

Radio and television interference

“Warning — This equipment has been verified to comply with the limits for a Class B computing device, pursuant to Subpart J, of Part 15, of FCC rules. Operation with non-certified or non-verified equipment is likely to result in interference to radio and TV reception.”

The equipment described in this manual generates and uses radio-frequency energy. If it is not installed and used properly, that is, in strict accordance with our instructions, it may cause interference with radio and television reception.

This equipment has been tested and found to comply with the limits for a Class B computing device in accordance with the specifications in Subpart J, of Part 15, of FCC Rules. These rules are designed to provide reasonable protection against such an interference in a residential installation.

However, there is no guarantee that the interference will not occur in a particular installation. If this equipment does cause interference to radio or television reception, which can be determined by turning the equipment on and off, the user is encouraged to try to correct the interference by the following measure:

- Disconnect other devices and their input/output cables one at a time. If the interference stops, it is caused by either the other device or its I/O cable.

These devices usually require Roland designated shielded I/O cables. For Roland devices, you can obtain the proper shielded cable from your dealer. For non Roland devices, contact the manufacturer or dealer for assistance.

If your equipment does cause interference to radio or television reception, you can try to correct the interference by using one or more of the following measures:

- Turn the TV or radio antenna until the interference stops.
- Move the equipment to one side or the other of the TV or radio.
- Move the equipment farther away from the TV or radio.
- Plug the equipment into an outlet that is on a different circuit than the TV or radio. (That is, make certain the equipment and the radio or television set are on circuits controlled by different circuit breakers or fuses.)
- Consider installing a rooftop television antenna with coaxial cable lead-in between the antenna and TV.

If necessary, you should consult your dealer or an experienced radio/television technician for additional suggestions. You may find helpful the following booklet prepared by the Federal Communications Commission:

“How to Identify and Resolve Radio-TV Interference Problems”

This booklet is available from the U.S. Government Printing Office, Washington, D.C., 20402, Stock No. 004-000-00345-4.

Contents

1	Panel Descriptions	3	7	Other useful functions for editing	28
2	Outline of the TR-727	6	a.	Copying a Single pattern	28
3	Connections	7	b.	Copy (within Tracks)	28
4	Operation	8	c.	Chaining patterns together	29
1	Getting to know your Composer	8	8	Tape Interface	31
a.	Manual Play	8	a.	Saving	31
b.	Demonstration Program	8	b.	Verification	32
2	Writing and playing rhythm patterns	9	c.	Loading	34
a.	Step Writing	9	d.	Setting a file number	34
b.	Tap Writing	14	9	Memory Cartridge	35
c.	Pattern Playing	16	a.	Selecting a Bank	35
3	About Last Step and Scale	17	b.	Saving and Loading	36
a.	Setting Last Step	18	10	External Connections	37
b.	Setting Scale	18	a.	Multi Output	37
4	Flam and Shuffle	20	b.	Trigger Out, Start/Stop	37
a.	Flam	20	11	SYNC	38
b.	Shuffle	21	a.	Sync using DIN	38
5	Track Writing and Playing	22	b.	Sync using MIDI	39
a.	Track Writing	22	c.	Sync using Tape Recorder	40
b.	Track Playing	23	12	MIDI	42
6	Editing	24	a.	Setting MIDI Channel	42
a.	Track Editing	24	b.	OMNI Mode	43
b.	Delete	25	c.	Key Number	44
c.	Insert	25	d.	Transmitting MIDI Message from the Composer	46
			5	Specifications	51

Please read the separate volume “MIDI” then this owner’s manual for better understanding of the TR-727.

1 Panel Description

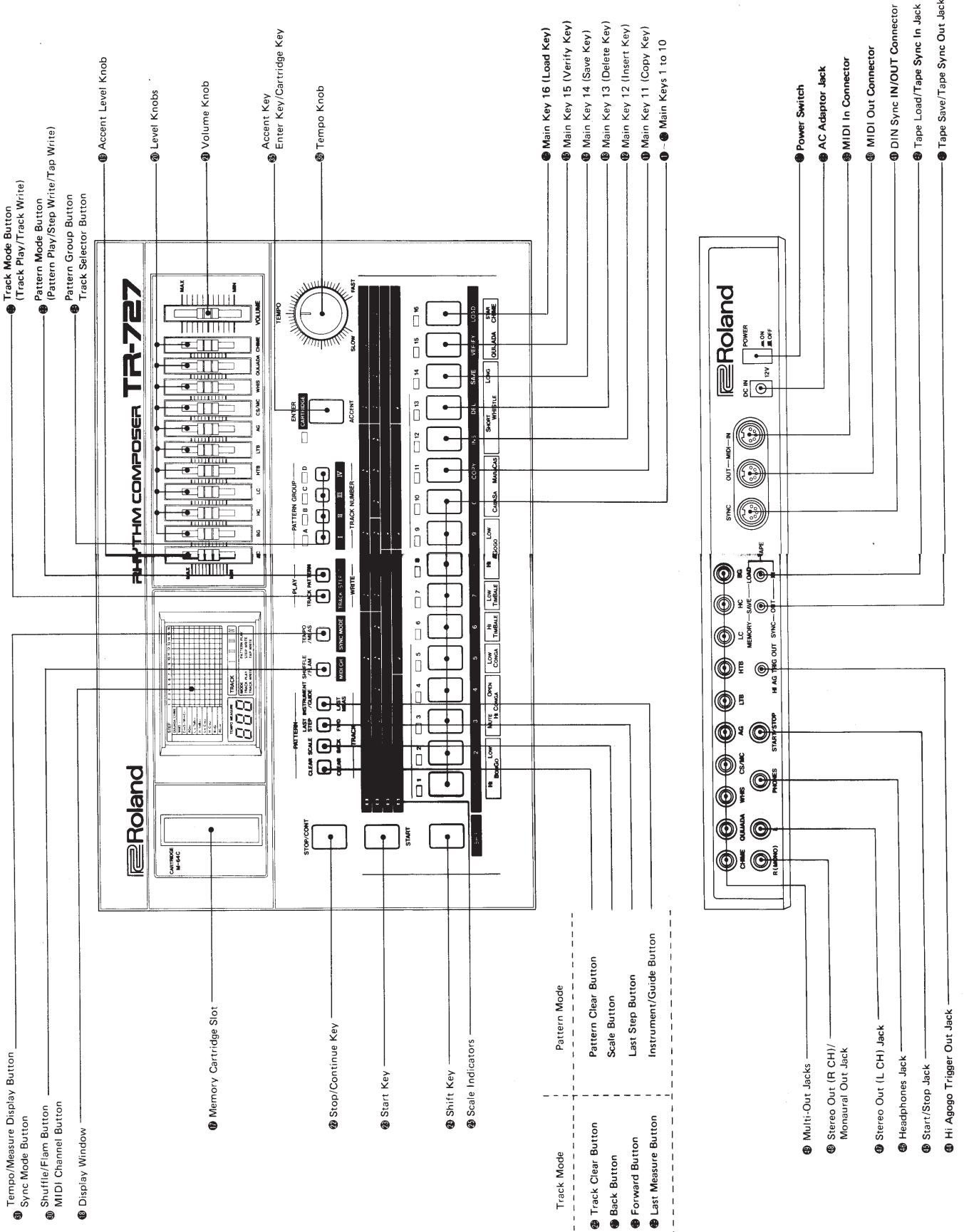

If error is indicated in Verify or Load procedure of Tape Interface, carefully repeat each procedure taking care of the following points.

▶ **When to press the Key**

- * Press the Verify or Load Key before the data you are to verify or load starts.

▶ **Playback Level of the Tape Recorder**

- * The appropriate playback level varies depending on the tape recorder. So change the level to find an appropriate level. Also, if your tape recorder features recording level control, try changing the recording level in saving.
- * If the tape recorder features Tone control, adjust it, too.

▶ **Connection**

- * Make sure that connections are made properly.
- * If your tape recorder has two kinds of In/Out Jacks (i.e. MIC/LINE In, EAR/LINE Out, etc), try using different ones this time.
- * Some tape recorders do not allow proper operation when both Save and Load connections are made at the same time. In such a case, make only the relevant connection.

▶ **Tape you use**

- * Use a new and high quality tape, if possible. An old tape is liable to have drop-out, therefore likely to cause error more often.
- * Use a cassette tape shorter than C-60. The one longer than C-90 is too thin for proper operation.

▶ **Tape Recorder**

- * Try using the same tape recorder in Saving and Loading, so that possibility of error will be reduced.
- * Clean and demagnetize the head of the tape recorder.

★ If error is still indicated, use a different tape recorder.

Important

- This unit might not work properly if turned on immediately after turned off. If this happens, simply turn it off and turn it on again a few seconds later.
- This unit might get hot while operating but there is no need to worry about it.
- Be sure to use the supplied AC Adaptor. Using any other adaptor may cause trouble. Do not use this adaptor with any other device, either.
- Do not switch the unit on without the AC Adaptor connected.
- Operating the TR-727 near a neon or fluorescent lamp may cause noise interference. If so, change the angle of the unit.
- Avoid using the unit in excessive heat or humidity or where it may be affected by direct sunlight or dust.
- Use a soft cloth and clean only with a neutral detergent.
- Do not use solvents such as paint thinner.
- View the Display from the proper angle.
- Please be careful not to damage the window.

Memory Back-up

The TR-727 features memory back-up system that retains the data even when switched off. A set of batteries (1.5V or UM-3 batteries x 2) supports its back-up circuit.

Be sure to keep the batteries securely connected even during AC operation.

Always replace with a complete set of new batteries once a year no matter how rarely you have used the unit.

Change the batteries with the TR-727 switched on, this way the memory can retain the data.

If the unit is not to be used for long periods of time, please save the data on a tape or cartridge then switch it off and remove the batteries, otherwise various troubles may be caused by battery leakage.

Please observe the following "Battery Replacement".

Please be sure that the polarities of the batteries are correct.

Battery Replacement

Please save the data in memory on a cartridge or tape to prevent accidental loss of memory during battery replacement.

Use two 1.5V (UM-3) batteries.

- ① Remove the battery cover on the bottom of the unit.

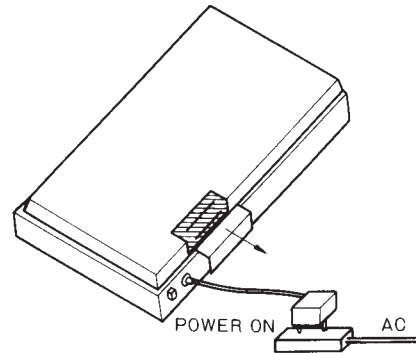

- ② Remove the batteries from the battery case.

- ③ Place a new set of batteries taking care of the polarities.

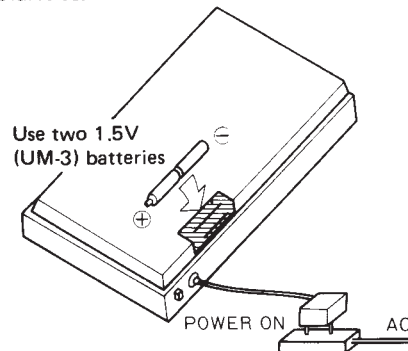

- ④ Replace the battery cover.

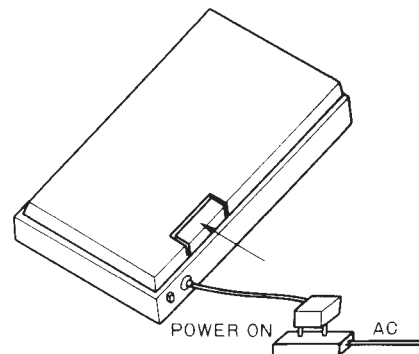

- Please be sure to do the entire battery replacing procedure with the unit switched on. Then the data in memory will be retained.

2 Outline of the TR-727

The Rhythm Composer TR-727 is a fully programmable rhythm machine which allows you to program 4 Rhythm Tracks or tunes (altogether 998 bars) from up to 64 kinds of user-created Rhythm Patterns.

Each of the 15 digital drum voices is extremely realistic and has a separate output jack for individual mixing, echo or equalizer.

An optional memory cartridge plugs directly into the Composer for instantaneous loading and saving, expanding the memory capacity by three times.

A Display window helps your operation to great extent.

MIDI Bus on the rear panel interfaces with other MIDI devices to allow control of several instruments.

Flam (Grace-note) and Shuffle can be added for greater variety and realism.

Now we'll find our way around the important controls before creating and storing ('writing') our own rhythm tracks. With any computer keyboard, the same key may do several different jobs depending on how it is used. The Composer, which is a type of computer, does this also. When switched on, the Composer automatically selects (or 'defaults' to) Track I.

"Default" means the value automatically selected by the Composer overridden by your command.

A Track is a complete tune in rhythm, made up of Patterns strung together (Patterns are covered later), and there is a demonstration tune written on Track I.

The SHIFT Key is used a lot. It enables many buttons and keys to perform two functions instead of just one. The distinction is clearly marked on the Composer: all functions enclosed with lines and highlighted are selected while the SHIFT Key is held down. All other functions do not need the SHIFT Key. The only exception to this rule is the ENTER Key.

The Main Keys numbered 1 to 16 are used for several tasks:

- (i) They produce the voices manually when tapped.
- (ii) They divide a bar of music into 16 parts, and enable voices to be written into any of these parts.
- (iii) They assign the instrument voices in turn when you are writing.
- (iv) They take care of all the "housekeeping" involved in editing Rhythm Patterns and Track, such as delete, insert and copy.
- (v) They set the Accent on the major voices.

Above the Main Keys is the scale of time values with a red LED beside each to indicate which is in operation. These indicate whether you are operating in 2/4, 3/4, 4/4, 6/8 or multiples of these times. Default value is 4/4, other times are set with the SCALE button.

Special times such as 5/4, 7/4 or any other can be set with the LAST STEP button. Mixed times which change each bar can also be set up.

We use the CLEAR button to erase rhythm patterns we want to write over, the FLAM button for adding Flam or 'grace notes' ahead of the main beat, and INSTRUMENT SELECT for selecting each voice in turn when writing Patterns.

Finally, don't worry if you can't get an immediate response from these controls; sometimes they operate only under special circumstances to protect your data. A full explanation of all controls follows in this Manual.

3 Connections

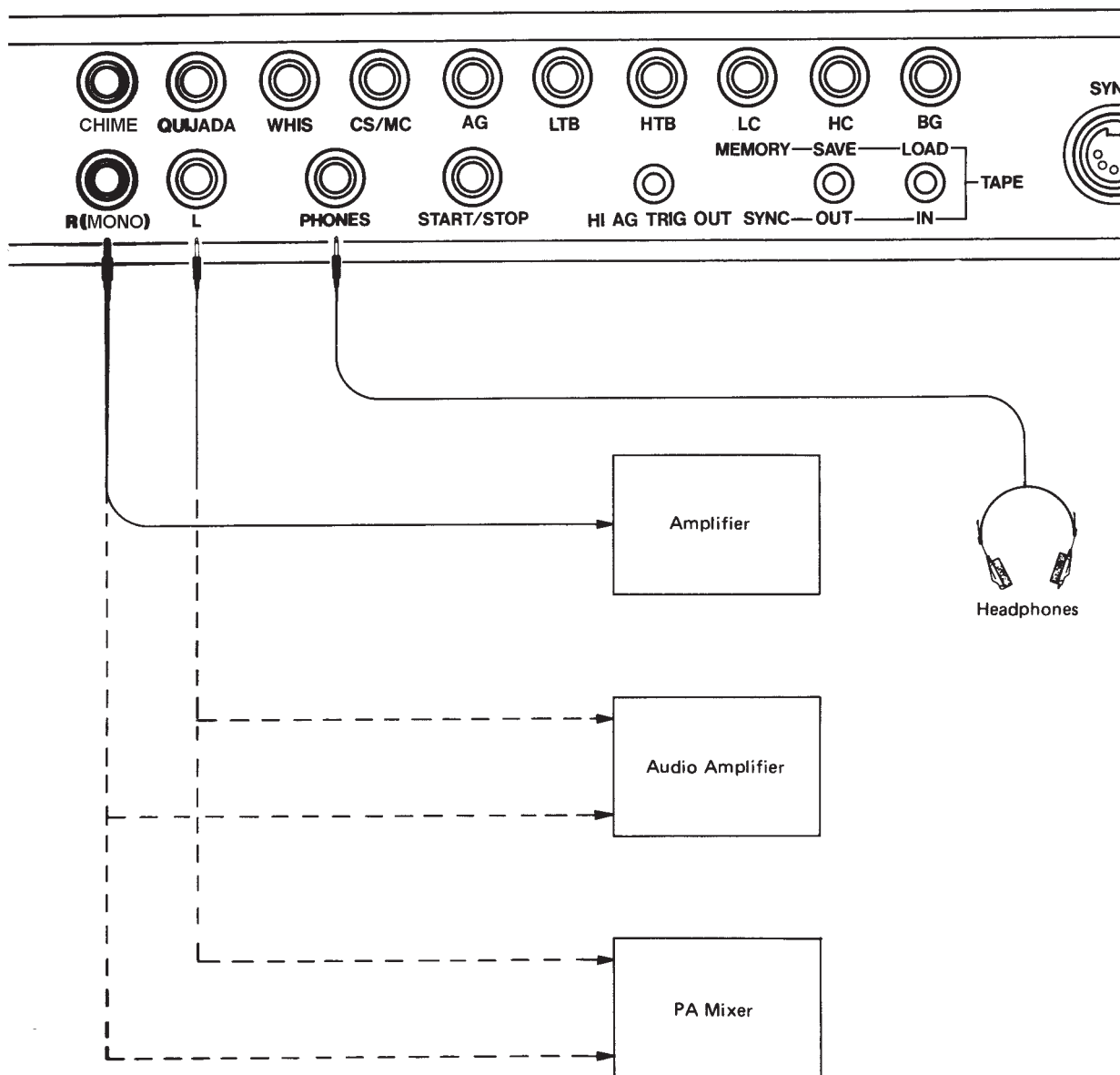

4 Operation

The TR-727 has the following 5 modes.

Pattern Playing Mode
Step Writing Mode } = Pattern Writing Modes
Tap Writing Mode }
Track Playing Mode
Track Writing Mode

1. GETTING TO KNOW YOUR COMPOSER

a. Manual Play

With the composer connected to the power source, and to your amplifier or mixer, you are ready to try out a variety of sounds by playing it manually.

Switch it on. A variety of lights will come on, but we'll learn about them later. Locate the Main Keys numbered 1 to 16 which have the instrument voices marked underneath. Simply tap each key: All voices have different instrument sounds. Also, if you tap the key with the Accent and/or Shuffle/Flam Keys down, the created sound will take on accent and/or Flam.

• Summary of controls

Level Knob 20

This is to control the volume of each drum voice.

Accent Level Knob 19

This knob controls the intensity of the accent.

Volume Knob 21

This is to control overall volume of the rhythm data.

Tempo Knob 26

Rotating this knob quickens the tempo of the rhythm data.

• Summary of voices

1. HI BONGO
2. LOW BONGO
3. MUTE HI CONGA
4. OPEN HI CONGA
5. LOW CONGA
6. HI TIMBALE
7. LOW TIMBALE
8. HI AGOGO
9. LOW AGOGO
10. CABASA
11. MARACAS

12. SHORT WHISTLE

13. SHORT WHISTLE

14. LONG WHISTLE

15. QUIJADA

16. STAR CHIME

The numbers 1 to 16 represent the Main Keys to be used for selecting corresponding instrument voices.

The Short Whistle 12 and 13 are exactly the same sounds.

It is not possible to output the following pairs of voices at the same time.

1 and 2 (High Bongo and Low Bongo)

3 and 4 (Mute High Conga and Open High Conga)

8 and 9 (High Agogo and Low Agogo)

10 and 11 (Cabasa and Maracas)

12(13) and 14 (Short Whistle and Long Whistle)

For instance, if you have entered the Maracas in the step where the Cabasa has already been written, the Cabasa will be automatically replaced with Maracas.

b. Demonstration Program

A sample program is stored in your Composer on Track I. You can hear this simply by pushing the START Key ●. At the end of the Track, the Composer will stop, and start again from the beginning if you again push the START Key.

You can vary the Tempo by turning the Tempo knob 26.

Restoring the demo program

If you have erased the demo program but want to restore it, take the following operation.

Press the Track Mode Switch 32 and Track Number Button I, and while still holding them down, switch the composer on.

2. WRITING AND PLAYING RHYTHM PATTERNS

Now that we know how to produce all the sounds, we will learn to write a pattern. A pattern is a one-bar phrase. We can write into memory a large number of patterns (up to 64) to recall later in any order we like, either manually or as a completely assembled track stored in memory. In practice, we will find it easier to write patterns in the same order we later assemble them into tracks, or complete tunes. There are two ways of writing patterns a—Step-writing, in which we enter or load one step at a time without worrying about tempo. The Composer will take care of that when we've finished. b—Tap Writing, in which we use a key to tap in the rhythm in time to a Hi Agogo produced every quarter-beat by the Composer.

a. Step Writing

We can enter a rhythm pattern by writing drum voices step by step.

- * First of all, check that the composer is switched on and not running.

Operation

- ① While holding the Shift Key down, press the Pattern Mode Button  until the Mode Display shows STEP WRITE.

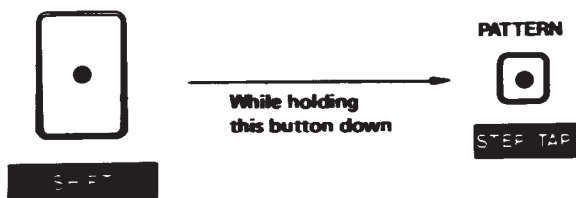

Now, the composer is in the Step writing mode.

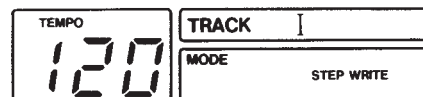

- ② To prepare for loading in our pattern, press any of the Pattern Group Keys  (A, B, C or D). The pressed key will light up showing the cor-

responding pattern group (consisting of 16 patterns each selected by one Main Key) is ready to receive data. It is in Pattern Writing mode.

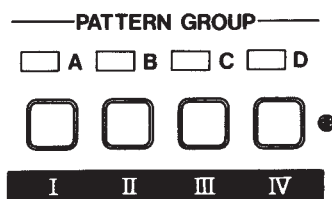

- ③ Press the Pattern Clear Key **20**, and still holding it down, press one Main key (1 to 16), selecting the position where you wish to store your pattern.

The indicator of the selected number will light up. Also, if any pattern has been previously stored in this position (in this pattern number), it will be erased.

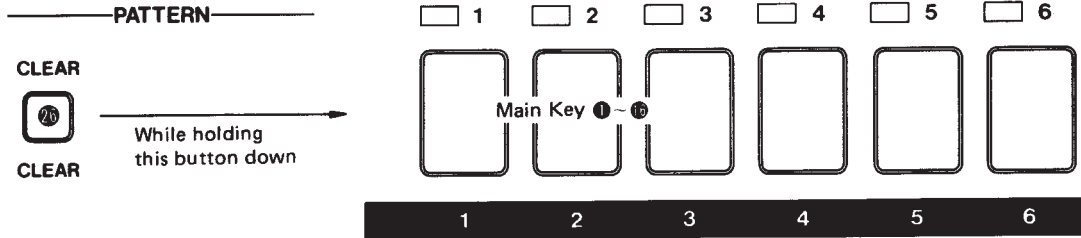

- ④ Press the Start Key **23**. Though the lights will flash in sequence, there will be no sound because you have clear memory. The flashing speed is equivalent to the tempo of the rhythm, so adjust the Tempo Knob **21**.



- ⑤ Now, select your first instrument, by holding down the Instrument Selector Button **22** then pushing the corresponding Main Key (if you want Mute Hi Conga, push the Main Key 3 marked Mute Hi Conga.)

In the Display **24**, the "▶" mark will flash on the left of the selected voice.

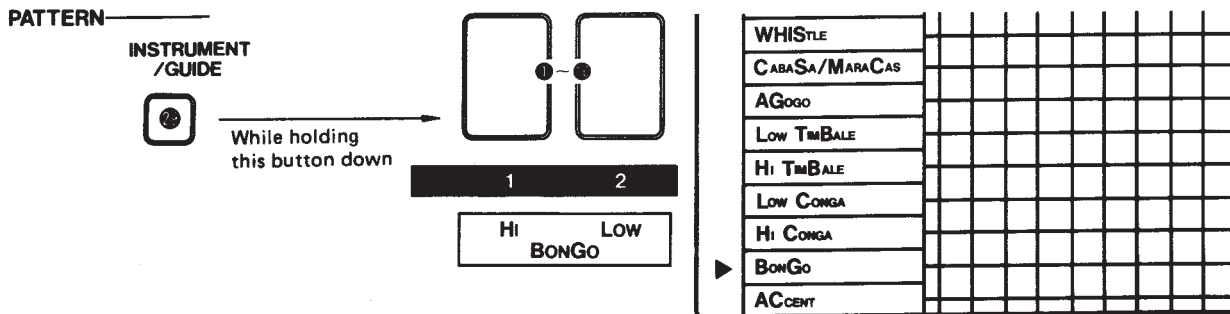

⑥ Regard the 16 Main Keys as an entire bar, and push the Main Keys that correspond to the steps where you want the instrument voice selected in the procedure ⑤. Now, in the Display, the dots of the corresponding positions (steps) light or flash.

* If you wish to erase the voice you have written into a certain step, simply press the Main Key that corresponds that step.

⑦ Now, move to the other instrument voices. Repeat procedures ⑤ and ⑥ for each instrument voice.

⑧ Now, you can hear the complete pattern. At this stage, you can modify it any way you want, by re-selecting other instruments and changing their timing, or adding accent.

⑨ To write accents, hold down the Instrument Selector Button ⑳, and without releasing it, push the Accent Key ㉑ (= Enter Key).

⑩ Regard the 16 Main Keys as an entire bar, and push the Main Keys that correspond to the steps where you want accents. There are two kinds of accents, weaker, and stronger. Pressing a Main Key once will write a weaker accent to the corresponding position, and pressing it again will write the stronger accent. And pressing it once again will cancel the accent altogether, and the indicator light will go out.

Weaker accent and stronger accent can be distinguished by the Display's response. " ● " flashes when weaker, and lights steadily when stronger.

⑪ When you are satisfied with the sound, it is time to leave "write" mode to store the pattern in its final form:

- i) Press the Stop/Continue Key
- ii) In future, you can always come back to the same pattern by pushing the same Pattern Group Button, the Main Key you selected in the procedure ③, then the Start Key ㉒.

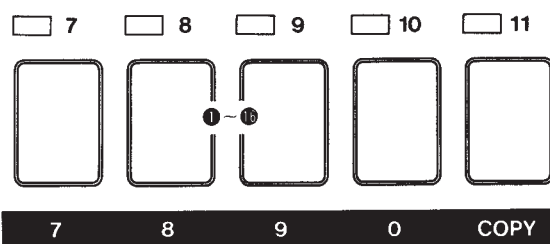

The dots (●) in the Display either flash or glow steadily depending on what drum voice is currently selected.

Glowing dots	Flashing dots
HI BONGO	LOW BONGO
MUTE HI CONGA	OPEN HI CONGA
LOW CONGA	
HI TIMBALE	
LOW TIMBALE	
HI AGOGO	LOW AGOGO
CABASA	MARACAS
SHORT WHISTLE	LONG WHISTLE
STAR CHIME	QUIJADA

Example Step Write

Let's write an example pattern of latin rhythm in Step Writing.

< Fig 1 >

HI AGOGO: Four quarter notes on a single line.

LOW CONGA: A sequence of notes including quarter notes, eighth notes, and sixteenth notes, with rests.

HI CONGA (OPEN): A sequence of notes including quarter notes, eighth notes, and sixteenth notes, with rests.

HI BONGO: A sequence of notes including quarter notes, eighth notes, and sixteenth notes, with rests.

< Fig 2 >

STEP	1	2	3	4	5	6	7	8	9	10	11	12	13	14	15	16
AGOGO	●				●				●				●			
LOW CONGA		●					●	●	●						●	●
HI CONGA	○			○	○					○		○				
BONGO			●			●					●		●			
ACCENT																

Display Response

First, follow the Step Writing procedures ① to ④ on page 9 and 10.

If the last step has been set to any number other than 16, set it to 16 by pressing the Main Key 16 while holding the Last Step Button ●.

Entering Hi Agogo

While holding the Instrument Selector Button ● down, press the Main Key 8 (Hi Agogo).

Tap the Main Keys 1 to 16 according to the score shown below.

Now, the Hi Agogo is selected and ready to be written at the position where the Main Key is pressed.

HI AGOGO: Four quarter notes on a single line.

Main Key: A row of 16 indicators numbered 1 to 16. Indicators 1, 5, 9, and 13 are highlighted with a dark background.

Press the Main Keys 1, 5, 9 and 13, and make sure that the corresponding indicators glow.

Entering Hi Bongo

While holding the Instrument Selector Button , press the Main Key 1 (Hi Bongo).

Tap the Main Keys according to the score. (Refer to the figure below.)

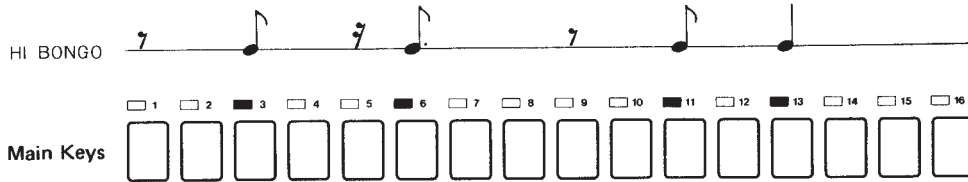

Press the Main Keys 3, 6, 11 and 13, and make sure the corresponding indicators glow.

Entering Hi Conga (Open)

While holding the Instrument Selector Button , press the Main Key 4 (Open Hi Conga).

Tap the Main Keys according to the score as shown below.

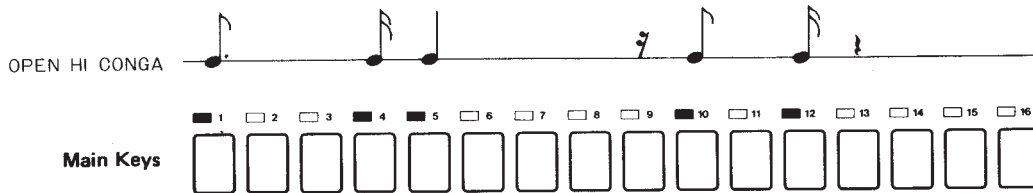

Press the Main Keys 1, 4, 5, 10 and 12, then make sure the corresponding indicators glow.

Entering Low Conga

While holding the Instrument Selector Button , press the Main Key 5 (Low Conga).

Tap the Main Keys according to the score as shown below.

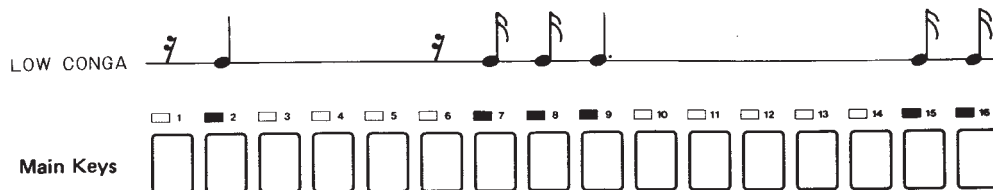

Press the Main Keys 2, 7, 8, 9, 15 and 16, then make sure the corresponding indicators glow.

Now, a Rhythm Pattern like Fig 1 is entered, and the Display Window responds as shown in Fig 2.

b. Tap Writing

Operation

First, check if the composer is switched on and not running.

- ① While holding down the Shift Key **24**, push the Pattern Mode Button **25** as many times as needed until the Display shows TAP WRITE.

Now, the composer is in the Tap Writing mode.

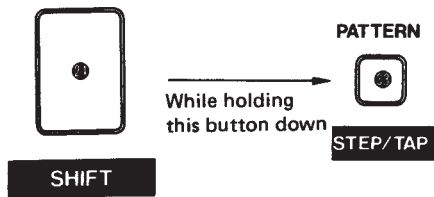

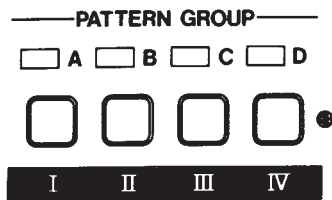

- ② Decide which Pattern Group you want to write into. Then push the Pattern Group Button (which will then flash).

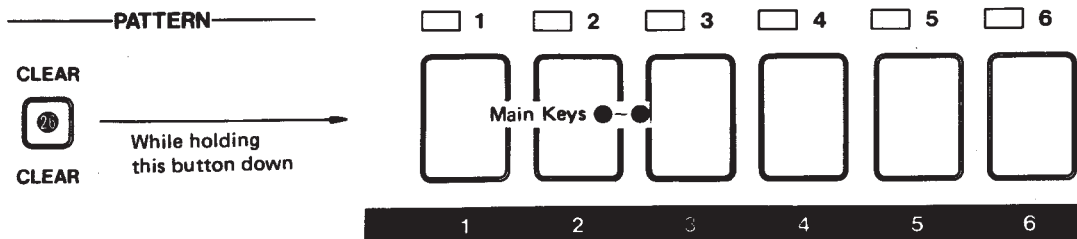

- ③ While holding the Pattern Clear Button **26**, select the Main Key (1 to 16) where you want to write the Pattern.

The indicator of the pressed Main Key flashes. Also the above operation erases any pattern previously written there.



④ Press the Start Button . Now, you will hear guide crotchet Hi Agogo. This will not be recorded.

Here, if you push the Instrument Selector Button , Hi Agogo will stop. And if pressed again, start.



START

⑤ Tap in the rhythm on the Main Keys, just as you did when playing the keys manually. Remember, you are writing one bar which is repeating.

* The shortest timing value that can be written into the TR-727 is 16th note (). Therefore, if you slow the tempo to make writing easier, you could be surprised at the result when you change back to normal tempo.

* If you make an error, while the rhythm is still running, hold down the Clear Button , then push the Main Key belonging to that voice until that voice has disappeared. Then write that voice again. Even if you make many mistakes at this stage, you will soon find it comes easier.

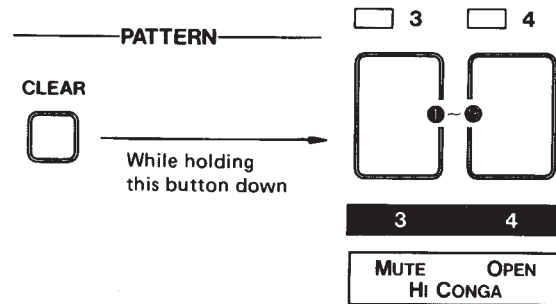

Note

By the above operation, erasing the Cabasa will erase the Maracas and vice-versa. This also holds true for the Star Chime/Quijada.

⑥ When you have finished writing, push the Stop/Continue Key.



⑦ If you wish to write accents, tap in the rhythm on the Accent Key  (=Enter Key), just as you did in the above procedure ⑤.

Now, the **weaker accents** have been written. To write **stronger accents**, try tapping in the exactly same timing as you have tapped. Tapping once again in the same timing will change the accents to weaker, and so on.

Weaker accent or stronger accent can be distinguished by the Display's response. The "●" mark flashes when weaker, and glows steadily when stronger.

STOP/CONT



To change from Step Writing mode to Tap Writing or from the Tap Writing to the Step Writing mode, simply hold the Shift Key  down, and without releasing it, push the Pattern Mode Button . This mode changing operation can be done even while rhythm is running. So, if you have made an error in Tap Writing mode, you can immediately turn the composer to the Step Write mode and correct the error without affecting any other part of the pattern data. To the contrary, you can add a more complicated rhythm in the Tap Write mode to the pattern entered in the Step Write mode.

c. Pattern Playing

When you intend to write a complete Track from a group of Patterns, you may want to listen carefully to your patterns either separately or in sequence. It is a good idea to write your Patterns roughly in the order you will use them, though you will often go back to re-use previous Patterns.

1) Playing a single Pattern

Operation

- ① Push the Pattern Mode Button ● to turn the composer to the Pattern Playing mode.
- ② Push the Pattern Group Button ● which is the same one you have been using. Then push the required Main Key to select your pattern.

The Display now shows the rhythm chart of the selected Pattern.

- ③ Press the Start Key ● .

To change Patterns, there is no need to stop playing. Simply push another Main Key and the new pattern will take over at the end of the bar.

- ④ Press the Stop/Continue Key ● to stop the rhythm. By pressing the Stop/Continue Key once again, the pattern will start playing from where it was stopped.

2) Block Playing

Any block of Patterns may be played in sequence. To play Patterns 1 to 5 in sequence, push Main Keys 1 and 5 together (the indicators of the Main Keys 1 to 5 will light up, showing that they are ready to be block-played), then push the Start Key ● .

All the other necessary procedures are the same as the Pattern Playing.

e.g. To play Pattern No. 1 to 5 continuously.

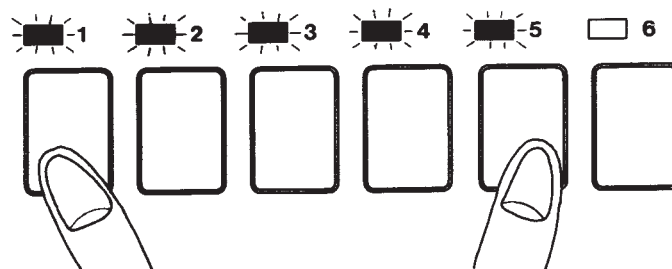

Pattern Playing

3. ABOUT LAST STEP AND SCALE

The default setting is 4/4 time, shown by the red light at the left side of the chart. In this, the lowest of the four chart lines, the 16 Main Keys are shown

divided into 1 bar of 4 crotchets, therefore the value represented by each Main Key is a semi-quaver, or 1/16 note.

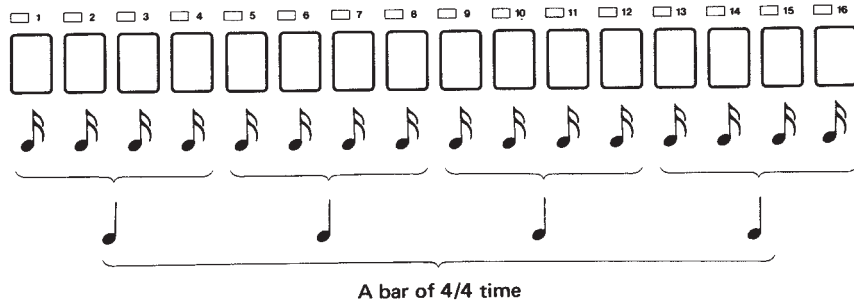

To enter the Pattern other than above, such as 3/4, a bar consists of 12 steps, so it is necessary to change the total step number from 16 to 12. (See a. Setting Last Step on page 18.)

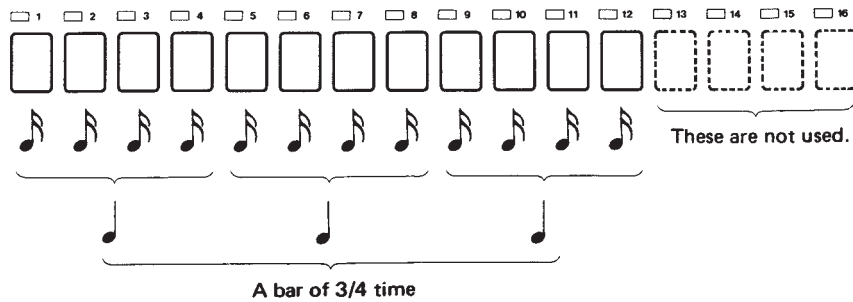

The chart line second from the bottom is divided into half a bar of two crotchets, in which the 16 Main Keys represent a demisemiquaver, or 1/32 note. Although patterns may be only half-a-bar long, two patterns may be chained to play consecutively. (See c. Chaining patterns together on page 29.)

The Pattern of 4/4 with triplets also consists of 12 steps. If, however, entering the Pattern with the Scale set to 4/4, the total playing time will be three quarter of the common time. So, it is necessary to change the time of each step. (See b. Setting Scale.)

The third line up on the chart is similar to the first, except for three beats (or 6) in the bar instead of common time. The fourth line is similar to the second line, but again caters for 3 or 6 beats in the bar. The Scale may be set to any of the lines. (See b. Setting Scale.)

The Last Step is set so that $\text{♪} = 16$, $\text{♪}^3 = 12$ (simple) and $\text{♪}^6 = 12$ (compound) = 12.

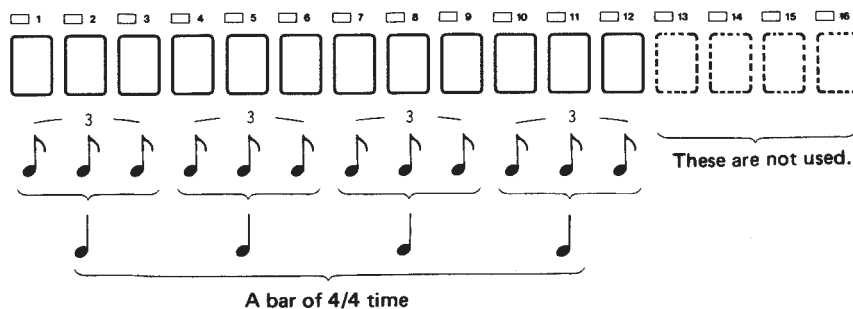

The total time required is three quarter compared to 4/4 time.

a. Setting Last Step

Operation

- ① Enter Pattern Writing mode, in either the Step Writing or Tap Writing mode.
- ② While holding the Last Step Button , push the relevant Main Keys to set the bar length. By using the above function of changing the number of steps or beats in a bar, odd times such as 5/4 (combination of 3/4 and 2/4) or 7/4 (combination of 4/4 and 3/4) can be easily entered.

b. Setting Scale

Operation

- ① Enter Pattern Writing mode, in either Step Writing or Tap Writing mode.
- ② Push the Scale Button . The Scale light will move up one step, to line 2.
- ③ Each time the Scale Button is pushed, the red light moves up. From the top line it moves back to the bottom line.
- ④ The tempo of the red light may also change, since all the rhythms are in step with each other.

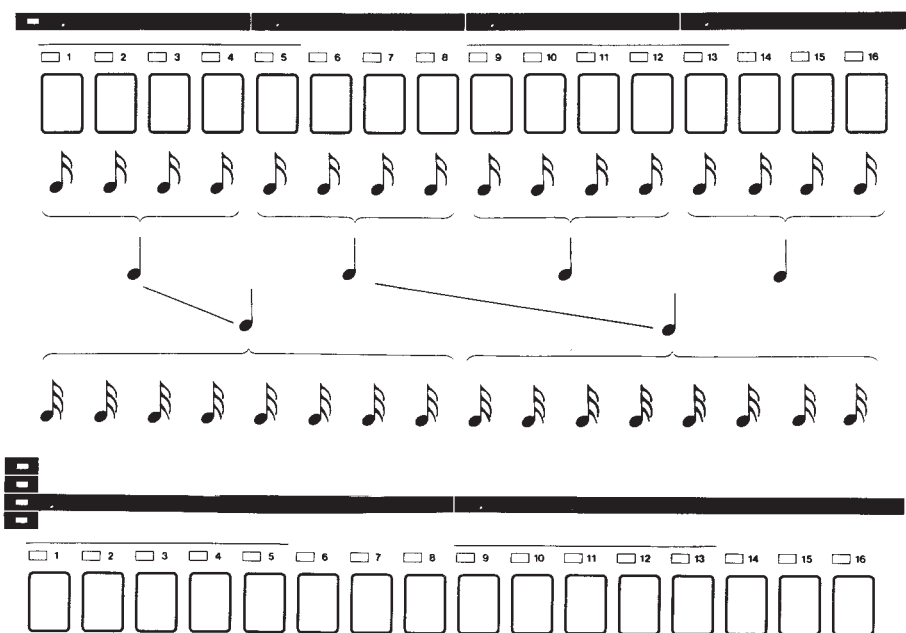

The diagram illustrates the setting of a scale on a 16-step sequencer. The top part shows a 16-step pattern with notes grouped into four 4-step segments. Brackets indicate that the first two steps of each segment are grouped together, and the last two steps are grouped together. Lines connect the notes to show a scale-like progression. The bottom part shows a similar 16-step pattern with notes grouped into two 8-step segments, demonstrating how repeating a pattern twice or chaining two patterns makes a common length.

In this scale, repeating a pattern twice or chaining two patterns makes a common length.

1 2 3 4 5 6 7 8 9 10 11 12 13 14 15 16

These are not used.

1 2 3 4 5 6 7 8 9 10 11 12 13 14 15 16

Last step

1 2 3 4 5 6 7 8 9 10 11 12 13 14 15 16

These are not used.

1 2 3 4 5 6 7 8 9 10 11 12 13 14 15 16

Last step

In this scale, repeating a pattern twice or chaining two patterns makes a common length.

4 FLAM & SHUFFLE

a. Flam

Flam is a kick-note written ahead of the main beat, and takes on the effect of a grace note. It differs from Shuffle in that it occurs once only. Flam can be written on the any of the Congas or Timbales. The time gap between the Flam or grace note and its following main note can be varied with 4 options, using the Main Keys. To set up the Flam:

1) In Step Writing Mode

- ① Change to Step Write mode and have the rhythm running.
- ② Hold down the Instrument Selector Button  and press TWICE the Main Key belonging to the voice you are writing Flam to.

The Display shows steady glow of "▶" mark.

- ③ Write your instrument voice as usual.

2) In Tap Writing Mode

- ① Change to the Tap writing mode, then have the rhythm running.
- ② Hold down the Shuffle/Flam Button , and without releasing it, tap in the rhythm on the relevant Main Keys belonging to the voice you are writing Flam to.

There are two types of Hi Conga voices in the Composer, but the Open Hi Conga will always take on the Flam. That is, even if you have entered the Flam on the Mute Hi Conga, what you have is always the Open Hi Conga with Flam unless you take the following operation. To obtain the Mute Hi Conga with Flam: Hold the Shift Key down, and push the Instrument Selector Button . Each time the button is pressed, Mute and Open Hi Congas are alternately selected.

- * The dots in the Display do not flash but glow steadily when the Open Hi Conga is selected.
- * Even if the above procedure has been taken to select the Mute Hi Conga, the Open Hi Conga with Flam will come on again when the composer is turned off once, then turned on.

3) Setting the Flam interval

The interval of Flam can be written after having entered Flam in either Step Writing or Tap Writing mode. But the Flam interval writing operation should be done in the Step Writing mode, so if the composer is in the Tap Writing mode, change to the Step Writing mode.

There are 4 different intervals optional by the Main Keys 10 to 13. The shortest interval is Key 10, and the longest is 13. The Key 9 is Off.

- ① Hold down the Shuffle/Flam Button **30** and press any of the Main Keys 9 to 13 to set the Flam interval.
- ② If you want to know the Flam interval currently set, press the Shuffle/Flam Button **30** and see which Main Key lights up.

* The position of the Tempo Knob does not affect the Flam interval.

b. Shuffle

A shuffle beat is one in which a bounce-note is added immediately in front of each crotchet beat. This is done for at least one chorus and frequently for a whole tune. A shuffle beat may be added to any rhythm pattern in common time (when either of the lower 2 lines of the Scale is selected). The added bounce is changed in volume with 4 options using the Main Keys 2 to 5. To set the Shuffle beat:

- ① Change to the Step Writing mode and have the rhythm running.
- ② Hold down the Shuffle/Flam Button **30** while pushing the relevant Main Keys which will be zero with key 1 and maximum with key 5.
- ③ If you want to know the bounce currently set, push the Shuffle/Flam Button. A Main Key will light up to indicate the degree of bounce.

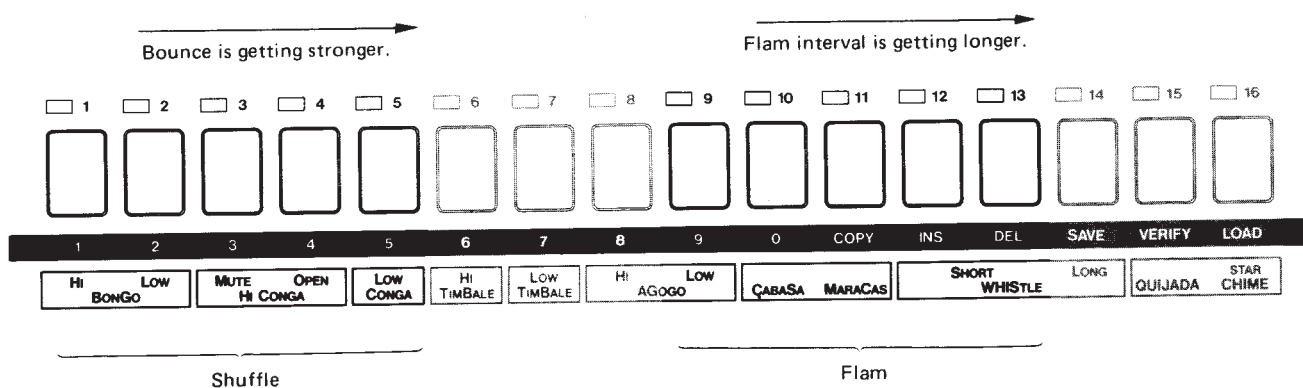



5 TRACK WRITING AND PLAYING

a. Track Writing

A track is a complete sequence of rhythm Patterns or Bars arranged in any order to form a complete piece. There are 4 Tracks retaining 998 bars in all. Entering rhythm Patterns of an entire Track will replace the patterns previously written, so you may save it. (See 31 and 36.)



1) Writing single Patterns to a Track

- ① Press the Shift Key , and still holding it down, push the Track Mode Button  to turn the composer to the Track Writing mode.

You will notice that the Display shows TRACK WRITE.



- ② Still holding the Shift Key down, press any Track Selector Button (I to IV) which will be shown in number in the Display.
- ③ If there is any data written in that Track, clear it by holding the Track Clear Button and the Track Selector Button you have selected in the step ② above.

Remember that the above operation WILL ERASE YOUR EXISTING TRACK. If you wish to preserve it, save it as described in Saving on page 31 and 36.

- ④ Push the Start Key  to start rhythm. You will now hear whichever pattern happens to be selected.
- ⑤ Change to the Pattern you want for Bar 1 by using a Pattern Group Button  (A, B, C or D) and a Main Key (1 to 16).

The indicators of the pressed button and key are now lighted. Also, the Display shows the rhythm pattern.

- ⑥ Press the Enter Key , which writes your Pattern into Bar 1 of the Track and moves on to Bar 2.
- ⑦ Repeat the procedure ⑤ and ⑥ for Bar 2, and so on. Naturally, there will be many bars where the sample pattern is repeated.

- ⑧ If you enter the wrong pattern in any bar, you can go back and do it again. Push the Back Button  once or more to step back to the bar.
- ⑨ When you have completed the Track, push the Stop Key , which will close off the Track.

When the composer is in the Track Writing mode, writing or editing (see Editing on page 24) can be done even while rhythm is not running. (= skipping the procedure ④), during which the indicators can considerably help you.

2) Writing Chained Patterns to a Track

Two or more Patterns may be chained so that they play as one. This takes care of Rhythms which need more than 16 steps per bar, such as 32nd notes within 4/4 time, or semi-quavers within odd times such as 5/4 or 7/8. You may need to change the Scale before writing the Rhythm patterns if you intend to Chain them, so that they all play with the same time value.

To write Chained patterns into a Track:



Instead of taking the procedure ⑤ in 1) Writing single Patterns to a Track, simultaneously press the Main Keys belonging to the first and last numbers of the Chained Patterns. (e.g. key 1 and key 3.)

NOTE



- * Do not turn off the Composer while in the Track Write mode, or the Track data may be lost.

b. Track Playing

To hear the Track you have written:

- ① Press the Track Mode Button until the Display shows TRACK PLAY.
- ② While holding the Shift Key  down, press the Track Selector Button (I to IV) which you wish play. This causes the Display to show the selected Track number.
- ③ Push the Start Key .

The selected Track will start to play from the first bar.

- ④ To stop playing, push the Stop Key  — as we found earlier, you can continue on from this point with the Cont Key , or else start again from Bar 1 with the Start Key .

- * If you do not touch any key at all during Track playing, it will play till the end, then stop.
- * You can select any other Track of course, but you must first stop the rhythm.
- * You can add to the track while it is playing by manually tapping the Main Keys. This will not be written into memory.

Playing the rhythm from the bar you like:

Operation

- ① Assign the beginning bar of the rhythm pattern, as shown on page 24.
- ② Push the Stop/Continue Key .

The rhythm pattern will play from the bar you assigned.

NOTE 1

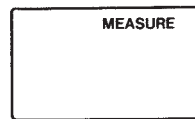

If the Display does not show the bar number, check if it is set to Measure Display mode. If it still does not show the bar number, most probably, there is no rhythm pattern written in the relevant Track, therefore pushing the Start Key has no effect.

NOTE 2

In Track Write or Track Play mode, you can select either tempo or bar number display. Simply push the Tempo Measure Display Button , and the mode will change alternately.

TEMPO
/MEAS

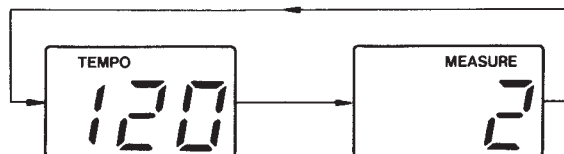

6 EDITING

You may find on listening to your Track that you have made an error. The TR-727 allows you to replace the wrong pattern in a certain bar with a correct one, add or delete patterns, groups of patterns or complete choruses, etc. This editing function, however, requires you to assign the bar number correctly. Otherwise the whole editing would go wrong.

To assign the bar you want:

Set the Composer to either Track Play mode or Track Write mode.

Set the Tempo/Measure Display section to Measure display mode by pushing the Tempo/Measure Display Button ①.

- Push the Forward Button ② which advances one bar at a time, until you come to the right bar.
- Push the Back Button ③ which backs up one bar at a time, until you come to the right bar.
- Assign the bar number by holding the Shift Key ④ down while punching the bar number on the Main Keys 1 to 10 (press 1 and 6 for bar number 16), and push the Enter Key.
- Push the Back Key down, while holding the Forward Key down, and the bars will be advanced quickly. On the contrary, push the Forward Key down while holding the Back Key to back up the bars quickly.

a. Track Editing

First, check if the composer is in the Track Writing mode, and not running the rhythm.

- ① Call the bar you wish to change, by any means you like as shown in "To assign the bar you want" in the section just before this.

The Display will show the number of the assigned bar.

- ② Press the Start Key ⑤ to start rhythm pattern.

* Skip this procedure if you are editing without rhythm running.

- ③ Select the correct pattern.

- ④ Push the Enter Key ⑥, which writes the correct pattern moving onto the next bar.

- ⑤ Press the Stop Key ⑦.

b. Delete

You can delete any Pattern or series of patterns from a Track. To delete a sequence of patterns, you assign the first and last bars of the sequence before removing them from the Track.

- ① Enter Track Writing mode, and select the Track by using a Track Selector Button **Ⓜ**.
- ② While holding the Shift Key down, use the Main Keys to select the first bar number you want to delete (it will appear in the Display). Then push the Enter Key **Ⓝ**.
- ③ Still holding the Shift Key down, push the Delete Key (= Main Key 13) then the number of the last bar you want to delete, then push the Enter Key.
- ④ To delete a single bar, while holding the Shift Key down, select bar number, push the Enter, then the Delete, then the Enter.
- ⑤ To delete the end of a Track, instead of assigning the last bar number, push the Last Measure Button **Ⓢ** (with the Shift Key down, push the Delete, Last Measure, Enter).
(See Example on page 26)

c. Insert

You can insert any single Pattern or Chain into a Track.

- ① Enter Track Writing mode. Select the Track by using a Track Selector Button.
- ② Assign the bar number by holding the Shift Key **Ⓜ**, selecting the bar number after which you wish to insert, push the Enter Key.
- ③ Select the Pattern you wish to insert by using a Pattern Group Button **Ⓢ** and Main Key.
- ④ While holding the Shift Key down, push the Insert Key (Main Key 12), then the Enter Key **Ⓝ**.

To insert a chain of Patterns, see page 22.

If the maximum memory capacity (998 Bars) is full up, no more Patterns can be written.

- ⑤ To add a Pattern to the end of Track, assign the last bar during the procedure ② by pushing the Last Measure Button. This advances one bar from the last measure, where a Pattern can be written in usual Track Writing procedure.
(See Example on page 27)

Example Delete

- To delete 21st to 24th bar.

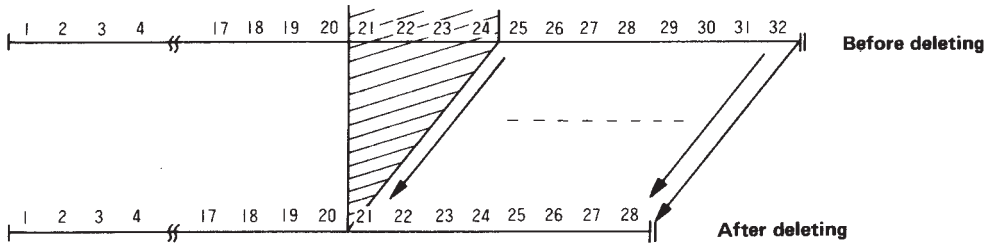

- ① Recall the 21st measure (Bar Assign)

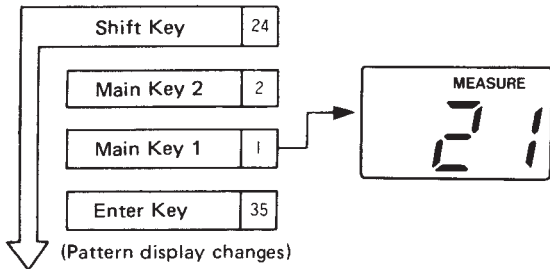

- ② Take Delete procedure and delete up to 24th bar.

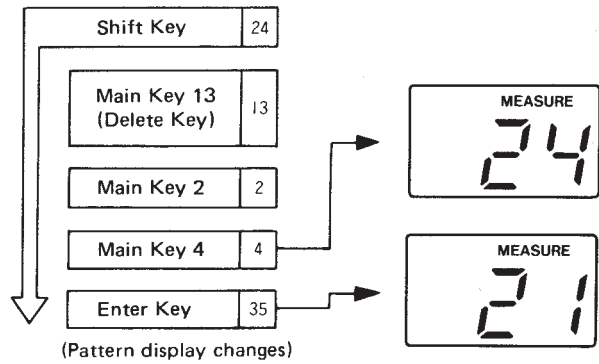

- To delete 25th to the last bar.

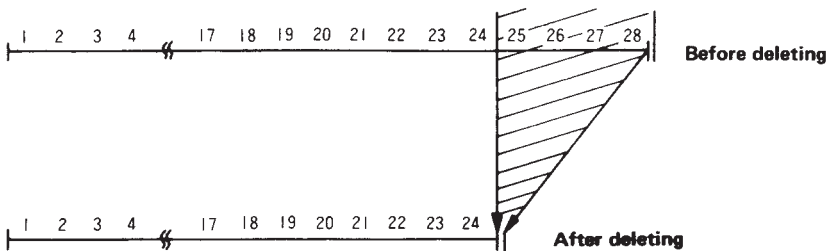

- ① Recall the 25th bar.

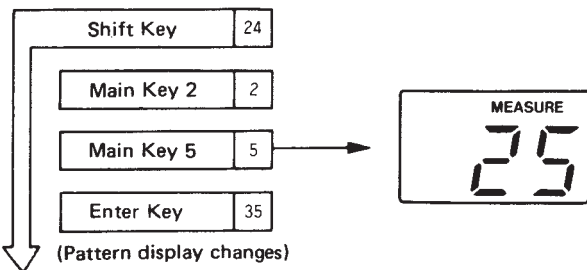

- ② Delete up to the last bar.

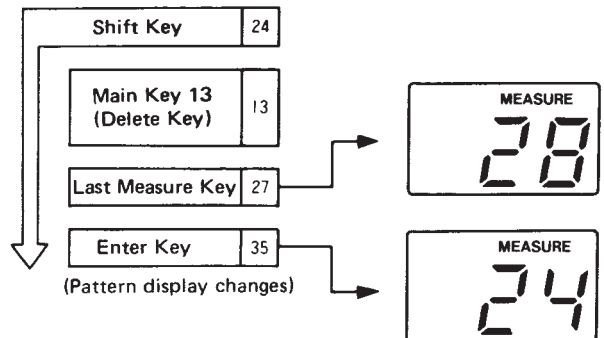

- To delete only 19th bar.

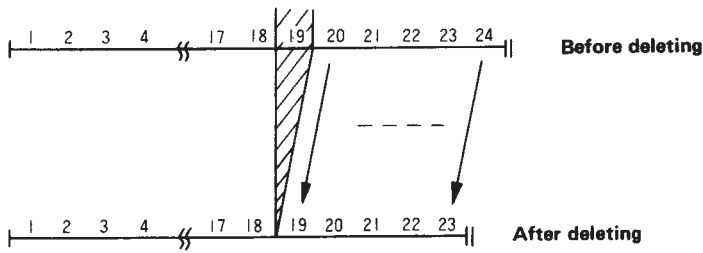

- ① Recall the 19th bar.

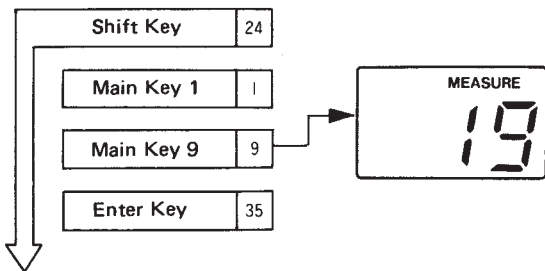

- ② Take Delete procedure.

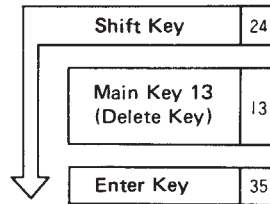

Example Insert

- To insert a Rhythm Pattern into the 3rd bar.

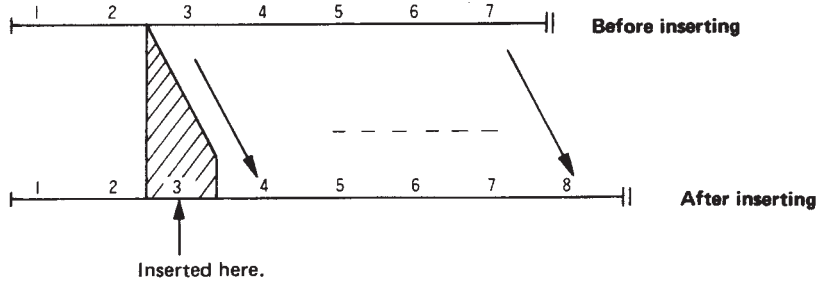

- ① Recall the 3rd bar.

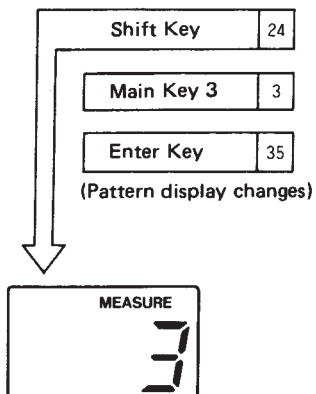

- ② Select the Rhythm Pattern (Pattern Group, Pattern Number).

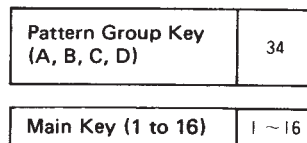

- ③ Take insert procedure

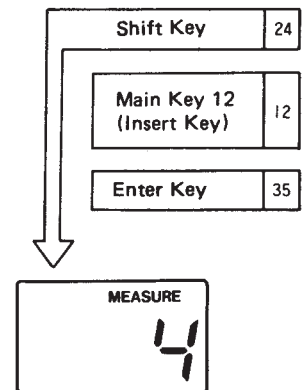

7 OTHER USEFUL FUNCTIONS FOR EDITING

a. Copying a single Pattern

A Rhythm Pattern can be copied from one memory location to another. After copying, the Pattern will remain in its original location as well as appearing in the new location you have chosen.

Operation for copying

- ① Enter the Pattern Writing mode.
- ② Assign the new location (Pattern Number) which your Pattern is copied to, by using Pattern Group Button (A, B, C, D) and Pattern Number Button (Main Key 1 to 16).
- ③ While holding the Shift Key **⏏** down, push the Copy Key (Main Key 11), the Pattern Group Button and Pattern Number Button assigning your source Pattern, then the Enter Key.

It is not possible to copy the Chained Patterns altogether at a time. You need to break the Chain once, then copy the pattern one by one. Then finally chain the patterns again. (See p 29)

b. Copy (in Track Writing Mode)

You can copy any Bar or sequence of Bars into a Track. The arrival of the new Patterns will extend the length of the Track accordingly. The difference between COPY and INSERT is that Insert deals with patterns while Copy adds extra bars from an existing Track, either within the same Track or a different Track. To follow the Copying procedure:

- ① Enter the Track Writing mode. Select the Track you want by pushing a Track Selector Button.
- ② Assign the bar number after which you wish the new pattern to begin, by holding the Shift Key, entering the bar number and pushing the Enter Key.
- ③ While holding the Shift Key, push the Copy (Main Key 11), appropriate Main Keys (1 to 10) assigning the starting bar number, then the Enter Key, and the ending bar number, then the Enter Key. Be sure that all are done while the Shift Key is being held down.
(See the Example on page 30)

NOTE

- * Please make sure that the composer is not running during the above Copying operation.
- * Some copies are impossible. For example, you cannot copy Bars 20 to 25 into Bar 22 of the same Track. If the Copy is impossible, or memory is full (exceeding 998 bars) the Display will respond with:

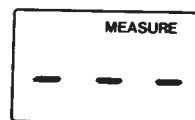

c. Chaining patterns together

The Chaining function allows two or more Patterns to be chained so that they play as one. This is useful for any Bar consisting of more than 16 steps (e.g. $\frac{5}{4}$ = 1 step or odd times such as $\frac{5}{4}$ or $\frac{7}{8}$).

- ① Enter the Pattern Writing mode, and select a pattern group by using the Pattern Group Buttons (A, B, C, D).
- ② Select the Main Keys belonging to the first and last number of the Patterns you wish to chain, and hold these down, and without releasing them, push the Enter Key.

To drop a Pattern from the Chain, hold the relevant Main Key down, and push the Enter Key.

NOTE

This Chain function, naturally is available just for the adjacent Patterns.

- Even the whole Pattern group (Key 1 to 16) can be chained if desired.
- You may need to change the Scale before writing the Rhythm Patterns so that they all play with the same time value.
- To play a Chain, select any of the Patterns which belong to the Chain and the whole chain will play.
- To break a Chain hold down each pattern key in turn and push the Enter Key.

Example Copy

- To copy 13th to 16th measures into the 19th measure.

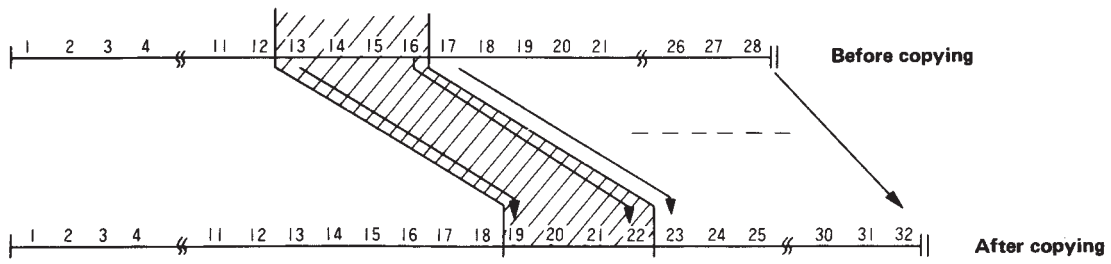

- 1 Recall the 19th bar.

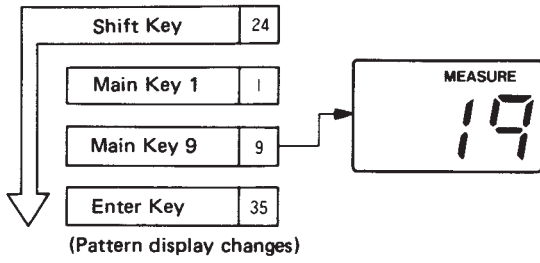

- 2 Take copy procedure and copy 13th to 16th bar.

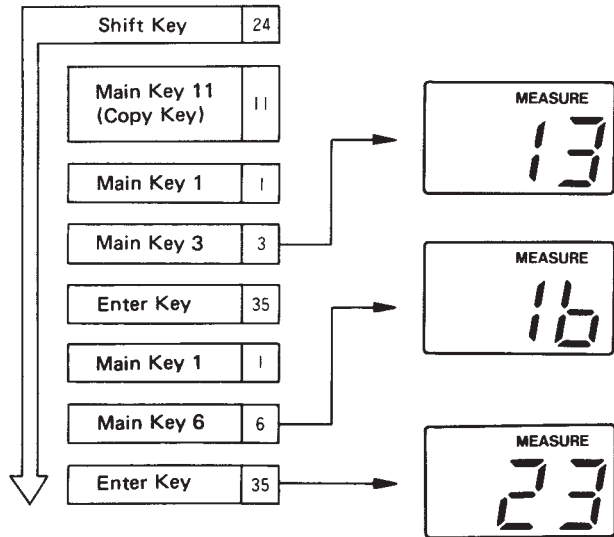

8 TAPE INTERFACE

Even if the optional Memory Cartridge is not available, the TR-727's Tape Interface allows the Tracks written into memory to be stored on tape (=Save).

This saving, however, requires much more complicated procedure than that by memory cartridge.

a. Saving

First of all, connect the tape recorder and the composer as shown below.

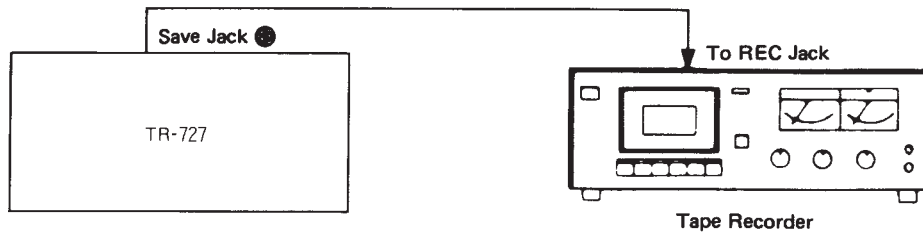

- ① Set your tape recorder ready to record using the Pause key if you have one.
- ② Start the tape recorder.
- ③ While holding the Shift Key down, press the Save (Main Key 14), then the Enter.

The Display will respond with  showing that it is now in saving mode.

- * If your tape recorder features a recording level meter, set it on +3VU, and if featuring a signal indicator, make sure that signal is being received.

For about 7 seconds after the Enter Key is pressed, the Pilot tone is heard then it is followed by the modulated tone which carries the data. In the Display Window, the dots on the line of Low Timbale light from the 1st step to right showing the progress of the saving during which all indicators go out. When the lighting reaches up to 14th step, the Display and indicators go back to the normal condition.

STEP	1	2	3	4	5	6	7	8	9	10	11	12	13	14	15	16
QUIJADA/CHIME																
WHISTLE																
CABASA/MARACAS																
AGOGO																
LOW TIMBALE	●	●	●	●	●	●	●	●	●	●	●	●	●	●	●	●
Hi TIMBALE																
LOW CONGA																

- ④ Stop the tape recorder.

To ensure the data has been properly saved, go to the next verifying operation.

- * At any time during saving, pushing the Main Key 1 can stop the saving operation.

b. Verification

Connect your recorder as shown below.

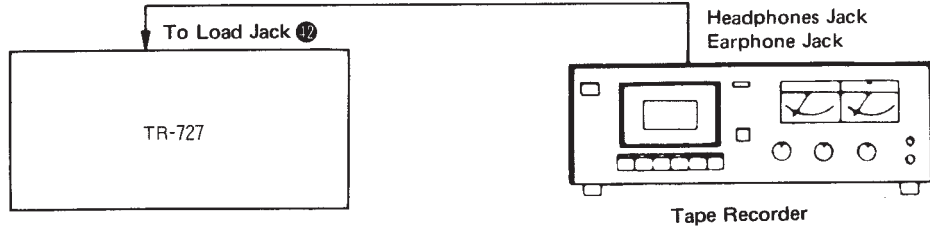

- ① Wind back the tape to the start of your pilot tone.
- ② While holding the Shift Key down, push the Verify Key (Main Key 15) then the Enter Key.

On pressing the Verify Key, the Display shows . Then on pressing the Enter Key, all the indicators go out.

STEP	1	2	3	4	5	6	7	8	9	10	11	12	13	14	15	16
QUIJADA/CHIME																
WHISTLE																
CABA SA/MARACAS																
AGOGO																
LOW TIMBALE	●	●	●	●	●	●	●	●	●	●	●	●	●	●	●	●
HI TIMBALE																
LOW CONGA																

- ③ Start your recorder on play.

When the data is found, the Display will show:



Watch the Display, if the dots on the line of Hi-Tom light from 1st step to 14, then the data has been properly saved.

- ④ Stop the tape recorder.

* At any time during verifying, pushing the Main Key 1 can stop verifying operation.

Error Indication

If  is shown in the Display, stop the tape recorder, then press the Main Key 1. Then repeat the Verifying operation with a different volume setting.

If the error indication is still showing no matter how many times you try, repeat saving procedure. If it is still not remedied, try saving with a different tape recorder.

c. Loading

The loading procedure is used to take a Track stored on tape and load it into the Composer. Loading procedure is exactly the same as the Verifying except that you use the Load Key instead of Verify. Likewise, the tape recorder connections are the same. Of course, you must push the Play Button on the Pilot tone to avoid missing out data.

- * At any time during loading, pushing the Main Key 1 can stop the loading operation.

d. Setting a File Number

A file number (1 to 99) can be allotted to data when you are saving it. This means that later when you are loading, you can specify the file number and the Composer will choose that file from the others and load it: provided you remember what the file number is. If load files, whether numbered or not, without specifying the file number, then the Composer will load the first file it comes to.

To allocate a file number

After pushing the Save Key during step ③ in Saving procedure on page 31, choose a file number (1 to 99) from the Main Keys (1 to 10), then push the Enter Key.

The assigned file number is shown in the Display.

To load a numbered file

After pushing the Load Key (Main Key 16) in the Loading procedure, assign the file number by pressing the relevant Main Key (1 to 10), and the Enter Key. If you do not assign any file number, the data first found will be automatically loaded.

NOTE

- * Until the assigned data is found, the Display will show P (Pass).

- * When the assigned file number is found, the Display shows F (Found), and loading starts.

If the data is properly saved on tape, loading will be done without any problem, unless the tape is damaged during preservation. If you want to load a numbered file, then see the following "d. Setting a File Number"

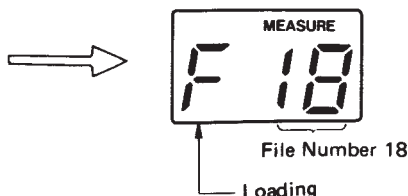
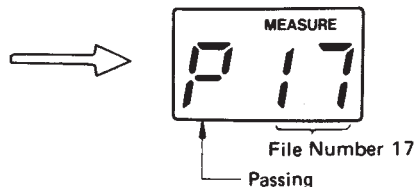
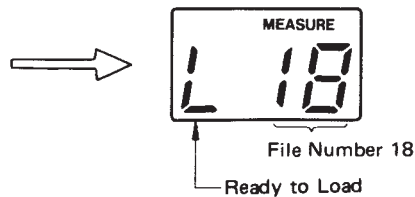
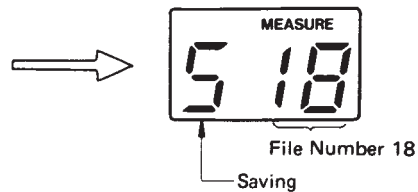

9 MEMORY CARTRIDGE

The Memory Cartridge M-64 is an optional extra which will save and load data instantly instead of using a tape recorder. It acts as additional memory to enable three times more capacity of Tracks to be held by the Composer at any one time. When many tracks are needed during a live performance, new tracks can be loaded into the Composer during a break or intermission, after the old ones have been performed. Memory Cartridge also permits the safe storage of data which might otherwise be lost through being accidentally written over.

You may consider the internal memory of the composer as Bank 1, the Memory Cartridge as Bank 2 and 3. The data in the Cartridge can be used in exactly the same way as using the data in the Composer's internal memory. Just note that to save the data in the cartridge onto a tape, it should be loaded from the cartridge into the composer then saved onto a tape, and vice-versa.

To operate the Memory Cartridge:

Load the cartridge by inserting it into its slot located at the upper left of the composer's front panel. Before connecting the Memory Cartridge to the Composer, be sure that it is entered to the Track Playing mode, the rhythm is not running and the Protect Switch on the Cartridge is set to the ON position. The ON/OFF operation of the Protect Switch should always be done while in the Track Play mode.

a. Selecting a Bank

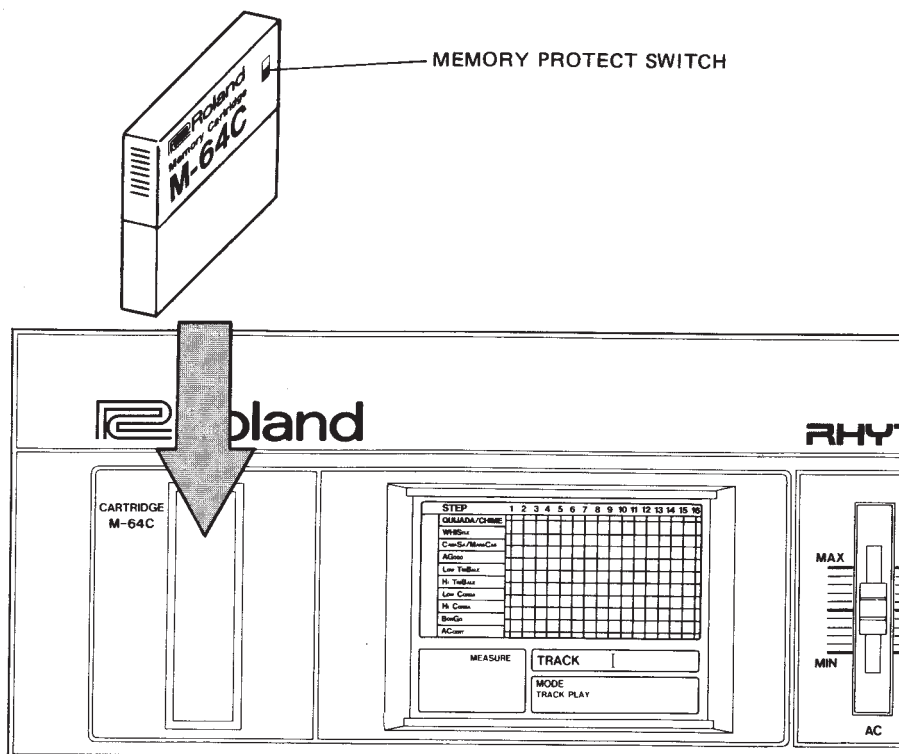
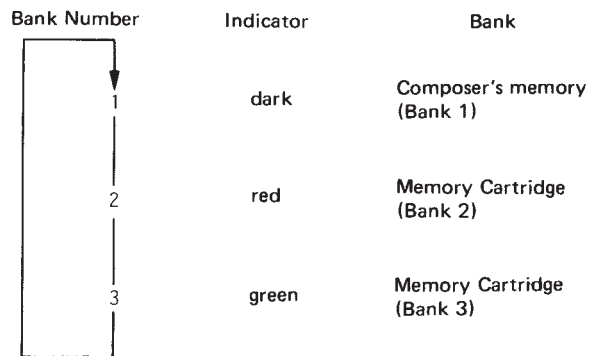
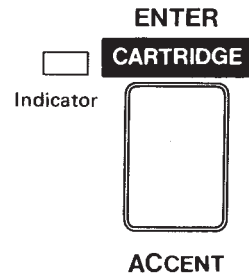

Enter the Track Playing mode with the rhythm not running. Then, press the Cartridge Key (Enter Key) while holding the Shift Key down, and the bank moves as shown below.





b. Saving and Loading

1) Saving data onto the cartridge

Enter the Track Playing mode with the rhythm not running.



- ① While holding the Shift Key  down, press the Cartridge Key (=Enter)  to select Bank 2 or 3. Each time you press the Cartridge Key, the banks will change as shown a. Selecting a Bank on page 35.
- ② Set the Protect Switch on the Memory Cartridge to OFF.
- ③ While holding the Shift Key down, press the Copy Key (Main Key 11), then the Main Key 1, then the Enter Key.





On pressing the Copy Key, the Display Window will show the selected Bank 2 or 3. And on pressing the Main Key 1,  or  appears showing that data in Bank 1 is being saved to Bank 2 or 3. On pressing the Enter Key, the Display will show the 1st pattern of the saved data. And, now saving is done.

- ④ Return the Protect Switch to ON.

2) Loading data from the cartridge

Enter the Track Playing mode with the rhythm not running.

- ① While holding the Shift Key  , press the Cartridge Button  to select Bank 1 (Composer's memory).
- ② While holding the Shift Key down, press the Copy Key (Main Key 11), then the Main Key 2 or 3 depending on which bank you wish to load, then the Enter Key  .

On pressing the Copy Key, the Display Window will show  , and on pressing the Main key,  or  appears showing that data in Bank 2 or 3 whichever has been selected is being loaded into the Composer. In a few seconds after pressing the Enter Key, the Display will show the 1st pattern of the loaded data. And, now loading is completed. In the same way, you can transfer data from bank 2 to 3  , or from 3 to 2  .

10 EXTERNAL CONNECTIONS

There are many ways of connecting the Composer to other instruments, special effects and external controls, especially through the use of MIDI. This Chapter describes how to use these connections which can all be found on the back panel of the Composer.

a. Multi Output

There is a separate output socket for each voice. All voices are normally summed together at the Master output. Any voices taken out separately will be subtracted from the total. Effect units may be Echo, Delay, Reverb, Graphic Equalizer, Flanger, etc.

b. Trigger Output, Start/Stop

A positive 5 volt pulse of 20ms is available in the same interval as written Hi Agogo.

An external Pedal Switch performs the same function as Start/Stop.

(See the picture below.)

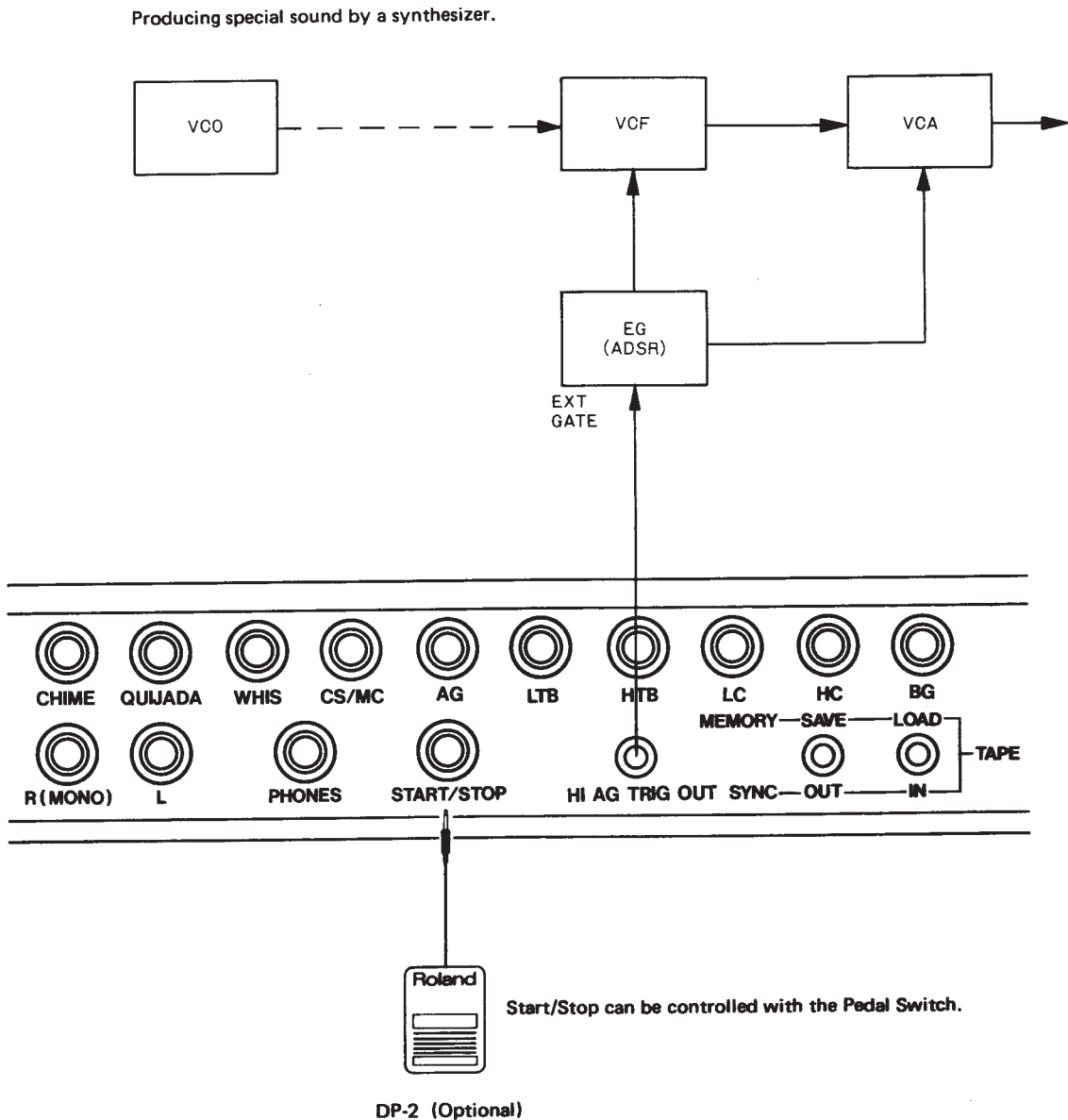

11 SYNC

The TR-727 features Sync function using DIN socket, MIDI connector and tape recorder.

To change the Sync modes, set the Composer to Track Play mode without rhythm running, and push the Sync Mode Button **31** while holding the Shift Key **24** down.

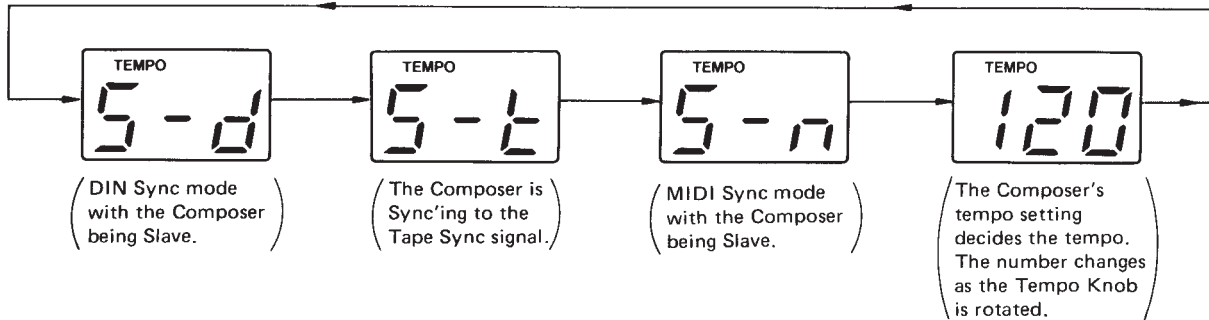

a. Sync using DIN

The DIN socket marked "SYNC" is for use with non-MIDI instruments.

When the Composer is controlling the tempo or set to Tape Sync mode, the DIN Connector on the back panel serves as an Output. To use the Composer as a Slave, however, convert it to an Input as follows.

Connect the composer to the master devices as shown in Fig a-1, and turn the TR-727 to the Track Playing mode. Then while holding the Shift Button **24** down, press the Sync Mode Button **31** until the Display becomes as shown in Fig a-2.

The TR-727 does not sync in the tempo quicker than $\downarrow = 250$, so be sure to set the tempo of the master instrument below that.

SYNC using DIN

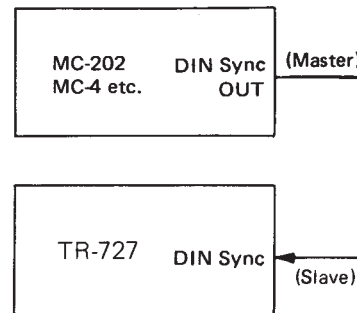

The Master device controls the tempo, start/stop, etc.

Fig a-1

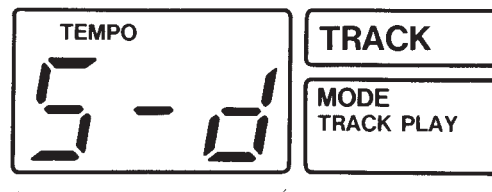

Display Reaction when the TR-727 serves as Slave in DIN Sync mode.

Fig a-2

b. Sync using MIDI

The TR-727 features MIDI output and input, therefore can sync with MIDI sequencer, etc.

1) Sync to slave devices

Connect the TR-727 to the slave device such as a sequencer, etc., as Fig b-1. Then set the slave device ready to receive Sync signal from the MIDI IN.

(Refer to the owner's manual of each device.)
Now, pressing the Start Key  of the composer will start sync'ing in the tempo of the composer.

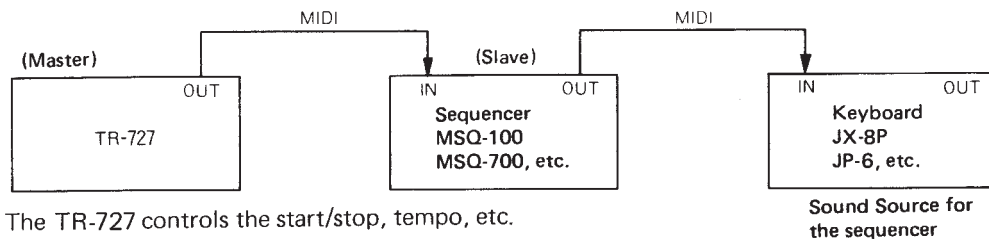

2) Sync to master device

Connect the TR-727 to the master device such as a sequencer, etc., as Fig b-2. Then take the following procedure to select MIDI Sync mode.

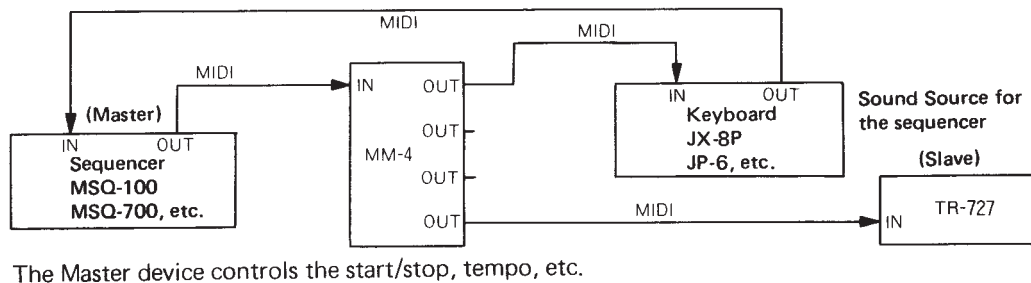

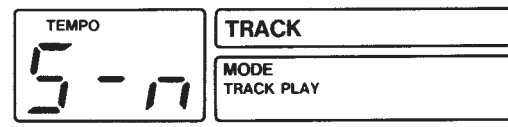

- ① Turn the composer to the Track Playing mode.
- ② While holding the Shift Key down, press the Sync Mode Button  until the Display becomes as shown right.

Now, the tempo and start/stop are controlled by the master device.



This indication means the TR-727 is in the MIDI Sync mode, serving as Slave.

How to return to the Internal Tempo Mode

While holding the Shift Key  down, push the Sync Mode Button  until the Tempo/Measure display section shows tempo value.

* In the MIDI Sync mode, there is no signal output from the DIN Sync Connector or Tape Sync Out Jack.

c. Sync using Tape Recorder

The Tape Sync jacks on the back panel (the same jacks used for saving and loading onto cassette) can be used to run the Composer from a Sync signal recorded on a tape.

1) Recording the Sync signal

- ① Connect the tape recorder as shown below.

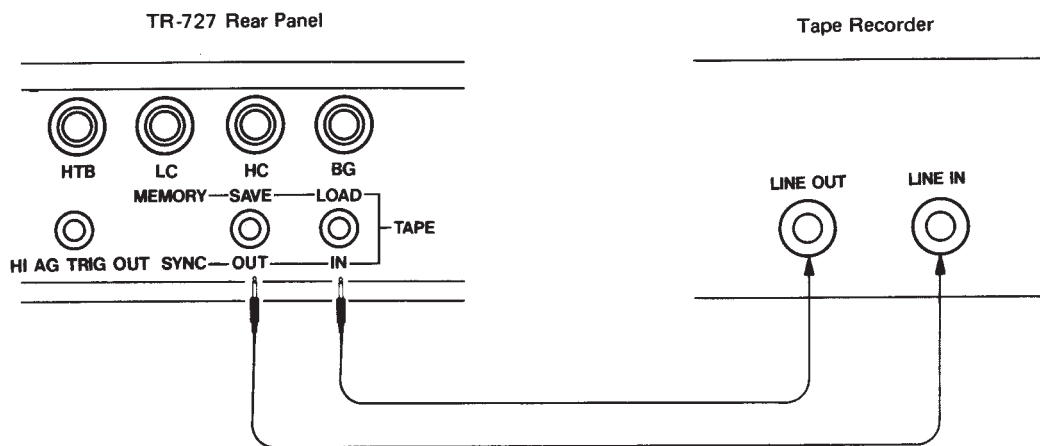



- ② With the rhythm not running, the Composer generates a signal at the Load jack. Adjust the tape deck so that the recording level reads about -10 to -3 VU.
- ③ Select the Track to be played and adjust the tempo.
- ④ Start recording, then in a few seconds push the Start Key to start the rhythm.
- ⑤ When the whole Track has played and the Composer stops, stop the recorder.

Be sure to set the tempo slower than $\text{♩} = 180$.



2) Controlling the Composer from the tape recorder

The composer can sync to the synchro signal recorded on tape, which is useful for multitrack recording.

- ① Connect the Composer to the tape recorder as shown in Fig c-2.
- ② Cue the tape recorder so that it will play from the beginning of the Pilot tone.
- ③ Select the Track Playing mode, then select the Track to be played.
- ④ Press the Sync Mode Button  while holding the Shift Key  until the Display shows as Fig c-3.
Now, the Composer is ready to be controlled by the synchro signal sent to the Tape Sync jack.
- ⑤ Press the Play button on the tape recorder.
- ⑥ Press the Start Key  on the composer.



Be sure to push the Start Key, before the Pilot tone turns to modulated tone.

The moment the Pilot tone turns to modulated tone, the composer starts sync'ing.

- ⑦ You can leave the Tape Sync mode before starting the Composer, by pushing the Sync Mode Button . You can stop it while running, by pushing the Stop/Continue Key .

* If slave instruments are connected to the Composer by MIDI or DIN, they will sync together.

How to return to the Internal Tempo Mode

While holding the Shift Key  down, push the Sync Mode Button  until the Tempo/Measure display section shows tempo value.

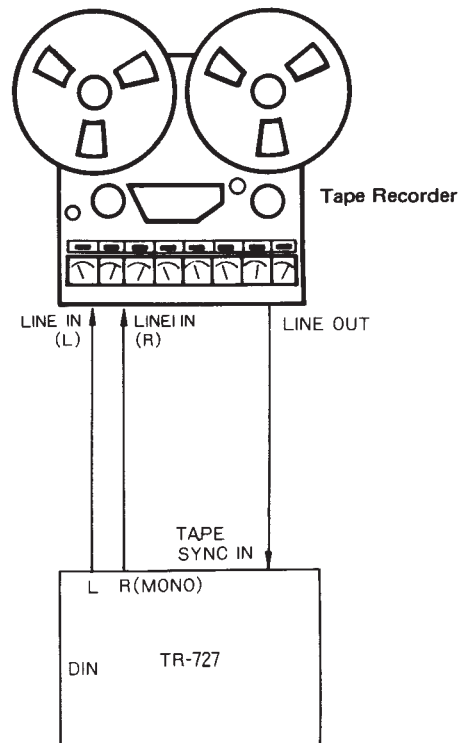

Fig c-2

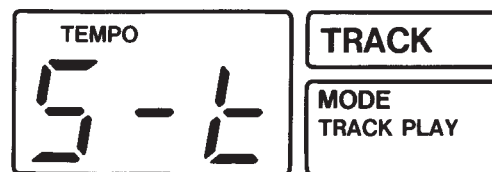

Fig c-3

12 MIDI

The TR-727 has two MIDI Connectors, IN and OUT. (See the separate volume "MIDI"). If the Composer is connected through its MIDI OUT to another

instrument's MIDI IN connector, then the Composer will control that instrument, and vice-versa.

The TR-727 can transmit and receive the following MIDI messages.



1. Key message for each voice (here, each instrument voice is represented by key number)
2. Track Number (Song Select) message
3. Bar Number (Song Position) message
4. Synchro Signal such as Tempo Clock, Start/Stop, etc.



The messages 1, 2 and 3 can be sent or received only in Track Play mode.

a. Setting MIDI Channel

MIDI message can be sent or received only on the same MIDI Channel, that is, the MIDI instruments should be set up properly, and also select the same MIDI Channels.

The TR-727 has 16 MIDI Channels and any of these channels can be selected using the Main Keys (1 to 16) depending on the device used with the TR-727.

- 1) First, check how the Display reacts by pressing the MIDI Channel Button  while holding the Shift Key  down.

- 2) Now, try changing channel numbers. While holding the Shift Key  down, push the MIDI Channel Button  then the Main Key (1 to 16) selecting the channel number (1 to 16).

The Tempo/Measure section of the Display shows the MIDI channel currently set.

* The Display shows the channel number you have set.

Indication of OMNI Mode ON/OFF & MIDI Channel.

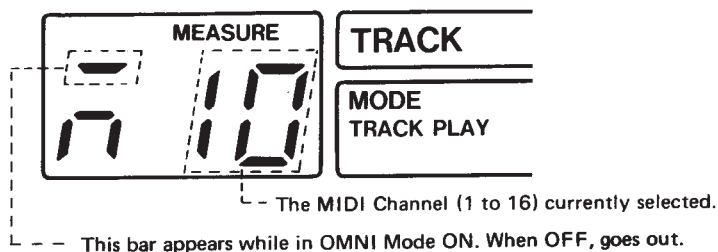

b. OMNI Mode



As explained in the former section, to enable MIDI voice messages to be communicated by means of MIDI, it is critical to set the MIDI channel of all the relevant MIDI instruments to the same numbers. OMNI ON mode, however, makes the receiver recognize voice messages in all channels without discrimination. Use the OMNI ON or OFF mode which makes the receiver accept voice messages only from the selected channel(s), depending on the situation.

Operation to select OMNI ON or OFF

Enter the Track Writing mode with the rhythm not running.

1) First, see how the Display reacts by pressing the MIDI Channel Button  while holding the Shift Key  down.

The Tempo/Measure section of the Display will show either OMNI ON or OMNI OFF whichever happens to be selected currently.

2) Try changing the modes, by holding the Shift Key  down and pushing the MIDI Channel Button  then the Enter .

Repeat the above procedure 2) to return to the previous mode.

Indication of OMNI Mode ON/OFF & MIDI Channel.

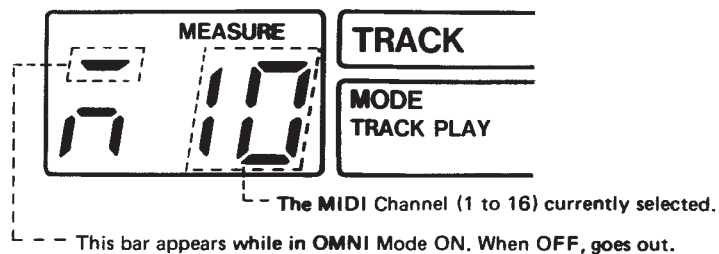

c. Key Number (Assigning Key numbers to the Composer's instrument voices)

The keyboard message sent from the sequencer or keyboard is received by the TR-727 and makes the instrument voices sound. Any key number can be assigned to each drum voice later, but let's see the initial setting from the manufacturer.

Instrument Voices and corresponding Key Numbers. (MIDI IN)

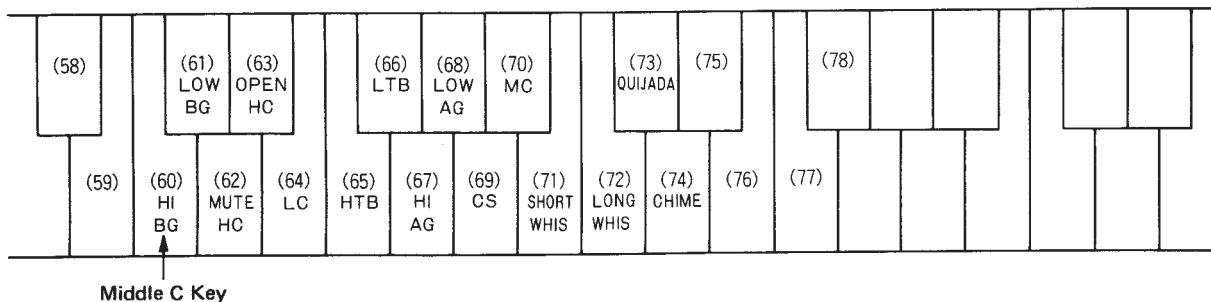

The numbers in () are the Key numbers.

1) Even if the initial setting shown above has been altered for some reason when you get your TR-727 you can initialize it as follows.

- ① Enter the Track Playing mode, with the rhythm not running.
- ② While holding the Shift Key down, press the MIDI Channel Button TWICE. All the indicators of Pattern Group Buttons and Main Keys will go out, telling you that key numbers can now be assigned to the voices.
- ③ Press the Instrument/Guide Button , and the initial setting is returned.
- ④ To leave this Key Number Setting mode, push the Enter Key .

2) To assign a Key number you like to each voice.

- ① First, connect the Composer to the MIDI instruments as shown in Fig c-2.

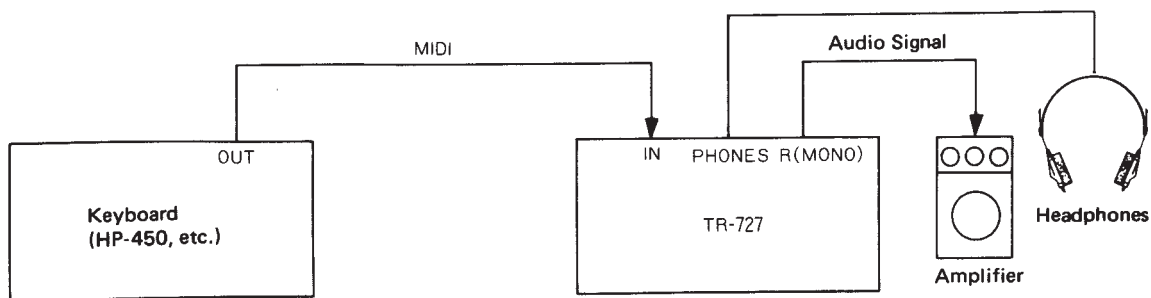

Set the amplifier and speaker so that you can monitor each instrument voice.

Fig c-2

- ② Enter the Track Writing **mode**, without the rhythm having run.
- ③ While holding the Shift Key ●, press the MIDI Channel Button ⑩ TWICE. **All the** indicators of Pattern Group Buttons **and Main Keys** will go out, telling you that **key numbers** can now be assigned to the voices.
- ④ Push the Track Clear Button ●. This clears previous key number **assignment**.
- ⑤ Select an instrument **voice** and hold the corresponding Main Key **down**, and without releasing it, press a key **on the connected** instrument.
- ⑥ To cancel **the key assignment** you have made, press the **same key again**.

- ⑦ If you wish to actually listen to the reaction of the instrument sound here, try it by playing the relevant key on the instrument.
- ⑧ To cancel this Key Number Setting mode, push the Enter Key ⑪.

Several key numbers can be set to one voice, but the same number cannot be assigned to more than one voice.

If you assign the key number already used for a certain voice to another voice, the previous voice will be automatically dropped.

The key numbers available for this assignment are 35 to 98.

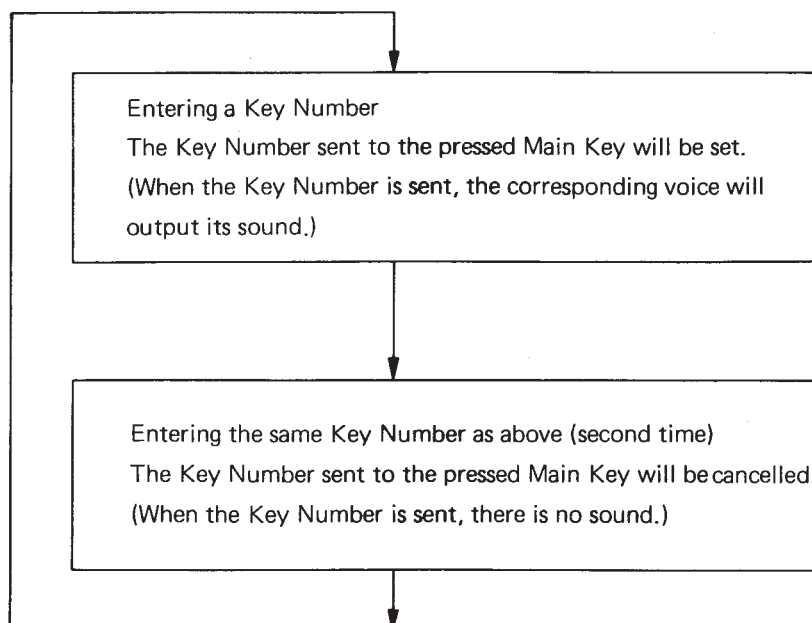

d. Transmitting MIDI message from the Composer

The MIDI message sent from the Composer is received by the connected instrument and makes the keys produce sounds. There are two kinds of assignments optional as shown in the Fig d-1 or 2 below. The following operation is to choose one of them.

- ① Enter the Track Playing mode, without rhythm running. Then while holding the Shift Key **24** down, push the MIDI Channel button **30** and the Instrument/Guide Button **29**. Turn the TR-727 to the Key message transmitting mode. (Each time you push the Instrument Guide Button, the TR-727 is turned to the internal voice mode and Key message transmitting mode alternately.)

NOTE

- * When the Composer is transmitting MIDI message, the built-in voices do not output any sound.
- * The Key message transmitting mode is available only while in the Track Play mode. In this mode, only the programmed sounds will be transmitted.

- ② Enter the Track Playing mode, without rhythm running. Then while holding the Shift Key **24** down, push the MIDI Channel Button **30** and the Last Step Button **26**. Table in Fig d-1 and in Fig d-2 are alternately selected.

Triggers of Voices and corresponding Key Numbers (MIDI OUT)

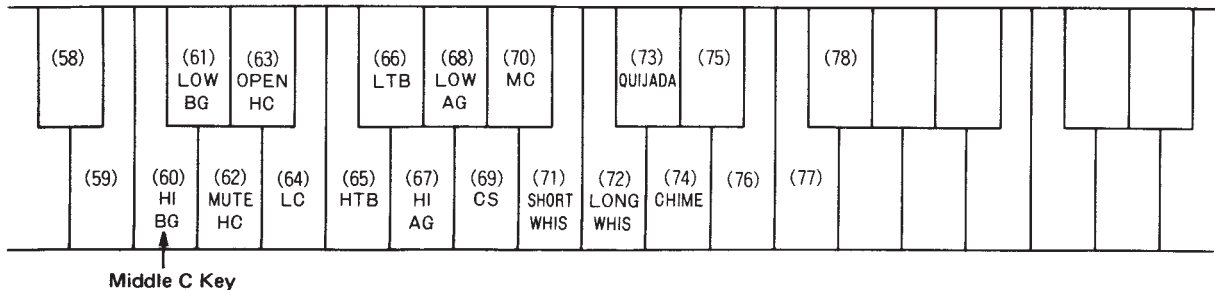

The numbers in () mean the Key Numbers, and the words below them are the Triggers' names of the Voices.

Fig d-1

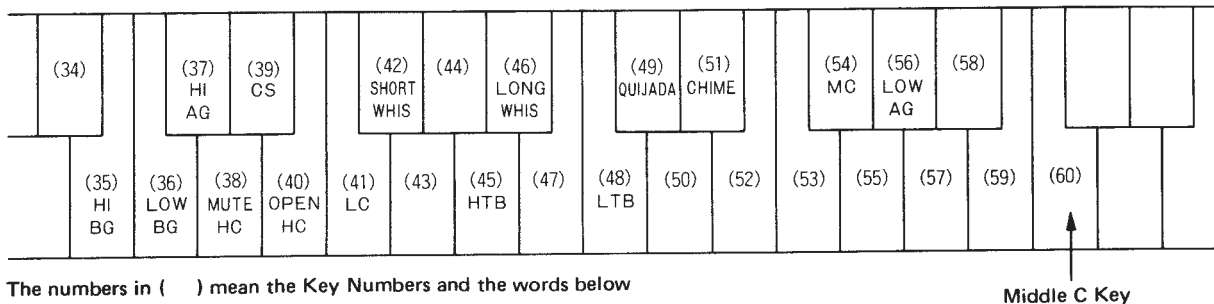

The numbers in () mean the Key Numbers and the words below them are the Triggers' names of the Voices.

Middle C Key

Fig d-2

Pattern # :

BANK :

PATTERN GROUP :



SHUFFLE : 1 2 3 4 5

FLAM : 9 10 11 12 13

STEP

1 2 3 4 5 6 7 8 9 10 11 12 13 14 15 16

LAST STEP

QUIJADA/CHIME

WHISTLE

CABASA/MARACAS

AGOGO

LOW TIMBALE

HI TIMBALE

LOW CONGA

HI CONGA

BONGO

ACCENT

1 2 3 4 5 6 7 8 9 10 11 12 13 14 15 16

Pattern # :

BANK :

PATTERN GROUP :



SHUFFLE : 1 2 3 4 5

FLAM : 9 10 11 12 13

STEP

1 2 3 4 5 6 7 8 9 10 11 12 13 14 15 16

LAST STEP

QUIJADA/CHIME

WHISTLE

CABASA/MARACAS

AGOGO

LOW TIMBALE

HI TIMBALE

LOW CONGA

HI CONGA

BONGO

ACCENT

1 2 3 4 5 6 7 8 9 10 11 12 13 14 15 16

Rhythm machine

MODEL **TR-727** MIDI Implementation Chart

Function.....		Transmitted	Recognized	Remarks
Basic Channel	Default Changed	1 - 16 1 - 16	1 - 16 1 - 16	Memorized
Mode	Default Messages Altered	Mode 3 *****	Mode 1 OMNI ON/OFF	MONO, POLY ignored
Note Number	True voice	35-42, 45, 46, 48, 49, 51, 54, 56, 60-74 *****	60-74 * 60-74 *	assigns to each rhythm voice
Velocity	Note ON Note OFF	○ 9n v=40-124 × 9n v=0	○ v=1-127 ×	n = 0 - \$F
After Touch	Key's Ch's	× ×	× ×	
Pitch Bender		×	×	
Control Change		×	×	
Prog Change	True #	× *****	×	
System Exclusive		○	○	For rhythm seq
System Common	Song Pos Song Sel Tune	○ ○ (0-3) ×	○ ○ (0-3) ×	
System Real Time	Clock Commands	○ ○	○ SYNC mode = MIDI ○ SYNC mode = MIDI	
Aux Messages	Local ON/OFF All Notes OFF Active Sense Reset	× × ** **	× × × ×	
Notes		* Recognized note numbers can be assigned by panel operation. (35-98) ** If received when SYNC mode is MIDI.		

Mode 1 : OMNI ON, POLY
Mode 3 : OMNI OFF, POLY

Mode 2 : OMNI ON, MONO
Mode 4 : OMNI OFF, MONO

○ : Yes
× : No

Rhythm machine

MODEL TR-727 MIDI Implementation

1. TRANSMITTED DATA

Status	Second	Third	Description
1001 nnnn	0kkk kkkk	0000 0000	Note OFF kkkkkkk = 35-51, 54, 56, 60-74
1001 nnnn	0kkk kkkk	0vvv vvvv	Note ON kkkkkkk = 35-51, 54, 56, 60-74 vvvvvvv = 40 - 124
1111 0010	0xxx xxxx	0yyy yyyy	Song Position Pointer xxxxxxx: Least significant yyyyyyy: Most significant
1111 0011	0sss ssss		Song Select sssssss = 0 - 3 (track #)
1111 1000			Timing Clock
1111 1010			Start
1111 1011			Continue
1111 1100			Stop
1111 0000	0100 0001	0xxx xxxx	Sequence Data (Exclusive message)
	1111 0111 (EOX)		

Notes: *1 Transmitted channel # can be changed to 1 - 16 from the front panel. When the power is applied, the latest channel # set prior to the last power OFF remains unchanged.
*2 When the measure number is set.
*3 When the track # is set.

track #	sssssss
1	0
2	1
3	2
4	3

*4

Tempo Mode	Synchronized with
Internal	internal tempo clock
MIDI mode	received timing clock
DIN mode	positive edge of the DIN clock

*5 Note numbers are assigned as follows:

Key Name	Setting A kkkkkkk	Setting B kkkkkkk
Hi Bongo	60	35
Low Bongo	61	36
Mute Hi Conga	62	38
Open Hi Conga	63	40
Low Conga	64	41
Hi Timbale	65	45
Low Timbale	66	48
Hi Agogo	67	37
Low Agogo	68	56
Cabasa	69	39
Maracas	70	54
Short Whistle	71	42
Long Whistle	72	46
Quijada	73	49
Star Chime	74	51

Setting A: Normal.
Setting B: When the 'MIDI CH' then 'LAST STEP' buttons are pressed while the 'SHIFT' button is being pressed.

2. RECOGNIZED RECEIVE DATA

Status	Second	Third	Description
1001 nnnn	0kkk kkkk	0vvv vvvv	Note ON kkkkkkk = 60-74 vvvvvvv = 1 - 127
1011 bbbb	0111 1100	0000 0000	OMNI OFF
1011 bbbb	0111 1101	0000 0000	OMNI ON
1111 0010	0xxx xxxx	0yyy yyyy	Song Position Pointer xxxxxxx: Least significant yyyyyyy: Most significant
1111 0011	0sss ssss		Song Select sssssss = track #
1111 1000			Timing Clock
1111 1010			Start
1111 1011			Continue
1111 1100			Stop
1111 0000	0100 0001	0100 0010	Sequence Data (Exclusive message)
	1111 0111 (EOX)		

Notes: *1 Received channel # can be changed to 1 - 16 from the front panel. When the power is applied, the latest channel # set prior to the last power OFF remains unchanged.

*2 Recognized while in the Track Play mode. Any of the key numbers (35 - 98) may be assigned to each instrument from panel operation, and will be kept assigned even after the power is turned OFF. Received note numbers are assigned at the factory as follows:

kkkkkkk	Instrument
60	Hi Bongo
61	Low Bongo
62	Mute Hi Conga
63	Open Hi Conga
64	Low Conga
65	Hi Timbale
66	Low Timbale
67	Hi Agogo
68	Low Agogo
69	Cabasa
70	Maracas
71	Short Whistle
72	Long Whistle
73	Quijada
74	Star Chime

All the note OFF messages are ignored.

*3 Recognized while the unit STOPS in the Track Play mode.
*4 When the SYNC mode is at MIDI.

While in the Tape Interface mode, all MIDI messages are ignored.

3. HANDSHAKING COMMUNICATION

3.1 Message type

3.1.1 Want to send a file (WSF)

Byte	Description
a 1111 0000	Exclusive status
b 0100 0001	Roland ID #
c 0101 0000	Operation code
d 1111 0111	End of System Exclusive

3.1.2 Request a file (RQF)

Byte	Description
a 1111 0000	Exclusive status
b 0100 0001	Roland ID #
c 0101 0001	Operation code
d 1111 0111	End of System Exclusive

3.1.3 Data (DAT)

Byte	Description
a 1111 0000	Exclusive status
b 0100 0001	Roland ID #
c 0101 0010	Operation code
d 0000 0010	Format type
e 0100 nnnn	Block # (0 - 14)
f 0000 xxxx	
0000 yyyy	
0000 xxxx	
0000 yyyy	
g 0sss ssss	Check sum (for preceding 512 data bytes)
h 1111 0111	End of System Exclusive

Note: Summed value of the all bytes in data and the check sum must be 0 (7 bits)

3.1.4 Acknowledge (PAS)

Byte	Description
a 1111 0000	Exclusive status
b 0100 0001	Roland ID #
c 0101 0011	Operation code
d 1111 0111	End of System Exclusive

3.1.5 Continue (CNT)

Byte	Description
a 1111 0000	Exclusive status
b 0100 0001	Roland ID #
c 0101 0100	Operation code
d 1111 0111	End of System Exclusive

3.1.6 End of file (EOF)

Byte	Description
a 1111 0000	Exclusive status
b 0100 0001	Roland ID #
c 0101 0101	Operation code
d 1111 0111	End of System Exclusive

3.1.7 Communication error (ERR)

Byte	Description
a 1111 0000	Exclusive status
b 0100 0001	Roland ID #
c 0111 0001	Operation code
d 1111 0111	End of System Exclusive

3.1.8 Rejection (RJC)

Byte	Description
a 1111 0000	Exclusive status
b 0100 0001	Roland ID #
c 0111 0000	Operation code
d 1111 0111	End of System Exclusive

3.2 Sequence of communication

3.2.1 When the RQF is recognized

a RQF :	Request a File	(received)
b DAT :	Data	(transmitted)
CNT :	Continue	(transmitted)
PAS :	Acknowledge	(received)
:	:	:
:	:	:
:	:	:
:	:	:
c DAT :	Data	(transmitted)
EOF :	End of File	(transmitted)
PAS :	Acknowledge	(received)

3.2.2 When the WSF is recognized

a WSF :	Want to Send a file	(received)
b RQF :	Request a File	(transmitted)
c DAT :	Data	(received)
CNT :	Continue	(received)
PAS :	Acknowledge	(transmitted)
:	:	:
:	:	:
:	:	:
d DAT :	Data	(received)
EOF :	End of file	(received)
PAS :	Acknowledge	(transmitted)

3.2.3 When the WSF is received with error.

a WSF :	Want to Send a file	(received)
b RJC :	Rejection	(transmitted)
	(The sequence will abort then return to normal operation.)	

3.2.4 When the RQF is received with error.

a RQF :	Request a file	(received)
b RJC :	Rejection	(transmitted)
	(The sequence will abort then return to normal operation.)	

3.2.5 When the ERR is recognized.

:	:	:
:	:	:
DAT :	Data	(transmitted)
CNT :	Continue	(transmitted)
ERR :	Communication error	(received)
DAT :	Data (same block)	(transmitted)
CNT :	Continue	(transmitted)

3.2.6 When DAT or others is received with errors.

:	:	:
:	:	:
DAT :	Data	(received)
ERR :	Communication error	(transmitted)
	The unit will expect to receive the previous DAT.	

5 Specifications

TR-727 RHYTHM COMPOSER

Memory Capacity 64 Patterns
(4 Pattern Groups x 16)

Tempo ♩ = 38 to 250

Tracks 4 tracks
(I to IV tracks up to 998 bars)

Step number (per bar) 1 to 16 steps

Drum Voices (15 Voices)

Bongo (Hi/Low)
Hi Conga (Mute/Open)
Low Conga
Hi Timbale
Low Timbale
Agogo (Hi/Low)
Cabasa/Maracas
Whistle (Short/Long)
Quijada
Star Chime
Total Accent (2 levels)

Controls & Indicators

Start Key
Stop Continue Key
Shift Key
Main Keys (1 to 16)
Clear Button

In Pattern Mode

Scale Button
Last Step Button
Instrument Select/Guide Button

In Track Mode

Back Button
Forward Button
Last Measure Button

Shuffle/Flam Button
Tempo/Measure Button
Enter Key/Accent Key
Pattern Group Buttons (A, B, C, D)

Shift Function

MIDI Channel Button
Sync Mode Button
Memory Cartridge Key
Track Selector Buttons (I to IV)
Pattern Mode Button

Track Mode Button
Tempo Knob
Accent Level Knob
Bongo Level Knob
Hi Conga Level Knob
Low Conga Level Knob
Hi Timbale Level Knob
Low Timbale Level Knob
Agogo Level Knob
Cabasa/Maracas Level Knob
Whistle Level Knob
Quijada Level Knob
Star Chime Level Knob
Volume Knob
Display Window (Rhythm Pattern, Tempo/
Measure, Track Number, Mode sections)
Memory Cartridge Slot (for M-64C)

Rear Panel

Master Output (L, R/Mono)
Multi Outputs
Bongo (Hi/Low)
Hi Conga (Mute/Open)
Low Conga
Hi Timbale
Low Timbale
Agogo (Hi/Low)
Cabasa/Maracas
Whistle (Short/Long)
Quijada
Star Chime

MIDI Input
MIDI Output
Tape Memory/Sync
Save/Out
Load/In
External Control
Trigger Output (HI AG: +5V, 20ms pulse)
Start/Stop (DP-2)
Sync (In/Out)
(1: Run/Stop, 2: GND, 3: Clock, 5: Continue)
Power Switch
DC IN (for supplied AC Adaptor)

Power Consumption: 2.4W

Dimensions: 380(W) x 250(D) x 73(H) mm/
14-15/16" x 9-13/16" x 2-7/8"

Weight: 1.5 kg/3 lb 5 oz

Accessories: 12V AC Adaptor
Connection Cord
Owner's Manual
MIDI

Options: Pedal Switch DP-2
Memory Cartridge M-64C

