

 Roland

MIDI RHYTHM COMPOSER

TR-707

Owner's Manual

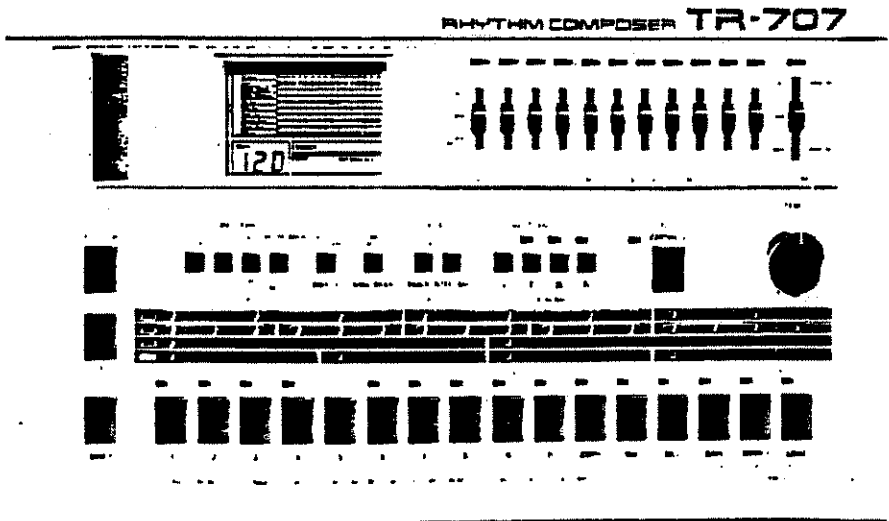

Radio and television interference

Warning — This equipment has been verified to comply with the limits for a Class B computing device, pursuant to Subpart J, of Part 15, of FCC rules. Operation with non-certified or non-verified equipment is likely to result in interference to radio and TV reception."

The equipment described in this manual generates and uses radio-frequency energy. If it is not installed and used properly, that is, in strict accordance with our instructions, it may cause interference with radio and television reception.

This equipment has been tested and found to comply with the limits for a Class B computing device in accordance with the specifications in Subpart J, of Part 15, of FCC Rules. These rules are designed to provide reasonable protection against such an interference in a residential installation.

However, there is no guarantee that the interference will not occur in a particular installation. If this equipment does cause interference to radio or television reception, which can be determined by turning the equipment on and off, the user is encouraged to try to correct the interference by the following measure:

- Disconnect other devices and their input/output cables one at a time. If the interference stops, it is caused by either the other device or its I/O cable.

These devices usually require Roland designated shielded I/O cables. For Roland devices, you can obtain the proper shielded cable from your dealer. For non Roland devices, contact the manufacturer or dealer for assistance.

If your equipment does cause interference to radio or television reception, you can try to correct the interference by using one or more of the following measures:

- Turn the TV or radio antenna until the interference stops.
- Move the equipment to one side or the other of the TV or radio.
- Move the equipment farther away from the TV or radio.
- Plug the equipment into an outlet that is on a different circuit than the TV or radio. (That is, make certain the equipment and the radio or television set are on circuits controlled by different circuit breakers or fuses.)
- Consider installing a rooftop television antenna with coaxial cable lead-in between the antenna and TV.

If necessary, you should consult your dealer or an experienced radio/television technician for additional suggestions. You may find helpful the following booklet prepared by the Federal Communications Commission:

"How to Identify and Resolve Radio-TV Interference Problems"

This booklet is available from the U.S. Government Printing Office, Washington, D.C., 20402, Stock No. 004-000-00345-4.

Contents

1	Panel Descriptions	3	7	Other useful functions for editing	26
2	Outline of the TR-707	6	a.	Copying a Single pattern	26
3	Connections	7	b.	Copy (within Tracks)	27
4	Operation	8	c.	Chaining patterns together	27
1	Getting to know your Composer	8	8	Tape Interference	31
a.	Manual Play	8	a.	Saving	31
b.	Demonstration Program	8	b.	Verification	32
2	Writing and playing rhythm patterns	9	c.	Loading	34
a.	Step Writing	9	d.	Setting a file number	34
b.	Tap Writing	14	9	Memory Cartridge	35
c.	Pattern Playing	16	a.	Selecting a Bank	35
3	About Last Step and Scale	17	b.	Saving and Loading	36
a.	Setting Last Step	18	10	External Connections	37
b.	Setting Scale	18	a.	Multi Output	37
4	Flam and Shuffle	20	b.	Trigger Out, Start/Stop	37
a.	Flam	20	11	SYNC	38
b.	Shuffle	21	a.	Sync using DIN	38
5	Track Writing and Playing	22	b.	Sync using MIDI	39
a.	Track Writing	22	c.	Sync using Tape Recorder	40
b.	Track Playing	23	12	MIDI	42
6	Editing	24	a.	Setting MIDI Channel	42
a.	Track Editing	24	b.	OMNI Mode	43
b.	Delete	25	c.	Key Number	44
c.	Insert	25	d.	Transmitting MIDI Message from the Composer	46
			5	Specifications	47

1 Panel Description

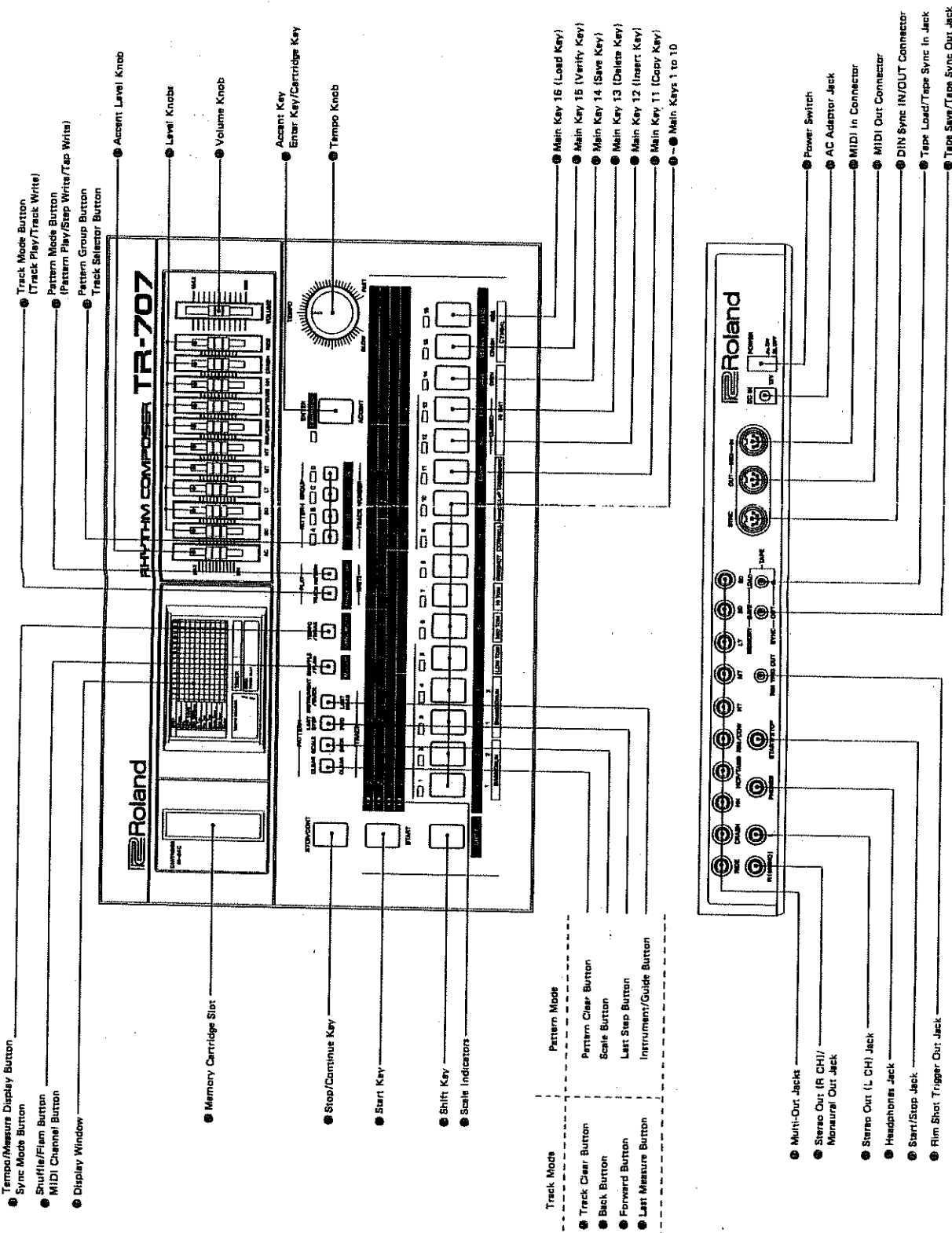

- Tempo/Measure Display Button
- Sync Mode Button
- Shuffle/Filter Button
- MIDI Channel Button
- Display Window
- Track Mode Button (Track Play/Track Write)
- Pattern Mode Button (Pattern Play/Step Writer/Tap Write)
- Pattern Group Button
- Track Selector Button
- Accent Level Knob
- Level Knob
- Volume Knob
- Accent Key
- Enter Key/Cartridge Key
- Tempo Knob
- Memory Cartridge Slot
- Stop/Continue Key
- Start Key
- Shift Key
- Scale Indicators

- Track Mode
- Pattern Mode
- Track Clear Button
- Back Button
- Forward Button
- Last Measure Button
- Pattern Clear Button
- Scale Button
- Last Step Button
- Instrument/Guide Button

- Main Key 16 (Load Key)
- Main Key 15 (Verify Key)
- Main Key 14 (Save Key)
- Main Key 13 (Direct Key)
- Main Key 12 (Insert Key)
- Main Key 11 (Copy Key)
- Main Keys 1 to 10
- Multi-Out Jacks
- Stereo Out (R CH)/Monaural Out Jack
- Stereo Out (L CH) Jack
- Headphones Jack
- Start/Stop Jack
- Rim Shot Trigger Out Jack
- Power Switch
- AC Adaptor Jack
- MIDI In Connector
- MIDI Out Connector
- DIN Sync IN/OUT Connector
- Tape Load/Tape Sync In Jack
- Tape Save/Tape Sync Out Jack

Important

- This unit might not work properly if turned on immediately after turned off. If this happens, simply turn it off and turn it on again a few seconds later.
- This unit might get hot while operating but there is no need to worry about it.
- Be sure to use the supplied AC Adaptor. Using any other adaptor may cause trouble. Do not use this adaptor with any other device, either.
- Do not switch the unit on without the AC Adaptor connected.
- Operating the TR-707 near a neon or fluorescent lamp may cause noise interference. If so, change the angle of the unit.
- Avoid using the unit in excessive heat or humidity or where it may be affected by direct sunlight or dust.
- Use a soft cloth and clean only with a neutral detergent.
- Do not use solvents such as paint thinner.
- View the Display from the proper angle.
- Please be careful not to damage the window.

Memory Back-up

The TR-707 features memory back-up system that retains the data even when switched off. A set of batteries (1.5V or UM-3 batteries x 2) supports its back-up circuit.

Be sure to keep the batteries securely connected even during AC operation.

Always replace with a complete set of new batteries once a year no matter how rarely you have used the unit.

Change the batteries with the TR-707 switched on, this way the memory can retain the data.

If the unit is not to be used for long periods of time, please save the data on a tape or cartridge then switch it off and remove the batteries, otherwise various troubles may be caused by battery leakage.

Please observe the following "Battery Replacement".

Please be sure that the polarities of the batteries are correct.

Battery Replacement

Please save the data in memory on a cartridge or tape to prevent accidental loss of memory during battery replacement.

Use two 1.5V (UM-3) batteries.

- 1 Remove the battery cover on the bottom of the unit.

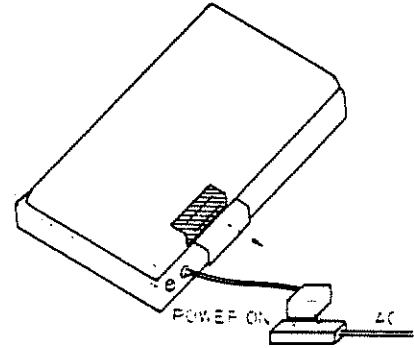

- 2 Remove the batteries from the battery case.

- 3 Place a new set of batteries taking care of the polarities.

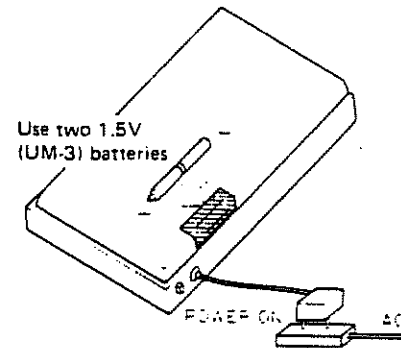

- 4 Replace the battery cover.

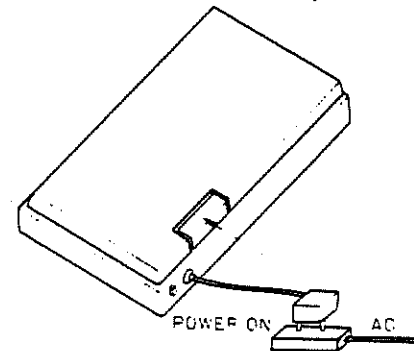

- Please be sure to do the entire battery replacing procedure with the unit switched on. Then the data in memory will be retained.

2 Outline of the TR-707

The Rhythm Composer TR-707 is a fully programmable rhythm machine which allows you to program 4 Rhythm Tracks or tunes (altogether 998 bars) from up to 64 kinds of user-created Rhythm Patterns.

Each of the 15 digital drum voices is extremely realistic and has a separate output jack for individual mixing, echo or equalizer.

An optional memory cartridge plugs directly into the Composer for instantaneous loading and saving, expanding the memory capacity by three times.

A Display window helps your operation to great extent.

MIDI Bus on the rear panel interfaces with other MIDI devices to allow control of several instruments.

Flam (Grace-note) and Shuffle can be added for greater variety and realism.

Now we'll find our way around the important controls before creating and storing ('writing') our own rhythm tracks. With any computer keyboard, the same key may do several different jobs depending on how it is used. The Composer, which is a type of computer, does this also. When switched on, the Composer automatically selects (or 'defaults' to) Track I.

"Default" means the value automatically selected by the Composer overridden by your command.

A Track is a complete tune in rhythm, made up of Patterns strung together (Patterns are covered later), and there is a demonstration tune written on Track I, II and III.

The SHIFT Key is used a lot. It enables many buttons and keys to perform two functions instead of just one. The distinction is clearly marked on the Composer: all functions enclosed with lines and highlighted are selected while the SHIFT Key is held down. All other functions do not need the SHIFT Key. The only exception to this rule is the ENTER Key.

The Main Keys numbered 1 to 16 are used for several tasks:

- (i) They produce the voices manually when tapped.
- (ii) They divide a bar of music into 16 parts, and enable voices to be written into any of these parts.
- (iii) They assign the instrument voices in turn when you are writing.
- (iv) They take care of all the "housekeeping" involved in editing Rhythm Patterns and Track, such as delete, insert and copy.
- (v) They set the Accent on the major voices.

Above the Main Keys is the scale of time values with a red LED beside each to indicate which is in operation. These indicate whether you are operating in 2/4, 3/4, 4/4, 6/8 or multiples of these times. Default value is 4/4, other times are set with the SCALE button.

Special times such as 5/4, 7/4 or any other can be set with the LAST STEP button. Mixed times which change each bar can also be set up.

We use the CLEAR button to erase rhythm patterns we want to write over, the FLAM button for adding Flam or 'grace notes' ahead of the main beat, and INSTRUMENT SELECT for selecting each voice in turn when writing Patterns.

Finally, don't worry if you can't get an immediate response from these controls; sometimes they operate only under special circumstances to protect your data. A full explanation of all controls follows in this Manual.

3 Connections

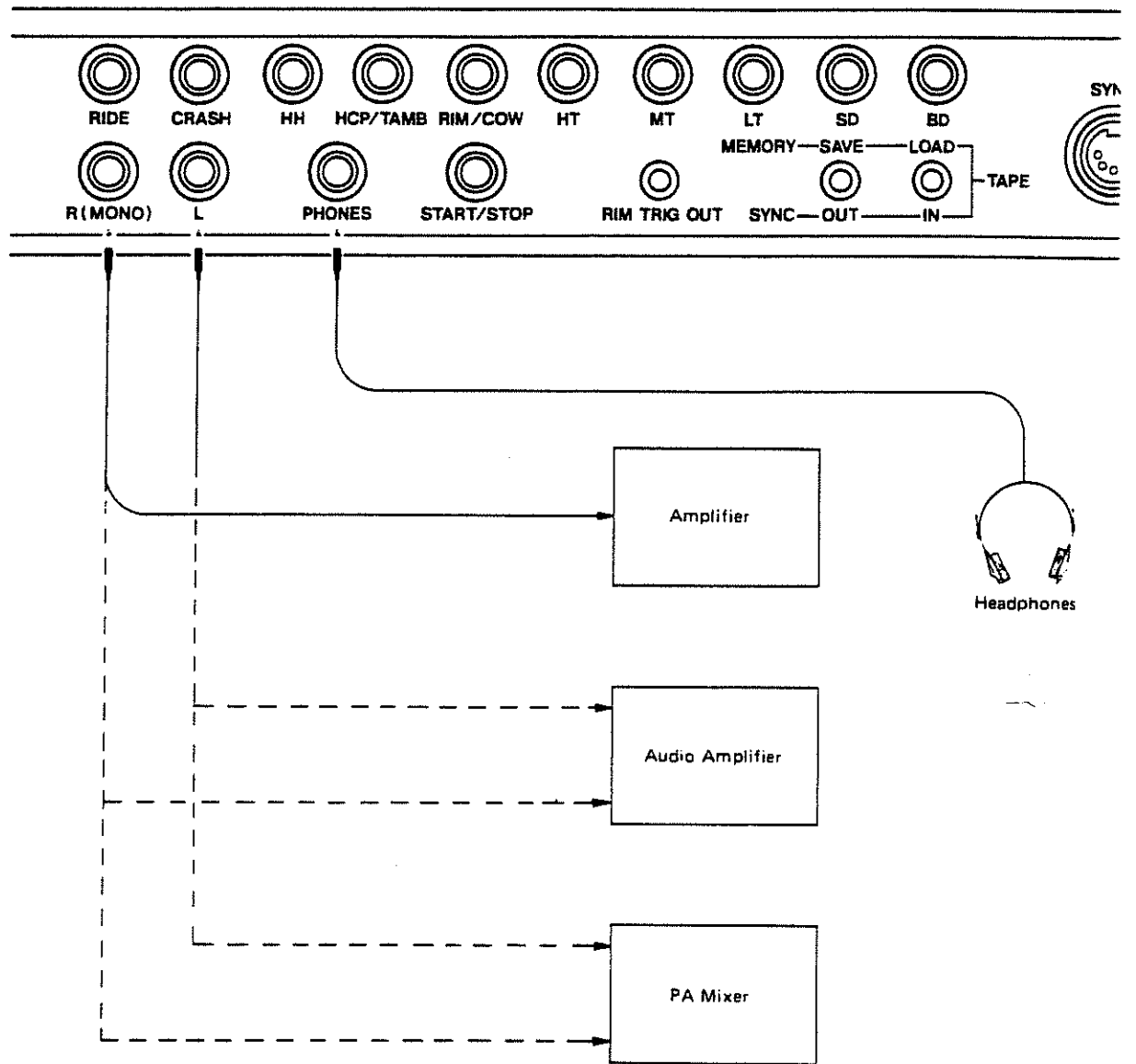

4 Operation

The TR-707 has the following 5 modes.

Pattern Playing Mode
Step Writing Mode } = Pattern Writing Modes
Tap Writing Mode
Track Playing Mode
Track Writing Mode

1. GETTING TO KNOW YOUR COMPOSER

a. Manual Play

With the composer connected to the power source, and to your amplifier or mixer, you are ready to try out a variety of sounds by playing it manually.

Switch it on. A variety of lights will come on, but we'll learn about them later. Locate the Main Keys numbered 1 to 16 which have the drum voices marked underneath. Simply tap each key: All voices have different drum sounds. Also, if you tap the key with the Accent and/or Shuffle/Flam Keys down, the created sound will take on accent and/or Flam.

• Summary of controls

Level Knob ⑳

This is to control the volume of each drum voice.

Accent Level Knob ㉑

This knob controls the intensity of the accent.

Volume Knob ㉒

This is to control overall volume of the rhythm data.

Tempo Knob ㉓

Rotating this knob quickens the tempo of the rhythm data.

• Summary of voices

1. BASS · DRUM (1)
2. BASS · DRUM (2)
3. SNARE · DRUM (1)
4. SNARE · DRUM (2)
5. LOW · TOM
6. MID · TOM
7. HI · TOM
8. RIM · SHOT
9. COW · BELL
10. HAND · CLAP
11. TAMBOURINE

12. CLOSED · HI-HAT
13. CLOSED · HI-HAT
14. OPEN · HI-HAT
15. CRASH · CYMBAL
16. RIDE · CYMBAL

The numbers 1 to 16 represent the Main Keys to be used for selecting corresponding drum voices.

The Closed Hi-hat 12 and 13 are exactly the same sounds.

It is not possible to output the following pairs of voices at the same time.

- 1 and 2 (Bass Drums 1 and 2)
- 3 and 4 (Snare Drums 1 and 2)
- 8 and 9 (Rim Shot and Cow Bell)
- 10 and 11 (Hand Clap and Tambourine)
- 12(13) and 14 (Closed Hi-hat and Open Hi-hat)

For instance, if you have entered the Cow Bell in the step where the Rim Shot has been already written, the Rim Shot will be automatically replaced with the Cow Bell.

b. Demonstration Program

A sample program is stored in your Composer on Tracks I, II and III. You can hear this simply by pushing the START Key ㉔. At the end of the Track, the Composer will stop, and start again from the beginning if you again push the START Key.

You can vary the Tempo by turning the Tempo knob ㉓.

Restoring the demo program

If you have erased the demo program but want to restore it, take the following operation.

Press the Track Mode Switch ㉕ and Track Number Button I, and while still holding them down, switch the composer on.

2. WRITING AND PLAYING RHYTHM PATTERNS

Now that we know how to produce all the sounds, we will learn to write a pattern. A pattern is a one-bar phrase. We can write into memory a large number of patterns (up to 64) to recall later in any order we like, either manually or as a completely assembled track stored in memory. In practice, we will find it easier to write patterns in the same order we later assemble them into tracks, or complete tunes. There are two ways of writing patterns a—Step-writing, in which we enter or load one step at a time without worrying about tempo. The Composer will take care of that when we've finished. b—Tap Writing, in which we use a key to tap in the rhythm in time to a Rim shot produced every quarter-beat by the Composer.

a. Step Writing

We can enter a rhythm pattern by writing drum voices step by step.

- * First of all, check that the composer is switched on and not running.

Operation

- 1 While holding the Shift Key down, press the Pattern Mode Button **13** until the Mode Display shows STEP WRITE.

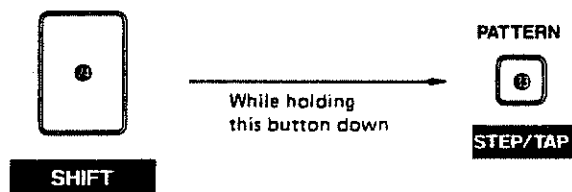

Now, the composer is in the Step writing mode.

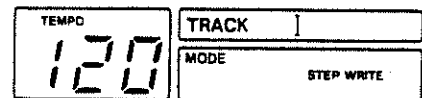

- 2 To prepare for loading in our pattern, press any of the Pattern Group Keys **14** (A, B, C or D). The pressed key will light up showing the cor-

responding pattern group (consisting of 16 patterns each selected by one Main Key) is ready to receive data. It is in Pattern Writing mode.

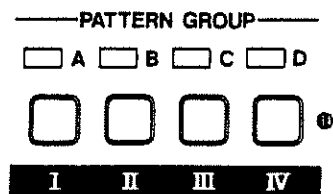

③ Press the Pattern Clear Key **16**, and still holding it down, press one Main key (1 to 16), selecting the position where you wish to store your pattern.

The indicator of the selected number will light up. Also, if any pattern has been previously stored in this position (in this pattern number), it will be erased.

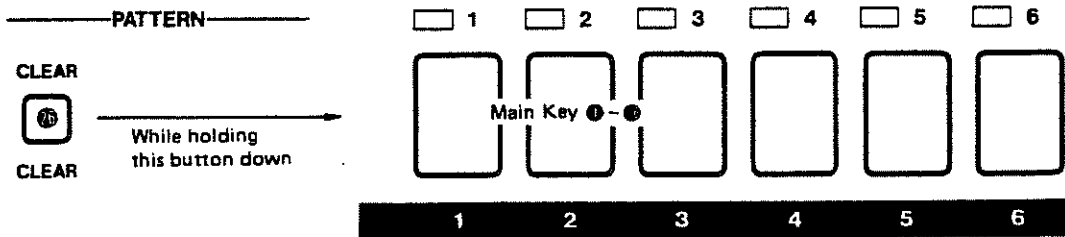

④ Press the Start Key **13**. Though the lights will flash in sequence, there will be no sound because you have clear memory. The flashing speed is equivalent to the tempo of the rhythm, so adjust the Tempo Knob **10**.



⑤ Now, select your first instrument, by holding down the Instrument Selector Button **12** then pushing the corresponding Main Key (if you want Snare Drum 1, push the Main Key 3 marked Snare Drum 1.)

In the Display **11**, the "▶" mark will flash on the left of the selected voice.

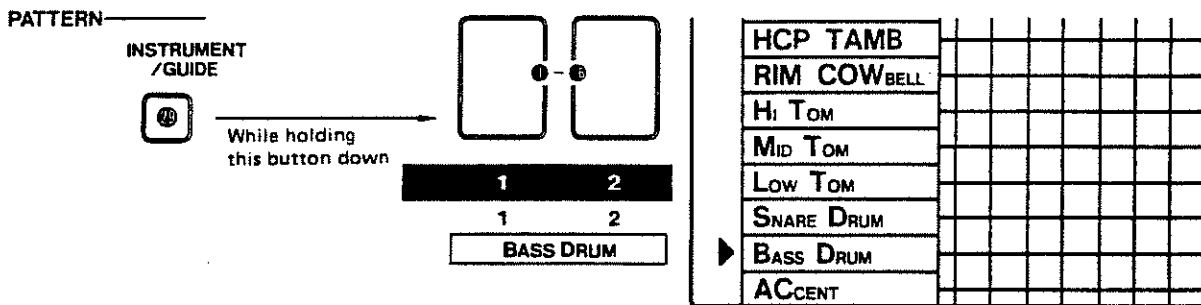

⑥ Regard the 16 Main Keys as an entire bar, and push the Main Keys that correspond to the steps where you want the drum voice selected in the procedure ⑤. Now, in the Display, the dots of the corresponding positions (steps) light or flash.

* If you wish to erase the voice you have written into a certain step, simply press the Main Key that corresponds that step.

⑦ Now, move to the other drum voices. Repeat procedures ⑤ and ⑥ for each drum voice.

⑧ Now, you can hear the complete pattern. At this stage, you can modify it any way you want, by re-selecting other instruments and changing their timing, or adding accent.

⑨ To write accents, hold down the Instrument Selector Button ④, and without releasing it, push the Accent Key ⑤ (= Enter Key).

⑩ Regard the 16 Main Keys as an entire bar, and push the Main Keys that correspond to the steps where you want accents. There are two kinds of accents, weaker, and stronger. Pressing a Main Key once will write a weaker accent to the corresponding position, and pressing it again will write the stronger accent. And pressing it once again will cancel the accent altogether, and the indicator light will go out.

Weaker accent and stronger accent can be distinguished by the Display's response. "●" flashes when weaker, and lights steadily when stronger.

⑪ When you are satisfied with the sound, it is time to leave "write" mode to store the pattern in its final form:

- i) Press the Stop/Continue Key
- ii) In future, you can always come back to the same pattern by pushing the same Pattern Group Button, the Main Key you selected in the procedure ③, then the Start Key ②.

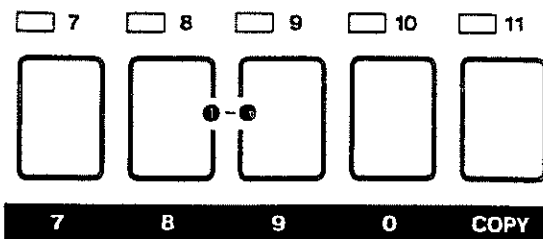

The dots (●) in the Display either flash or glow steadily depending on what drum voice is currently selected.

Glowing dots	Flashing dots
BASS · DRUM (1)	BASS · DRUM (2)
SNARE · DRUM (1)	SNARE · DRUM (2)
RIM · SHOT	COW · BELL
HAND · CLAP	TAMBOURINE
CLOSED · HI-HAT	OPEN · HI-HAT
RIDE · CYMBAL	CRASH · CYMBAL
HI · TOM	
MID · TOM	
LOW · TOM	

Example Step Write

Let's write an example pattern of 4/4 time rock rhythm in Step Writing.

< Fig 1 >

Fig 1 shows musical notation for a 4/4 time rock rhythm. It includes four staves: ACCENT (with accents >), CLOSED HIHAT (a series of eighth notes), SDI (Snare Drum with a pattern of eighth notes and rests), and BDI (Bass Drum with a pattern of eighth notes and rests).

< Fig 2 >

Fig 2 is a step writing grid with 16 steps. The top section shows CYMBAL, HHAT, and HCP TAMB patterns. The bottom section shows SNARE DRUM, BASS DRUM, and ACCENT patterns. The grid is labeled 'Display Response'.

First, follow the Step Writing procedures 1 to 4 on page 9 and 10.

If the last step has been set to any number other than 16, set it to 16 by pressing the Main Key 16 while holding the Last Step Button.

1 Entering Closed Hi-hat

While holding the Instrument Selector Button down, press the Main Key 12 or 16 (both are Closed Hi-hat).

Tap the Main Keys 1 to 16 according to the score shown below.

Now, the Closed Hi-hat is selected and ready to be written at the position where the Main Key is pressed.

The diagram shows the musical notation for CLOSED HIHAT (a series of eighth notes) and a row of 16 Main Key indicators (numbered 1 to 16) below it. A bracket under the indicators points to the instruction below.

Hit all the Main Keys, and make sure all the indicators glow.

2 Entering Snare Drum 1

While holding the Instrument Selector Button , press the Main Key 3 .

Tap the Main Keys according to the score. (Refer to the figure below.)

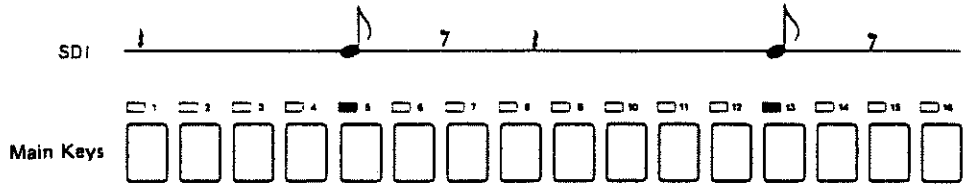
SDI 

Main Keys 

Press the Main Keys 5 and 13, and make sure the corresponding indicators glow.

3 Entering Bass Drum 1

While holding the Instrument Selector Button , press the Main Key 1 .

Tap the Main Keys according to the score as shown below.

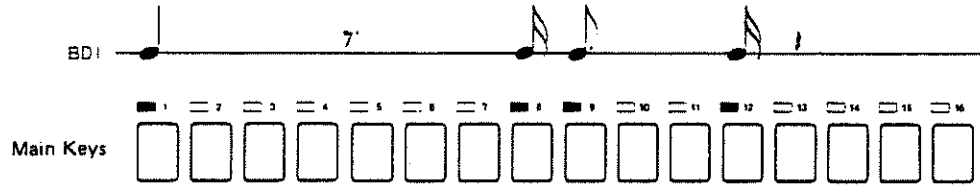
BDI 

Main Keys 

Press the Main Keys 1, 8, 9 and 12, then make sure the corresponding indicators glow.

4 Entering Accents

While holding the Instrument Selector Button , press the Accent Key (Enter Key).

Tap the Main Keys according to the score as shown below.

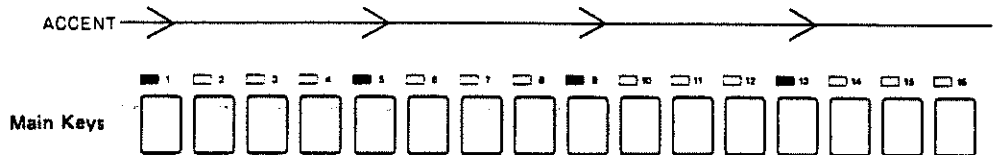
ACCENT 

Main Keys 

Press the Main Keys 1, 5, 9 and 13, then make sure the corresponding indicators glow.

Now, a Rhythm Pattern like Fig 1 is entered, and the Display Window responds as shown in Fig 2.

b. Tap Writing

Operation

First, check if the composer is switched on and not running.

- ① While holding down the Shift Key **34**, push the Pattern Mode Button **33** as many times as needed until the Display shows TAP WRITE.

Now, the composer is in the Tap Writing mode.

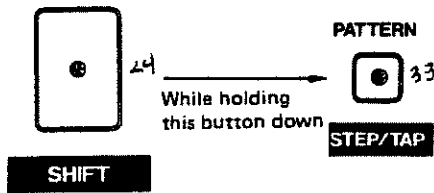

- ② Decide which Pattern Group you want to write into. Then push the Pattern Group Button (which will then flash).

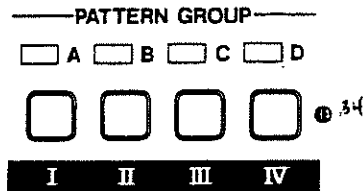

- ③ While holding the Pattern Clear Button **35**, select the Main Key (1 to 16) where you want to write the Pattern.

The indicator of the pressed Main Key flashes. Also the above operation erases any pattern previously written there.

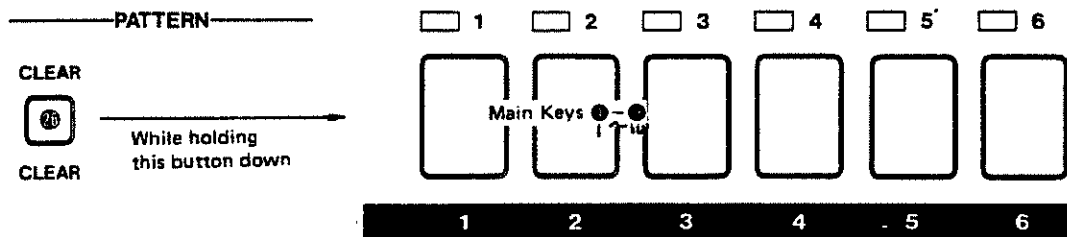

- ④ Press the Start Button ⑮. Now, you will hear guide crotchet rim shot. This will not be recorded.

Here, if you push the Instrument Selector Button ⑭, this rim shot will stop. And if pressed again, start.



START

- ⑤ Tap in the rhythm on the Main Keys, just as you did when playing the keys manually. Remember, you are writing one bar which is repeating.

- * The shortest timing value that can be written into the TR-707 is 16th note ($\frac{1}{16}$). Therefore, if you slow the tempo to make writing easier, you could be surprised at the result when you change back to normal tempo.
- * If you make an error, while the rhythm is still running, hold down the Clear Button ⑯, then push the Main Key belonging to that voice until that voice has disappeared. Then write that voice again. Even if you make many mistakes at this stage, you will soon find it comes easier.

Note

By the above operation, erasing the Hand Clap will erase the Tambourine and vice-versa. This also holds true for the Rimshot/Cowbell.

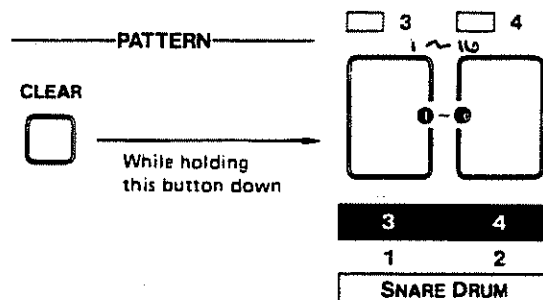

- ⑥ When you have finished writing, push the Stop/Continue Key.

STOP/CONT



- ⑦ If you wish to write accents, tap in the rhythm on the Accent Key ⑰ (=Enter Key), just as you did in the above procedure ⑤.

Now, the weaker accents have been written. To write stronger accents, try tapping in the exactly same timing as you have tapped. Tapping once again in the same timing will change the accents to weaker, and so on.

Weaker accent or stronger accent can be distinguished by the Display's response. The "●" mark flashes when weaker, and glows steadily when stronger.



To change from Step Writing mode to Tap Writing or from the Tap Writing to the Step Writing mode, simply hold the Shift Key ⑱ down, and without releasing it, push the Pattern Mode Button ⑲. This mode changing operation can be done even while rhythm is running. So, if you have made an error in Tap Writing mode, you can immediately turn the composer to the Step Write mode and correct the error without affecting any other part of the pattern data. To the contrary, you can add a more complicated rhythm in the Tap Write mode to the pattern entered in the Step Write mode.

c. Pattern Playing

When you intend to write a complete Track from a group of Patterns, you may want to listen carefully to your patterns either separately or in sequence. It is a good idea to write your Patterns roughly in the order you will use them, though you will often go back to re-use previous Patterns.

1) Playing a single Pattern

Operation

- ① Push the Pattern Mode Button  to turn the composer to the Pattern Playing mode.
- ② Push the Pattern Group Button  which is the same one you have been using. Then push the required Main Key to select your pattern.

The Display now shows the rhythm chart of the selected Pattern.

- ③ Press the Start Key .

To change Patterns, there is no need to stop playing. Simply push another Main Key and the new pattern will take over at the end of the bar.

- ④ Press the Stop/Continue Key  to stop the rhythm. By pressing the Stop/Continue Key once again, the pattern will start playing from where it was stopped.

2) Block Playing

Any block of Patterns may be played in sequence. To play Patterns 1 to 5 in sequence, push Main Keys 1 and 5 together (the indicators of the Main Keys 1 to 5 will light up, showing that they are ready to be block-played), then push the Start Key .

All the other necessary procedures are the same as the Pattern Playing.

e.g. To play Pattern No. 1 to 5 continuously.

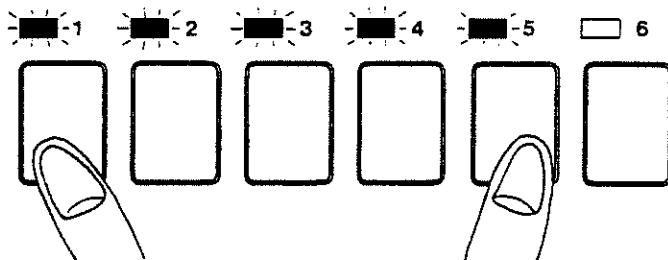

Pattern Playing

3. ABOUT LAST STEP AND SCALE

The default setting is 4/4 time, shown by the red light at the left side of the chart. In this, the lowest of the four chart lines, the 16 Main Keys are shown

divided into 1 bar of 4 crotchets, therefore the value represented by each Main Key is a semi-quaver, or 1/16 note.

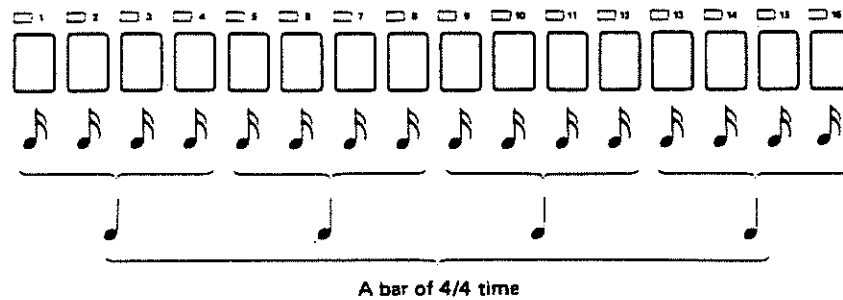

To enter the Pattern other than above, such as 3/4, a bar consists of 12 steps, so it is necessary to change the total step number from 16 to 12. (See a. Setting Last Step on page 18.)

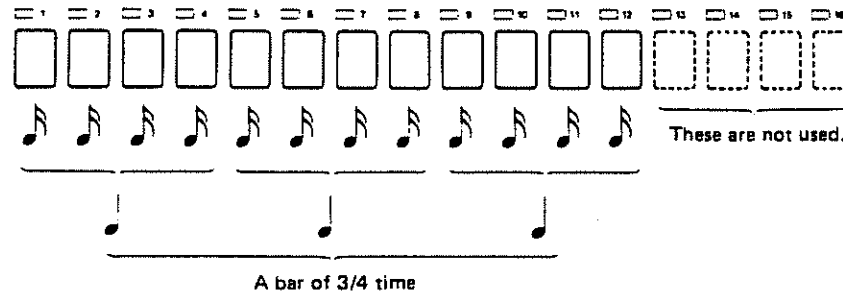

The chart line second from the bottom is divided into half a bar of two crotchets, in which the 16 Main Keys represent a demisemiquaver, or 1/32 note. Although patterns may be only half-a-bar long, two patterns may be chained to play consecutively. (See c. Chaining patterns together on page 29.)

The third line up on the chart is similar to the first, except for three beats (or 6) in the bar instead of common time. The fourth line is similar to the second line, but again caters for 3 or 6 beats in the bar. The Scale may be set to any of the lines. (See b. Setting Scale.)

The Pattern of 4/4 with triplets also consists of 12 steps. If, however, entering the Pattern with the Scale set to 4/4, the total playing time will be three quarter of the common time. So, it is necessary to change the time of each step. (See b. Setting Scale.)

The Last Step is set so that $\frac{1}{16}$ and $\frac{1}{8}$ = 16, $\frac{1}{4}$ (simple) and $\frac{1}{8}$ (compound) = 12.

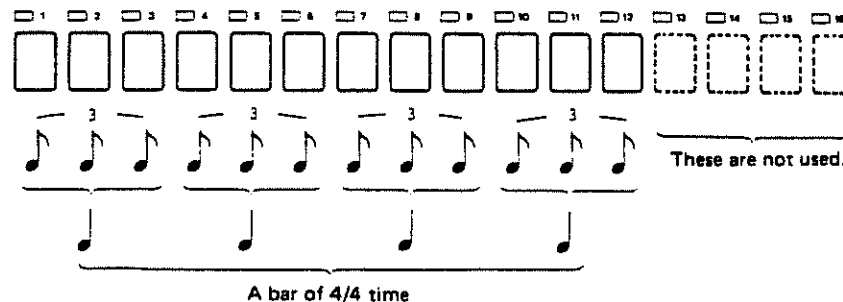

The total time required is three quarter compared to 4/4 time.

a. Setting Last Step

Operation

- ① Enter Pattern Writing mode, in either the Step Writing or Tap Writing mode.
- ② While holding the Last Step Button , push the relevant Main Keys to set the bar length.
By using the above function of changing the number of steps or beats in a bar, odd times such as 5/4 (combination of 3/4 and 2/4) or 7/4 (combination of 4/4 and 3/4) can be easily entered.

b. Setting Scale

Operation

- ① Enter Pattern Writing mode, in either Step Writing or Tap Writing mode.
- ② Push the Scale Button . The Scale light will move up one step, to line 2.
- ③ Each time the Scale Button is pushed, the red light moves up. From the top line it moves back to the bottom line.
- ④ The tempo of the red light may also change, since all the rhythms are in step with each other.

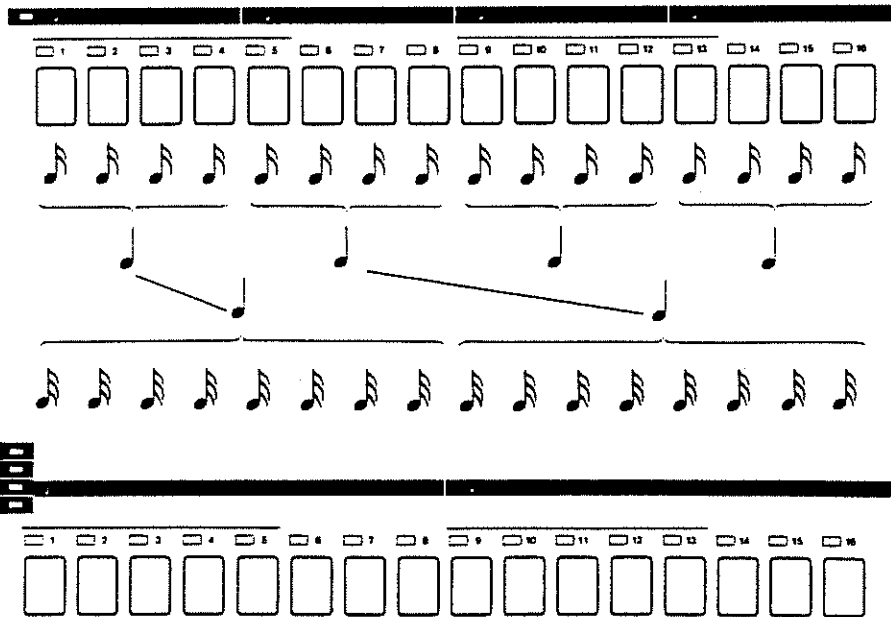

The diagram illustrates two musical staves, each with 16 steps. The top staff shows a sequence of notes grouped into four measures of 4 steps each. The bottom staff shows a similar sequence of notes, also grouped into four measures of 4 steps each. Brackets connect the notes between the two staves, demonstrating that they are in step with each other.

In this scale, repeating a pattern twice or chaining two patterns makes a common length.

1 2 3 4 5 6 7 8 9 10 11 12 13 14 15 16

These are not used.

1 2 3 4 5 6 7 8 9 10 11 12 13 14 15 16

Last step

1 2 3 4 5 6 7 8 9 10 11 12 13 14 15 16

These are not used.

1 2 3 4 5 6 7 8 9 10 11 12 13 14 15 16

Last step

In this scale, repeating a pattern twice or chaining two patterns makes a common length.

4 FLAM & SHUFFLE

a. Flam

Flam is a kick-note written ahead of the main beat, and takes on the effect of a grace note. It differs from Shuffle in that it occurs once only. Flam can be written on the Snare Drum or any of the Toms. The time gap between the Flam or grace note and its following main note can be varied with 4 options, using the Main Keys. To set up the Flam:

1) In Step Writing Mode

- ① Change to Step Write mode and have the rhythm running.
- ② Hold down the Instrument Selector Button  and press TWICE the Main Key belonging to the voice you are writing Flam to.

The Display shows steady glow of "▶" mark.

- ③ Write your instrument voice as usual.

2) In Tap Writing Mode

- ① Change to the Tap writing mode, then have the rhythm running.
- ② Hold down the Shuffle/Flam Button , and without releasing it, tap in the rhythm on the relevant Main Keys belonging to the voice you are writing Flam to.



Flam cannot be entered to the Snare Drum 1 and 2 at the same time. It is only written to the Snare Drum 2. To obtain Flam on the Snare Drum 1, hold the Shift Key down, and push the Instrument Selector Button . Each time the button is pressed, Snare Drum 1 and 2 are alternately selected.

- * The dots in the Display do not flash but glow steadily, even when the Snare Drum 2 is selected.

3) Setting the Flam interval

The interval of Flam can be written after having entered Flam in either Step Writing or Tap Writing mode. But the Flam interval writing operation should be done in the Step Writing mode, so if the composer is in the Tap Writing mode, change to the Step Writing mode.

There are 4 different intervals optional by the Main Keys 10 to 13. The shortest interval is Key 10, and the longest is 13. The Key 9 is Off.

- ① Hold down the Shuffle/Flam Button  and press any of the Main Keys 9 to 13 to set the Flam interval.
- ② If you want to know the Flam interval currently set, press the Shuffle/Flam Button  and see which Main Key lights up.

* The position of the Tempo Knob does not affect the Flam interval.

b. Shuffle

A shuffle beat is one in which a bounce-note is added immediately in front of each crotchet beat. This is done for at least one chorus and frequently for a whole tune. A shuffle beat may be added to any rhythm pattern in common time (when either of the lower 2 lines of the Scale is selected). The added bounce is changed in volume with 4 options using the Main Keys 1 to 5. To set the Shuffle beat:

- ① Change to the Step Writing mode and have the rhythm running.
- ② Hold down the Shuffle/Flam Button  while pushing the relevant Main Keys which will be zero with key 1 and maximum with key 5.
- ③ If you want to know the bounce currently set, push the Shuffle/Flam Button. A Main Key will light up to indicate the degree of bounce.

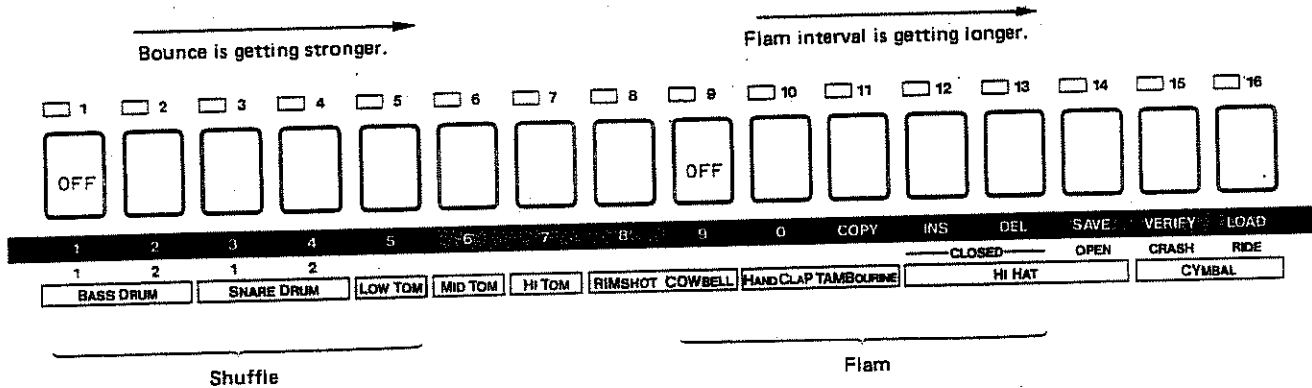

Fig 4-1

5 TRACK WRITING AND PLAYING

a. Track Writing

A track is a complete sequence of rhythm Patterns or Bars arranged in any order to form a complete piece. There are 4 Tracks retaining 998 bars in all. Entering rhythm Patterns of an entire Track will replace the patterns previously written, so you may save it. (See 31 and 36.)

1) Writing single Patterns to a Track

① Press the Shift Key **⏏**, and still holding it down, push the Track Mode Button **⏏** to turn the composer to the Track Writing mode.

You will notice that the Display shows TRACK WRITE.

② Still holding the Shift Key down, press any Track Selector Button (I to IV) which will be shown in number in the Display.

③ If there is any data written in that Track, clear it by holding the Track Clear Button and the Track Selector Button you have selected in the step ② above.

Remember that the above operation WILL ERASE YOUR EXISTING TRACK. If you wish to preserve it, save it as described in Saving on page 31 and 36.

④ Push the Start Key **⏏** to start rhythm. You will now hear whichever pattern happens to be selected.

⑤ Change to the Pattern you want for Bar 1 by using a Pattern Group Button **⏏** (A, B, C or D) and a Main Key (1 to 16).

The indicators of the pressed button and key are now lighted. Also, the Display shows the rhythm pattern.

⑥ Press the Enter Key **⏏**, which writes your Pattern into Bar 1 of the Track and moves on to Bar 2.

⑦ Repeat the procedure ⑤ and ⑥ for Bar 2, and so on. Naturally, there will be many bars where the sample pattern is repeated.

⑧ If you enter the wrong pattern in any bar, you can go back and do it again. Push the Back Button **⏏** once or more to step back to the bar.

⑨ When you have completed the Track, push the Stop Key **⏏**, which will close off the Track.

When the composer is in the Track Writing mode, writing or editing (see Editing on page 24) can be done even while rhythm is not running. (= skipping the procedure ④), during which the indicators can considerably help you.

2) Writing Chained Patterns to a Track

Two or more Patterns may be chained so that they play as one. This takes care of Rhythms which need more than 16 steps per bar, such as 32nd notes within 4/4 time, or semi-quavers within odd times such as 5/4 or 7/8. You may need to change the Scale before writing the Rhythm patterns if you intend to Chain them, so that they all play with the same time value.

To write Chained patterns into a Track:



Instead of taking the procedure ⑤ in 1) Writing single Patterns to a Track, simultaneously press the Main Keys belonging to the first and last numbers of the Chained Patterns. (e.g. key 1 and key 3.)

NOTE



- * Do not turn off the Composer while in the Track Write mode, or the Track data may be lost.

b. Track Playing

To hear the Track you have written:

- ① Press the Track Mode Button until the Display shows TRACK PLAY.
- ② While holding the Shift Key  down, press the Track Selector Button (I to IV) which you wish play. This causes the Display to show the selected Track number.
- ③ Push the Start Key .

The selected Track will start to play from the first bar.

- ④ To stop playing, push the Stop Key  — as we found earlier, you can continue on from this point with the Cont Key , or else start again from Bar 1 with the Start Key .

- * If you do not touch any key at all during Track playing, it will play till the end, then stop.
- * You can select any other Track of course, but you must first stop the rhythm.
- * You can add to the track while it is playing by manually tapping the Main Keys. This will not be written into memory.

Playing the rhythm from the bar you like:

Operation

- ① Assign the beginning bar of the rhythm pattern, as shown on page 24.
- ② Push the Stop/Continue Key .

The rhythm pattern will play from the bar you assigned.

NOTE 1



If the Display does not show the bar number, check if it is set to Measure Display mode. If it still does not show the bar number, most probably, there is no rhythm pattern written in the relevant Track, therefore pushing the Start Key has no effect.

NOTE 2

In Track Write or Track Play mode, you can select either tempo or bar number display. Simply push the Tempo Measure Display Button , and the mode will change alternately.

TEMPO
/MEAS

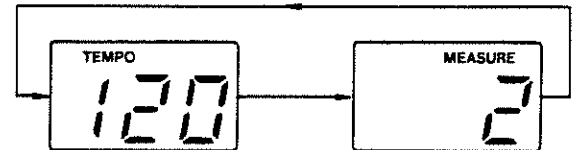

6 EDITING

You may find on listening to your Track that you have made an error. The TR-707 allows you to replace the wrong pattern in a certain bar with a correct one, add or delete patterns, groups of patterns or complete choruses, etc. This editing function, however, requires you to assign the bar number correctly. Otherwise the whole editing would go wrong.

To assign the bar you want:

Set the Composer to either Track Play mode or Track Write mode.

Set the Tempo/Measure Display section to Measure display mode by pushing the Tempo/Measure Display Button **11**.

- Push the Forward Button **12** which advances one bar at a time, until you come to the right bar.
- Push the Back Button **13** which backs up one bar at a time, until you come to the right bar.
- Assign the bar number by holding the Shift Key **14** down while punching the bar number on the Main Keys 1 to 10 (press 1 and 6 for bar number 16), and push the Enter Key.
- Push the Back Key down, while holding the Forward Key down, and the bars will be advanced quickly. On the contrary, push the Forward Key down while holding the Back Key to back up the bars quickly.

a. Track Editing

First, check if the composer is in the Track Writing mode, and not running the rhythm.

- 1 Call the bar you wish to change, by any means you like as shown in "To assign the bar you want" in the section just before this.

The Display will show the number of the assigned bar.

- 2 Press the Start Key **15** to start rhythm pattern.

* Skip this procedure if you are editing without rhythm running.

- 3 Select the correct pattern.

- 4 Push the Enter Key **16**, which writes the correct pattern moving onto the next bar.

- 5 Press the Stop Key **17**.

b. Delete

You can delete any Pattern or series of patterns from a Track. To delete a sequence of patterns, you assign the first and last bars of the sequence before removing them from the Track.

- ① Enter Track Writing mode, and select the Track by using a Track Selector Button **Ⓜ**.
- ② While holding the Shift Key down, use the Main Keys to select the first bar number you want to delete (it will appear in the Display). Then push the Enter Key **Ⓜ**.
- ③ Still holding the Shift Key down, push the Delete Key (= Main Key 13) then the number of the last bar you want to delete, then push the Enter Key.
- ④ To delete a single bar, while holding the Shift Key down, select bar number, push the Enter, then the Delete, then the Enter.
- ⑤ To delete the end of a Track, instead of assigning the last bar number, push the Last Measure Button **Ⓜ** (with the Shift Key down, push the Delete, Last Measure, Enter).
(See Example on page 26)

c. Insert

You can insert any single Pattern or Chain into a Track.

- ① Enter Track Writing mode. Select the Track by using a Track Selector Button.
- ② Assign the bar number by holding the Shift Key **Ⓜ**, selecting the bar number after which you wish to insert, push the Enter Key.
- ③ Select the Pattern you wish to insert by using a Pattern Group Button **Ⓜ** and Main Key.
- ④ While holding the Shift Key down, push the Insert Key (Main Key 12), then the Enter Key **Ⓜ**.

To insert a chain of Patterns, see page 22.

If the maximum memory capacity (998 Bars) is full up, no more Patterns can be written.

- 5 To add a Pattern to the end of Track, assign the last bar during the procedure ② by pushing the Last Measure Button. This advances one bar from the last measure, where a Pattern can be written in usual Track Writing procedure.
(See Example on page 27)

Example Delete

- To delete 21st to 24th bar.

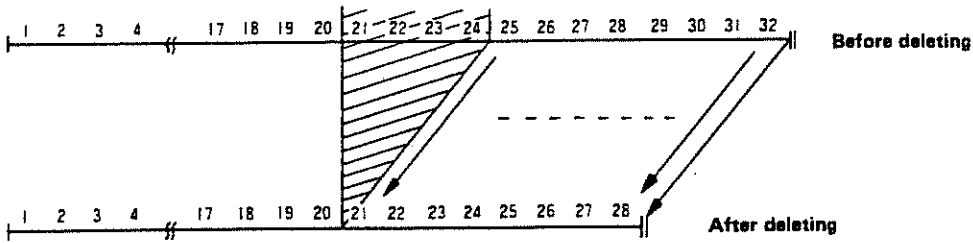

- 1 Recall the 21st measure (Bar Assign)

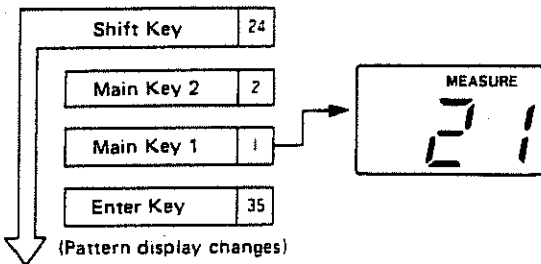

- 2 Take Delete procedure and delete up to 24th bar.

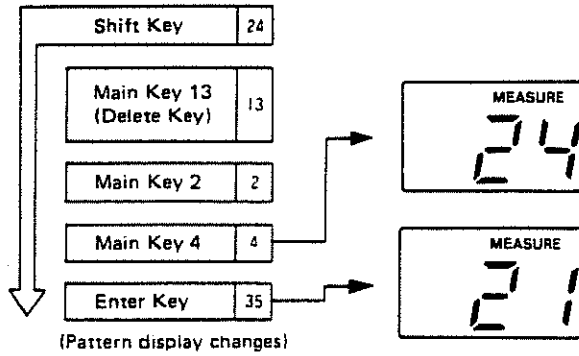

- To delete 25th to the last bar.

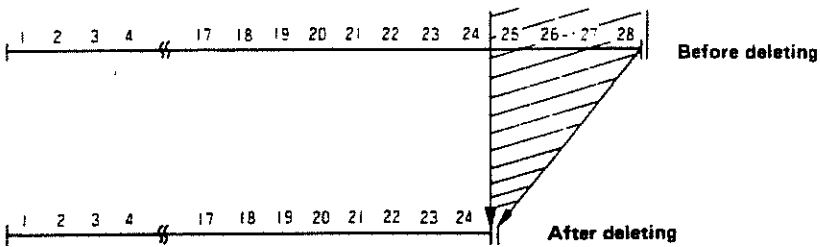

- 1 Recall the 25th bar.

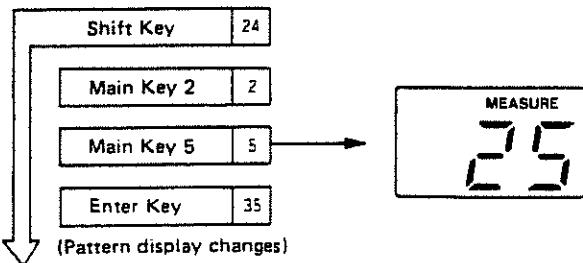

- 2 Delete up to the last bar.

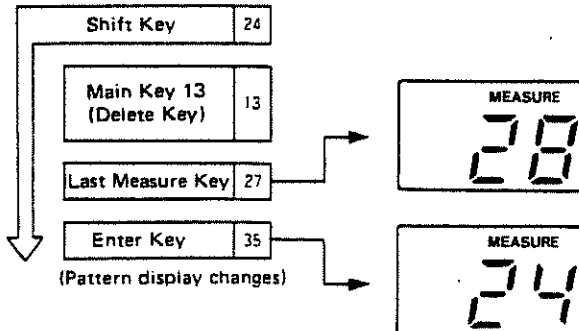

- To delete only 19th bar.

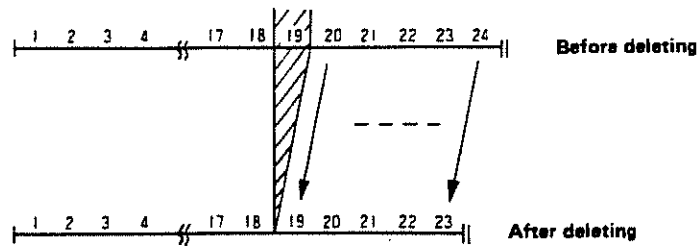

- ① Recall the 19th bar.

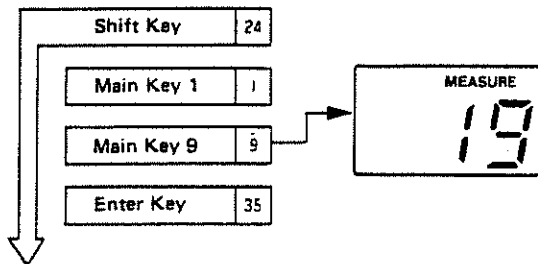

- ② Take Delete procedure.

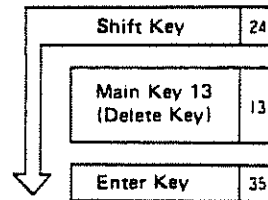

Example Insert

- To insert a Rhythm Pattern into the 3rd bar.

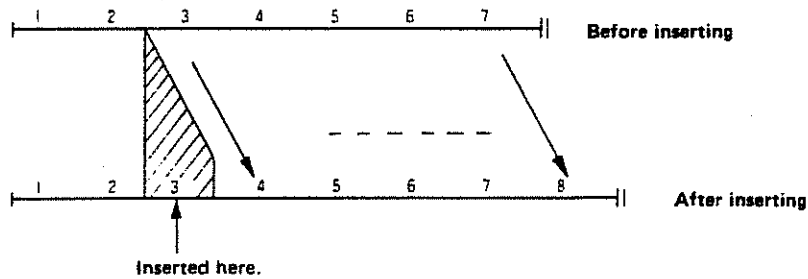

- ① Recall the 3rd bar.

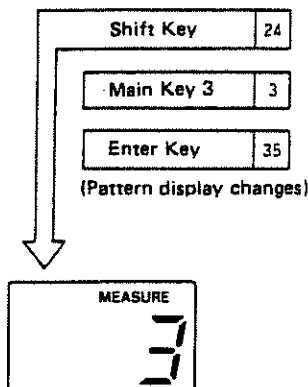

- ② Select the Rhythm Pattern (Pattern Group, Pattern Number).

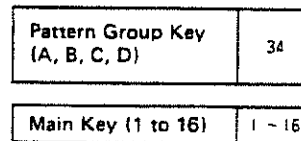

- ③ Take insert procedure

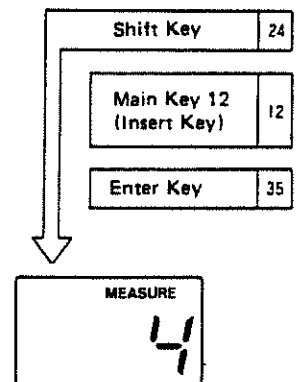

7 OTHER USEFUL FUNCTIONS FOR EDITING

a. Copying a single Pattern

A Rhythm Pattern can be copied from one memory location to another. After copying, the Pattern will remain in its original location as well as appearing in the new location you have chosen.

Operation for copying

- ① Enter the Pattern Writing mode.
- ② Assign the new location (Pattern Number) which your Pattern is copied to, by using Pattern Group Button (A, B, C, D) and Pattern Number Button (Main Key 1 to 16).
- ③ While holding the Shift Key $\text{\textcircled{S}}$ down, push the Copy Key (Main Key 11), the Pattern Group Button and Pattern Number Button assigning your source Pattern, then the Enter Key.

It is not possible to copy the Chained Patterns altogether at a time. You need to break the Chain once, then copy the pattern one by one. Then finally chain the patterns again. (See p 29)

b. Copy (in Track Writing Mode)

You can copy any Bar or sequence of Bars into a Track. The arrival of the new Patterns will extend the length of the Track accordingly. The difference between COPY and INSERT is that Insert deals with patterns while Copy adds extra bars from an existing Track, either within the same Track or a different Track. To follow the Copying procedure:

- ① Enter the Track Writing mode. Select the Track you want by pushing a Track Selector Button.
- ② Assign the bar number after which you wish the new pattern to begin, by holding the Shift Key, entering the bar number and pushing the Enter Key.
- ③ While holding the Shift Key, push the Copy (Main Key 11), appropriate Main Keys (1 to 10) assigning the starting bar number, then the Enter Key, and the ending bar number, then the Enter Key. Be sure that all are done while the Shift Key is being held down.
(See the Example on page 30)

NOTE

- * Please make sure that the composer is not running during the above Copying operation.
- * Some copies are impossible. For example, you cannot copy Bars 20 to 25 into Bar 22 of the same Track. If the Copy is impossible, or memory is full (exceeding 998 bars) the Display will respond with:

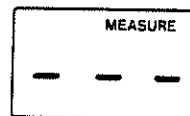

c. Chaining patterns together

The Chaining function allows two or more Patterns to be chained so that they play as one. This is useful for any Bar consisting of more than 16 steps (e.g. $\frac{7}{8}$ = 1 step or odd times such as $\frac{5}{4}$ or $\frac{7}{8}$).

- ① Enter the Pattern Writing mode, and select a pattern group by using the Pattern Group Buttons (A, B, C, D).
- ② Select the Main Keys belonging to the first and last number of the Patterns you wish to chain, and hold these down, and without releasing them, push the Enter Key.

To drop a Pattern from the Chain, hold the relevant Main Key down, and push the Enter Key.

NOTE

This Chain function, naturally is available just for the adjacent Patterns.

- Even the whole Pattern group (Key 1 to 16) can be chained if desired.
- You may need to change the Scale before writing the Rhythm Patterns so that they all play with the same time value.
- To play a Chain, select any of the Patterns which belong to the Chain and the whole chain will play.
- To break a Chain hold down each pattern key in turn and push the Enter Key.

Example of using Chain Function

The diagram shows a musical score for four tracks: ACCENT, OPEN/CLOSED HI HAT, SD 1, and BD 1. The score is divided into two sections, Pattern 'a' and Pattern 'b'. Pattern 'a' is associated with a 'Scale: Bottom Line' and has a 'Main Key (one) = ♩' and 'Last Step : B'. Pattern 'b' is associated with a 'Scale: Top Line' and has a 'Main Key (one) = ♩⁶' and 'Last Step : 12'. Below the score are two grid diagrams. The first grid, labeled 'Use up to 8 steps', shows a 16-step grid with activity in steps 1-8. The second grid, labeled 'Use up to 12 steps', shows a 16-step grid with activity in steps 1-12. A legend indicates that a solid dot (●) means 'glowing steadily' and a solid circle (○) means 'flashing'.

To enter the rhythm pattern shown above, you need to divide it into two patterns; 'a' and 'b', then enter them with two different Scale settings. If, however, these two patterns are written in different pattern numbers, they will be written as two bars later in Track writing. To solve this problem, enter the patterns 'a' and 'b' in the two adjacent pattern numbers, then chain them together. Now, these patterns will be written into a Track together and counted as one bar.

Example Copy

• To copy 13th to 16th measures into the 19th measure.

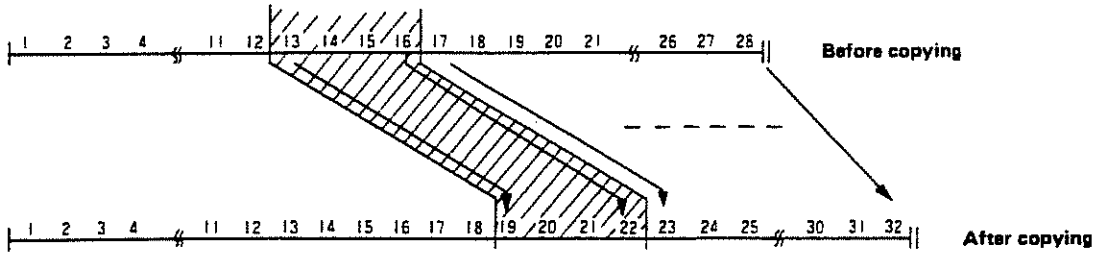

① Recall the 19th bar.

② Take copy procedure and copy 13th to 16th bar.

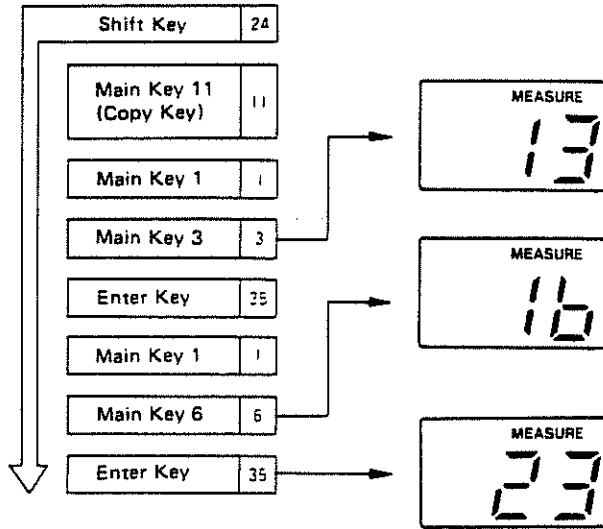
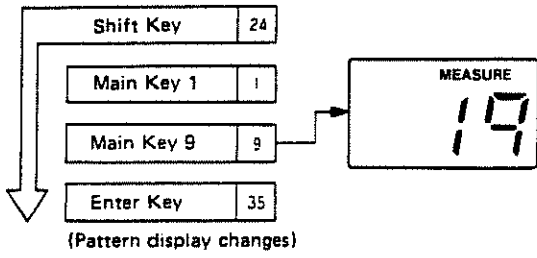

8 TAPE INTERFACE

Even if the optional Memory Cartridge is not available, the TR-707's Tape Interface allows the Tracks written into memory to be stored on tape (=Save).

This saving, however, requires much more complicated procedure than that by memory cartridge.

a. Saving

First of all, connect the tape recorder and the composer as shown below.

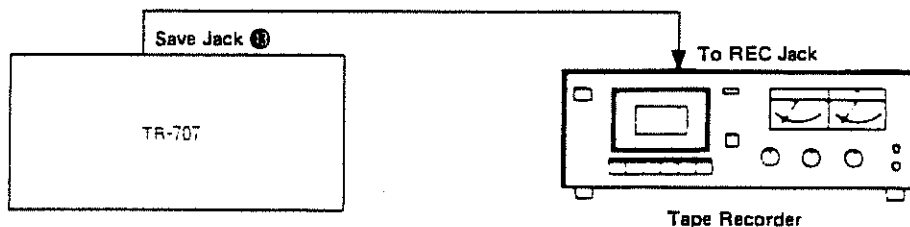

① Set your tape recorder ready to record using the Pause key if you have one.

② Start the tape recorder.

③ While holding the Shift Key down, press the Save (Main Key 14), then the Enter.

The Display will respond with  showing that it is now in saving mode.

* If your tape recorder features a recording level meter, set it on +3VU, and if featuring a signal indicator, make sure that signal is being received.

For about 7 seconds after the Enter Key is pressed, the Pilot tone is heard then it is followed by the modulated tone which carries the data. In the Display Window, the dots on the line of Hi-Tom light from the 1st step to right showing the progress of the saving during which all indicators go out. When the lighting reaches up to 14th step, the Display and indicators go back to the normal condition.

STEP	1	2	3	4	5	6	7	8	9	10	11	12	13	14	15	16
CYMBAL																
HiHAT																
HCP TAMB																
RIM COWBELL																
Hi TOM	●	●	●	●	●	●	○	○	○	○	○	○	○	○	○	○
Mid TOM																
Low TOM																

④ Stop the tape recorder.

* At any time during saving, pushing the Main Key 1 can stop the saving operation.

To ensure the data has been properly saved, go to the next verifying operation.

b. Verification

Connect your recorder as shown below.

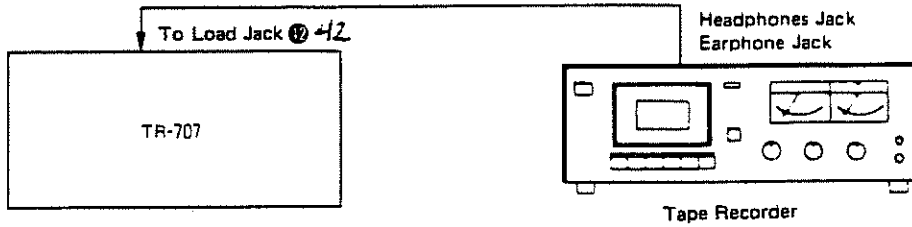

① Wind back the tape to the start of your pilot tone.

② While holding the Shift Key down, push the Verify Key (Main Key 15) then the Enter Key.

On pressing the Verify Key, the Display shows . Then on pressing the Enter Key, all the indicators go out.

STEP	1	2	3	4	5	6	7	8	9	10	11	12	13	14	15	16
CYMBAL																
HHAT																
HCP TAMB																
RIM COWBELL																
H TOM	●	●	●	●	●	●	○	○	○	○	○	○	○	○	○	○
MID TOM																
LOW TOM																

- ③ Start your recorder on play.

When the data is found, the Display will show:



Watch the Display, if the dots on the line of Hi-Tom light from 1st step to 14, then the data has been properly saved.

- ④ Stop the tape recorder.

- * At any time during verifying, pushing the Main Key 1 can stop verifying operation.

Error Indication

If **Err** is shown in the Display, stop the tape recorder, then press the Main Key 1. Then repeat the Verifying operation with a different volume setting.

If the error indication is still showing no matter how many times you try, repeat saving procedure. If it is still not remedied, try saving with a different tape recorder.

c. Loading

The loading procedure is used to take a Track stored on tape and load it into the Composer. Loading procedure is exactly the same as the Verifying except that you use the Load Key instead of Verify. Likewise, the tape recorder connections are the same. Of course, you must push the Play Button on the Pilot tone to avoid missing out data.

- * At any time during loading, pushing the Main Key 1 can stop the loading operation.

If the data is properly saved on tape, loading will be done without any problem, unless the tape is damaged during preservation. If you want to load a numbered file, then see the following "d. Setting a File Number".

d. Setting a File Number

A file number (1 to 99) can be allotted to data when you are saving it. This means that later when you are loading, you can specify the file number and the Composer will choose that file from the others and load it: provided you remember what the file number is. If load files, whether numbered or not, without specifying the file number, then the Composer will load the first file it comes to.

To allocate a file number

After pushing the Save Key during step ⑧ in Saving procedure on page 31, choose a file number (1 to 99) from the Main Keys (1 to 10), then push the Enter Key.

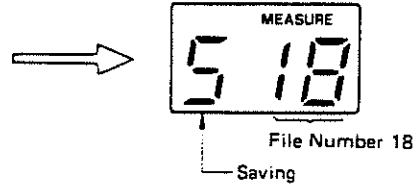

The assigned file number is shown in the Display.

To load a numbered file

After pushing the Load Key (Main Key 16) in the Loading procedure, assign the file number by pressing the relevant Main Key (1 to 10), and the Enter Key. If you do not assign any file number, the data first found will be automatically loaded.

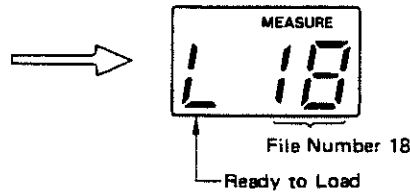

NOTE

- * Until the assigned data is found, the Display will show P (Pass).

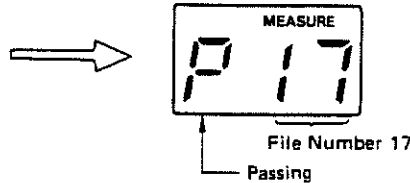

- * When the assigned file number is found, the Display shows F (Found), and loading starts.

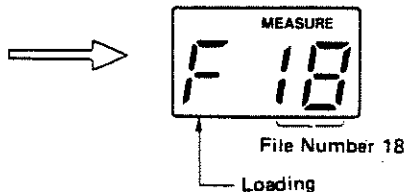

9 MEMORY CARTRIDGE

The Memory Cartridge M-64 is an optional extra which will save and load data instantly instead of using a tape recorder. It acts as additional memory to enable three times more capacity of Tracks to be held by the Composer at any one time. When many tracks are needed during a live performance, new tracks can be loaded into the Composer during a break or intermission, after the old ones have been performed. Memory Cartridge also permits the safe storage of data which might otherwise be lost through being accidentally written over.

You may consider the internal memory of the composer as Bank 1, the Memory Cartridge as Bank 2 and 3. The data in the Cartridge can be used in exactly the same way as using the data in the Composer's internal memory. Just note that to save the data in the cartridge onto a tape, it should be loaded from the cartridge into the composer then saved onto a tape, and vice-versa.

To operate the Memory Cartridge:

Load the cartridge by inserting it into its slot located at the upper left of the composer's front panel. Before connecting the Memory Cartridge to the Composer, be sure that it is entered to the Track Playing mode, the rhythm is not running and the Protect Switch on the Cartridge is set to the ON position. The ON/OFF operation of the Protect Switch should always be done while in the Track Play mode.

a. Selecting a Bank

Enter the Track Playing mode with the rhythm not running. Then, press the Cartridge Key (Enter Key) while holding the Shift Key down, and the bank moves as shown below.

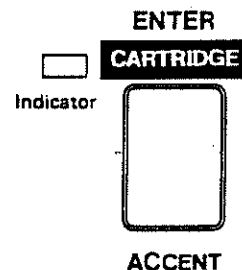

Bank Number	Indicator	Bank
1	dark	Composer's memory (Bank 1)
2	red	Memory Cartridge (Bank 2)
3	green	Memory Cartridge (Bank 3)

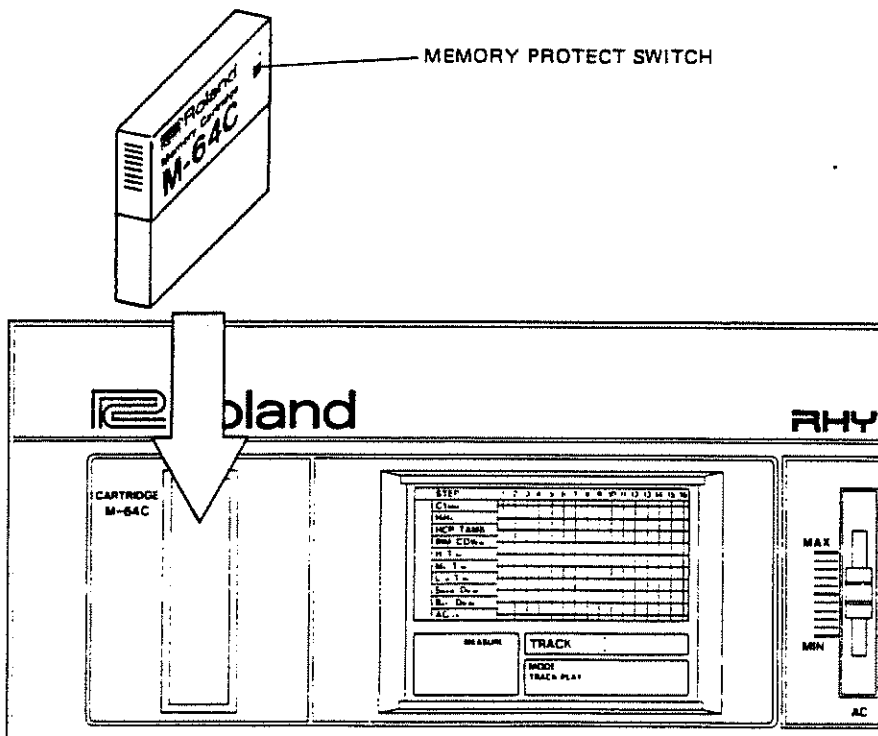

b. Saving and Loading

1) Saving data onto the cartridge

Enter the Track Playing mode with the rhythm not running.

① While holding the Shift Key 2^{4} down, press the Cartridge Key (=Enter) 1 to select Bank 2 or 3. Each time you press the Cartridge Key, the banks will change as shown a. Selecting a Bank on page 35.

② Set the Protect Switch on the Memory Cartridge to OFF.

③ While holding the Shift Key down, press the Copy Key (Main Key 11), then the Main Key 1, then the Enter Key.

On pressing the Copy Key, the Display Window will show the selected Bank 2 or 3. And on pressing the Main Key 1, 1-2 or 1-3 appears showing that data in Bank 1 is being saved to Bank 2 or 3. On pressing the Enter Key, the Display will show the 1st pattern of the saved data. And, now saving is done.

④ Return the Protect Switch to ON.

2) Loading data from the cartridge

Enter the Track Playing mode with the rhythm not running.

① While holding the Shift Key 2^{4} , press the Cartridge Button 1 to select Bank 1 (Composer's memory).

② While holding the Shift Key down, press the Copy Key (Main Key 11), then the Main Key 2 or 3 depending on which bank you wish to load, then the Enter Key 1 .

On pressing the Copy Key, the Display Window will show - 1 , and on pressing the Main key, 2-1 or 3-1 appears showing that data in Bank 2 or 3 whichever has been selected is being loaded into the Composer. In a few seconds after pressing the Enter Key, the Display will show the 1st pattern of the loaded data. And, now loading is completed. In the same way, you can transfer data from bank 2 to 3 2-3 , or from 3 to 2 3-2 .

10 EXTERNAL CONNECTIONS

There are many ways of connecting the Composer to other instruments, special effects and external controls, especially through the use of MIDI. This Chapter describes how to use these connections which can all be found on the back panel of the Composer.

a. Multi Output

There is a separate output socket for each voice. All voices are normally summed together at the Master output. Any voices taken out separately will be subtracted from the total. Effect units may be Echo, Delay, Reverb, Graphic Equalizer, Flanger, etc.

b. Trigger Output, Start/Stop

A positive 5 volt pulse of 20ms is available in the same interval as written Rim Shot. An external Pedal Switch performs the same function as Start/Stop. (See the picture below.)

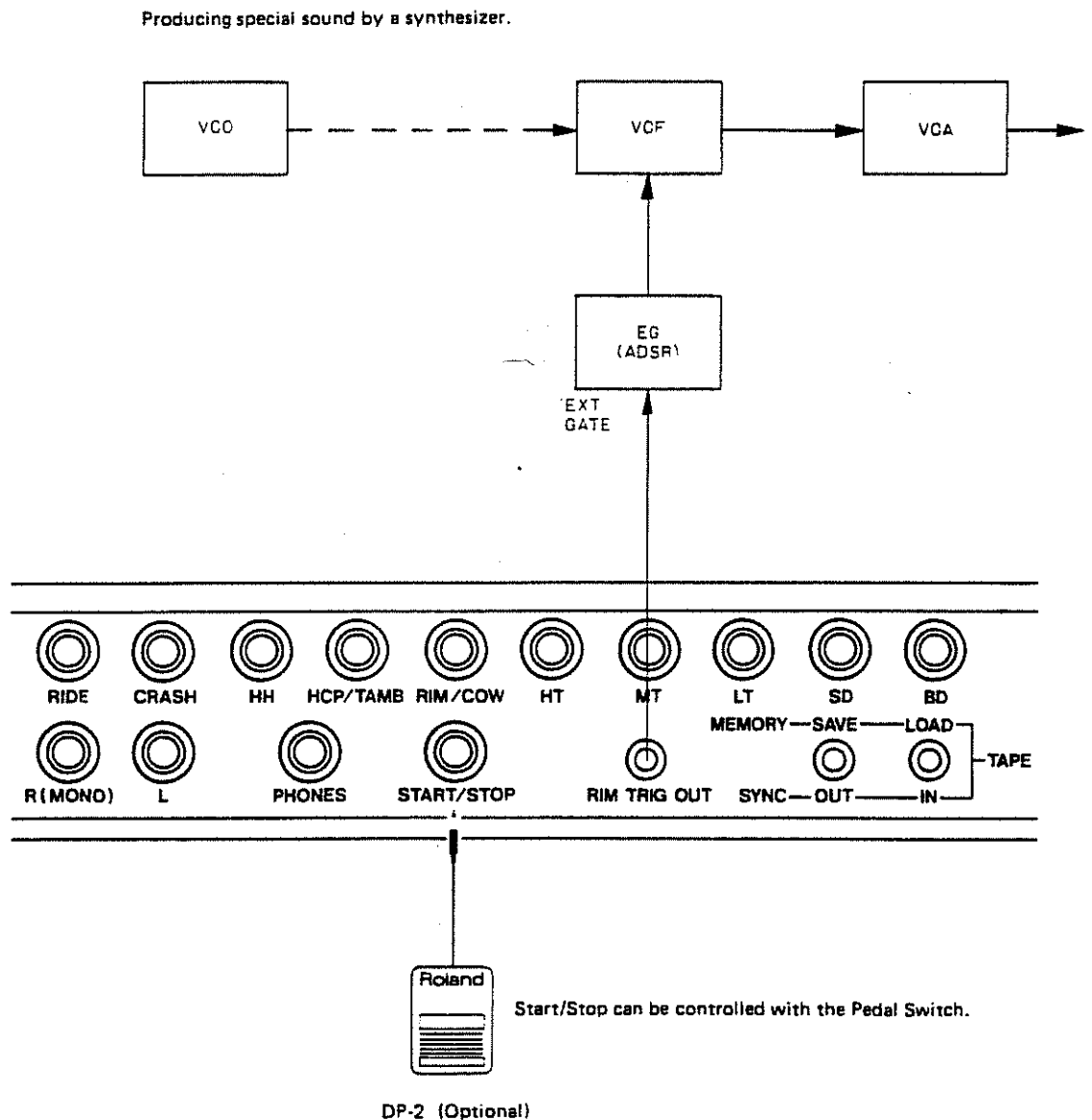

11 SYNC

The TR-707 features Sync function using DIN socket, MIDI connector and tape recorder.

To change the Sync modes, set the Composer to Track Play mode without rhythm running, and push the Sync Mode Button ① while holding the Shift Key ② down.

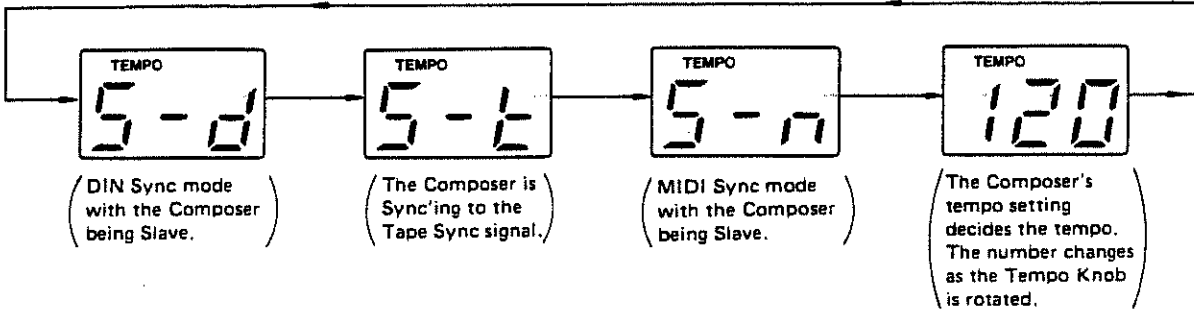

a. Sync using DIN

The DIN socket marked "SYNC" is for use with non-MIDI instruments.

When the Composer is controlling the tempo or set to Tape Sync mode, the DIN Connector on the back panel serves as an Output. To use the Composer as a Slave, however, convert it to an Input as follows.

Connect the composer to the master devices as shown in Fig a-1, and turn the TR-707 to the Track Playing mode. Then while holding the Shift Button ② down, press the Sync Mode Button ① until the Display becomes as shown in Fig a-2.

The TR-707 does not sync in the tempo quicker than $\mu = 250$, so be sure to set the tempo of the master instrument below that.

SYNC using DIN

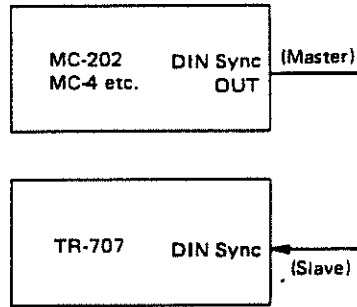

The Master device controls the tempo, start/stop, etc.

Fig a-1

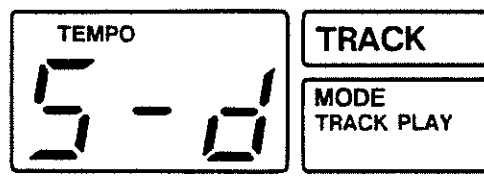

Display Reaction when the TR-707 serves as Slave in DIN Sync mode.

Fig a-2

b. Sync using MIDI

The TR-707 features MIDI output and input, therefore can sync with MIDI sequencer, etc.

1) Sync to slave devices

Connect the TR-707 to the slave device such as a sequencer, etc., as Fig b-1. Then set the slave device ready to receive Sync signal from the MIDI IN.

(Refer to the owner's manual of each device.)
Now, pressing the Start Key  of the composer will start syncing in the tempo of the composer.

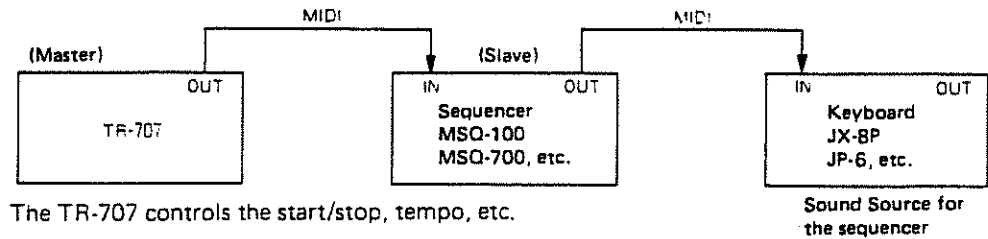

Fig b-1

2) Sync to master device

Connect the TR-707 to the master device such as a sequencer, etc., as Fig b-2. Then take the following procedure to select MIDI Sync mode.

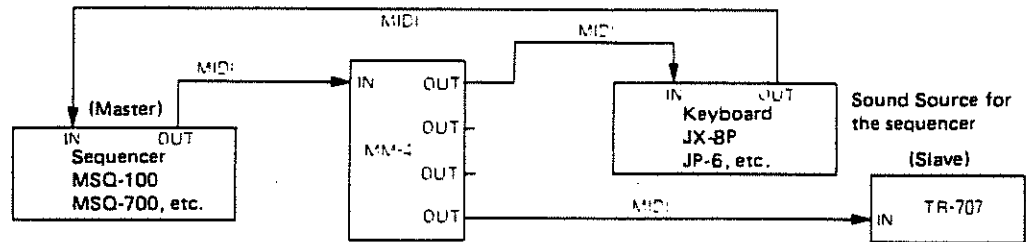

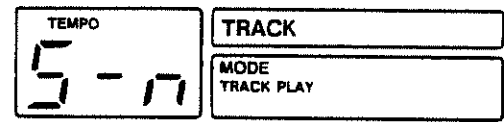

Fig b-2



- ① Turn the composer to the Track Playing mode.
- ② While holding the Shift Key  down, press the Sync Mode Button  until the Display becomes as shown right.

Now, the tempo and start/stop are controlled by the master device.



This indication means the TR-707 is in the MIDI Sync mode, serving as Slave.

How to return to the Internal Tempo Mode

While holding the Shift Key  down, push the Sync Mode Button  until the Tempo/Measure display section shows tempo value.

- * In the MIDI Sync mode, there is no signal output from the DIN Sync Connector or Tape Sync Out Jack.

c. Sync using Tape Recorder

The Tape Sync jacks on the back panel (the same jacks used for saving and loading onto cassette) can be used to run the Composer from a Sync signal recorded on a tape.

1) Recording the Sync signal

- 1) Connect the tape recorder as shown below.

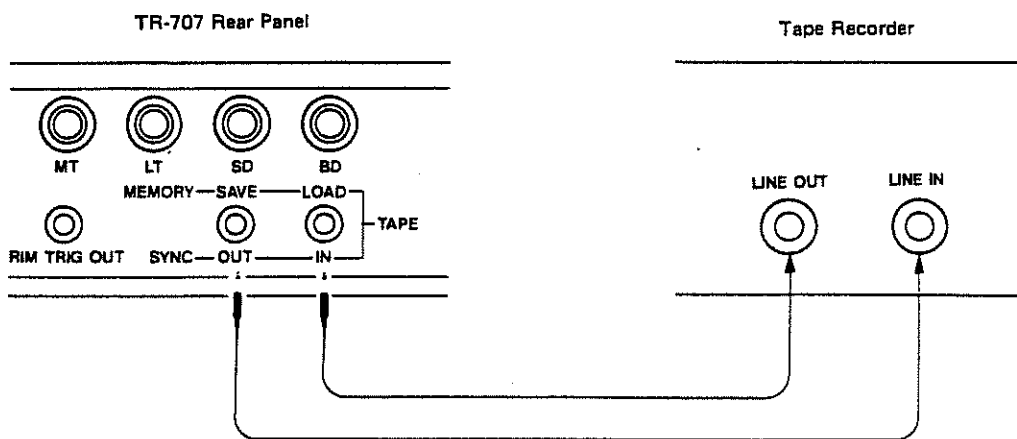

- 2) With the rhythm not running, the Composer generates a signal at the Load jack. Adjust the tape deck so that the recording level reads about -10 to -3 VU.
- 3) Select the Track to be played and adjust the tempo.
- 4) Start recording, then in a few seconds push the Start Key to start the rhythm.
- 5) When the whole Track has played and the Composer stops, stop the recorder.

Be sure to set the tempo slower than $\bullet = 180$.

2) Controlling the Composer from the tape recorder

The composer can sync to the synchro signal recorded on tape, which is useful for multitrack recording.

- ① Connect the Composer to the tape recorder as shown in Fig c-2.
- ② Cue the tape recorder so that it will play from the beginning of the Pilot tone.
- ③ Select the Track Playing mode, then select the Track to be played.
- ④ Press the Sync Mode Button **Ⓜ** while holding the Shift Key **⇧** until the Display shows as Fig c-3.
Now, the Composer is ready to be controlled by the synchro signal sent to the Tape Sync jack.
- ⑤ Press the Play button on the tape recorder.
- ⑥ Press the Start Key **Ⓢ** on the composer.

Be sure to push the Start Key, before the Pilot tone turns to modulated tone.

The moment the Pilot tone turns to modulated tone, the composer starts syncing.

- ⑦ You can leave the Tape Sync mode before starting the Composer, by pushing the Sync Mode Button **Ⓜ**. You can stop it while running, by pushing the Stop/Continue Key **Ⓢ**.

* If slave instruments are connected to the Composer by MIDI or DIN, they will sync together.

How to return to the Internal Tempo Mode

While holding the Shift Key **⇧** down, push the Sync Mode Button **Ⓜ** until the Tempo/Measure display section shows tempo value.

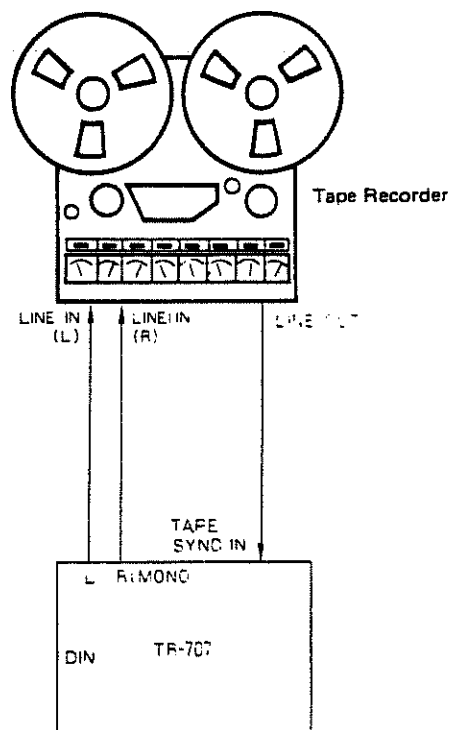

Fig c-2

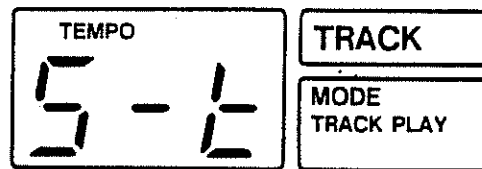

Fig c-3

12 MIDI

The TR-707 has two MIDI Connectors, IN and OUT. (See the separate volume "MIDI"). If the Composer is connected through its MIDI OUT to another

instrument's MIDI IN connector, then the Composer will control that instrument, and vice-versa.

The TR-707 can transmit and receive the following MIDI messages.



1. Key message for each voice (here, each drum voice is represented by key number)
2. Track Number (Song Select) message
3. Bar Number (Song Position) message
4. Synchro Signal such as Tempo Clock, Start/Stop, etc.



The messages 1, 2 and 3 can be sent or received only in Track Play mode.

a. Setting MIDI Channel

MIDI message can be sent or received only on the same MIDI Channel, that is, the MIDI instruments should be set up properly, and also select the same MIDI Channels.

The TR-707 has 16 MIDI Channels and any of these channels can be selected using the Main Keys (1 to 16) depending on the device used with the TR-707.

1) First, check how the Display reacts by pressing the MIDI Channel Button  while holding the Shift Key  down.

2) Now, try changing channel numbers. While holding the Shift Key  down, push the MIDI Channel Button  then the Main Key (1 to 16) selecting the channel number (1 to 16).

The Tempo/Measure section of the Display shows the MIDI channel currently set.

* The Display shows the channel number you have set.

Indication of OMNI Mode ON/OFF & MIDI Channel.

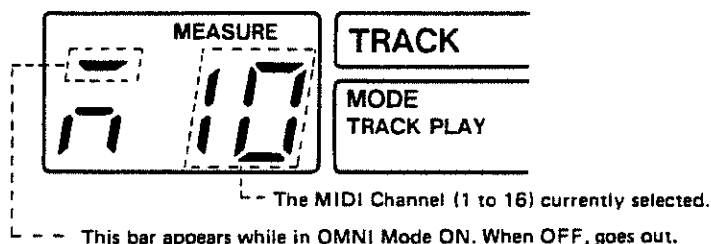

-- The MIDI Channel (1 to 16) currently selected.

-- This bar appears while in OMNI Mode ON. When OFF, goes out.

b. OMNI Mode

As explained in the former section, to enable MIDI voice messages to be communicated by means of MIDI, it is critical to set the MIDI channel of all the relevant MIDI instruments to the same numbers. OMNI ON mode, however, makes the receiver recognize voice messages in all channels without discrimination. Use the OMNI ON or OFF mode which makes the receiver accept voice messages only from the selected channel(s), depending on the situation.

Operation to select OMNI ON or OFF

Enter the Track Writing mode with the rhythm not running.

1) First, see how the Display reacts by pressing the MIDI Channel Button **Ⓜ** while holding the Shift Key **⇧** down.

2) Try changing the modes, by holding the Shift Key **⇧** down and pushing the MIDI Channel Button **Ⓜ** then the Enter **Ⓜ**.

The Tempo/Measure section of the Display will show either OMNI ON or OMNI OFF whichever happens to be selected currently.

Repeat the above procedure 2) to return to the previous mode.

Indication of OMNI Mode ON/OFF & MIDI Channel.

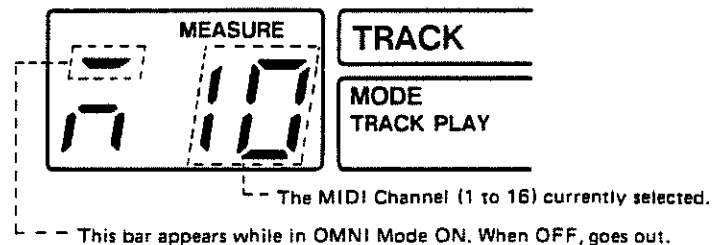

c. Key Number (Assigning Key numbers to the Composer's drum voices)

The keyboard message sent from the sequencer or keyboard is received by the TR-707 and makes the drum voices sound. Any key number can be assigned to each drum voice later, but let's see the initial setting from the manufacturer.

Drum Voices and corresponding Key Numbers. (MIDI IN)

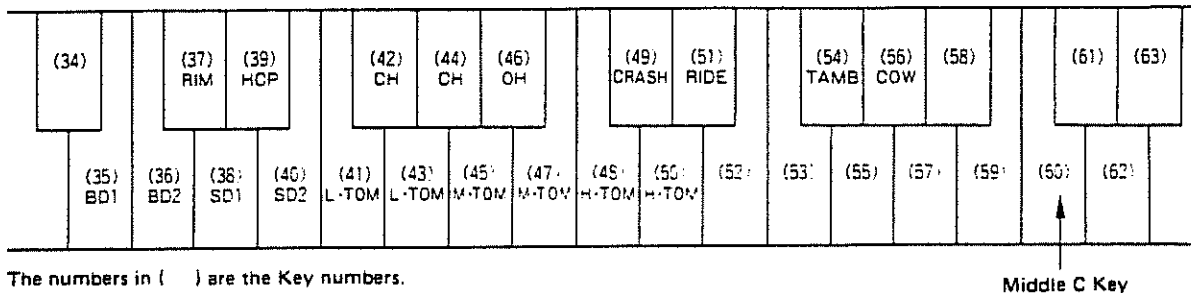

1) Even if the initial setting shown above has been altered for some reason when you get your TR-707, you can initialize it as follows.

- 1 Enter the Track Playing mode, with the rhythm not running.
- 2 While holding the Shift Key (24) down, press the MIDI Channel Button (10) TWICE. All the indicators of Pattern Group Buttons and Main Keys will go out, telling you that key numbers can now be assigned to the voices.

3 Press the Instrument/Guide Button (29), and the initial setting is returned.

4 To leave this Key Number Setting mode, push the Enter Key (25).

2) To assign a Key number you like to each voice.

- 1 First, connect the Composer to the MIDI instruments as shown in Fig c-2.

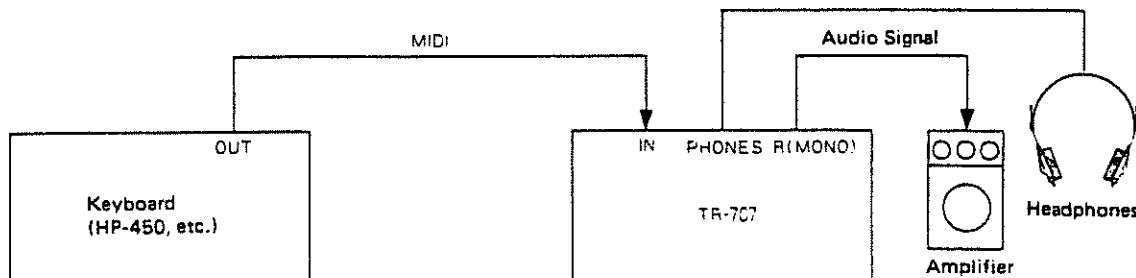

Set the amplifier and speaker so that you can monitor each drum voice.

Fig c-2

- ② Enter the Track Writing mode, without the rhythm having run.
- ③ While holding the Shift Key **Ⓢ**, press the MIDI Channel Button **Ⓜ** TWICE. All the indicators of Pattern Group Buttons and Main Keys will go out, telling you that key numbers can now be assigned to the voices.
- ④ Push the Track Clear Button **Ⓢ**. This clears previous key number assignment.
- ⑤ Select a drum voice and hold the corresponding Main Key down, and without releasing it, press a key on the connected instrument.
- ⑥ To cancel the key assignment you have made, press the same key again.

- ⑦ If you wish to actually listen to the reaction of the drum sound here, try it by playing the relevant key on the instrument.
- ⑧ To cancel this Key Number Setting mode, push the Enter Key **Ⓢ**.

Several key numbers can be set to one voice, but the same number cannot be assigned to more than one voice.

If you assign the key number already used for a certain voice to another voice, the previous voice will be automatically dropped.

The key numbers available for this assignment are 35 to 98.

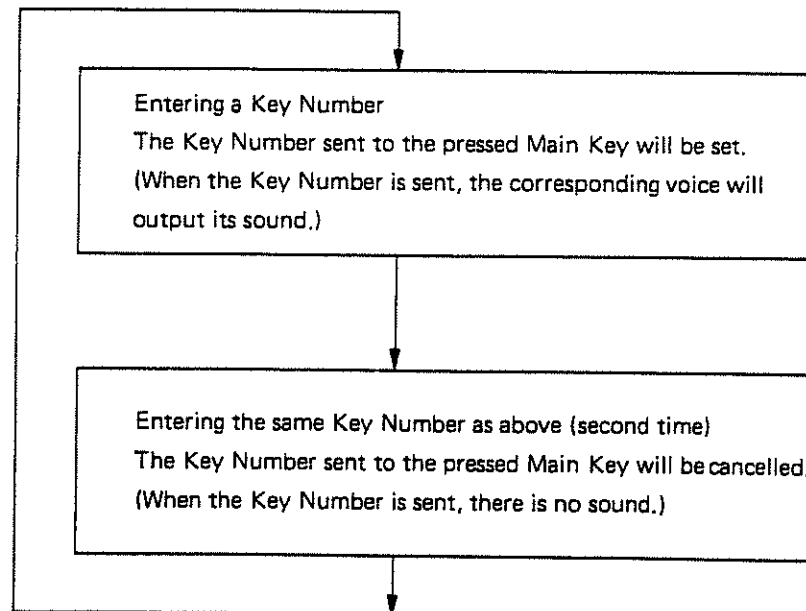

d. Transmitting MIDI message from the Composer

The MIDI message sent from the Composer is received by the connected instrument and makes the keys produce sounds. There are two kinds of assignments optional as shown in the Fig d-1 or 2 below. The following operation is to choose one of them.

- ① Enter the Track Playing mode, without rhythm running. Then while holding the Shift Key **23** down, push the MIDI Channel button **10** and the Instrument/Guide Button **29**. Turn the TR-707 to the Key message transmitting mode. (Each time you push the Instrument Guide Button, the TR-707 is turned to the internal voice mode and Key message transmitting mode alternately.)
- ② Enter the Track Playing mode, without rhythm running. Then while holding the Shift Key **23** down, push the MIDI Channel Button **10** and the Last Step Button **28**. Table in Fig d-1 and in Fig d-2 are alternately selected.

NOTE

- * When the Composer is transmitting MIDI message, the built-in voices do not output any sound.
- * The Key message transmitting mode is available only while in the Track Play mode. In this mode, only the programmed sounds will be transmitted.

Triggers of Voices and corresponding Key Numbers (MIDI OUT)

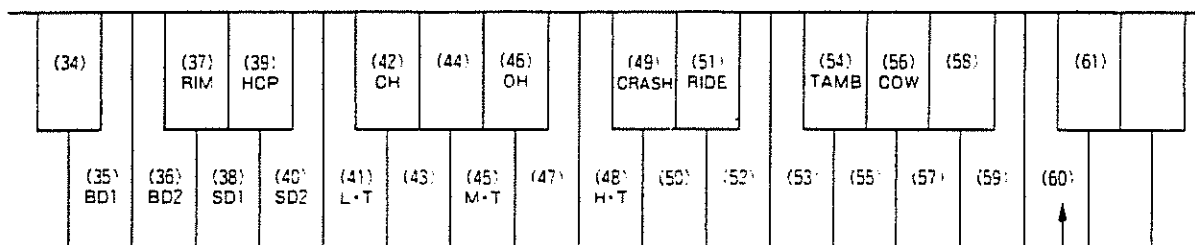

The numbers in () mean the Key Numbers, and the words below them are the Triggers' names of the Voices.

Middle C Key

Fig d-1

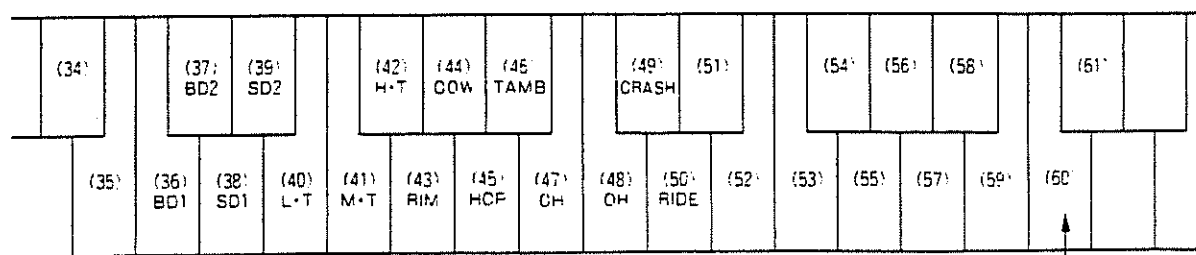

The numbers in () mean the Key Numbers and the words below them are the Triggers' names of the Voices.

Middle C Key

Fig d-2

5 Specifications

TR-707 RHYTHM COMPOSER

Memory Capacity 64 Patterns
(4 Pattern Groups x 16)
Tempo ♩ = 38 to 250
Tracks 4 tracks
(I to IV tracks up to 998 bars)
Step number (per bar) 1 to 16 steps

Drum Voices (15 Voices)

Bass Drums (1 and 2)
Snare Drums (1 and 2)
Low Tom
Mid Tom
Hi Tom
Rim Shot/Cow Bell
Hand Clap/Tambourine
Closed/Open Hi-hat
Crash Cymbal
Ride Cymbal
Total Accent (weaker, stronger)

Controls & Indicators

Start Key
Stop Continue Key
Shift Key
Main Keys (1 to 16)
Clear Button

In Pattern Mode

Scale Button
Last Step Button
Instrument Select/Guide Button

In Track Mode

Back Button
Forward Button
Last Measure Button

Shuffle/Flam Button
Tempo/Measure Button
Enter Key/Accent Key
Pattern Group Buttons (A, B, C, D)

Shift Function

MIDI Channel Button
Sync Mode Button
Memory Cartridge Key
Track Selector Buttons (I to IV)

Pattern Mode Button
Track Mode Button
Tempo Knob
Accent Level Knob
Bass Drum Level Knob
Snare Drum Level Knob
Low Tom Level Knob
Mid Tom Level Knob
Hi Tom Level Knob
Rim Shot Level Knob/Cow Bell Level Knob
Hand Clap/Tambourine Level Knob
Hi-hat Level Knob
Ride/Crash Cymbal Level Knob
Volume Knob
Display Window (Rhythm Pattern, Tempo/
Measure, Track Number, Mode sections)
Memory Cartridge Slot (for M-64C)

Rear Panel

Master Output (L, R/Mono)
Multi Outputs

Bass Drum (1 and 2)
Snare Drum (1 and 2)

Low Tom

Mid Tom

Hi Tom

Rim Shot/Cow Bell

Hand Clap/Tambourine

Closed/Open Hi-hat

Crash Cymbal

Ride Cymbal

MIDI Input

MIDI Output

Tape Memory/Sync

Save/Out

Load/In

External Control

Trigger Output (Rim Shot: +5V, 20ms pulse)

Start/Stop (DP-2)

Sync (In/Out)

(1: Run/Stop, 2: GND, 3: Clock, 5: Continue)

Power Switch

DC IN (for supplied AC Adaptor)

Power Consumption: 2.4W

Dimensions: 380(W) x 250(D) x 73(H) mm/
14-15/16" x 9-13/16" x 2-7/8"

Weight: 1.5 kg/3 lb 5 oz

Accessories: 12V AC Adaptor
Connection Cord
Owner's Manual
MIDI

Options: Pedal Switch DP-2
Memory Cartridge M-64C

Pattern # :



BANK :
PATTERN GROUP :

SHUFFLE : 1 2 3 4 5
FLAM : 9 10 11 12 13

STEP	1	2	3	4	5	6	7	8	9	10	11	12	13	14	15	16
LAST STEP																
CYMBAL																
HIHAT																
HCP/TAMB																
RIM/COW																
HI TOM																
MID TOM																
LOW TOM																
SNARE DRUM																
BASS DRUM																
ACCENT																
	1	2	3	4	5	6	7	8	9	10	11	12	13	14	15	16

Pattern # :



BANK :
PATTERN GROUP :

SHUFFLE : 1 2 3 4 5
FLAM : 9 10 11 12 13

STEP	1	2	3	4	5	6	7	8	9	10	11	12	13	14	15	16
LAST STEP																
CYMBAL																
HIHAT																
HCP/TAMB																
RIM/COW																
HI TOM																
MID TOM																
LOW TOM																
SNARE DRUM																
BASS DRUM																
ACCENT																
	1	2	3	4	5	6	7	8	9	10	11	12	13	14	15	16

Pattern # :

BANK :

PATTERN GROUP :

Scale : 

SHUFFLE : 1 2 3 4 5

FLAM : 9 10 11 12 13

STEP

1 2 3 4 5 6 7 8 9 10 11 12 13 14 15 16

LAST STEP

CYMBAL

HIHAT

HCP/TAMB

RIM/COW

HI TOM

MID TOM

LOW TOM

SNARE DRUM

BASS DRUM

ACCENT

1 2 3 4 5 6 7 8 9 10 11 12 13 14 15 16

Pattern # :

BANK :

PATTERN GROUP :

Scale : 

SHUFFLE : 1 2 3 4 5

FLAM : 9 10 11 12 13

STEP

1 2 3 4 5 6 7 8 9 10 11 12 13 14 15 16

LAST STEP

CYMBAL

HIHAT

HCP/TAMB

RIM/COW

HI TOM

MID TOM

LOW TOM

SNARE DRUM

BASS DRUM

ACCENT

1 2 3 4 5 6 7 8 9 10 11 12 13 14 15 16

MODEL TR-707 MIDI Implementation Chart

Function.....		Transmitted	Recognized	Remarks
Basic Channel	Default Changed	1 - 16 1 - 16	1 - 16 1 - 16	Memorized
Mode	Default Messages Altered	Mode 3 *****	Mode 1 OMNI ON OFF	MONO, POLY ignored
Note Number	True voice	35-51, 54, 56 *****	35-51, 54, 56 * 35-51, 54, 56 *	assigns to each rhythm voice
Velocity	Note ON Note OFF	⌋ 9n v=40-124 X 9n v=0	⌋ v=1-127 X	n = 0 - SF
After Touch	Key's Ch's	X X	X X	
Pitch Bender		X	X	
Control Change		X	X	
Prog Change	True =	X *****	X	
System Exclusive		⌋	⌋	For rhythm seq
System Common	Song Pos Song Sel Tune	⌋ ⌋ (0-3) X	⌋ ⌋ (0-3) X	
System Real Time	Clock Commands	⌋ ⌋	⌋ SYNC mode = MIDI ⌋ SYNC mode = MIDI	
Aux Messages	Local ON OFF All Notes OFF Active Sense Reset	X X ** **	X X X X	
Notes		* Recognized note numbers can be assigned by panel operation. (35-98) ** If received when SYNC mode is MIDI.		

Mode 1 : OMNI ON, POLY
 Mode 3 : OMNI OFF, POLY

Mode 2 : OMNI ON, MONO
 Mode 4 : OMNI OFF, MONO

⌋ : Y
 X : N

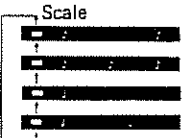
Mode Setting	
1. Track Playing TRACK 32 Number of the button (corresponding Panel Descriptions) Display Action MODE TRACK PLAY	23
2. Track Writing SHIFT 24 TRACK 32 MODE TRACK WRITE	22
3. Pattern Playing PATTERN 33 MODE PATTERN PLAY	16
4. Step Writing SHIFT 24 PATTERN 33 MODE STEP WRITE	9
5. Tap Writing SHIFT 24 PATTERN 33 MODE TAP WRITE	14
Recalling the Demonstration Program	
TRACK 32 TRACK NUMBER I 34 POWER ON 37	8
Selecting a Pattern (64 patterns)	
Set the Composer to Pattern Writing or Pattern Playing mode without rhythm running. PATTERN GROUP A-D 34 + MAIN KEY 1-16 1-16	9
Selecting a Track (4 Tracks)	
Set the Composer to Track Playing or Track Writing Mode. SHIFT 24 TRACK NUMBER I-IV 34	22
Setting the Scale	
Set the Composer to Tap Writing or Step Writing mode. 1. Setting the Scale SCALE 28 	18
Setting the Last Step	
Set the Composer to Tap Writing or Step Writing mode. 1. Start the rhythm. START 23 2. Set the Last Step. LAST STEP 27 MAIN KEY 1-16 1-16	18
Clearing a Pattern	
Set the Composer to Pattern Writing mode without rhythm running. CLEAR 29 MAIN KEY 1-16 1-16	10
Clearing a Drum Voice	
Set the Composer to Tap Writing mode with rhythm running. CLEAR 29 MAIN KEY 1-16 1-16	15
Chain Function	
Set the Composer to Pattern Writing mode. MAIN KEY 1-16 1-16 MAIN KEY 1-16 1-16 ENTER 35 The first and last pattern numbers of a Chain.	29
Cancel the Chain Function MAIN KEY 1-16 1-16 ENTER 35 The number of the Pattern to be dropped.	

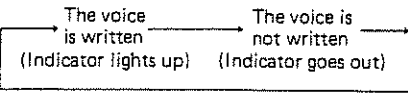
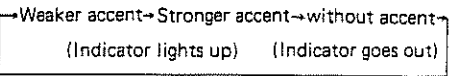
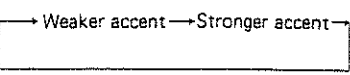
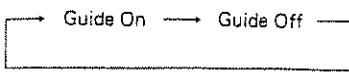
Step Writing	
Set the Composer to the Step Writing mode. 1. Select a location where you write your Pattern. PATTERN GROUP A-D 34 + MAIN KEY 1-16 1-16	9
2. Clear the previous Pattern. CLEAR 29 MAIN KEY 1-16 1-16 Press the same Key pressed in step 1.	10
3. Start the rhythm. START 23	
4. Select a voice to be written. a) Selecting a voice INSTRUMENT/GUIDE 26 MAIN KEY 1-16 1-16 b) Selecting a voice to which you wish to write Flam. INSTRUMENT/GUIDE 26 MAIN KEY 3-6 3-6 MAIN KEY 3-6 3-6 c) Selecting a stronger or weaker accent. INSTRUMENT/GUIDE 26 ACCENT 35	20
5. Select the steps where you want the drum voice. MAIN KEY 1 1 MAIN KEY 16 16 When writing a drum voice. 	11
When writing accent. 	
6. Repeat the procedures 4 and 5 as many times.	
Tap Writing	
Set the Composer to Tap Writing mode. 1. Select a location where you write your pattern. PATTERN GROUP A-D 34 + MAIN KEY 1-16 1-16	14
2. Clear the previous Pattern. CLEAR 29 MAIN KEY 1-16 1-16 Press the same Main Key as pressed in step 2.	
3. Start the rhythm START 23	
4. Tap in the rhythm of the Rim Shot on Main Keys. a) Usual Tap Writing MAIN KEY 1-16 1-16 b) Tap Writing of voice with Flam. (SD, LT, MT, HT) SHUFFLE/FLAM 30 MAIN KEY 3-7 3-7 c) Tap Writing of accent. ACCENT 35 	15
Turning On/Off of guide crotchet rim shot. In Tap Writing mode INSTRUMENT/GUIDE 26 	20

Selecting a Snare Drum with Flam (SD1 or SD2)

Set the Composer to Pattern Writing mode.

SHIFT 24 INSTRUMENT/GUIDE 26

Snare Drum 1 with Flam → Snare Drum 2 with Flam

20

Setting a Flam Interval (4 options)

Set the Composer to Step Writing mode.

FLAM/SHUEELE 30 MAIN KEY 9~13 9~13

MAIN KEY 9 = Flam OFF

21

Selecting Shuffle Intensity (4 options)

Set the Composer to Step Writing mode.

FLAM/SHUFFLE 30 MAIN KEY 1~5 1~5

MAIN KEY 1 = Shuffle OFF

21

Copying a Pattern

Set the Composer to Pattern Writing mode.

1. Assign a new location (Pattern Number)

PATTERN GROUP A~D 34 + MAIN KEY 1~16 1~16

2. Assign your source Pattern, then execute copying.

SHIFT 24 COPY (MAIN KEY 11) 11 PATTERN GROUP A~D 34

MAIN KEY 1~16 1~16 ENTER 35

28

Pattern Playing

1. Select a Pattern to be played.

PATTERN GROUP A~D 34 + MAIN KEY 1~16 1~16

2. Start the rhythm.

START 23

The rhythm pattern will repeat until the Stop Key is pushed.

3. Stop the rhythm.

STOP/CONT 22

16

Block Playing

1. Assign the block to be played.

MAIN KEY 1~16 1~16 MAIN KEY 1~16 1~16

2. Start the rhythm.

START 23

16

Track Writing

1. Set the Composer to Track Writing mode.

SHIFT 24 TRACK 32

2. Select a Track to be used.

SHIFT 24 TRACK NUMBER I, II, III or IV 34

3. Clear the existing Patterns written in the Track.

TRACK CLEAR 29 TRACK NUMBER I, II, III or IV 34

4. Start the rhythm.

START 23

5. Select the Patterns to be written into the Track.

a) Writing single Patterns.

PATTERN GROUP A~D 34 + MAIN KEY 1~16 1~16

b) Writing Chained Patterns.

PATTERN GROUP A~D 34

MAIN KEY 1~16 1~16 MAIN KEY 1~16 1~16

6. Execute writing Patterns.

ENTER 35

7. Repeat procedures 5 and 6 as many times.

8. Stop writing.

STOP/CONT 22

22

Track Playing

1. Set the Composer to Track Playing mode.

TRACK 32

2. Select a Track to be played.

SHIFT 24 TRACK NUMBER I ~ IV 34

3. a) Starting to play from the 1st bar.

START 23

b) Starting to play from the bar you like.

Set the bar you like

SHIFT 24 MAIN KEY 1~10 1~10 ENTER 35

Bar number

Continue Start.

STOP/CONT 22

23

Calling a desired Bar

Set the Composer to Track Playing or Track Writing mode.

1. SHIFT 24 MAIN KEY 1~10 1~10 ENTER 35

2. Forward a Bar

FWD

3. Quick Forward

FWD 27 BACK 28

4. Back-up a Bar

BACK 28

5. Quick Back-up

BACK 28 FWD 27

24

EDIT FUNCTIONS

Delete

Set the Composer to Track Writing mode.

1. Set the Bar where deleting starts.

SHIFT 24 MAIN KEY 1~10 1~10 MAIN KEY 1~10 1~10 MAIN KEY 1~10 1~10

ENTER 35 Setting the Bar number.

2. Set the Bar where deleting ends and execute deleting.

SHIFT 24 DELETE (MAIN KEY 13) 13 MAIN KEY 1~10 1~10 MAIN KEY 1~10 1~10

MAIN KEY 1~10 1~10 ENTER 35 Setting the Bar number.

Insert

Set the Composer to Track Writing mode.

1. Set the Bar after which you wish to insert a Pattern.

SHIFT 24 MAIN KEY 1~10 1~10 MAIN KEY 1~10 1~10 MAIN KEY 1~10 1~10

ENTER 35 Setting the Bar number.

2. Select the Pattern to be inserted.

PATTERN GROUP A~D 34 MAIN KEY 1~16 1~16

3. Execute inserting.

SHIFT 24 INSERT (MAIN KEY 12) 12 ENTER 35

Copy (within Tracks)

Set the Composer to the Track Writing mode.

1. Assign the Bar after which you wish the new pattern to begin.

SHIFT 24 MAIN KEY 1~10 1~10 MAIN KEY 1~10 1~10 MAIN KEY 1~10 1~10

ENTER 35 Setting the Bar number.

2. Assign the starting Bar number and ending bar number.

SHIFT 24 COPY (MAIN KEY 11) 11 MAIN KEY 1~10 1~10 ENTER 35

Setting the Bar number.

MAIN KEY 1~10 1~10 ENTER 35

Setting ending Bar number.

MIDI

Setting a MIDI Channel (one CH for both receive and send)

Set the Composer to Track Playing mode.

1. Set a MIDI Channel (1 to 16).

SHIFT 24 MIDI CH 30 MAIN KEY 1~16 1~16



Setting OMNI ON or OFF

Set the Composer to Track Playing mode.

1. Select OMNI ON or OFF mode. OMNI ON/OFF Indication ("—" lights up when OMNI ON)

SHIFT 24 MIDI CH 30 ENTER 35

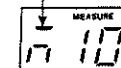
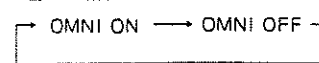

Key Number Assignment 1 (to the Composer)

Set the Composer to the Track Playing mode.

1. Set the Composer ready to be assigned Key number.

SHIFT 24 MIDI CH 30 MIDI CH 30

2. Set the same Key number as MIDI out.

INSTRUMENT/GUIDE 26 + ENTER 35

Key numbers of MIDI out



The numbers in () are the Key numbers.

Key Number Assignment 2 (from the Composer)

Set the Composer to Track Playing mode.

1. Set the Composer to Key Number Setting mode.

SHIFT 24 MIDI CH 30 MIDI CH 30

2. Clear the previous Key number assignment.

CLEAR 29

3. Assign a Key number to each voice.

MAIN KEY 1~16 1~16 Send NOTE ON of a Key number to MIDI IN. ...

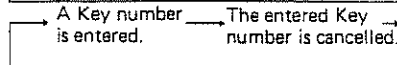

4. Leave the Key Number Setting mode.

ENTER 35

Selecting the Trigger Out (to MIDI out/to Internal Sound Source)

Set the Composer to Track Playing mode.

1. Changing Trigger Out.

SHIFT 24 MIDI CH 30 INSTRUMENT/GUIDE 26

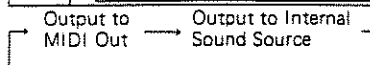

Transmitter Key Assignment to the Voice Trigger

Set the Composer to Track Playing mode without rhythm running.

SHIFT 24 MIDI CH 38 LAST STEP 27

Key Assignment 1

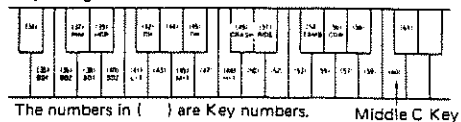

Key Assignment 2

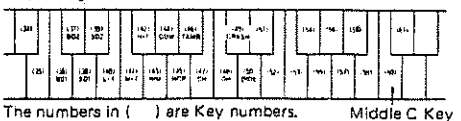

46

Changing Sync Modes

Set the Composer to Track Writing mode.

1. Enter to the Sync mode.

SHIFT 24 SYNC 31

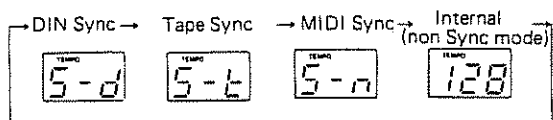

38

Memory Cartridge

Changing Memory Banks

Set the Composer to Track Playing mode.

1. Changing Memory Banks.

SHIFT 24 ENTER 35

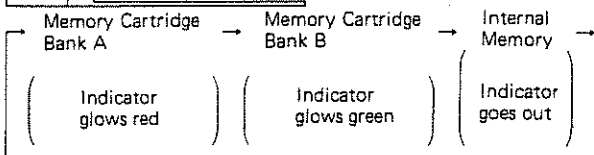

35

Saving & Loading

Set the Composer to the Track Playing mode.

A. Internal Memory → Memory Cartridge A or B Bank.

1. Set the Protect Switch on the Memory Cartridge to OFF.
2. Select either Memory Cartridge A or B Bank.
3. Save the data in Internal Memory to the Memory Cartridge.

SHIFT 24 COPY (MAIN KEY 11) 11 Internal Memory Bank (MAIN KEY 1) 1 ENTER 35

B. Memory Cartridge A or B Bank → Internal Memory

1. Select the Internal Memory.

SHIFT 24 COPY (MAIN KEY 11) 11 Memory Cartridge A Bank (MAIN KEY 2) 2

ENTER 35

or

SHIFT 24 COPY (MAIN KEY 11) 11 Memory Cartridge B Bank (MAIN KEY 3) 3

ENTER 35

36

Tape Interface

A. Saving

SHIFT 24 SAVE (MAIN KEY 14) 14 MAIN KEY 1-10 1-10 MAIN KEY 1-10 1-10

Setting File Number (Skip it, if you do not want to set a file number.)

ENTER 35

B. Verifying

SHIFT 24 VERIFY (MAIN KEY 15) 15 ENTER 35

C. Loading

SHIFT 24 LOAD (MAIN KEY 16) 16 MAIN KEY 1-10 1-10 MAIN KEY 1-10 1-10

Assigning File Number (Skip this if you do not need this.)

ENTER 35

Leaving Tape Interface mode.

MAIN KEY 1 1

31
32
34

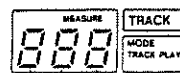

File Number (1 to 99) or no indication.

- S Save
- U Verify
- L Load
- P Pass
- F Found

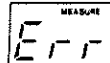

Error

MODEL TR-707 MIDI Implementation

1. TRANSMITTED DATA

Status	Second	Third	Description
100: nnnn	0kkt kkkk	0000 0000	Note OFF kkkkkk = 35-51, 54, 55 #1 #5
100: nnnn	0kkt kkkk	Dvvv vvvv	Note ON kkkkkk = 35-51, 54, 55 #1 vvvvvv = 40 - 124 #5
111: 0010	0nnn nnnn	Oyyy yyyy	Song Position Pointer #2 nnnnnn: Least significant yyyyyy: Most significant
111: 0011	0nnn nnnn		Song Select #3 nnnnnn = 0 - 3 (track #)
111: 1000			Timing Clock #4
111: 1010			Start #4
111: 1011			Continue #4
111: 1100			Stop #4
111: 0000	0100 0001	0nnn nnnn	Sequence Data (Exclusive message)
	111: 0111 (EOX)		

Notes: #1 Transmitted channel # can be changed to 1 - 15 by the front panel. When the power is applied, the channel is set to the last channel.
#2 When the measure number is set.
#3 When the track # is set.

track #	nnnnnn
1	0
2	1
3	2
4	3

#4

Tempo Mode	Synchronized with
Internal	Internal tempo clock
MIDI mode	received timing clock
DIN mode	positive edge of the DIN clock

#5 Note numbers are assigned as follows:

Key Name	Setting A	Setting B
Bass drum 1	35	36
Bass drum 2	36	37
Rim shot	37	40
Snare drum 1	38	38
Hand clap	39	45
Snare drum 2	40	39
Low tom	41	40
Closed Hi-hat	42	47
Mid tom	45	41
Open Hi-hat	45	48
High tom	48	42
Crash cymbal	48	49
Ride cymbal	51	50
Tambourine	54	46
Cowbell	55	44

Setting A: Normal.
Setting B: When the "MIDI" then "LAST STEP" buttons are pressed while pressing the "SHIFT" button.

2. RECOGNIZED RECEIVE DATA

Status	Second	Third	Description
100: nnnn	0kkt kkkk	Dvvv vvvv	Note ON kkkkkk = 35-51, 54, 55 #1 vvvvvv = 1 - 127 #2
101: bbbb	0111 1100	0000 0000	OMN: OFF
101: bbbb	0111 1101	0000 0000	OMN: ON
111: 0010	0nnn nnnn	Oyyy yyyy	Song Position Pointer #3 nnnnnn: Least significant yyyyyy: Most significant
111: 0011	0nnn nnnn		Song Select #3 nnnnnn = track #
111: 1000			Timing Clock #4
111: 1010			Start #4
111: 1011			Continue #4
111: 1100			Stop #4
111: 0000	0100 0001	0100 0010	Sequence Data (Exclusive message)
	111: 0111 (EOX)		

Notes: #1 Received channel # can be changed to 1 - 15 by the front panel. When the power is applied, the channel is set to the last channel.

#2 Recognized while in the Track Play mode. Any of the key numbers (35 - 55) may be assigned to each instrument by panel operation, and then they will be memorized. Originally, received note numbers are assigned as follows:

kkkkkk	Instrument
35	Bass Drum 1
36	Bass Drum 2
37	Rim Shot
38	Snare Drum 1
39	Hand Clap
40	Snare Drum 2
41, 43	Low Tom
42, 44	Closed Hi-Hat
45, 47	Mid Tom
45	Open Hi-Hat
48, 50	High Tom
48	Crash Cymbal
51	Ride Cymbal
54	Tambourine
55	Cowbell

All the note OFF messages are ignored.

#3 Recognized while in STOP of the Track Play mode. #4 When the SYNC mode is at MIDI.

While in the Tape interface mode, all MIDI messages are ignored.

3. HANDSHAKING COMMUNICATION

3.1 Message type

3.1.1 Want to send a file (WSF)

Byte	Description
a 1111 0000	Exclusive status
b 0100 0001	Reland ID #
c 0101 0000	Operation code
d 1111 0111	End of System Exclusive

3.1.2 Request a file (RWF)

Byte	Description
a 1111 0000	Exclusive status
b 0100 0001	Reland ID #
c 0101 0001	Operation code
d 1111 0111	End of System Exclusive

3.1.3 Data (DAT)

Byte	Description
a 1111 0000	Exclusive status
b 0100 0001	Reland ID #
c 0101 0010	Operation code
d 0000 0010	Format type
e 0100 nnnn	Block # (0 - 14)
f 0000 nnnn	
0000 yyyy	
0000 nnnn	B12 data bytes (255 bytes of yyyyyyyy)
0000 yyyy	
0000 yyyy	
00nn nnnn	Check sum (for preceding B12 data bytes)
k 1111 0111	End of System Exclusive

Note 1:

Summed value of the all bytes in data and the check sum must be 0 (7 bits).

3.1.4 Acknowledges (PAS)

Byte	Description
a 1111 0000	Exclusive status
b 0100 0001	Reland ID #
c 0101 0011	Operation code
d 1111 0111	End of System Exclusive

3.1.5 Continue (CNT)

Byte	Description
a 1111 0000	Exclusive status
b 0100 0001	Reland ID #
c 0101 0100	Operation code
d 1111 0111	End of System Exclusive

3.1.6 End of file (EOF)

Byte	Description
a 1111 0000	Exclusive status
b 0100 0001	Roland ID #
c 0101 0101	Operation code
d 1111 0111	End of System Exclusive

3.1.7 Communication error (ERR)

Byte	Description
a 1111 0000	Exclusive status
b 0100 0001	Roland ID #
c 0111 0001	Operation code
d 1111 0111	End of System Exclusive

3.1.8 Rejection (RJC)

Byte	Description
a 1111 0000	Exclusive status
b 0100 0001	Roland ID #
c 0111 0000	Operation code
d 1111 0111	End of System Exclusive

3.2 Sequence of communication

3.2.1 When the RGF is recognized

a RGF :	Request a File	(received)
b DAT :	Data	(transmitted)
c CNT :	Continue	(transmitted)
PAS :	Acknowledge	(received)
:	:	(14 times)
:	:	:
e DAT :	Data	(transmitted)
EOF :	End of File	(transmitted)
PAS :	Acknowledge	(received)

3.2.2 When the VSF is recognized

a VSF :	Want to Send a file	(received)
b RGF :	Request a File	(transmitted)
c DAT :	Data	(received)
e CNT :	Continue	(received)
PAS :	Acknowledge	(transmitted)
:	:	(14 times)
:	:	:
d DAT :	Data	(received)
EOF :	End of file	(received)
PAS :	Acknowledge	(transmitted)

3.2.3 When the VSF is received with error.

a VSF :	Want to Send a file	(received)
b RJC :	Rejection	(transmitted)
	(The sequence will abort then return to normal operation.)	

3.2.4 When the RGF is received with error.

a RGF :	Request a file	(received)
b RJC :	Rejection	(transmitted)
	(The sequence will abort then return to normal operation.)	

3.2.5 When the ERR is recognized.

:	:	:
:	:	:
DAT :	Data	(transmitted)
CNT :	Continue	(transmitted)
ERR :	Communication error	(received)
DAT :	Data (same block)	(transmitted)
CNT :	Continue	(transmitted)

3.2.6 When DAT or others is received with errors.

:	:	:
:	:	:
DAT :	Data	(received)
ERR :	Communication error	(transmitted)
	The unit will expect to receive the previous DAT.	

Roland®

10666

UPC

10666

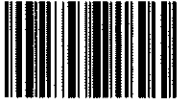

10901

Roland®