

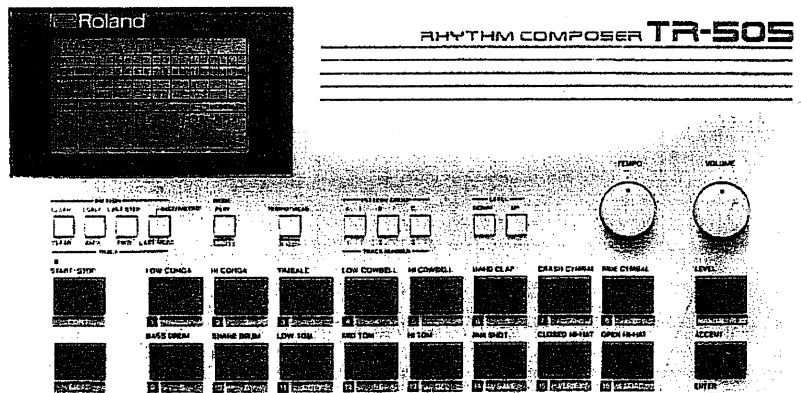

MIDI RHYTHM COMPOSER

TR-505

Owner's Manual



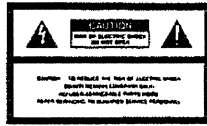

The lightning flash with arrowhead symbol, within an equilateral triangle, is intended to alert the user to the presence of un-insulated "dangerous voltage" within the product's enclosure that may be of sufficient magnitude to constitute a risk of electric shock to persons.

The exclamation point within an equilateral triangle is intended to alert the user to the presence of important operating and maintenance (servicing) instructions in the literature accompanying the product.

INSTRUCTIONS PERTAINING TO A RISK OF FIRE, ELECTRIC SHOCK OR INJURY TO PERSONS.

IMPORTANT SAFETY INSTRUCTIONS

WARNING When using electric products, basic precautions should always be followed, including the following:

1. Read all the instructions before using the product.
2. To reduce the risk of injury, close supervision is necessary when a product is used near children.
3. Do not use this product near water—for example, near a bathtub, washbowl, kitchen sink, in a wet basement, or near a swimming pool, or the like.
4. This product should be used only with a cart or stand that is recommended by the manufacturer.
5. This product, either alone or in combination with an amplifier and headphones or speakers, may be capable of producing sound levels that could cause permanent hearing loss. Do not operate for a long period of time at a high volume level or at level that is uncomfortable. If you experience any hearing loss or ringing in the ears, you should consult an audiologist.
6. The product should be located so that its location or position does not interfere with its proper ventilation.
7. The product should be located away from heat sources such as radiators, heat registers or other products that produce heat.
8. The product should avoid using in where it may be affected by dust.
9. The product should be connected to a power supply only of the type described in the operating instructions or as marked on the product.
10. The power-supply cord of the product should be unplugged from the outlet when left unused for a long period of time.
11. Do not tread on the power-supply cord.
12. Do not pull the cord but hold the plug when unplugging.
13. When setting up with any other instruments, the procedure should be followed in accordance with instruction manual.
14. Care should be taken so that objects do not fall and liquids are not spilled into the enclosure through openings.
15. The product should be serviced by qualified service personnel when:
 - A: The power-supply cord or the plug has been damaged; or
 - B: Objects have fallen, or liquid has been spilled into the product; or
 - C: The product has been exposed to rain; or
 - D: The product does not appear to operate normally or exhibits a marked change in performance; or
 - E: The product has been dropped, or the enclosure damaged.
16. Do not attempt to service the product beyond that described in the user-maintenance instructions. All other servicing should be referred to qualified service personnel.

SAVE THESE INSTRUCTIONS

WARNING

THIS APPARATUS MUST BE EARTH GROUNDED.

The three conductors of the mains lead attached to this apparatus are identified with color as shown in the table below, together with the matching terminal on the UK type power plug. When connecting the mains lead to a plug, be sure to connect each conductor to the correct terminal, as indicated.

"This instruction applies to the product for United Kingdom."

MAINS LEADS		PLUG
Conductor	Color	Mark on the matching terminal
Live	Brown	Red or letter L
Neutral	Blue	Black or letter N
Grounding	Green-Yellow	Green, Green-Yellow, letter E or symbol

Bescheinigung des Herstellers/Importeurs

Hiermit wird bescheinigt, daß der/die/ies

ROLAND RHYTHM COMPOSER TR-505

(Gerät, Typ Bezeichnung)

in Übereinstimmung mit den Bestimmungen der

Amtsbl. Vfg 1046 / 1984

(Amtsblattverfügung)

funk-entstört ist.

Der Deutschen Bundespost wurde das Inverkehrbringen dieses Gerätes angezeigt und die Berechtigung zur Überprüfung der Serie auf Einhaltung der Bestimmungen eingeräumt.

Roland Corporation Osaka / Japan

Name des Herstellers/Importeurs

RADIO AND TELEVISION INTERFERENCE

"Warning—This equipment has been certified to comply with the limits for a Class B computing device, pursuant to Subpart J of Part 15, of FCC Rules. Operation with non-certified or non-verified equipment is likely to result in interference to radio and TV reception."

The equipment described in this manual generates and uses radio-frequency energy. If it is not installed and used properly, that is, in strict accordance with our instructions, it may cause interference with radio and television reception.

This equipment has been tested and found to comply with the limits for a Class B computing device in accordance with the specifications in Subpart J, of Part 15, of FCC Rules. These rules are designed to provide reasonable protection against such a interference in a residential installation.

However, there is no guarantee that the interference to radio or television reception, which can be determined by turning the equipment on and off, the user is encouraged to try to correct the interference by the following measures:

- Disconnect other devices and their input/output cables one at a time. If the interference stops, it is caused by either the other device or its I/O cable.

These devices, usually require Roland designated shielded I/O cables. For Roland devices, you can obtain the proper shielded cables from your dealer. For non-Roland devices, contact the manufacturer or dealer for assistance.

If your equipment does cause interference to radio or television reception, you can try to correct the interference by using one or more of the following measures:

- Turn the TV or radio antenna until the interference stops.
- Move the equipment to one side or the other of the TV or radio.
- Move the equipment further away from the TV or radio.
- Plug the equipment into an outlet that is on a different circuit than the TV or radio. (That is, make certain the equipment and the radio or television set are on circuits controlled by different circuit breakers or fuses.)
- Consider installing a rooftop television antenna with shielded cable lead-in between the antenna and TV.

If necessary, you should consult your dealer or an experienced radio/television technician for additional suggestions. You may find helpful the following booklet prepared by the Federal Communications Commission:

"How to Identify and Resolve Radio-TV Interference Problems"

This booklet is available from the U.S. Government Printing Office, Washington, D.C. 20462, Stock No. 004-000-00341-4.

Please read the separate volume "MIDI", before reading this owner's manual.

Copyright © 1986 by ROLAND CORPORATION

All rights reserved. No part of this publication may be reproduced in any form without the written permission of ROLAND CORPORATION.

1 PANEL DESCRIPTION

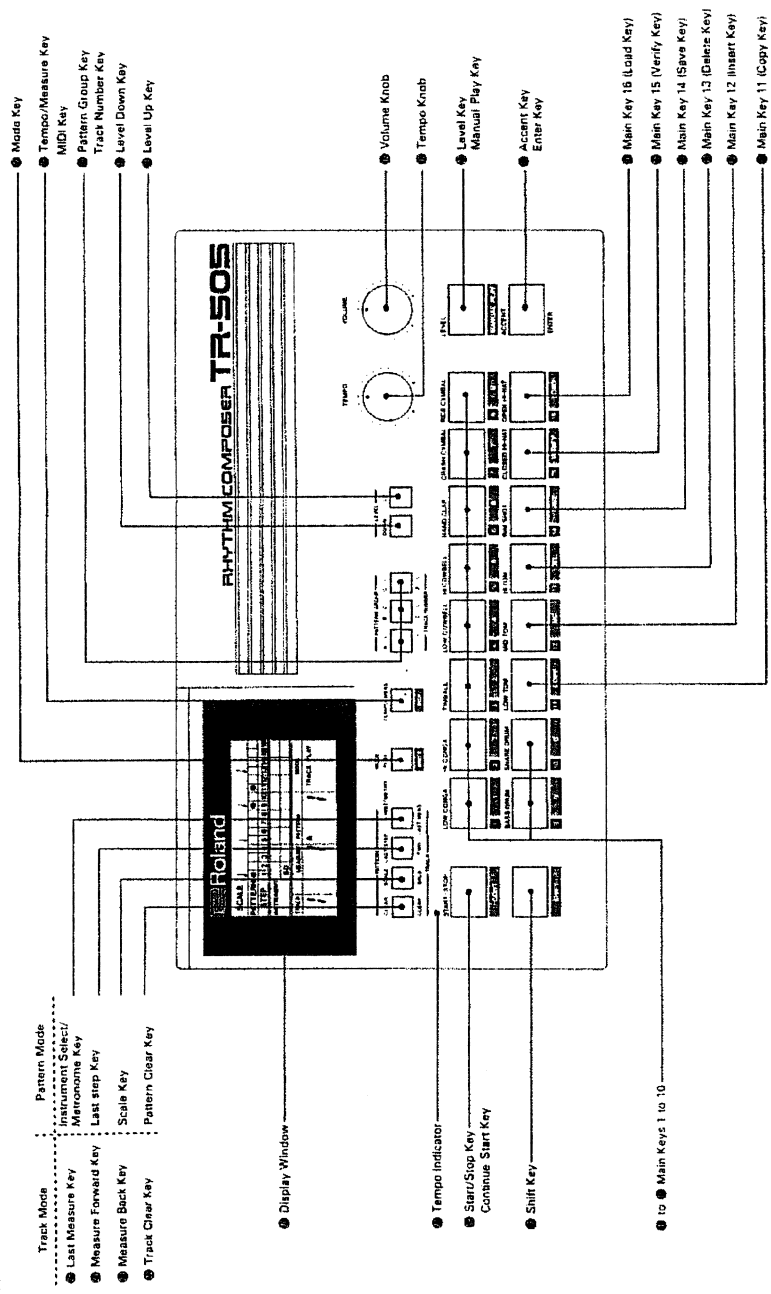

- Mode Key
- Tempo/Measure Key
- MIDI Key
- Pattern Group Key
- Track Number Key
- Level Down Key
- Level Up Key

- Volume Knob
- Tempo Knob
- Level Key
- Manual Play Key
- Accent Key
- Enter Key

- Main Key 16 (Load Key)
- Main Key 15 (Verify Key)
- Main Key 14 (Save Key)
- Main Key 13 (Delete Key)
- Main Key 12 (Insert Key)
- Main Key 11 (Copy Key)

- Track Mode
- Pattern Mode
- Instrument Select/
- Meronome Key
- Last Measure Key
- Measure Forward Key
- Measure Back Key
- Track Clear Key
- Scale Key
- Pattern Clear Key

- Display Window
- Tempo Indicator
- Start/Stop Key
- Continue Start Key
- Shift Key

- to ● Main Keys 1 to 10

- Stereo Out (R CH)/
- Monaural Out Jack
- Stereo Out (L CH) Jack
- Headphones Jack
- Start/Stop Jack
- Tape In/Out Jack

- Power Switch
- AC Adapter Jack
- MIDI IN Connector
- MIDI OUT Connector

CONTENTS

- 1 Panel Description 3
- 2 Outline of the TR-505 6
- 3 Connections 7
- 4 Operation 8
 - 1. Manual Playing 9
 - 2. Demonstration Program 10
 - 3. Playing the Preset Rhythm Patterns 12
 - 4. Volume Adjusting 14
 - 5. Track Writing and Playing 16
 - 6. Writing and Playing Rhythm Patterns 19
 - a. Before writing rhythm patterns 19
 - b. Stop Writing 20
 - c. Tap Writing 21
 - d. Pattern Playing 23
 - e. Block Playing 23
 - f. Continuous Start 23
 - 7. About Scale and Last Step 24
 - 8. Useful Functions in Pattern Writing Mode 26
 - a. Copying a Rhythm Pattern 26
 - b. Changing Patterns 27
 - 9. Other Useful Functions 28
 - a. Assigning a Bar 28
 - b. Delete 28
 - c. Insert 28
 - d. Copy 29
 - e. Playing Track from the bar you like 29
 - f. Last Measure 29
 - g. Start/Stop with the Pedal Switch 35
 - 10. Tape Interface 35
 - a. Saving 35
 - b. Verification 36
 - c. Loading 37
 - 11. MIDI 38
 - a. Setting MIDI Sync 39
 - b. Setting OMNI Mode 39
 - c. Changing the Receive Channels 39
 - d. Changing the Key Numbers 40
 - e. Changing the Transmit Channels 40
 - 12. Specifications 50

Important

- Operating the TR-505 near a neon or fluorescent lamp may cause noise interference. If so, change the angle of the unit.
- Avoid using the unit in excessive heat or humidity or where it may be affected by direct sunlight or dust.
- Use a soft cloth and clean only with a neutral detergent.
- Do not use solvents such as paint thinner.
- View the Display from the proper angle.
- Please be careful not to damage the window.

Initialization

After placing the batteries for the first time as shown in "Battery Replacement", be sure to initialize the TR-505 as follows.

Make sure that the TR-505 is turned off, then turn it on while holding the Mode Key **Ⓜ** and Pattern Group Key A **ⓐ** down.

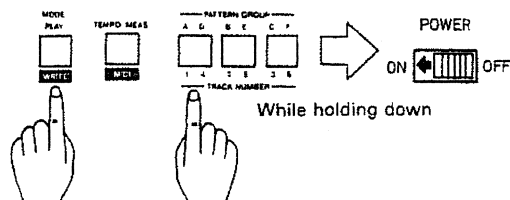

The above initializing procedure is not necessary when you replace the batteries later.

Memory Back-up

The TR-505 features memory back-up system that retains the data even when switched off. A set of batteries supports its back-up circuit.

Be sure to keep the batteries securely connected even during AC operation.

Always replace with a complete set of new batteries once a year no matter how rarely you have used the unit.

Change the batteries with the TR-505 switched off.

If the unit is not to be used for long periods of time, please save the data on a tape then switch it off and remove the batteries, otherwise various troubles may be caused by battery leakage.

Please observe the following "Battery Replacement".

Please be sure that the polarities of the batteries are correct.

When the Tempo Indicator's flashing is dimmer or the sound and action of the unit are unstable, immediately replace the batteries.

Initialization explained on page 2 is not necessary after replacing the batteries.

Battery Replacement

Please save the data in memory on a tape to prevent accidental loss of memory during battery replacement.

Use six 1.5V (UM-3) batteries.

① Make sure that the TR-505 is turned off.

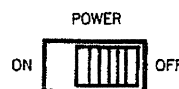

② Remove the battery cover on the bottom of the unit.

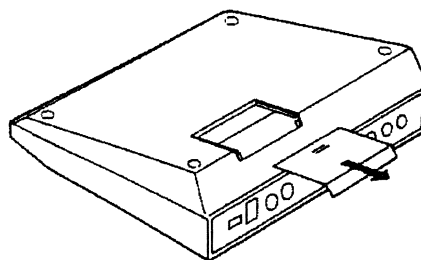

③ Remove the batteries from the battery case.

④ Place a new set of batteries taking care of the polarities.

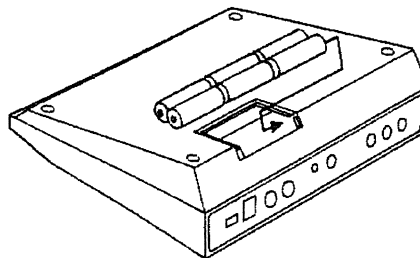

⑤ Replace the battery cover.

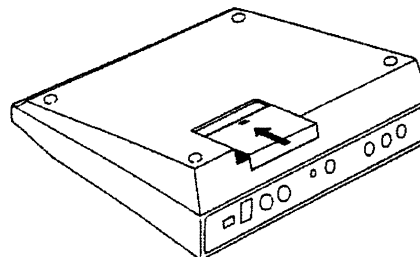

2 OUTLINE OF THE TR-505

The Rhythm Composer TR-505 is a fully programmable rhythm machine with 48 different rhythm patterns preprogrammed.

The 16 digital drum voices are a basic drum set and some Latin percussions, allowing wide variety of rhythms.

The TR-505 allows you to program 6 Rhythm Tracks or tunes (altogether 423 bars) from the 48 user-programmed and another 48 preset rhythm patterns.

There are two methods for programming a rhythm pattern; Step Writing in which we enter or load one step at a time without worrying about tempo, and Tap Writing that is programming a rhythm by actually tapping the Instrument Keys.

The large display window makes the operation easier.

The Tape Interface function makes it possible to save the data on a tape and later load it back.

The MIDI Connectors on the rear panel interfaces with other MIDI devices for syncing or using the TR-505 as a sound source.

3 CONNECTIONS

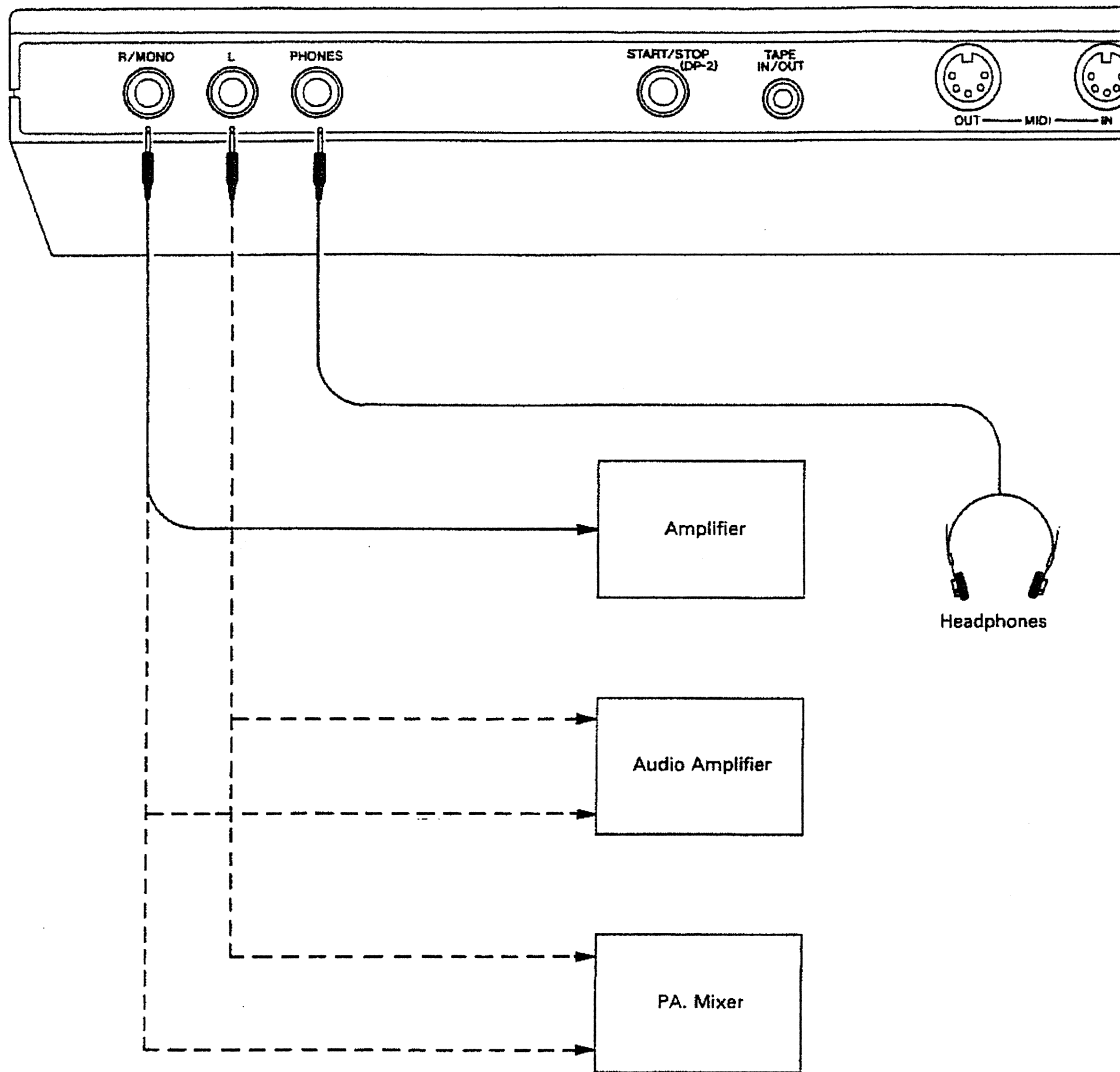

4 OPERATION

The TR-505 has the following modes.

- TRACK PLAY Mode plays a song or tune.
- PATTERN PLAY Mode plays a bar of rhythm pattern.
- TRACK WRITE Mode writes a song or tune.
- STEP WRITE Mode writes a bar of rhythm pattern (1)
- TAP WRITE Mode writes a bar of rhythm pattern (2)

The Display Window shows the mode in which the TR-505 currently is.

SCALE	J															
PATTERN	●															
STEP	1	2	3	4	5	6	7	8	9	10	11	12	13	14	15	16
INSTRUMENT	BD															
TRACK	MEASURE		PATTERN		MODE											
			A		TRACK PLAY PATTERN PLAY TRACK WRITE STEP WRITE TAP WRITE											

To change the modes, press the Mode Key (sometimes with the Shift Key held down.)

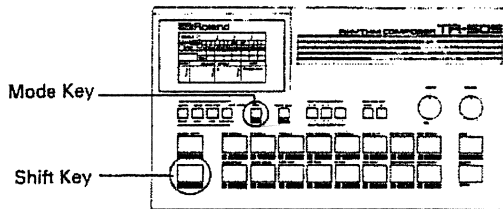

The picture below shows how the mode changes by pressing the Mode Key.

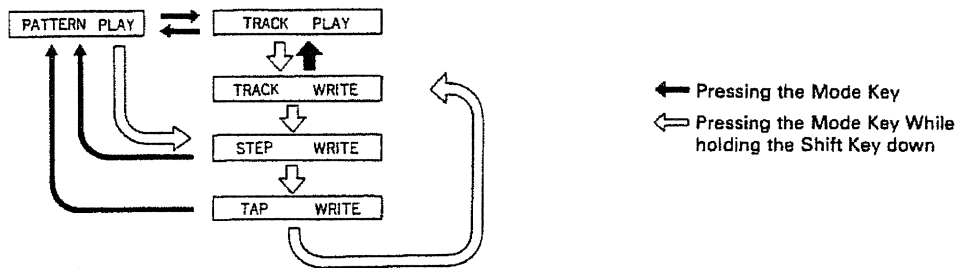

The modes do not change while the TR-505 is playing.

1. Manual Playing

With the composer connected to your amplifier or mixer, you are ready to try out a variety of sounds by playing it manually.

Switch it on. Make sure that the composer is in the Track mode (the Display shows TRACK PLAY). The Main Keys numbered ① to ⑩ have the drum voices marked above. Simply tap each key; all voices have different drum sounds. Also, if you tap the key with the Accent Key down, the created sound will take on accent.

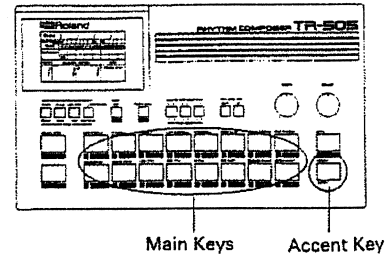

If the composer is not in the Track Play mode, push the Mode Key ④ as many times until the Display shows TRACK PLAY.

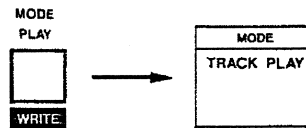

Summary of Drum Voices

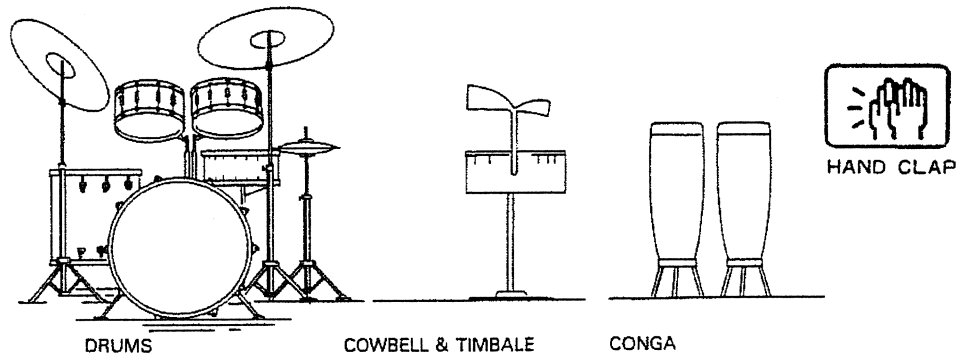

BASS DRUM(BD)
 SNARE DRUM(SD)
 LOW TOM(LT)/MID TOM(MT)/HI TOM(HT)/TIMBALE(TB)
 RIM SHOT(RIM)/HAND CLAP(HCP)
 OPEN HI-HAT(OH)/CLOSED HI-HAT(CH)
 LOW CONGA(LCG)/HI CONGA(HCG)
 LOW COWBELL(LCB)/HI COWBELL(HCB)
 CRASH CYMBAL(CC)/RIDE CYMBAL (RC)

The drum voices written in the same line cannot be played at the same time.

The letters in () are the abbreviation shown in the Display.

2. Demonstration Program

6 Tracks (6 songs) of sample program are stored in your composer. The procedure for initialization (see page 2) always restores the demo program.

How to play the demo program

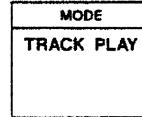

① Make sure that the Display shows TRACK PLAY.



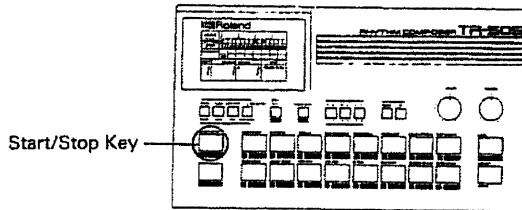

② Push the Start/Stop Key .

- The composer plays the demo program, and the Tempo Indicator blinks in the tempo of the music.

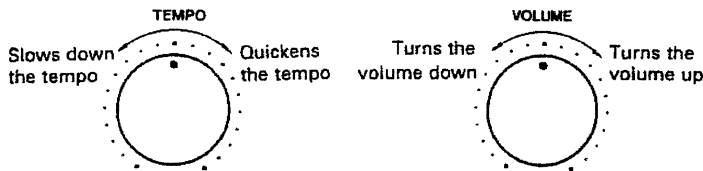

③ Adjust the tempo with the Tempo Knob , and the volume with the Volume Knob .



Each time you push the Tempo/Measure Key , the Display changes between the tempo and measure.

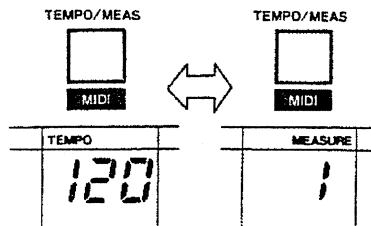

- When the song is played up, the first measure automatically returns.

④ To stop playing, push the Start/Stop Key **⏮** again.

⑤ To play other Track, push the relevant Track Number Key **⏮** as many times until the desired Track number is shown in the Display. Then repeat the steps ② to ④.

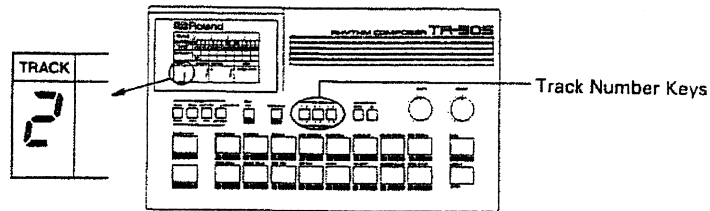

To select Track 1 or 4

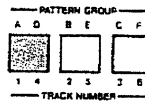

To select Track 2 or 5

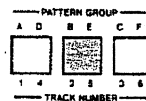

To select Track 3 or 6

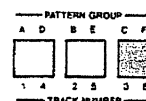

● Summary of the Demo Program



- Track 1 Latin rock mainly using the latin percussions
- Track 2 8 beat rock using the preset rhythm patterns
- Track 3 Shaffle using the preset rhythm patterns
- Track 4 4 beat jazz
- Track 5 Samba using the preset rhythm patterns
- Track 6 Reggae using the preset rhythm patterns

3. Playing the Preset Rhythm Patterns

In the TR-505 48 different rhythm patterns (one pattern is one bar phrase.) are preprogrammed. These rhythm patterns are divided into 3 groups A, B and C, and numbered 1 to 16.

As shown in "Preset Rhythm Patterns" on page 43 and in the separate book "Preset Rhythm Scores", select the rhythm you like.

- ① Without the composer playing, push the Mode Key  to turn to the Pattern Play mode. (The Display shows PATTERN PLAY.)

- In the Pattern Play mode, the Main Keys  to  work to select the pattern numbers 1 to 16.

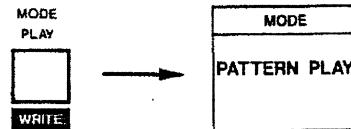



- ② Select the pattern group by pushing the Pattern Group Key  (A, B or C).

- The Display shows the pattern group you have selected.

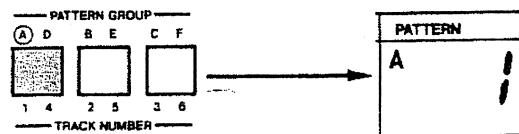
e.g.) Selecting the Pattern Group A



- ③ Select the pattern number by pushing the relevant Main Key ( to ).

- The Display shows the pattern number you have selected.

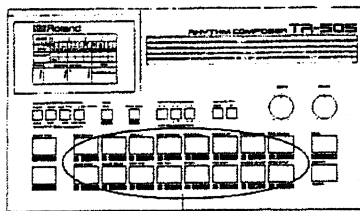

Main Keys

e.g.) Selecting the Pattern Number 2.

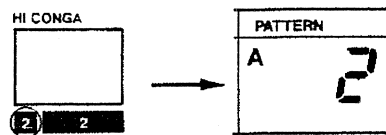

- ④ To play the rhythm pattern you have selected, push the Start/Stop Key 15.

Pushing the Tempo/Measure Key 26 will cause the Display to show the tempo of the music currently played.



- * Even during pattern playing, you can change the rhythm patterns. When a new pattern is selected, it will be played from the following measure.

- ⑤ To stop playing, push the Start/Stop Key 15.

• Manual Playing Mode

This mode enables you to add some more drum voices to the rhythm currently played by tapping the Instrument Keys (Main Keys 1 to 16).

- ① While holding the Shift Key 17 down, push the Manual Play Key 20.

The Display will respond with:

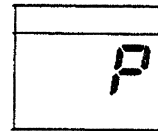
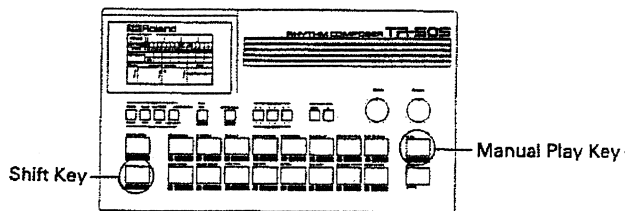

- ② Hit the Main Keys (1 to 16), and the relevant drum voices will sound. Also, hitting the keys while holding the Accent Key 18 will create the sound with accent.

- ③ If you wish to change the pattern numbers, turn the composer to the usual mode by pushing the Manual Key 20 while holding the Shift Key 17 down.

The Display now shows the group and the number of the rhythm pattern currently selected. This means that the Main Keys now work to change the pattern numbers.

- * The Manual Play Mode can be entered in any other mode. (When the composer is in the Track Play mode, this Manual Play is always available without taking any special procedure.)

4. Volume Adjusting

6 different volume levels are selectable for drum voices and also for the accent.

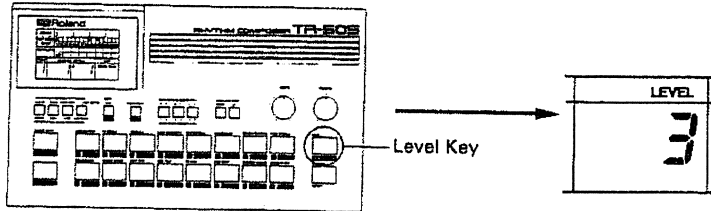

- ① Turn to the Level Setting mode by pushing the Level Key .

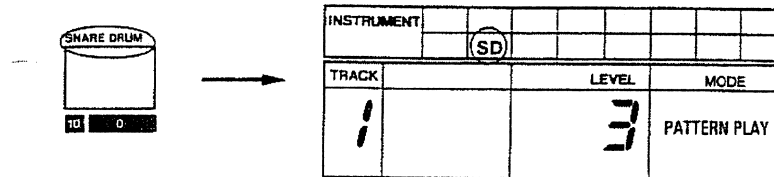

- ② Push the appropriate Main Key of the drum voice whose volume you wish to change.

The Display shows the name of the drum voice you have called and its volume. When the composer is not playing, the above operation will make the drum voice sound at the set volume.



- ③ To turn the volume up, press the Up Key , and to turn the volume down, press the Down Key . The 6 levels are 0 to 5, and at 0, there is no sound.

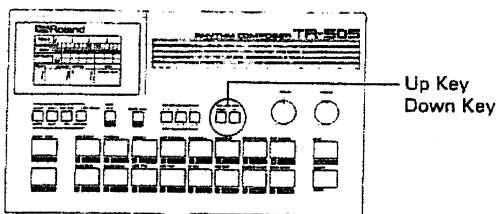

④ When the composer is not playing, you can hear what it sounds like by hitting the relevant Main Key.

⑤ If you do not like the volume you set, repeat the step ③ and ④.

⑥ Take the same procedures as ②, ③ and ④ for other voices.

⑦ To adjust the accent level, push the Accent Key then take the step ③.

The Display shows the current accent level.

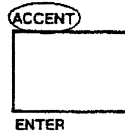

ACCENT			
TRACK		LEVEL	MODE
1		3	PATTERN PLAY

⑧ After adjusting all volumes of all the voices, push the Level Key to turn the composer to the usual mode.

* This Level Adjusting mode can be entered from any other mode.

5. Track Writing and Playing

The TR-505 is a fully programmable rhythm machine, that is, you can make a complete tune by using various rhythm patterns. In this manual we call this Track Writing. The composer allows you to make up to 6 Tracks (6 tunes).

[Track Writing]

Here, we write a track using only the preset rhythm patterns.



① Push the Mode Key  to turn to the Track Play Mode. (The Display shows TRACK PLAY.)

② Select the Track (1 to 6) which you wish to use.

If the composer is set to the Track Write mode, you cannot select the Track number.

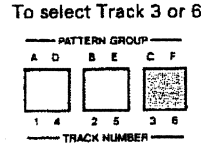
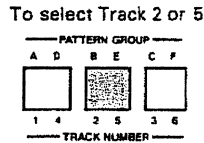
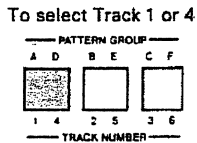
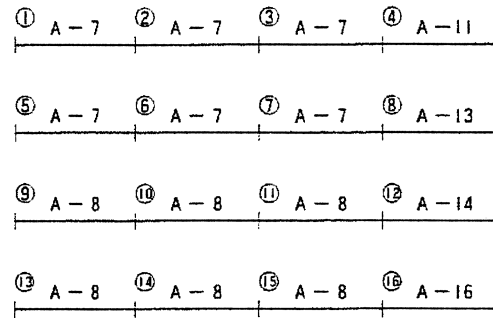

[Example score] 16 beat Rock

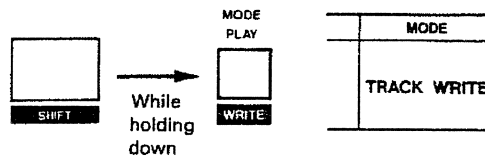

③ While holding the Shift Key  down, push the Mode Key  to turn to the Track Write Mode. (The Display shows TRACK WRITE.)

The Main Keys now work for selecting the pattern number (1 to 16).



④ To erase the data previously written in the Track, push the Enter Key  while holding the Track Clear Key  down.

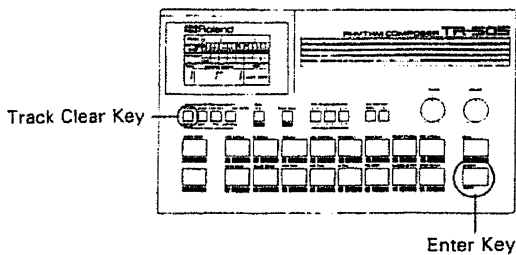

- ⑤ If you wish to monitor the rhythm patterns you are programming into a Track, push the Start/Stop Key **Ⓜ**.



- ⑥ Select the rhythm pattern to be played at the 1st bar. In this example score, A-7 (pattern group A, pattern number 7) should be selected.

- ⑦ Push the Enter Key **Ⓝ**.



The rhythm pattern A-7 is now written into the 1st measure.

The Display now shows the 2nd measure.

- ⑧ Select the rhythm pattern to be played at the 2nd bar. Here, it is the same as the one before (A-7), so skip and hit the Enter Key **Ⓝ**.
The 3rd bar is the same case as the 2nd bar.

- ⑨ The rhythm pattern to be played for the 4th bar is A-11, so assign the pattern number 11, then hit the Enter Key.

- ⑩ Write the 5th to 16th bars as above.

- ⑪ When you have written a wrong rhythm pattern, stop the composer, then go to the bar where you made a mistake by using the Measure Back key **Ⓜ** or Measure Forward Key **Ⓜ**, with the aid of the Display. Assign the correct rhythm pattern, then hit the Enter Key **Ⓝ**.

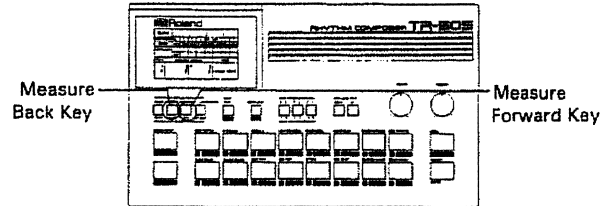

- ⑫ When you have completed to program up to the last bar, stop playing by pushing the Start/Stop Key.

[Track Playing]

Now, let's play the Track you have written.

- ① Push the Mode Key **Ⓜ** to turn to the Track Playing mode.

- ② Push the Start/Stop Key **Ⓜ**.

The composer plays the rhythm patterns from the first bar, and when plays up to the last bar, starts playing from the first bar again.

- ③ To stop playing, push the Start/Stop Key.

- * If you want to play the Track just once, write several blanks after the last bar of the Track, and push the Start/Stop Button while the blank bars are playing.

Track Editing

To replace a rhythm pattern with other one, turn the composer to the Track Writing mode, then take the step ⑪ on page 17. Also, if you wish to add some more measures of rhythm patterns, again select the Track Writing mode, and push the Last Measure Key ⑫ to go to the last measure (=17th measure in this example), then repeat the steps ⑤ to ⑪.

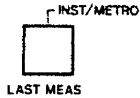

Total bar numbers of a Track

How many bars can be used for programming a Track depends on how many bars have been taken away for other 5 Track. Total of 423 bars are available for the 6 Tracks.

e.g. 1

Track Number	Bar Number
1	80
2	80
3	80
4	80
5	80
+} 6	23
Total	423

e.g. 2

Track Number	Bar Number
1	200
2	200
3	23
4	0
5	0
+} 6	0
Total	423

* In this example, no more bar can be written in the Tracks 4, 5 and 6.

- In other words, if all of the 423 bars are used for a single Track, no bar is left for writing other Tracks. When no bar is left, the Display will respond with as shown below. Therefore, if you wish to write a Track, you have to erase a whole Track or that many bars to make a space.

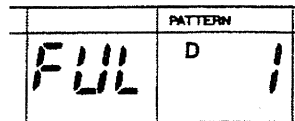

6. Writing and Playing rhythm Patterns



A pattern is a one bar phrase. We can write into memory a large number of patterns (up to 48) to recall later in any order we like, either manually or as a completely assembled track stored in memory. In practice, we will find it easier to write patterns in the same order we later assemble them into tracks, or complete tunes.

There are two ways of writing patterns.

- a - Step Writing, in which we enter or load one step at a time without worrying about tempo.
- b - Tap Writing, in which we write the rhythm pattern by tapping the Main Keys in time to a Rim shot produced every quarter-beat by the composer.

a. Before writing rhythm patterns

Before writing rhythm patterns either in the Step Writing or Tap Writing, take the following steps ① to ④.

- ① With the composer stopped, hold the Shift Key , and without releasing it, press the Mode Key  as many times until the Display shows STEP WRITE or TAP WRITE which you like.

- The Main Keys (1 to 16) here work to select Pattern Numbers.

- ② Push any of the Pattern Group Keys (D, E or F), select a Pattern Group.

The Display shows the pattern group you have selected.

- * Rhythm patterns have been preprogrammed in the Pattern Groups A, B and C and they cannot be edited or rewritten.

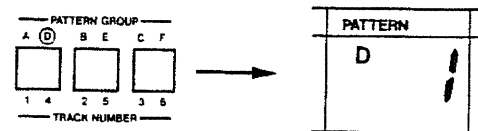

- ③ While holding the Pattern Clear Key  down, select the Pattern Number where you wish to write the rhythm pattern using the Main Key. This erases the rhythm pattern previously written.

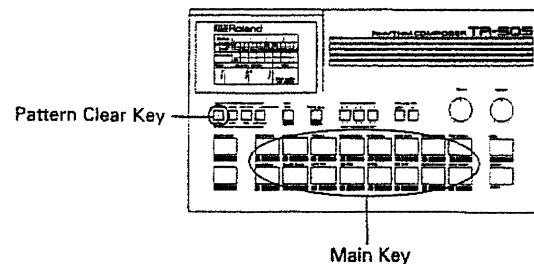

- ④ Go to the "Step Writing" on page 20 or "Tap Writing" on page 22.

b. Step Writing

Take the above procedures ① to ④, then write the rhythm pattern shown right.

The score can be modified as shown below for easier Step Writing.

> = Accent

CLOSED HI-HAT

HI-HAT

SNARE DRUM

BASS DRUM

● - Where the sound is output

CLOSED HI-HAT

SNARE DRUM

BASS DRUM

ACCENT

SCALE	J	J	J	J												
PATTERN	●	●	●	●												
STEP	1	2	3	4	5	6	7	8	9	10	11	12	13	14	15	16
INSTRUMENT																CH

SCALE	J	J	J	J												
PATTERN																
STEP	1	2	3	4	5	6	7	8	9	10	11	12	13	14	15	16
INSTRUMENT																SD

SCALE	J	J	J	J												
PATTERN	●															
STEP	1	2	3	4	5	6	7	8	9	10	11	12	13	14	15	16
INSTRUMENT																BD

SCALE	J	J	J	J												
PATTERN	●															
STEP	1	2	3	4	5	6	7	8	9	10	11	12	13	14	15	16
ACCENT																

① Push the Start/Stop Key ①.

● The Tempo Indicator flashes.

② To write the rhythm of the Bass Drum, press the Main Key (Bass Drum) while holding the Instrument Selector Key ② down.

The Display shows BD (Bass Drum). Here, regard the 16 Main Keys as an entire bar, and push the corresponding Main Keys where you wish to write the Bass Drum sound.

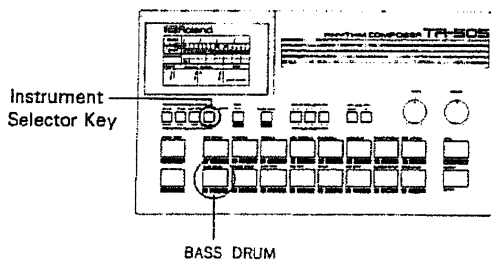

INSTRUMENT																
	BD															

- ③ We want the drum voice at the steps (positions) 1, 8, 9 and 11, so push the Main Keys 1, 8, 9 and 11.

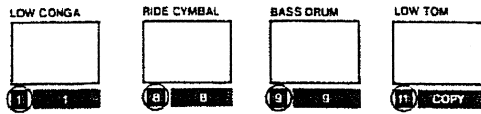

In the Display, "●" is shown where the drum voice is written.

- * If you have written a voice at a wrong step (position), simply press the same Main Key. Also, to erase the entire sound currently selected, keep pressing the Clear Key ⑫ until no sound of that voice is heard.

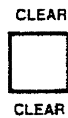

- ④ Go to the Snare Drum by pushing the Snare Drum of the Main Key while holding the Instrument Selector Key ⑬ down.

- ⑤ We want the snare drum at the steps 5 and 13, so push the Main Keys 5 and 13.

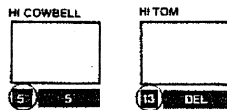

- ⑥ Take the similar procedure for the Closed Hi-hat.

- ⑦ To go to the Accent Writing mode, push the Accent Key ⑭ while holding the Instrument Selector Key ⑬ down.

The Display shows ACCENT, and the Main Keys now work to write accents.

- ⑧ We want the accents at the steps 1, 5, 9 and 13, so push the Main Keys 1, 5, 9 and 13.

- ⑨ Now, we have completed writing the example score. Push the Start/Stop Key ⑮, and the composer stops playing.

- ⑩ To write more rhythm patterns, repeat the steps ① and ② in "Before start writing", then Step Writing procedure.

- ⑫ To play the rhythm pattern you have written, go to "Pattern Playing Mode" on page 23.

c. Tap Writing

After taking the procedure of "Before start writing" on page 19, go to the following Tap Writing operation.

This is writing a rhythm pattern by tapping the Main Keys to the metronome.

① Push the Start/Stop Key .

- The Tempo Indicator flashes in the tempo you have set.

If the metronome sound is not heard here, push the Instrument Selector Key , and the metronome (crochet rim shot) will be heard with the accent at the head of the bar.

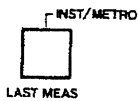



② Tap the Main Keys to the rim shot to make a rhythm pattern you like.

In the same way as above, write accents by tapping the Accent Key .

If you wish to tap the Main Keys without writing into the memory, turn the composer to the Manual Play mode.

The shortest note here is a 16th note, and if you tap too slowly or quickly, it will be automatically written in the exact tempo of the 16th note.

To stop the metronome, push the Instrument Selector Key .

- * If you wish to see a certain voice of the rhythm you have written in the Display, press the Main Key of that voice while holding the Instrument Selector Key  down.

- * If you make an error while the rhythm is running, hold down the Clear Key , and without releasing it, push the Main Key of that voice until that voice has disappeared.

③ When you have finished writing, push the Start/Stop Key , and the composer stops writing and playing.

Even while rhythm is running, you can change from Step Writing mode to Tap Writing mode or from the Tap Writing to the Step Writing, simply by pushing the Mode Key. So, if you have made an error in Tap Writing mode, you can immediately turn the composer to the Step Writing mode and correct the error without affecting any other part of the pattern data. To the contrary, you can add a more complicated rhythm in the Tap Writing mode to the rhythm pattern written in the Step Writing mode.

If you wish to write more rhythm patterns, take the steps ② and ③ in "Before start writing" on page 19, then repeat the Tap Writing operation. To play the rhythm pattern you have written, go to "Pattern Playing Mode" on page 23.

[NOTE]

If the drum voices listed on the same line on page 9, — Summary of Drum Voices are written into the same step, the one previously written will be erased. For instance, writing closed hi-hat over the open hi-hat will automatically erases the open hi-hat, the closed hi-hat taking over the place.

d. Pattern Playing

How to play the rhythm pattern you have written

- ① With the composer stopped, push the Mode Key  to turn to the Pattern Playing mode.

- ② Push the Pattern Group Key  as many times until the Display shows the pattern group of the rhythm you wish to play.

When the desired pattern group is already shown in the Display, you can skip this step.

- ③ Assigning the pattern number of the rhythm you wish to play.

When the desired pattern number is already shown in the Display, you can skip this step.

- ④ Push the Start/Stop Key .

The selected rhythm will be played repeatedly.

While the rhythm is playing, you can change the pattern groups and pattern numbers at any time.

- ⑤ To stop the rhythm, push the Start/Stop Key.

Editing Rhythm Pattern



Turn the composer to the Step Writing or Tap Writing mode, and take the procedures of correcting errors or writing. No need to erase the rhythm pattern and write it again.

e. Block Playing

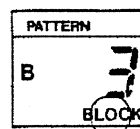
Adjacent rhythm patterns can be played in sequence. We call this Block playing. To play pattern 1 to 5 in sequence, push the Main Keys 1 and 5 together during the procedure ③ of Pattern Playing, and the Display will show BLOCK. The patterns 1 to 5 will be played by pushing the Start/Stop Key.



f. Continue Start

The TR-505 allows you to start playing the rhythm pattern from where it was stopped. Push the Start/Stop Key  while holding the Shift Key  down.

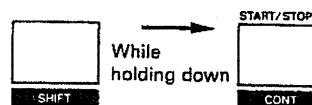

7. About Last Step and Scale

The default setting is 4/4 time. That is, whenever a rhythm pattern is erased, the TR-505 automatically selects 4/4 time. This can be always seen in the Display.

SCALE																
PATTERN																
STEP	1	2	3	4	5	6	7	8	9	10	11	12	13	14	15	16

The above picture shows that four steps are assigned to a quarter note, this means that a step is a sixteenth note. In this case, it is not possible to write a rhythm pattern with thirty-second notes or shuffle or swing which use triplets. To solve this problem, the TR-505 features 4 different scales.

SCALE																
PATTERN																

1 Step consists of



SCALE																
PATTERN																

1 Step consists of



SCALE																
PATTERN																

1 Step consists of



SCALE																
PATTERN																

1 Step consists of



= (a quarter note)

Selecting a scale

① Make sure that the composer is stopped and in the Step Writing or Tap Writing mode.

② Push the Scale Key  as many times until the Display shows the scale you want.



How to set the last step

Select the preset rhythm C-15 (Waltz), and the Display responds with :

SCALE															
PATTERN															
STEP	1	2	3	4	5	6	7	8	9	10	11	12			

See the Step in the Display. It has only 12 steps. This means that the rhythm will be played up to the 12th steps, then returns to the first step. That is, this is the rhythm of 3/4 time. The preset rhythms B-1 to B-16 also need 12 steps.

The number of the steps can be changed, which we call "setting the last step".

① Make sure that the composer is stopped and in the Step Writing or Tap Writing mode.

② While pushing the Last Step Key  down, set the step number needed for your rhythm by pushing the appropriate Main Key (1 to 16).

The Display Window shows the step number you have set.

e.g.) Setting the Last Step to 12.

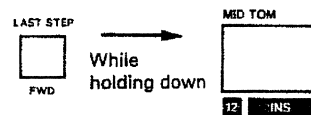

8. Useful Functions in Pattern Writing Mode

a. Copying a Rhythm Pattern

A rhythm pattern can be copied from one memory location to another. After copying, the pattern will remain in its original location as well as appearing in the new location you have chosen. This function is useful for when writing several similar rhythm patterns or changing the order of the patterns.

- ① Make sure that the composer is not playing.
- ② Enter the Step Writing or Tap Writing mode.
- ③ Assign the new location (pattern number) which your pattern is copied to, by using the Pattern Group Button  and the Pattern Number Button (Main Key 1 to 16).
- ④ While holding the Shift Key down, push the Copy Key (Main Key 11), and the Pattern Group Button and the Pattern Number assigning your source pattern, then the Enter Key.

Example Operation

Copying Preset Rhythm A-5 to D-1.

Assign the pattern group (D) and the pattern number (1).

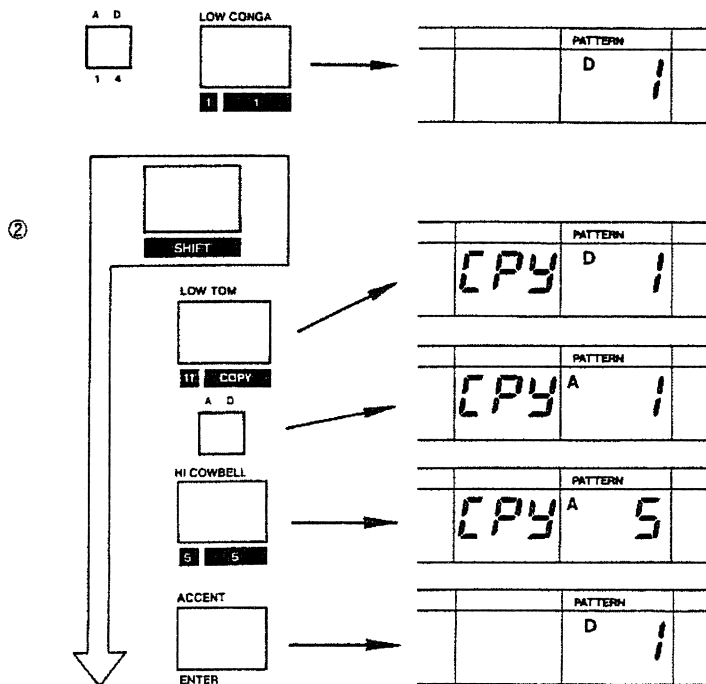

It is not possible to copy the chained patterns altogether at a time. You need to copy the pattern one by one, then chain the patterns. (See page 27.)

b. Chaining Patterns

The Chaining function allows two or more patterns to be chained together so that they are played as one. This is useful for any rhythm pattern consisting of more than 16 steps (e.g. 1 step = $\frac{1}{8}$ or odd times such as $\frac{5}{4}$ or $\frac{7}{8}$).

- ① Make sure that the composer is not playing.
- ② Enter the Step Writing or Tap Writing mode, and select the pattern group by using the Pattern Group Button.
- ③ Hold down the Main Keys that belong the first and the last pattern numbers to be chained, and while still holding these, push the Enter Key ⏏ .

The Display shows CHAIN.

To drop a pattern from the Chain, hold the relevant Main Key down, and push the Enter Key ⏏ .

- This Chain function naturally is available for the adjacent patterns.
- When one of chained rhythm patterns is erased, the Chain itself will disappear.

Sample Score

Pattern 1	Pattern 2	Pattern 3
Scale = ♩	Scale = ♩	Scale = ♩
Last Step = 8	Last step = $\frac{6}{8}$	Last step = 4

In the above score, the third beat is $\frac{1}{16}$ triplet, therefore a rhythm cannot be made in one pattern. To solve this problem, divide the rhythm pattern into 3 patterns; 1, 2 and 3, then set the scale and last step of each pattern. Write these patterns then chain them into one pattern.

9. Other Useful Functions

[Track Editing]

You may find on listening to your Track, that you have made an error. The TR-505 allows you to replace the wrong pattern in a certain bar with a correct one, add or delete patterns, etc. This editing function, however, requires you to assign the bar number correctly.

a. Assigning a Bar

There are two methods for assigning a bar number. One is by using the Back Key and Forward Key, and other is by using the Number Keys (Main Keys).

Using the Back and the Forward Keys

Push the Forward Key  which advances one bar at a time as many times until you come to the right bar.

Push the Back Key  which backs up one bar at a time, as many times until you come to the right bar.

Using the Number Keys (Main Keys 0 to 9)

Assign the bar number by holding the Shift Key down while punching the bar number on the Main Keys 0 to 9 (press 1 and 6 for bar number 16), and push the Enter Key.

b. Delete

You can delete any pattern or series of patterns from a Track. To delete a sequence of patterns, you assign the first and last bars of the sequence before removing them from the Track.

① Enter the Track Writing mode.

② While holding the Shift Key down, assign the first bar number you want to delete by using the Main Keys.

③ While holding the Shift Key down, push the Delete Key (Main Key 13), assign the last bar number to be deleted, then the Enter Key. (This is the same operation as shown on page 30.)

To delete up to the end of the Track, instead of assigning the last bar number, push the Last Measure Key  (with the Shift Key down, push the Delete, Last Measure then Enter). (Refer to the example shown on page 31.)

To delete a single bar, while holding the Shift Key down, push the Delete, then the Enter. (Refer to the example shown on page 32.)

c. Insert

You can insert any single pattern or block of patterns into a Track.

① Enter the Track Writing mode.

② Assign the bar number after which you wish to insert a pattern, by pushing the appropriate Main Key while holding the Shift Key down.

③ Select the pattern you wish to insert by using the Pattern Group Key  and the Main Key.

④ While holding the Shift Key down, push the Insert Key (Main Key ) , then the Enter Key. (Refer to the example shown on page 33.)

* You can also insert a block of patterns. Assign the first and the last pattern numbers of the block by pushing the relevant Main Keys at a time.

d. Copy

You can copy a sequence of rhythm patterns you have written in a Track.

- ① Enter the Track Writing mode.
- ② Assign the bar number from which you wish the new patterns to begin, by holding the Shift Key down while pushing the appropriate Main Key, then push the Enter Key.
- ③ While holding the Shift Key down, push the Copy (Main Key 11), the appropriate Main Keys (0 to 9) assigning the starting bar number, the Enter Key, and the ending bar number, then the Enter Key. Be sure that all are done while the Shift Key is being held down. (Refer to the example copy on page 34.)

- * You cannot copy to the bar number that is included in the sequence of the bars to be copied. For example, you cannot copy bars 5 to 10 to the bar 9.
- * You cannot copy the bars in a Track to a different Track.

NOTE

When you have taken a wrong operation, the Display responds with:

TRACK		PATTERN	MODE
	- - - -	D	PATTERN PLAY

Repeat the copying procedure correctly.

[Functions in Track Playing Mode]

e. Playing Track from the bar you like

- ① Call the bar from which you wish the Track to play, as shown in "a. Assigning a Bar" on page 28.
- ② Push the Start/Stop Key **⏮** while holding the Shift Key **⇧** down.

The Track will play from the bar you have assigned.

f. Last Measure

When the composer is stopped, hold the Last Measure Key **⏮** down. The last bar number of the Track currently selected and its rhythm pattern are shown in the Display.

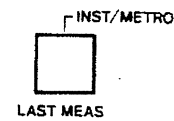

[Functions available in any mode]

g. Start/Stop with the Pedal Switch

Connect the pedal switch as shown below, and the composer can be started or stopped by pressing the pedal.

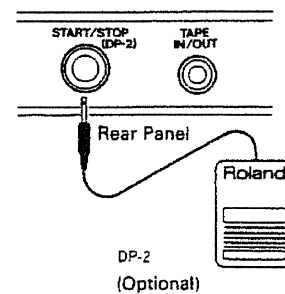

Example Delete

- To delete 21st to 24th bar.

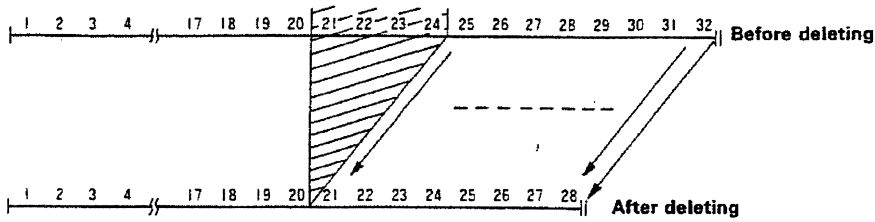

- ① Recall the 21st measure (Bar Assign).

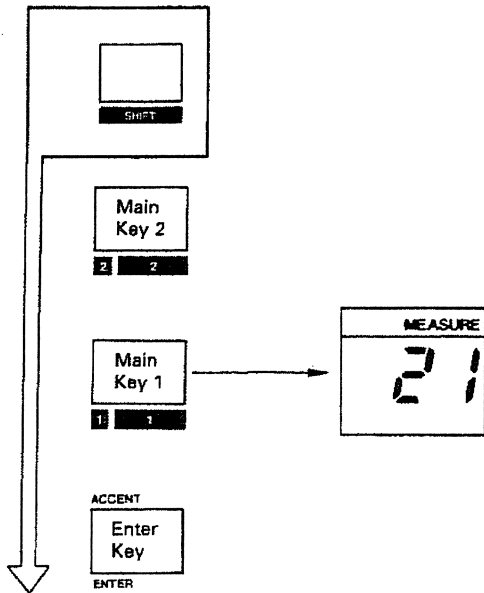

- ② Take Delete procedure and delete up to 24th bar.

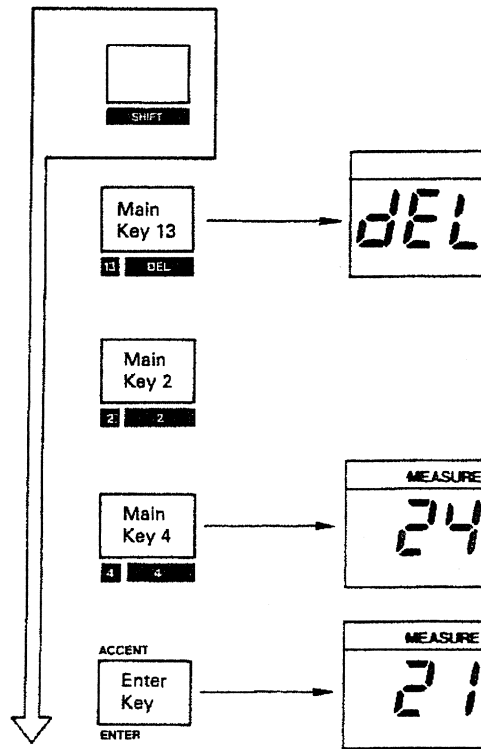

- To delete 25th to the last bar.

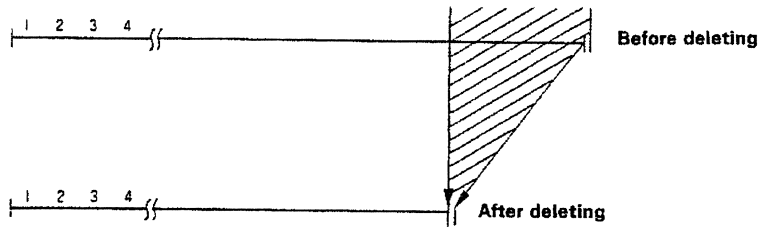

- ① Recall the 25th bar.

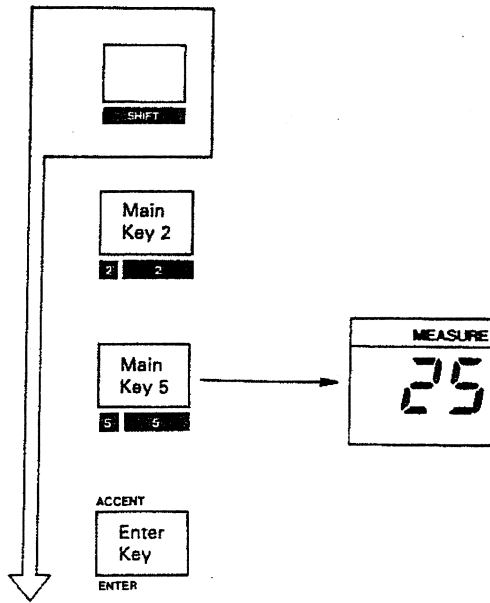

- ② Delete up to the last bar.

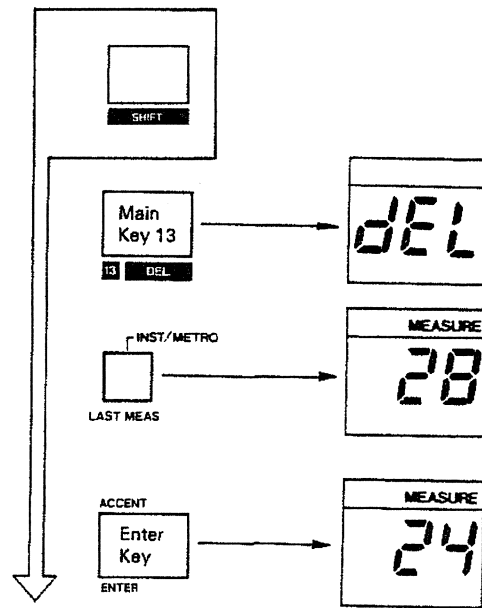

● To delete only 19th bar.

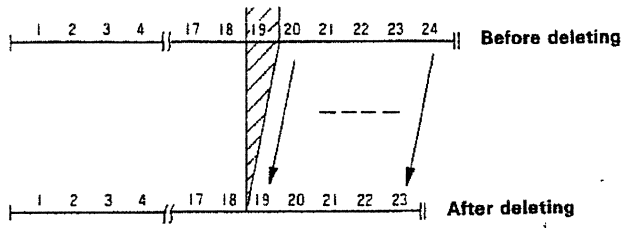

① Recall the 19th bar.

② Take Delete procedure.

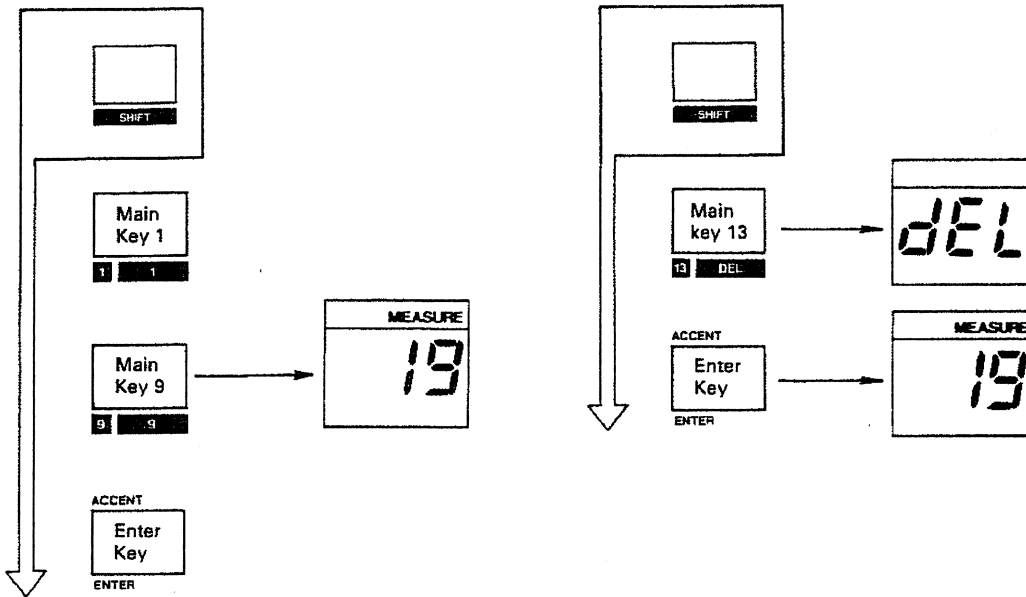

Example Insert

- To insert a Rhythm Pattern into the 3rd bar.

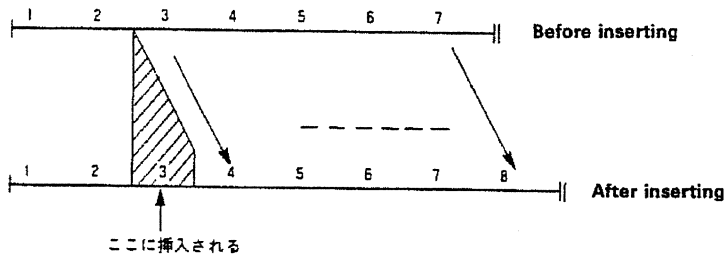

① Recall the 3rd bar.

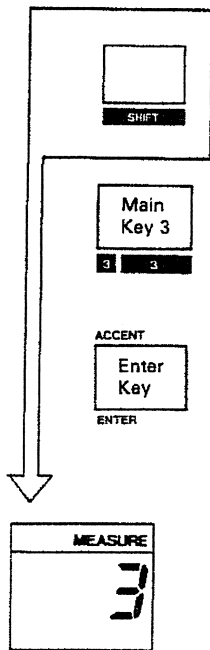

② Select the Rhythm Pattern (Pattern Group, Pattern Number).

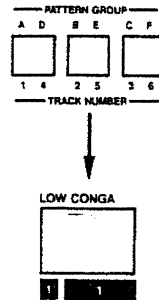

③ Take insert procedure.

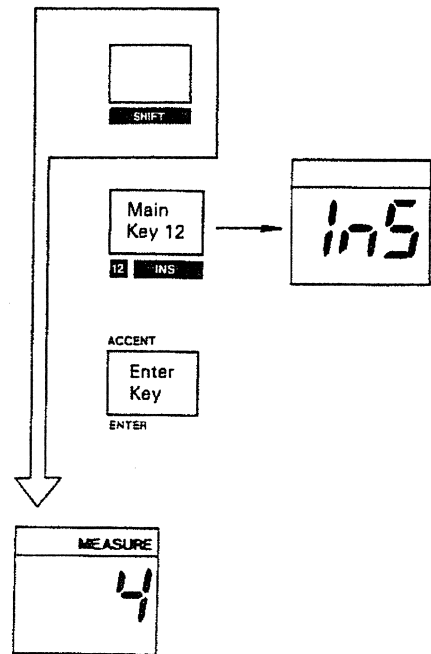

Example Copy

- To copy 13th to 16th measures into the 19th measure.

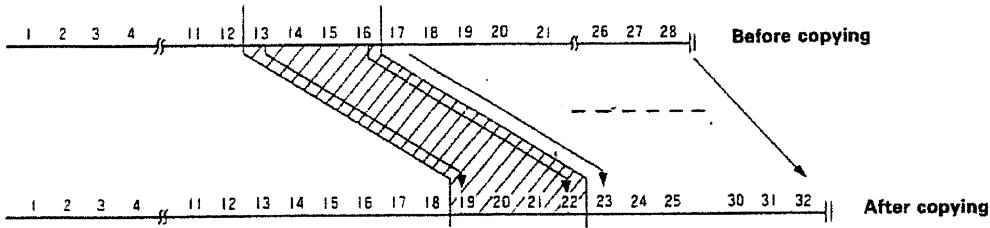

① Recall the 19th bar.

② Take copy procedure and copy 13th to 16th bar.

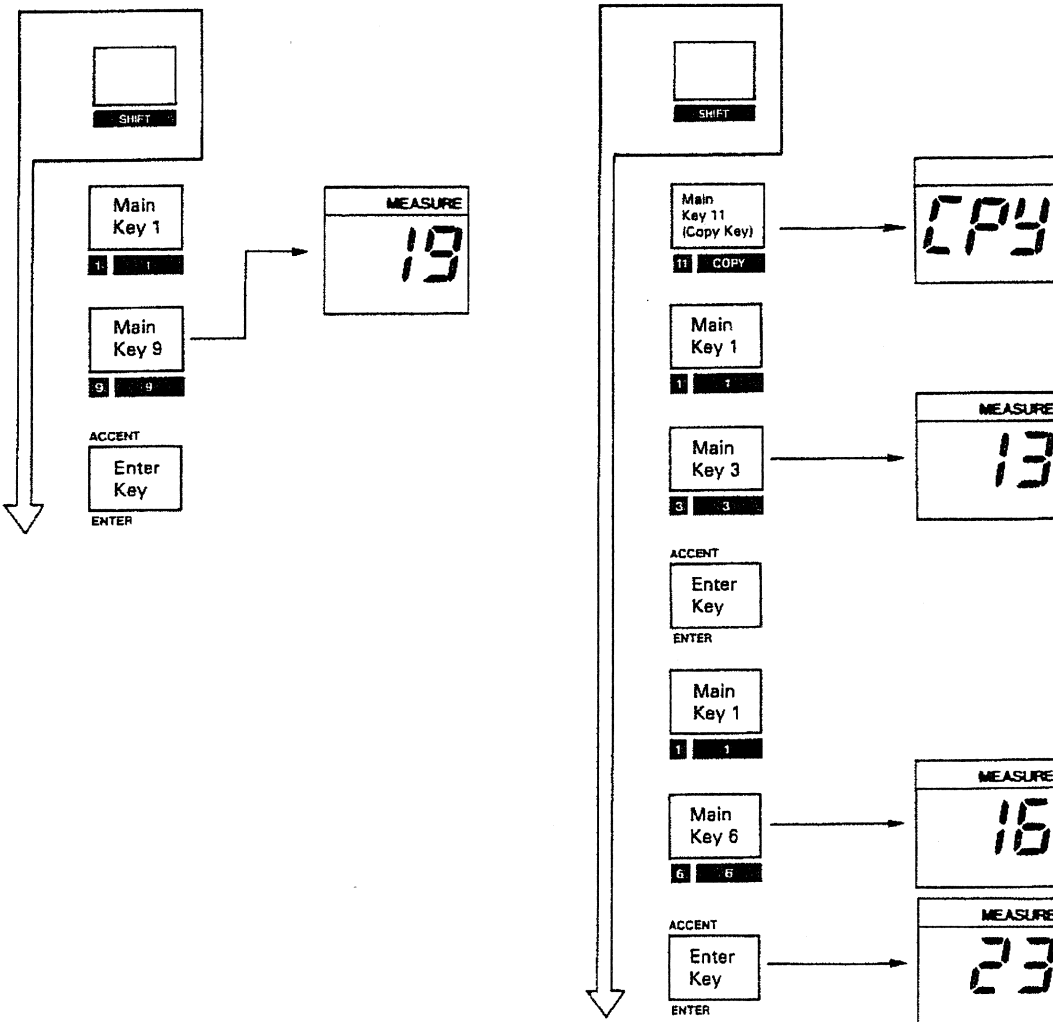

5 TAPE INTERFACE

The TR-505's Tape Interface allows the Tracks and Patterns written into memory to be stored on a tape.

If saving cannot be done after all, use a different tape recorder.

It may be a good idea to verify if the data has been successfully saved every time to prevent the loss of important data. The data saved on a tape can be loaded back to the TR-505 at any time you like.

All the saving, verification and loading procedures should be done with the composer set to the Track Playing mode and stopped.

a. Saving

First of all, connect the tape recorder and the composer as shown below.

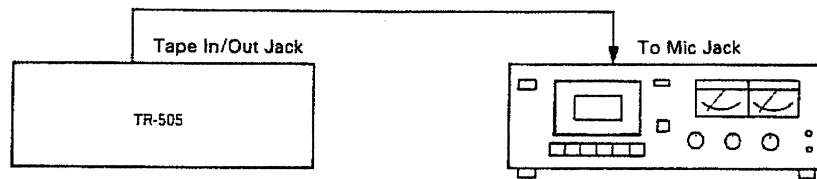

① Start the tape recorder on record.

② While holding the Shift Key (⌘) down, press the Save (Main Key 1), then the Enter Key.

The Display responds with as below showing that it is now in the saving mode.

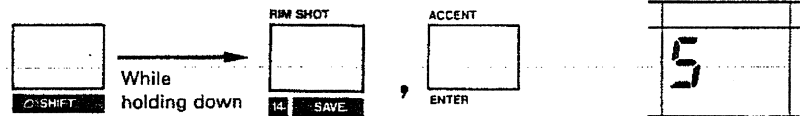

③ When the saving sign in the Display disappears from the Display, stop the tape recorder.

For about 5 seconds after the Enter Key is pressed, the Pilot tone is heard, then it is followed by the modulated tone which carries the data.

- To stop saving during the saving, push the Main Key 1.

To ensure if the data has been properly saved, go to the Verification on the next page.

b. Verification

Change the connection of the tape recorder and the composer to as shown below. (The same jack is used on the TR-505.)



① Play back the tape, and start the tape recorder from where you hear the pilot tone.

② While holding the Shift Key (SHIFT) down, push the Verify Key (Main Key 15), then the Enter Key.

• On pressing the Verify Key, the display responds with:

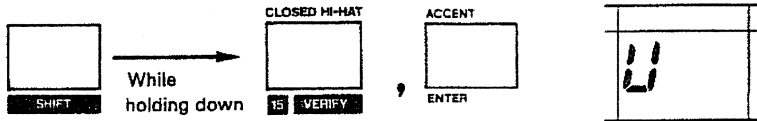

When verification starts, the Tempo Indicator lights up.

• To stop verification during verifying, push the Main Key 1.

• When the saving has not been properly done, error indication as shown below will appear in the Display.

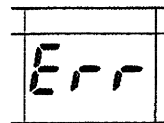

If this happens, stop the tape recorder, and repeat the verification with a different volume setting.

If the error indication still remains no matter how many times you try, repeat saving procedure. If it is still not remedied, try saving with a different tape recorder.

c. Loading

Connect the composer and the tape recorder in the same way as verification.

- ① While playing back the tape, and wind back the tape to the start of the pilot tone, then stop the tape recorder.
- ② Start the tape recorder on play.
- ③ While holding the Shift Key  down, push the Load Key (Main Key 16), then the Enter Key.

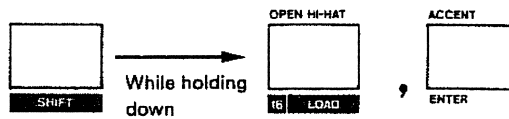

On pressing the Load Key, the Display responds with:

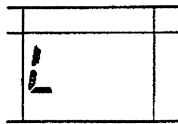

When loading starts, the Tempo Indicator lights up.

- To stop loading during loading, push the Main Key 1.

6 MIDI

The TR-505 has two MIDI Connectors, IN and OUT. (See the separate volume "MIDI"). If the composer is connected through its MIDI OUT to another instrument's MIDI IN, then the composer will control that instrument, and vice-versa.

The TR-505 can transmit and receive the following MIDI messages.

1. Trigger signal for the individual voice. (Key message is used.)
2. Track Number (Song Select) message
3. Bar Number (Song Position Pointer) message
4. Synchro signal such as Tempo Clock, Start/Stop, etc.

MIDI Key

When the composer is stopped, push the MIDI Key **M** while holding the Shift Key **S** down. Each time you push the MIDI Key, the MIDI function and its setting shown in the Display change as shown below; MIDI Sync On/Off, OMNI Mode On/Off, Receive MIDI channel number 1 to 16, Key number of the drum voice 25 to 99, Transmit MIDI channel number of the drum voice 1 to 16.

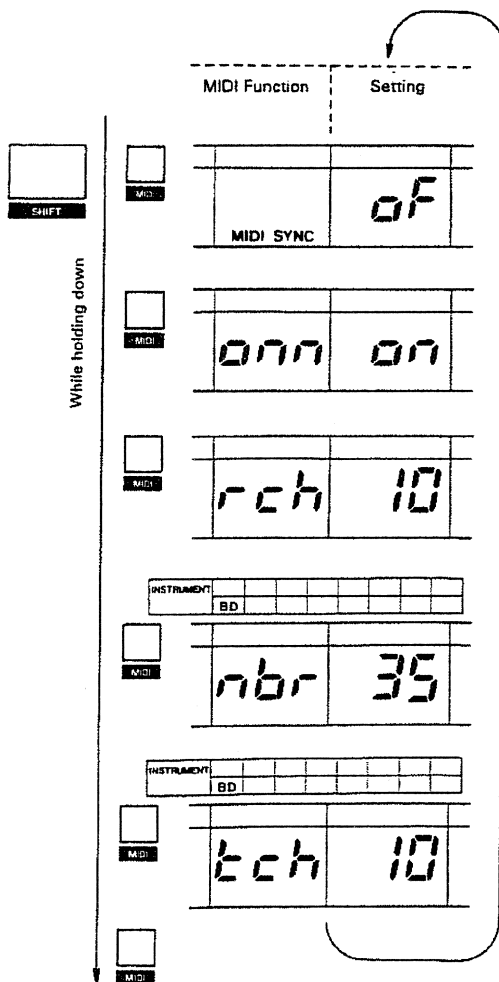

- MIDI Sync
 - on : Syncs to external device
 - of : Does not sync to external device
- OMNI Mode
 - on : Receives the Messages of all the Channels.
 - of : Receives the message of the set receive Channel.
- Receive Channel Number

In this example : Channel 10 is selected.
- Key Number of the drum voice

In this example : Key number of Bass Drum = 35

To see the Key number of other drum voice, push the corresponding Main Key.
- Transmit Channel of the drum voice

In this example : Transmit channel of Bass Drum = 10

To see the transmit channel of other drum voice, push the relevant main Key.

To change the Setting of each MIDI function, call the MIDI function whose setting you wish to change, and go to the relevant procedure (following a to e) WITH THE SHIFT KEY STILL HELD DOWN.

The MIDI functions you have set will be retained even when the composer is switched off.

a. Setting MIDI Sync

If you wish to control the TR-505 with the sync signal from the external device, push the Up Key **⬆**, and if not, push Down Key **⬇**.

When this MIDI Sync is set to ON, the TR-505 is controlled by the sync signal of the external device. This can be understood by the indication in the Display as shown right.

b. Setting OMNI Mode

OMNI ON mode makes the receiver recognize voice messages in all channels without discrimination. To select this OMNI ON mode, push the Up Key **⬆**. To select the OMNI OFF mode which makes the receiver recognize the messages exclusively in the set receive channel, push the Down Key **⬇**.

c. Changing the Receive Channels

To change to the MIDI channel number higher than the current one, push the Up Key **⬆**, and to decrease the number, push the Down Key **⬇**. (CH 1 to 16 are available.)

With the Display still showing the function.

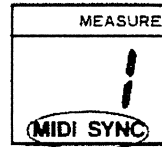
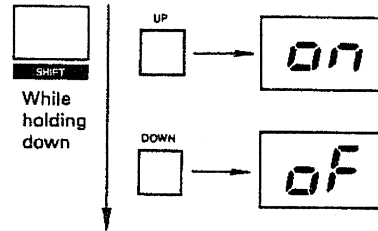

With the Display still showing the function.

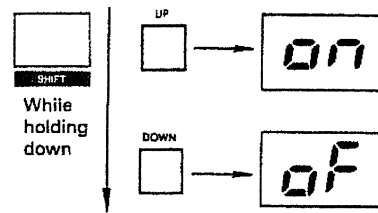

With the Display still showing the function.

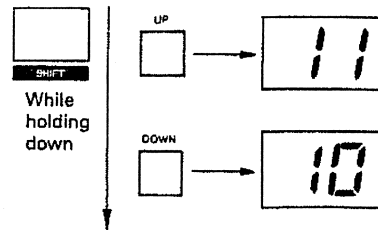

d. Changing the Key Numbers (Assigning Key Numbers to the Composer's Drum Voices)

The key number assigned to each drum voice is for both transmitting and receiving. Any key number can be assigned to each drum voice later, but let's see the initial setting from the manufacturer.

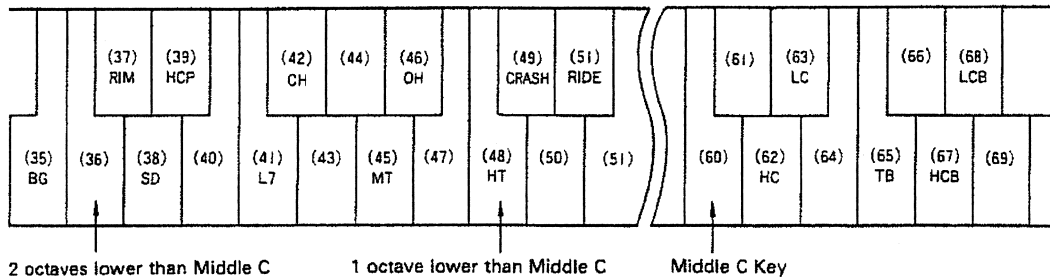

How to assign a key number to a drum voice on the composer:

- ① Push the Main Key that corresponds to the drum voice whose key number you wish to change.

The Display shows the selected drum voice and the key number currently assigned.

- ② To change the key number to the higher number than the current one, push the Up Key \uparrow , and to decrease the number, push the Down Key \downarrow .
(The lowest number: 25, the highest: 99)

e. Changing the Transmit Channels (of the Drum Voices)

A transmit channel can be assigned to each drum voice, therefore, several MIDI sound modules can be played at a time.

Channel 10 is assigned to all the voices at the manufacture.

How to change the transmit channels:

- ① Push the Main Key that corresponds to the drum voice whose transmit channel you wish to change.

The Display shows the selected drum voice and its MIDI channel number currently set.

- ② To change to the number higher, push the Up Key \uparrow , and to decrease the number, push the Down Key \downarrow . (CH 1 to 16 are available.)

Sync using MIDI

1. Sync with the slave devices

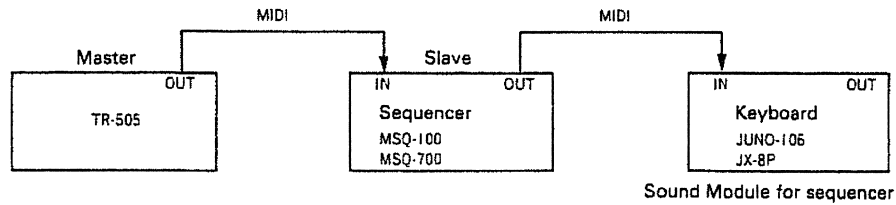

When the Start/Stop Key on the TR-505 is pushed, the slave device will start playing in the tempo of the TR-505.

- ① Set all the receivers to OMNI OFF modes.
- ② Set the receivers so that they can run with the TR-505's sync signal. (Refer to the owner's manual of each device.)

2. Sync to the master devices

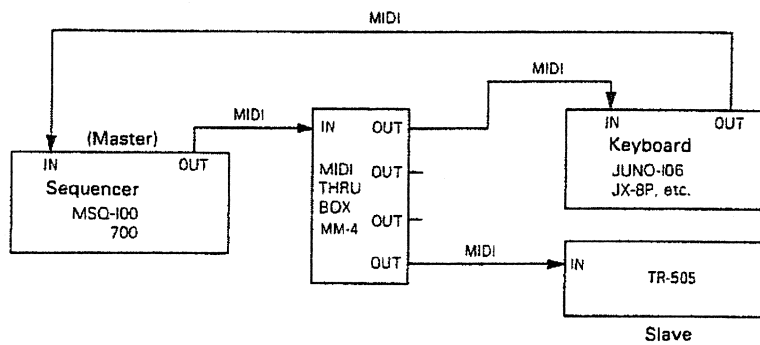

The Start/Stop and tempo of the TR-505 are controlled by the master device such as the sequencer.

- ① Set the composer's MIDI Sync function to ON.
- ② Set the composer to OMNI OFF mode.

3. Using the TR-505 as a MIDI sound module

- ① Set the composer to OMNI OFF mode.
When using only one transmitter, you can skip the step 1 and 2.
- ② Match the MIDI channel numbers of the transmitters to the composer's receive channel.

③ Match the transmitters and the key numbers of the composer.

* The volume of the drum sound is determined by the MIDI Velocity messages. It is not affected by the level set on the TR-505.

4. Transmitting MIDI message from the composer

In such a setup as below, the MIDI messages sent from the composer are received by the connected instruments such other rhythm machine and synthesizer, making them sound.

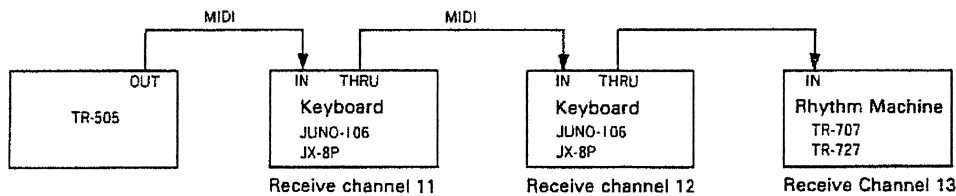

- ① Set the receivers to OMNI OFF mode.
- ② Match the transmit MIDI channel of each drum voice to the receiver's MIDI channel.
- ③ Match the key numbers of the composer to the receivers.

* The volume of each drum voice set on the composer does not affect receiver's volume. This can be useful for listening to the sounds of the external instruments with the composer's volume set to 0.

RHYTHM NOTE

Pattern Group A

1	2	3	4	5	6	7	8
8 Beat Rock 1	8 Beat Rock 2	8 Beat Rock 3	8 Beat Rock 4	Disco	Electric Pop	16 Beat Rock 1	16 Beat Rock 2
9	10	11	12	13	14	15	16
Fill In 2/4 1	Fill In 2/4 2	Fill In 4/4 1	Break	Fill In 4/4 2	Fill In 4/4 3	Fill In 4/4 4	Fill In 4/4 5

Pattern Group B (Triplet Time Rhythm)

1	2	3	4	5	6	7	8
Shuffle 1	Shuffle 2	Shuffle 3	Shuffle 4	Shuffle 5	Shuffle 6	Shuffle 7	4 Beat 1
9	10	11	12	13	14	15	16
Fill In 4/4 1	Fill In 4/4 2	Fill In 2/4 1	Fill In 4/4 3	Fill In 4/4 4	Fill In 4/4 5	Fill In 4/4 6	4 Beat 2

Pattern Group C (Latin Rhythm, etc.)

1	2	3	4	5	6	7	8
Rock Bossa 1	Rock Bossa 2	Samba 1	Samba 2	Reggae 1	Reggae 2	Mambo	March
9	10	11	12	13	14	15	16
Bossanova 1	Bossanova 2	Samba 3	Samba Fill In	Reggae Fill In 1	Reggae Fill In 2	Waltz	Waltz (Triplet)

RHYTHM NOTE

Pattern Group

1	2	3	4	5	6	7	8
9	10	11	12	13	14	15	16

Pattern Group

1	2	3	4	5	6	7	8
9	10	11	12	13	14	15	16

Pattern Group

1	2	3	4	5	6	7	8
9	10	11	12	13	14	15	16

Pattern Group

1	2	3	4	5	6	7	8
9	10	11	12	13	14	15	16

Pattern Group

1	2	3	4	5	6	7	8
9	10	11	12	13	14	15	16

Pattern Group

1	2	3	4	5	6	7	8
9	10	11	12	13	14	15	16

PATTERN NOTE

Pattern Group :

Pattern # :

Scale :

STEP	1	2	3	4	5	6	7	8	9	10	11	12	13	14	15	16
LAST STEP																
BASS DRUM																
SNARE DRUM																
LOW TOM																
MID TOM																
HI TOM																
TIMBALE																
RIM SHOT																
HAND CLAP																
OPEN HI-HAT																
CLOSED HI-HAT																
LOW CONGA																
HI CONGA																
LOW COWBELL																
HI COWBELL																
CRASH CYMBAL																
RIDE CYMBAL																
ACCENT																

Pattern Group :

Pattern # :

Scale :

STEP	1	2	3	4	5	6	7	8	9	10	11	12	13	14	15	16
LAST STEP																
BASS DRUM																
SNARE DRUM																
LOW TOM																
MID TOM																
HI TOM																
TIMBALE																
RIM SHOT																
HAND CLAP																
OPEN HI-HAT																
CLOSED HI-HAT																
LOW CONGA																
HI CONGA																
LOW COWBELL																
HI COWBELL																
CRASH CYMBAL																
RIDE CYMBAL																
ACCENT																

Pattern Group :

Pattern # :

Scale :

STEP	1	2	3	4	5	6	7	8	9	10	11	12	13	14	15	16
LAST STEP																
BASS DRUM																
SNARE DRUM																
LOW TOM																
MID TOM																
HI TOM																
TIMBALE																
RIM SHOT																
HAND CLAP																
OPEN HI-HAT																
CLOSED HI-HAT																
LOW CONGA																
HI CONGA																
LOW COWBELL																
HI COWBELL																
CRASH CYMBAL																
RIDE CYMBAL																
ACCENT																

Pattern Group :

Pattern # :

Scale :

STEP	1	2	3	4	5	6	7	8	9	10	11	12	13	14	15	16
LAST STEP																
BASS DRUM																
SNARE DRUM																
LOW TOM																
MID TOM																
HI TOM																
TIMBALE																
RIM SHOT																
HAND CLAP																
OPEN HI-NAT																
CLOSED HI-HAT																
LOW CONGA																
HI CONGA																
LOW COWBELL																
HI COWBELL																
CRASH CYMBAL																
RIDE CYMBAL																
ACCENT																

Pattern Group :

Pattern # :

Scale :

STEP	1	2	3	4	5	6	7	8	9	10	11	12	13	14	15	16
LAST STEP																
BASS DRUM																
SNARE DRUM																
LOW TOM																
MID TOM																
HI TOM																
TIMBALE																
RIM SHOT																
HAND CLAP																
OPEN HI-HAT																
CLOSED HI-HAT																
LOW CONGA																
HI CONGA																
LOW COWBELL																
HI COWBELL																
CRASH CYMBAL																
RIDE CYMBAL																
ACCENT																

Pattern Group :

Pattern # :

Scale :

STEP	1	2	3	4	5	6	7	8	9	10	11	12	13	14	15	16
LAST STEP																
BASS DRUM																
SNARE DRUM																
LOW TOM																
MID TOM																
HI TOM																
TIMBALE																
RIM SHOT																
HAND CLAP																
OPEN HI-HAT																
CLOSED HI-HAT																
LOW CONGA																
HI CONGA																
LOW COWBELL																
HI COWBELL																
CRASH CYMBAL																
RIDE CYMBAL																
ACCENT																

Rhythm machine

MODEL TR-505 MIDI Implementation

1. TRANSMITTED DATA

Status	Second	Third	Description	
1001 nnnn	0kkk kkkk	0000 0000	Note OFF kkkkkk = 25-99	#1 #2
1001 nnnn	0kkk kkkk	0vvv vvvv	Note ON kkkkkk = 25-99 vvvvvvv = 48,64,80,96,112,127	#1 #2 #3
1111 0010	0xxx xxxx	0yyy yyyy	Song Position Pointer xxxxxxx: Least significant yyyyyyy: Most significant	#4 #5
1111 0011	0aaa aaaa		Song Select aaaaaaa = 0-5 (track # 1-6)	#6 #5
1111 1000			Timing Clock	#8
1111 1010			Start	#5
1111 1011			Continue	#5
1111 1100			Stop	#5

Notes :

#1 Transmitted channel for each instrument can be changed to 1 - 16, and memorized.

#2 Note number for each instrument can be changed.

#3 vvvvvvv is set as follows.

accent level	vvvvvvv
not given	48
1	64
2	80
3	96
4	112
5	127

#4 When the measure is set.

#5 When MIDI sync mode is on, the unit transmits these messages received from MIDI IN.

#6 When the track # is set.

track #	aaaaaaa
1	0
2	1
3	2
4	3
5	4
6	5

2. RECOGNIZED RECEIVE DATA

RECOGNIZED RECEIVE DATA			Description	
1001 nnnn	0kkk kkkk	0vvv vvvv	Note ON kkkkkk = 25 - 99 vvvvvvv = 1 - 127	#1 #2
1011 bbbb	0111 1100	0000 0000	OHMI OFF	
1011 bbbb	0111 1101	0000 0000	OHMI ON	
1111 0010	0xxx xxxx	0yyy yyyy	Song Position Pointer xxxxxxx: Least significant yyyyyyy: Most significant	#3 #4
1111 0011	0aaa aaaa		Song Select aaaaaaa = 0-5 (track # 1-6)	#3 #4
1111 1000			Timing Clock	#4
1111 1010			Start	#4
1111 1011			Continue	#4
1111 1100			Stop	#4

Notes :

#1 Received channel # can be changed to 1 - 16, and memorized. The sounds listed below on the same row cannot sound at the same time.

Low Tom (LT) / Mid Tom (MT) / Right Tom (RT) / Timbale (TB)
Rim Shot (RIM) / Hand Clap (HCP)
Open Hi-Hat (OH) / Closed Hi-Hat (CH)
Low Conga (LCG) / Right Conga (RCG)
Low Cowbell (LCB) / Right Cowbell (RCB)
Crash Cymbal (CC) / Ride Cymbal (RC)

#2 Note number for each instrument can be changed.

#3 Recognized while the unit is in 'STOP' in the Track Play mode.

#4 When the SYNC mode is set at MIDI.

Rhythm machine

MODEL TR-505 MIDI Implementation Chart

Date:Jan.31 1986
Version:1.0

Function.....		Transmitted	Recognized	Remarks
Basic Channel	Default Changed	1-16 1-16	1-16 1-16	Memorized
Mode	Default Messages Altered	Mode 3 *****	Mode 1 OMNI ON/OFF	
Note Number	True voice	25-99 *1 *****	25-99 *1	assigns to each rhythm voice
Velocity	Note ON Note OFF	<input type="radio"/> 9n v=48-127 <input checked="" type="radio"/> 9n v=0	<input type="radio"/> 9b v=1-127 <input checked="" type="radio"/> X	n=Inst CH *2 b=Basic CH
After Touch	Key's Ch's	<input checked="" type="radio"/> X <input checked="" type="radio"/> X	<input checked="" type="radio"/> X <input checked="" type="radio"/> X	
Pitch Bender		<input checked="" type="radio"/> X	<input checked="" type="radio"/> X	
Control Change		<input checked="" type="radio"/> X	<input checked="" type="radio"/> X	
Prog Change	True #	<input checked="" type="radio"/> X *****	<input checked="" type="radio"/> X	
System Exclusive		<input checked="" type="radio"/> X	<input checked="" type="radio"/> X	
System Common	Song Pos Song Sel Tune	<input type="radio"/> O <input type="radio"/> O <input checked="" type="radio"/> X	<input type="radio"/> O SYNC mode=MIDI <input type="radio"/> O SYNC mode=MIDI <input checked="" type="radio"/> X	0-5
System Real Time	Clock Commands	<input type="radio"/> O <input type="radio"/> O	<input type="radio"/> O SYNC mode=MIDI <input type="radio"/> O SYNC mode=MIDI	
Aux Mes-Sages	Local ON/OFF All Notes OFF Active Sense Reset	<input checked="" type="radio"/> X <input checked="" type="radio"/> X <input checked="" type="radio"/> X <input checked="" type="radio"/> X	<input checked="" type="radio"/> X <input checked="" type="radio"/> X <input checked="" type="radio"/> X <input checked="" type="radio"/> X	
Notes		*1 Transmitted and recognized note numbers can be assigned by panel operation. *2 Transmit channel # for each instrument can be changed to 1-16 by panel operation.		

Mode 1 : OMNI ON, POLY Mode 2 : OMNI ON, MONO
Mode 3 : OMNI OFF, POLY Mode 4 : OMNI OFF, MONO

: Yes
 : No

 Roland

TR-505

PRESET RHYTHM SCORE

プリセット・リズム・スコア

Pattern Group A

1	2	3	4	5	6	7	8
8 Beat Rock 1	8 Beat Rock 2	8 Beat Rock 3	8 Beat Rock 4	Disco	Electric Pop	16 Beat Rock 1	16 Beat Rock 2
9	10	12	13	14	15	16	17
Fill In 2/4 1	Fill In 2/4 2	Fill In 4/4 1	Break	Fill In 4/4 2	Fill In 4/4 3	Fill In 4/4 4	Fill In 4/4 5

Pattern Group B (Triplet Time Rhythm)

1	2	3	4	5	6	7	8
Shuffle 1	Shuffle 2	Shuffle 3	Shuffle 4	Shuffle 5	Shuffle 6	Shuffle 7	4 Beat 1
9	10	11	12	13	14	15	16
Fill In 4/4 1	Fill In 4/4 2	Fill In 2/4 1	Fill In 4/4 3	Fill In 4/4 4	Fill In 4/4 5	Fill In 4/4 6	4 Beat 2

Pattern Group C (Latin Rhythm)

1	2	3	4	5	6	7	8
Rock Bossa 1	Rock Bossa 2	Samba 1	Samba 2	Reggae 1	Reggae 2	Mambo	March
9	10	11	12	13	14	15	16
Bossanova 1	Bossanova 2	Samba 3	Samba Fill In	Reggae Fill In 1	Reggae Fill In 2	Waltz	Waltz (Triplet)

A-1 8ビート 1 8 Beat 1

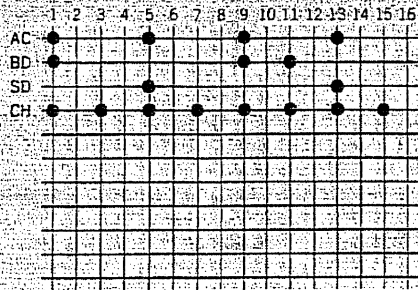

SCALE 
 LAST STEP 16

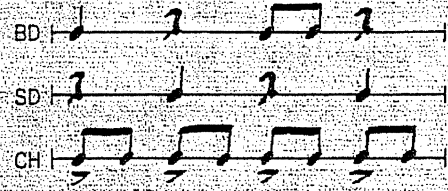

A-2 8ビート 2 8 Beat 2

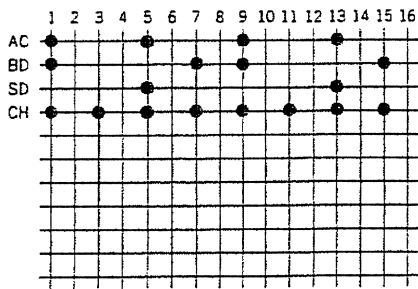

SCALE 
 LAST STEP 16

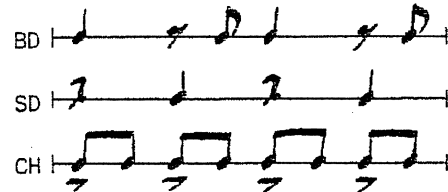

A-3 8ビート 3 8 Beat 3

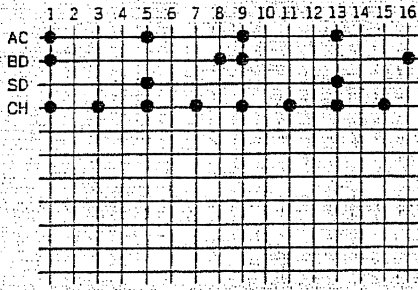

SCALE 
 LAST STEP 16

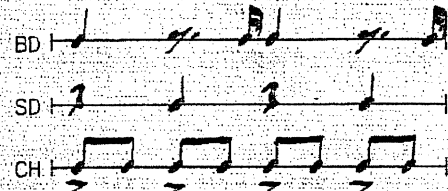

A-4 8ビート 4 8 Beat 4

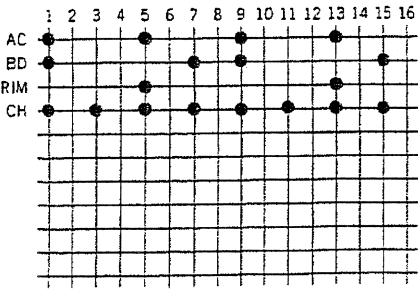

SCALE 
 LAST STEP 16



A-5 ディスコ Disco

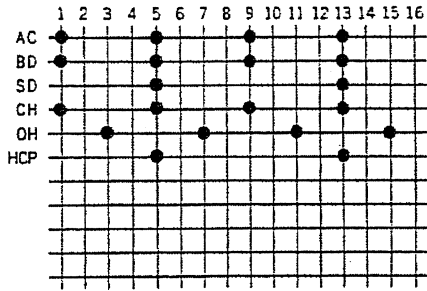

SCALE 
 LAST STEP 16



A-6 エレクトリック・ポップ Electric Pop

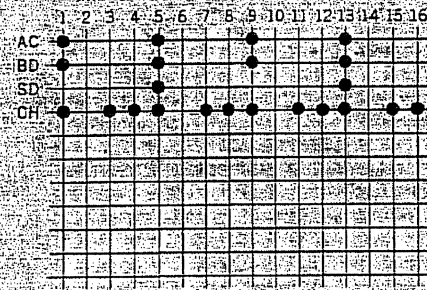

SCALE 
 LAST STEP 16

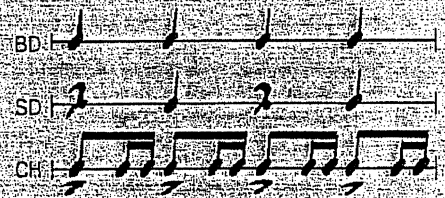

A-7 16ビート 1 16 Beat 1

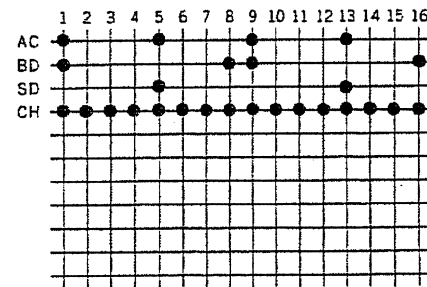

SCALE 
 LAST STEP 16



A-8 16ビート 2 16 Beat 2

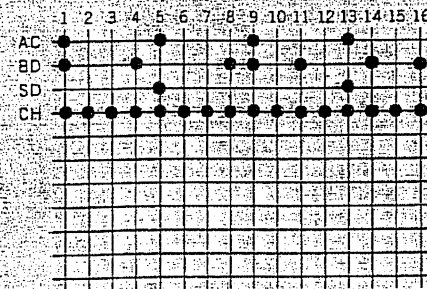

SCALE 
 LAST STEP 16



A-9 フィル・イン 2/4 1 Fill In 2/4 1

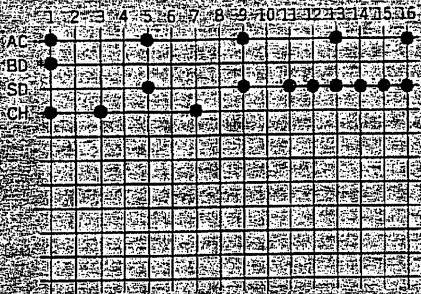

SCALE 
 LAST STEP 16

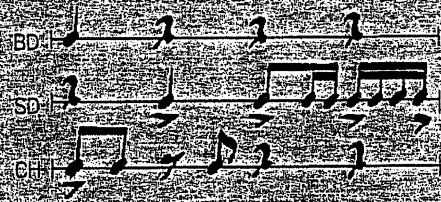

A-10 フィル・イン 2/4 2 Fill In 2/4 2

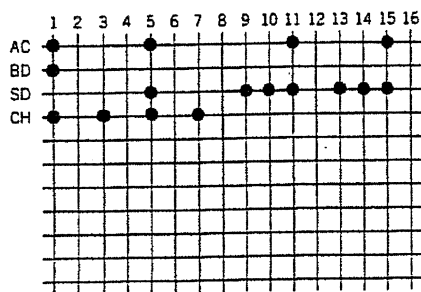

SCALE 
 LAST STEP 16

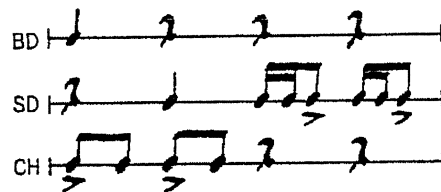

A-11 フィル・イン 4/4 1 Fill In 4/4 1

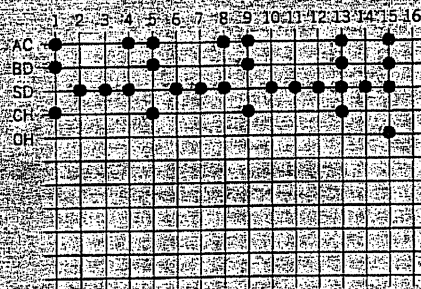

SCALE 
 LAST STEP 16

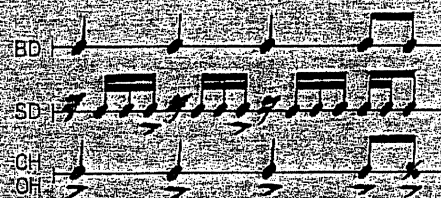

A-12 ブレイク Break

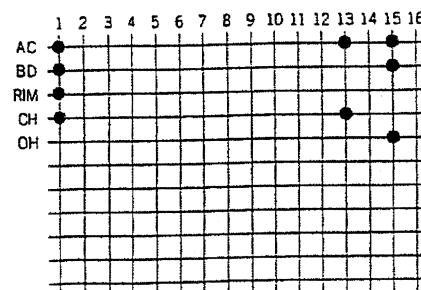

SCALE 
 LAST STEP 16

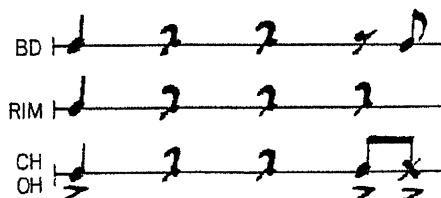

A-13 フィル・イン 4/4 2 Fill In 4/4 2

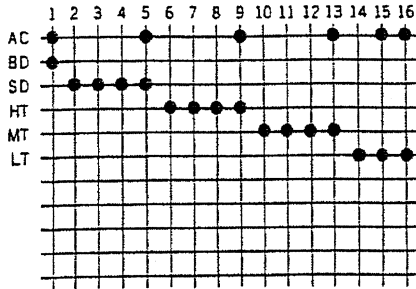

SCALE ♪
LAST STEP 16

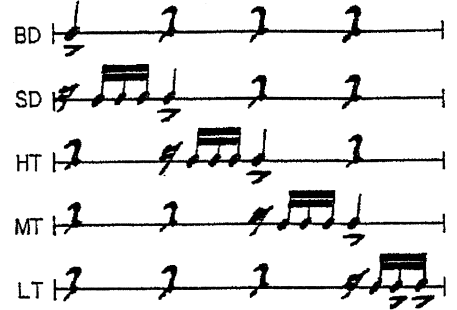

A-14 フィル・イン 4/4 3 Fill In 4/4 3

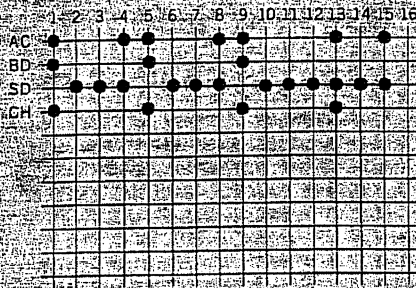

SCALE ♪
LAST STEP 16

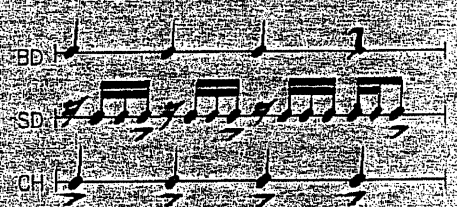

A-15 フィル・イン 4/4 4 Fill In 4/4 4

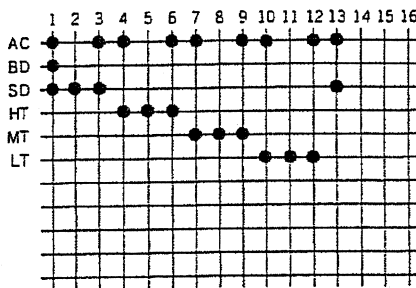

SCALE ♪
LAST STEP 16

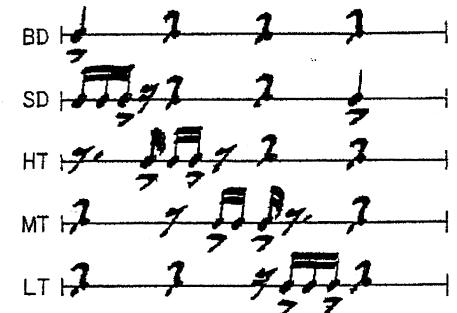

A-16 フィル・イン 4/4 5 Fill In 4/4 5

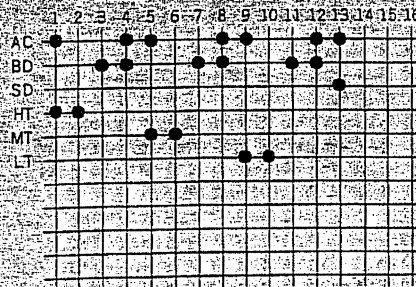

SCALE ♪
LAST STEP 16

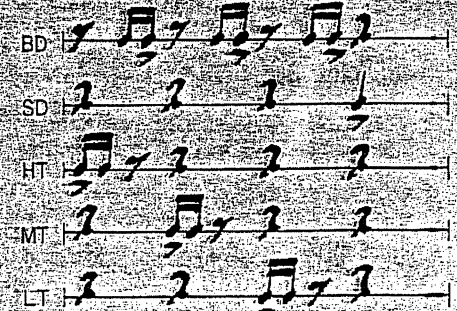

B-1 シャッフル 1 Shuffle 1

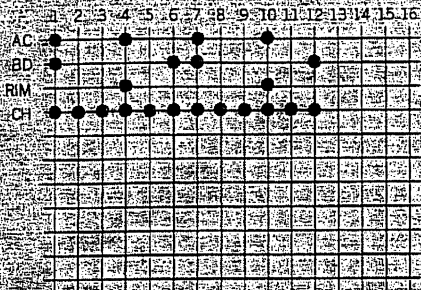

SCALE $\frac{3}{4}$
LAST STEP 12



B-2 シャッフル 2 Shuffle 2

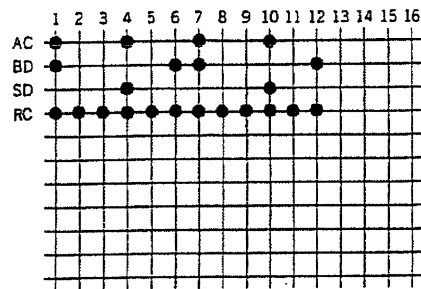

SCALE $\frac{3}{4}$
LAST STEP 12



B-3 シャッフル 3 Shuffle 3

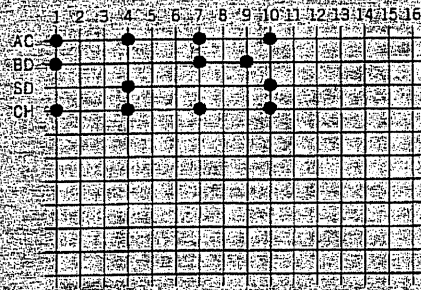

SCALE $\frac{3}{4}$
LAST STEP 12

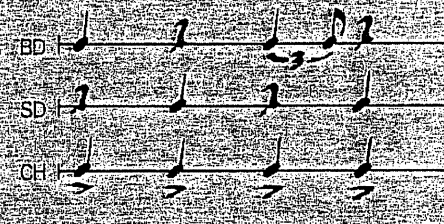

B-4 シャッフル 4 Shuffle 4

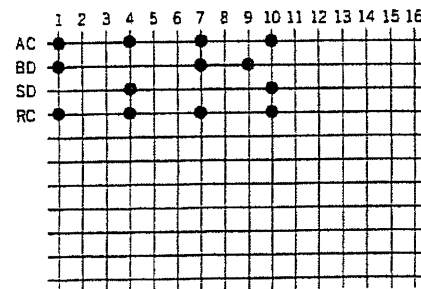

SCALE $\frac{3}{4}$
LAST STEP 12

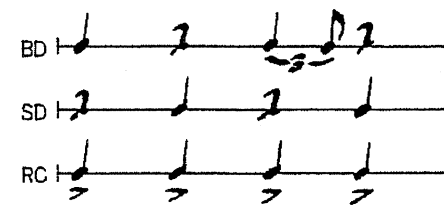

B-5 シャッフル 5 Shuffle 5

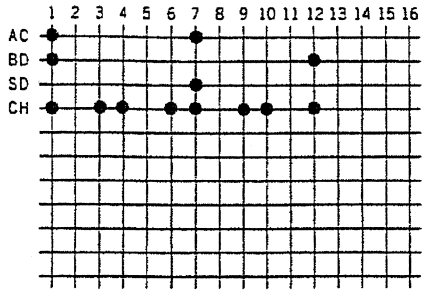

SCALE $\frac{3}{4}$
LAST STEP 12

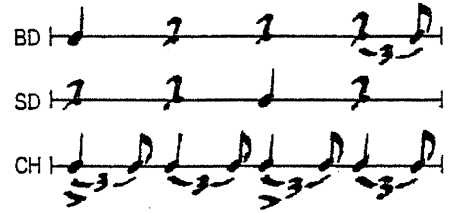

B-6 シャッフル 6 Shuffle 6

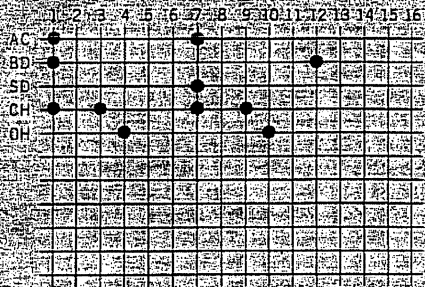

SCALE $\frac{3}{4}$
LAST STEP 12

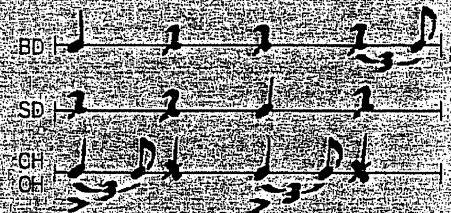

B-7 シャッフル 7 Shuffle 7

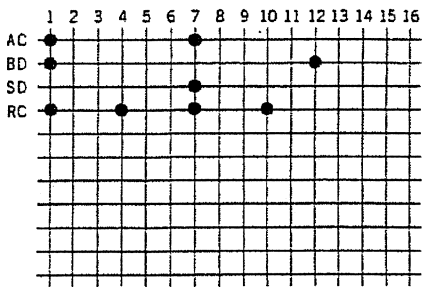

SCALE $\frac{3}{4}$
LAST STEP 12

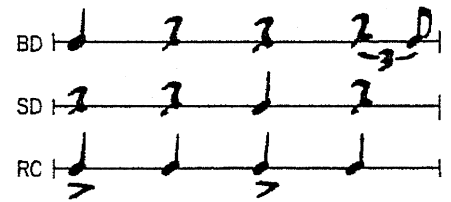

B-8 4ビート 1 4 Beat 1

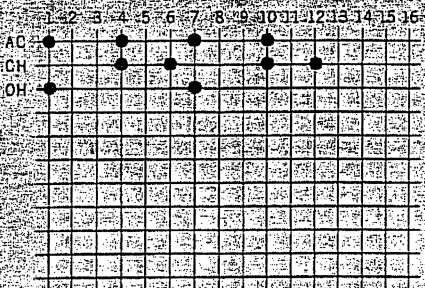

SCALE $\frac{3}{4}$
LAST STEP 12



B-9 フィル・イン 4/4 1 Fill In 4/4 1

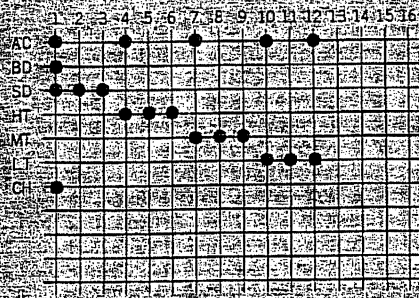

SCALE $\frac{3}{4}$
LAST STEP 12

B-10 フィル・イン 4/4 2 Fill In 4/4 2

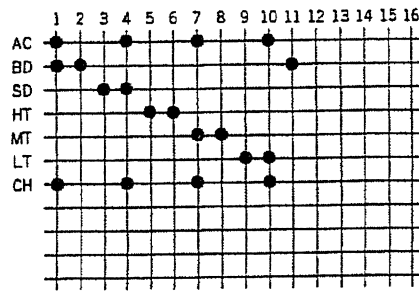

SCALE $\frac{3}{4}$
LAST STEP 12

B-11 フィル・イン 2/4 1 Fill In 2/4 1

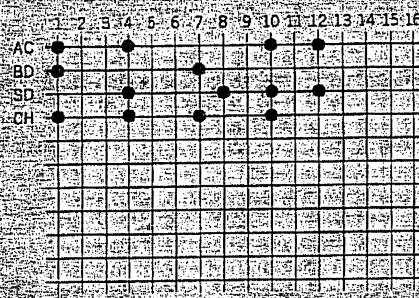

SCALE $\frac{3}{4}$
LAST STEP 12

B-12 フィル・イン 4/4 3 Fill In 4/4 3

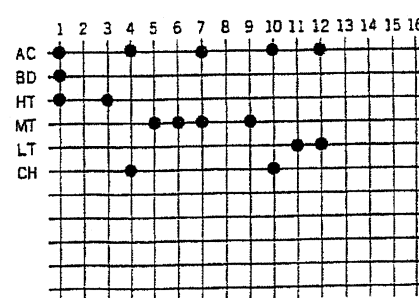

SCALE $\frac{3}{4}$
LAST STEP 12

B-13 フィル・イン 4/4 4 Fill In 4/4 4

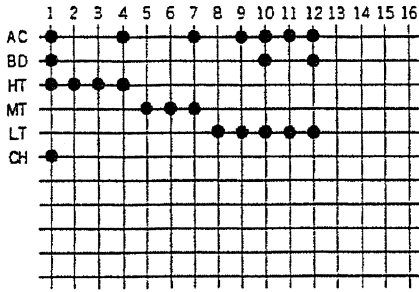

SCALE $\frac{3}{4}$
LAST STEP 12

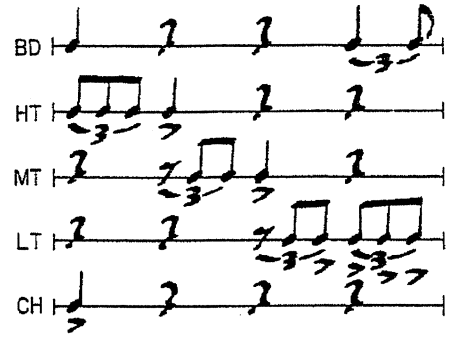

B-14 フィル・イン 4/4 5 Fill In 4/4 5

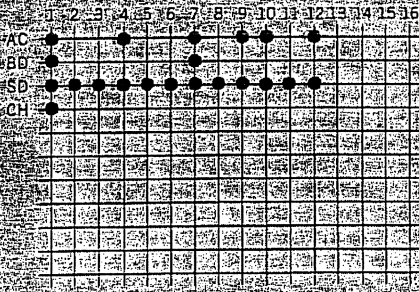

SCALE $\frac{3}{4}$
LAST STEP 12

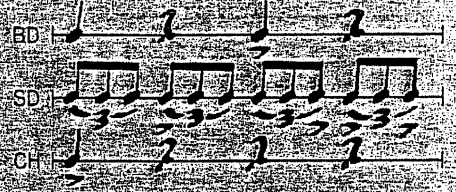

B-15 フィル・イン 4/4 6 Fill In 4/4 6

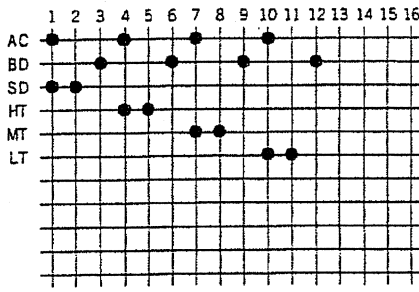

SCALE $\frac{3}{4}$
LAST STEP 12

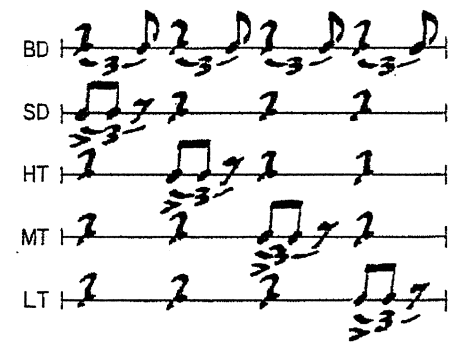

B-16 4 Beat 2 4 Beat 2

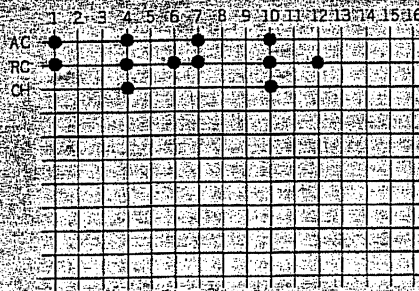

SCALE $\frac{3}{4}$
LAST STEP 12

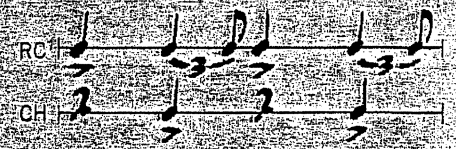

C-1 ロック ボサノバ 1 Rock Bossa 1

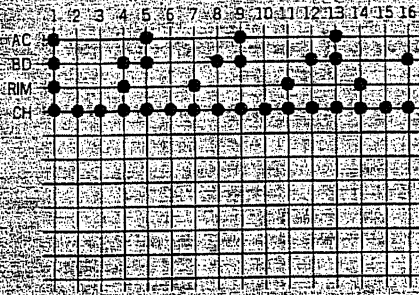

SCALE ♩
LAST STEP 16

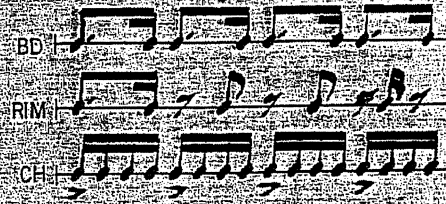

C-2 ロック ボサノバ 2 Rock Bossa 2

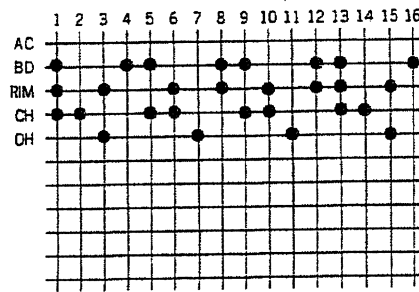

SCALE ♩
LAST STEP 16



C-3 サンバ 1 Samba 1

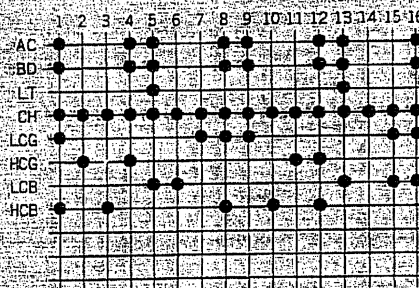

SCALE ♩
LAST STEP 16

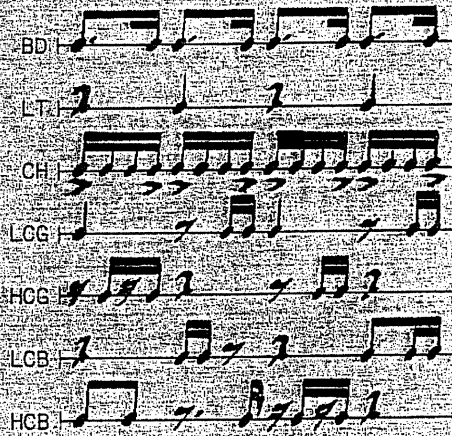

C-4 サンバ 2 Samba 2

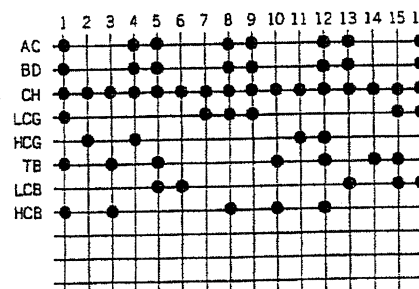

SCALE ♩
LAST STEP 16



C-5 レゲエ 1 Reggae 1

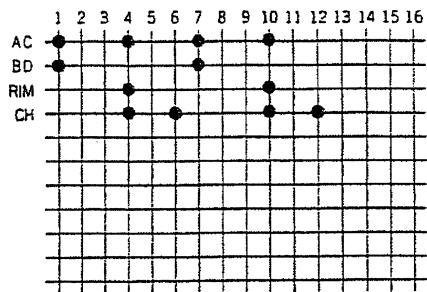

SCALE $\frac{3}{4}$
LAST STEP 12

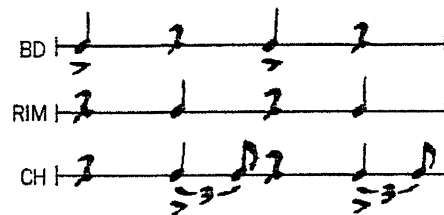

C-6 レゲエ 2 Reggae 2

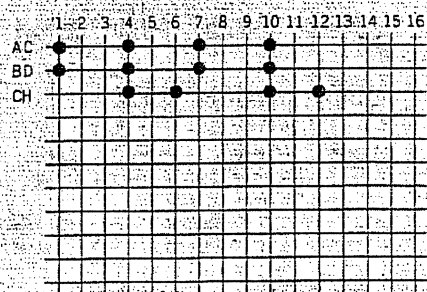

SCALE $\frac{3}{4}$
LAST STEP 12

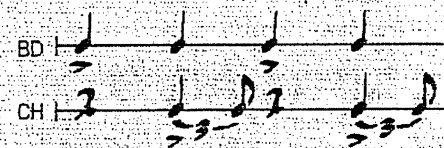

C-7 マンボ Mambo

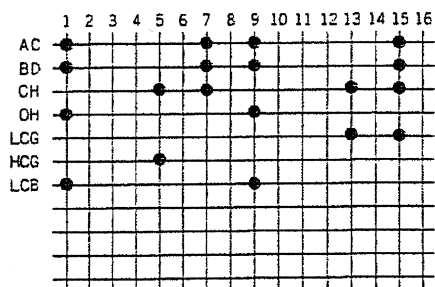

SCALE $\frac{3}{4}$
LAST STEP 16

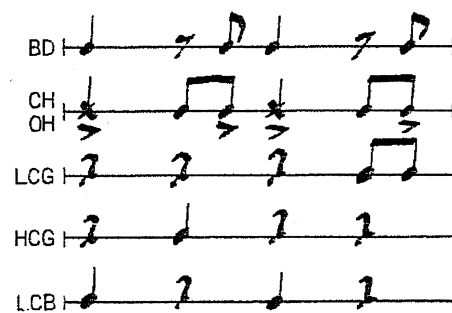

C-8 マーチ March

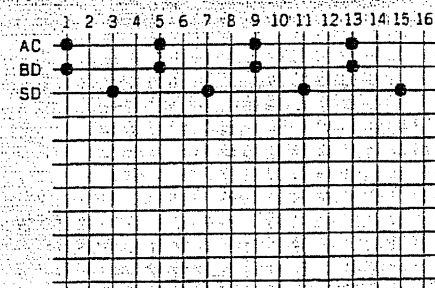

SCALE $\frac{3}{4}$
LAST STEP 16

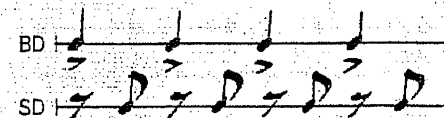

C-9 ボサノバ 1 Bossanova 1

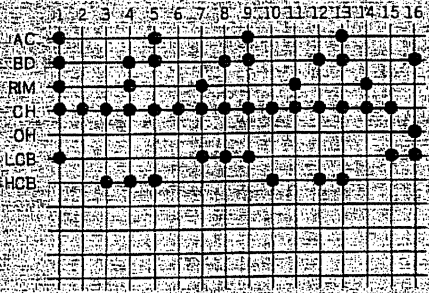

SCALE 
 LAST STEP 16



C-10 ボサノバ 2 Bossanova 2

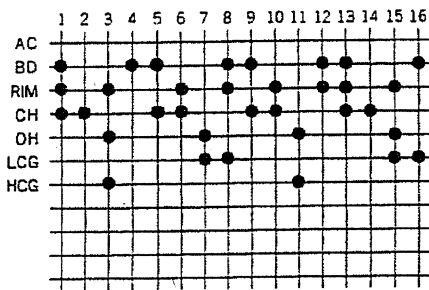

SCALE 
 LAST STEP 16

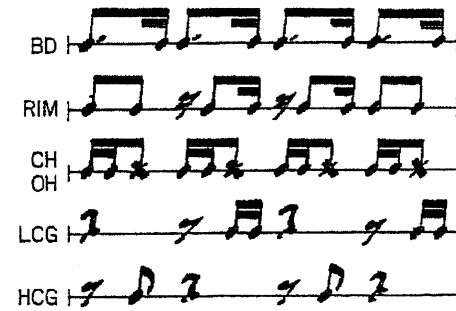

C-11 サンバ 3 Samba 3

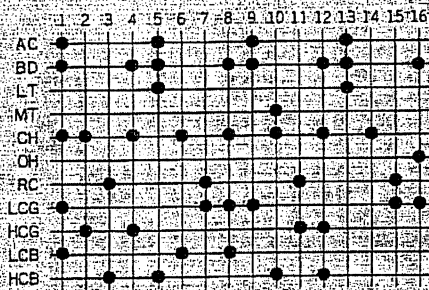

SCALE 
 LAST STEP 16

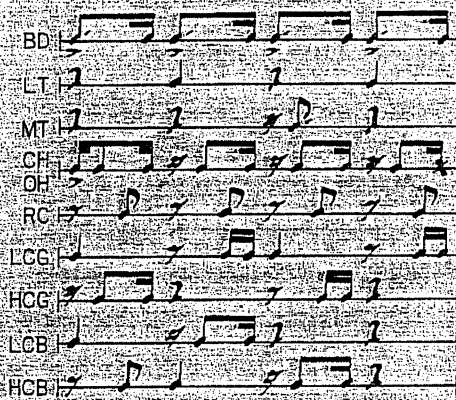

C-12 サンバ フィル・イン Samba Fill In

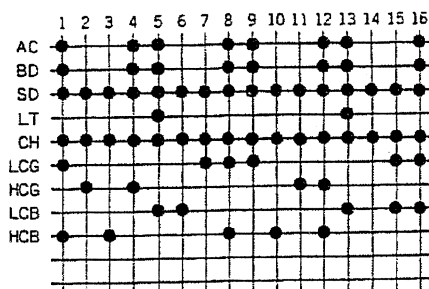

SCALE 
 LAST STEP 16

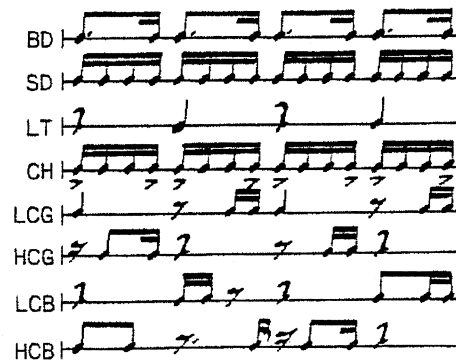

C-13 レゲエ フィル・イン 1 Reggae Fill In 1

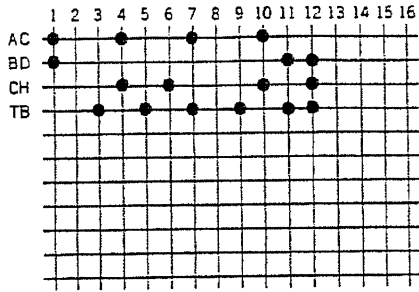

SCALE $\frac{3}{4}$
LAST STEP 12

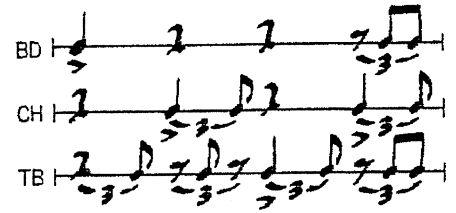

C-14 レゲエ フィル・イン 2 Reggae Fill In 2

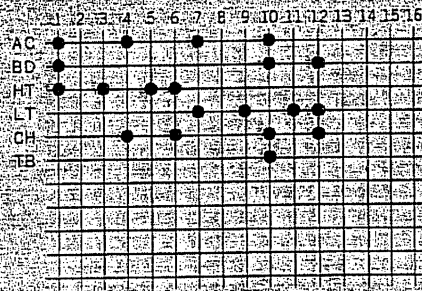

SCALE $\frac{3}{4}$
LAST STEP 12

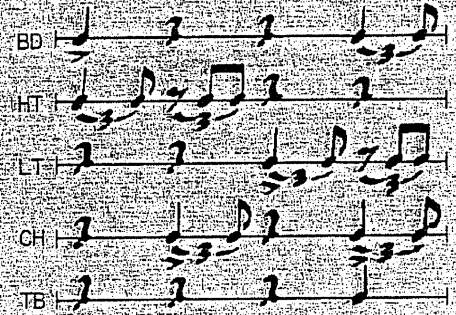

C-15 ワルツ Waltz

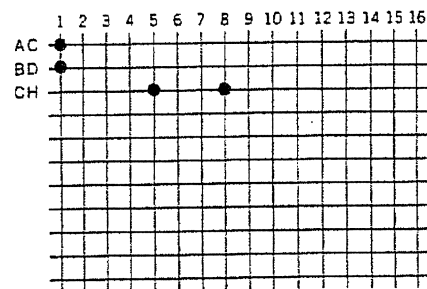

SCALE $\frac{3}{4}$
LAST STEP 12

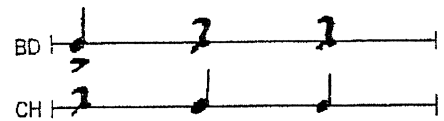

C-16 ワルツ (3連系) Waltz (Triplet)

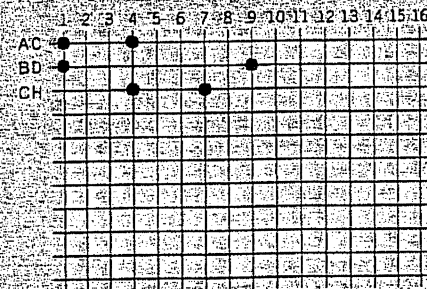

SCALE $\frac{3}{4}$
LAST STEP 9

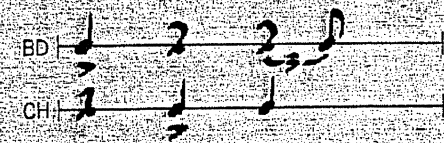



〒559 大阪市住之江区新北島3-7-13 代表 (06)681-5431

26015360 '88-10-A3-22S

Roland®

10662

UPC 10662



1290:

Roland®