



INSTRUCTION MANUAL

TABLE OF CONTENTS

	Page		Page
Conversion Kit Contents	Inside Cover	56 Pin Wiring Harness Color Code	6
Introduction	1	36 Pin Wiring Harness Color Code	7
Graphics	2	Wiring Diagram	8
Monitor Specifications	3	Dip Switch Setting	9
Monitor Information	4	User Information Warning	Back Cover
Stereo/Mono Sound Installation	5		

CONVERSION KIT CONTENTS:

- MAIN PRINTED CIRCUIT BOARD
- P.C.B. CAGE (FCC REQUIRED)
- CONNECTING WIRING HARNESS
- 6 SETS — BUTTON ASSEMBLIES
- TWO 8-WAY JOYSTICKS
- MARQUEE (HEADER)
(1/8" acrylic sheet)
- ONE SET SIDE PANEL GRAPHICS (left & right)
- CONTROL PANEL OVERLAY
- CONTROL PANEL DECALS
instruction decals/button decals (2 sets)
- MANUAL
- REGISTRATION CARD

REPLACEMENT ACCESSORIES ARE AVAILABLE THROUGH YOUR DISTRIBUTOR.

THIS KIT USABLE IN AN UPRIGHT WITH A VERTICAL MONITOR.

*THIS KIT NOT INTENDED FOR COCKTAIL MODEL CABINETS.

TOP GUNNER: INTRODUCTION

KONAMI CONVERSION KITS are the most complete conversion kits available today. Every detail has been carefully considered, designed and packaged to provide you the means of easily producing a professional conversion.

These kits have all the accessories to easily convert your UPRIGHT video game.

We strongly urge you to FULLY STUDY this instruction manual BEFORE you begin your conversion. It contains step-by-step instructions, schematic diagrams and suggestions on how to install your Konami Conversion Kit and maximize your profits.

TOP GUNNER can be installed in any vertically mounted raster scan monitor game.

Everything you will need to construct your new game is provided in this kit. All accessory parts—wiring harness, joystick, etc. are custom made for TOP GUNNER by top engineers experienced in the coin-op industry. An 8-way joystick with rotary switch (as provided) MUST be used.

The Player Instruction and Button Control decals are made of a non-destructible acrylic material specifically to keep the player from peeling them off. Should you convert a cocktail table game, TOP GUNNER is supplied with 2 sets of button decals.

★ ★ ★ IMPORTANT NOTICE ★ ★ ★

The Japanese Amusement Machine Manufacturers Association (JAMMA) has introduced a new standard in video game P.C.B.'s. It was decided that all new products from any JAMMA member will use the same pin print-out on the edge connector. The edge connector will have 56 pin outs, 28 per side.

Konami Inc. will offer a 56 to 36 pin adaptor P.C.B. available through your distributor. This new adaptor P.C.B. will enable the new 56 pin out to adapt to Konami's old standard 36 pin out.

★ ★ ★ STEREO SOUND ★ ★ ★

TOP GUNNER offers stereo sound in this kit.
Please see page 5 for proper installation.

PUTTING YOUR BEST GAME FORWARD

PREPARATION:

For best results, all old graphics should be removed completely from the cabinet. "Stick-on" graphics can be removed by using a hairdryer or hot air device. The heat from the dryer will loosen the adhesive, allowing you to easily peel them off — any adhesive residue can be cleaned off with acetone and a soft dry cloth. (DO NOT USE ACETONE ON SURFACES PAINTED WITH FLAT PAINT.)

TOOLS YOU NEED:

1. Foaming Aerosol (such as "Windex").
2. Soft Squeegee.
3. X-Acto Knife.

SIDE PANEL DECALS

1. Spray area of cabinet where Side Panel decals are to be applied with foaming aerosol or a mild soap solution.
2. Remove protective backing from decals.
3. Position decals into place.
4. With a soft squeegee, beginning from the center of the decal, slowly and evenly press out excess foam until you achieve a smooth finish.
5. Allow to set approximately 2 to 3 hours before handling. Maximum adherence is achieved in 48 to 72 hours.

6. Trim side decal to fit your cabinet.

CONTROL PANEL OVERLAY:

1. Refer to Recommended Control Panel Layout on page 1.
2. Drill any new holes needed.
3. Plug any holes that will not be used. (A permanent epoxy filler works well for this step.)
4. Pre-position the overlay prior to removing the backing.
5. Slowly apply the overlay — inch by inch on the control panel, removing the backing as you apply it.
6. Once it's in place, by using an X-Acto knife, cut around the button and joystick placements.

INSTRUCTION/BUTTON DECALS:

Apply the Player Instruction, Button and 1 Player/2 Player decals in their respective positions. Apply pressure liberally. Allow to set as long as possible before putting game on location.

NOTE: Maximum adherence is achieved in 48 to 72 hours.

FCC WARNING LABEL:

FCC Warning Label must be applied to the outside of the cabinet near the line cord entry.

MARQUEE

(WEAR PROTECTIVE GLASSES WHILE TRIMMING MARQUEE)

1/8" Acrylic Marquee should be cut to fit your game. DO NOT remove protective mask until this is done.

One way of cutting your Marquee is as follows: (Be sure to protect painted side of Marquee from any surface which may scratch or mar finish).

CUTTING WITH A KNIFE OR SCRIBER

Acrylic sheet up to 3/16" thick may be cut by a method similar to that used for cutting window glass. Use a scribe of some kind — a scribing knife such as the one pictured, a metal scribe, an awl, or even a sturdy craft knife — to score the sheet. Draw the scribe several times (7 or 8 times for a 3/16" thick piece) along a straight edge held firmly in place. It is best not to remove the protective masking. Make the cuts carefully using firm, even pressure. For best results make each stroke cleanly off the edge of the sheet.

Then clamp the acrylic sheet or hold it rigidly under a straight edge with the scribe mark hanging just over the edge of a table. Protect your hands with a cloth, and apply a sharp downward pressure to the other side of the sheet. It will break along the scratch. Scrape the edges to smooth any sharp corners. This method is not recommended for long breaks or thick material.

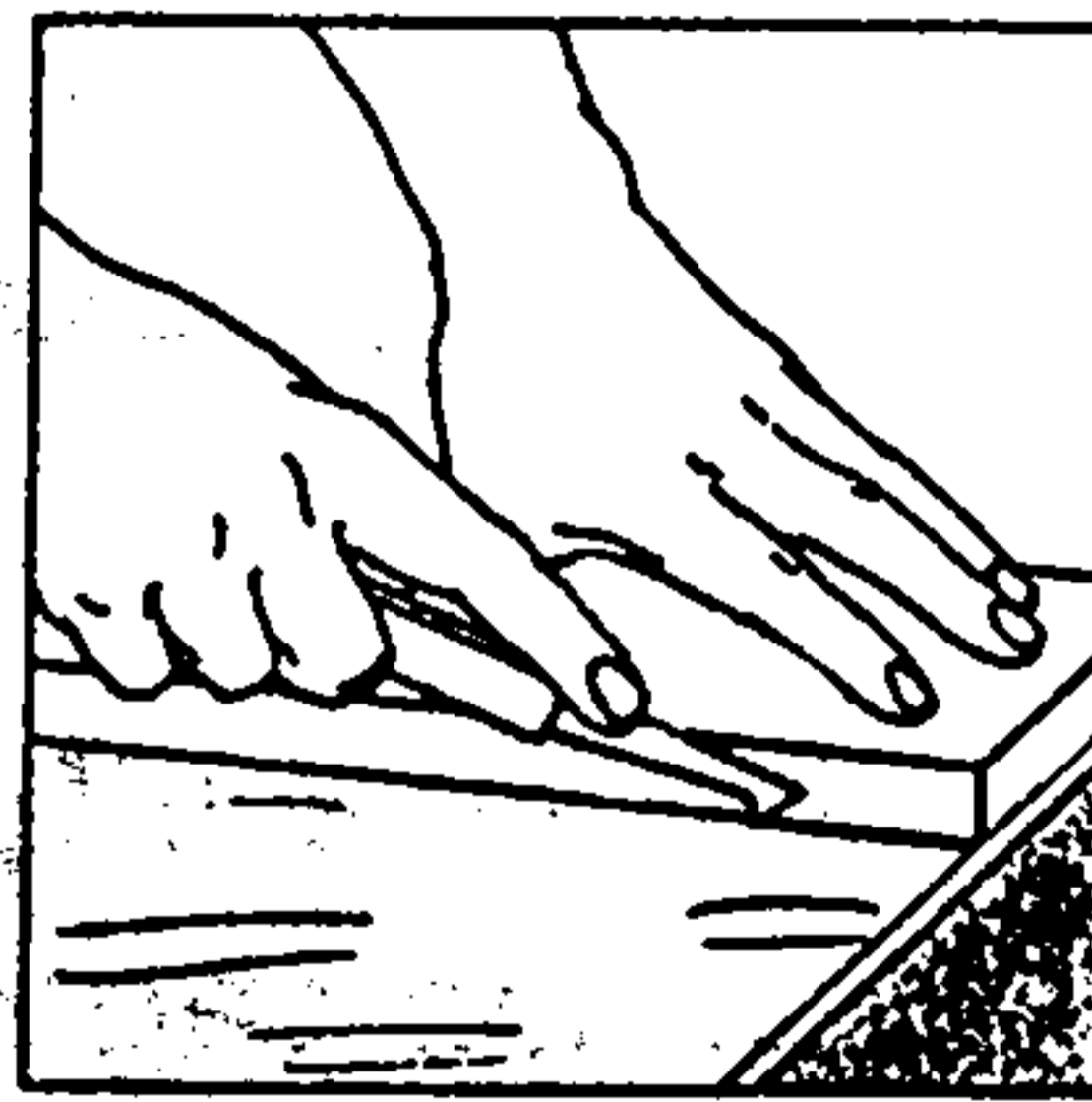

Always draw the scribing knife along a straight edge.

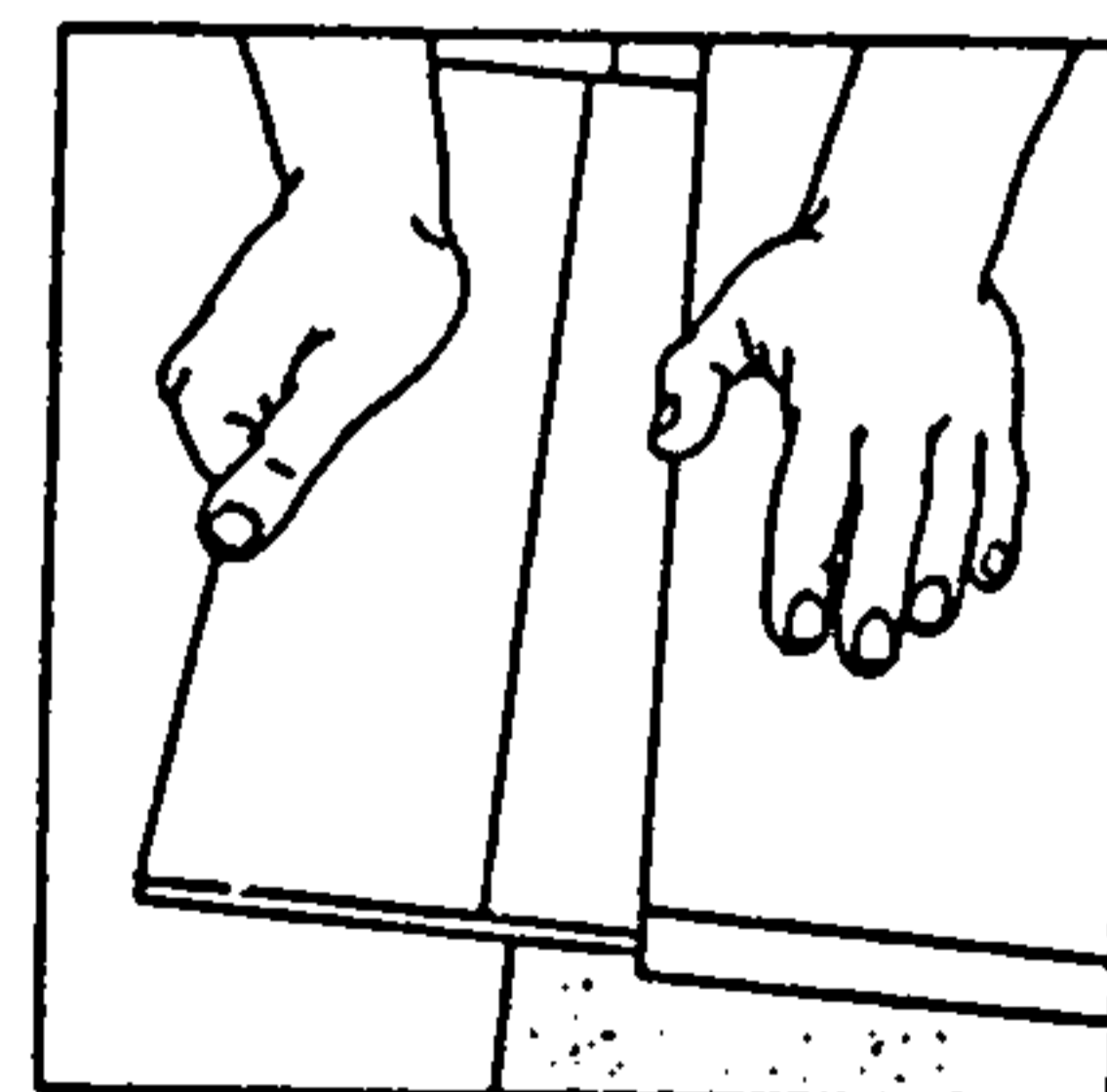

Break sheet over edge of table after scribing.

P.C.B. CAGE INSTALLATION

Konami, Inc. now supplies a new style P.C.B. cage which is superior to old style cages because of ease of installation. The cage is made of a 32 point stem-stock which is fire retardant.

TO INSTALL THE CAGE:

1. Open cage bottom and secure to desired P.C.B. position.
2. Install printed circuit board inside cage using wood screws, screwed through the cage bottom into cabinet side.
3. Close the cage over printed circuit board and secure with latch on cage.

TOP GUNNER: 36 PIN WIRING HARNESS

36 Pin Wire
Harness

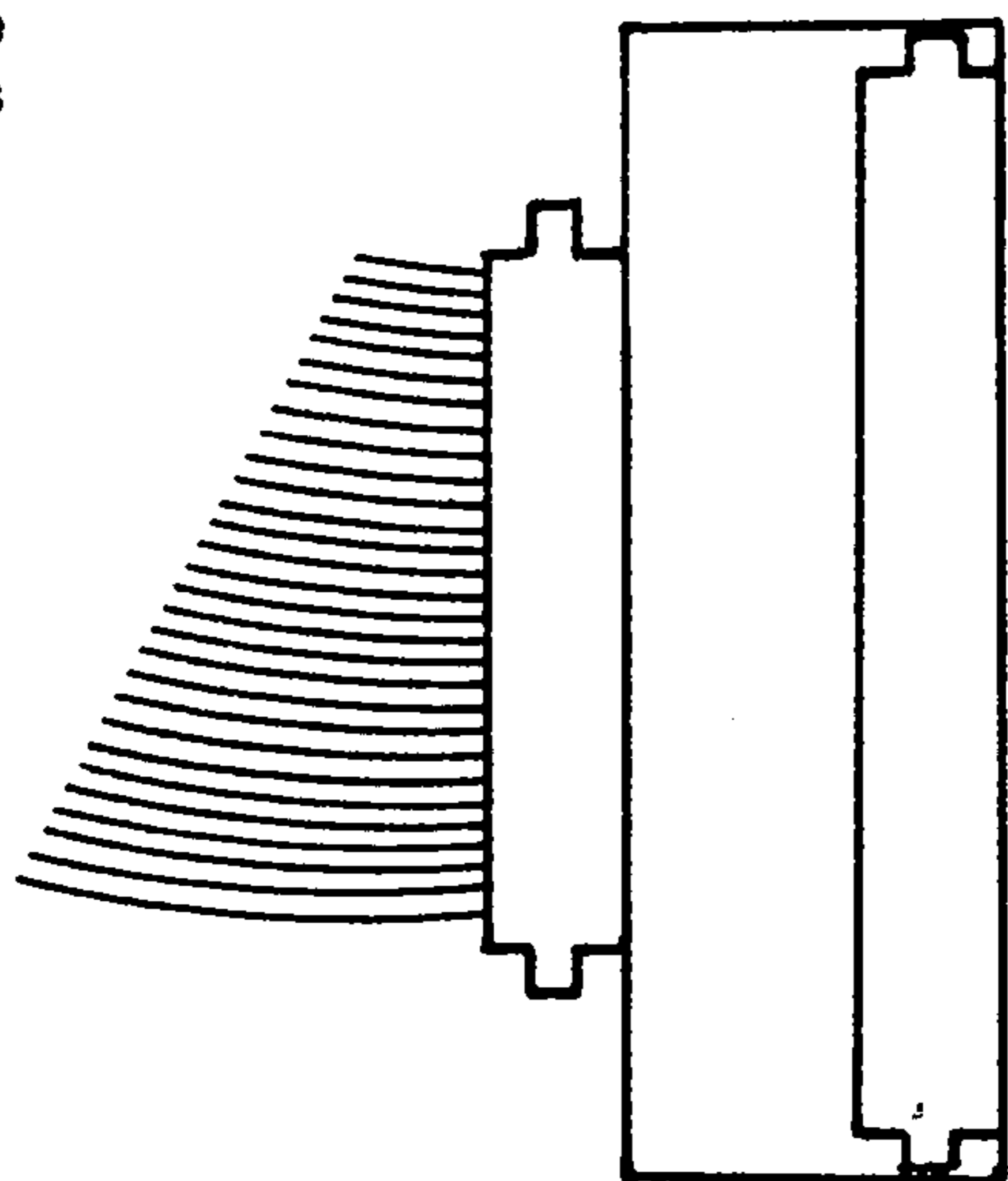

36 to 56 Pin
Adaptor Card

Supplied in TOP GUNNER you will find a 36 to 56 pin card connector. This connector enables the operator to convert his Konami wired video cabinet from the old 36 pin harness to the new JAMMA standard 56 pin connector without major rewiring.

If this kit is to be installed in a non-Konami wired cabinet a wiring harness is supplied.

Solder Side ←

→ Parts Side

WIRE COLOR KEY:

WHITE/GREEN	(NOT USED)	A	1	+ 12V DC	ORANGE
RED/GREEN	*(Mono Speaker Output)	B	2	*(Mono Speaker Output)	ORANGE/GREEN
YELLOW/RED	2P GUN	C	3	2P MISSILE	ORANGE/YELLOW
BROWN/YELLOW	2P LEFT	D	4	2P RIGHT	BLUE/YELLOW
VIOLET/WHITE	1P START	E	5	2P START	VIOLET/YELLOW
ORANGE/WHITE	1P MISSILE	F	6	2P UP	BLACK/YELLOW
RED/WHITE	1P GUN	H	7	(NOT USED)	ORANGE/GRAY
BLUE/WHITE	1P RIGHT	J	8	1P LEFT	BROWN/WHITE
BLACK/WHITE	1P UP	K	9	2P DOWN	GRAY/YELLOW
RED/GRAY	COIN 1	L	10	COIN 2	BLUE/GRAY
GRAY/WHITE	1P DOWN	M	11	COIN COUNTER 1	GREEN/GRAY
PINK/WHITE	(NOT USED)	N	12	COIN COUNTER 2	YELLOW/GRAY
GREEN/BROWN	VIDEO GREEN	P	13	VIDEO BLUE	BLUE/BROWN
RED/BROWN	VIDEO RED	R	14	VIDEO SYNC	WHITE/BROWN
WHITE/BLACK	(NOT USED)	S	15		PINK/YELLOW
BLACK	GROUND	T	16	GROUND	BLACK
BLACK	GROUND	U	17	GROUND	BLACK
RED	+ 5V DC	V	18	+ 5V DC	RED

(BASE COLOR/LINE COLOR)

*SEE PG. 5 FOR SPEAKER WIRING

TOP GUNNER: 56 PIN WIRING HARNESS

WIRE COLOR KEY:

Solder Side ←

→ Parts Side

Solder Side		Pin	Parts Side	
BLACK	GND	A 1	GND	BLACK
BLACK	GND	B 2	GND	BLACK
RED	+ 5V DC	C 3	+ 5V DC	RED
RED	+ 5V DC	D 4	+ 5V DC	RED
	(NOT USED)	E 5	(NOT USED)	
ORANGE	+ 12V DC	F 6	+ 12V DC	ORANGE
	KEY	H 7	KEY	
WHITE/RED	COIN COUNTER 2	J 8	COIN COUNTER 1	WHITE/BLACK
	(EMPTY)	K 9	(EMPTY)	
WHITE/GREEN	(Mono Speaker Output)	L 10	(Mono Speaker Output)	WHITE/BLUE
	(EMPTY)	M 11	(EMPTY)	
GREEN/WHITE	VIDEO GREEN	N 12	VIDEO RED	RED/WHITE
WHITE	VIDEO SYNC	P 13	VIDEO BLUE	BLUE/WHITE
YELLOW/BLACK	SERVICE SW	R 14	VIDEO GROUND	BLACK
	(EMPTY)	S 15	(EMPTY)	
YELLOW/RED	COIN 2	T 16	COIN 1	YELLOW/BLUE
WHITE/VIOLET	2P START	U 17	1P START <i>yellow white</i>	ORANGE /BLACK
WHITE/BROWN	2P UP	V 18	1P UP	WHITE/GRAY
ORANGE/WHITE	2P DOWN	W 19	1P DOWN	YELLOW/GRAY
ORANGE/RED <i>+ white</i>	2P LEFT	X 20	1P LEFT	YELLOW/GREEN
ORANGE/GRAY <i>white/black</i>	2P RIGHT	Y 21	1P RIGHT	ORANGE/BLUE
GRAY/RED <i>white/black</i>	2P SHOOT	Z 22	1P SHOOT	GRAY/BLACK <i>white</i>
GRAY/GREEN <i>+ white</i>	2P SHOOT 2	a 23	1P SHOOT 2	GRAY/BLUE <i>white</i>
	NOT USED	b 24	NOT USED	
	NOT USED	c 25	NOT USED	
	NOT USED	d 26	NOT USED	
BLACK	GND	e 27	GND	BLACK
BLACK	GND	f 28	GND	BLACK

(BASE COLOR/LINE COLOR)

DIP SWITCH SETTINGS

DIP SW No. 1 Settings

Coin 1 Switch Set

SW	4	3	2	1	COIN	PLAY
•	OFF	OFF	OFF	OFF	1	1
			OFF	ON	1	2
			ON	OFF	1	3
			ON	ON	1	4
	OFF	ON	OFF	OFF	1	5
			OFF	ON	1	6
			ON	OFF	1	7
			ON	ON	2	1
	ON	OFF	OFF	OFF	2	3
			OFF	ON	2	5
			ON	OFF	3	1
			ON	ON	3	2
	ON	ON	OFF	OFF	3	4
			OFF	ON	4	1
			ON	OFF	4	3
			ON	ON	FREE PLAY	

Coin 2 Switch Set

SW	8	7	6	5	COIN	PLAY
•	OFF	OFF	OFF	OFF	1	1
			OFF	ON	1	2
			ON	OFF	1	3
			ON	ON	1	4
	OFF	ON	OFF	OFF	1	5
			OFF	ON	1	6
			ON	OFF	1	7
			ON	ON	2	1
	ON	OFF	OFF	OFF	2	3
			OFF	ON	2	5
			ON	OFF	3	1
			ON	ON	3	2
	ON	ON	OFF	OFF	3	4
			OFF	ON	4	1
			ON	OFF	4	3
			ON	ON	INVALIDITY	

DIP SWITCH NO. 2 SETTINGS

THE NUMBER OF PLAYER'S LIFE

SW	1	2	NUMBER
•	OFF	OFF	2
	ON	OFF	3
	OFF	ON	4
	ON	ON	7

SOUND IN ATTRACT MODE

SW	8	SOUND
•	OFF	OFF
	ON	ON

*SW 3 NOT USED

NOT USED

SW	3
	OFF
	ON

DIP SWITCH NO. 3 SETTINGS

VIDEO SCREEN FLIP

SW	1	
•	OFF	NORMAL
	ON	UPSIDE DOWN

*SW 2, SW 3, & SW 4: NOT USED

BONUS SET

SW	4	5	FIRST	SECOND
•	OFF	OFF	30,000	150,000
	ON	OFF	50,000	250,000
	OFF	ON	30,000	N/A
	ON	ON	50,000	N/A

DIFFICULTY OF THE GAME

SW	6	7	DIFFICULTY
•	OFF	OFF	EASY
	ON	OFF	NORMAL
	OFF	ON	DIFFICULT
	ON	ON	VERY DIFFICULT

• SHOWS NORMAL SETTING

TOP GUNNER: MONITOR INFORMATION

SERVICE INSTRUCTIONS

NOTE: All monitors are equipped with automatic degaussing coils (L701) which demagnetize the picture tube every time the monitor is turned on after being off for a minimum of 5 minutes. Should any part of the chassis become magnetized it will be necessary to degauss the affected area with a manual degaussing coil. Move the coil slowly around the CRT face and all surrounding metal parts. Then slowly withdraw for a distance of 6 feet before turning off.

1.0 BLACK LEVEL CONTROL ADJUSTMENT

This control has been set at the factory and should not need further attention, however, when the game is connected a slight adjustment of VR201 may be necessary to obtain the proper black level (the black portion of the picture just extinguished).

2.0 VERTICAL SIZE (HEIGHT)

Location of this control is shown in Fig. 1. This control must be adjusted slowly, if necessary, until the picture or test pattern attains the correct vertical proportions.

3.0 CIRCUIT PROTECTION

A 4.0A pigtail fuse, mounted on the Main Board has been provided to protect the Power Output Circuit.

4.0 FOCUS

Adjust the focus control, located on the HV unit (T352), for maximum over-all definition and fine picture detail.

5.0 HORIZONTAL HOLD CONTROL ADJUSTMENT, VR351 (See Fig. 1)

A warm-up period of at least five minutes should be allowed before alignment is carried out. With the monitor being driven from the game signal, short TP601 to TP31. Adjust VR351 until the picture stops sliding horizontally. Remove the short.

6.0 HORIZONTAL VIDEO POSITION

If the video is off center on the raster some compensation can be made by adjusting this control.

7.0 VERTICAL RASTER POSITION ADJUSTMENT

If the video is off center vertically, (short dimension of picture tube) some compensation can be made by moving the vertical raster position adjustment jumper to either positions "U" or "D".

8.0 HORIZONTAL RASTER POSITION ADJUSTMENT

If the video is off center horizontally (long dimension of the picture tube) some compensation can be made by moving the horizontal raster position adjustment jumper to either positions "R" or "L".

9.0 HORIZONTAL WIDTH ADJUSTMENT

The horizontal width coil is a hexagonal tuning tool adjustment. This control must be adjusted slowly, if necessary, until the picture or test pattern attains the correct horizontal proportions.

* KONAMI GAMES ARE ALL NEGATIVE COMPOSIT SYNC. USE THE THREE PIN CONNECTOR ON THE MONITOR.

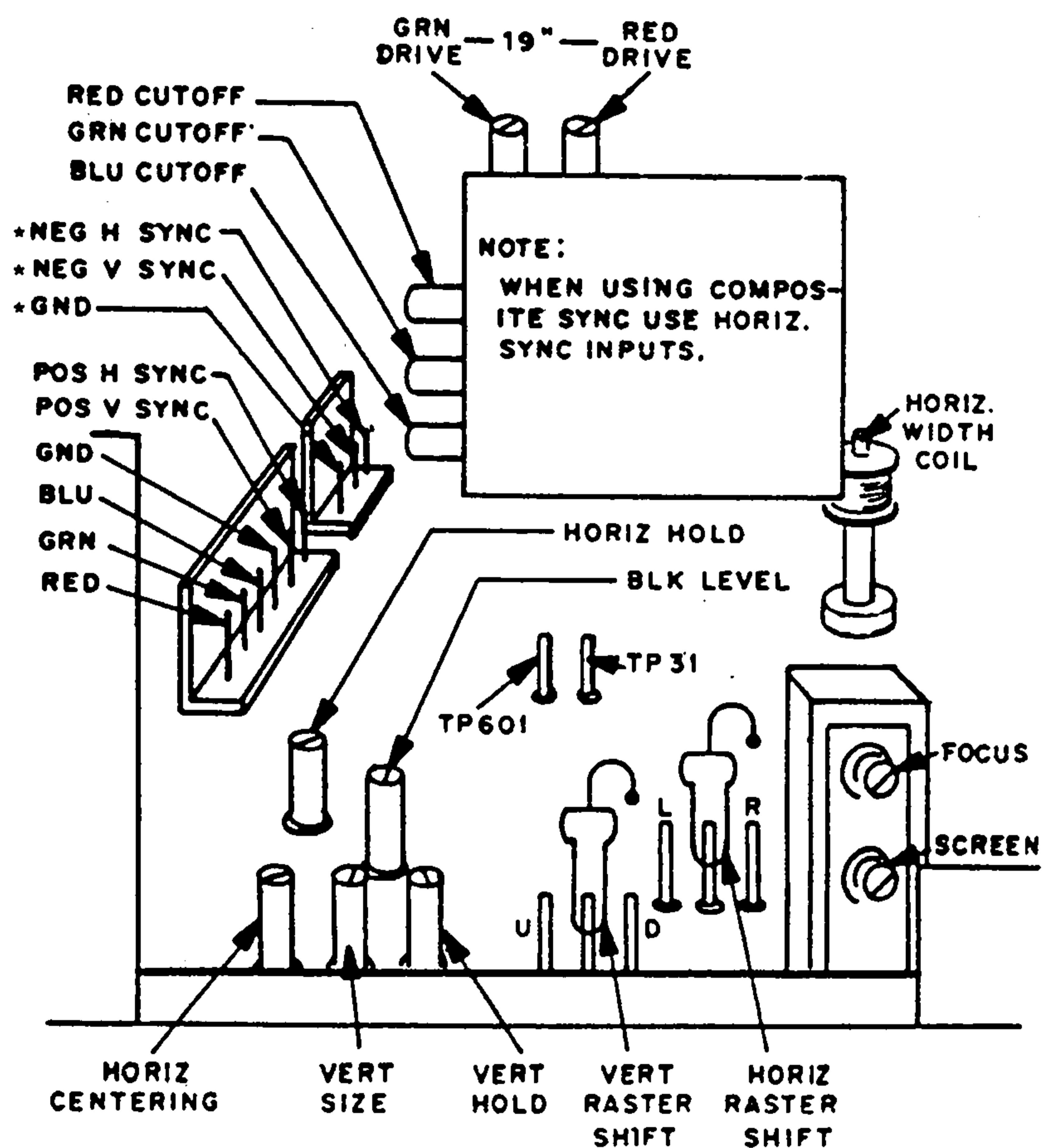

FIGURE 1

TOP GUNNER: MONITOR SPECIFICATIONS

TOP GUNNER requires a vertically mounted monitor. It also generates composite negative sync. If your monitor is composite positive sync, you will have to change to composite negative sync.

- (1) To alternate composite positive sync to composite negative sync, use 7404 IC or 74LS04 IC. The signal on the output pin from the P.C.B. is a combination of H-sync and V-sync.

NOTE: Please refer to Figure 2.

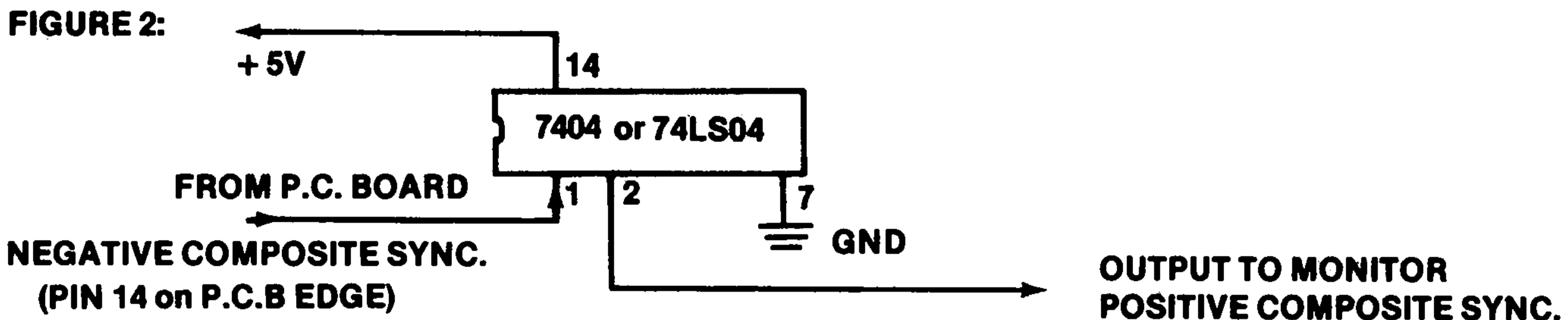

(+ 5V and GND should be taken out of the P.C. Board.)

- (2) Separate Sync modification for TOP GUNNER if your monitor has "Separate Sync" input. (For example "Electrohome brand" and "Wells-Gardner brand.")

Step 1

WIRING HARNESS

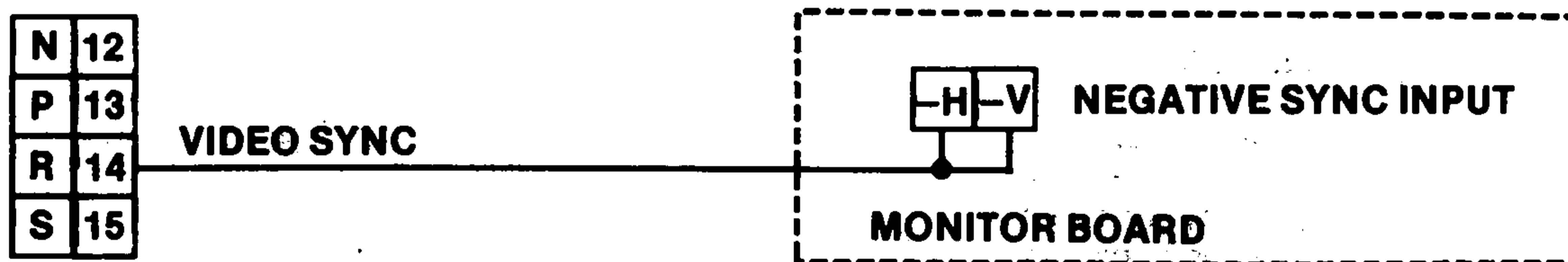

If the picture is still not stable...

Step 2

Prepare Hook-up wire to separate -H and -V sync. signals.

WIRING HARNESS

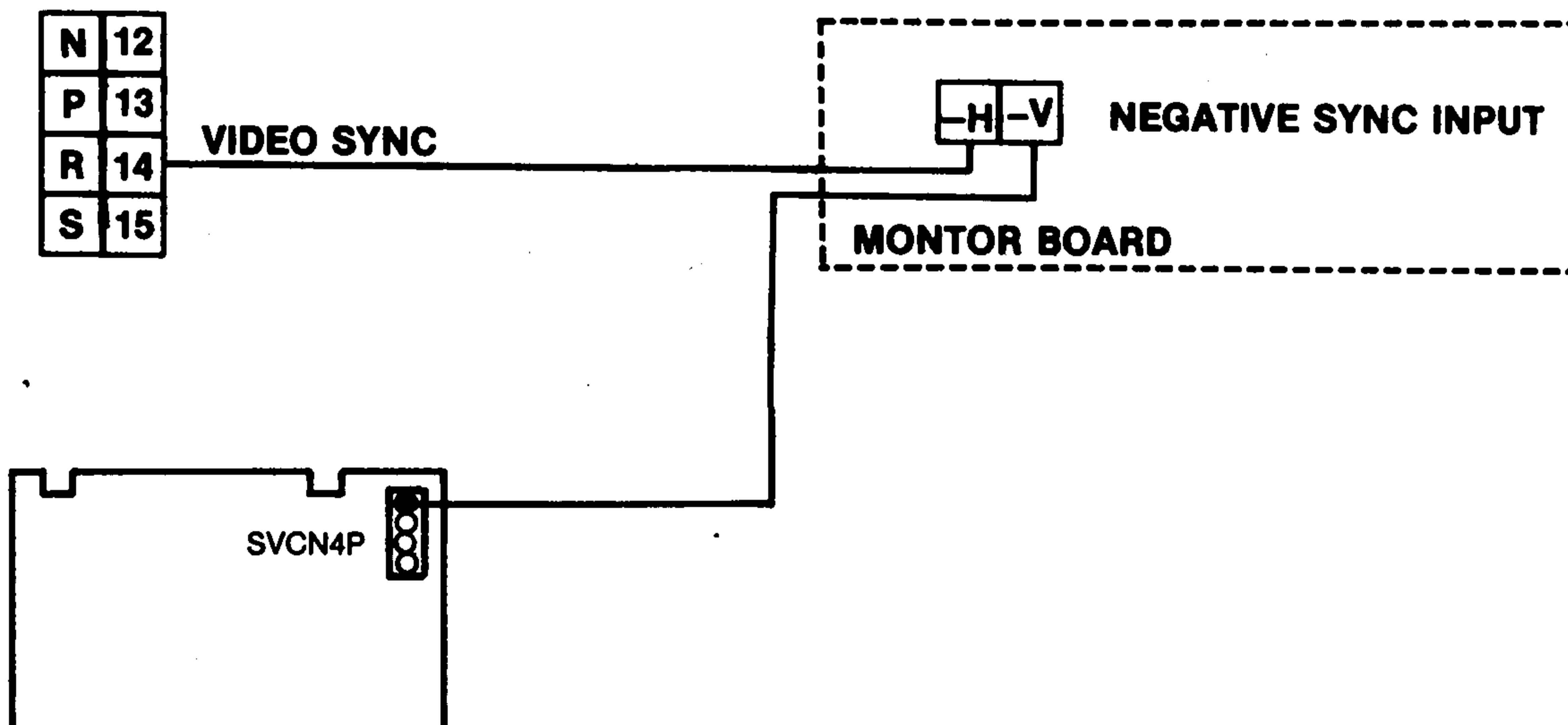

A

B

C

D

E

F

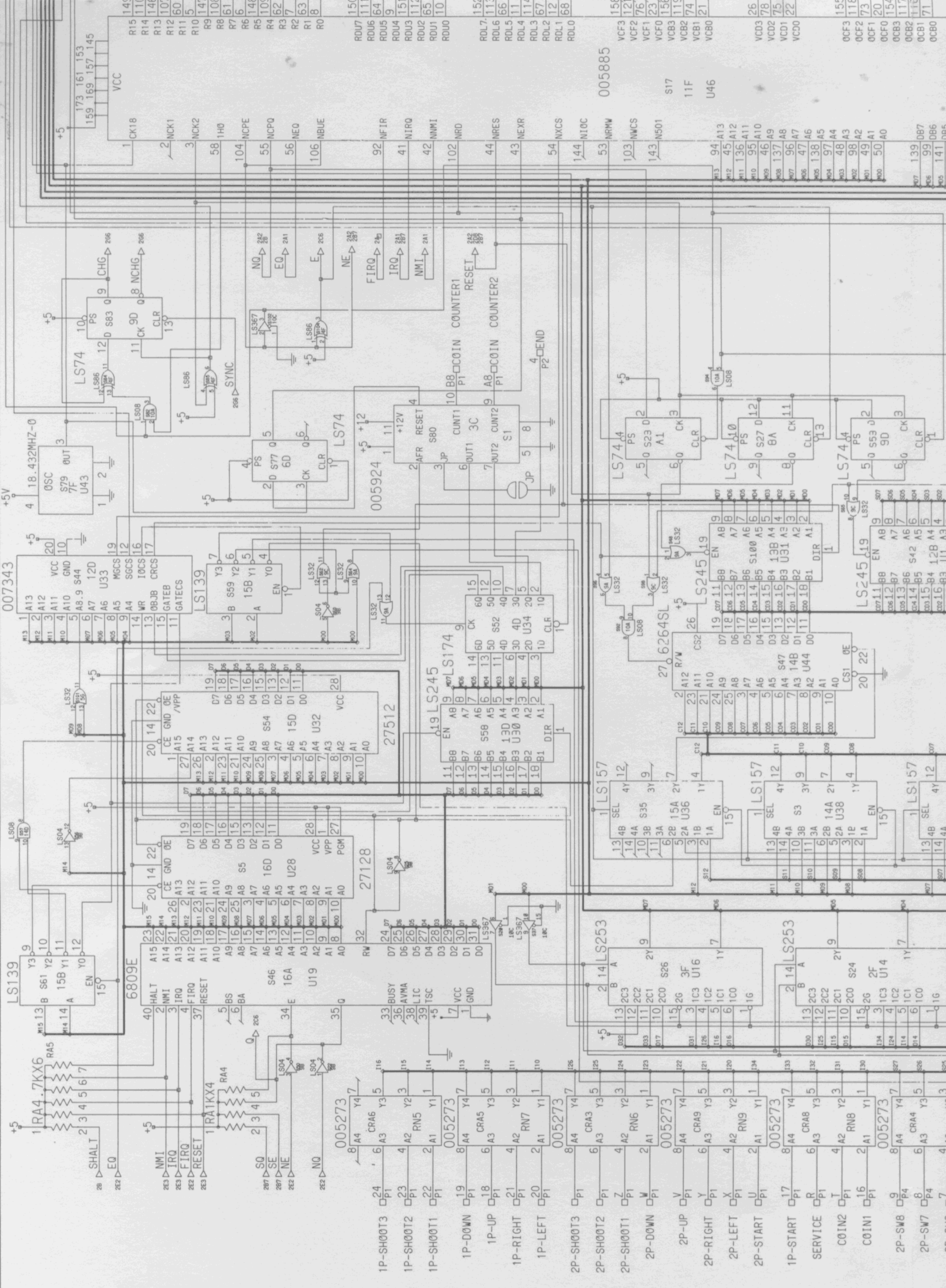

1

2

3

4

5

A

B

C

D

E

F

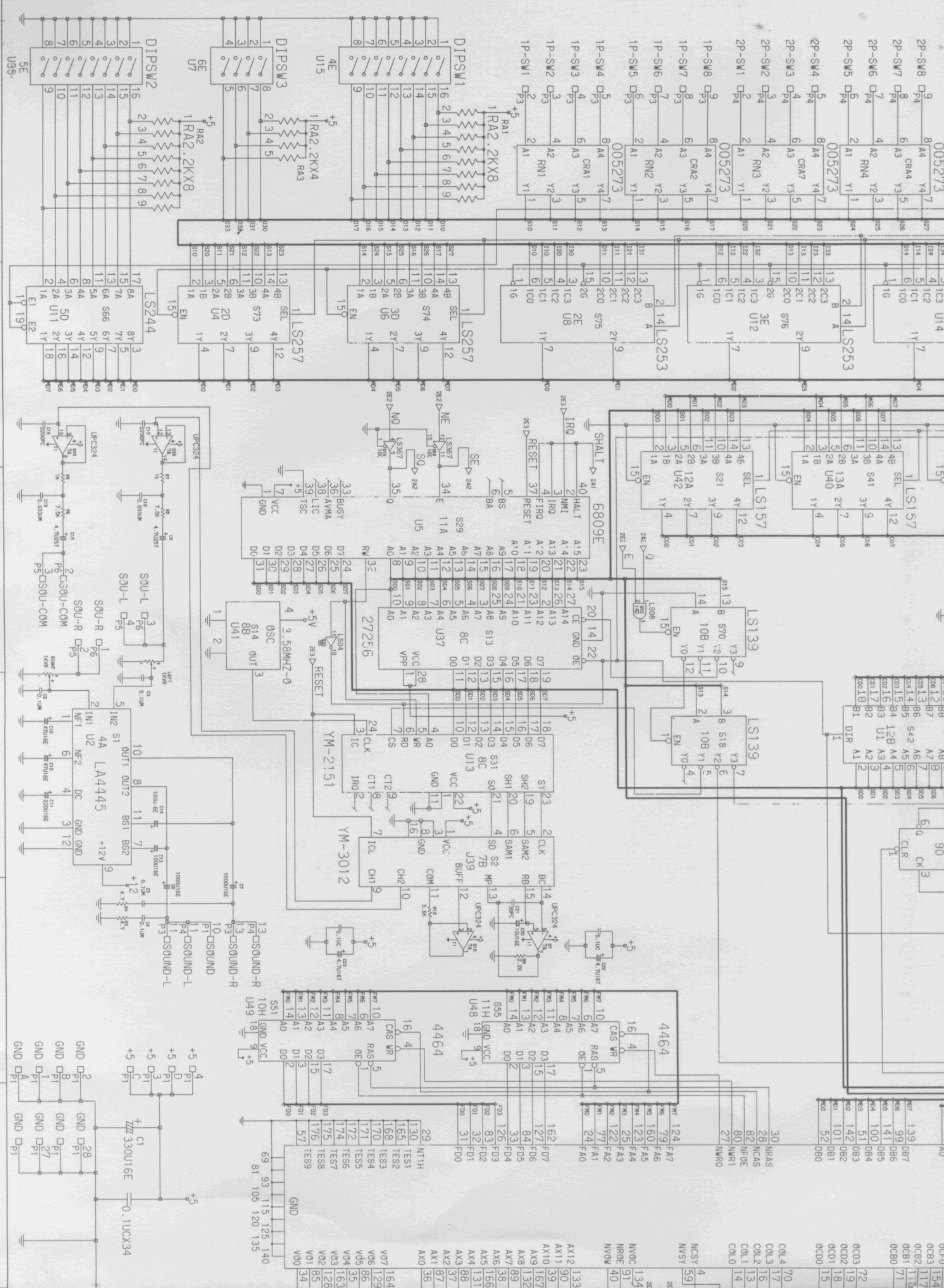

G

H

I

J

K

1

2

3

4

5

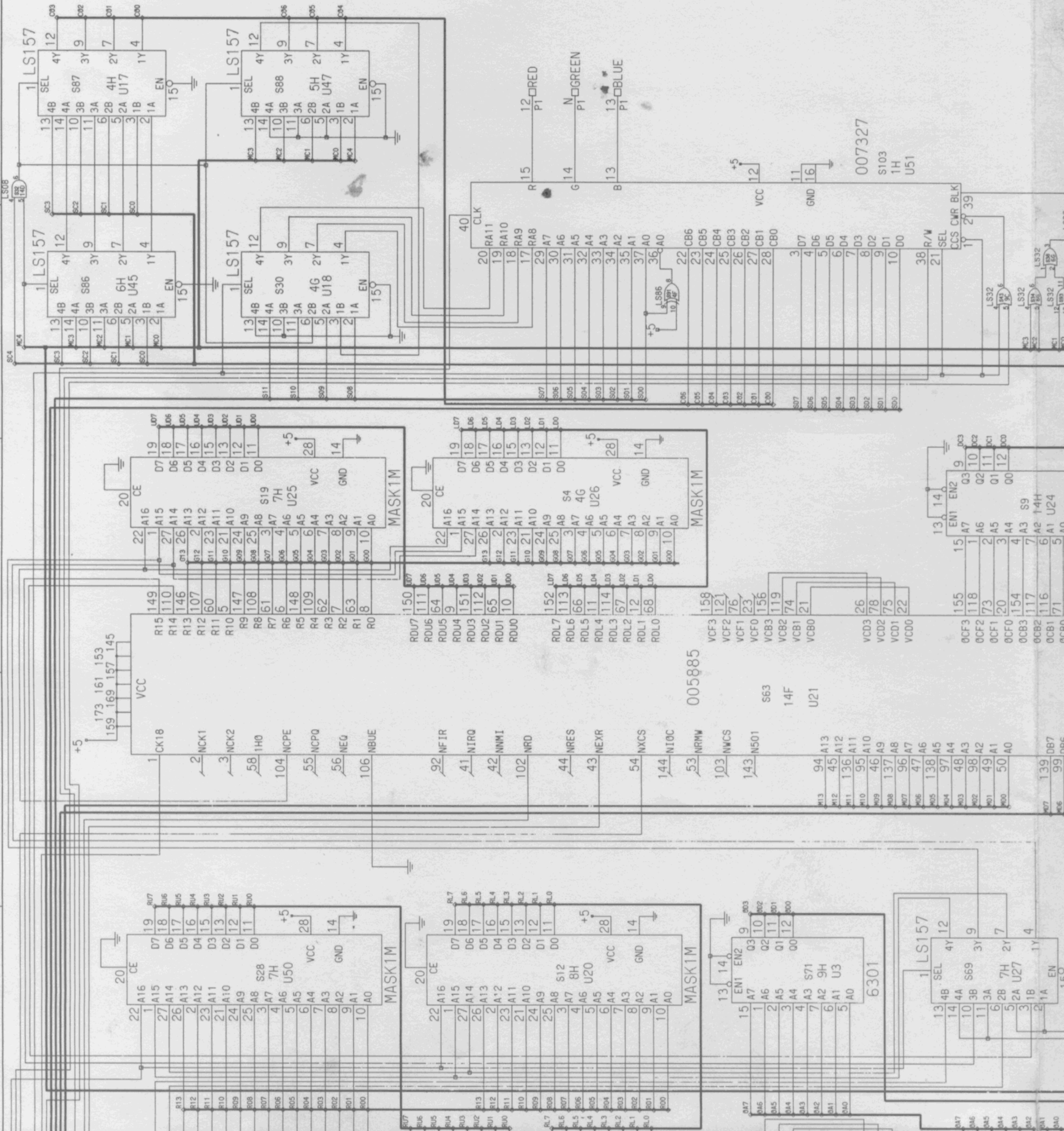

007327

S103
1H
U51

005885

S63

14F

U21

6301

LS157

LS32

LS32

LS32

LS32

LS32

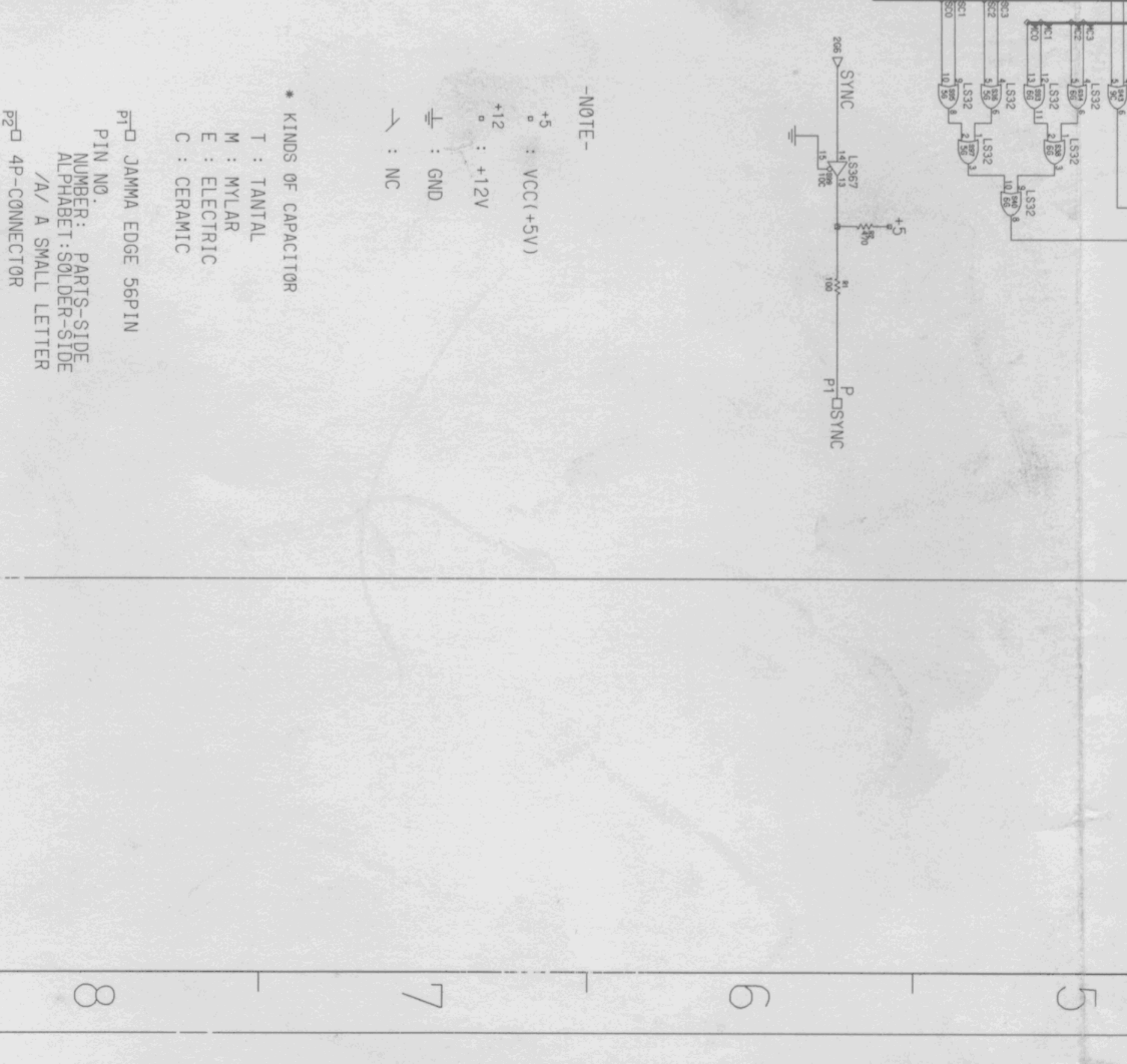
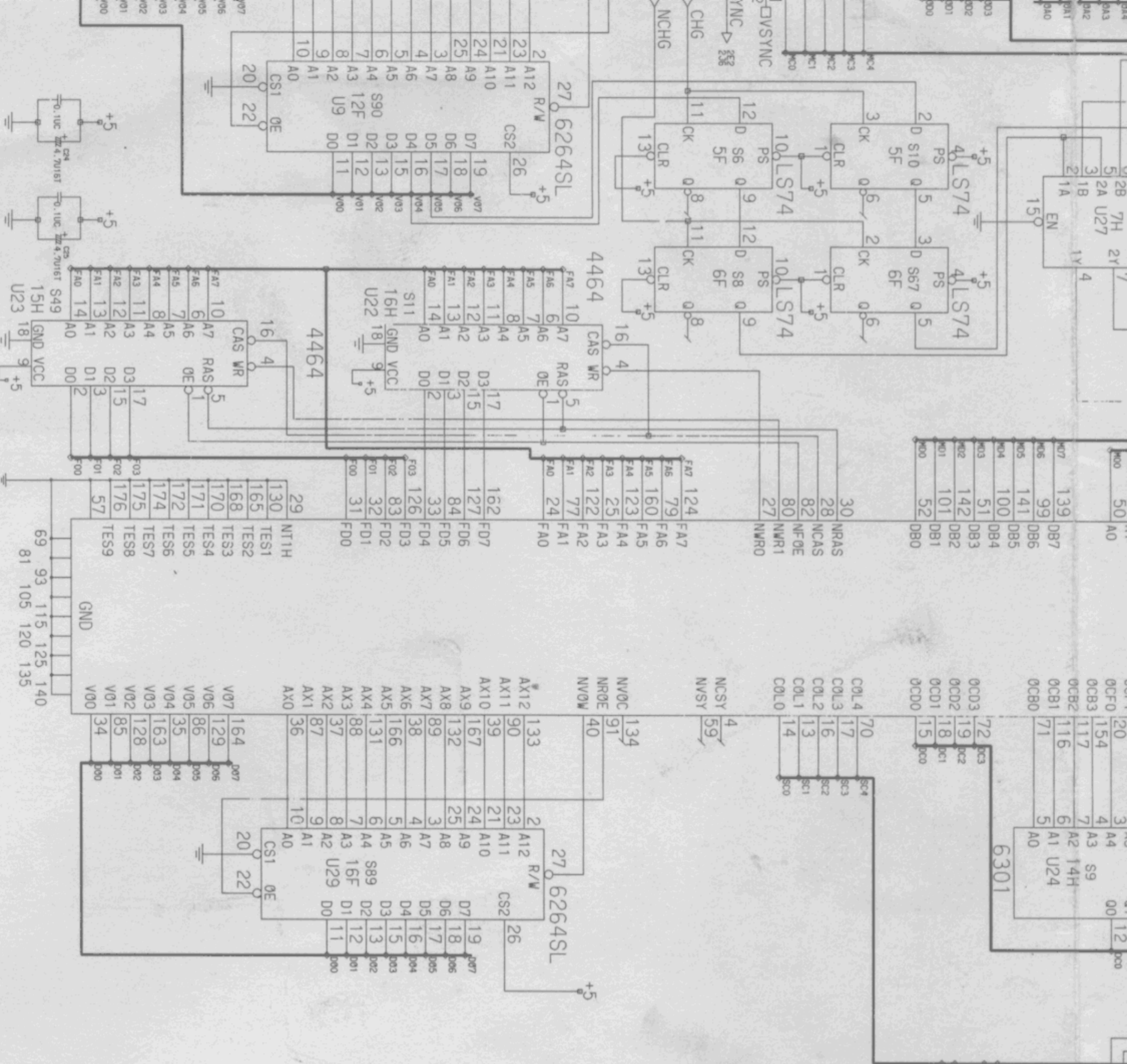

-NOTE-
 +5 : VCC(+5V)
 +12 : +12V
 : GND
 : NC

* KINDS OF CAPACITOR
 T : TANTAL
 M : MYLAR
 E : ELECTRIC
 C : CERAMIC

P1 □ JAMMA EDGE 56PIN
 PIN NO.
 NUMBER: PARTS-SIDE
 ALPHABET: SOLDER-SIDE
 /A/ A SMALL LETTER

P2 □ 4P-CONNECTOR
 P3 □ 13P-CONNECTOR
 P4 □ 1P ROTARY SW. SOUND
 P5 □ 13P-CONNECTOR
 P6 □ 2P ROTARY SW. SOUND
 M0N0 4P-CONNECTOR
 STEREO

Konami		KONAMI INDUSTRY CO., LTD.		REG. TYPE	SCHEMATIC DIAGRAM		
		DESIGN	DRAW	CHECK	APPROVE	NAME	GX631 PWB302067A
M.	M.	IDAKA	IDAKA	SCALE	RELEASE DATE	86.6.27	
				TOLERANCE	A1	CODE NO.	101006

G H I J K L

TOP GUNNER: STEREO/MONO SOUND INSTALLATION

Konami introduces stereo sound.

Please read instructions carefully. If your video cabinet doesn't utilize two speakers, follow instructions for mono output.

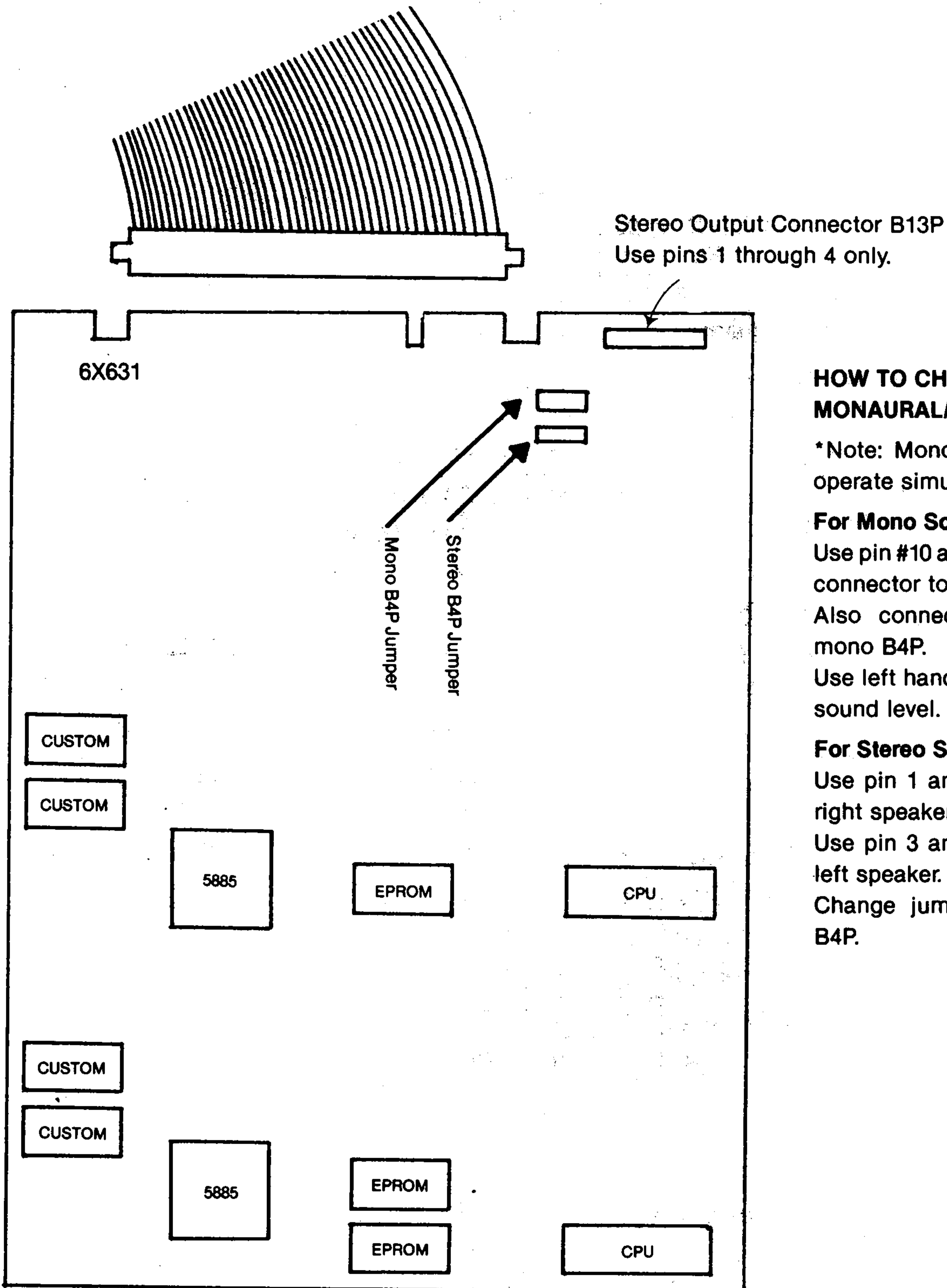

HOW TO CHANGE TO MONAURAL/STEREO

*Note: Mono & Stereo sound *cannot* operate simultaneously.

For Mono Sound

Use pin #10 and Pin L of the 56 pin edge connector to the speaker contacts.

Also connect Jumper connector to mono B4P.

Use left hand volume control to adjust sound level.

For Stereo Sound

Use pin 1 and 2 of connector B13 for right speaker.

Use pin 3 and 4 of connector B13 for left speaker.

Change jumper connector to stereo B4P.

TOP GUNNER

WIRING DIAGRAM

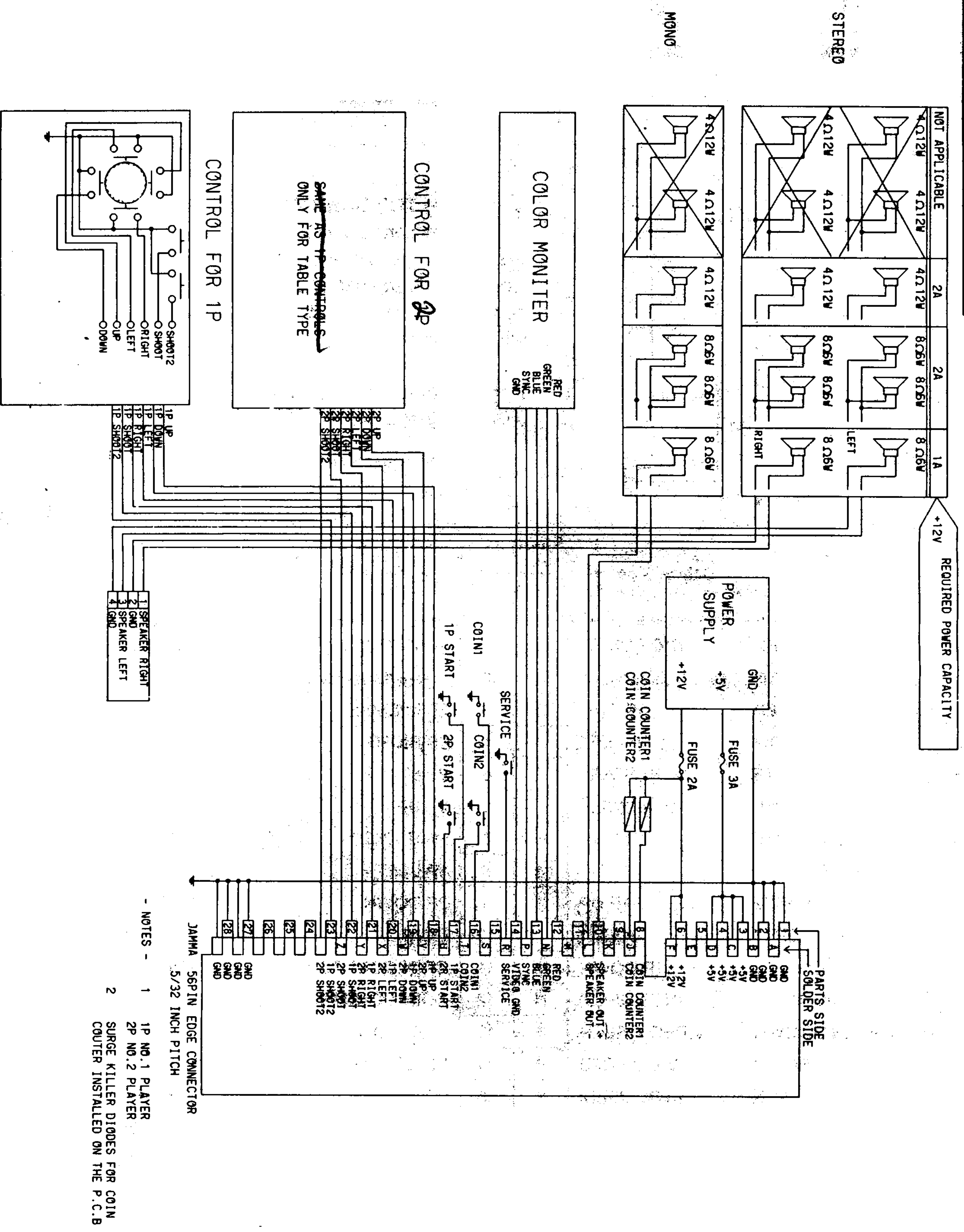

+12V REQUIRED POWER CAPACITY

STEREO
MONO

COLOR MONITOR
RED
GREEN
BLUE
SYNC
GND

CONTROL FOR 2P
~~SAME AS 1P CONTROLS~~
ONLY FOR TABLE TYPE

CONTROL FOR 1P
SHOOT
UP
DOWN
LEFT
RIGHT

1 SPEAKER RIGHT
2 GND
3 SPEAKER LEFT
4 GND

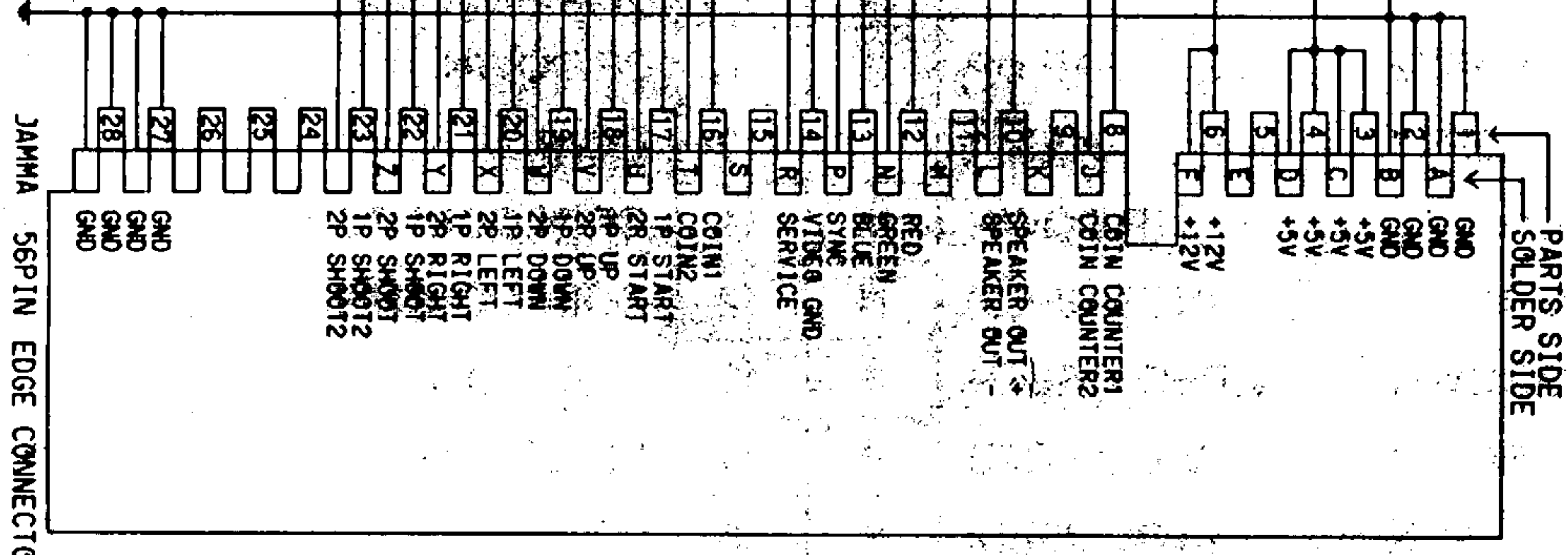

- NOTES -
- 1P NO. 1 PLAYER
 - 2P NO. 2 PLAYER
 - SURGE KILLER DIODES FOR COIN COUNTER INSTALLED ON THE P.C.B

USER INFORMATION
WARNING
F.C.C. REGULATION COMPLIANCE

THIS KIT IS INTENDED FOR USE ONLY ON COIN-OPERATED VIDEO GAMES MANUFACTURED AFTER OCTOBER 1, 1983 WHICH HAVE BEEN VERIFIED FOR COMPLIANCE WITH REQUIREMENTS IN PART 15 OF F.C.C. RULES FOR A CLASS A COMPUTING DEVICE.

IMPROPER CONNECTION OF THIS KIT OR CONNECTION TO ANY OTHER GAME NOT SO MANUFACTURED OR VERIFIED FOR COMPLIANCE MAY CAUSE UNACCEPTABLE INTERFERENCE TO RADIO AND T.V. RECEPTION, REQUIRING THE OPERATOR TO TAKE WHATEVER STEPS ARE NECESSARY TO CORRECT THE INTERFERENCE.

THE P.C. BOARD CAGE SUPPLIED WITH THIS CONVERSION KIT MUST BE UTILIZED AND TERMINATED TO GROUND AT THE TIME OF INSTALLATION.



815 Mittel Drive, Wood Dale, Illinois 60191
Telephone: (312) 595-1443, Telex: 6871385 KONAM UW, Fax: (312) 595-2973
For Technical Assistance Call Toll Free (800) 222-6181 (Outside Illinois)