

TOMYTRONIC®

TRON

INSTRUCTIONS

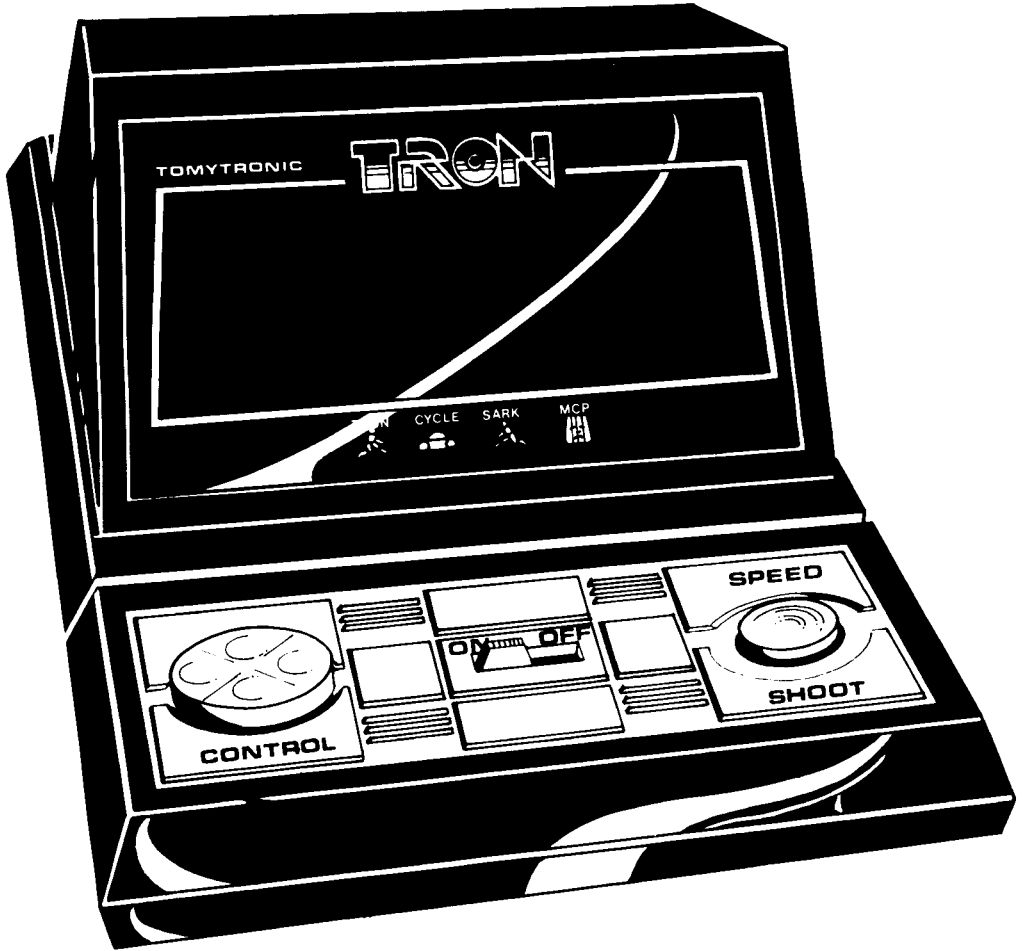

TOMY®

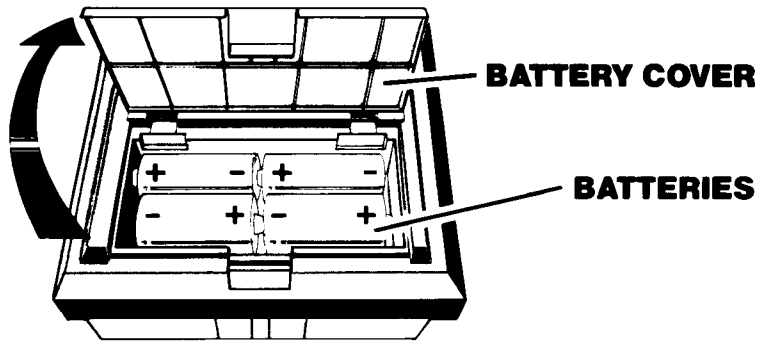

ILLUSTRATION 1

INSERT BATTERIES:

Set the On/Off switch to the Off position. Turn the game over and lift the battery cover. SEE ILLUSTRATION 1. Insert four "C" size Alkaline batteries, not included.

An AC Adapter may also be used. Recommended AC Adapters:
 Archer Cat. No. 270-1551 A
 Recoton Model No. AD-10UL
 AC Adapter Requirements:
 Output: 7.5 V DC 200mA
 Plug: 2.1mm ID Coaxial Type
 Tip (Center) Polarity: Negative

OBJECT OF THE GAME:

You must try to destroy the Enemy; Sark and the MCP (Master Control Program) by making the Enemy Light Cycle crash and by destroying Sark's Rings and finally by penetrating the MCP Barrier and destroying the MCP.

CONTROL BUTTON ON/OFF SWITCH SPEED / SHOOT BUTTON

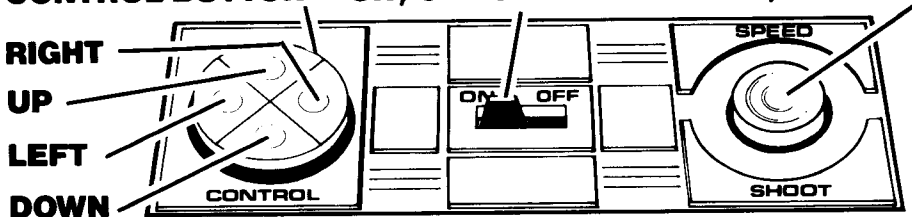

ILLUSTRATION 2

HOW TO PLAY:

Set the On/Off switch to the On position. SEE ILLUSTRATION 2. A pattern will move across the screen and a fanfare will sound.

The first screen will show your four Tron figures on the left, the four Enemy Sark figures on the right, three red and green Enemy Light Cycles, the MCP on the far right and your beginning score "0". SEE ILLUSTRATION 3.

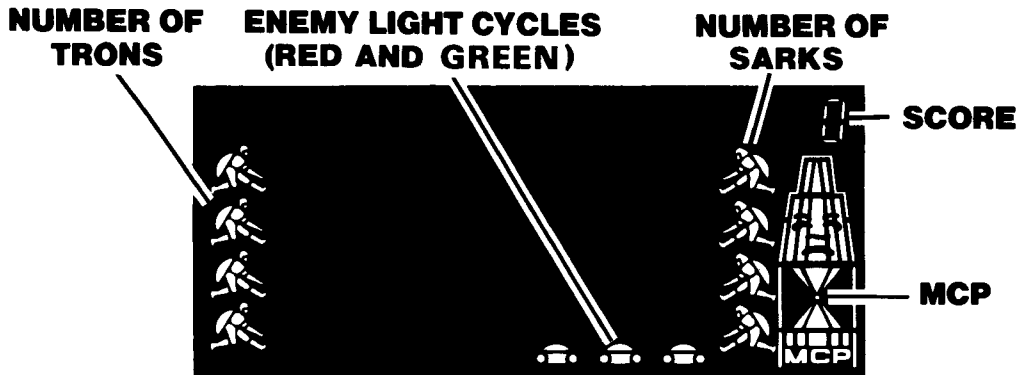

ILLUSTRATION 3

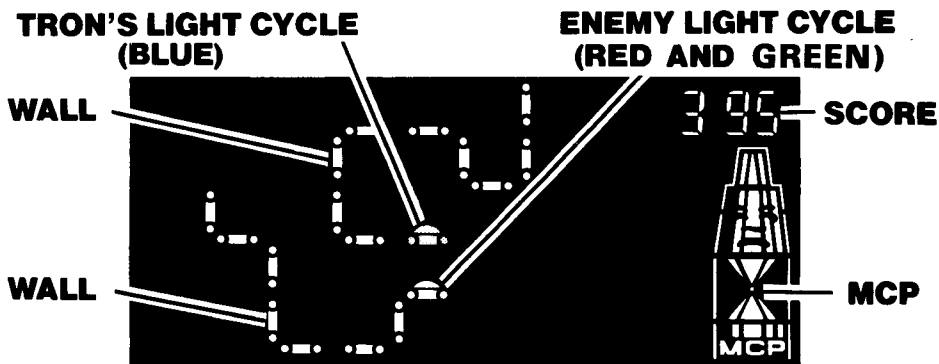

ILLUSTRATION 4

LEVEL 1-LIGHT CYCLE GAME

The first level, the Light Cycle Game, begins with two Light Cycles on the screen. The blue one is Tron's and the red and green Light Cycle is the enemy's. By pressing the Control button you can control the direction of Tron's Light Cycle. SEE ILLUSTRATION 2. By holding the Speed/Shoot button you can accelerate Tron's Light Cycle. When released, Tron's Light Cycle will automatically slow down. As both Light Cycles travel across the screen they create a wall behind them. SEE ILLUSTRATION 4. Parts of the wall remains off of the screen. You must try to destroy the Enemy Light Cycle by causing it to crash into a wall while avoiding crashing into a wall or the Enemy Light Cycle. You must be at least two cycle lengths in front of the Enemy Light Cycle to block it off. Try to build a wall around the Enemy Light Cycle.

When the Enemy Light Cycle disappears off of the screen you should slow your Light Cycle because the Enemy Light Cycle may appear from any point. If both Light Cycles crash Tron loses. When Tron's Light Cycle crashes the score appears with one less Tron figure and the race continues until all of Tron's Light Cycles are destroyed or all Enemy Light Cycles are destroyed.

When all three Enemy Light Cycles are destroyed the screen proceeds to the next level.

The skill level increases after all three levels are completed. Both Light Cycles move faster as the skill level increases.

Scoring: 5 points for moving ahead and creating five Tron wall bars
100 points for destroying each Enemy Light Cycle

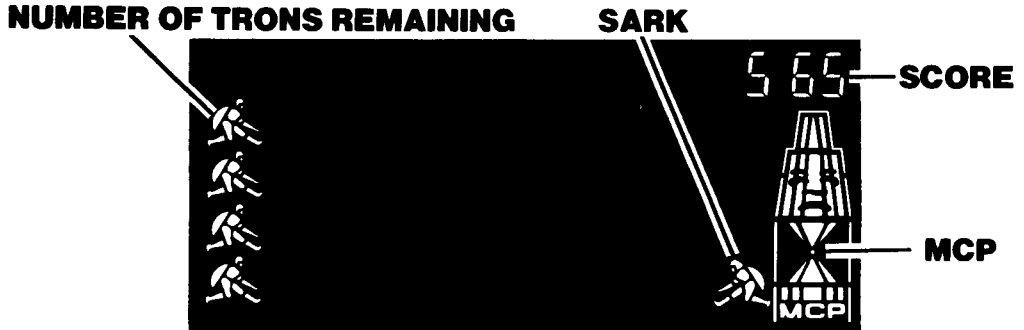

ILLUSTRATION 5

On the next screen will appear the number of Trons remaining and the number of Sark for the next level. The score up to that point will appear in the top right corner. SEE ILLUSTRATION 5.

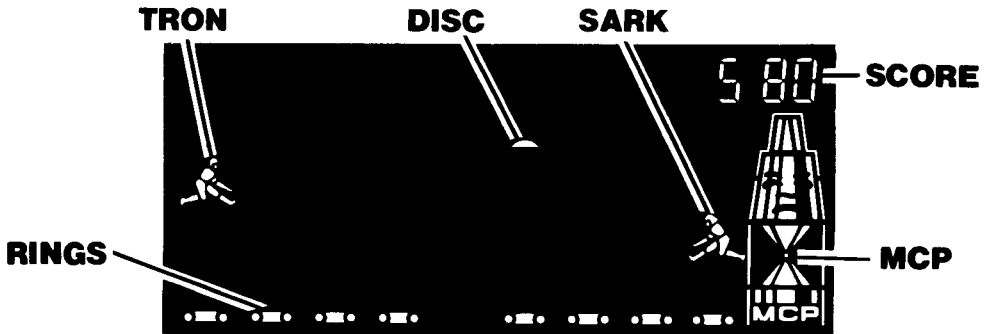

ILLUSTRATION 6

LEVEL 2-RING GAME

The second level is the Ring Game. Tron is on the left and Sark is on the right. The green bars beneath each figure represent the four concentric Rings each player begins with. SEE ILLUSTRATION 6.

Sark begins moving up and down then tosses his Disc. The Disc rebounds off of the top of the screen and moves towards Tron. By using the Control button move Tron up or down to catch the Disc. Position Tron and press the Speed/Shoot button to throw the Disc back to where Sark cannot catch it. If either one misses it they lose one Ring below them. When Sark loses all four Rings the game moves on to the next level.

The skill level increases after all three levels are completed. Only Sark increases his speed as the skill level increases.

Scoring: 5 points for catching each Disc
20 points for destroying the Enemy's Rings
200 points for destroying all Rings

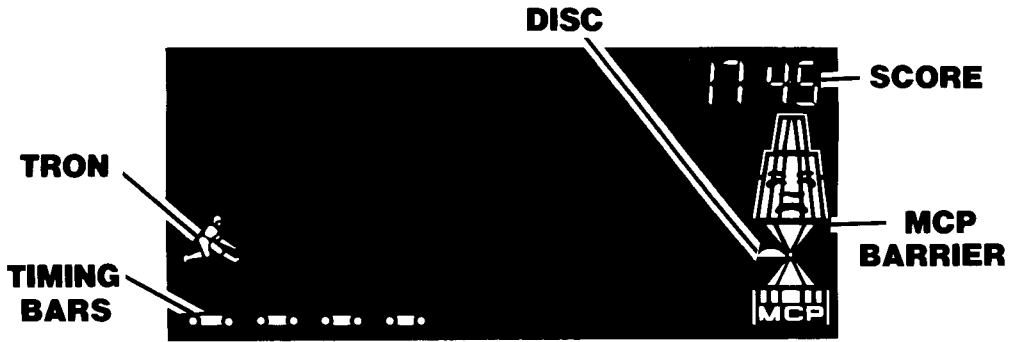

ILLUSTRATION 7

LEVEL 3-MCP GAME

The third level is the MCP Game. Tron is on the left in a stationary position. Below him are bars that act as timers. The number of bars equals the number of Tron's remaining Rings from the Ring Game. Press the Speed/ Shoot button to throw one Disc at the MCP Barrier. The Barrier will begin to move up and down. Try to pick the correct timing to press the Speed/ Shoot button again and release a Disc to penetrate the Barrier and destroy the MCP. SEE ILLUSTRATION 7.

If the Disc fails to penetrate the Barrier it will fly off of the screen. You must release another Disc to create an opening in the MCP Barrier and try timing the next Disc again. If all bars disappear before you destroy the MCP, the score will appear and there will be one less Tron figure.

When the MCP is destroyed it will flash then the score will appear and the game continues again at the Light Cycle Game.

The skill level increases after all three levels are completed. The Barrier around the MCP moves faster and the time for each bar is shorter as the skill level increases. The speed on all levels increases six times then remains the same speed.

Scoring: 200 points for destroying the MCP
 Bonus points-50 points x the number of remaining timing bars

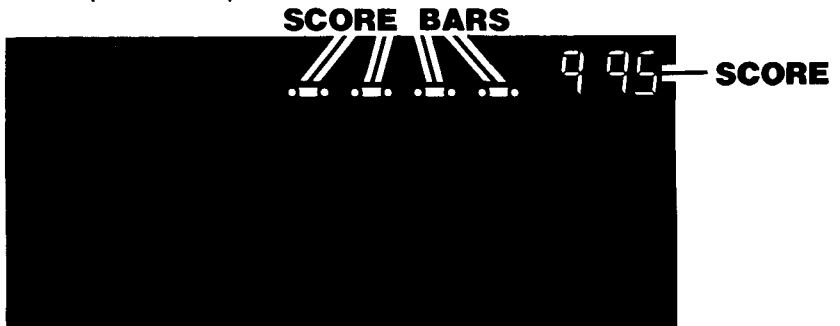

ILLUSTRATION 8

4 Green bars = 8,000 points
 plus 995 points
 Total score = 8,995 points

SCORING:

The highest score that can be recorded is 1,995 points, anything over 2,000 points appears as a green bar on the top of the screen when your total score is shown. Your total score appears between each level and when you lose a Tron. The highest score possible is 15,995 points which will appear as seven green bars each worth 2,000 points plus 1,995 points. SEE ILLUSTRATION 8. After this maximum score the screen will return to "0" and the game continues. By reaching a score of 2,000 points you gain one additional Tron figure with a maximum of five Trons at one time.

The game ends when all of your Trons are destroyed.

TAKING CARE OF YOUR GAME:

Your TRON game uses a micro-processor so handle it as you would any electronic game.

- * Don't expose it to excessive cold or excessive heat; for example, in the glove compartment of a car on a hot, sunny day or near a heater vent.
- * Avoid getting it wet or dirty.
- * Don't take it apart.
- * Don't shake or drop it.
- * Turn the game off when not in use and remove batteries if you plan to store the game.
- * Don't leave any dead batteries in your game.

If the batteries become weak the display screen will become dark and show incorrect action.

No: 7601

© MCMLXXXI Walt Disney Productions

© 1982 TOMY CORP., 901 E. 233rd Street, P.O. Box 6252, Carson, CA 90749

www.handheldmuseum.com

PRINTED IN JAPAN