

# **namco®**



# **TEKKEN 4**

## **Game PCB Kit**

Connections  
and  
Adjustments



## NOTICE

**MAGICGATE** is a term to describe a copyright protection technology created by Sony Group. This **MAGICGATE** mark does not necessarily guarantee compatibility with other products bearing the “MagicGate” trademark.

**MAGICGATE** is a trademark of Sony Corporation.

**MAGICGATE** est un terme décrivant une technique de protection de copyright créée par Sony Group. **MAGICGATE** ne garantit pas nécessairement de compatibilité avec d'autres produits portant la marque de commerce “MagicGate”

**MAGICGATE** est une marque de commerce de Sony Corporation.

The DVD-ROM DISC supplied with the product must not be copied, modified, distributed, or used for the purposes other than the operation of the product. Copyright laws protect the contents of the DVD-ROM DISC. Infringement of copyright laws may be subject to criminal penalties.

Do not use the supplied DVD-ROM DISC with other product models or other media formats. Doing so may result in equipment failure.

# Contents

KIT CONTENTS .....	5
1. SPECIFICATIONS .....	7
2. CABINET CONNECTIONS (Standard Jamma) .....	7
3. CABINET CONNECTIONS (JVS Standard) .....	11
4. FITTING THE DONGLE .....	12
5. FITTING THE CD-ROM DISC .....	13
6. ADJUSTMENTS AND SETTINGS .....	15
6-1 Option Switches .....	15
6-2 Test Mode .....	16
6-2-1 Display Test .....	16
6-2-2 Colour Edit .....	18
6-2-3 Convergence .....	18
6-2-4 Interlace .....	19
6-2-5 Input Test .....	20
6-2-6 Game Options .....	21
6-2-7 Coin Options .....	22
6-2-8 Sound Test .....	23
6-2-9 JVS Status .....	23
6-2-10 A. D. S - (Book Keeping) .....	24
6-2-11 Data Clear .....	25

## KIT CONTENTS

Description	Part No	Quantity
Tekken 4 PCB Rack Assy	XTEK4-PCB	1
DVD Rom CD Disc	XTEK4-CDROM	1
Jamma (B) PCB	XTEK4-JAMMA	1
Rack Assy to Jamma (B) PCB connecting cables	Power Supply Loom	1
	RGB Video Loom	1
	RCA (Phono) Audio Loom	1
	Data Loom	1
Amp EI connectors to 48way Edge Adaptor Loom	69200067	1
Amp EI connectors with Flying Leads Loom	69200066	1
Button Decals		1 set
Instruction Card		1
Move List Card		1
Title Board		1
Tekken 4 Promotional Poster		1
Top Flash	40000703	1
Universal Cabinet Side Decal - LHS / RHS	40000704	2
Header Decal	40000705	1
Connection and Adjustment Manual	90500133	1

## 1. SPECIFICATIONS

**COMPATIBILITY:** JAMMA STANDARD (with JAMMA (B) PCB)  
JAMMA VIDEO STANDARD (JVS)

**PCB INPUT POWER:** +5v ( $\pm 5\%$ ) @ 7A (Min), +12v ( $\pm 5\%$ ) @ 2A (Min)

**OPERATING ENVIRONMENT:** Temperature +5°C to +45°C  
Humidity 10% to 85% (no condensation)

**MONITOR ORIENTATION AND SIGNAL:** Horizontal Orientation  
Horizontal Frequency 15kHz / 31kHz (selectable)

RGB output level 0.7V p-p / 3.0V p-p (selectable)  
when set to 15kHz  
0.7V p-p when set to 31kHz

Composite Sync / Separate Sync (selectable)

2. CABINET CONNECTIONS (Standard Jamma)

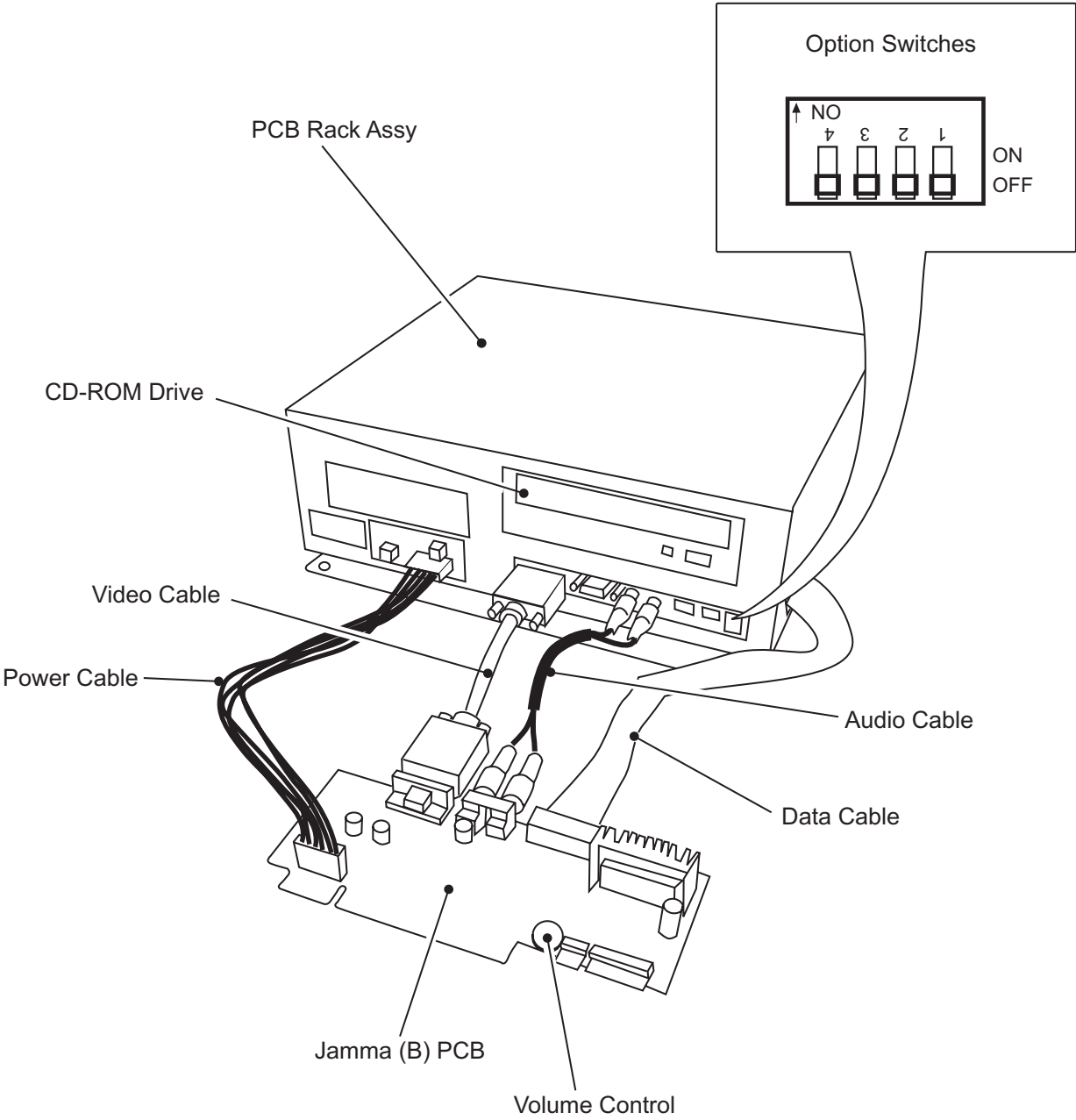

The JAMMA (B) PCB is connected to the game cabinet with a 56way Edge Connector (standard JAMMA) and 4 and 10way AMP EI Connectors.

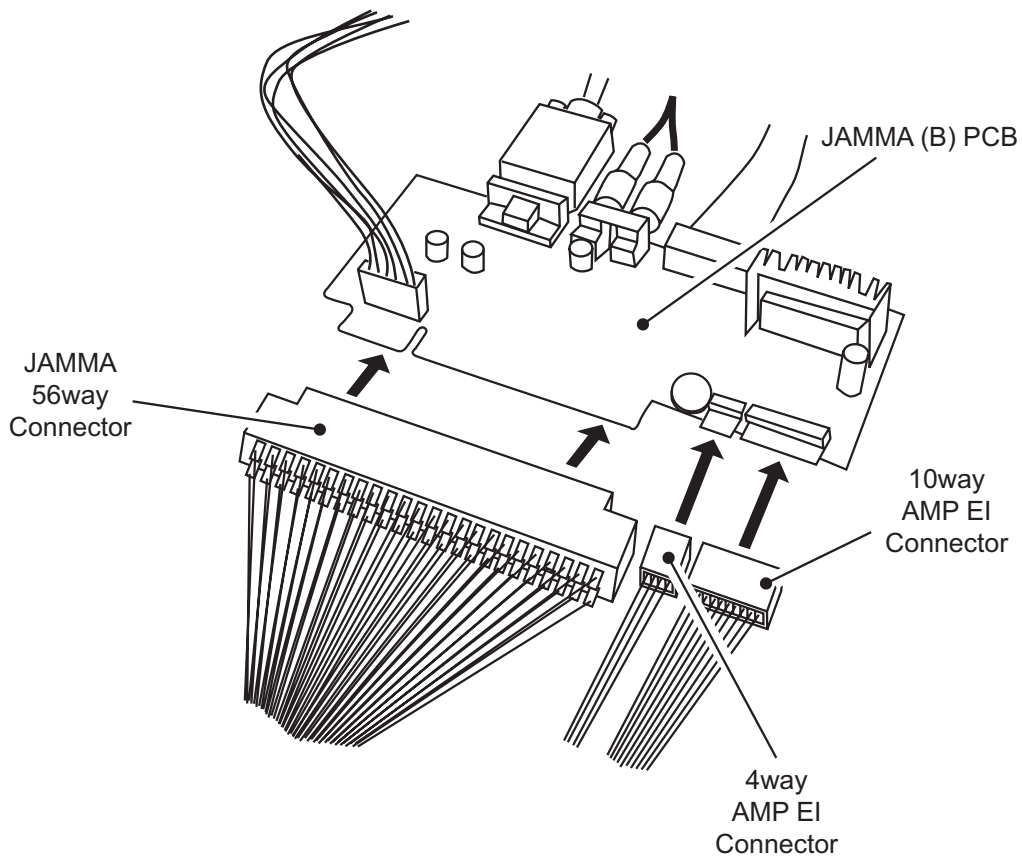

*Note: Supplied in the Kit is an Amp EI connectors to 48way extender card adaptor loom, for cabinets with an existing 48way connector, and an AMP EI connectors with flying leads loom for cabinets without a 48way connection.*



4 and 10way AMP EI Connector with 48way Extender Card  
Part No. 69200067



4 and 10way AMP EI Connector with flying leads  
Part No.69200066



## Connections for Standard JAMMA Cabinet

<b>TEKKEN 4</b>			
JAMMA 56way Edge Connector			
Solder Side	Terminal No		Component Side
GND	A	1	GND
GND	B	2	GND
+5volt	C	3	+5volt
+5volt	D	4	+5volt
	E	5	
+12volt	F	6	+12volt
Polarizing Key	G	7	Polarizing Key
Coin Counter 2	H	8	Coin Counter 1
	J	9	
L Speaker (-)	K	10	L Speaker (+)
Audio (-) (mono)	L	11	Audio (+) (mono)
Video GREEN	M	12	Video RED
Video SYNC	N	13	Video BLUE
SERVICE	P	14	Video GND
	R	15	TEST
Coin Switch 2	S	16	Coin Switch 1
P2 START	T	17	P1 START
P2 Lever UP	U	18	P1 Lever UP
P2 Lever DOWN	V	19	P1 Lever DOWN
P2 Lever LEFT	W	20	P1 Lever LEFT
P2 Lever RIGHT	Y	21	P1 Lever RIGHT
P2 PUNCH (Left) Sw1	Z	22	P1 PUNCH (Left) Sw1
P2 PUNCH (Right) Sw2	a	23	P1 PUNCH (Right) Sw2
P2 Sw3 Not used	b	24	P1 Sw3 Not Used
	c	25	
	d	26	
GND	e	27	GND
GND	f	28	GND

<b>TEKKEN 4</b>	
10way AMP EI Connector	
Pin No	Description
1	GND
2	
3	P2 KICK (Right) Sw5
4	P2 KICK (Left) Sw4
5	
6	
7	P1 KICK (Right) Sw5
8	P1 KICK (Left) Sw4
9	
10	GND

<b>TEKKEN 4</b>	
4way AMP EI Connector	
Pin No	Description
1	
2	
3	R Speaker (+)
4	R Speaker (-)

**Connector Loom  
(Part no 69200066)**

**Adaptor for Earlier Tekken Series Cabinets  
with 48way Edge Connector  
(Part No 69200067)**

<b>PREVIOUS TEKKEN GAMES</b>						
48way Extension Connector						
Solder Side		Terminal No		Component Side		
4w AMP EI pin 4	R Speaker (-)	A24	B24	R Speaker (+)	4w AMP EI pin 3	
		A23	B23			
		A22	B22			
		A21	B21			
	Polarizing Key	A20	B20	Polarizing Key		
	A19	B19				
	A18	B18				
10w AMP EI pin 4	P2 KICK (Left) Sw4	A17	B17	P2 KICK (Right) Sw5	10w AMP EI pin 3	
		A16	B16			
		A15	B15	GND		10w AMP EI pin 10
		A14	B14	GND		10w AMP EI pin 10
		A13	B13			
	A12	B12				
	A11	B11				
	A10	B10				
	A9	B9				
	A8	B8	GND	10w AMP EI pin 1		
	A7	B7	GND	10w AMP EI pin 1		
	A6	B6	P1 KICK (Right) Sw5	10w AMP EI pin 7		
10w AMP EI pin 8	P1 KICK (Left) Sw4	A5	B5			
		A4	B4			
		A3	B3			
		A2	B2			
		A1	B1			

### 3. CABINET CONNECTIONS (JVS Standard)

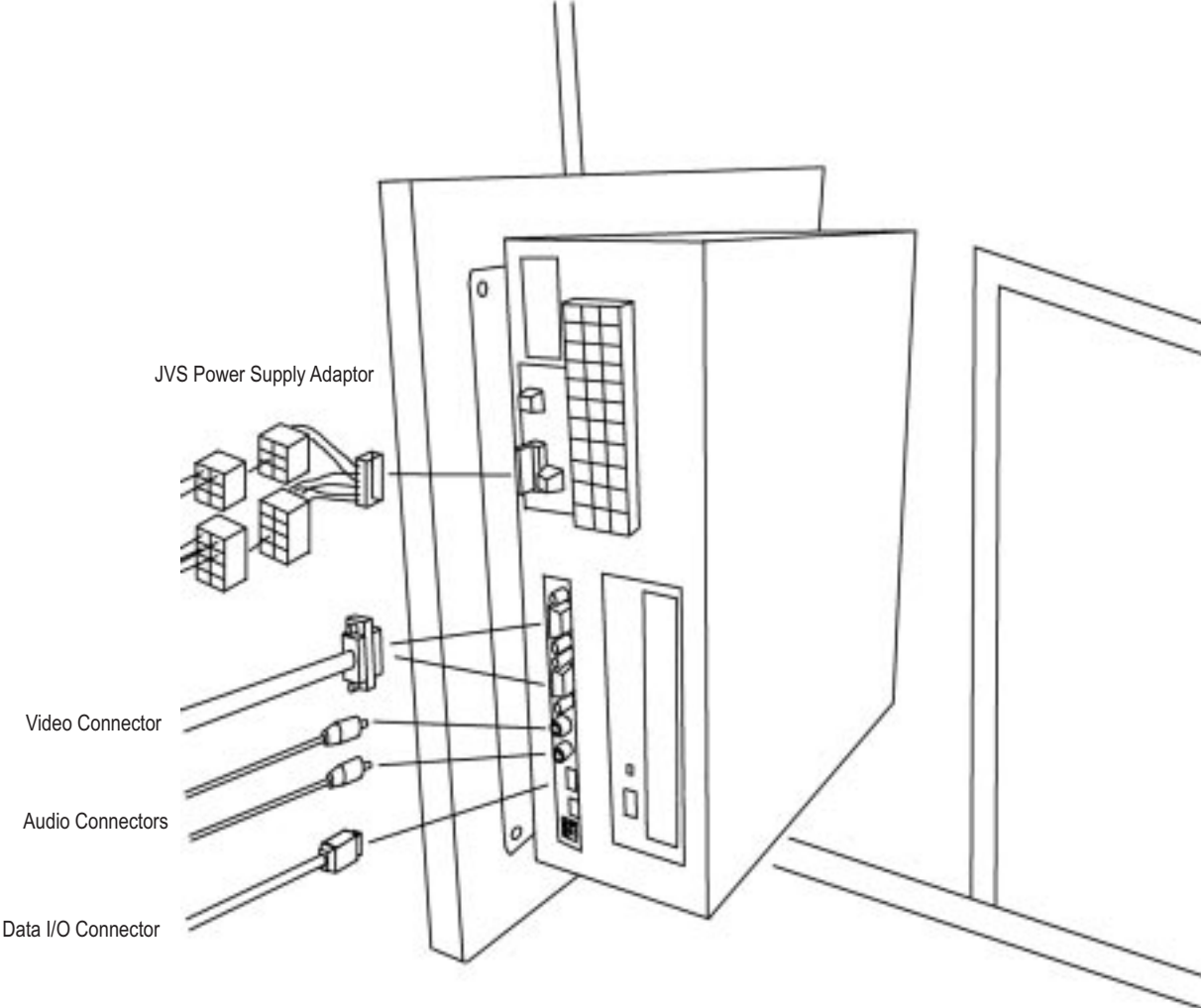

## 4. FITTING THE DONGLE

**The dongle included in this kit is limited to this game only. DO NOT insert this Dongle in other games. Inserting the Dongle in other games may cause damage.**

Ensure that the power is switched OFF before inserting the Dongle.

1. Remove 1 off pozi head screw (M3x10) and remove the Dongle Cover.

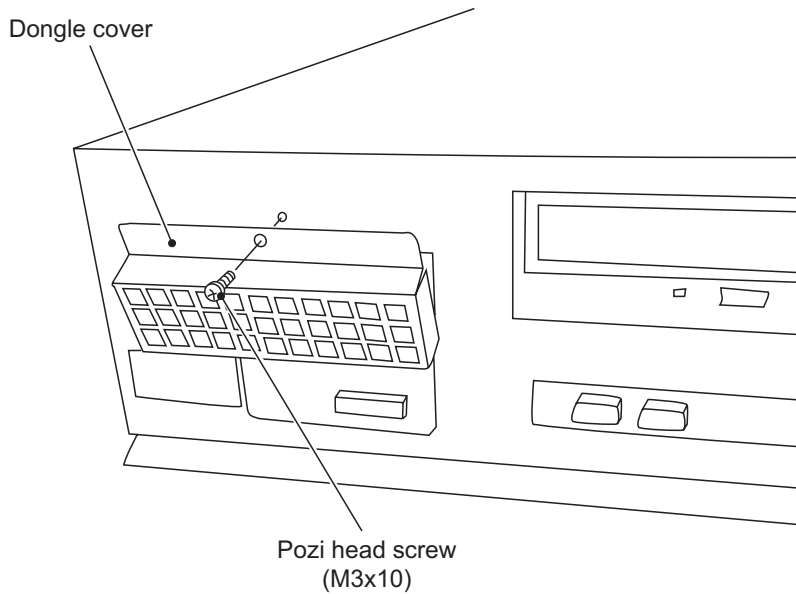

2. Fit the Dongle to the left hand connector.

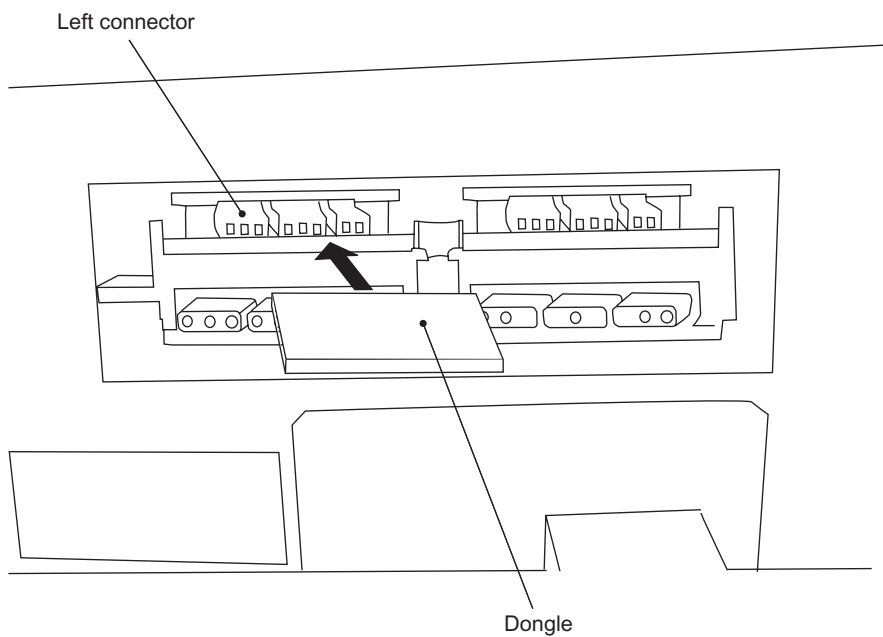

3. Refit the Dongle cover and pozi head screw (M3x10)

## 5. FITTING THE CD-ROM DISC

- The CD-ROM Disc must be inserted with the power switched on. To prevent an electric shock, accident or injury, do not touch any parts other than those specified below.
- The supplied CD-ROM Disc is designed exclusively for this product. Never use the CD-ROM Disc in any other product. Do not insert other CD-ROM Discs in the CD-ROM drive of this game.
- The CD-ROM tray retracts automatically after 10 seconds.

1. Press the eject button of the CD-ROM drive to open the tray.

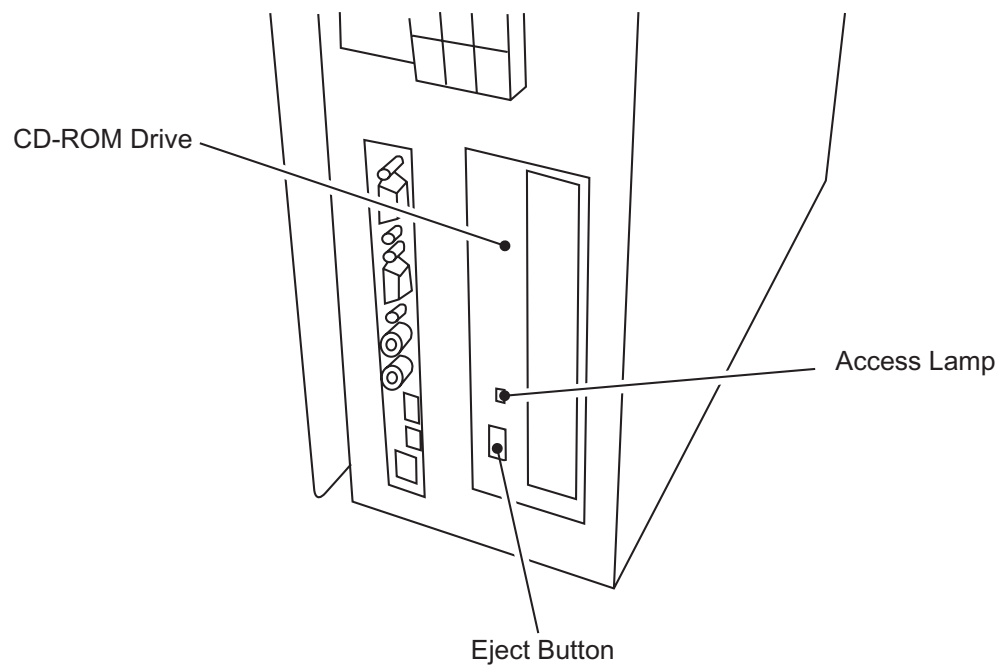

2. Place the CD-ROM Disc on to the tray, ensuring that the label side (printed surface) is facing away from the Tray.

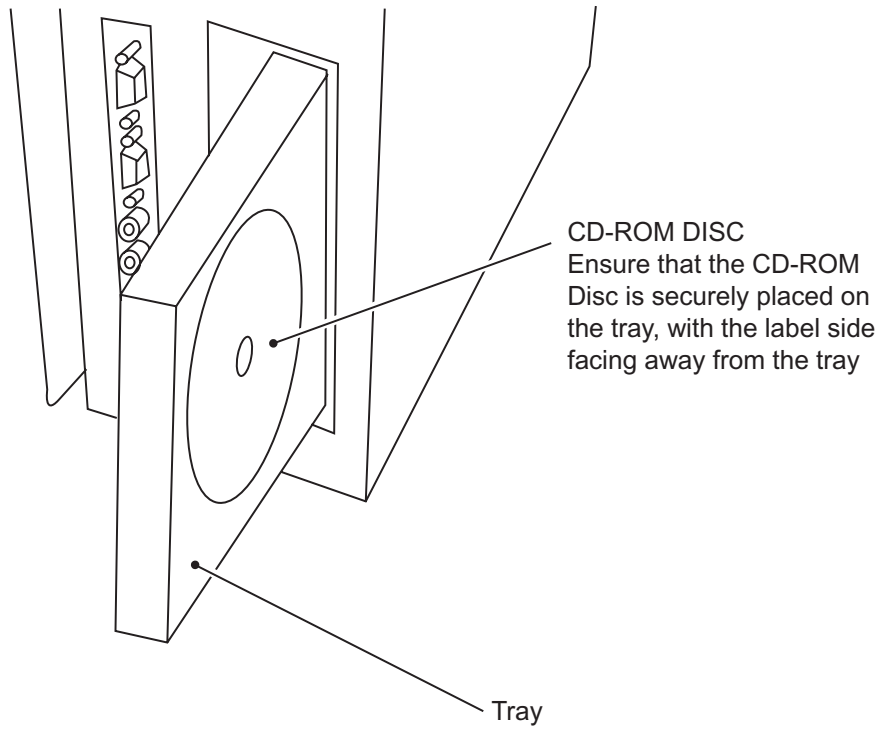

3. Press the Eject button to retract the Tray in to the unit.
4. Switch the power OFF, wait approx 10 seconds then switch the game back ON.

## 6. ADJUSTMENTS AND SETTINGS

The Game PC Board Assy is fitted with 4 Option Switches.

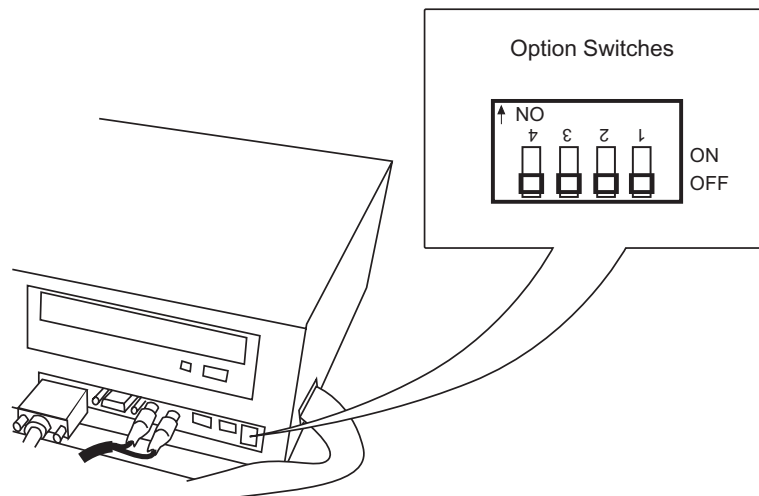

The JAMMA (B) PCB has the Volume Control fitted.

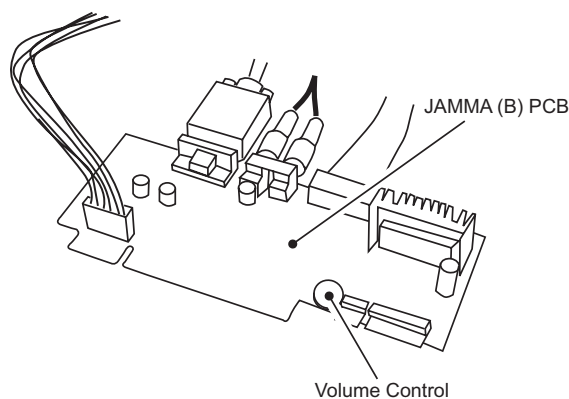

### 6-1 Option Switches

Switch 1 is used to change between Test Mode and Game Mode.

ON: Test Mode                      OFF: Game Mode

Switch 2 is used to set the output level of the video signal.

31kHz	ON: 0.7V p-p	OFF: 0.7V p-p
15kHz	ON: 3.0V p-p	OFF: 0.7v P-P

Switch 3 is used to change the monitor Sync Frequency

ON: 31kHz                              OFF: 15kHz

*Note: When using a 31kHz monitor, set the RGB input of the monitor to 0.7v. If the monitor does not have a setting adjustment, refer to page 17 section 6-2-1 "Display Test", and change the Contrast and RGB Brightness levels to adjust the brightness.*

Switch 4 is used to set the Video Sync Signal

ON: Composite Sync              OFF: Seperate Sync

## 6-2 Test Mode

To enter Test Mode set the Test switch in the cabinet (if fitted) to ON, or if no Test switch is fitted to the cabinet, set Option switch 1 ON

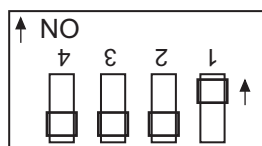

*Note: The test mode is activated only when the cabinet Test switch or Option switch 1 is moved from OFF to ON. If the game is switched on with either switch in the ON position the Test Mode will not be activated. The switch must be switched OFF and then ON to enter the test mode.*

When the Test Mode is entered, the following screen is displayed.

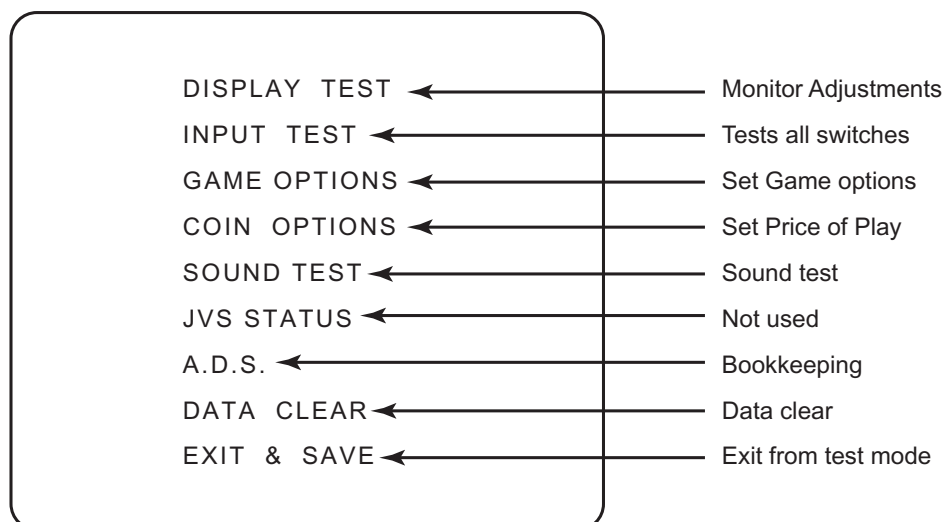

Use the Joystick Up or Down to step through the tests. (The selected test will be displayed in red)

Press the 1 Player Button 1 to enter the selected test.

After making adjustments select EXIT and press the 1 Player Button 1 to return to the above screen. Select another test or select 'EXIT & SAVE' and press the 1 Player Button 1 to save the changes and return to the Game Mode.

*Note: If 'EXIT &SAVE' is not selected and activated, any changes made may not be stored properly. Switching the cabinet Test switch or Option 1 switch OFF does not exit the Test Mode.*

Switch the cabinet Test switch or Option 1 switch OFF.



## 6-2-1 Display Test

This test allows the following checks and adjustments to be made.

- **Colour Edit**  
Adjust contrast and brightness of each colour to match video output from the PCB to the Monitor.  
*Note: This adjustment should only be made if the correct picture quality cannot be achieved by using the normal monitor adjustments.*
- **Convergence**  
Check and adjust the size, position and distortion of the screen image.
- **Interlace Check**  
Switches between interlaced and non-interlaced display. (Only with 15kHz video signal).

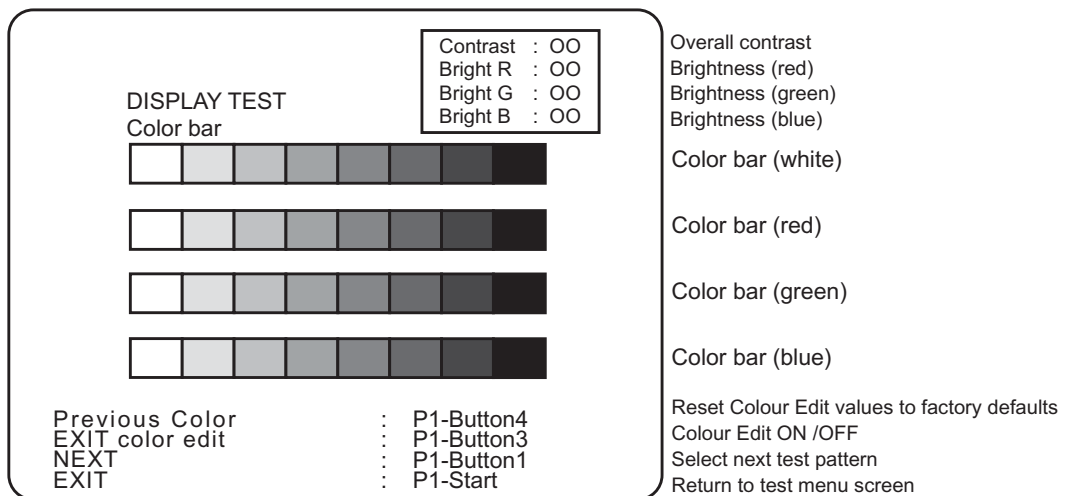

1. Select display Test from the Test Menu Screen, the following screen is displayed.

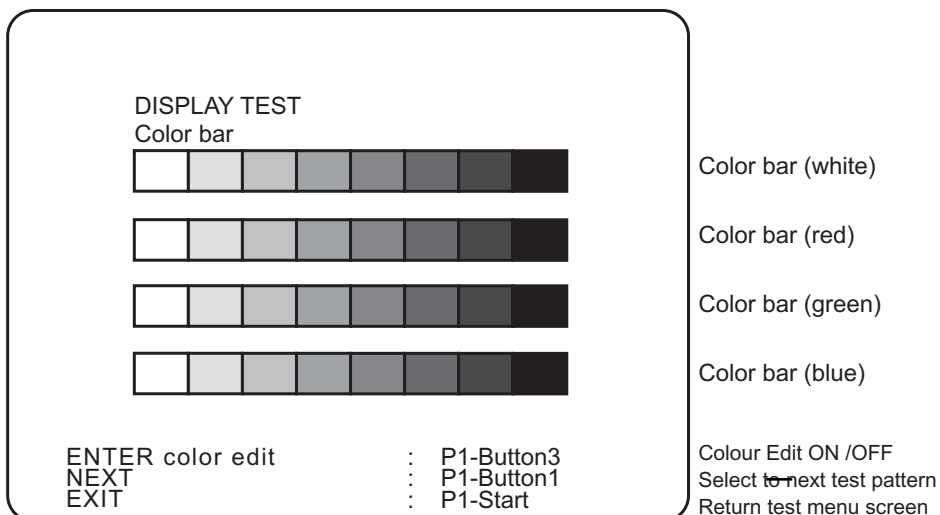

2. Each time the 1P Button 3 is pressed the Colour Edit adjustment box is turned ON or OFF.
3. Press the 1P Button 1 to step to the next test function  
COLOUR BAR → CONVERGENCE → INTERLACE



### 6-2-2 Colour Edit

1. Ensure that the Colour Edit Adjustment Box is showing. (Press P1 Button 3 if the Adjustment box is not displayed).
2. Use the Joystick UP/DOWN to step to the required adjustment. (Contrast, Brightness (red), Brightness (green), Brightness (blue)).
3. Use the Joystick LEFT/RIGHT to adjust the value.
3. When all adjustments have been made, press P1 Button 1 to step to the Convergence Test or P1 Start Button to return to the Main Test Menu screen

### 6-2-3 Convergence

Use this screen to adjust the geometry (height, width , etc.) of the Monitor.

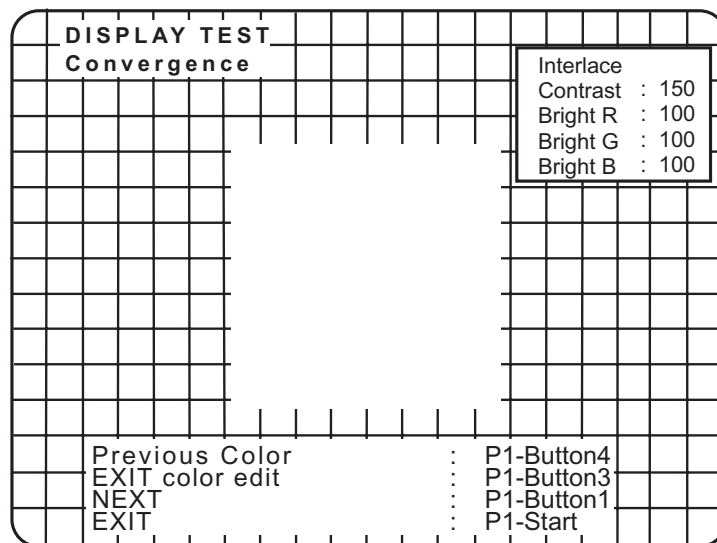

When all adjustments have been made, press P1 Button 1 to step to the Interlace Test or P1 Start Button to return to the Main Test Menu screen.

## 6-2-4 Interlace

**Interlace Mode:** This mode provides a more detailed and smoother graphics than the non-interlaced mode. This is achieved by shifting the picture display a half line in the vertical direction every other frame scan, so doubling the vertical resolution without changing the horizontal/vertical frequency.

**Non-Interlaced Mode:** Use this display if the interlace mode results in flicker over the entire screen display. In the non-interlaced mode, there is no shift of the display position, and the display remains constant every time.

1. Ensure that the Colour Edit Adjustment Box is showing. (Press P1 Button 3 if the Adjustment box is not displayed.)
2. Use the Joystick LEFT/RIGHT to change Interlace/Non Interlace.

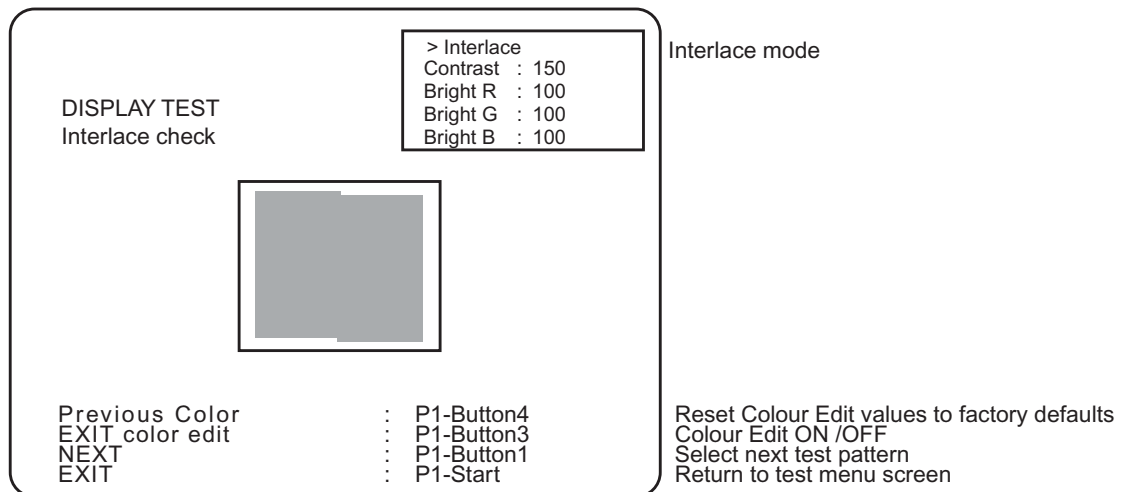

3. When the adjustment has been made, press P1 Button 1 to step back to the Colour Edit Test or P1 Start Button to return to the Main Test Menu screen.

## 6-2-5 Input Test

Select Input Test from the Main Test Menu. The following screen is displayed.

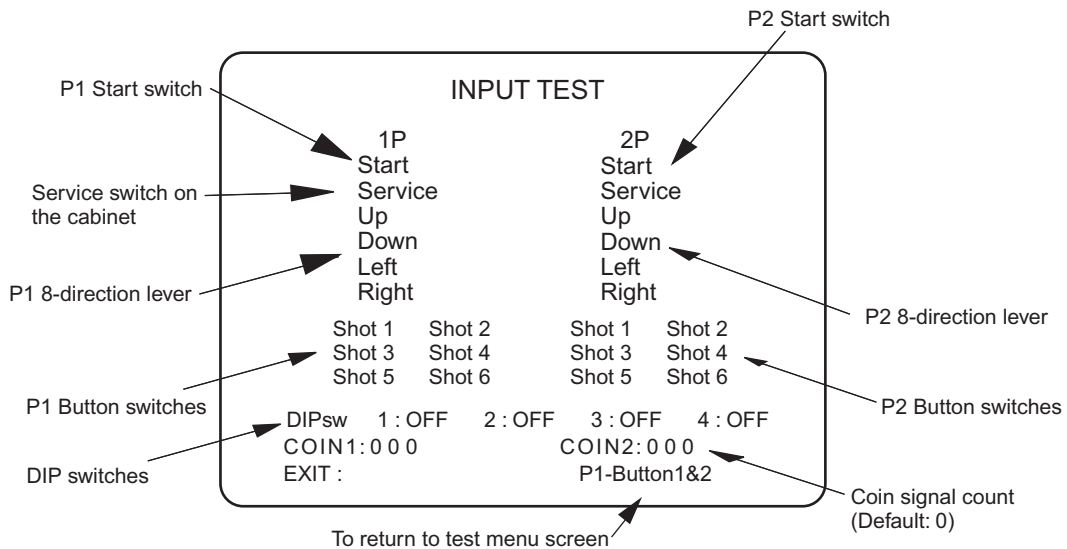

Each time a switch is operated, the corresponding item on the display will change colour to red.

*Note: When player button 1 is pressed Shot 1 is indicated.  
When player button 2 is pressed Shot 2 is indicated  
When player button 3 is pressed Shot 4 is indicated  
When player button 4 is pressed Shot 5 is indicated*

When testing is completed, press P1 Buttons 1 and 2 together to return to the Main Test Menu screen.

## 6-2-6 Game Options

1. Select Game Options from the Main Test Menu. The following screen is displayed.

GAME OPTIONS	
< Defaults in Green >	
(a)	Subtitles language: ENGLISH
(b)	Difficulty level: MEDIUM
(c)	Fight count <1P game> : 2
(d)	Fight count <VS game> : 2
(e)	Life bar <1P game> : +1
(f)	Life bar <VS game> : +1
(g)	Guard damage: OFF
(h)	Neutral guard: ON
(i)	Round time: 60
(j)	Character change at continue: YES
(k)	Character change at VS game: YES
(l)	Sound in attract mode: YES
(m)	Event mode: OFF
(n)	Hit color: GREEN
Modify :	P1-Left/Right
EXIT :	P1-Start

2. Use the Joystick UP/DOWN to step to the required adjustment.
3. Use the Joystick LEFT/RIGHT to adjust the value.
4. When all adjustments have been made, press P1 Start Button to return to the Main Test Menu screen

(a) Subtitles Language

ENGLISH	FRENCH	SPANISH	GERMAN	ITALIAN
---------	--------	---------	--------	---------

(b) Difficulty level (degree of game difficulty)

EASY	MEDIUM	HARD	VERY HARD	ULTRA HARD	ULTRA HARD 1	ULTRA HARD 2	SUPER HARD	EXTRA SUPER HARD
------	--------	------	-----------	------------	--------------	--------------	------------	------------------

(c) Fight Count <1P game > (number of rounds required to win the game in 1 player mode)

1	2	3	4	5
---	---	---	---	---

(d) Fight Count <VS game > (number of rounds required to win the game in 2 player mode)

1	2	3	4	5
---	---	---	---	---

(e) Life bar <1P game > (energy guage in 1 player mode)

-2	-1	NORMAL	+1	+2
----	----	--------	----	----

(f) Life bar <VZ game > (energy guage in 2 player mode)

-2	-1	NORMAL	+1	+2
----	----	--------	----	----

(g) Guard damage (damage received on guard)

ON (slight damage)	OFF (no damage)
--------------------	-----------------

(h) Neutral guard ( guard activated with lever in neutral)

ON	OFF
----	-----

(i) Round time (time [seconds] per round)

30	40	60	80	99
----	----	----	----	----

(j) Character change at continue (change of character for continued game)

YES (possible)	NO (not possible)
----------------	-------------------

(k) Character change at VS game (change of character)

YES (possible)	NO (not possible)
----------------	-------------------

(l) Sound in attract mode

YES (with sound)	NO (without sound)
------------------	--------------------

(m) Event mode (action after 2 player game has finished)

ON (game over for both players)	OFF (1P game play continues for winner)
---------------------------------	---

(n) Hit colour (colour of graphic effects when attacks are successful)

RED	GREEN
-----	-------

## 6-2-7 Coin Options

1. Select Coin Options from the Main Test Menu. The following screen is displayed.

COIN OPTIONS	
Defaults in Green	
(a)	> Start Cost 1Credit to START
(b)	Continue Cost 1Credit to CONTINUE
(c)	Coin chute 1 mechanical value 1Coin count as 1coin
(d)	Coin chute 2 mechanical value 1Coin count as 1coin
(e)	Credit mode COMMON
(f)	Coin counter 1counter
(g)	Free play no
Modify : <span style="float: right;">P1-Left/Right</span> EXIT : <span style="float: right;">P1-Start</span>	

2. Use the Joystick UP/DOWN to step to the required adjustment.
3. Use the Joystick LEFT/RIGHT to adjust the value.
4. When all adjustments have been made, press P1 Start Button to return to the Main Test Menu screen

*Note: When using a CashFlow acceptor ensure that Cost and Coin Chute values are set to 1*

(a) Start cost (number of credits to start a game)

1	2	3	4	5	6	7	8	9
---	---	---	---	---	---	---	---	---

(b) Continue cost (number of credits to continue a game - must be equal to or smaller than start cost)

1	2	3	4	5	6	7	8	9
---	---	---	---	---	---	---	---	---

(c) Coin chute 1 mechanical value (number of credits for each coin)

1	2	3	4	5	6	7	8	9
---	---	---	---	---	---	---	---	---

(d) Coin chute 2 mechanical value (number of credits for each coin)

1	2	3	4	5	6	7	8	9
---	---	---	---	---	---	---	---	---

(e) Credit Mode (credit storage and use)

<p style="text-align: center;"><b>COMMON</b></p> <p>Credits are stored as a single account regardless of which coin switch or start switch is operated.</p>	<p style="text-align: center;"><b>EACH ONE</b></p> <p>Different credit accounts are established. Credits from coin 1 are used by player 1 and credits from coin 2 are used by player 2</p>
---	--

(f) Coin counter (assignment of coin meters)

<p style="text-align: center;"><b>1 COUNTER</b></p> <p>Both coin switches share one coin counter</p>	<p style="text-align: center;"><b>2 COUNTERS</b></p> <p>Each coin switch has its own coin counter</p>
--	---

(g) Free play

YES (no coins required)	NO (coins required)
-------------------------	---------------------

### 6-2-8 Sound Test

1. Select Sound Test from the Main Test Menu. The following screen is displayed.

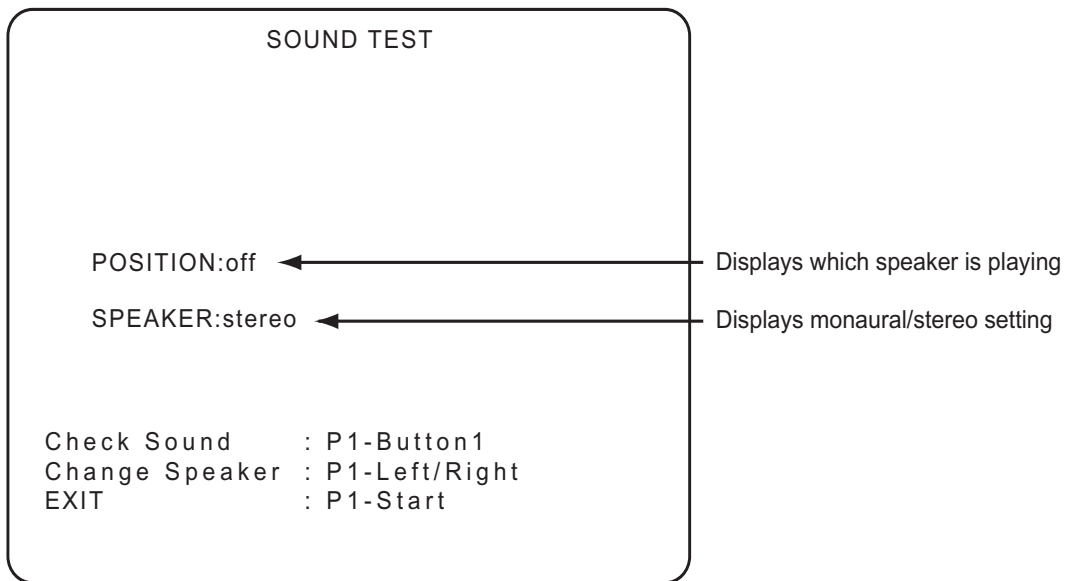

2. Press 1P Button 1 to conduct a stereo check. Sound will be produced from the left speaker only, then the right speaker only, then both speakers together. The display will show which speaker is active.
3. Use the Joystick LEFT/RIGHT to change between STEREO/MONO sound.
4. When testing has been completed, press P1 Start Button to return to the Main Test Menu screen

### 6-2-9 JVS Status

This test is inactive and not used on JAMMA system cabinets, it is only operational on JVS system cabinets.

**6-2-10 A. D. S - (Book Keeping)**

1. Select ADS from the Main Test Menu. The following screen is displayed.

	ADS		ON TIME	x:xx:xx	(e)
(a)	Coin 1 Total	xx	Play Ratio	100%	(f)
(b)	Coin 2 Total	xx	1P Play Ratio	xx.x%	(g)
(c)	Service Total	xx	VS Play Ratio	xx.x%	(h)
(d)	Freeplay Total	xx			
		Total Time	Count	Average	
(i)	1P Play	x:xx:xx	xxx	x:xx:xx	
(j)	1P Cont.	x:xx:xx	xxx	x:xx:xx	
(k)	VS Play	x:xx:xx	xxx	x:xx:xx	
(l)	All Play	x:xx:xx	xxx	x:xx:xx	
	EXIT :		P1-Start		

- (a) Total games on 1 player side.
- (b) Total games on 2 player side.
- (c) Total number of games using the Service switch.
- (d) Total number of games during Free Play.
- (e) Total time game has been switched on.
- (f) Total time the game has been played as a 1P game, Total number of 1P games played and the Average time of a 1P game.
- (g) Total time the game has been played as a 1P Continue game, Total number of 1P Continue games played and the Average time of a 1P Continue game.
- (h) Total time the game has been played as a 2P game, Total number of 2P games played and the Average time of a 2P game
- (g) Total time the game has been played, Total number of games played and the Average time of all games.



## 6-2-11 Data Clear

1. Select Data Clear from the Main Test Menu. The following screen is displayed.

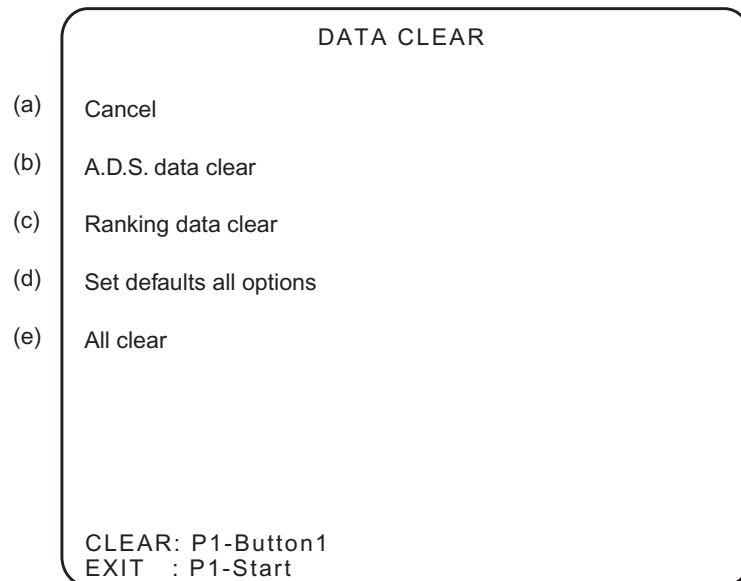

2. Use the Joystick UP/DOWN to step to the required adjustment.
3. When all adjustments have been made, press P1 Start Button to return to the Main Test Menu screen
  - (a) Returns to the Main Test Menu.
  - (b) Resets all Book Keeping data to zero
  - (c) Resets all ranking data such as record of consecutive wins to factory default
  - (d) Resets all Game and Coin Options to factory default.
  - (e) Executes (a), (b) and (c) all at once.





Copies of Namco Game Manuals can be downloaded from our **website:**

**[www.namco.co.uk](http://www.namco.co.uk)**

They are located under Components Distribution

For all Parts or Technical Support contact:

Brent Electronic,  
Namco House,  
Units 5-8, Acton Park Estate,  
The Vale,  
London. W3 7QE

[www.namco.co.uk](http://www.namco.co.uk)

For Technical Support, Warranty and

Advance Replacement Parts:-  +44 (0) 20 8324 6120

For Consumable Parts:-  +44 (0) 20 8324 6102

Fax for both:-  +44 (0) 20 8324 6126