

OWNER'S MANUAL

PRIMEVAL HUNT™**IMPORTANT**

- Before using this product, read this manual carefully to understand the contents herein stated.
- After reading this manual, be sure to keep it near the product or in a convenient place for easy reference when necessary.

WARRANTIES

GAME WARRANTY POLICY

Your new SEGA PRODUCT is covered for a period of ninety (90) days from the date of the shipment. This certifies that all Printed Circuit boards, power supplies and monitors are to be free of defects in workmanship or materials under normal operating conditions.

This also certifies that all Interactive Control Assemblies are to be free from defects in workmanship and materials under normal operating conditions. No other product in this machine is hereby covered. Sellers sole liability in the event a warranted part described above fails shall be, at its option, to replace or repair the defective part during the warranty period. For warranty claims, contact your SEGA Distributor. Should the seller determine, by inspection that the problem was caused by accident, misuse, neglect, alteration, improper repair, installation or testing, the warranty offered will be null and void.

Under no circumstances is the seller responsible for any loss of profits, loss of use, or other damages. This shall be the exclusive written Warranty of the original purchaser expressed in lieu of all other warranties expressed or implied. Under no circumstances shall it extend beyond the period of time listed above.

PARTS WARRANTY POLICY

Sega Amusements USA, Inc. warrants all parts to be free from defective materials and workmanship for a period of thirty (30) days from Sega Amusements USA, Inc. invoice date unless otherwise specified in writing by Sega Amusements USA, Inc.

This limited warranty is invalid for any part that upon examination, is deemed to have been subject to misuse, improper repair or installation, neglect or violation of specification or other instructions published by Sega Amusements USA, Inc. There are no additional warranties described above.

The limited warranties described above shall be in lieu of any other warranty, express or implied, including but not limited to any implied warranty of merchantability or fitness for a particular purpose.

BEFORE USING THE PRODUCT, BE SURE TO READ THE FOLLOWING:

To maintain safety:

To ensure the safe operation of this product, be sure to read the following before usage. The following instructions are intended for the users, operators and the personnel in charge of the operation of the product. After carefully reading and sufficiently understanding the warning displays and cautions, handle the product appropriately. Be sure to keep this manual close to the product or in a convenient place for future reference.

Herein, explanations which require special attention are enclosed with dual lines. Depending on the potentially hazardous degrees, the terms of DANGER, WARNING, CAUTION, etc. are used. Be sure to understand the contents of the displays before reading the text.



Indicates that mishandling the product by disregarding this pictograph will cause severe injury or death.



Indicates that mishandling the product by disregarding this caution will cause a slight hazardous situation which can result in personal injury and/or material damage.



Indicates that mishandling the product by disregarding this warning will cause a potentially hazardous situation which can result in death or serious injury.

For the safe usage of the product, the following pictographs are used:



Indicates "HANDLE WITH CARE." In order to protect the human body and equipment, this display is attached to places where the Owner's Manual, Serviceman Manual and/or Service Manual should be referred to.



Indicates a "Protective Earth Terminal." Before operating the equipment, be sure to connect it to the Ground.
(The step may be omitted for products in which a power cord with earth is used.)

- **Perform work in accordance with the instructions herein stated.**
Instructions for work are explained by paying attention to the aspect of accident prevention. Failing to perform work as per the instructions can cause accidents. In the case where only those who have technical expertise should perform the work to avoid hazardous situation, the instructions herein state that the site maintenance personnel should perform such work.
- **Be sure to turn off the power before working on the machine.**
To prevent an electric shock, be sure to turn off the power before carrying out any work that requires direct contact with the interior of the product. If the work is to be performed in the power-on status, the Instruction Manual herein always states to that effect.
- **Be sure to ground the Earth Terminal.**
(This is not required in the case where a power cord with earth is used.)
This product is equipped with the Earth Terminal. When installing the product, connect the Earth Terminal to the "accurately grounded indoor earth terminal" by using an earth wire. Unless the product is grounded appropriately, the user can be subject to an electric shock. After performing repair, etc. for the control equipment, ensure that the Earth Wire is firmly connected to the control equipment.
- **Ensure that the Power Supply used is equipped with an Earth Leakage Breaker.**
This product does not incorporate the Earth Leakage Breaker. Using a power supply which is not equipped with the Earth Leakage Breaker can cause a fire when earth leakage occurs.
- **Be sure to use fuses which meet the specified rating.**
(Only for the machines which use fuses.)
Using fuses exceeding the specified rating can cause a fire and an electric shock.

- **Specification changes (removal of equipment, conversion and addition) not designated by SEGA are not allowed.**

The parts of the product include warning labels for safety, covers for personal protection, etc. It is very hazardous to operate the product by removing parts and/or modifying the circuits. Should doors, lids and protective parts be damaged or lost, refrain from operating the product, and contact where the product was purchased from or the office herein stated.

SEGA shall not be held responsible for any accidents, compensation for damage to a third party, resulting from the specifications not designated by SEGA.

- **Ensure that the product meets the requirements of appropriate Electrical Specifications.**

Before installing the product, check for Electrical Specifications. SEGA products have a nameplate on which Electrical Specifications are described. Ensure that the product is compatible with the power supply voltage and frequency requirements of the location. Using any Electrical Specifications different from the designated Specifications can cause a fire and an electric shock.

- **Install and operate the product in places where appropriate lighting is available, allowing warning labels to be clearly read.**

To ensure safety for the customers, labels and printed instructions describing potentially hazardous situations are applied to places where accidents can be caused. Ensure that where the product is operated has sufficient lighting allowing the warnings to be read. If any label is peeled off, apply it again immediately. Please place an order with where the product was purchased from or the office herein stated.

- **When handling the monitor, be very careful. (Applies only to the product with a monitor.)**

Some of the monitor (TV) parts are subject to high tension voltage. Even after turning off the power, some portions are still subject to high tension voltage sometimes. Monitor repair and replacement should be performed only by those technical personnel who have knowledge of electricity and technical expertise.

- **Be sure to adjust the monitor/projector properly. (Applies only to the product with a monitor/projector.)**

Do not operate the product leaving on-screen flickering or blurring as it is. Using the product with the monitor/projector not properly adjusted may cause dizziness or a headache to an operator, a player, or the customers.

- **When transporting or reselling this product, be sure to attach this manual to the product.**

In the case where commercially available monitors and printers are used in this product, only the contents relating to this product are explained herein. Some commercially available equipment has functions and reactions not stated in this manual. Read this manual together with the specific Instruction Manual of such equipment.

**Descriptions herein contained may be subject to improvement changes without notice.*

**The contents described herein are fully prepared with due care. However, should any question arise or errors be found, please contact SEGA.*

INSPECTIONS IMMEDIATELY AFTER TRANSPORTING THE PRODUCT TO THE LOCATION

Normally, at the time of shipment, SEGA products are in a status allowing for usage immediately after transporting to the location. Nevertheless, an irregular situation may occur during transportation. Before turning on the power, check the following points to ensure that the product has been transported in a satisfactory status.

- Are there any dented portions or defects (cuts, etc.) on the external surfaces of the cabinet?
- Are Casters and Adjusters damaged?
- Do the power supply voltage and frequency requirements meet with those of the location?
- Are all wiring connectors correctly and securely connected? Unless connected in the correct way, connector connections can not be made accurately. Do not insert connectors forcibly.
- Do power cords have cuts and dents?
- Do the fuses used meet specified ratings? Is the Circuit Protector in an energized status?
- Are all accessories available?
- Can all Doors and Lids be opened with the Accessory Keys? Can Doors and Lids be firmly closed?

TABLE OF CONTENTS

BEFORE USING THE PRODUCT, BE SURE TO READ THE FOLLOWING:

TABLE OF CONTENTS	i
INTRODUCTION	iv
1 HANDLING PRECAUTIONS	1
2 PRECAUTIONS REGARDING INSTALLATION LOCATION	4
2-1 LIMITATIONS OF USAGE	4
2-2 OPERATION AREA	5
3 PRECAUTIONS REGARDING PRODUCT OPERATION	6
4 PART DESCRIPTIONS	8
5 ACCESSORIES	9
6 ASSEMBLY AND INSTALLATION	10
6-1 FIXATION TO INSTALLATION SITE	12
6-2 TURNING ON THE POWER (SOFTWARE INSTALLATION)	15
6-3 CHECKING ASSEMBLY (SETUP)	20
7 PRECAUTIONS WHEN MOVING THE MACHINE	24
8 GAME DESCRIPTION	25
8-1 GAME OUTLINE	26
8-2 TOUCH PANEL CONTROL IN GAME PLAY	28
8-3 RULE OF BONUS PLAY	30
8-4 ITEM RULE	32
8-5 GAME FLOW	33

9 TEST MODE 34

 9-1 SWITCH UNIT AND COIN METER35

 9-2 SYSTEM TEST MODE37

 9-3 GAME TEST MODE38

 9-3-1 GAME TEST MODE Menu.....38

 9-3-2 INPUT TEST39

 9-3-3 OUTPUT TEST40

 9-3-4 GAME ASSIGNMENTS41

 9-3-5 GUN ADJUSTMENT.....42

 9-3-6 TOUCH PANEL ADJUSTMENT43

 9-3-7 BOOKKEEPING44

 9-3-8 BACKUP DATA CLEAR46

10 LICENSE MARK 47

11 FLUORESCENT LIGHT/OTHER LAMPS REPLACEMENT 48

12 PERIODIC INSPECTION 50

13 TROUBLESHOOTING 52

 13-1 TROUBLESHOOTING (WHEN NO ERROR MESSAGE IS SHOWN).....52

 13-2 ERROR MESSAGES.....55

14 GAME BOARD 58

 14-1 REMOVING THE LINDBERGH58

 14-2 COMPOSITION OF THE GAME BOARD.....60

15 DESIGN-RELATED PARTS..... 61

16 PARTS LIST..... 62

17 WIRE COLOR CODE TABLE 64

18 WIRING DIAGRAM 65

INTRODUCTION

This manual is intended to provide detailed descriptions together with all the necessary information covering the general operation of electronic assemblies, electro-mechanicals, servicing control, spare parts, etc. for the product, "PRIMEVAL HUNT DX."

This manual is intended for the owners, personnel and managers in charge of operation of the product. Operate the product after carefully reading and sufficiently understanding the instructions.

In the unlikely event that the product does not function correctly, DO NOT allow anyone other than a technician to touch the internal system. Turn off the power to the machine, making sure to unplug the electrical cord from the outlet, and contact the office listed below or the point of purchase for this product.

Use of this product is unlikely to cause physical injuries or damage to property. However, points that require special attention are indicated by bold text, the word "IMPORTANT" and the symbol below.



Indicates important information that, if ignored, may result in the mishandling of the product and cause faulty operation or damage to the product.

Sega Amusements U.S.A., Inc.
800 Arthur Avenue, Elk Grove Village, IL 60007-5215, U.S.A.

TEL: 1-847-364-9787
TOLL FREE: 1-888-877-2669
FAX: 1-847-427-1065

SPECIFICATIONS

Dimensions:	Unit : 55" [Width] x 70" [Depth] x 93" [Height]
Weight:	Unit : 553 lbs.
Power, maximum current:	540 W, 4.5 A (AC 120 V, 60 Hz)
Monitor:	56" DLP Monitor

NOTE: The contents herein described are subject to change without notice.

Definition of 'Site Maintenance Personnel or Other Qualified Individuals'**⚠WARNING**

Procedures not described in this manual or marked as 'to be carried out by site maintenance personnel or other qualified professionals' should not be carried out by personnel without the necessary skill or technology. Work carried out by unqualified persons may cause serious accidents, including electrocution.

Parts replacement, maintenance inspections and troubleshooting should be carried out by site maintenance personnel or other qualified professionals. This manual includes directions for potentially dangerous procedures which should only be carried out by professionals with the appropriate specialized knowledge.

The site maintenance personnel or other qualified professionals mentioned in this manual are defined as follows:

Site maintenance personnel:

Individuals with experience in maintaining amusement equipment, vending machines, etc., working under the supervision of the owner/operator of this product to maintain machines within amusement facilities or similar premises by carrying out everyday procedures such as assembly, maintenance inspections, and replacement of units/expendable parts.

Activities to be carried out by site maintenance personnel:

Amusement equipment/vending machine assembly, maintenance inspection and replacement of units/expendable parts.

Other qualified professionals:

Persons employed by amusement equipment manufacturers, or involved in design, production, testing or maintenance of amusement equipment. The individual should have either graduated from technical school or hold similar qualifications in electrical/electronics/mechanical engineering.

Activities to be carried out by other qualified professionals:

Amusement equipment/vending machine assembly, repair/adjustment of electrical/electronic/mechanical parts.

1 HANDLING PRECAUTIONS

When installing or inspecting the machine, be very careful of the following points and pay attention to ensure that the player can enjoy the game safely.

Non-compliance with the following points or inappropriate handling running counter to the cautionary matters herein stated can cause personal injury or damage to the machine.

WARNING

- Before performing work, be sure to turn the power off. Performing the work without turning the power off can cause an electric shock or short circuit. In the case work should be performed in the status of power on, this manual always states to that effect.
- To avoid an electric shock or short circuit, do not plug in or unplug quickly.
- To avoid an electric shock, do not plug in or unplug with a wet hand.
- Do not expose power cords or earth wires on the surface, (floor, passage, etc.). If exposed, the power cords and earth wires are susceptible to damage. Damaged cords and wires can cause an electric shock or short circuit.
- To avoid causing a fire or an electric shock, do not put things on or damage the power cords.
- When or after installing the product, do not unnecessarily pull the power cord. If damaged, the power cord can cause a fire or an electric shock.
- In case the power cord is damaged, ask for a replacement through where the product was purchased from or the office herein stated. Using the cord as is damaged can cause fire, an electric shock or leakage.
- Be sure to perform grounding appropriately. Inappropriate grounding can cause an electric shock.
- Be sure to use fuses meeting the specified rating. Using fuses other than the specified rating can cause a fire or an electric shock.
- Be sure that connections such as IC BD are made properly. Insufficient insertion can cause an electric shock.
- Specification changes, removal of equipment, conversion and/or addition, not designated by SEGA are not permitted.
 - Failure to observe this may cause a fire or an electric shock. Non-compliance with this instruction can have a bad influence upon physical conditions of the players or the onlookers, or result in injury during play.
 - SEGA shall not be held responsible for damage, compensation for damage to a third party, caused by specification changes not designated by SEGA.
- Do not perform any work or change parts not listed in this manual. Doing so may lead to an accident.

If you need to perform any work not listed in this manual, request work from the office indicated in this manual or the point of purchase, or inquires for details.
- Be sure to perform periodic maintenance inspections herein stated.

STOP IMPORTANT

1 HANDLING PRECAUTIONS

- For the IC board circuit inspections, only the logic tester is allowed. The use of a multiple-purpose tester is not permitted, so be careful in this regard.
- When cleaning the CRT surfaces, use a soft and dry cloth. Do not apply chemicals such as thinner, benzene, etc.
- Static electricity from your body may damage some electronics devices on the IC board. Before handling the IC board, touch a grounded metallic surface so that the static electricity can be discharged.
- Some parts are not designed and manufactured specifically for this game machine. The manufacturers may discontinue, or change the specifications of such general-purpose parts. If this is the case, SEGA cannot repair or replace a failed game machine whether or not a warranty period has expired.

CONCERNING THE STICKER DISPLAY

This SEGA product has stickers attached describing the product manufacture No. (Serial No.) and Electrical Specifications. It also has a Sticker describing where to contact for repair and for purchasing parts.

When inquiring about or asking for repairs, mention the Serial No. and Name of Machine indicated on the Sticker. The Serial Number indicates the product register. Identical machines could have different parts depending on the date of production. Also, improvements and modifications might have been made after the publication of this manual. In order to ensure you order the correct parts, mention the Serial No. when contacting the applicable places.

CONCERNING WARNING DISPLAYS

This SEGA product has warning displays on stickers, labels and/or printed instructions adhered/attached to or incorporated in the places where a potentially hazardous situation could arise. The warning displays are intended for accident prevention for customers and for avoiding hazardous situations relating to maintenance and servicing work. Some portions of the cabinet contain high voltage and may cause accidents if touched. When performing maintenance, be very careful of the warning displays. It is especially important that any complex repair and replacement work not mentioned herein should be performed by those technical personnel who have knowledge of electricity and technical expertise. In order to prevent accidents, caution any customer ignoring the warnings to cease and desist immediately.



2 PRECAUTIONS REGARDING INSTALLATION LOCATION

WARNING

This product is an indoor game machine. Do not install it outside. Even indoors, avoid installing in places mentioned below so as not to cause a fire, electric shock, injury and/or malfunction.

- Places subject to rain or water leakage, or places subject to high humidity in the proximity of an indoor swimming pool and/or shower, etc.
- Places subject to direct sunlight, or places subject to high temperatures in the proximity of heating units, etc.
- Places filled with inflammable gas or vicinity of highly inflammable/volatile chemicals or hazardous matter.
- Dusty places.
- Sloped surfaces.
- Places subject to any type of violent impact.
- Vicinity of anti-disaster facilities such as fire exits and fire extinguishers.
- Areas where the temperature exceeds the applicable temperature (ambient temperature) range of 5 to 30 degrees centigrade.

2-1 LIMITATIONS OF USAGE

WARNING

- Be sure to check the Electrical Specifications. Ensure that this product is compatible with the location's power supply, voltage, and frequency requirements. A plate describing Electrical Specifications is attached to the product. Non-compliance with the Electrical Specifications can cause a fire and electric shock.
- This product requires a breaker and earth mechanism as part of the location facilities. Using the product without these can cause a fire and electric shock.
- Ensure that the indoor wiring for the power supply is rated at 15 A or higher (AC single phase 100 V ~ 120 V area). Non-compliance with the Electrical Specifications can cause a fire and electric shock.
- Be sure to use an independent power supply equipped with an earth leakage breaker. Using a power supply without an earth leakage breaker can cause an outbreak of fire if a power surge occurs.
- Putting many loads on one electrical outlet can cause generation of heat and a fire resulting from overload.
- When using an extension cord, ensure that the cord is rated at 15 A or higher (AC 100 V ~ 120 V area). Using a cord rated lower than the specified rating can cause a fire and electric shock.

2-2 OPERATION AREA

WARNING

- For safe operation, use and operate this product in an area measuring at least 2.60 m (102.4 in) in width and 3.0 m (118.1 in) in depth. The area prescribed in this manual is absolutely necessary, for if one should fall over and hit their head against something, there could be a serious accident.
- Be sure to provide sufficient space specified in this manual. Do not allow objects to block the ventilation ports. It can cause generation of heat and a fire.
- SEGA shall not be held responsible for damage or compensation for damage to a third party, resulting from the failure to observe this instruction.
- If the machine does not fit through the entryway to the installation location, do not disassemble it without first consulting the instructions. The machine should only be disassembled in accordance with the instructions listed in this manual; do not attempt to disassemble it in any other way. This may cause electric shock or short circuits.

IMPORTANT

To install this product, the entrance must be at least 32" width and 80" in height.

3 PRECAUTIONS REGARDING PRODUCT OPERATION

To avoid injury and trouble, be sure to pay attention to the behavior of visitors and players.

BEFORE OPERATION

WARNING

In order to avoid accidents, check the following before starting the operation:

- To ensure maximum safety for the players and the customers, ensure that where the product is operated has sufficient lighting to allow any warnings to be read. Operation under insufficient lighting can cause bodily contact with each other, hitting accident, and/or trouble between customers.
- Be sure to perform appropriate adjustment of the monitor (projector). For operation of this machine, do not leave monitor's flickering or deviation as is. Failure to observe this can have a bad influence upon the players' or the customers' physical conditions.
- It is suggested to ensure a space allowing the players who feel sick while playing the game to take a rest.
- Check if all of the adjusters are in contact with the surface. If they are not, the Cabinet can move and cause an accident.

WARNING

- Do not put any heavy item on this product. Placing any heavy item on the product can cause a falling down accident or parts damage.
- Do not climb on the product. Climbing on the product can cause falling down accidents. To check the top portion of the product, use a step ladder.
- To avoid electric shock, check to see if door & cover parts are damaged or omitted.
- To avoid electric shock, short circuit and/or parts damage, do not put the following items on or in the periphery of the product. Flower vases, flowerpots, cups, water tanks, cosmetics, and receptacles/containers/vessels containing chemicals and water.

CAUTION

- During daily cleaning, be sure to check the surface of the steering wheel, gear shifter, and other parts that the player touches with his hands for damage, cracks, or loose screws. If a player uses the machine while it is damaged, cracked, or has a loose screw, the player may become injured.
- During daily cleaning, be sure to check the seat for any abnormality, wetness, etc. Failure to do this may result in deliberate tampering or negligence being left undetected.
- To avoid injury, be sure to provide sufficient space by considering the potentially crowded situation at the installation location. Insufficient installation space can cause making bodily contact with each other, hitting accidents, and/or trouble between customers.

DURING OPERATION (PAYING ATTENTION TO CUSTOMERS)

WARNING

- For safety reasons, do not allow any of the following people to play the game.
 - Those who need assistance such as the use of an apparatus when walking.
 - Those who have high blood pressure or a heart problem.
 - Those who have experienced muscle convulsion or loss of consciousness when playing video games, etc.
 - Those who have neck or spinal cord problems.
 - Those who are intoxicated or under the influence of drugs.
 - Pregnant women.
 - Persons susceptible to motion sickness.
 - Persons who disregard the product's warning displays.
- Even players who have never been adversely affected by light stimulus might experience dizziness or headache depending on their physical condition when playing the game. Small children are especially likely to experience these symptoms. Caution guardians of small children to keep watch on their children during play.
- Instruct those who feel sick during play to have a medical examination.
- To avoid injury from falls and electric shocks due to spilled drinks, instruct the player not to place heavy items or drinks on the product.
- To avoid electric shocks and short circuits, do not allow customers to put hands and fingers or extraneous matter in the openings of the product or small openings in or around the doors.
- To avoid falls and resulting injury, immediately stop the customer from leaning against or climbing on the product, etc.
- To avoid electric shock and short circuit, do not allow customers to unplug the power plug without a justifiable reason.

CAUTION

Immediately stop such violent acts as hitting and kicking the product. Such violent acts can cause parts damage or falling down, resulting in injury due to fragments and falling down.

4 PART DESCRIPTIONS

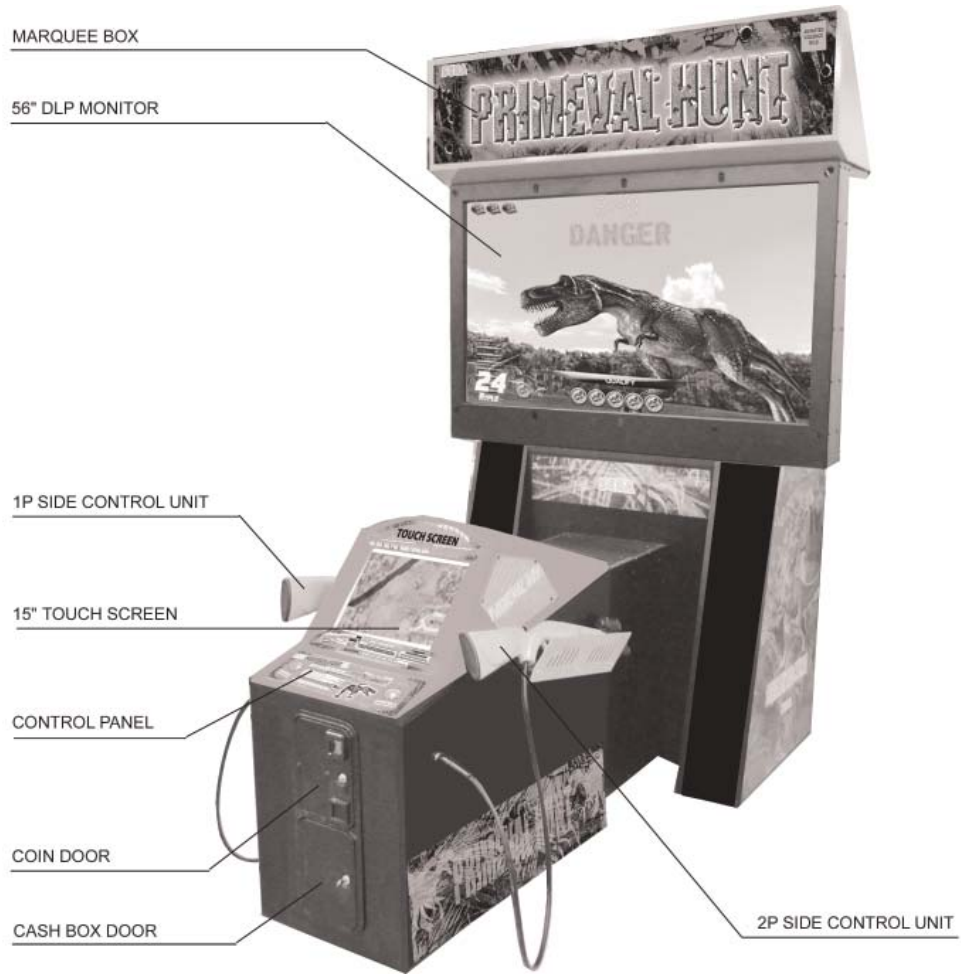

4 PARTS DESCRIPTIONS



5 ACCESSORIES

Confirm that the accessories listed in the table below are present when setting up the product. Accessories marked “Spare” in the note column are consumable items but included as spares.

5 TABLE 01

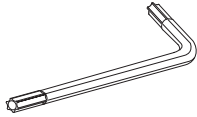
<p>OWNER'S MANUAL 543-30-300 (1) This manual</p>	<p>REMOTE FOR 56" DLP MONITOR</p> 	<p>HARNESS FOR DBA</p> 
<p>TAMPER PROOF SCREW WRENCH</p> 		

5 TABLE 02 DVD SOFT KIT PRIMEVAL HUNT (610-0727-0048)

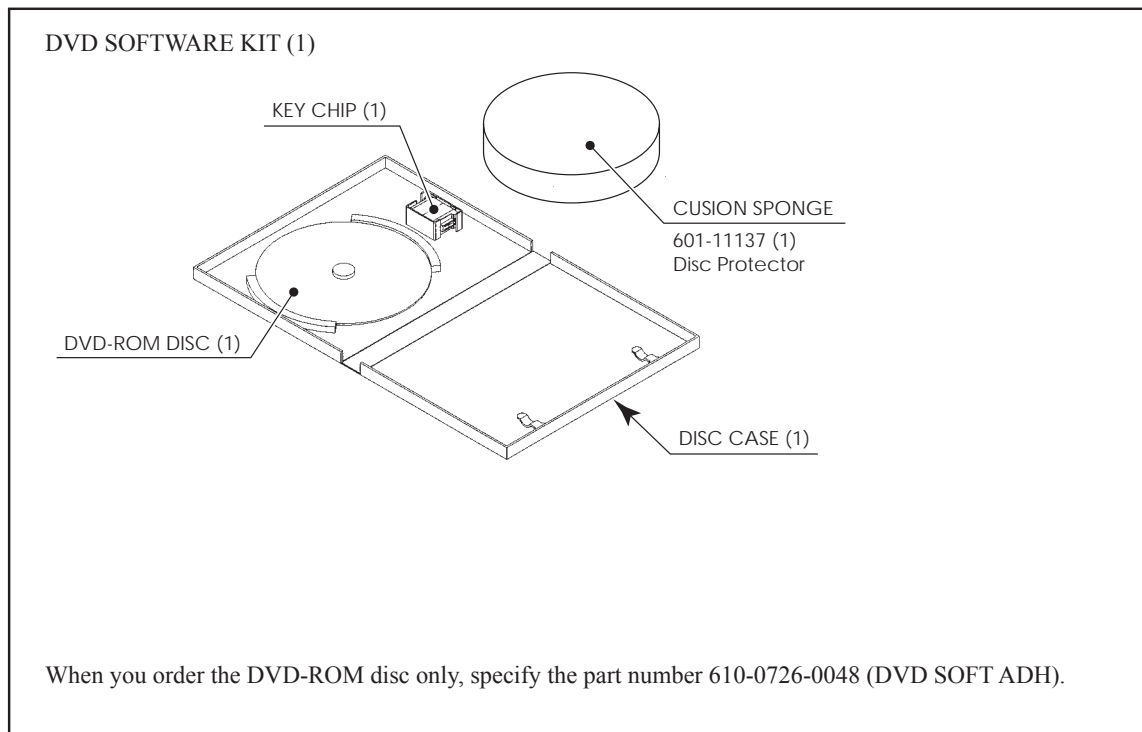

NOTE; The game software has been pre-installed in the main PCB and the key chip has been pre-set to the main PCB.
Please use the DVD software, only when necessary for some reason such as replacing the main PCB.
However to install the software, the DVD DRIVE and USB (mini type) cable need to be prepared separately.
Those are not included in the unit and available separately at SEGA.

6 ASSEMBLY AND INSTALLATION

WARNING

- Perform assembly work by following the procedure herein stated. Failure to comply with the instructions can cause electric shock.
- Perform assembling as per this manual. Since this is a complex machine, incorrect assembling can cause an electric shock, machine damage and/or improper functioning as per specified performance.
- When assembling, more than one person is required. Depending on the assembly work, there are some cases in which working by one person alone can cause personal injury or parts damage.
- Ensure that connectors are properly connected. Improper connections can cause electric shock.
- This work should be carried out by the site maintenance personnel or other qualified professionals. Work performed by non-technical personnel can cause a severe accident such as electric shock. Failing to comply with this instruction can cause a severe accident such as electric shock to the player during operation. If no one with proper technological expertise is available, request service from the office indicated in this document or the point of purchase so as to ensure safety.
- Provide sufficient space so that assembling can be performed. Performing work in places with narrow space or low ceiling may cause an accident and assembly work to be difficult.
- To perform work safely and avoid serious accident such as the cabinet falling down, do not perform work in places where step-like grade differences, a ditch, or slope exist.
- Be careful not to damage the wires. Damaged wires may cause electric shock or short circuit or present a risk of fire.
- Do not leave power cords, ground wires, or network cables exposed in areas of heavy foot traffic. Doing so may cause them to become damaged, possibly resulting in electric shock and/or short circuits. When laying wiring across the floor, always use safety covers to protect the wires.
- The power cord for this product has a ground terminal. Make sure to use this ground terminal when plugging it in to an indoor outlet. Failure to properly ground the product could lead to electrocution. It can also lead to malfunction.

CAUTION

- When opening/closing, attaching/removing doors or lids, be careful that your hand or finger does not get caught in anything.
- To perform the operation safely and accurately you must use a safe, steady footstool or stepladder. Working without this may lead to a fall and possible injury.
- Wear appropriate work clothing so that work can be performed safely. Use gloves and safety shoes to prevent accidents or injuries.
- When installing a wire protection cover over a floor, use a material shaped so that no one passing by will stumble over it. Using a material that could be stumbled over might lead to an accidental fall.
- Handle plastic parts with care. Excessive weight or pressure may cause them to break and the broken pieces may cause injury.

When carrying out the assembling and installation, follow the following 6-item sequence.

6-1 Installation

6-2 Turning on the power (Software Installation)

6-3 Checking assembly (Setup)

Tools necessary for work

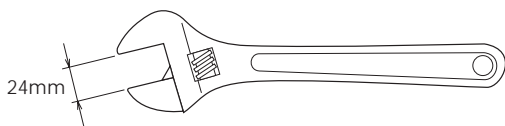

Spanner with measuring distance of 24 mm to opposite side

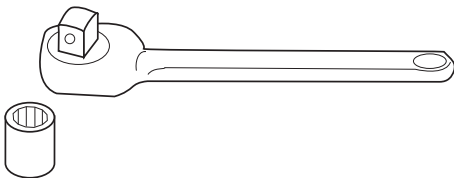

Hexagon socket wrench

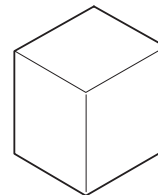

STEP

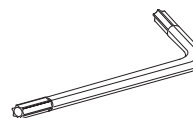

TAMPER PROOF SCREW WRENCH
(in accessory kit)

6-1 INSTALLATION

6-1-1 Assembling the Monitor cabinet, Extension (middle) cabinet, and Pedestal cabinet.

1. Screw side panels to the front of the monitor (2) places, using (8) silver screws and (8) silver lock washers.
2. Place bottom panel on inside rails of side panels. Do not screw in place.
3. Screw pedestal cabinet to side panels using (8) silver screws and (8) silver lock washers.
4. Now screw bottom panel to rails, on side panels, using (2) 1 1/4 long silver screws.
5. Route and connect cables from pedestal cabinet to monitor cabinet.
6. Screw top cover to side panels using (6) black black screws and (6) black washers.

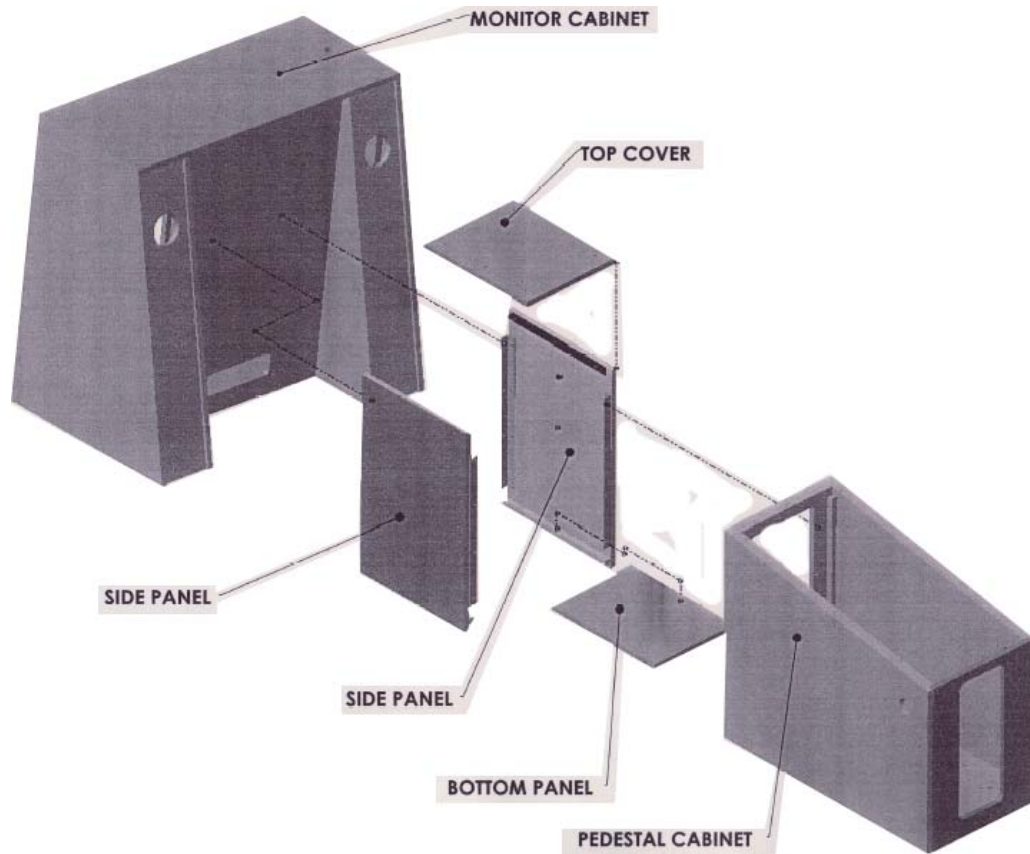

Cable connection

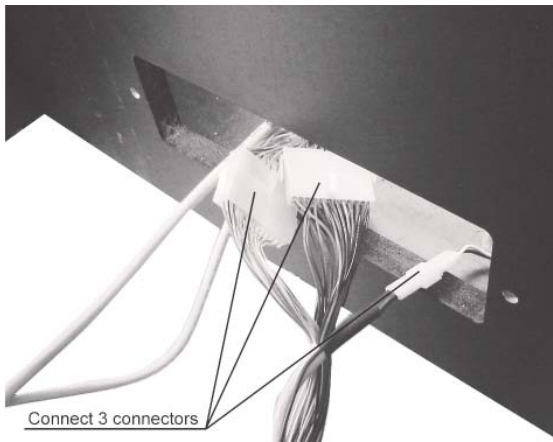

6-1-2 Installing the Marquee box unit

1. Lift the marquee box up with two people and place it atop of DLP monitor. Lift it up from the rear of the cabinet.
2. Place the marquee box so that the two marquee holding brackets match with the two holes on the bottom of the marquee box. Then slide the marquee box in the direction of the DLP screen. This will lock the bottom of the marquee box into the marquee holding brackets and fix the marquee box in place.
3. Fix the back of the marquee box with the two screws.



4. Remove the wire cover bracket on the back of monitor.

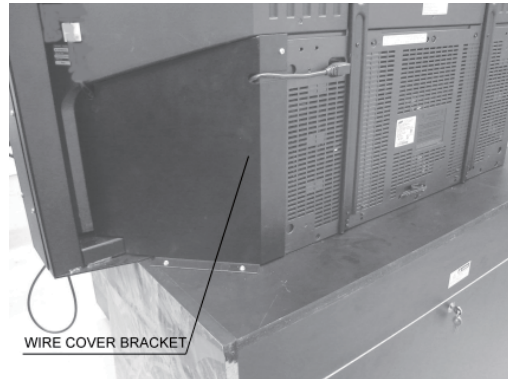

5. Route the cable down to inside monitor cabinet and connect it

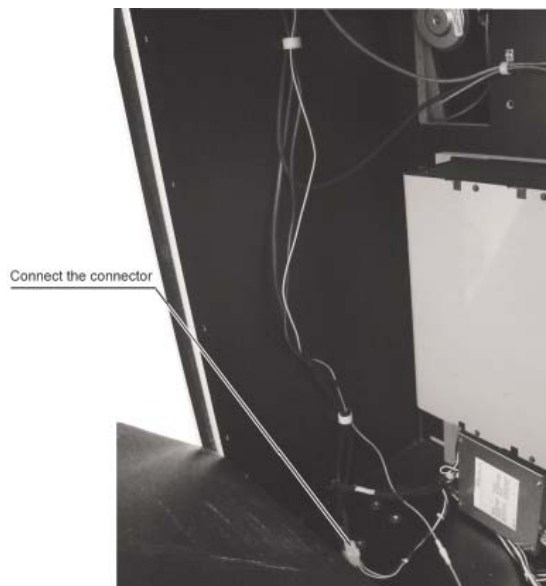

- Put the wire cover bracket back and tie down the cable with tie wraps on tie bases.

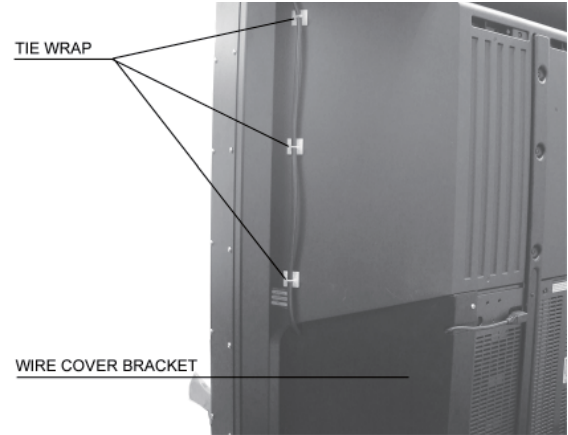

6-2 TURNING ON THE POWER (SOFTWARE INSTALLATION)

The software installation is not necessary for this game, as it is pre-installed into the main PCB. Please refer to the following section, only when necessary.

WARNING

- Be careful not to damage the DVD wire by getting it caught between objects, etc. Doing so may cause a short circuit or fire.
- The following explanation assumes that the product has been assembled properly as explained above. If there is an error or if the product operates in a manner other than as indicated below, cut off the power supply immediately. Failure to do so may result in a fire or electrical shock.
- If you look directly at the laser beam in the DVD DRIVE, you could suffer vision impairment. Do not look inside the DVD DRIVE.

IMPORTANT

- Do not use or store the DVD DRIVE or DVD wire in any of the following locations, as this may result in serious damage.
[Do not use or store in these locations]
 - Anywhere which may vibrate or shock the equipment
 - In direct sunlight
 - In damp or dusty places
 - In places with a sharp change in temperature
 - Close to anything that gives off heat (a heater, etc.)
 - Close to anything with a strong magnetic field (magnets, monitor, speakers, radio, etc.)
 - Anywhere that is likely to get wet (kitchen, etc.)
 - Anywhere with a slope or incline
 - Anywhere with corrosive gas in the air (chlorine, hydrogen sulfide, ammonia, sulfur dioxide, etc.)
 - Anywhere with strong static electricity
- [Do not use in these locations]
 - Close to anything that is highly retentive of heat (carpet, sponge, cardboard, etc.)
 - Anywhere that blocks the DVD DRIVE air vent.
- The DVD DRIVE is a delicate piece of equipment. Avoid the following.
 - Dropping or shaking it violently.
 - Getting water or other liquids on it, or placing small items on top of it.
 - Placing large or heavy items on top of it.
 - Drinking or smoking close to the DVD DRIVE.
- Do not turn off the power to the DVD DRIVE when its access lamp is on or flashing, as this could cause damage to the device.

STOP IMPORTANT

- Do not allow any foreign materials, such as liquids, metals or smoke inside the DVD DRIVE.
- Use a soft, dry cloth to wipe off any dirt or marks on the DVD DRIVE.
- If you need to use a cleaning agent, always use a "neutral" agent diluted in water.
- Never use products or cleaning agents containing benzene, alcohol, thinners, etc.
- Do not touch the lens inside the DVD DRIVE. Doing so may prevent it from reading accurately.
- The chip components on IC boards can be damaged by electrostatic discharge from the human body. Before handling an IC board, always neutralize any static charge in the body by touching a grounded metal surface.
- Some parts are not designed and manufactured specifically for the kit. The manufacturers may discontinue, or change the specifications of such general purpose parts. If this is the case, SEGA cannot repair or replace a failed kit whether or not a warranty period has expired.

STOP IMPORTANT

- Do not use a DVD-ROM with a damaged front. This may cause a malfunction.
- Insert the DVD-ROM into the DVD DRIVE with the label facing upwards.
- Do not get fingerprints or dust particles on the disc. Contaminated discs may lower audio and video quality, and may result in read malfunctions.
- When cleaning the disc, do not use volatile chemicals (benzene, thinner, etc.), cleaning sprays, or antistatic agents.
- Do not use a cracked, warped, or damaged disc. Do not attach papers or seals onto the disc to avoid scratching it. Do not use a disc with signs of peeled seals, tape, etc. If such a disc is placed in the DVD-ROM DRIVE, malfunctions, such as the inability to remove the disc from the drive, may result.
- When cleaning a heavily contaminated disc, use a clean cloth that has been soaked in water and squeezed. After wiping, remove any remaining moisture with a clean, dry cloth.
- How to Hold a Disc
When handling a disc, be careful not to contaminate it with your fingerprints.

With both hands:
Put your thumbs and forefingers on 4 opposite sides of the disc.



6-5 FIG. 02

With one hand:
Insert your forefinger into the center hole, while placing your thumb and middle finger on opposite sides of the disc.

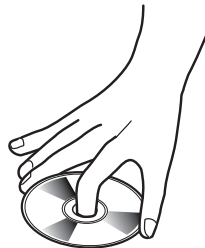

6-5 FIG. 03

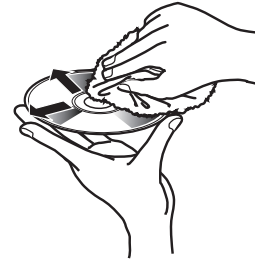

Wipe the disc with a soft cloth, working from the center outwards.

6-5 FIG. 01

- The software is not installed on the game board (LINDBERGH) when the power supply is engaged, so the "Error 22" message is not a malfunction. However, if there is another error display, or if there is no video output at all, there might have been an error in product assembly, wiring connections might be faulty, or the LINDBERGH might not be functioning properly.
- After the power supply is engaged, wait for "Error 22" message to be displayed. If the product is indiscriminately operated in any way beforehand, there could be unexpected problems or malfunctions, as well as damage to parts.
- Once "Error 22" is displayed, set the DVD-ROM in the DVD DRIVE and re-engage the power supply. Installation takes place.

STOP IMPORTANT

- After the power supply is engaged, the DVD DRIVE tray will not come out for about 30 seconds even if you press the switch. This is due to DVD DRIVE initialization.
- The DVD DRIVE tray can come out or return only while the power supply is engaged. The tray cannot be opened or closed while the power is off.
- Even after the software has been installed, store the DVD software kit, DVD DRIVE and DVD wire in a secure location.
- If for any reason installation cannot be completed, an error is displayed. Refer to the LINDBERGH service manual and take corrective action.

Take out the DVD software kit provided.

1 Turn on the MAIN POWER switch on the AC unit.

2 The LINDBERGH startup image appears on the screen. However, it does take several minutes for the projector image to become visible. Wait for at least one minute. An error will occur. Check to see if it is “Error 22.” If it is “Error 22,” proceed to the next operation. If it is not “Error 22,” take corrective measures as indicated in the LINDBERGH service manual.

3 Remove 1 urea (resin-head) screw, and then remove DVD DRIVE case lid.

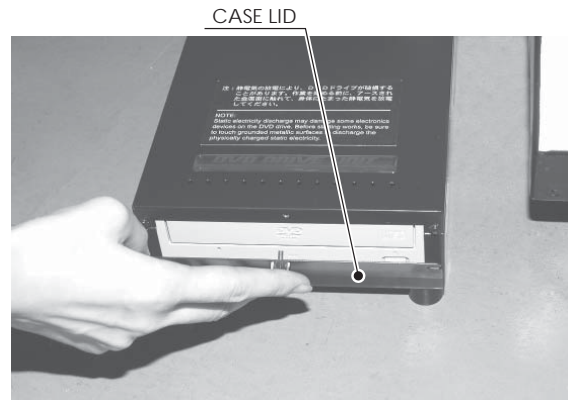

6-5 FIG. 04

4 Press the DVD DRIVE switch. The DVD DRIVE tray comes out. Set the DVD from the DVD software kit into the tray. Always have the DVD label side facing upward.



6-5 FIG. 05

-
- 5** Press the DVD DRIVE switch and the tray returns to its original position.
-
- 6** Reset power. Turn the MAIN POWER switch to OFF, wait for at least 10 minutes, and then turn the switch to ON. Wait until the projector lamp cools.
-
- 7** Software installs automatically from the DVD to the LINDBERGH. In some cases, it may take as long as 30 minutes for the software to install to the LINDBERGH.
-
- 8** After the software installation, the game image appears automatically.
-
- 9** Press the DVD DRIVE switch to have the tray come out, and then remove the DVD.
-
- 10** Press the DVD DRIVE switch to have the tray return. When the power is cut off the tray will not move.
-
- 11** Set the MAIN POWER switch to OFF.
-
- 12** Remove 2 DVD wires from the DVD DRIVE.
-
- 13** Refer to steps 1-13 in “6-3 ATTACHING DVD DRIVE AND KEY CHIP” and follow the steps in reverse order to detach the DVD wire (2 m) from the cabinet.
-
- 14** Attach DVD DRIVE case lid and fasten it with 1 urea (resin-head) screw.
Store DVD DRIVE and DVD software kit at a location where there is no dust or cigarette smoke.
-
- 15** Turn on the MAIN POWER switch on the AC unit. When the game image appears, installation is complete.

6-3 CHECKING ASSEMBLY (SETUP)

Checking Assembly

In the TEST MODE, ensure that the assembly has been made correctly and IC BD. is satisfactory (refer to Chapter 9). Refer to the LINDBERGH Service Manual for details on SYSTEM TEST MODE and “9-3 GAME TEST MODE” for details on GAME TEST MODE.

(1) C.R.T. TEST

In the TEST mode menu, selecting C.R.T. TEST allows the screen (on which the monitor is tested) to be displayed. Although the monitor adjustments have been made at the time of shipment from the factory, make needed by watching the test mode screen. If it is necessary, adjust the monitor by referring to Chapter 14.

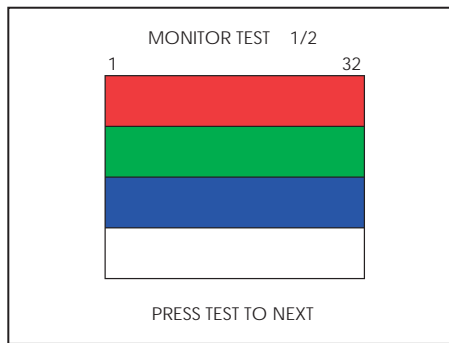

6-6 FIG. 01

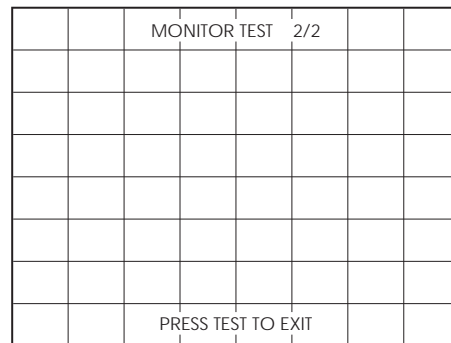

6-6 FIG. 02

(2) INPUT TEST

Selecting INPUT TEST from the GAME TEST Mode menu screen will display a screen that allows input devices to be tested.

Press each switch to check that each is working. If the display next to the input device changes to “ON” or the values displayed change smoothly then that input device and all connections with it are working correctly.

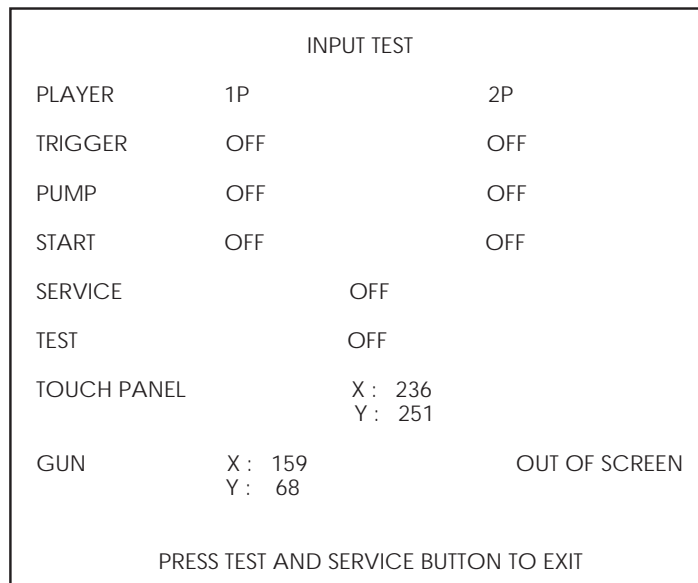

(3) OUTPUT TEST

Selecting OUTPUT TEST from the GAME TEST Mode menu screen will display a screen that allows output devices to be tested.

Operate the lamps and other output devices and check that they are all working correctly.

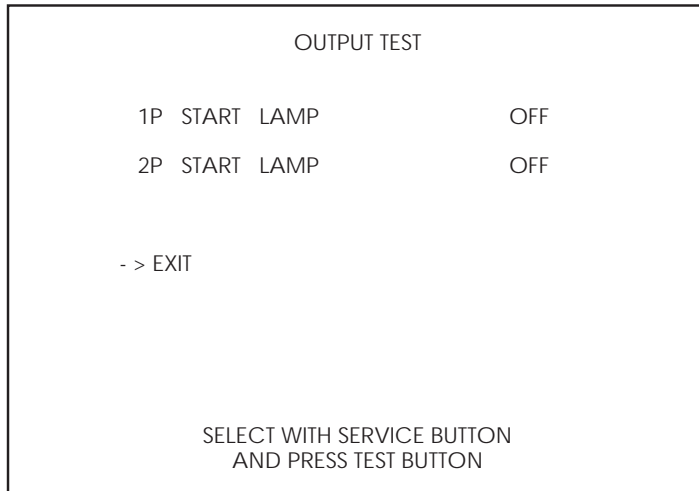

(4) SPEAKER TEST

Selecting SPEAKER TEST from the SYSTEM TEST Mode menu screen will display a screen that allows the speaker output to be tested.

The speakers attached to the machine will output a test sound. Use this to check that all speakers are outputting correctly.

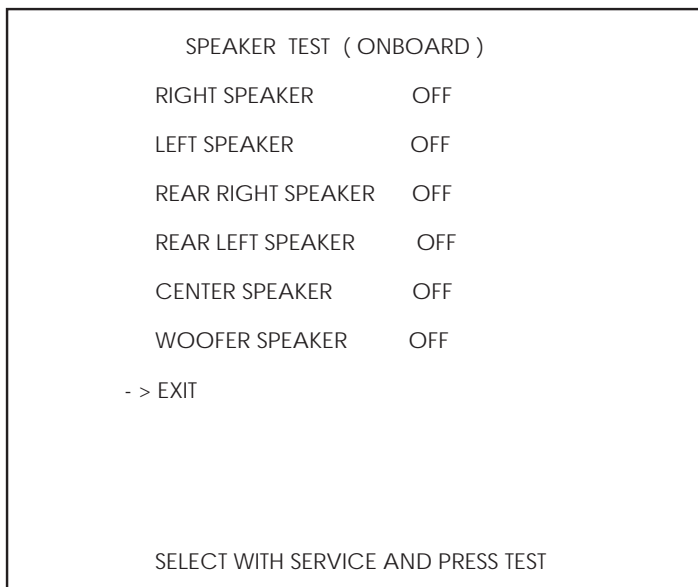

(5) GUN CALIBRATION CHECK

Prior to letting customers use the game, you must play a game and make sure that everything is operating correctly. Although adjusted prior to leaving the factory, incidents in transit may have affected these settings and so check to make sure that adjustment is not required.

GUN ADJUSTMENT						
PLAYER 1			PLAYER 2			
	OLD	NEW		OLD	NEW	
- > TOP	0	0	-> TOP	0	0	
LEFT	0	0	LEFT	0	0	
CENTER	0	0	CENTER	0	0	
RIGHT	0	0	LEFT	0	0	
BOTTOM	0	0	BOTTOM	0	0	
+ OUT OF SCREEN			+ OUT OF SCREEN			+
SELECT WITH START BUTTON AND PULL TRIGGER PRESS TEST BUTTON TO EXIT +						

⚠ WARNING

- **“Store maintenance man” or “Engineer” must be doing of this work. When it works by there are neither knowledge nor a technology, it causes the breakdown.**
- **Please work after cutting the power on/off switch without fail. It causes the electric shock and the short-circuit accident.**
- **Please do not damage wiring. When wiring is damaged, it causes the electric shock and the short-circuit accident.**

- THE HOUSE OF THE DEAD 2, U/R type, DX type and Super DX type
- DEATH CRIMSON, U/R type and DX type
- THE LOST WORLD, U/R type, DX type and Super DX type
- BRAVE FIRE FIGHTERS
- SAMBA DE AMIGO
- CONFIDENTIAL MISSION, U/R type and DX type
- SHAKATTO TAMBOURINE
- LUPIN THE 3RD THE SHOOTING, U/R type and DX type
- THE MAZE OF THE KINGS, U/R type and DX type
- THE HOUSE OF THE DEAD 3, U/R type and DX type
- VIRTUA COP 3, U/R type and DX type
- GHOST SQUAD, U/R type and DX type
- THE HOUSE OF THE DEAD 4, SPECIAL, U/R type and DX type
- 2 SPICY, U/R type

- 1) Turn the power off.
- 2) Undo the Screws and remove the monitor cabinet back door.

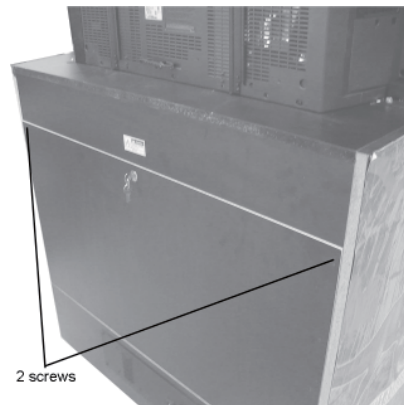

- 3) The interference prevention wire is connected to the IC board inside the cabinet.
If multiple units of the same game are installed side by side, make sure that the game units that are connected to the interference prevention wires are arranged so that they alternate with the units that are not connected.

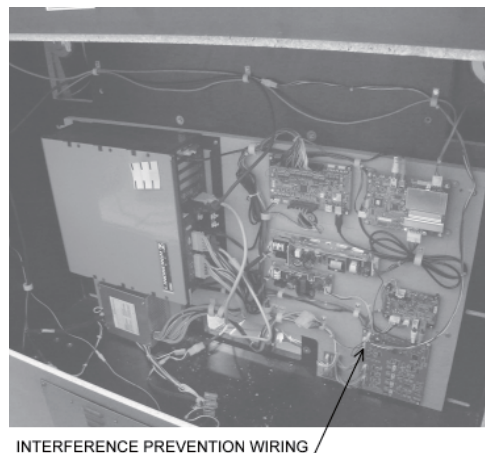

7 PRECAUTIONS WHEN MOVING THE MACHINE

⚠ WARNING

- When moving the machine, be sure to pull out the plug from the power supply. Moving the machine with the plug still inserted can cause the power cord to be damaged, resulting in a fire and/or electric shock.
- When moving the machine on the floor, retract the adjusters, and ensure that the casters make contact with the floor. Pay careful attention so that the casters do not run over power cords and earth wires. Damaging the power cords can cause an electric shock and/or short circuit.
- When moving across an area with a sharp difference in height first separate the monitor cabinet and pedestal cabinet. Tilting them whilst the two are still joined together may damage the connectors and could cause injury.
- When moving the monitor cabinet, do not push it from the rear side. Push it from sideways. Pushing the monitor cabinet from the rear side can have the ASSY DLP fall down, causing personal injury, etc. In case the floor has slanted surfaces or step-like differences, be sure to move the machine by 2 or more persons.
- When the monitor cabinet and pedestal cabinet are not connected the cabinet is unstable on its own. Pushing it may cause it to fall over.
- When detached always keep the cabinet on a level surface and make sure it does not start to lean to the left or right whilst working on it.

⚠ CAUTION

Do not push on any parts made of glass or plastic, as these parts may break and result in bodily injury.



IMPORTANT

When moving the cabinet do not hold or push the gun holders. This could deform their shape or cause damage to them.

Pushing the monitor cabinet from the back may make it fall over. Always push it from the side.

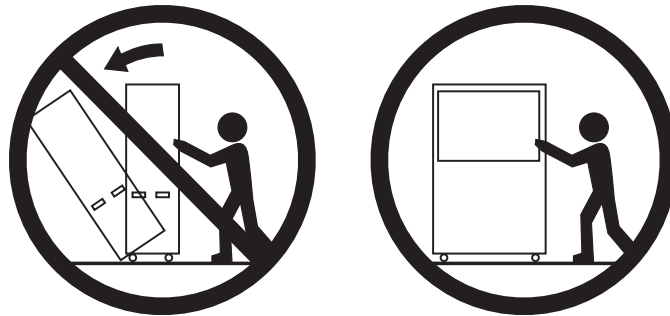

8 GAME DESCRIPTION

The following explanations apply to the product when functioning properly. If the product operates differently from the following contents, a fault may have occurred. Immediately look into and eliminate the cause of the fault to ensure proper operation.

The fluorescent light in the billboard is always on whenever the power is turned on.

Demo movies and game rankings are displayed on both 56" main monitor and 15" touch screen. Audio may also be played from speakers on the monitor cabinet and speakers inside gun controller. However, it is possible to select whether sound is output or not during Attract Mode through Test Mode settings.

Both the right and left START buttons are integrated with a light. The light flashes when sufficient coins are inserted for play. The light goes out when the START button is pressed to start the game.

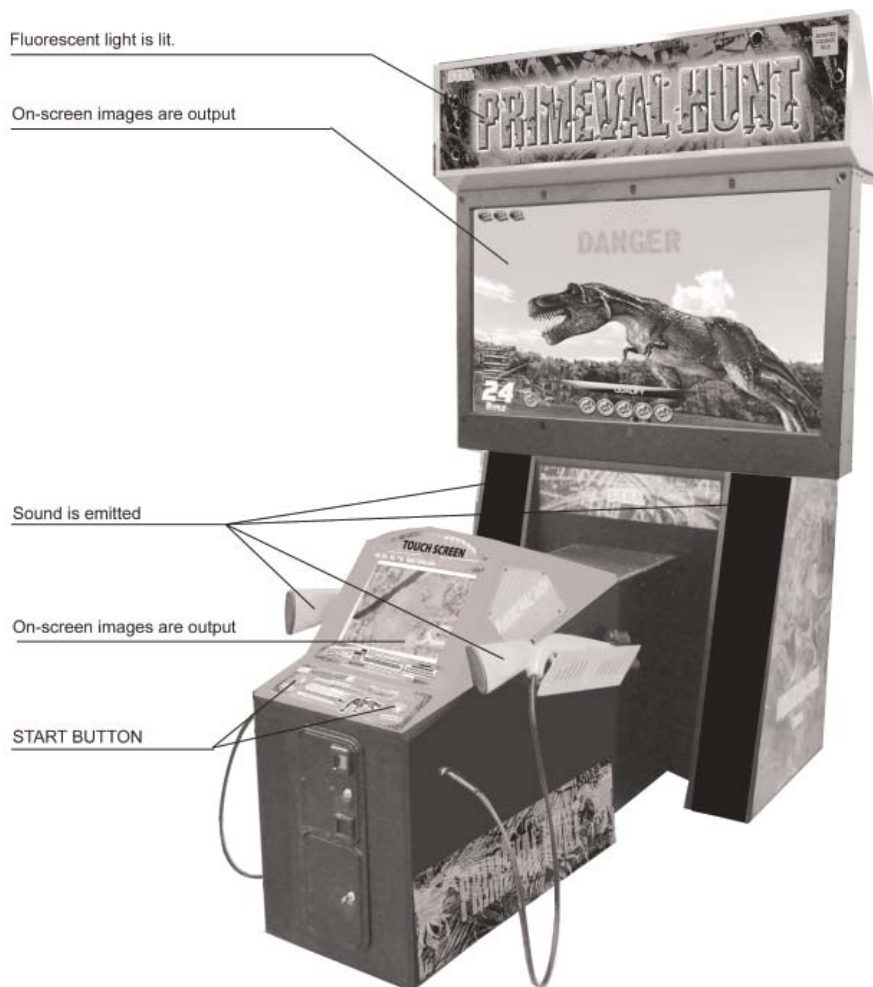

8-1 GAME OUTLINE

Capture the target dinosaurs in each area in limited time with assigned number of bullets.

The remaining time is displayed at the top of the screen as per circled in red on right-hand picture.

8 GAME DESCRIPTION

AREA SELECT screen displays the main target dinosaur in each area.



Sub screen (touch screen) displays the location of main target dinosaurs



The assigned number of bullets is displayed on the screen prior to the game start.



The number of remaining bullets is displayed at the bottom left side for player 1 and bottom right side for player 2 on the screen.



8-2 TOUCH PANEL CONTROL IN GAME PLAY

(1) TOUCH MOVING

Touch the point where you want to go on the map and you will start moving there.

Touch dinosaur on the map and you will proceed close to the dinosaur

You will be detoured, if there is any part that can't be passed through.



(2) DRAG MOVEMENT

Drag the player icon and move an arbitrary route that you can draw on the map.

It stops moving when it comes at where it can't pass such as cliffs.



(3) DRAG MOVEMENT OF VIEW CHANGE

Drag the view object (blue triangle) to change view of player icon.



(4) ARMS SWITCHING TO ROCKET LAUNCHER

Touch the ARMS SWITCHING BUTTON on the screen to change weapon from regular weapon to ROCKET LAUNCHER.

Touch again to change it back to regular weapon.



(5) ZOOM FUNCTION IN BONUS GAME

The picture can be zoomed in or out in "SNIPER ON THE SPIRE" mode in bonus game by touching or dragging the zoom button at the bottom of the screen.



8-3 RULE OF BONUS GAME

There are 3 kinds of BONUS GAMES and one of them will appear at random after each 3 stages are cleared.

(1) EGG ROBBERS

Rule: Protect the eggs not to be deprived by other dinosaur, Oviraptor during the assigned time

Item gain condition:

1 PLAYER GAME> Defeat more than 10 Oviraptors and clear the game.

2 PLAYER GAME> Clear the game and the winner gets item.



(2) SNIPER ON THE SPIRE

Rule: Defeat as many dinosaurs as possible by shooting from top of the spire using the zoom function within the assigned time.

Item gain condition:

1 PLAYER GAME> Defeat more than 5 dinosaurs and clear the game.

2 PLAYER GAME> Clear the game and the winner gets item.



(3) BATTALION ION THE BRIDGE

Rule: Shoot the bridge where the battarion of velociraptors are approaching down to the lake shooting ropes of the bridge.

Item gain condition:

1 PLAYER GAME> Clear the game

2 PLAYER GAME> Clear the game and the winner gets item.



8-4 ITEM RULE

The item can be obtained by clearing the bonus game and making a higher score than certain score.
The order of items obtained is as follows.

(1) ADVANTAGE OF ITEM OBTAINED BY 1ST BONUS GAME CLEAR

- Rifle: 4 additional bullets only in next stage
- Shot gun : 3 additional slugs only in next stage
- Bowgun: 6 additional allows only in next stage

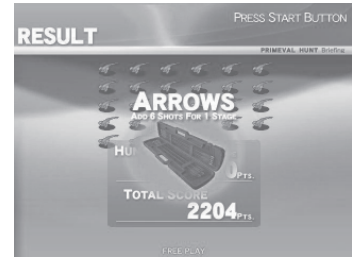
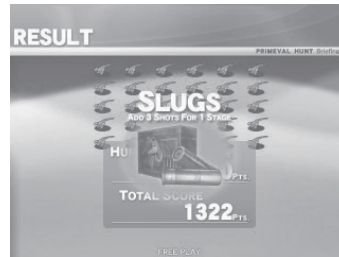
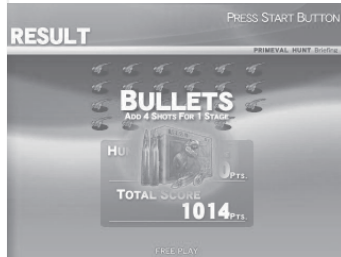

(2) ADVANTAGE OF ITEM OBTAINED BY 2ND BONUS GAME CLEAR

The hitting ratio is going up only in next stage.

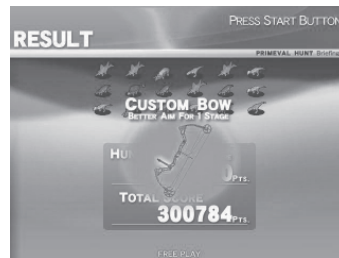

(3) ADVANTAGE OF ITEM OBTAINED BY 3RD BONUS GAME CLEAR

Rocket Launcher: 1 additional Rocket only in next stage



8-5 GAME FLOW

ADVERTISE



WEAPON SELECT



AREA SELECT



TARGET INTRODUCTION



GAME START



BONUS GAME



ENDING (ON 12 STAGES CLEAR)



ENDING (ON 13 STAGES CLEAR)



NAME ENTRY (WHEN RANK IN)



GAME OVER

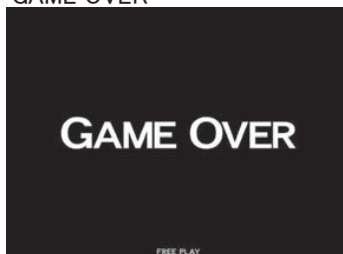

8 GAME DESCRIPTION

9 TEST MODE

Perform periodic tests and data checks using the TEST and SERVICE buttons inside the cabinet. Follow the instructions in this chapter to conduct checks when the game machine is first installed, when money is being collected, or when the game machine does not operate properly.

Shown below are the tests and screens to be used for different problems.

This product uses a LINDBERGH game board and a DVD DRIVE. In the system, a different game can be played by putting a different DVD ROM in the DVD DRIVE.

For this reason, the product's Test Mode consists of two modes: a System Test Mode for systems in which coin settings, for instance, are made for products that use the same system, and the Game Test Mode for setting of difficulty level, etc., and for input/output test of operational units used exclusively with this product.

9 TABLE 01 EXPLANATION OF TEST MODE

ITEMS	DESCRIPTION	REFERENCE SECTIONS
INSTALLATION OF MACHINE	<ol style="list-style-type: none"> 1. Check to ensure each is the standard setting at shipment. 2. Check each Input equipment in the INPUT TEST mode. 3. Check each Output equipment in the OUTPUT TEST mode. 	Chapter 6.
PERIODIC SERVICING	<p>Periodically perform the following:</p> <ol style="list-style-type: none"> 1. Ascertain each setting. 2. To test each Input equipment in the INPUT TEST mode. 3. To test each Output equipment in the OUTPUT TEST mode. 	Chapter 12.
CONTROL SYSTEM	<ol style="list-style-type: none"> 1. To check each Input equipment in the INPUT TEST mode. 2. Adjust or replace each Input equipment. 	Chapter 9, 16
MONITOR	In the Monitor Adjustment mode, check to see if Monitor (Projector) adjustments are appropriate.	Chapter 6
IC BOARD	<ol style="list-style-type: none"> 1. Information Display Screen 2. SPEAKER TEST 	Chapter 9
DATA CHECK	Check such data as game play time and histogram to adjust the difficulty level, etc.	Chapter 9

9-1 SWITCH UNIT AND COIN METER

⚠ WARNING

Never touch places other than those specified. Touching places not specified can cause electric shock and short circuit accidents.

⚠ CAUTION

Be careful that a finger or hand does not get caught when opening/closing the coin chute door.

STOP IMPORTANT

- When you enter the Test Mode, fractional coin and bonus adder data is erased.
- Adjust the sound to the optimum volume, taking into consideration the environmental requirements of the installation location.
- Removing the Coin Meter circuitry renders the game inoperable.

SWITCH UNIT

Open the coin chute door, and the switch unit shown will appear.
The functioning of each SW is as follows:

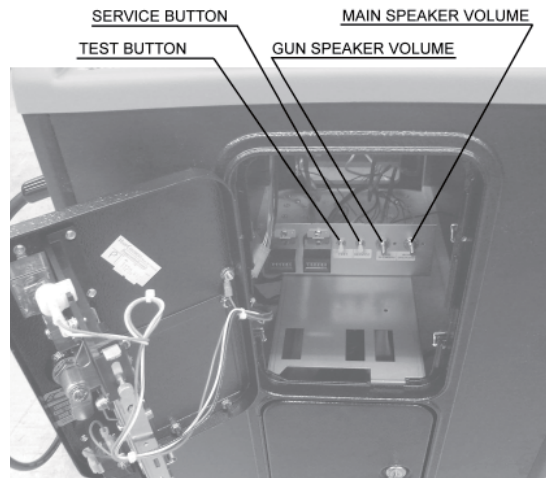

TEST BUTTON:

For the handling of the test button, refer to the following pages

SERVICE BUTTON:

Gives credits without registering the coin meter

SOUND VOLUME (MAIN):

Adjusts sound volume for the speakers on the monitor cabinet

SOUND VOLUME (GUN):

Adjusts sound volume for the speakers inside gun controllers

COIN METER

Open the Coin Door by using the key to have the Coin Meters appear.

COIN METERS

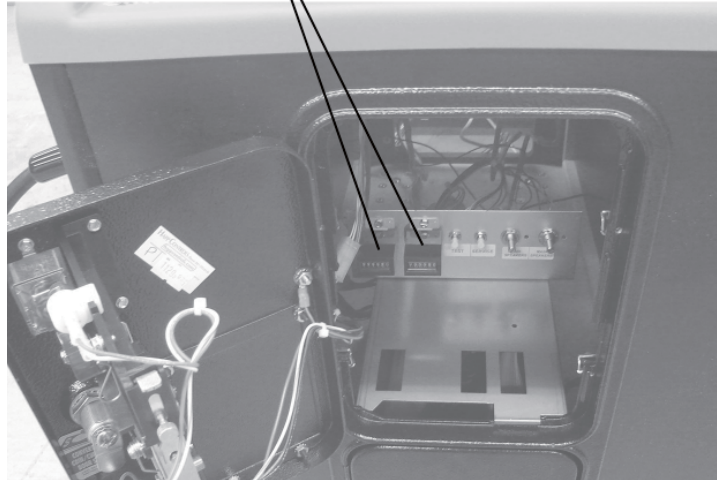

9-2 SYSTEM TEST MODE

STOP IMPORTANT

- Refer to BOOKKEEPING in GAME TEST MODE for this product's data.
- Adjust for an appropriate sound volume in consideration of the installation site.
- If the coin meter circuit is removed, play cannot be executed.
- Read the LINDBERGH service manual included with the product for details about System Test Mode. However, the settings for this product should follow the specifications in this manual.

System Test Mode can be used to check the information or the operation of the LINDBERGH board, adjust Monitor color, and perform coin/credit settings.

Press the TEST Button after powering on the unit to display the following SYSTEM TEST MENU.

```

                SYSTEM TEST MENU

SYSTEM INFORMATION
STORAGE INFORMATION
JVS TEST
MONITOR TEST
SPEAKER TEST
COIN ASSIGNMENTS
CLOCK SETTING
NETWORK SETTING
GAME TEST MODE
-> EXIT

        SELECT WITH SERVICE AND PRESS TEST

```

Use the SERVICE Button to move the cursor to the desired test item. Press the TEST Button to enter the selected item.

Press the TEST Button when GAME TEST MODE is selected to change to the Test Menu specific to this game. Refer to the section "9-3 GAME TEST MODE."

After the TEST is complete, move the cursor to EXIT and press the TEST button to return to the Game Advertisement screen.

9-3 GAME TEST MODE

STOP IMPORTANT

- When changing the game configuration, changes will not take effect until the Game Test Mode properly after configuration changes. Be sure to exit the Game Test Mode properly after configuration changes.
- Do not configure the game in ways not described in this text. It is possible that the game will not function properly.

9-3-1 GAME TEST MODE Menu

Select GAME TEST MODE from the System Menu screen to display the Game Test Menu screen.

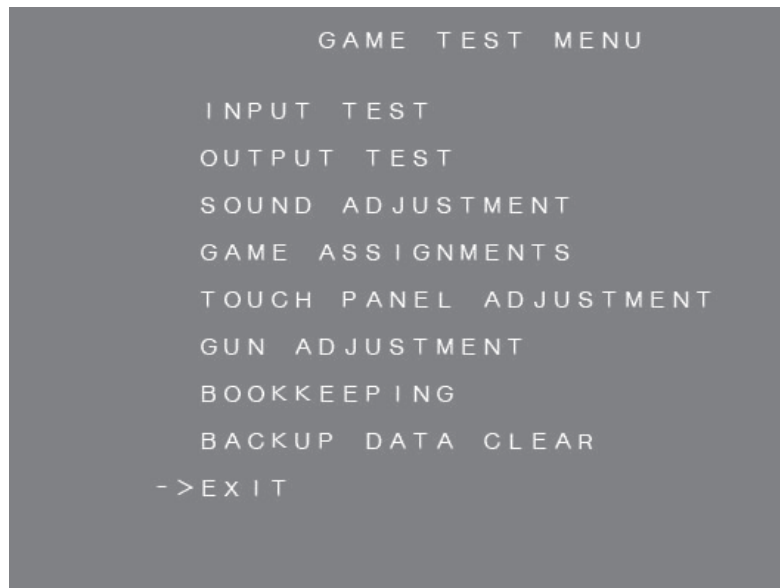

1. Use the SERVICE Button to move the cursor to the desired test item.
2. Press the TEST Button to enter the selected item.
3. Move the cursor to EXIT and press the TEST Button to return to the System Menu screen

9-3-2 INPUT TEST

Select INPUT TEST to display the following screen and check the status of input devices. This test should be used periodically to check that each input device is functioning correctly.

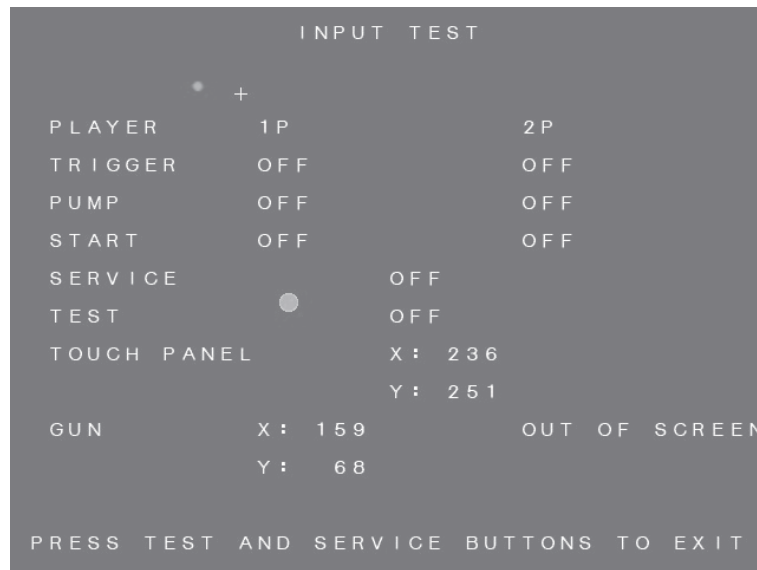

1. Other controls are working properly if the OFF display changes to ON when operating the corresponding input device.

2. Press the SERVICE and TEST Buttons simultaneously to return to the Game Test Menu Screen.

TRIGGER: The trigger on the gun

PUMP: The pump on the gun

START: The player start buttons

SERVICE The service button

TEST The test button

TOUCH PANEL X: The X axis position on the touch screen touched

TOUCH PANEL Y: The Y axis position on the touch screen touched

GUN X: The X axis position on the screen targeted by the gun

GUN Y: The Y axis position on the screen targeted by the gun

9-3-3 OUTPUT TEST

Select OUTPUT TEST to display the following screen and check the status of output devices. This test should be used periodically to check that the lamps are functioning correctly.

Use the SERVICE Button to move the cursor to the desired test item. Press the TEST Button to enter the selected item's test.

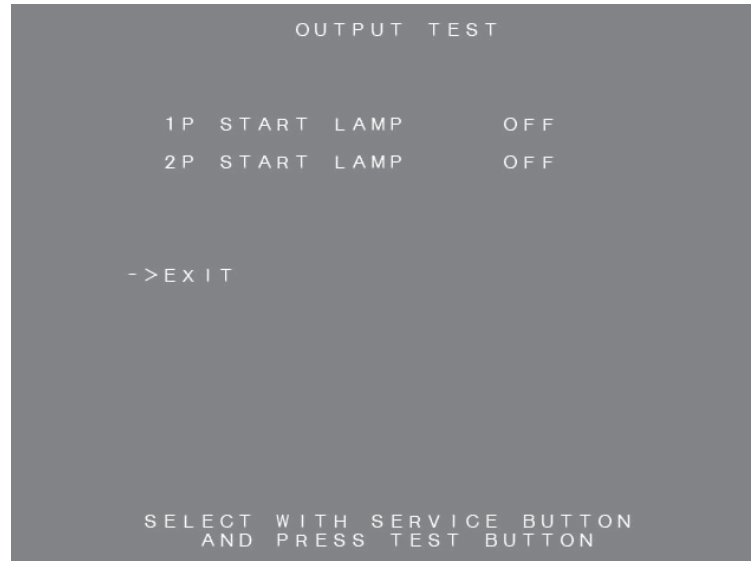

Perform the tests as follows.

1P START LAMP: Select START1 LAMP and press the TEST Button to turn the option ON. The player 1 START Button will light up. The lamp will remain on for as long as the TEST Button is held down.

2P START LAMP: Select START2 LAMP and press the TEST Button to turn the option ON. The player 2 START Button will light up. The lamp will remain on for as long as the TEST Button is held down.

Move the cursor to EXIT and press the TEST Button to return to the Game Test Mode screen.

9-3-4 GAME ASSIGNMENTS

Select GAME ASSIGNMENTS to display the current game settings and make changes.

Changes to settings are not enabled until Game Assignments is exited. After changing settings, be sure to exit the Test Mode.

Use the SERVICE Button to move the cursor to the desired test item. Press the TEST Button to enter the selected item's test

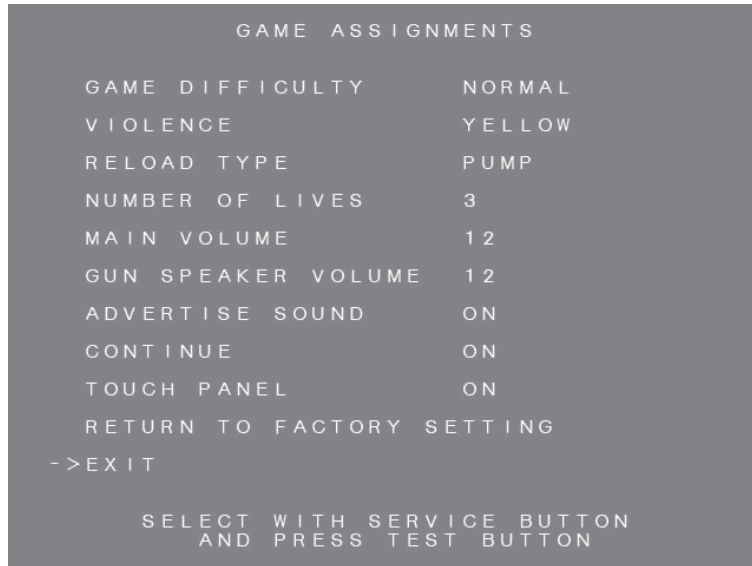

GAME DIFFICULTY: Set the level of difficulty to one of 4 levels; EASY -> NORMAL -> HARD -> EXPERT

VIOLENCE: You can set the color of blood to one of three settings; YELLOW, RED or OFF.

RELOAD TYPE: You can set the reload type to one of two method; PUMP or OUT OF SCREEN

NUMBER OF LIFE: The number of lives the player will start the game with. Can be set between 1 and 5

MAIN VOLUME: You can adjust the volume level of the main speakers between 0 and 15.

GUN SPEAKER VOLUME: You can adjust the volume level of the gun speakers between 0 and 15.

ADVERTISE SOUND: You can set the Attract Mode (Advertise) sound to ON or OFF.

CONTINUE: You can set the continue setting to ON or OFF.

TOUCH PANEL: Set TOUCH PANEL to OFF only when the touch panel breaks down. When it is set to OFF, the touch panel will activate as follows.

- The data received from the touch oanel is disregarded.
- Any instruction is not shown on the touch screen.
- TIPS (instruction of how to use the touch screen) is not shown.

After changing the settings, select EXIT and press the TEST Button to return to the Game Test Mode screen.

9-3-5 GUN ADJUSTMENT

This adjusts the 1P and 2P gun sights.
 Select GUN ADJUSTMENT to display the following screen.

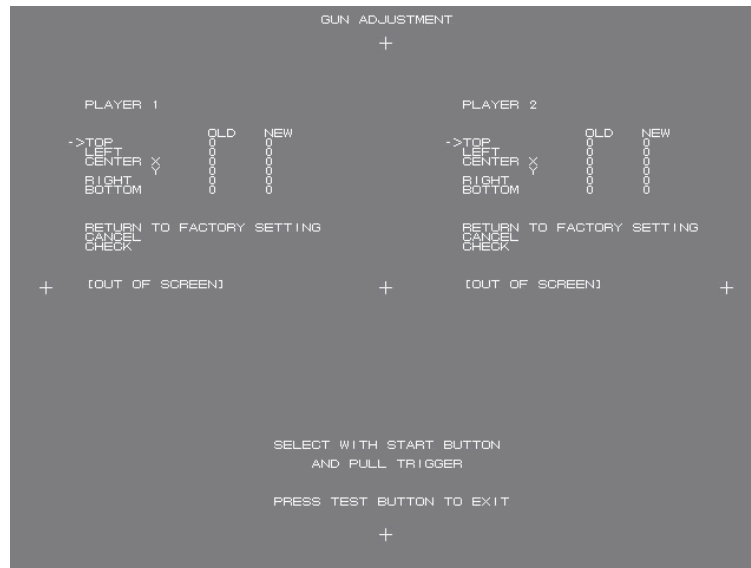

Perform the sight settings for the guns to be used in the game as follows.

- TOP: Shoot the “+” mark at the top of the screen to set the value of top part.
- LEFT: Shoot the “+” mark at the left of the screen to set the value of left side.
- CENTER: Shoot the “+” mark at center of the screen to set the value of canter part.
- RIGHT: Shoot the “+” mark at the right of the screen to set the value of right side.
- BOTTOM: Shoot the “+” mark at the bottom of the screen to set the value of botom part.

RETURN TO FACTORY SETTING:

Reset the setting to the factory setting

CANCEL:

The settingchange made is canceled and returns to the last time setting.

CHECK:

Pointing the gun at the screen displays the gun sight for that gun. You can check to see if the sight lines up properly at this screen.

1P gun sight is displayed in blue mark and 2P sight is displayed in red mark
 "OUT OF SCREEN" is displayed when the gun sight is perceived to be out of screen.

9-3-6 TOUCH PANEL ADJUSTMENT

This adjusts the touch screen setting.
Select TOUCH PANEL ADJUSTMENT to display the following screen.



Use the SERVICE Button to move the cursor to the desired test item. Press the TEST Button to enter the selected item's test. Details for each item are as follows.

TOUGH PANEL ADJUSTMENT: Adjust the touch panel setting.

Press (touch) "+" marks for 5 positions in order shown on the touch screen.
Then the screen displays COMPLETE.

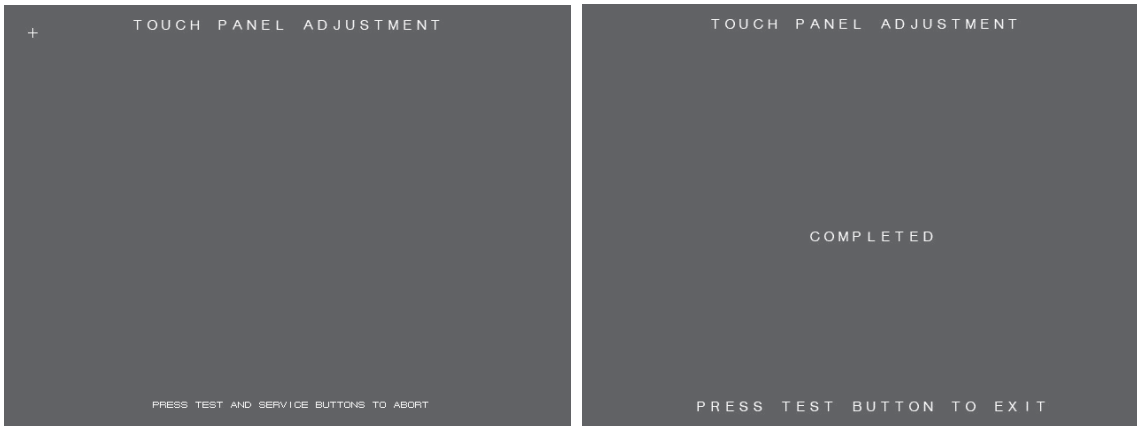

RETURN TO FACTORY SETTINGS: Reset the touch panel setting to the default factory setting.

9-3-7 BOOKKEEPING

Select BOOKKEEPING to display the following screens of operating status data.

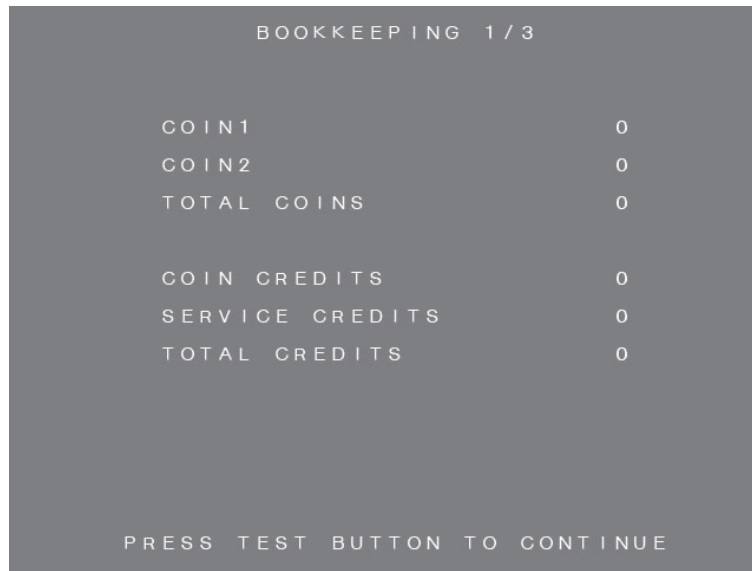

The display items for the screen (PAGE1/3) are as follows.

- COIN 1: The number of coins inserted in COIN CHUTE 1
- COIN 2: The number of coins inserted in COIN CHUTE 2
- TOTAL COINS: The total number of coins inserted
- COIN CREDITS: The total number of coins inserted
- SERVICE CREDITS: The number of credits added by the SERVICE Button
- TOTAL CREDITS: The total number of credits

Press TEST button to display the next screen (PAGE 2/3).

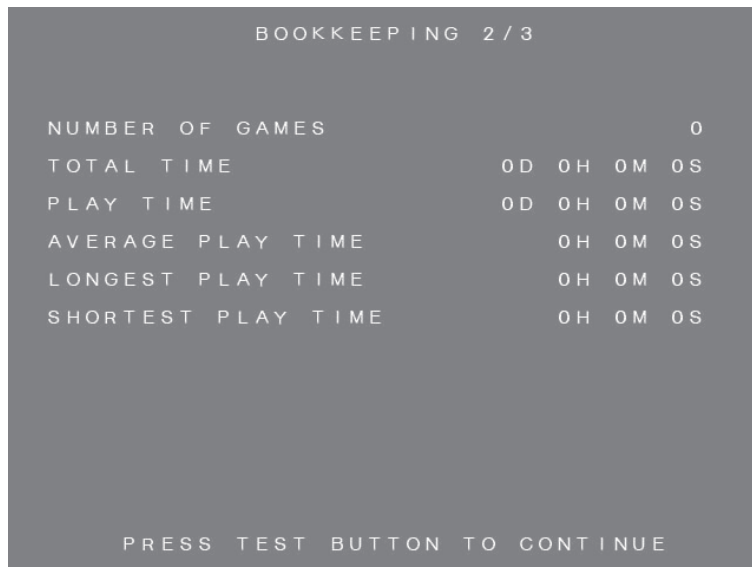

- NUMBER OF GAMES: The total number of games played
- TOTAL TIME: The total time
- PLAY TIME: The total play time
- AVERAGE PLAY TIME: The average play time
- LONGEST PLAY TIME: The longest play time
- SHORTEST PLAY TIME: The shortest playtime

Press the TEST Button to display the next screen (PAGE 3/3).

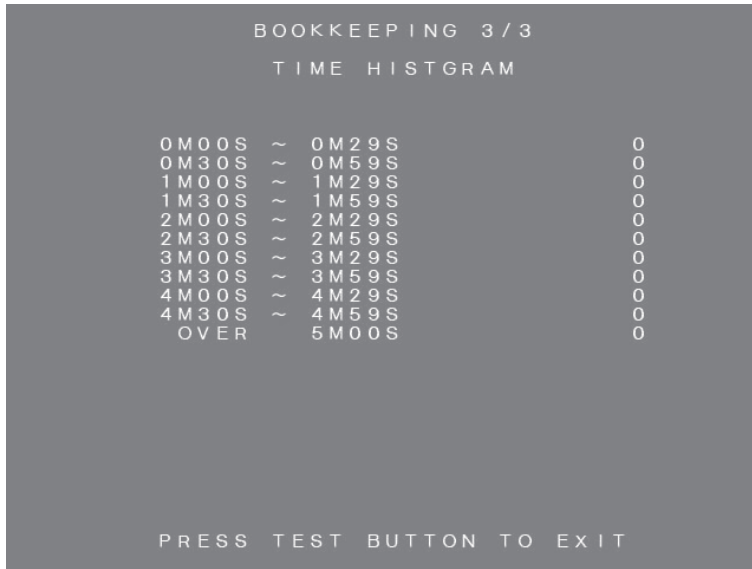

This displays play times on a scale from 0M00S to 4M59S with 30-second intervals. All play times over 5 minutes are included in the item OVER 5M00S.

Press the TEST Button after viewing. You will return to the Game Test Mode screen.

9-3-8 BACKUP DATA CLEAR

Select BACKUP DATA CLEAR to display the following screen.

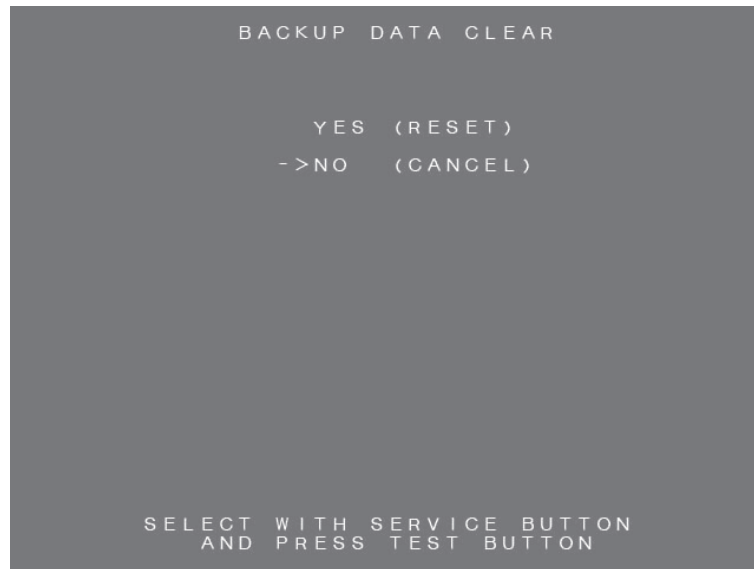

This screen allows you to clear backup data. Use the cursor to select YES or NO.

- YES: Clear all data in BOOKKEEPING, ranking data and credit data.
- NO: Go back to the menu screen without clearing data.



Select YES and press the TEST Button to clear all data in BOOKKEEPING, ranking data and credit data. Clearing data does not affect other game settings.

When the data has been cleared, the screen displays “COMPLETED”.

Press the TEST Button again to return to the Game Test Menu Screen.

10 LICENSE MARK

Copyright © 1994-2007 Lua.org, PUC-Rio.

Permission is hereby granted, free of charge, to any person obtaining a copy of this software and associated documentation files (the “Software”), to deal in the Software without restriction, including without limitation the rights to use, copy, modify, merge, publish, distribute, sublicense, and/or sell copies of the Software, and to permit persons to whom the Software is furnished to do so, subject to the following conditions:

The above copyright notice and this permission notice shall be included in all copies or substantial portions of the Software.

THE SOFTWARE IS PROVIDED “AS IS”, WITHOUT WARRANTY OF ANY KIND, EXPRESS OR IMPLIED, INCLUDING BUT NOT LIMITED TO THE WARRANTIES OF MERCHANTABILITY, FITNESS FOR A PARTICULAR PURPOSE AND NONINFRINGEMENT. IN NO EVENT SHALL THE AUTHORS OR COPYRIGHT HOLDERS BE LIABLE FOR ANY CLAIM, DAMAGES OR OTHER LIABILITY, WHETHER IN AN ACTION OF CONTRACT, TORT OR OTHERWISE, ARISING FROM, OUT OF OR IN CONNECTION WITH THE SOFTWARE OR THE USE OR OTHER DEALINGS IN THE SOFTWARE.

Copyright © 1999-2000 Pawel W. Olszta. All Rights Reserved.

Permission is hereby granted, free of charge, to any person obtaining a copy of this software and associated documentation files (the “Software”), to deal in the Software without restriction, including without limitation the rights to use, copy, modify, merge, publish, distribute, sublicense, and/or sell copies or substantial portions of the Software.

The above copyright notice and this permission notice shall be included in all copies or substantial portions of the Software.

THE SOFTWARE IS PROVIDED “AS IS”, WITHOUT WARRANTY OF ANY KIND, EXPRESS OR IMPLIED, INCLUDING BUT NOT LIMITED TO THE WARRANTIES OF MERCHANTABILITY, FITNESS FOR A PARTICULAR PURPOSE AND NONINFRINGEMENT. IN NO EVENT SHALL PAWEŁ W. OLSZTA BE LIABLE FOR ANY CLAIM, DAMAGES OR OTHER LIABILITY, WHETHER IN AN ACTION OF CONTRACT, TORT OR OTHERWISE, ARISING FROM, OUT OF OR IN CONNECTION WITH THE SOFTWARE OR THE USE OR OTHER DEALINGS IN THE SOFTWARE.

Except as contained in this notice, the name of Pawel W. Olszta shall not be used in advertising or otherwise to promote the sale, use or other dealings in this Software without prior written authorization from Pawel W. Olszta.

The Font to be used in the game

The typefaces included herein are solely developed by DynaComware.

11 FLUORESCENT LIGHT/OTHER LAMPS REPLACEMENT

WARNING

- When working with the product, be sure to turn the power off. Working with the power on may cause an electric shock or short circuit.
- You may get burned by a hot fluorescent lamp or other lamps. Pay full attention to the lamps when performing the work.
- Be sure to use lamps of the designated rating. Using lamps of undesignated rating can cause a fire or malfunctioning.
- There is the danger of short circuits or smoke generation due to deterioration of insulation in lighting fixtures resulting from age deterioration. Check for anomalies such as the following: Does it smell like something is burning? Is there socket discoloration? Are any lamps being replaced frequently? Do lamps not go on properly?

CAUTION

- Be careful when handling the plastic parts. Failure to observe this may cause injury or damage due to fragments, etc.
- Do not attempt to replace billboard fluorescent lamps while standing on the base. If you should misstep while working, you could stumble or fall down.

Billboard Fluorescent Light

- 1 Turn off the power.
- 2 Remove the 5 screws then remove the front billboard plate.

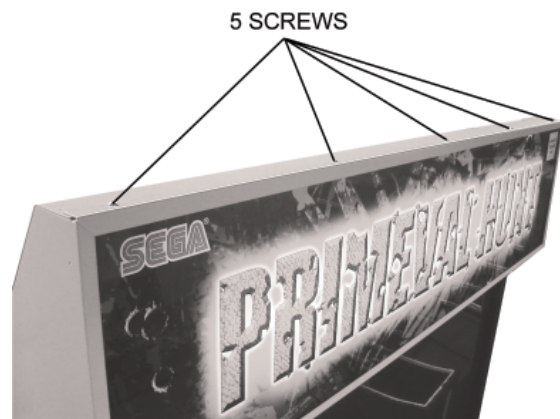

-
- 3** Remove a clamp taking a screw out and remove a red CCFL from each left and right side.

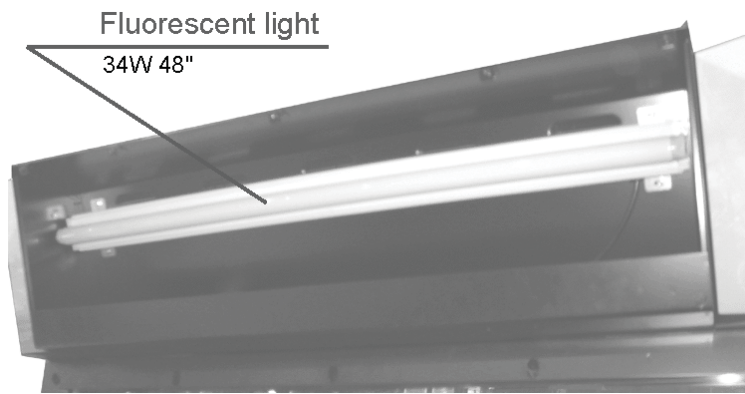

12 PERIODIC INSPECTION

The items listed below require periodic check and maintenance to retain the performance of this machine and to ensure safe business operation.

When handling the controller, the player will be in direct contact with it. In order to always allow the player to enjoy the game, be sure to clean it regularly. Also, it is advisable to provide wet tissue, etc. available for player use.

WARNING

- Once a year, check to see if power cords are damaged, the plug is securely inserted, dust is accumulated between the socket outlet and the power plug, etc. Using the product with accumulated dust in the interior may cause fire or electric shock.
- Never use a water jet, etc. to clean the inside and outside of the cabinet. If wetness occurs for any reason, do not use the product until it has completely dried.
- Once a year, request the office shown on this manual or the dealer from whom the product was originally purchased to perform the internal cleaning. Using the product with accumulated dust in the interior may cause fire or other accidents. Note that you are liable for the cost of cleaning the interior parts.
- There is the danger of accidents involving electrical shorts circuits or fire caused by factors such as the deterioration of insulation in electrical and electronic equipment over time. Check that there are no abnormalities such as odors from burning.

	Description	Period	Reference
CABINET	Checking adjuster grounding	Daily	6
CONTROL UNIT (GUN)	Cleaning	As necessary	-
	Checking sight	Weekly	9
	Inspecting switches	Monthly	9
COIN SELECTOR	Inspecting coin switches	Monthly	
	Testing coin insertion	Monthly	
	Cleaning the coin selector	Tri-monthly	
PROJECTOR	Screen cleaning	Weekly	DLP manual
	Checking adjustments	Monthly or when moving	6
GAME BOARD	Performing memory test	Monthly	9
	Checking settings	Monthly	9
POWER SUPPLY PLUG	Inspecting and cleaning	Annually	
INTERIOR	Cleaning	Annually	
CABINET SURFACES	Cleaning	As necessary	

Cleaning the Cabinet Surfaces

When the cabinet surfaces are badly soiled, remove stains with a soft cloth dipped in water or diluted (with water) chemical detergent and squeezed dry. To avoid damaging surface finish, do not use such solvents as thinner, benzene, etc. other than ethyl alcohol, or abrasives, bleaching agent and chemical dustcloth.

Some general-purpose household, kitchen and furniture cleaning products may contain strong solvents that degrade plastic components, coatings, and print. Before using any cleaning product, read the product's cautionary notes carefully and test the product first on a small area that is not highly visible.

13 TROUBLESHOOTING

13-1 TROUBLESHOOTING (WHEN NO ERROR MESSAGE IS SHOWN)

WARNING

- In order to prevent electric shock and short circuit, be sure to turn power off before performing work.
- Be careful so as not to damage wirings. Damaged wiring can cause electric shock or short circuit.
- After removing the cause of the functioning of the Circuit Protector, reinstate the Circuit Protector. Depending on the cause of the functioning, using the Circuit Protector as is without removing the cause can cause generation of heat and fire hazard.
- In the event that a problem cannot be resolved by employing the procedures listed in this Manual, be sure to request service from the office shown on this Manual or the dealer from whom the product was originally purchased. Attempts to employ procedures other than those specified in this Manual can cause electrical shock, shorting, or fire.
- In the event of a problem that is not described here, be sure to contact the office shown on this Manual or the dealer from whom the product was originally purchased. Careless attempts at repair can result in electrical shock, shorting, or fire.

PROBLEMS	CAUSE	COUNTERMEASURES
With Main SW ON, no activation.	Power is not supplied.	Securely insert the power plug into the plug socket.
	Power supply/voltage is not correct.	Make sure that power supply/voltage is correct.
	Loose Fuse or wiring around of AC power line and harness.	Check Fuses, AC power harness, wirind and connectors.
The color on the projector screen is incorrect.	Image adjustment is not appropriate.	Adjust appropriately (see Manual of DLP monitor).
No sound is emitted.	Sound volume adjustment is not appropriate.	Adjust sound volume (see Sec. 9).
	Board and Amplifier malfunctioning	Perform the sound test and confirm (see Sec. 9) .

PROBLEMS	CAUSE	COUNTERMEASURES
Control Unit (Gun) sighting is not satisfactory.	Sights are not aligned due to changes in the surrounding environment.	Perform sighting adjustment in the test mode
	LED board malfunctioning	Check to ensure that the LED lights up. If it does not light up, replace.
	Sensor unit malfunctioning	Replace the sensor unit.
	LED board and LED board cover are contaminated.	Wipe off soiled surface
	Fuse on the sensor unit has blown due to a momentary electrical overload.	Fix the source of overload, then replace the fuse.
The Control Unit (Gun) does not appear to be operating correctly.	A fault with the microswitches	Use an Input Test to make sure they change between ON and OFF. If they do not, exchange the faulty micro switch.
	A fault with the LED board	Check that the LEDs are on. If not, exchange them.
	The sensor unit is broken.	Exchange the sensor unit.
The fluorescent light does not come on.	The fluorescent light has died.	Exchange the fluorescent light.
	The fluorescent light has died.	Exchange the starter or the ballast.
Touch screen does not appear to be operating correctly	Touch panel is not set up correctly	Set it correctly in TOUCH PANEL ADJUSTMENT in the TEST mode.
	Touch panel usage is set to OFF	Set the touch panel to ON in the GAME ASSIGNMENT in the test mode

Replacing Fuses

⚠WARNING

- In case fuse replacements other than those stated in this manual are necessary, contact where you purchased the product from for inquiries regarding this matter.
- In order to prevent an electric shock, be sure to turn power off and unplug from the socket outlet before performing work by touching the internal parts of the product.
- Be careful so as not to damage wirings. Damaged wiring can cause electric shock and short circuit accidents.
- Be sure to use fuses meeting specified rating. Using fuses exceeding the specified rating can cause fire and electric shock accidents.
- After eliminating the cause of the blowing of fuse, replace the fuse. Depending on the cause of fuse blowing, continued use with the fuse as is blown can cause generation of heat and fire hazard.

The main fuse located on the AC power plate on the back of the monitor cabinet.

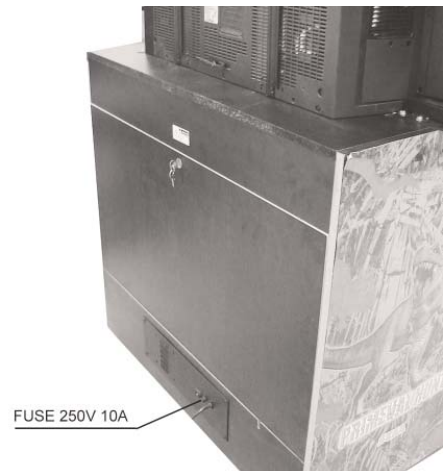

Other fuse is located in the minitor cabinet.

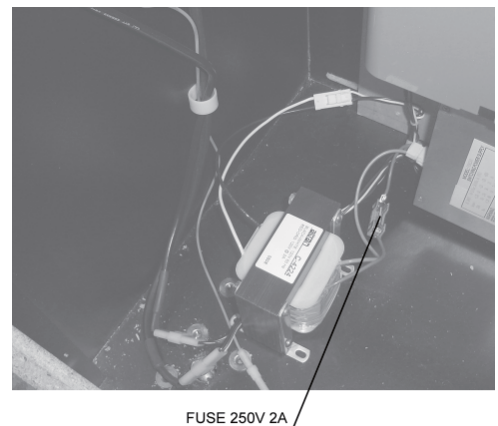

16-2 ERROR MESSAGES

This product displays the following messages when it detects an error. Read the error description and follow the steps indicated. Refer to the LINDBERGH Service Manual for details on error messages displayed with the LINDBERGH logo.

Error 01 DISPLAY CAUSE COUNTERMEASURES	Game Program Not Found. The key chip is not connected. Check that the key chip is connected correctly. Check that the keychip is not inserted the wrong way or that the key chip from a different system is not inserted.
Error 02 DISPLAY CAUSE COUNTERMEASURES	Game Program Not Available. The key chip is not supported. Send the LINDBERGH board in for repair with the key chip still in place.
Error 05 DISPLAY CAUSE COUNTERMEASURES	Wrong Region. The game is for a foreign region. Use a domestic game.
Error 06 DISPLAY CAUSE COUNTERMEASURES	I/O Device Not Found. The LINDBERGH board's I/O board cannot be found. Send the LINDBERGH board in for repair with the key chip still in place.
Error 07 DISPLAY CAUSE COUNTERMEASURES	Graphic Card Not Found. The LINDBERGH board's graphics card cannot be found. Send the LINDBERGH board in for repair with the key chip still in place.
Error 08 DISPLAY CAUSE COUNTERMEASURES	Sound Card Not Found. The LINDBERGH board's sound card cannot be found. Send the LINDBERGH board in for repair with the key chip still in place.
Error 09 DISPLAY CAUSE COUNTERMEASURES	System Memory Not Enough. The LINDBERGH board does not have enough memory. Send the LINDBERGH board in for repair with the key chip still in place.
Error 10 DISPLAY CAUSE COUNTERMEASURES	Unexpected Game Program Failure. The game program crashed due to an unexpected error. Turn the power off and then restart.
Error 11 DISPLAY CAUSE COUNTERMEASURES	JVS I/O board is not connected to main board. (1) The I/O board is not connected. (2) Unreliable connection between the main board and the I/O board. (1) Connect the I/O board to the main board. Verify that the power cable is connected to I/O board. (2) Reconnect or replace the JVS cable that connects the I/O board to the main board.
Error 12 DISPLAY CAUSE COUNTERMEASURES	JVS I/O board does not fulfill the game spec. The correct I/O board is not connected. Use an I/O board that provides the proper input/output for the game.
Error 14 DISPLAY CAUSE version. COUNTERMEASURES	Network firmware version does not fulfill the game spec. Required version XX.XX. The firmware version installed on either the network board or the DIMM Media board is older than the required version. Use a network board or DIMM Media board with firmware that meets or exceeds the required version.
Error 15 DISPLAY CAUSE COUNTERMEASURES	Game Program Not Found. The key chip is not connected. Check that the key chip is connected correctly. Check that the key chip is not inserted the wrong way or that the key chip from a different system is not inserted.
Error 21 DISPLAY CAUSE COUNTERMEASURES	Game Program Not Found on Game Disk. There is no program image on the game disk. Check that a game disk corresponding to the key chip is inserted into the drive.
Error 22 DISPLAY CAUSE COUNTERMEASURES	Game Program Not Found on Device. There is no game image on the game installer device. Perform a reinstall from the game disk.

<p>Error 24 DISPLAY CAUSE COUNTERMEASURES</p>	<p>DVD Drive Not Found. The DVD drive cannot be found. Connect the DVD drive.</p>
<p>Error 25 DISPLAY CAUSE COUNTERMEASURES</p>	<p>Game Disk Not Found. The game disk cannot be found. Insert the game disk.</p>
<p>Error 26 DISPLAY CAUSE COUNTERMEASURES</p>	<p>Storage Device Not Found. The program installer device cannot be found. Send the LINDBERGH board in for repair with the key chip still in place.</p>
<p>Error 27 DISPLAY CAUSE COUNTERMEASURES</p>	<p>Storage Device is Not Acceptable. The program installer device does not have enough space. Send the LINDBERGH board in for repair with the key chip still in place.</p>
<p>Error 28 DISPLAY CAUSE COUNTERMEASURES</p>	<p>This Game Disk is Not Acceptable. The game disk cannot be read correctly. Exchange the game disk for a proper game disk. Check that the game disk is not scratched, damaged or dirty.</p>
<p>Error 29 DISPLAY CAUSE COUNTERMEASURES</p>	<p>Cannot Control DVD Drive. The DVD drive cannot be controlled. The DVD drive may be damaged.</p>
<p>Error 31 DISPLAY CAUSE COUNTERMEASURES</p>	<p>Storage Device Not Enough. The program installer device does not have enough space. Send the LINDBERGH board in for repair with the key chip still in place.</p>
<p>Error 32 DISPLAY CAUSE COUNTERMEASURES</p>	<p>Installing Game Program Failed. Transfer of the program failed. Check that the DVD drive is connected correctly. Check that the game disk is not scratched, damaged or dirty.</p>
<p>Error 33 DISPLAY CAUSE COUNTERMEASURES</p>	<p>Storage Device is Not Acceptable. The program installer device cannot be found. Send the LINDBERGH board in for repair with the key chip still in place.</p>
<p>Error 34 DISPLAY CAUSE COUNTERMEASURES</p>	<p>Storage Device Not Found. The program installer device cannot be found. Send the LINDBERGH board in for repair with the key chip still in place.</p>
<p>Error 35 DISPLAY CAUSE COUNTERMEASURES</p>	<p>Storage Device is Not Acceptable. The program installer device does not have enough space. Send the LINDBERGH board in for repair with the key chip still in place.</p>
<p>Error 36 DISPLAY CAUSE COUNTERMEASURES</p>	<p>Storage Device May be Broken. The program installer device is broken. Send the LINDBERGH board in for repair with the key chip still in place.</p>
<p>Error 37 DISPLAY CAUSE COUNTERMEASURES</p>	<p>Verifying Game Program Failed. The program image is unverified due to the program image not existing on the game disk or server. Check that the correct game disk is inserted.</p>
<p>Error 41 DISPLAY CAUSE COUNTERMEASURES</p>	<p>Server Not Respond. The server is not responding. Check the network settings. Set IP Address and other settings. Check that the network cable has not been pulled out.</p>
<p>Error 42 DISPLAY CAUSE COUNTERMEASURES</p>	<p>Server Mount Failed The server directory is could not be reached. Check the network settings. Set IP Address and other settings. Check that the network cable has not been pulled out.</p>
<p>Error 43 DISPLAY CAUSE COUNTERMEASURES</p>	<p>IP Address Not Assigned. An IP Address could not be obtained from the DHCP server. Check the network settings. Set IP Address and other settings. Check that the network cable has not been pulled out.</p>

Error 44
DISPLAY
CAUSE
COUNTERMEASURES

Game Program Not Found on Server.
No program image on the network server.
Check that the game title, place on the network server, and the key chip correspond to each other.

Caution 51
DISPLAY
CAUSE
COUNTERMEASURES

Wrong Resolution Setting.
The game does not support the current resolution settings.
Change the DIP SW to the correct settings and restart.

Caution 52
DISPLAY
CAUSE
COUNTERMEASURES

Wrong Horizontal/Vertical Setting.
The monitor horizontal/vertical settings are incorrect.
Change the DIP SW to the correct settings and restart.

14 GAME BOARD

14 GAME BOARD

⚠ WARNING

- In order to prevent electric shock and short circuit hazards, be sure to turn power off before performing work.
- Be careful not to damage the wires. Damaged wires may cause electric shock or short circuit or present a fire risk.
- When replacing or repairing the game board and then returning it to the cabinet, be sure to reconnect all the connectors correctly. Improper connection may cause electric shock, short circuit or fire.
- When connecting the connector, check the orientation carefully and connect securely. The connector must be connected in the proper direction. If it is connected in the wrong direction or indiscriminately at an incline so that a load is applied, the connector or its terminal pins could break, causing a short circuit or fire.
- No connectors other than those connected on the game board when first delivered can be used by this product. Do not connect any other wires to any of the unused connections. This may lead to the generation of heat, smoke or burn outs.

⚠ CAUTION

In this product, setting changes are made during the test mode. The game board need not be operated. Use the game board, etc. as is with the same setting made at the time of shipment so as not to cause electric shock and malfunctioning.

14-1 REMOVING THE LINDBERGH

- 1 Turn off the power.
- 2 Remove 2 screws on the monitor cabinet back door. Then unlock and open the door.



3 Remove all connectors connecting to the game board.

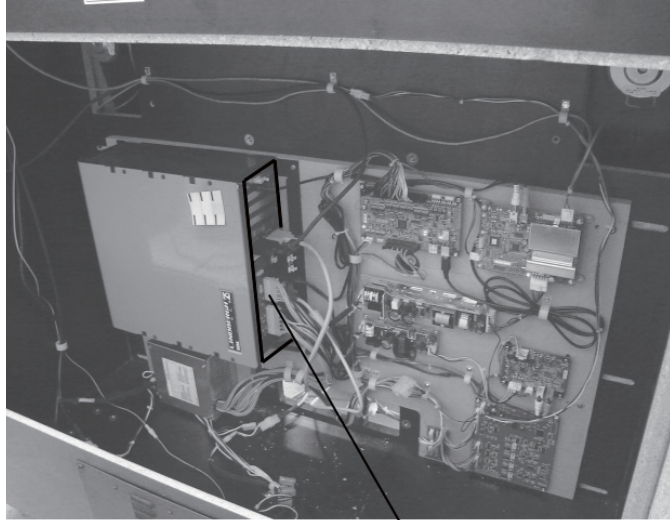

Remove all connectors.

4 Remove 4 screws and remove the game board.

14-2 COMPOSITION OF THE GAME BOARD

STOP IMPORTANT

- The game board becomes the game board for this product once the key chip is inserted.
- The DIP SW (dip switches on the board must be set as specified below. If set incorrectly for this product, an error will be displayed and the game will not run.

ASSY CASE LBG L 1GB RTV (844-0019D-01) <USA>

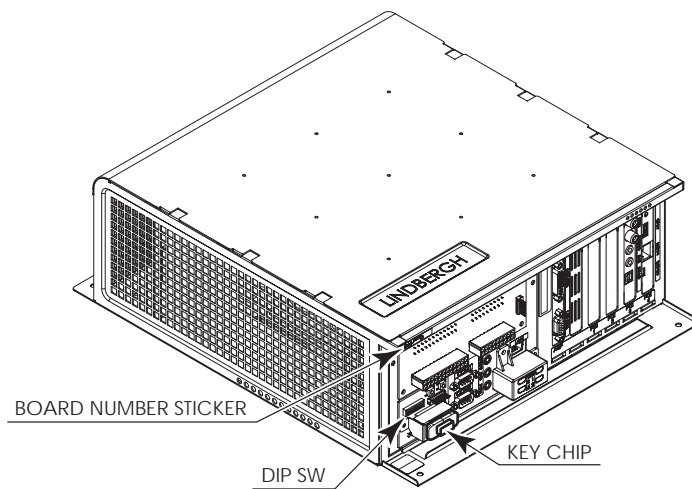

18-2 FIG. 01

DIP SW Setting

Use this product with the DIP SW settings shown in the figure below.



18-2 FIG. 02

15 DESIGN-RELATED PARTS

For the warning display stickers, refer to Chapter 1.

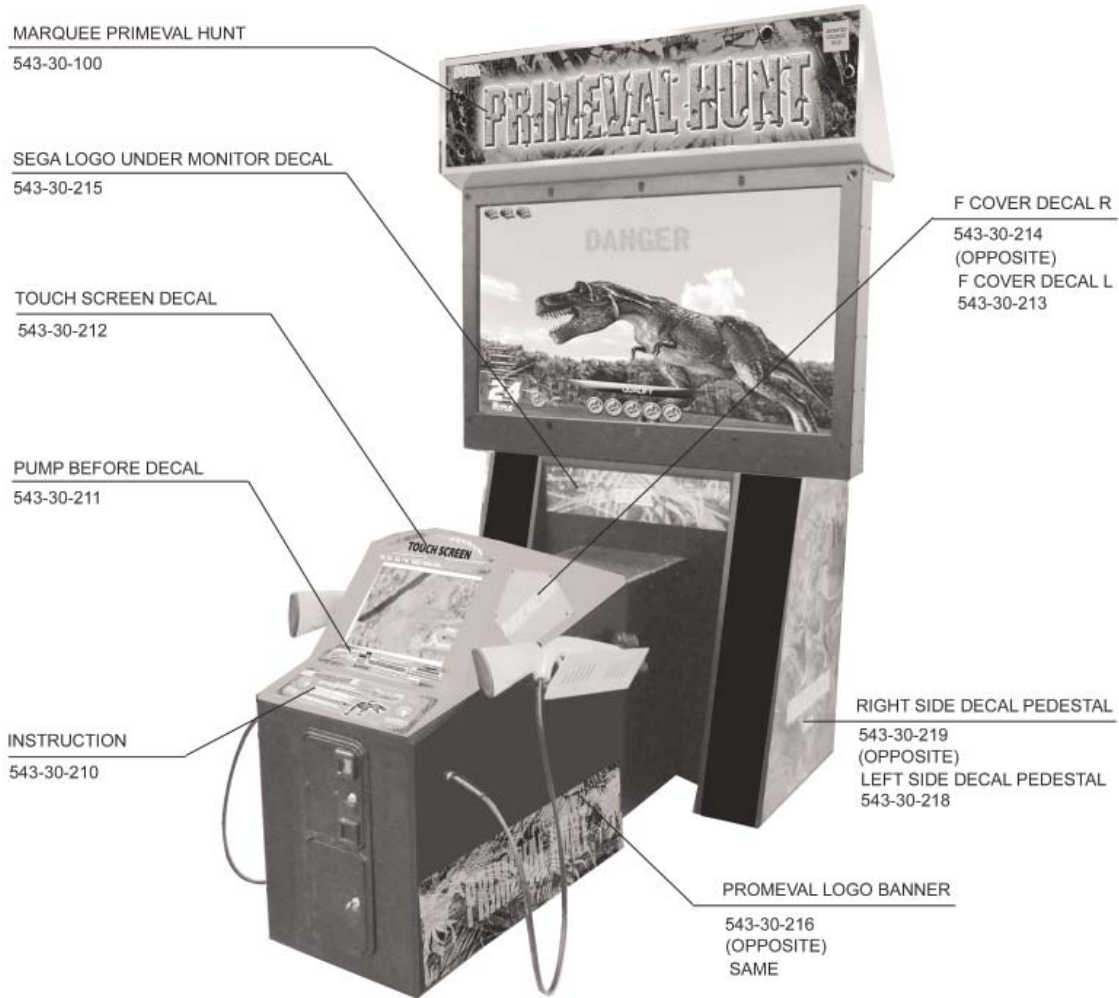

16 PARTS LIST

(CABINET PARTS)

56" DLP MONITOR HL-T5676S

99-60-720

LED BD GUN SENSE HOD (X10)

838-13145R02

IR COVER

JPT-1082

SHOTGUN W/SPKR,SENSOR

99-50-343

15" TOUCH SCREEN

200-6086

SW PB OBSA-45UM-Y-1 FLED-Y-5V

509-6101

CONTROL PANEL COVER PRIMEVAL

543-70-610

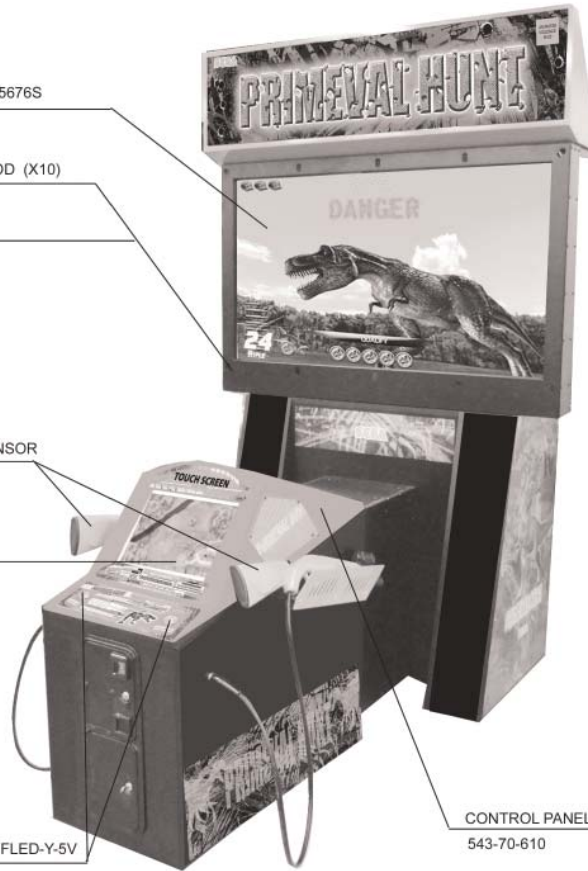

(INSIDE ELECTRIC COMPONENTS) INSIDE MONITOR PEDESTAL CABINET

ASSY CASE LBJ L512MB USA

845-0001D-01

I/O CONTROL BD FOR JVS

837-14505

SOUND AMP ANALOG IN

838-14515-A0191

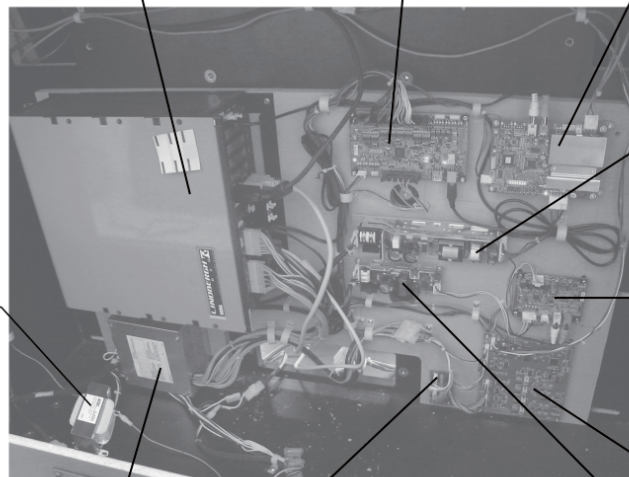

ISOLATION TRANSFORMER 2 AMPS

99-60-222

SW REGU LCA 100S-24-H

400-5421-10024H

CLASS D 10W STEREO AMP

839-1315

IC BD G.SENSE 19(OMC-GZH200-H)

838-14465R03

POWER SUPPLY FOR LBG

99-60-719

TYPE2 GUN PROTECT CKT BD/HRN

998-0165

SW REGU LCA 30S-12

400-5421-03012

SHOTGUN W/SPKR, SENSOR ORANGE 99-50-343

ITEM NO.	QTY.	PART NO.	DESCRIPTION
1	1	196-0728-00	HOUSING- LEFT F/SEGA PUMP ACTION SHOTGUN
2	1	196-0728-00	HOUSING- RIGHT F/SEGA PUMP ACTION SHOTGUN
3	1	196-0732-00L	PUMP HOUSING- SEGA L.H.
4	1	196-0732-00R	PUMP HOUSING- SEGA R.H.
5	1	196-0775-00	REAR CAP F/PUMP ACT. SHOTGUN
6	1	143-1245-00	PLASTIC WASHER
7	2	196-0309-00	BUMPER- STOP FOR ACTIVATION BAR
8	1	196-0774-00	TRIGGER FOR PUMP ACT. SHOTGUN/RIFLE
9	10	143-0095-00	SCREW 4-32 X3/8 BHMS T-10 TORX
10	11	143-1294-00P	SCREW 4-32 X5/16 BHMS T-10 TORX W/PATCH
11	1	143-2314-00	SCREW 4-32 X 7/32 BHMS T-10
12	13	143-0094-00	NUT HEX 6-32 .25 A.F. BLACK OXIDE
13	2	143-2311-00	SCR 10-32 X 1-1/2 BH TORX BLACK
14	2	143-2350-00	NUT HEX 10-32 JAM NYLOCK BLK OX
15	1	196-0793-00	ACTIVATION BAR FOR PUMP ACTION RIFLE
16	1	143-2312-00	SCREW 4-32 X 9/16 BH TORX
17	1	196-0308-00	SPRING PUMP- CARNEVEL PUMP SHOTGUN
18	1	196-0311-00	TORSION SPRING TRIGGER PUMP SHOTGUN
19	4	143-0172-00	SCREW #2 X 1/2 TYPE B. PPH
20	2	143-2313-00	SCREW 4-40 X 3/8 BHMS T-10 TORX
21	1	196-0318-00	TRIGGER & PUMP SWITCH AND HARNESS ASSY
22	1	196-0752-1NF	TETHER HOSE AND HARNESS ASSY F/INFRARED SEGA RIFLE
23	2	196-0753-00	SPEAKER HOLDER BRACKET
24	2	196-0758-00	SPEAKER COVER BRKT F/SEGA SHOTGUN
25	2	196-0734-00	SPEAKER BASE BRACKET
26	2	130-5982-88	AW SHOTGUN SPEAKER
27	2	196-0919-00	SPEAKER SPONGE ROUND
28	1	ADH-2130	SENSOR UNIT (OMC-GZH200-H)
29	1	ADH-2004	CASE RUBBER FRONT CAP
30	1	ADH-2003	CASE RUBBER TOP
31	1	ADH-2001	SENSOR CASE L
32	1	ADH-2002	SENSOR CASE R
33	1	196-0918-00	SENSOR CASE SUPPORT BRKT
34	4	143-2347-00	CORD CLAMP SR10
35	1	143-2351-00	WASHER #6 FLAT .03T BLK OX
36	1	143-0004-00	WASHER #6 FLAT .03T ZINC
37	2	143-0492-00	SCREW 4-40 X .25 PH. PN. HD
38	4	143-2349-00	SCREW 4-32 X 1-1/2 BHMS T10
39	1	143-2348-00	SCREW 4-32 X 7/8 BHMS T10
40	2	196-0922-00	SENSOR CASE SPONGE LARGE
41	2	196-0921-00	SENSOR CASE SPONGE LARGE

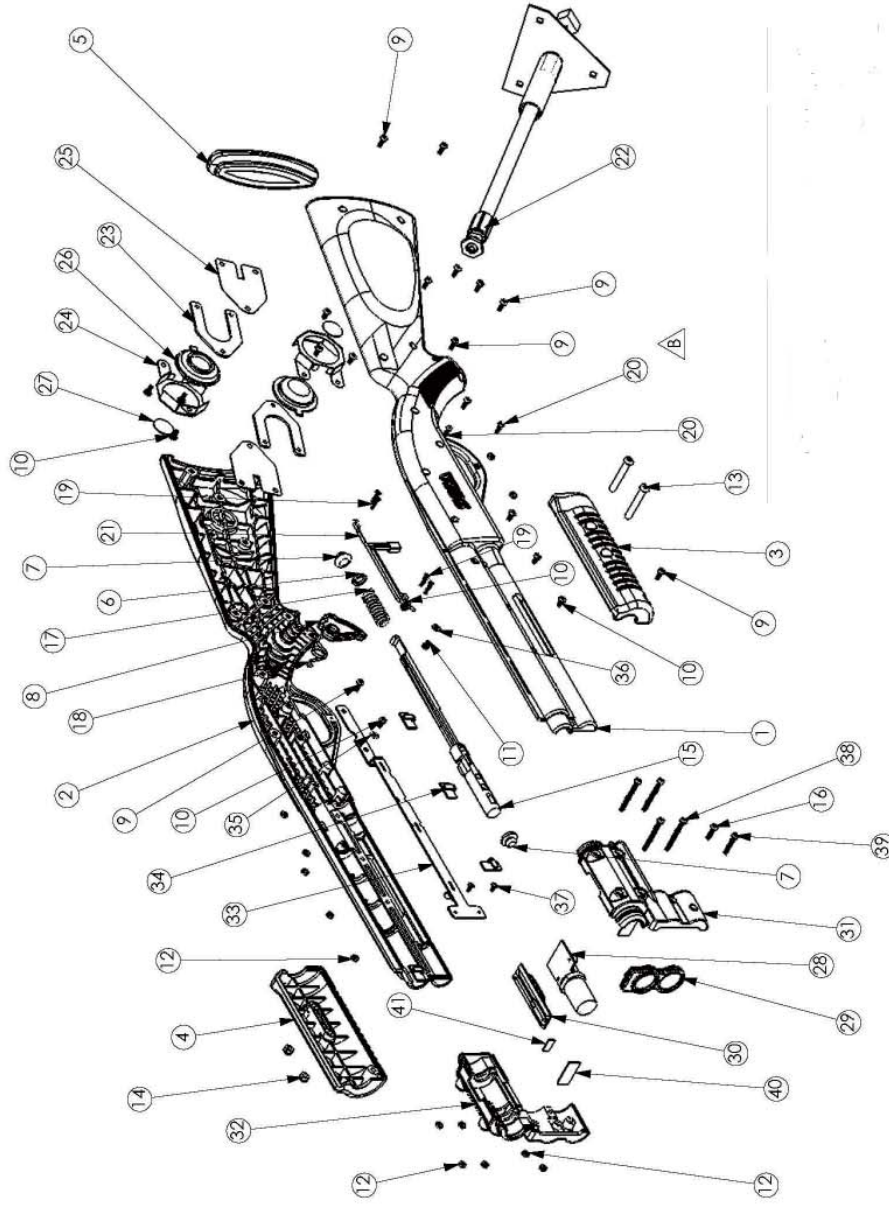

16 PARTS LIST

17 WIRE COLOR CODE TABLE

⚠ WARNING

The DC power wire color for this product is different from previous SEGA titles. Working from the previous wire colors will create a high risk of fire.

The color codes for the wires used in the diagrams in the following chapter are as follows.

- A PINK
- B SKY BLUE
- C BROWN
- D PURPLE
- E LIGHT GREEN

Wires other than those of any of the above 5 single colors will be displayed by 2 alphanumeric characters.

- 1 RED
- 2 BLUE
- 3 YELLOW
- 4 GREEN
- 5 WHITE
- 7 ORANGE
- 8 BLACK
- 9 GRAY

If the right-hand side numeral of the code is 0, then the wire will be of a single color shown by the left-hand side numeral (see the above).

Note 1: If the right-hand side numeral is not 0, that particular wire has a spiral color code. The left-hand side character shows the base color and the right-hand side one, the spiral color.

<Example> 51.....WHITE/RED

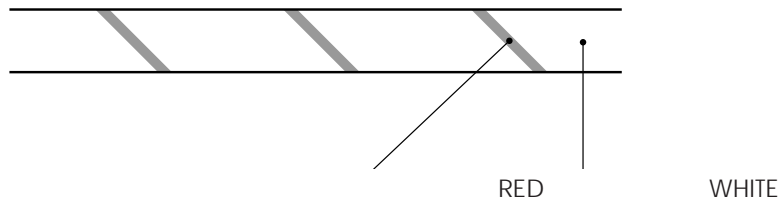

Note 2: The character following the wire color code indicates the size of the wire.

- U: AWG16
- K: AWG18
- L: AWG20
- None: AWG22

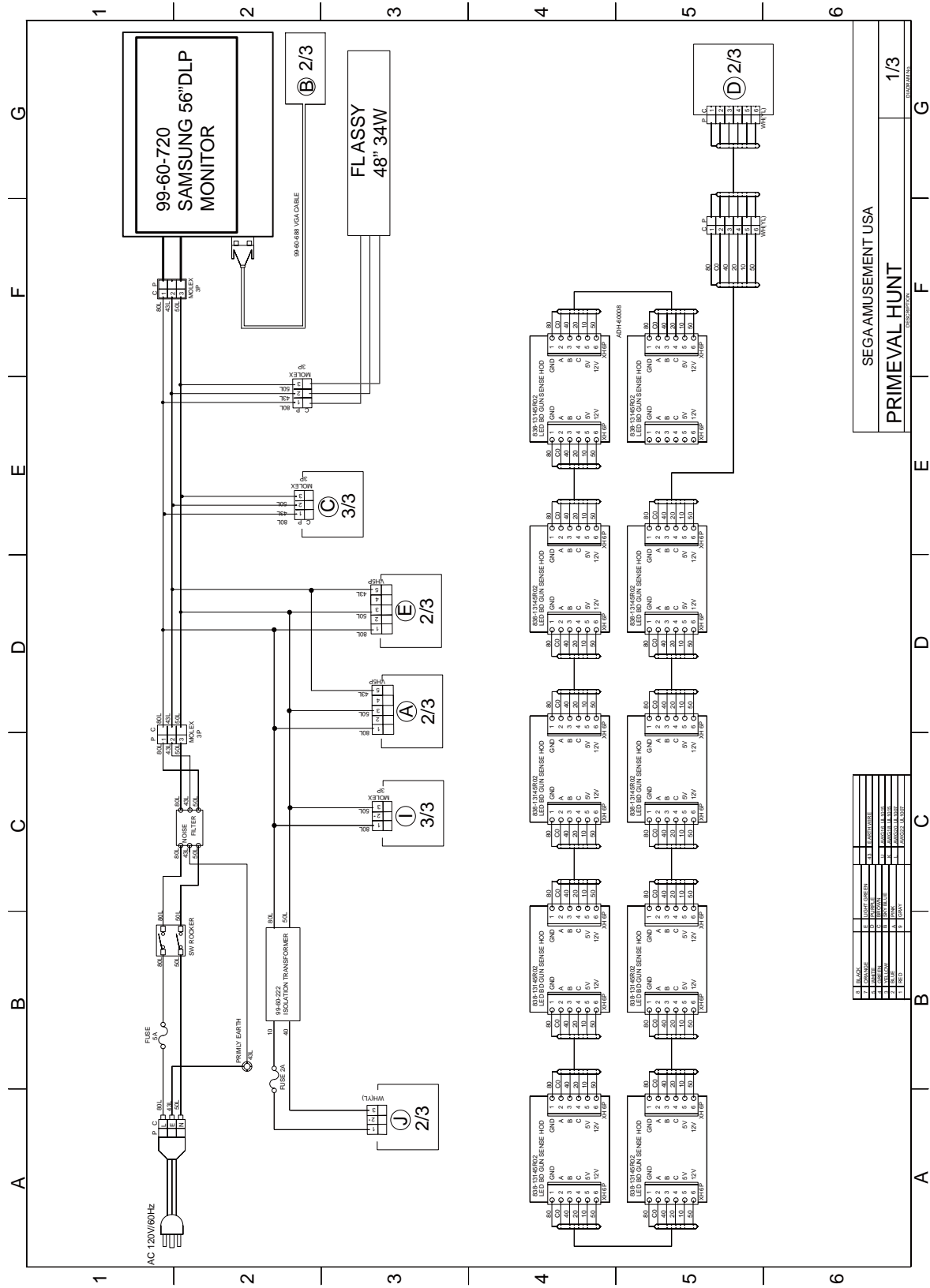

18 WIRING DIAGRAM

18 WIRING DIAGRAM

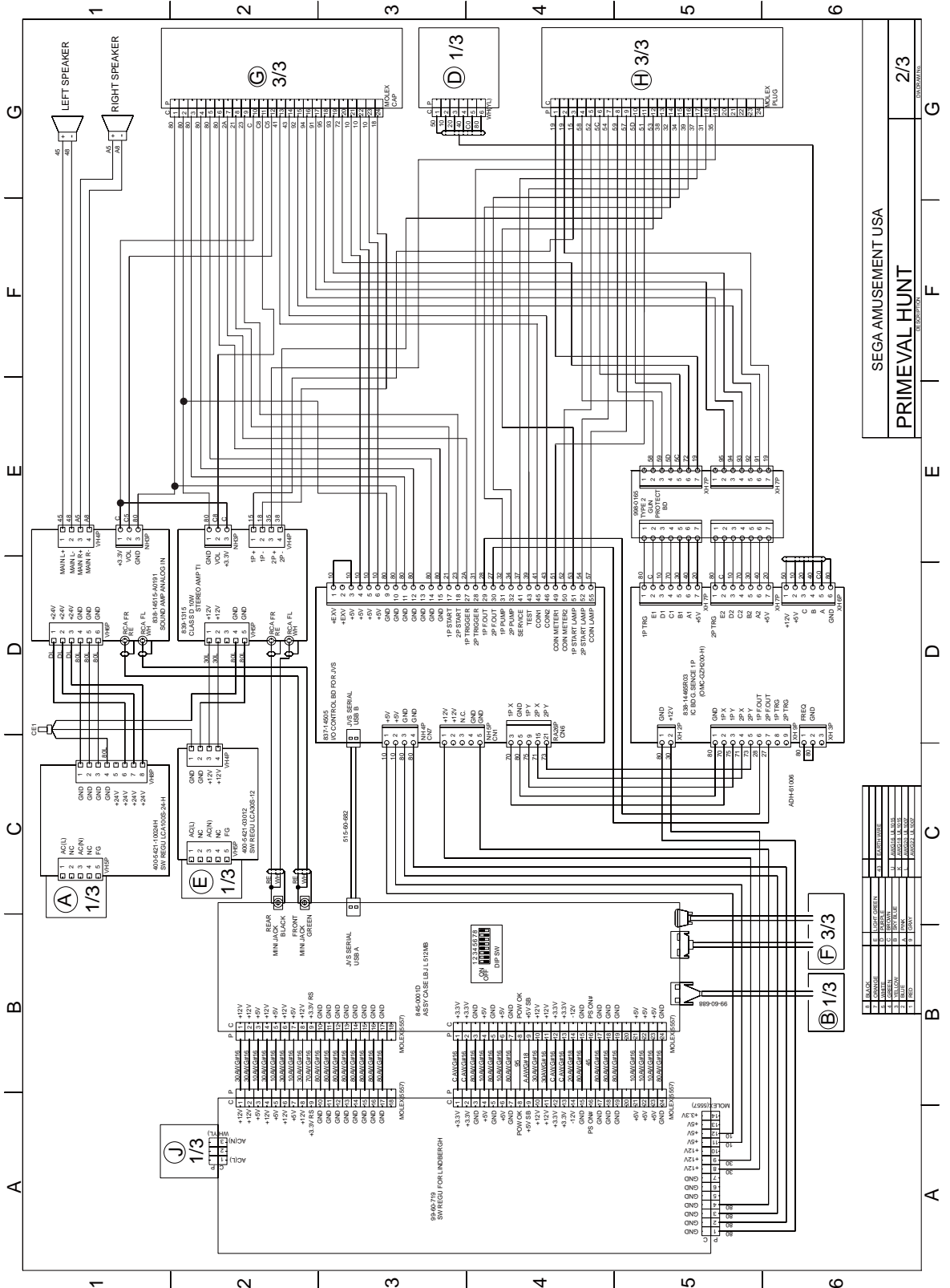

SEGA AMUSEMENT USA
PRIMEVAL HUNT

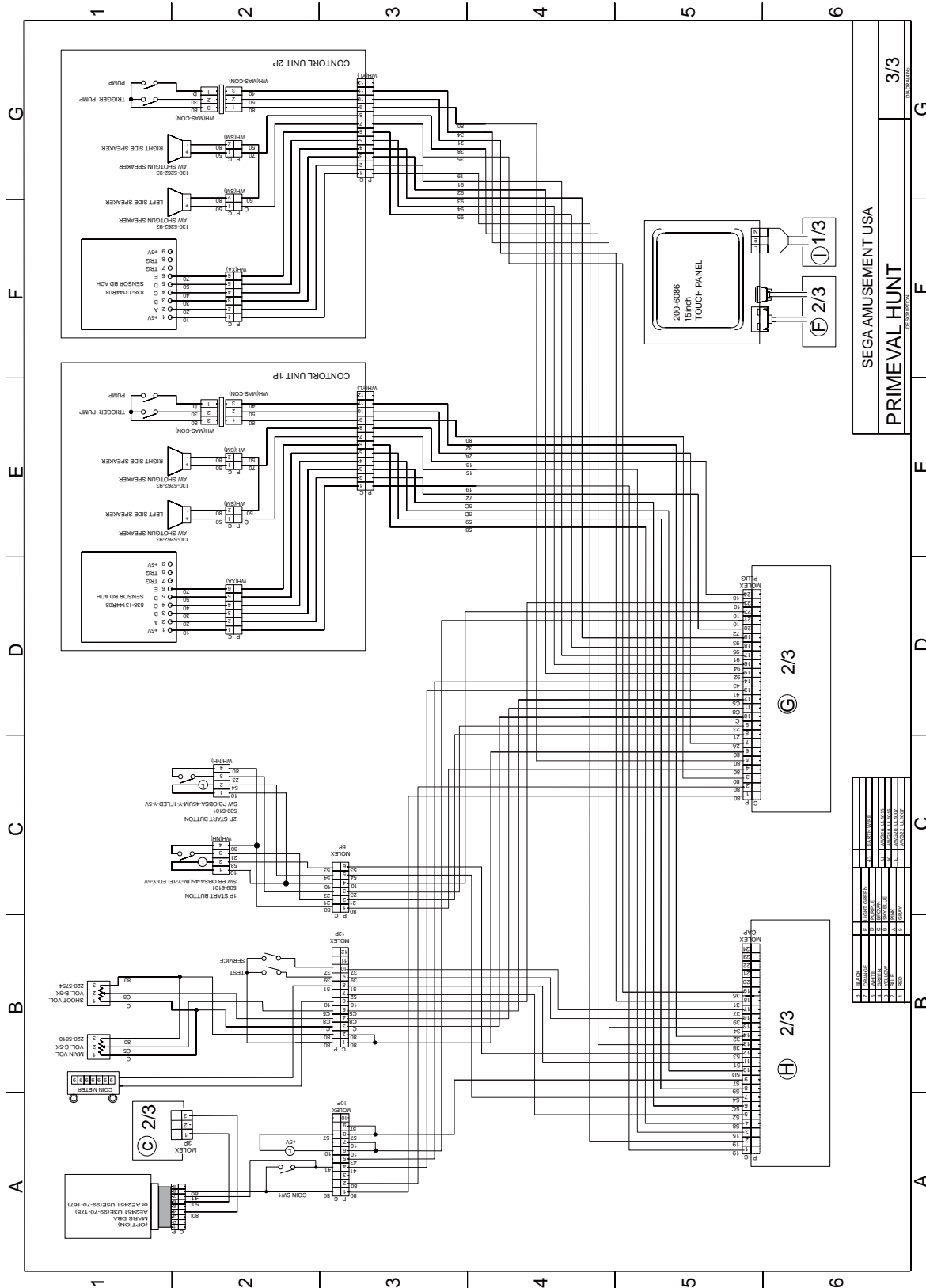

1	2	3	4	5	6
1	2	3	4	5	6
1	2	3	4	5	6
1	2	3	4	5	6
1	2	3	4	5	6
1	2	3	4	5	6

SEGA AMUSEMENT USA
PRIMEVAL HUNT

18 WIRING DIAGRAM

543-30-300
1ST PRINTING FEB. 2008



SEGA AMUSEMENTS U.S.A., INC.

800 ARTHUR AVENUE, ELK GROVE VILLAGE, IL 60007-5215
Phone: 888-877-2669 Facsimile: 847-427-1065
WEB: WWW.SAU.SEGA.COM

© SEGA

All manufacturers, cars, names, brands and associated imagery featured in this game are trademarks and/or copyrighted materials of their respective owners. All rights reserved.