

 Roland

**PR-100**

DIGITAL SEQUENCER

Owner's Guide

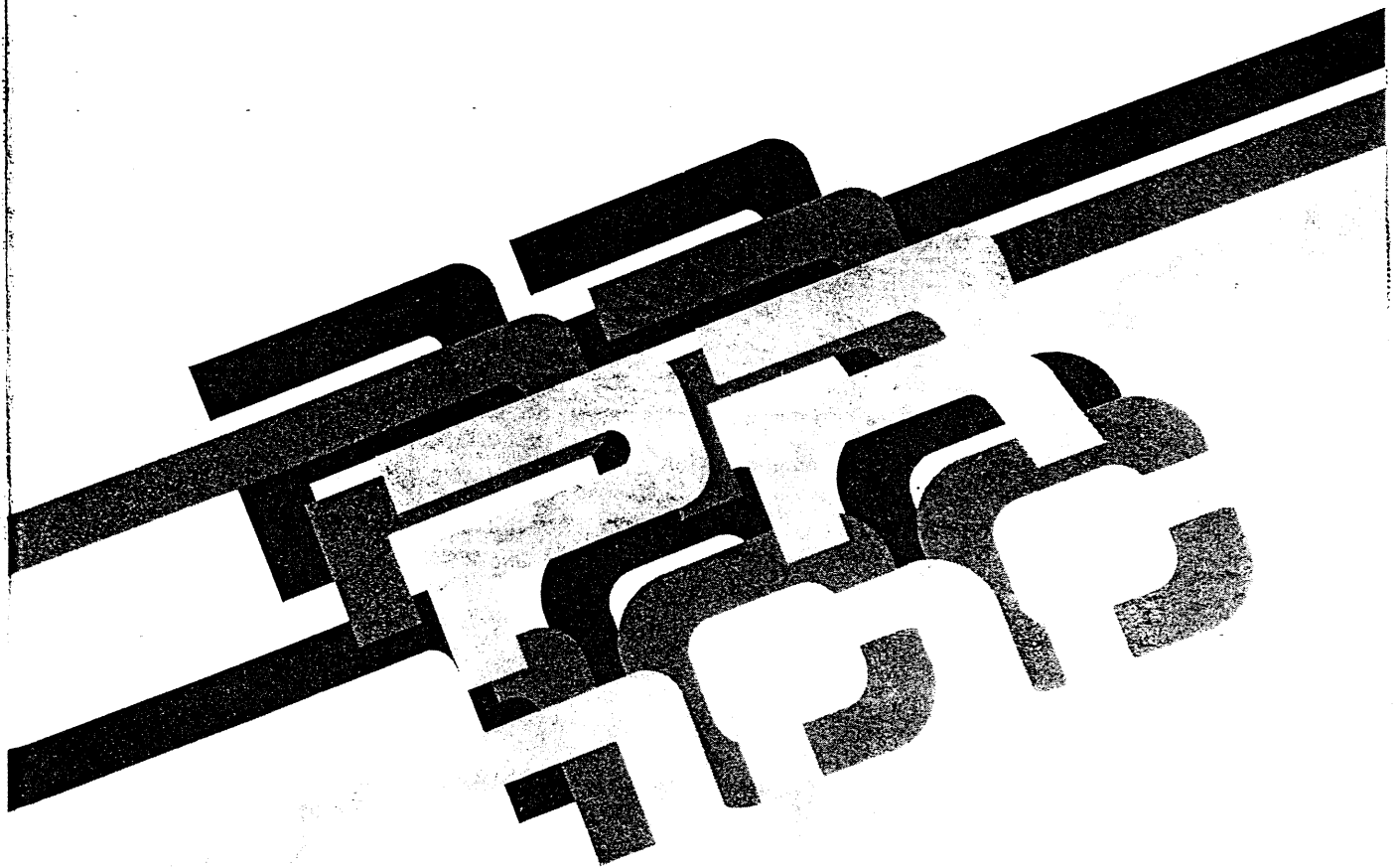

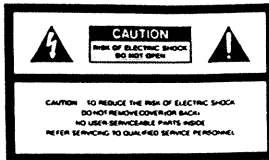

The lightning flash with arrowhead symbol, within an equilateral triangle, is intended to alert the user to the presence of un-insulated "dangerous voltage" within the product's enclosure that may be of sufficient magnitude to constitute a risk of electric shock to persons.

The exclamation point within an equilateral triangle is intended to alert the user to the presence of important operating and maintenance (servicing) instructions in the literature accompanying the product.

**INSTRUCTIONS PERTAINING TO A RISK OF FIRE, ELECTRIC SHOCK OR INJURY TO PERSONS.**

## IMPORTANT SAFETY INSTRUCTIONS

**WARNING** When using electric products, basic precautions should always be followed, including the following:

1. Read all the instructions before using the product.
2. To reduce the risk of injury, close supervision is necessary when a product is used near children.
3. Do not use this product near water- for example, near a bathtub, washbowl, kitchen sink, in a wet basement, or near a swimming pool, or the like.
4. This product should be used only with a cart or stand that is recommended by the manufacture.
5. This product, either alone or in combination with an amplifier and headphones or speakers, may be capable of producing sound levels that could cause permanent hearing loss. Do not operate for a long period of time at a high volume level or at level that is uncomfortable. If you experience any hearing loss or ringing in the ears, you should consult an audiologist.
6. The product should be located so that its location or position does not interfere with its proper ventilation.
7. The product should be located away from heat sources such as radiators, heat registers or other products that produce heat.
8. The product should avoid using in where it may be effected by dust.
9. The product should be connected to a power supply only of the type described in the operating instructions or as marked on the product.
10. The power-supply cord of the product should be unplugged from the outlet when left unused for a long time.
11. Do not tread on the power-supply cord.
12. Do not pull the cord but hold the plug when unplugging.
13. When setting up with any other instruments, the procedure should be followed in accordance with instruction manual.
14. Care should be taken so that objects do not fall and liquids are not spilled into the enclosure through openings.
15. The product should be serviced by qualified service personnel when:
  - A: The power-supply cord or the plug has been damaged; or
  - B: Objects have fallen, or liquid has been spilled into the product; or
  - C: The product has been exposed to rain; or
  - D: The product does not appear to operate normally or exhibits a marked change in performance; or
  - E: The product has been dropped, or the enclosure damaged.
16. Do not attempt to service the product beyond that described in the user-maintenance instructions. All other servicing should be referred to qualified service personnel.

## SAVE THESE INSTRUCTIONS

### WARNING

#### THIS APPARATUS MUST BE EARTH GROUNDED.

The three conductors of the mains lead attached to this apparatus are identified with color as shown in the table below, together with the matching terminal on the UK type power plug. When connecting the mains lead to a plug, be sure to connect each conductor to the correct terminal, as indicated. "This instruction applies to the product for United Kingdom."

MAINS LEADS		PLUG
Conductor	Color	Mark on the matching terminal
Live	Brown	Red or letter L
Neutral	Blue	Black or letter N
Grounding	Green-Yellow	Green, Green-Yellow, letter E or symbol

### RADIO AND TELEVISION INTERFERENCE

"Warning - This equipment has been verified to comply with the limits for a Class B computing device, pursuant to Subpart J, of Part 15, of FCC Rules. Operation with non-certified or non-verified equipment is likely to result in interference to radio and TV reception."

The equipment described in this manual generates and uses radio-frequency energy. If it is not installed and used properly, that is, in strict accordance with our instructions, it may cause interference with radio and television reception.

This equipment has been tested and found to comply with the limits for a Class B computing device in accordance with the specifications in Subpart J, of Part 15, of FCC Rules. These rules are designed to provide reasonable protection against such an interference in a residential installation.

However, there is no guarantee that the interference will not occur in a particular installation. If this equipment does cause interference to radio or television reception, which can be determined by turning the equipment on and off, the user is encouraged to try to correct the interference by the following measure:

- Disconnect other devices and their input/output cables one at a time. If the interference stops, it is caused by either the other device or its I/O cable.

These devices usually require Roland designated shielded I/O cables. For Roland devices, you can obtain the proper shielded cable from your dealer. For non-Roland devices, contact the manufacturer or dealer for assistance.

If your equipment does cause interference to radio or television reception, you can try to correct the interference by using one or more of the following measures:

- Turn the TV or radio antenna until the interference stops.
- Move the equipment to one side or the other of the TV or radio.
- Move the equipment farther away from the TV or radio.
- Plug the equipment into an outlet that is on a different circuit than the TV or radio. (That is, make certain the equipment and the radio or television set are on circuits controlled by different circuit breakers or fuses.)
- Consider installing a rooftop television antenna with coaxial cable lead-in between the antenna and TV.

If necessary, you should consult your dealer or an experienced radio/television technician for additional suggestions. You may find helpful the following booklet prepared by the Federal Communications Commission:

"How to Identify and Resolve Radio-TV Interference Problems"

This booklet is available from the U.S. Government Printing Office, Washington, DC., 20402, Stock No. 004-000-00345-4.

### Bescheinigung des Herstellers /Importeurs

Hiermit wird bescheinigt, daß der/die/das

**ROLAND DIGITAL SEQUENCER PR-100**

(Gerät Typ Bezeichnung)

in Übereinstimmung mit den Bestimmungen der

Amtsbl. Vfg 1046 / 1984

(Amtsblattverfügung)

funk-entstört ist

Der Deutschen Bundespost wurde das Inverkehrbringen dieses Gerätes angezeigt und die Berechtigung zur Überprüfung der Serie auf Einhaltung der Bestimmungen eingeräumt

Roland Corporation Osaka / Japan

Name des Herstellers/Importeurs

Please read the separate volume "MIDI", before reading this owner's manual.

Copyright © 1987 by ROLAND CORPORATION

All rights reserved. No part of this publication may be reproduced in any form without the written permission of ROLAND CORPORATION.

## FEATURES

The Roland PR-100 is a high quality real time digital sequencer, which will record and playback MIDI performance information. With the PR-100, the following functions are possible.

- Large amounts of MIDI information can be quickly and accurately recorded.
- The memory capacity of the PR-100 is 17,000 notes of music data.
- Up to two tracks can be used to record polyphonic MIDI information, Program Change messages, Pitch Bend messages, etc. A further two tracks can be recorded on by using advanced functions. The PR-100 has REC, PLAY, STOP, BWD (<<) and FWD (>>) buttons which function just like those found on a cassette player/recorder.
- Recording is carried out in Real Time.
- You can Punch-In and overdub on the existing music data while it is being played back.
- The data recorded on two individual tracks can be merged into one of the tracks.
- Any number of bars can be delete  
When playing back the recorded data, you can mute any track, adjust the tempo, even Transpose.
- The music data recorded on the PR-100 can be saved and loaded onto 2.8 inch QD's (Quick disks) with the convenient built-in Disk Drive.
- The Alpha-DIAL serves for quick operation. By rotating the Alpha-DIAL clockwise or counterclockwise, you can change functions, change parameters, enter values and perform a variety of other functions.
- The PR-100 is provided with a display (LCD) which is used to display information and help in operating.
- The PR-100 can synchronize to other MIDI instruments.

# Panel Description

## 1. Front Panel

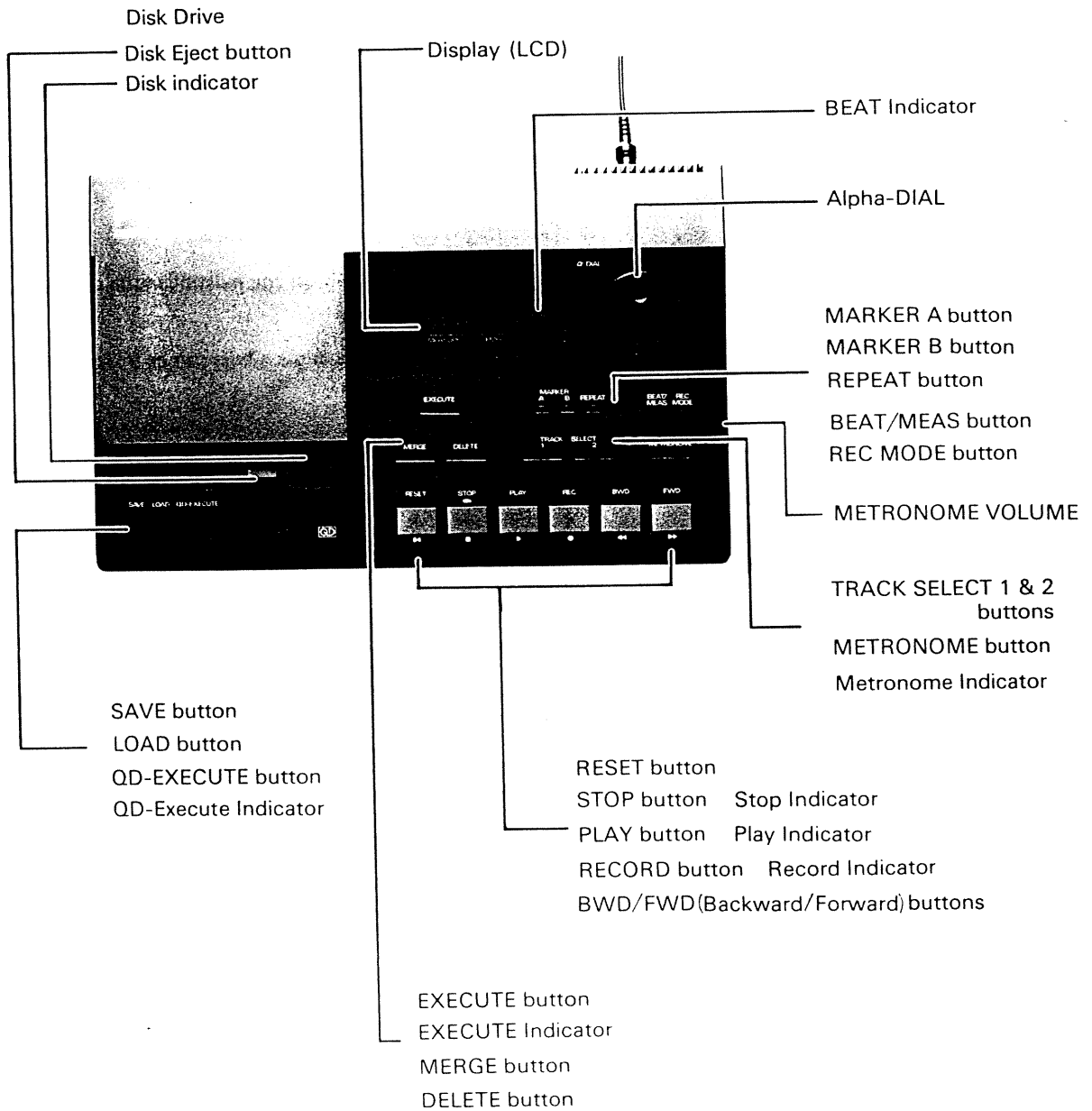

## 2. Rear Panel

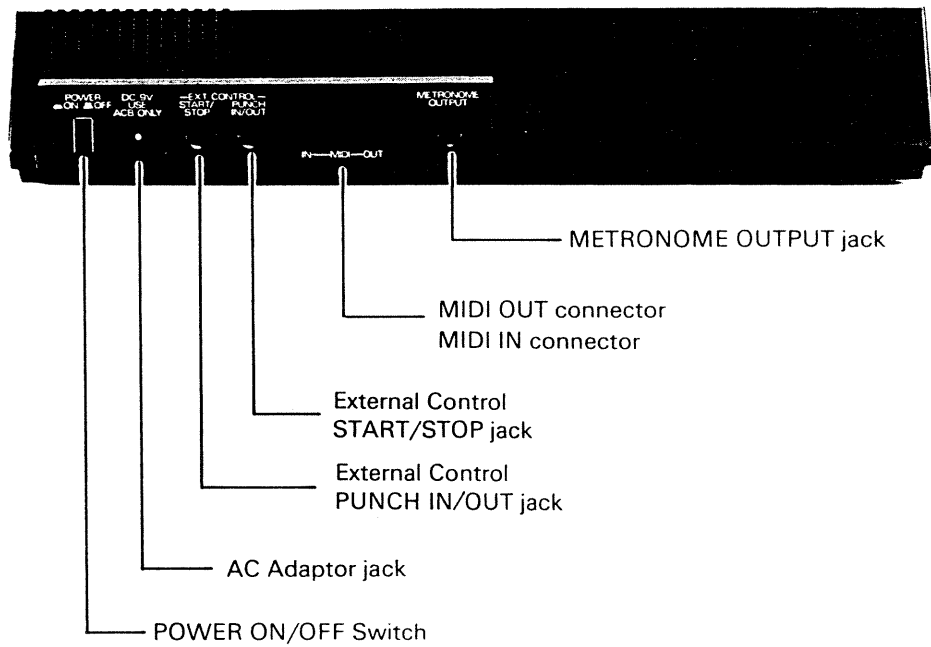

# CONTENTS

THE CARE OF YOUR PR-100 . . . . .	6
CONNECTIONS . . . . .	8
Connecting up with a Keyboard . . . . .	8
Connecting up with a module . . . . .	9
QUICK DISK (QD) . . . . .	10
Quick Disk Care . . . . .	12
GETTING STARTED . . . . .	14

## HOW TO USE PR-100 FEATURES - PART 1

RECORDING . . . . .	16
Key-on-Start . . . . .	16
Manual Start with Count-In . . . . .	17
FOOT SWITCH Start . . . . .	18

OVERDUBBING . . . . .	19
METRONOME . . . . .	20
BEAT Indicator . . . . .	20
BEAT/MEASURE . . . . .	21

PLAYBACK . . . . .	22
Forward/Backward (FWD/BWD) . . . . .	22
Tempo change . . . . .	23
Track Mute . . . . .	23
MARKERS A & B . . . . .	24
- Set . . . . .	24
- Jump . . . . .	24
- Cancel . . . . .	24
- REPEAT . . . . .	25

OPTIONAL MODES . . . . .	26
Transpose . . . . .	26
Restore original Tempo . . . . .	27
Sub Tracks . . . . .	27
Mute Sub Tracks . . . . .	28
Auto metronome count-in . . . . .	28
Start/Stop Playback with FOOT SWITCH . . . . .	29

## HOW TO USE PR-100 FEATURES - PART 2

EDIT .....	30
Delete .....	30
Merge (combine) .....	30
PUNCH-IN/OUT RECORDING .....	31
- using MARKER A & B .....	32
- using Foot Switch .....	33
Recording from the middle or end of a song .....	35
Recording Non-Note Information .....	35
QUICK DISK (QD) .....	36
Quick Disk Care .....	36
Quick Disk (QD) - Load .....	36
Quick Disk (QD) - Save .....	37
Playback Pre-recorded QD's .....	37
MIDI CONFIGURATION MEMORY .....	38
Summary MIDI parameters/values .....	39
Changing Parameters .....	42
Changing Values .....	44
ERROR MESSAGES .....	45
Explanation of Error Messages .....	45
ADVANCED OPTIONAL MODES .....	46
All Clear .....	46
Memory Consumption .....	46
PAUSE MARK .....	47
PAUSE MARK Set .....	47
PAUSE MARK Delete .....	47
Jump PAUSE MARK .....	47
QD - OPTIONAL MODES .....	48
QD-Model check .....	48
QD-Verify .....	48
Exchange Tracks and SAVE .....	49
OPTIONAL ACCESSORIES .....	50

To ensure the best use and full enjoyment of your PR-100, please read this guide carefully and thoroughly.

## THE CARE OF YOUR PR-100

### ROOM LOCATION

Avoid using this unit in excessive heat or humidity conditions or where it may be affected by direct sunlight or dust and avoid places subject to high vibrations.

### CABINET CARE

Use a soft dry cloth for dusting. To remove fingerprints or dulling film, use a soft cloth slightly dampened with water and a little mild detergent. Immediately wipe dry with a soft cloth. Do not use solvents such as paint thinners.

### CHECK LIST

#### IF YOUR PR-100 FAILS TO OPERATE:

Make sure that the AC adaptor is firmly plugged into the jack at the rear and that the AC adaptor is not faulty. Also check that the AC wall outlet is not faulty. Plug in a lamp or radio to test the wall outlet.

Be sure the ON/OFF switch is ON.

Make sure that the PR-100 has been correctly connected through MIDI to other MIDI devices.

In the event the instrument is still inoperable, your Roland technician or dealer is best qualified to provide you with competent service. Do not attempt any adjustments or repairs by yourself.

When the display responds with a different indication from any explained in this manual, refer to "ERROR MESSAGES" in PART 2.



## PRECAUTIONS

The appropriate power supply for the AC adaptor unit is shown on its name plate. Please make sure that the line voltage in your country meets the requirement.

Use only the AC adaptor provided.

Please do not use the same socket used for any noise generating device (such as a motor, variable lighting system).

Disconnect the AC adaptor immediately in the event of an electrical storm.

Before setting up this unit with other MIDI devices, turn this unit off along with all other units.

Be sure to connect the MIDI cable securely. If the MIDI cable is disconnected while the PR-100 is being played, various troubles will occur (e.g. the sound would not stop).

Static electricity may cause the build-in computer to malfunction. Should this occur, simply reset the computer by turning the power switch off and then after a few seconds, back on.

This unit might not operate correctly if turned on immediately after being turned off. If this happens, simply turn it off and after a few seconds later, turn it on again.

Operating this unit near a neon, Fluorescent lamp, TV or CRT Display, may cause noise interference. If so, change the angle or the position of the unit.

This unit could get heated while operating, but there is no need to be concerned.

The built-in Disk Drive of the PR-100 is a precision machine. So, please handle it carefully.

To avoid risk of electric shock, do not perform any servicing. Refer all servicing to qualified service personnel.

# CONNECTIONS

## 1. Connecting up with a Keyboard

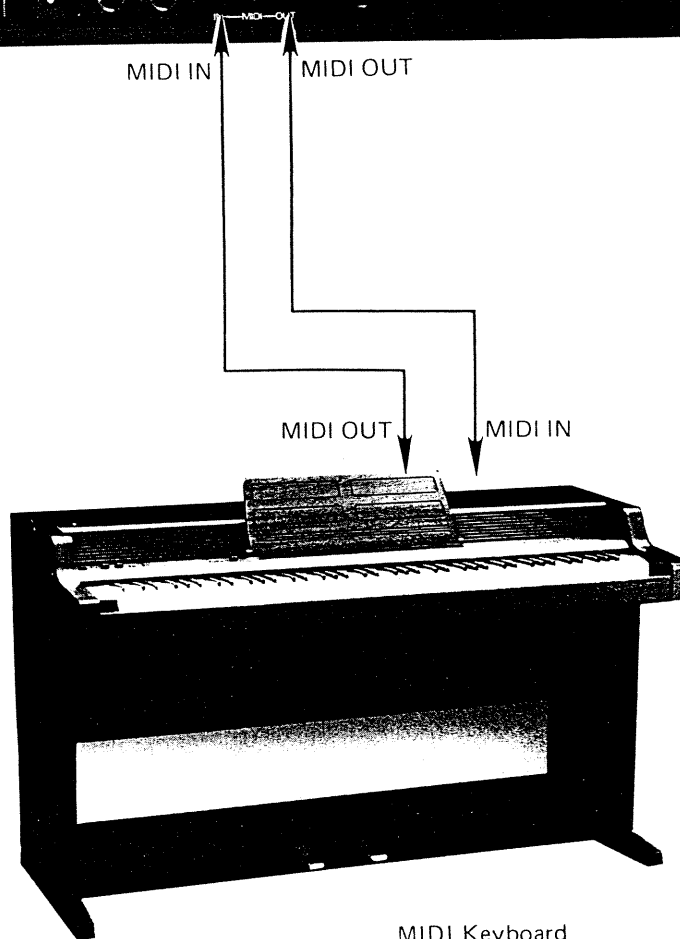
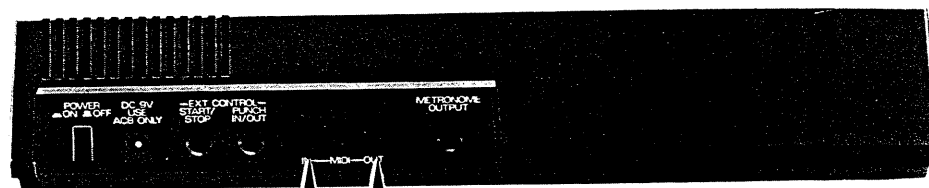

MIDI Keyboard  
e.g. HP-2000/3000(S)/4500(S)/5500(S)/5600(S)  
HS-10  
HS-80  
HP-100/600/700/800

\*Before connecting the PR-100 to the keyboard, turn both units off.

## 2. Connecting up with MIDI Keyboard and Sound Module

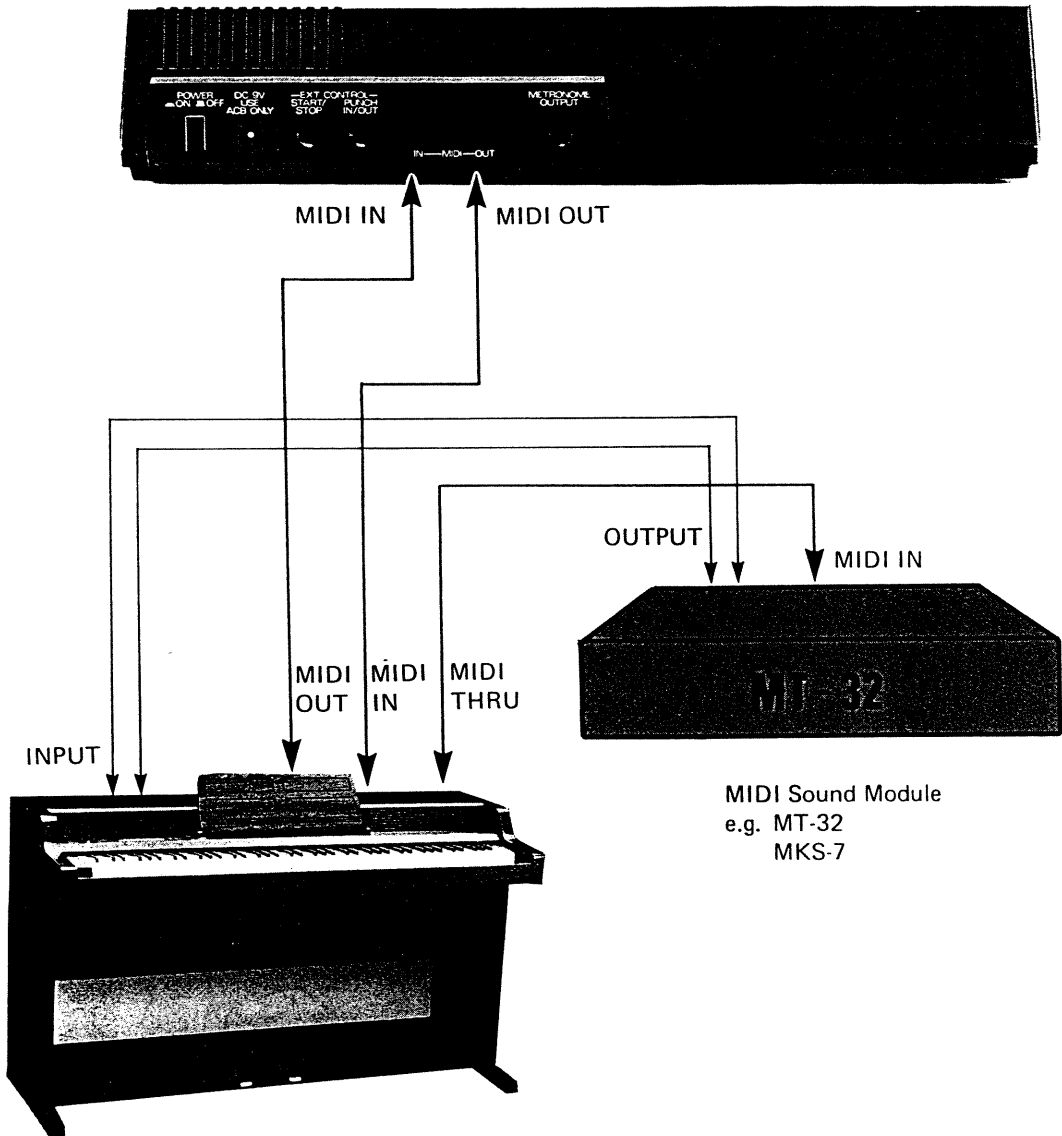

MIDI Keyboard  
e.g. HP-2000/3000(S)/4500(S)/5500(S)/5600(S)  
HS-10  
HS-80  
HP-100/600/700/800

MIDI Sound Module  
e.g. MT-32  
MKS-7

## QUICK DISK (QD)

After recording your performance on the PR-100, the data can be stored onto a 2.8 inch Quick Disks (QD's) using the built-in Disk Drive. The memory capacity of a QD is approx. 8,500 notes on each side.

Quick disks are delicate and can be damaged if not handled properly. Disks could also become erased naturally after a certain length of time. To ensure a long life for your data disks, be sure to follow the instructions.

### Instructions on handling Quick Disks

Do not touch the magnetic disk

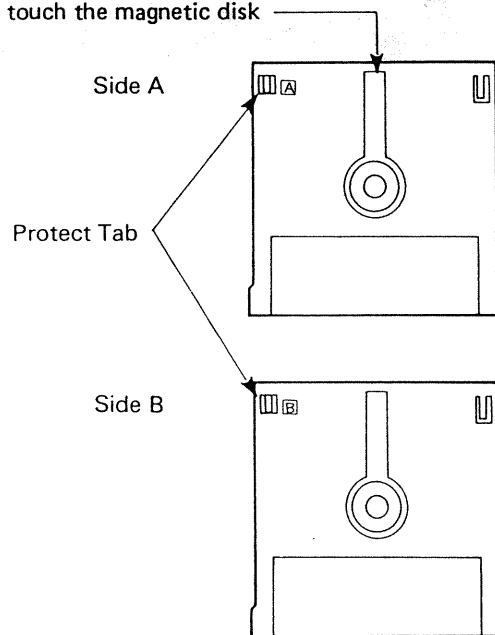

\* To prevent accidental loss of data after saving onto the QD, be sure to break off the plastic tab next to the indicated side (A or B). To rewrite data on a protected QD, place adhesive tape over the slot next to the indicated side (A or B) as shown below.

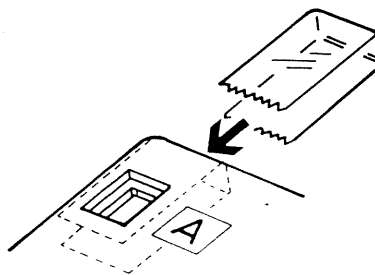

### Quick Disk Care

Do not touch the magnetic disk.

Do not use the disk where it may be affected by dust.

Do not use the disk near anything magnetic such as headphones or speakers.

Keep disks away from extremely hot and cold temperatures.

To avoid accidental loss of data, be sure to remove the plastic tab on the disk.

Never remove or insert the disk, or switch the PR-100 OFF or ON while the indicator of the disk drive is lit, or the disk may become erased.

The PR-100's internal memory cannot read the data recorded on a damaged disk, so we recommend that you should make copies of your important data.

One blank 2.8 inch Quick disk (QD) has been supplied with the PR-100 to store your performance on. You may purchase additional QD's from your local Roland dealer, or obtain a high-quality Quick Disk as an alternative.

The following pages of easy-to-follow instructions will help you to get started on the PR-100.

### A HANDLING PROCEDURE FOR QD

When you want to remove the QD, please push the Eject Button.

If you try to take out the QD without pushing the Eject Button, the pad applied to the disk drive will be damaged, causing breakdown.

If the QD does not come out, push the Eject Button again.

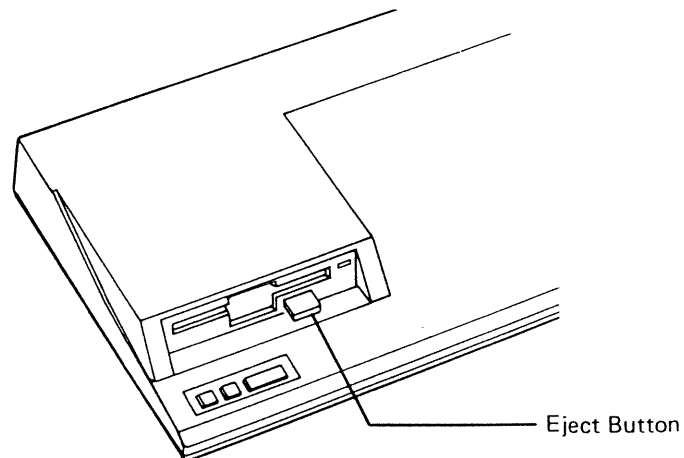

# GETTING STARTED

1. Make sure you have followed the "Connecting up with a keyboard" procedure on (Page 5).
2. Turn on MIDI keyboard.
3. Power on PR-100.  
Press the POWER switch on the rear panel ON  
The display will read "PR-100" as the instrument readies itself for operation. In just two seconds the display will change to "1 120", letting you know that the PR-100 is ready for you to use.

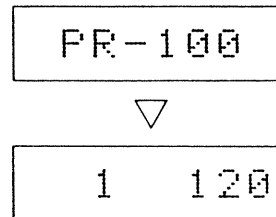
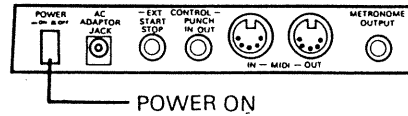

4. Press REC button. LED of REC button will light and LED's of TRACK SELECT 1 and 2 will begin to flash.
5. As you are going to record the right hand to the following music first, press TRACK SELECT 2 button. LED of TRACK SELECT 2 button will stay lit and LED of PLAY button will begin to flash.

Automatically the PR-100 will start recording by pressing a key on your MIDI keyboard.

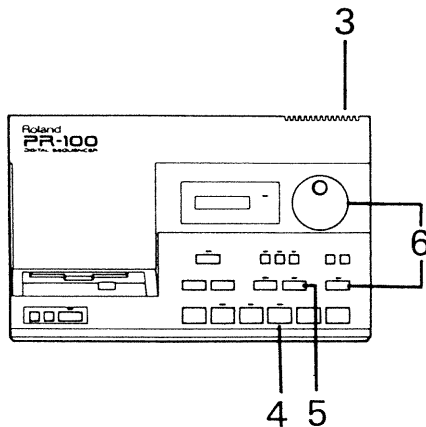

6. To help you to keep perfect time during recording, the PR-100 is equipped with a built-in Metronome. Press METRONOME button, LED will light. To record FANTASIE-IMPROMPTU at the correct tempo, simply rotate the Alpha-DIAL counter-clockwise until the display reads "1 100".

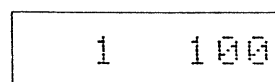
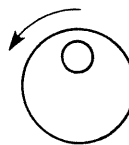

(Make sure the volume of the Metronome is turned up fully. Rotate the METRONOME VOLUME control on the right side of the PR-100 fully clockwise.)

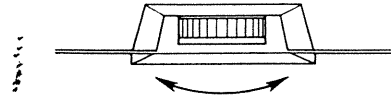

7. Play the right-hand melody alone. Simply match the melody notes to the corresponding keys. Count as you play.

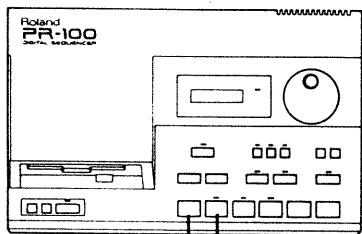

8. Press STOP button. TRACK SELECT 2 LED will stay lit verifying that there is music data recorded there.
9. Press RESET button. Display will revert back to read "1 100".

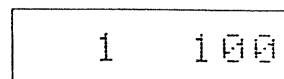

### NOW, ADD THE ACCOMPANIMENT...

Now you are going to record the left-hand to accompany the right-hand melody you have just recorded.

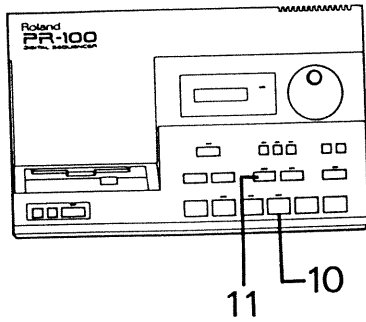

10. Press REC button, LED will light and TRACK SELECT 1 & 2 will begin to flash. (Track 1 red, Track 2 red & green.)

11. Press TRACK SELECT 1. Red LED will stay lit and LED of PLAY will begin to flash.

12. Play the left-hand accompaniment according to the indicated notes.  
(While recording the accompaniment you will automatically hear your recorded melody playing back.)

Five systems of musical notation for the left hand in 4/4 time. The first system includes a treble clef staff with notes G4, A4, B4, C5, D5, E5, G5 and a bass clef staff with notes G3, F3, E3, D3, C3, B2, A2, G2. An arrow points to the first measure of the bass staff. The second system has a treble staff with notes D5, E5, F5, G5, A5, B5, C6 and a bass staff with notes G3, F3, E3, D3, C3, B2, A2, G2. The third system has a treble staff with notes G5, A5, B5, C6, D6, E6, F6 and a bass staff with notes G3, F3, E3, D3, C3, B2, A2, G2. The fourth system has a treble staff with notes G5, A5, B5, C6, D6, E6, F6 and a bass staff with notes G3, F3, E3, D3, C3, B2, A2, G2. The fifth system has a treble staff with notes G5, A5, B5, C6, D6, E6, F6 and a bass staff with notes G3, F3, E3, D3, C3, B2, A2, G2. First and second endings are marked with '1' and '2' above the treble staff.

13. Press STOP button. TRACK SELECT 1 LED will now stay lit verifying that there is music data recorded there.



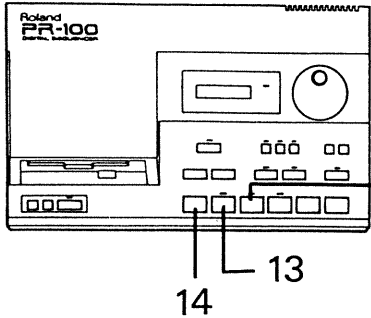

14. Press RESET button. Display will revert back to read "1 100".

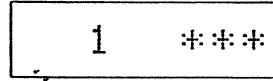

15. To replay FANTASIE-IMPROMPTU press PLAY button. (The PR-100 automatically stop at the end of the playback.)

To help you with this initial recording, the "Sample Disk" which accompanied your PR-100 contains the tune "FANTASIE-IMPROMPTU" pre-recorded for Roland Piano.

- 1) Insert Side A into the Disk Drive.
- 2) Press LOAD button. QD-EXECUTE LED will begin to flash.
- 3) Press QD-EXECUTE button to load Side A into the internal memory of the PR-100.

The left hand is recorded on Sub Track 3 and the right hand on Sub Track 4. To mute Sub Tracks 3 or 4, press Track 1 or 2 button respectively while pressing EXECUTE button. You can therefore practice with each recorded track (left or right hand) and furthermore, recorded your own left or right hand on Track 1 and 2 respectively. Your own performance can then be checked against the professionally recorded one by switching back on Sub Tracks 3 and 4. Also included on Side A of the Sample Disk are three additional examples of recorded music.

A PAUSE MARK has been inserted between each tune enabling you to quickly and easily go to the beginning of each song. (See Page 46-9. "ADVANCED OPTIONAL MODES" c to f)

- |                |   |  |
|----------------|---|--|
| Tune 1         | - | Fantaisie - Impromptu  |
| (PAUSE MARK 1) |   |  |
| Tune 2         | - | Beethoven Op 27, No 2 (Sonata in C# minor)                     |
| (PAUSE MARK 2) |   |  |
| Tune 3         | - | Jesu, Joy of Man's Desiring                                    |
|                |   | (Example for four hands -                                      |
|                |   | Track 1 - Left hand 1st Piano                                  |
|                |   | Track 2 - Right hand 1st Piano                                 |
|                |   | Sub Track 3 - Left hand 2nd Piano                              |
|                |   | Sub Track 4 - Right hand 2nd Piano                             |
| (PAUSE MARK 3) |   |  |
| Tune 4         | - | Rondo al a Turca   |
|                |   | (Try varying the tempo and transposing the key with this tune) |

Learn more about your PR-100 and the fun of making music. It's all in the following pages ... a complete tour of your new Roland PR-100 Digital Sequencer.

# HOW TO USE PR-100 FEATURES - PART 1

## 1. RECORDING

The PR-100 will record MIDI information in real time from any MIDI keyboard and will record all the nuances of your performance exactly as you play them. To find out which performance parameters your particular instrument can send and/or receive through MIDI, check the MIDI implementation chart in your instrument's Owner's Manual.

The PR-100 will record information on all sixteen MIDI channels. When you are recording, the PR-100 will record the set channel number of the MIDI keyboard you are using.

Multi-timbral instruments allow you to play more than one sound simultaneously. Instruments that are not multi-timbral can only play back one sound at one time. The PR-100 cannot perform beyond the capabilities of the instrument you are using. If your instrument is multi-timbral, you can play back different parts simultaneously on different MIDI channels.

Make sure you have followed the "Connecting up with a keyboard" procedure on (Page 8).

### a) Key-On-Start Recording: (REC MODE is set for "REAL")

- (1) Press REC MODE button. Display will indicate "REAL" or "PUNCH".

Real

Punch

If the display reads "PUNCH", rotate the Alpha-DIAL until "REAL" is displayed. Press EXECUTE button. A beep will sound and the display will revert to "1 120".

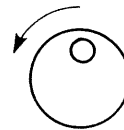

Real

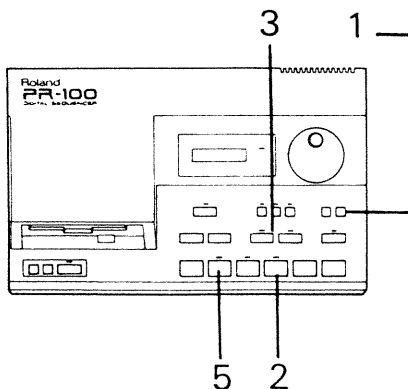

- (2) Press REC button. REC LED will light and TRACK SELECT buttons 1 & 2 will begin to flash.

- (3) Press TRACK SELECT button 1 or 2, to put PR-100 in REC 'Stand By'. TRACK SELECT LED of button pressed will stay lit and PLAY button LED will begin to flash.

(To help you to keep perfect time during recording, the PR-100 is equipped with a built-in Metronome. See METRONOME.)

- (4) Play your MIDI keyboard. The PR-100 will start recording automatically.



- (5) Press STOP button or RESET button to stop recording.

**b) Manual Start with Count-In Recording: (REC MODE is set for "REAL")**

- (1) Press REC MODE button. Display will indicate "REAL" or "PUNCH". If the display reads "PUNCH", rotate the Alpha-DIAL until "REAL" is displayed. Press EXECUTE button. A beep will sound and the display will revert to "1 120".

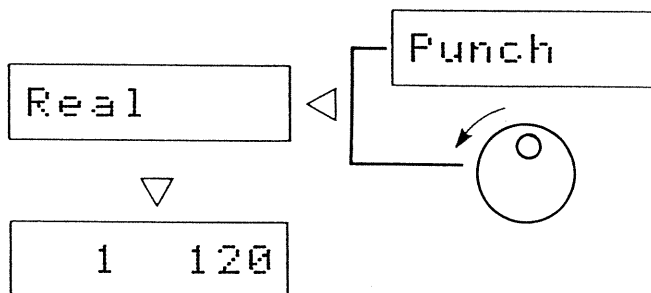

- (2) Press REC button. REC LED will light and TRACK SELECT buttons 1 & 2 will begin to flash.
- (3) Press TRACK SELECT button 1 or 2, to put PR-100 in REC 'Stand By'. TRACK SELECT LED of button pressed will stay lit and PLAY button LED will begin to flash.

(To help you to keep perfect time during recording, the PR-100 is equipped with a built-in Metronome. See METRONOME.)

- (4) Press PLAY button to start recording. Recording will automatically begin after a two-measure count-in.

- (5) Play your MIDI keyboard at the 2 measure count-in.



- (6) Press STOP button or RESET button to stop recording.

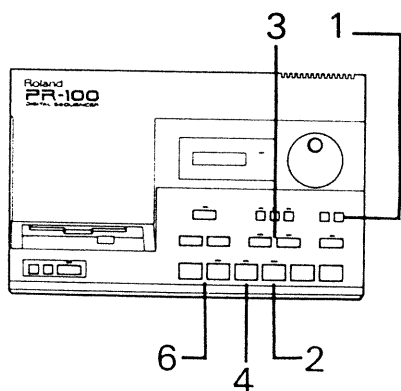

c) **FOOT SWITCH Start Recording:** (REC MODE is set for "REAL")

(Make sure the Foot Switch "DP-2" (optional) is connect to the jack on the rear of the PR-100)

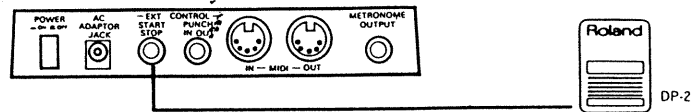

- (1) Press REC MODE button. Display will indicate "REAL" or "PUNCH". If the display reads "PUNCH", rotate the Alpha-DIAL until "REAL" is displayed. Press EXECUTE button. A beep will sound and the display will revert to "1 120".

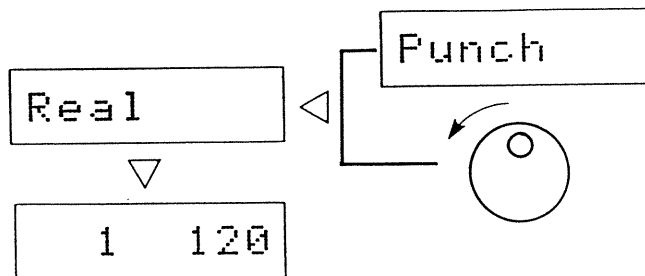

- (2) Press REC button. REC LED will light and TRACK SELECT buttons 1 & 2 will begin to flash.
- (3) Press TRACK SELECT button 1 or 2, to put PR-100 in REC 'Stand By'. TRACK SELECT LED of button pressed will stay lit and PLAY button LED will begin to flash.

(To help you to keep perfect time during recording, the PR-100 is equipped with a built-in Metronome. See METRONOME.)

- (4) Press the Foot Switch (DP-2) to start recording. Recording starts immediately.
- (5) Play your MIDI keyboard.



- (6) Press Foot Switch (DP-2), STOP button or RESET button to stop recording.

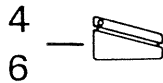
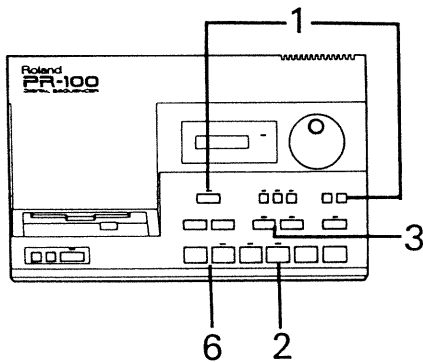

**NOTE:** If the memory becomes full during recording, the display will respond with "Full". This means that no more notes can be recorded.

## 2. OVERDUBBING

After recording on one Track, you may record data on another Track either from the beginning, middle or end of the first tracks composition. This is called "Overdubbing". The PR-100 will allow you to hear the data on the other track while you record a new part.

- (1) Position the song at the measure where you wish overdubbing to start using BWD/FWD buttons.  
(Make sure the PR-100 is in "REAL" recording mode.)

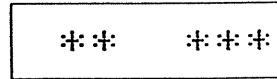

- (2) Press REC button.
- (3) Press TRACK SELECT button 1 or 2, to select the empty track for overdubbing and to put the PR-100 in REC 'Stand By'.
- (4) Press PLAY button to start recording (overdubbing).

The two previous measures will play during the count-in. If you are overdubbing from the beginning of the song, you will hear a two-measure count-in from the Metronome and the display will count down two measures " - 2" then " - 1".

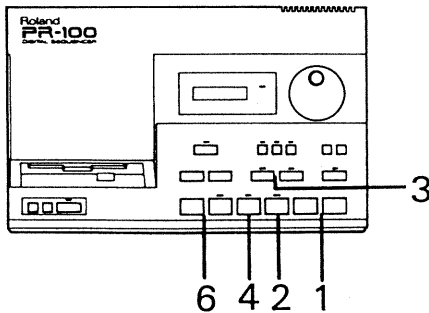
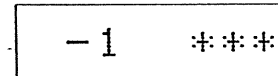
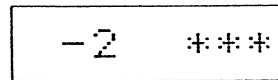

- (5) Play your MIDI keyboard after the 2 measure count-in.

Measure Count

- 2 , - 1 ▶



- (6) Press STOP button or RESET button to stop recording.

You can mute (silence) the other track if you do not want to hear it while recording simply by pushing the relevant TRACK SELECT button. (The LED will be turned off). This procedure does not erase the previously recorded data, therefore, pushing the TRACK SELECT button again will recall the sound recorded in that Track.

**NOTE:** If you do not want a count-in before recording (overdubbing). Just start to play on the MIDI keyboard. Recording will start automatically.

**NOTE:** You may overdub on a track that is not blank. However, all the information you record will replace the previous recorded data.

#### d) METRONOME

To help you to keep perfect time during recording, the PR-100 is equipped with a built-in Metronome. The down-beat of each measure is indicated by a higher pitched beep.

- (1) Press METRONOME. LED will light.  
Now when recording, a metronome sound can be heard.  
Metronome sound can also be enabled on playback.

To adjust the volume of the Metronome, rotate the METRONOME VOLUME control situated on the right side of the PR-100. (Clockwise for louder, counterclockwise for softer.)

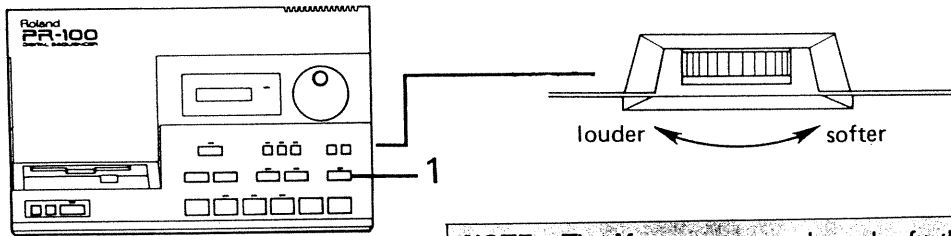

**NOTE:** The Metronome sound can be further amplified by connecting a cable from the METRONOME OUTPUT jack located on the rear of the PR-100 to an amplifier and speakers.

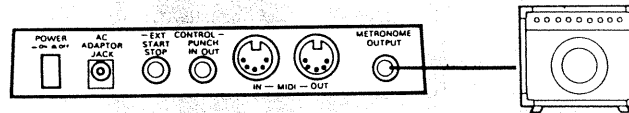

**NOTE:** The Metronome will also play during the two measure count-in on "Manual Start with Count-In Recording".

#### e) BEAT Indicator

A further aid in time-keeping is the BEAT indicator LED at the right-hand side of the display. When in 'Stand By' mode, the indicator flashes green. In Recording or Playback mode, the BEAT indicator LED will visually count out the measure or beat for you by flashing in sequence. The first beat of the measure flashes red, while the following beats flash green.

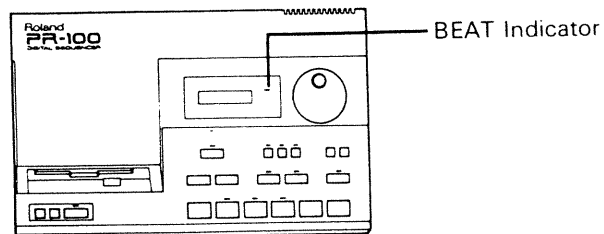

f) **BEAT/MEAS** - to set time signature for new measures to record

Upon turn-on of the PR-100, the time-signature automatically preset for recording (default value) is 4/4.

If you wish to record in another time signature:

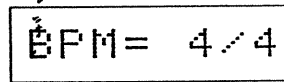

- (1) Press **BEAT/MEAS** button. The display will indicate "BPM=4/4" (default value). **EXECUTE** button LED will begin to flash. Rotate the Alpha-DIAL to change values.

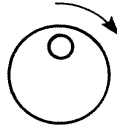

Clockwise for

5/4
6/4
7/4
8/4
1/2
2/2
3/2
4/2

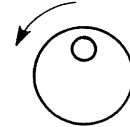

Counterclockwise for

3/4	9/8
2/4	8/8
1/4	7/8
16/8	6/8
15/8	5/8
14/8	4/8
13/8	3/8
12/8	2/8
11/8	1/8
10/8	

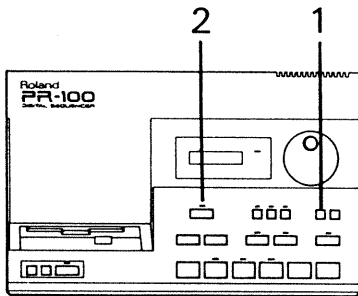

- (2) Press the **EXECUTE** button to execute the change and return the PR-100 to 'Stand By' mode.  
(The PR-100 being switched off, any changed value is cancelled.)

or

Press the **STOP** button to cancel any change of **BEAT/MEAS** and return the PR-100 to 'Stand By' mode.

For cancellation of any changed value while in the **BEAT/MEAS** mode, simply press **BEAT/MEAS** button.

**NOTE:** The time signature can be changed numerous times in any one recording.

### 3. PLAYBACK

The recorded sequencer data can be played on any MIDI instrument connected to the PR-100. Make sure you have followed the "Connecting up with a keyboard" procedure on (Page 5).

- (1) Press RESET button to return the song to Measure 1.
- (2) Press PLAY button to playback music data. The LED of the PLAY button lights and the recorded data will be played back.

(When all the data is played back, the indicator of the PLAY button is turned off and the PR-100 automatically stops.)

- (3) To stop the playback before the end of the song, press STOP button and the PR-100 will stop playing and return to the 'Stand By' mode.

(Pressing the PLAY button again will start the playback and continue from the point that it was stopped.)

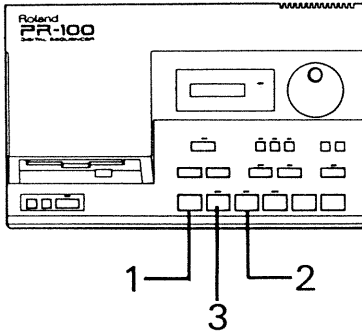

**NOTE:** If you wish to stop playing the data before the end of the song and go back to the first bar at the same time, push the RESET button instead of the STOP button. The PR-100 will immediately stop and will reset to Measure 1.

#### a) Forward/Backward (FWD/BWD)

The FWD/BWD buttons operate similar to the controls you already are familiar with on a cassette player/recorder. Pressing FWD button once will move the position of the song by one measure forward, pressing the BWD button once will move the position by one measure backward. Holding the FWD or BWD buttons down will scroll (move) the position of the song rapidly forward or backwards respectively.

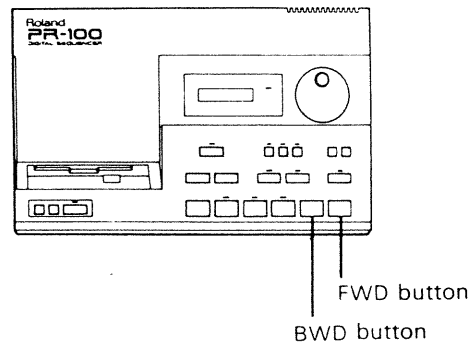



### b) Tempo Change

During playback, the tempo can be changed.

- (1) Rotate the Alpha-DIAL clockwise to quicken the tempo and counterclockwise to slow down the tempo of the playback. The display will indicate the new tempo which has been set.

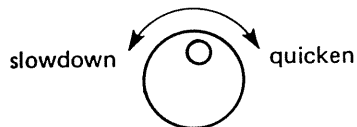
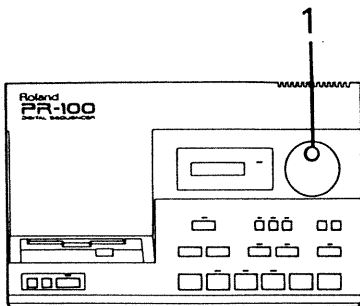

The number shown in the display indicates how many quarter notes are played within one minute.

**NOTE:** The tempo can also be changed - faster or slower while the PR-100 is stopped ('Stand By' mode).

### c) Track Mute

TRACK 1 or TRACK 2 can be muted (silenced) during playback.

- (1) Press TRACK SELECT button 1 or 2. The LED of the muted track will be turned off.

To hear a track which has been muted, simply press the same TRACK SELECT button again. LED will light and the track will be heard.

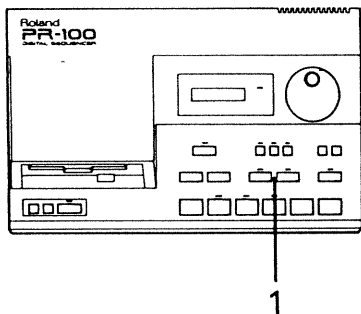

**NOTE:** Track muting can also be carried out while the PR-100 is stopped ('Stand By' mode).

**NOTE:** If the LED is not lit of TRACK 1 or 2 before muting, this means that there is no data recorded in that track.

**NOTE:** Any data you have recorded or any pre-recorded data in Sub-Tracks 3 & 4 can also be muted. See "Mute Sub Tracks".

#### d) MARKERS A & B

Two 'Markers' can be inserted anywhere during the song. These markers can be used to:

- instantly search for a particular point in the song, backward or forward.
- manually repeat the playback from a particular measure.
- manually jump from one measure to another anywhere during the song.

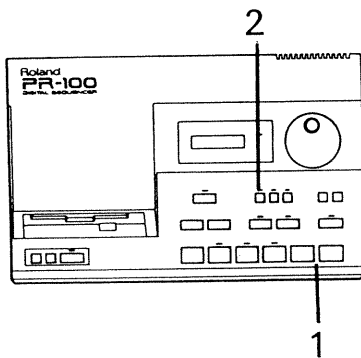

#### e) Set MARKER A & B

MARKERS A & B can be inserted at the beginning of a measure or anywhere in between.

To set MARKER A at the beginning of measure:

- (1) Go to the desired measure by FWD/BWD buttons. Display will indicate measure number.
- (2) Press MARKER A button. LED of MARKER A will light, and MARKER A is now set.

Repeat operation 1 & 2 to set a second Marker (MARKER B).

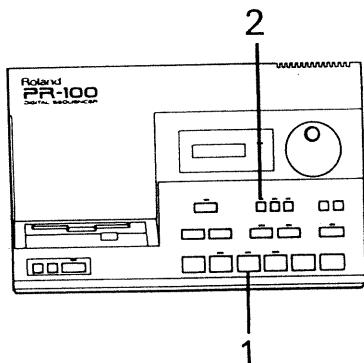

To set MARKER A at any point during a measure:

- (1) Press PLAY. Playback of the song will occur.
- (2) While the song is being played back, press MARKER A button at the precise point in the song you wish the marker to be. LED of MARKER A will light and MARKER A is now set.

Repeat operation 1 & 2 to set a second marker (MARKER B).

**NOTE:** Both MARKER A and MARKER B can be set in the same song, however MARKER B cannot be set before the position in the song of MARKER A.

#### f) Jump to MARKER

To jump to MARKER either A or B:

- (1) Press the lit MARKER button A or B. The PR-100 will immediately respond and jump to the desired position (MARKER A or B). This can be achieved if you are before or after that mark.

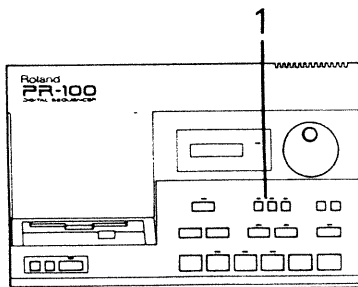

**NOTE:** Jumping to MARKER A or B can be carried out while stopped ('Stand By' mode) or while playback is in progress.

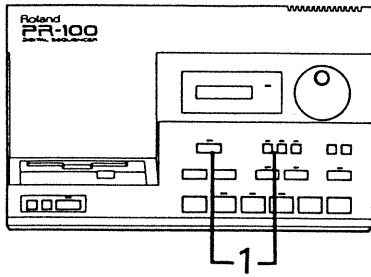

### g) Cancel MARKER A & B

To cancel a set MARKER A or B,

- (1) Press MARKER button A or B while pressing EXECUTE button. LED of the pressed button will be turned off and the Marker will be cancelled.

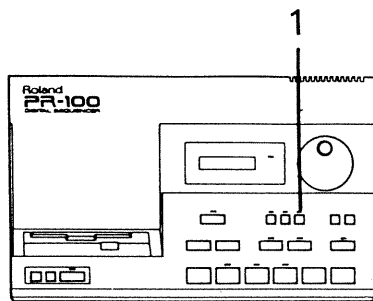

### h) Repeat MARKER A & B

Any section of the recording can be repeated automatically on playback.

- (1) Press REPEAT button. LED will light. On playback, the song will automatically repeat:

- a) from the beginning of the song  
- if no markers are set

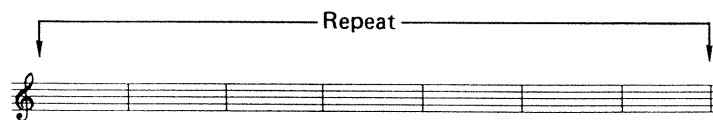

- b) from MARKER A to the end  
- if MARKER A is set

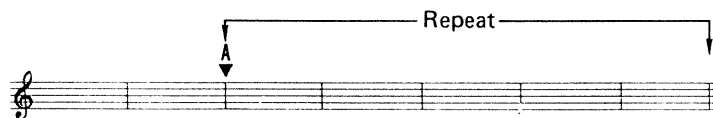

- c) from the beginning to MARKER B  
- if MARKER B is set

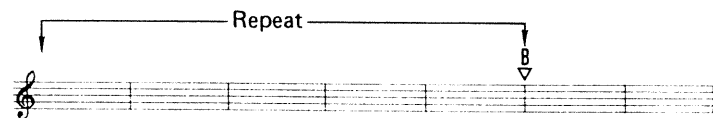

- d) from MARKER A to MARKER B  
- if MARKER A & B are set.

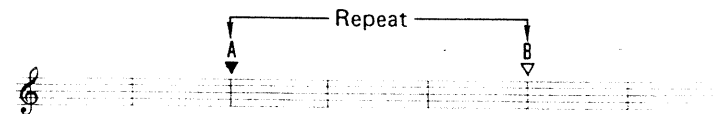

To cancel the REPEAT function, press REPEAT button, LED will be turned off.

## 4. OPTIONAL MODES

### a) Transpose - playback key

The Transpose function shifts the pitch (note) up or down by half-steps. The Transposition range on the PR-100 is two octaves up or down. Transposition can be applied to all the data or each individual track (Tracks 1, 2 and Sub-Tracks 3 & 4).

This function is available while being both played and stopped.

To transpose all data (Tracks 1, 2, 3 & 4) simultaneously.

- (1) Press BEAT/MEAS button while keeping EXECUTE button pressed. EXECUTE LED begins to flash and the display indicates:

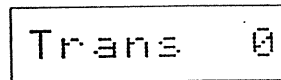

- (2) Rotate the Alpha-DIAL to change values. Rotate clockwise to transpose up, and counterclockwise to transpose down.

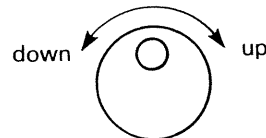

(Music data can be transposed up or down 24 steps.)

- (3) Press EXECUTE button to write the changed data in the PR-100.

Press STOP button to cancel the changed data and return the PR-100 to 'Stand By' mode.

To cancel any changed value while in the Transpose mode, press BEAT/MEAS button again.

To transpose any track individually.

- (1) Press BEAT/MEAS button while keeping EXECUTE button pressed. EXECUTE LED begins to flash and the display indicates:

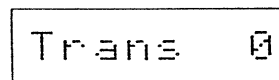

- (2) Press FWD button. The display will indicate:

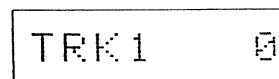

(Press BWD button to return to (1).)

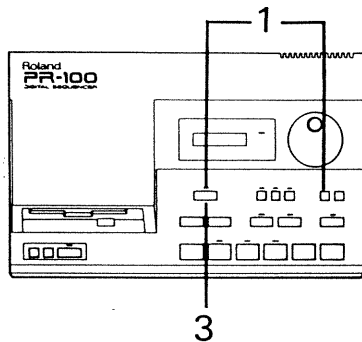

- (3) Rotate the Alpha-DIAL to change values. Rotate clockwise to transpose up, and counterclockwise to transpose down.

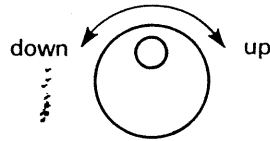

**NOTE:** Pressing FWD button once more will increase Track number. When no music exists on a track, the track number does not appear and the display will indicate the next track which has data recorded there.

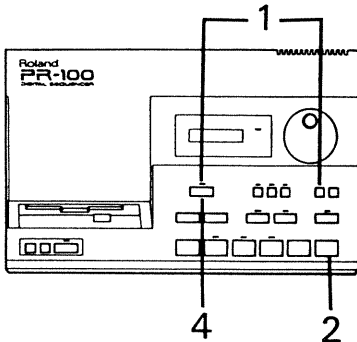

- (4) Press EXECUTE button to write the changed data in the PR-100.

- or -

Press STOP button to cancel the changed data and return the PR-100 to 'Stand By' mode.

To cancel any changed value while in the Transpose mode, press BEAT/MEAS button again.

**NOTE:** Any data that has been transposed can be saved onto QD's in that mode.

**b) Restore original Tempo**

If the tempo has been changed on playback of any data, the original tempo can be easily restored. This function is available while being both played and stopped.

- (1) Hold EXECUTE button down and rotate Alpha-DIAL either way. (TEMPO is restored to original tempo.)

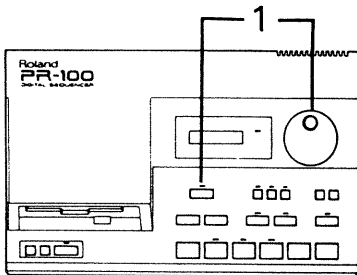
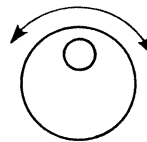

**c) Sub Tracks - Tracks 3 & 4**

Sub Tracks 3 & 4 are mainly used to store pre-recorded music data included on PR-100 pre-recorded Quick Disks. See "Pre-recorded QD's". However, Tracks 3 & 4 can be used for customer recording with all the same functions as Track 1 & 2. See "Exchange Tracks and SAVE".

#### d) Mute Sub Tracks

Sub Tracks 3 & 4 and Rhythm track can be muted (silenced) during playback.

To mute Sub Track 3 or 4:

- (1) Press EXECUTE button. If data has been recorded on Tracks 3 & 4, the LEDs will light. (The buttons and LEDs of TRACK 1 & 2 become momentarily functionable for Tracks 3 & 4 respectively. Releasing the EXECUTE button returns the functioning of these to Tracks 1 & 2.)
- (2) To mute Track 3, press TRACK SELECT 1 button while keeping EXECUTE button pressed. LED will be turned off. To mute Track 4, press TRACK SELECT 2 button while keeping EXECUTE button pressed.
- (3) To mute the Rhythm track (this only applies to Roland pre-recorded disk), press METRONOME button while keeping EXECUTE button pressed.

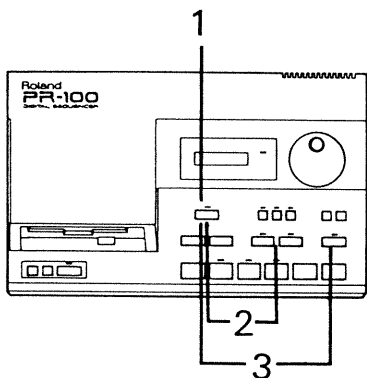

**NOTE:** If no music is recorded in Tracks 1 or 2, LEDs of TRACK SELECT buttons 1 or 2 will not be lit. If there is no recorded data in Tracks 3 or 4, on pressing EXECUTE button, LEDs of TRACK SELECT 1 or 2 buttons will not light. Similar, if there is no rhythm recorded in the Rhythm track, on pressing EXECUTE button, METRONOME LED will not be lit.

If there is recorded data in Tracks 1 and 2, and no data is recorded in Tracks 3, 4 or in the Rhythm track, on pressing EXECUTE button, LEDs of TRACK SELECT 1 and 2 remain alight, causing no change in LEDs.

Summary of "muting" procedure:

Track 1	= Press TRACK SELECT 1 button
Track 2	= Press TRACK SELECT 2 button
Sub Track 3	= Press EXECUTE & SELECT 1 button
Sub Track 4	= Press EXECUTE & SELECT 2 button
Sub Track RHYTHM	= Press EXECUTE & METRONOME button

e) Start playback with automatic metronome count-in.

- (1) While pressing EXECUTE button, press PLAY button. Playback will automatically start with a 2 measure metronome count-in.

(This 2 measure metronome count-in will occur even if the song is played from the very beginning - Measure 1)

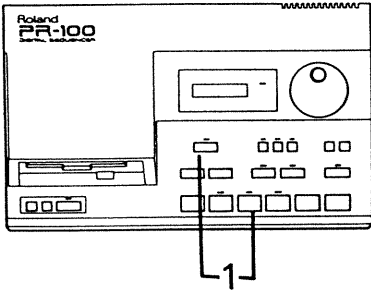

**NOTE:** If the playback is to be started from anywhere in the middle of a measure, the metronome will count-in one measure and up to the start of the playback in the next measure.

f) Start/Stop Playback with FOOT SWITCH

Instead of using the PLAY and STOP buttons, you may use the Foot Switch DP-2 (optional) for starting or stopping the playback. Connect the DP-2 Foot Switch into the START/STOP jack on the rear of the PR-100.

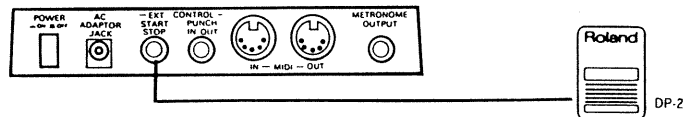

Press the Foot Switch to start, and press it again to stop.

Many more advanced functions are available with the PR-100. These are all explained in PART 2.

# HOW TO USE PR-100 FEATURES - PART 2

## 5. EDIT

### a) Delete

The Delete function will delete the measure presently appointed in the display and onwards to the end of the song.

- (1) Position the song at the measure number you wish to delete and onwards by using BWD/FWD buttons.)
- (2) Press DELETE button. The display will indicate "Delete" and TRACK SELECT 1 & 2 LEDs begin to flash.

Delete

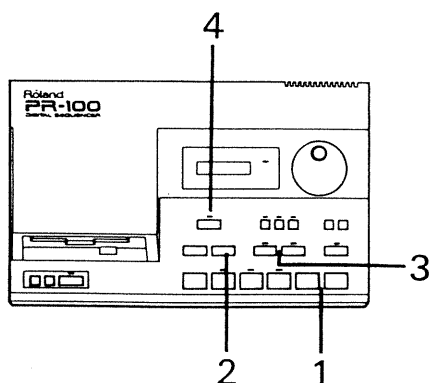

- (3) Press TRACK SELECT button 1 or 2 to select which track you wish the deletion to take place. EXECUTE LED begins to flash.
- (4) Press EXECUTE button to execute the function. Measure presently appointed and onwards have now been deleted and the PR-100 is returned to the 'Stand By' mode.

- or -

Press DELETE button to return to (2).

- or -

Press STOP button to cancel the Delete function and return the PR-100 to 'Stand By' mode.

### b) Merge

The Merge function allows you to combine the information on one track with the information on the other track to provide you with an empty track for additional recording. Separate MIDI channel information will be retained after the tracks have been merged.

Merge is similar to "bouncing" or "Ping-Ponging" tracks on a multi-track tape recorder. However, unlike a tape recorder, the sound quality is not affected by merging and an empty third track is not required.

When you are satisfied with the recordings in Tracks 1 & 2, you can merge both tracks into one:

- (1) Press MERGE button. The display will indicate "Merge" and TRACK SELECT 1 & 2 LEDs begin to flash.

Merge

- (2) Press TRACK SELECT button 1 or 2 to select the destination track. EXECUTE LED begins to flash. (Remember any data on the destination track will be retained.)

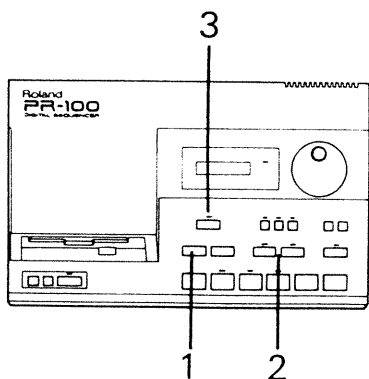



- (3) Press EXECUTE button to execute the function. The track selected now contains all information from both tracks. LED of source track (track merged from) will be turned off.  
- or -

Press MERGE button to return to (2).

- or -

Press STOP button to cancel the Merge function and return the PR-100 to 'Stand By' mode.

**NOTE:** After merging, the tracks cannot be separated.

### c) PUNCH-IN/OUT RECORDING

The Punch-In/Out Recording function is useful for when you want to re-record only a certain part of the recorded data. This can be valuable for correcting a part in real time without having to re-record the entire performance.

From the Punch-In position to the Punch-Out position, the PR-100 is in the recording mode, that is, the data previously recorded will be erased.

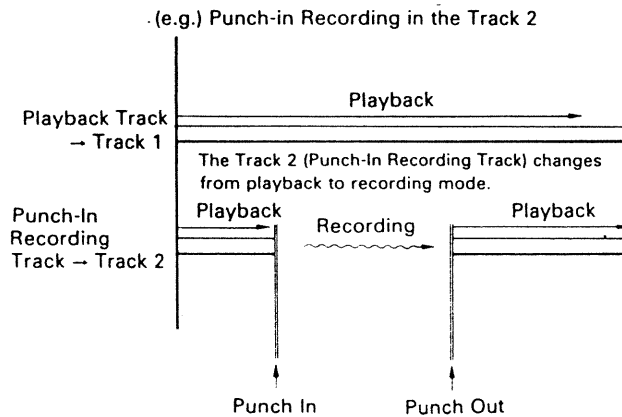

**NOTE:** Punch-In/Out Recording can be carried out from the beginning, ending or any position in a measure.

d) Punch-In/Out Recording - using MARKER A & B:

- (1) Press REC MODE button. The display will indicate "REAL" and EXECUTE LED will begin to flash.

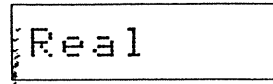

- (2) Rotate Alpha-DIAL clockwise to select "PUNCH".

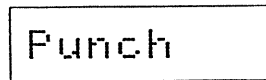
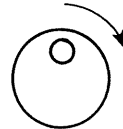

- (3) Press EXECUTE button to execute the change and return the PR-100 to 'Stand By' mode. (The PR-100 being switched off, any changed data is cancelled.)

- or -

Press STOP button to cancel the change of REC MODE and return the PR-100 to 'Stand By' mode.

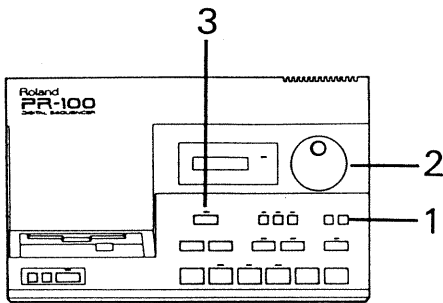

For cancellation of any changed value in the REC MODE, press REC MODE button.

- (4) Set the measure number where recording is to start (Punch-In).
- (5) Press MARKER A button. LED lights.
- (6) Set the measure number where recording is to end (Punch-Out).
- (7) Press MARKER B button. LED lights.
- (8) Set the measure number of the music to one or two measures before the point Punch-In recording is to be carried out.
- (9) Press REC button. REC LED will light and TRACK SELECT buttons 1 & 2 will begin to flash.
- (10) Press TRACK SELECT button 1 or 2, to put PR-100 in REC 'Stand By'. TRACK SELECT LED of button pressed will stay lit and PLAY button LED will begin to flash.

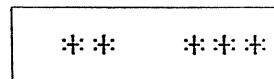

- (11) Press PLAY button to start playback. (Count-In function is not available for this mode.)

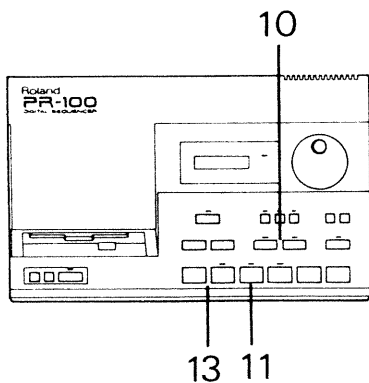
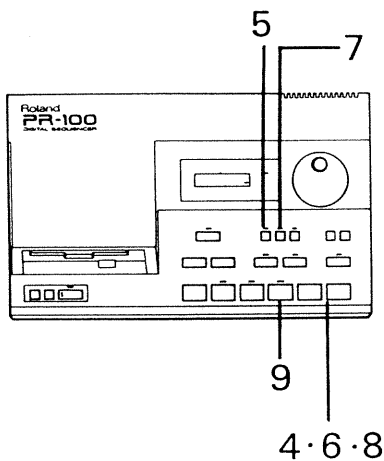

- (12) Play MIDI keyboard at point when Punch-In recording is required. (PR-100 will automatically start recording at MARKER A and stop recording at MARKER B.)



- (13) Press STOP button or RESET button to stop playback.

**e) Punch-In/Out Recording - using optional Foot Switch (DP-2):**

Carry out procedures 1 to 3 in "Punch-In/Out Recording using MARKER A & B".

- (4) Connect the Foot Switch (DP-2) to the PUNCH IN/OUT jack located on the rear of the PR-100.

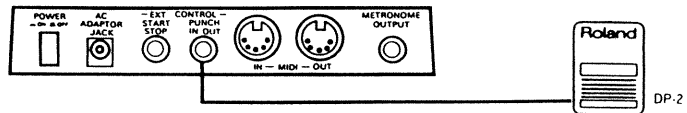

- (5) Press REC MODE button while keeping STOP button pressed. The display will indicate "MARKER" and EXECUTE LED will begin to flash.

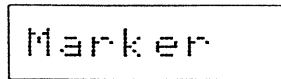

- (6) Rotate Alpha-DIAL counterclockwise to select "PEDAL".

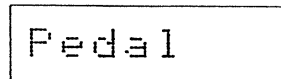
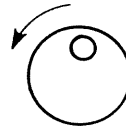

- (7) Press EXECUTE button to execute the change and return the PR-100 to 'Stand By' mode. (The PR-100 being switched off, any changed data is cancelled.)

- or -

Press STOP button to cancel the change of Start mode and return the PR-100 to 'Stand By' mode.

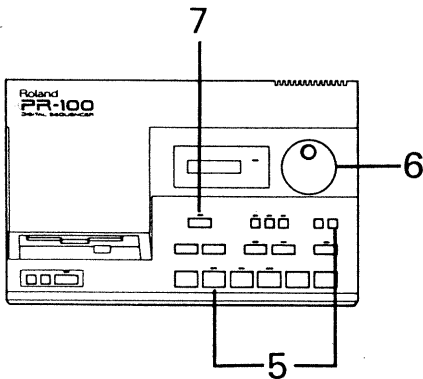

For cancellation of any changed value in the REC MODE, press REC MODE button.

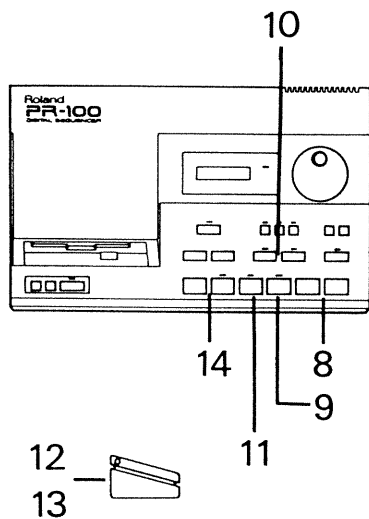

- (8) Set the measure number of the music to one or two measures before the point Punch-In recording is to be carried out.
- (9) Press REC button. REC LED will light and TRACK SELECT buttons 1 & 2 will begin to flash.
- (10) Press TRACK SELECT button 1 or 2, to put PR-100 in REC 'Stand By'. TRACK SELECT LED of button pressed will stay lit and PLAY button LED will begin to flash.
- (11) Press PLAY button to start playback. PLAY LED will light and REC LED will begin to flash.  
(Count-In function is not available for this mode.)
- (12) Press the Foot Switch at the point when Punch-In recording is required and play MIDI keyboard. REC LED will stay lit.

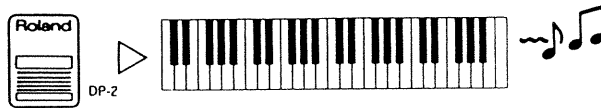

- (13) Press Foot Switch at the measure you wish the recording to stop (Punch-Out). REC LED will again start to flash.
- (14) Press STOP button or RESET button to stop playback.

**NOTE:** This Punch-In/Out feature is available for plural places.

**NOTE:** Both the above Punch-In/Out features can also be used to erase a certain note(s) from any track. Follow all procedures but do not play MIDI keyboard.

**NOTE:** The Punch-In/Out recording function should not be used to record or record over data which has been recorded with bender or hold effect on. Otherwise problems could occur, such as notes sounding continuously, and the overall pitch of the sound being altered.

#### f) Recording from the middle or end of a song

Data can be recorded from any measure in a track. When you enter data into an existing track, the new information will replace any data that previously existed in those measures.

You may also continue recording from the end of a song. The data in the preceding measures will remain. Recording from the end of song gives you the option of remaining with the previous Time-Signature or selecting a new Time-signature.

**NOTE:** If the memory becomes full during recording, the display will respond with "Full". This means that no more notes can be recorded.

Full

---

#### Recording Non-Note Information in Real Time

MIDI performance information other than notes may be overdubbed onto an empty track. This can be very useful for adding information such as Modulation, Sustain Pedal, Program Change, Volume etc. to a performance.

Parameters such as Program Changes and Volume should usually be entered as an overdub since it is difficult to enter this information while playing. In this way, you can listen to the performance and enter changes accordingly.

To record non-note information into a particular track, follow the procedure "OVERDUBBING" in PART 1. Instead of playing music on the keyboard, carry out the necessary non-note changes.

When you are satisfied with the additional performance information you have recorded, Merge (combine) it with the note information. When the merge operation has been carried out, the note and non-note data cannot be separated.

## 6. QUICK DISK (QD)

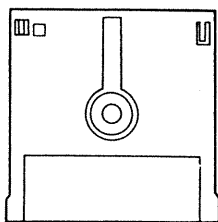

After recording your performance on the PR-100, the data can be stored onto a 2.8 inch Quick Disks (QD's) using the built-in Disk Drive. The memory capacity of a QD is approx. 8,500 notes on each side.

### Disk Drive Indicator

This is always lit when the Disk Drive is working.

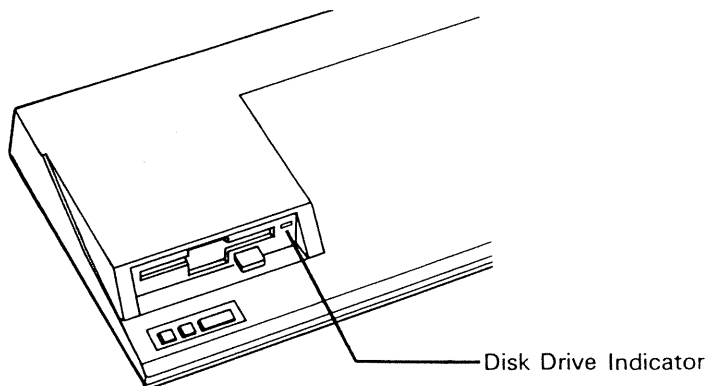

### a) Quick Disk (QD) - LOAD

To load data from a Quick Disk, make sure that the Disk Indicator is not lit.

- (1) Insert a QD into the Disk Drive and press LOAD button. The display will ask "Load OK?" and QD EXECUTE LED will begin to flash.

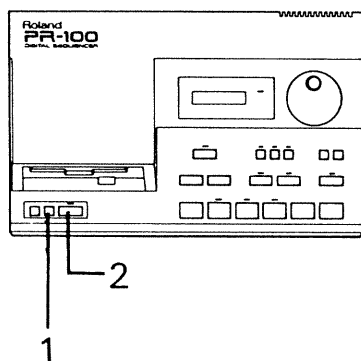

Load OK?

- (2) Press QD-EXECUTE button to execute the function.

When the loading is completed, a beep is heard and the PR-100 will return to the 'Stand By' mode.

To remove the disk, push the EJECT button which is located at the right side of the Disk Drive and take out the disk.

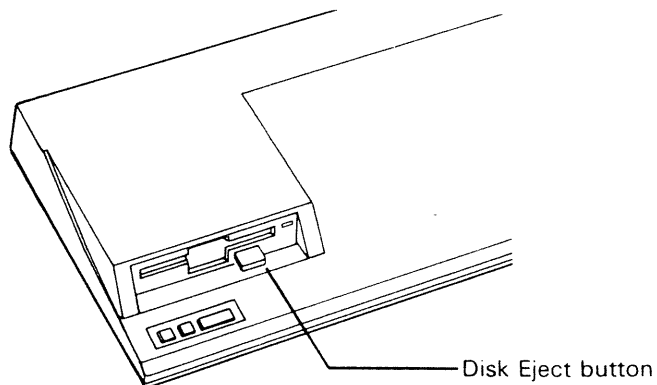

### b) Quick Disk (QD) - SAVE

- (1) Insert a QD into the Disk Drive with the side indication (A or B) you wish to save on facing upwards and press SAVE button. The display will ask "Save OK?" and QD EXECUTE LED will begin to flash.

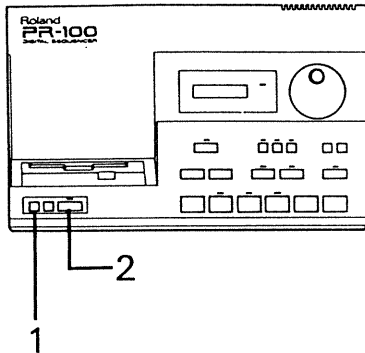

Save OK?

- (2) Press QD-EXECUTE button to execute the function.

When saving is completed, a beep is heard and the PR-100 returns to the 'Stand By' mode.

"Protect": The protect tab of the QD is broken off. To rewrite data on this QD, see page 10.

To remove the disk, push the EJECT button which is located at the right side of the Disk Drive and take out the disk.

The data saved on the QD can be loaded back into the PR-100 at any time.

---

You may be required to insert or change a QD by the PR-100 indicating the following messages in the LCD display:

"INSERT QD": 1. When you pressed LOAD or SAVE button, the QD was not in the DISK Drive.

"INSERT QD": 2. When you took the QD out of the Disk Drive to turn over for loading or saving the data from both sides of the disk.

"CHANGE QD": 1. Turn the QD over and insert again to load or save the data continuously from the first side of the QD.

---

### c) Playback Pre-recorded QD's

- (1) Insert the QD into the Disk Drive and press LOAD button. The display will ask "Load OK?" and QD EXECUTE LED will begin to flash.

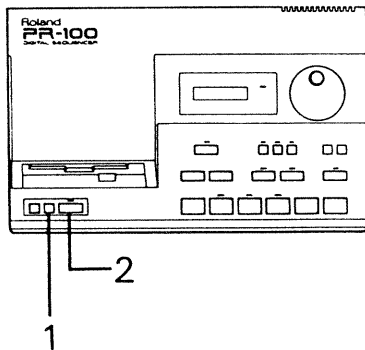

Load OK?

- (2) Press QD-EXECUTE button to execute the function.

Try to playback the songs of the Pre-recorded QD which accompanied the PR-100. Four demonstration songs are stored on side A and two complete songs on side B.

**NOTE:** ON side B playback, PR-100 automatically stops at the end of the first song. The display on PR-100 will indicate 41th measure. A PAUSE MARK is preset on this measure (See Page-9. "ADVANCED OPTIONAL MODES" c to f). Press PLAY button again to start to playback the second song.

## 7. MIDI CONFIGURATION MEMORY

Through the use of the following eight parameters, you can select which information the PR-100 sends or receives.

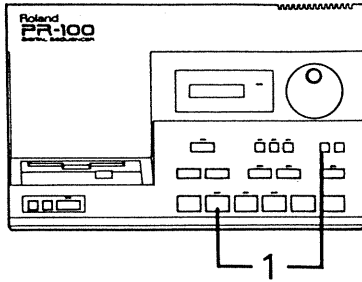

- (1) Press BEAT/MEAS button while keeping STOP button pressed. The display will indicate the first parameter value "THRU OFF" and the EXECUTE LED will begin to flash.

THRU OFF

### a) SOFT THRU

The SOFT THRU function on the PR-100 combines the signal coming into the MIDI Input with the signal transmitted from the MIDI Output.

When using a MIDI master keyboard, example: Roland Contemporary Piano (HP); this function must be in the ON position to play the connected sound module. If Soft Thru is OFF, the master keyboard's live performance will not pass through the MIDI OUT of the PR-100 to the sound module.

- (2) Rotate the Alpha-DIAL to change value (ON or OFF).

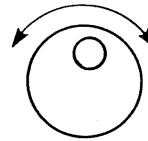

- (3a) Press EXECUTE button while keeping REC button pressed, to write the change of MIDI CONFIGURATION MEMORY in the PR-100 and return the PR-100 to 'Stand By' mode. (The changed data is stored even if the PR-100 is switched off.)

- or -

- (3b) Press EXECUTE button to store the changed data of MIDI CONFIGURATION MEMORY in the PR-100 temporarily and return the PR-100 to 'Stand By' mode. (The PR-100 being switched off, any changed data is cancelled.)

- or -

- (3c) Press STOP button to cancel the change of MIDI CONFIGURATION MEMORY and return the PR-100 to 'Stand By' mode.

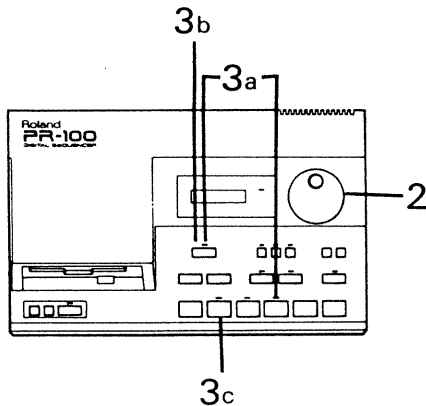

For cancellation of any changed data in the selected mode, press BEAT/MEAS button.



**NOTE:** When using a normal synthesizer, switch off the SOFT THRU parameter, otherwise it could cause a problem.



To change to other MIDI parameters, carry out procedure (1) then:  
Press FWD button once to select the second parameter and the display will indicate its value "SYNC INT".

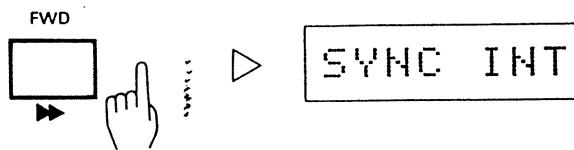

#### b) SYNC MODE

The SYNC MODE function determines the mode of the clock control of the PR-100. (Internal or External) The PR-100 can function as either a master clock which will control other MIDI instruments (such as an external drum machine), or as a slave which will sync to the clock of another instrument or device.

When using an external drum machine or device, set the SYNC MODE parameter to internal (SYNC INT).

To use an external device as the master and the PR-100 as the slave:

- (2) Rotate the Alpha-DIAL clockwise to change the mode to "SYNC EXT".

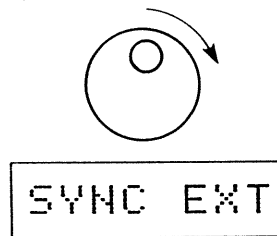

Follow procedures (3a), (3b) and (3c) to execute or cancel any change.

Press FWD button twice to select the third parameter and the display will indicate its value "CLK OFF".

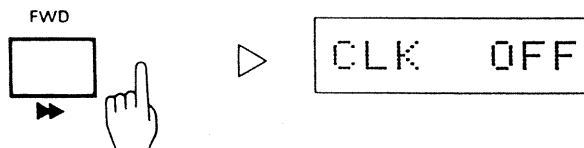

### c) MIDI Clock

The MIDI timing (clock) information is in the off position upon turn-on of the PR-100. If you want to transmit this information:

- (2) Rotate the Alpha-DIAL clockwise to change the value to "CLK ON".

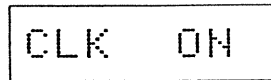
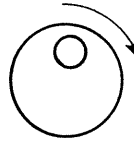

Follow procedures (3a), (3b) and (3c) to execute or cancel any change.

- Press the FWD button three times to select the fourth parameter and the display will indicate its value "AFT ON".

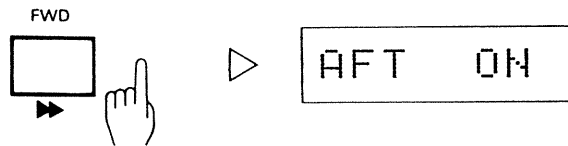

### d) After-Touch

After-touch is MIDI information which is produced by applying pressure to the key after it has been played. Channel monophonic after-touch, found on most synthesizers and keyboard controllers sends out one stream of after-touch information for the entire keyboard. Channel (monophonic) after-touch uses less memory in the PR-100 than polyphonic after-touch but if you are using a keyboard with Channel (monophonic) after-touch you may still wish to filter out this information while recording to conserve memory.

- (2) Rotate the Alpha-DIAL counterclockwise to change the value to "AFT OFF".

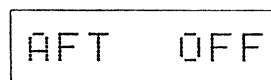
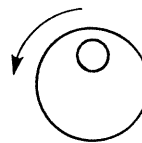

Follow procedures (3a), (3b) and (3c) to execute or cancel any change.

Press the FWD button four times to select the fifth parameter and the display will indicate its value "BEND ON".

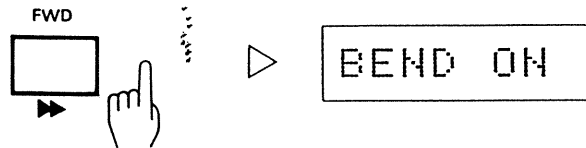

#### e) Pitch Bend

Pitch Bend is a continuous change in frequency (pitch) and is generated from Pitch Bend wheels, levers or ribbons. Pitch Bending uses a large amount of memory. To conserve memory, you may wish to filter out this information while recording.

- (2) Rotate the Alpha-DIAL counterclockwise to change the value to "BEND OFF".

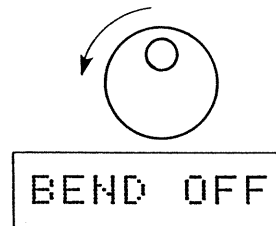

Follow procedures (3a), (3b) and (3c) to execute or cancel any change.

Press the FWD button five times to select the sixth parameter and the display will indicate its value "CTRL ON".

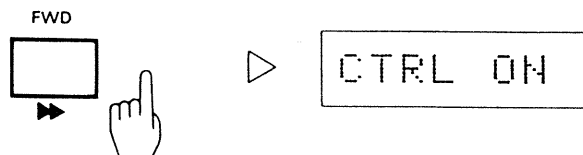

#### f) Control Change

The Control Change message is used to modify the MIDI data with a controller other than a keyboard. These include - Damper (Sustain) Pedal, Soft pedal, Modulation wheel or lever, Breath Controller etc. If using a keyboard which includes one of these controllers, you may wish to filter out this information when recording.

- (2) Rotate the Alpha-DIAL counterclockwise to change the value to "CTRL OFF".

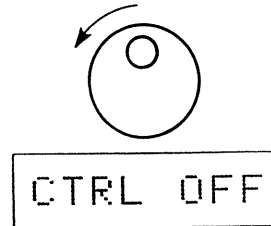

Follow procedures (3a), (3b) and (3c) to execute or cancel any change.

Press the FWD button six times to select the seventh parameter and the display will indicate its value "PROG ON".

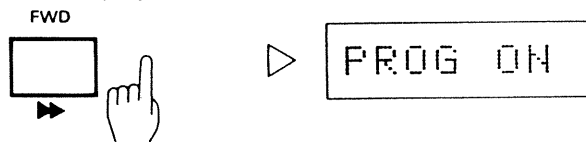

#### g) Program Change

Program Change messages can be sent through MIDI to change a sound module's patch (program) numbers. Program Change messages sent from a keyboard controller to the PR-100 can be selectively filtered out by turning off the Receive Program Change.

- (2) Rotate the Alpha-DIAL counterclockwise to change the value to "PROG OFF".

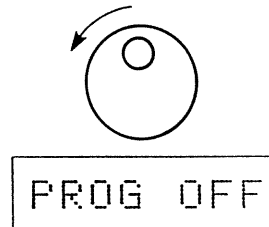

Follow procedures (3a), (3b) and (3c) to execute or cancel any change.

Press the FWD button seven times to select the eighth parameter and the display will indicate its value "EXCL ON".

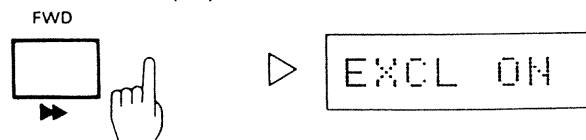

#### h) System Exclusive

System Exclusive contains parameter information that is specific to a particular product of device. The PR-100 has the ability to record this information from instruments that can send it. Because System Exclusive can use a large amount of memory, you may wish to filter out System Exclusive information while you are recording.

- (2) Rotate the Alpha-DIAL counterclockwise to change the value to "EXCL OFF".

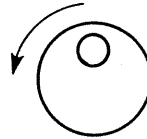

EXCL OFF

Follow procedures (3a), (3b) and (3c) to execute or cancel any change.

**NOTE:** If your master keyboard does not send any of the MIDI messages (After-touch, Pitch Bend, Control Change, Program Change, System Exclusive), there is no need to turn any of these parameters OFF.

**Summary of MIDI CONFIGURATION MEMORY parameters and default (preset) values.**

"THRU OFF"	(default)	SOFT THRU
"SYNC INT"	(default)	SYNC MODE
"CLK OFF"	(default)	Transmit MIDI clock
"AFT ON"	(default)	Receive aftertouch (Channel/keys)
"BEND ON"	(default)	Receive Pitch Bend
"CTRL ON"	(default)	Receive Control Change
"PROG ON"	(default)	Receive Program Change
"EXCL ON"	(default)	Receive System Exclusive

To change parameters: use FWD/BWD button

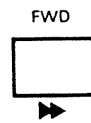
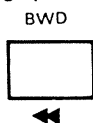

To change values: use Alpha-DIAL

For "ON" or "EXT", rotate Alpha-DIAL clockwise and for "OFF" or "INT", counterclockwise.

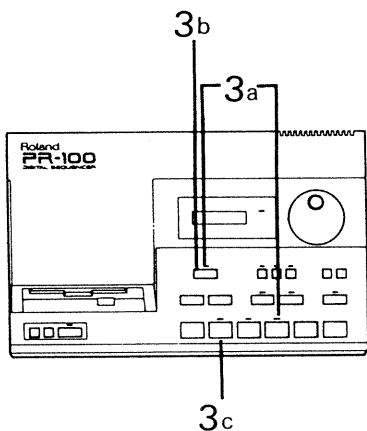
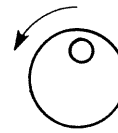
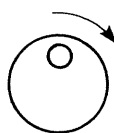

(3a) Press EXECUTE button while keeping REC button pressed, to write the change of MIDI CONFIGURATION MEMORY in the PR-100 and return the PR-100 to 'Stand-By' mode. (The changed data is stored even if the PR-100 is switched off.)

- or -

(3b) Press EXECUTE button to store the changed data of MIDI CONFIGURATION MEMORY in the PR-100 temporarily and return the PR-100 to 'Stand-By' mode. (The PR-100 being switched off, any changed data is cancelled.)

- or -

(3c) Press STOP button to cancel any change of MIDI CONFIGURATION MEMORY and return the PR-100 to 'Stand-By' mode.

For cancellation of any changed data in any selected mode, press BEAT/MEAS button.



## 8. ERROR MESSAGES

Error 1	"Error 1" - MAIN MEMORY error
Error 2	"Error 2" - MIDI CONFIGURATION MEMORY error ⋮ ⋮
	▲ <u>The PR-100 has broken down. Call for the Roland service station.</u>
Full	"Full " - Overloading the memory capacity in recording.
Load ERR	"Load ERR". The QD is totally blank. - The QD was once used and loaded on other Roland products. - The QD was once used and loaded on other manufacturers. - Totally impossible for the disk drive to read because of the QD being damaged or faulty.
Save ERR	"Save ERR" - Accurate saving is not possible.
Protect	"Protect" - The protect tab of the QD is broken off.
VerifyER	"Verify ER" - data in PR-100 does not correspond to data on QD when QD-Verify feature has been executed.
Cannot !	"Cannot !" - Impossible to save data onto the QD because of protection.
Ejected!	"Ejected!" - QD is ejected, under loading or saving conditions.
Mismatch	"Mismatch" - In loading the data saved on both sides of a QD, and when the same side of the QD is inserted again or different QD is inserted.
CheckERR	"CheckERR"- The QD is totally blank. - The QD was once used and loaded on other Roland products. - The QD was once used and loaded on other manufacturers.

- ▲ Pushing the Stop Button will return the unit to the previous condition (which is before the Error Messages is displayed).

## 9. ADVANCED OPTIONAL MODES

### a) All Clear - to clear memory and mode changes completely.

- (1) Press DELETE button while keeping STOP button depressed. The display will indicate "All Clear" and EXECUTE LED starts to flash.

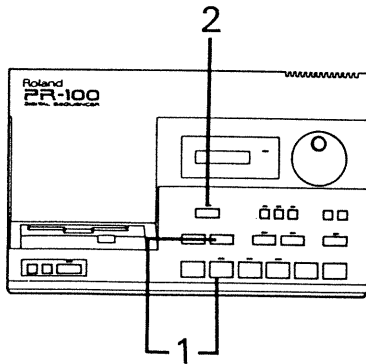

All Clear

- (2) Press EXECUTE button to execute the function and clear all data.

All the tracks become empty and all the data of REC MODE, Punch-In/Out start, BEAT/MEAS, MIDI CONFIGURATION MEMORY are returned to the same conditions as when PR-100 was switched on (default value).

### b) Memory Consumption

The PR-100 will display by percentage how much memory has been used on any recording.

- (1) Press REC MODE button while keeping EXECUTE button depressed, the display will indicate the amount of memory already consumed.  
"Used%"

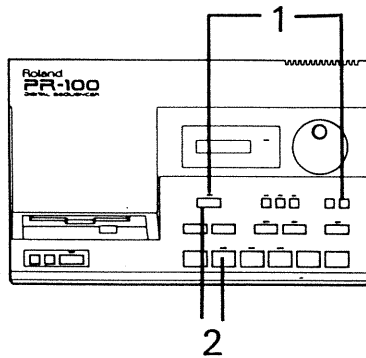

Used\*\*\*%

- (2) Press STOP button or EXECUTE button to return to 'Stand-By' mode.

### c) PAUSE MARK

PAUSE MARKS are similar to marks set by MARKER A & B buttons but are invisible to the eye. PAUSE MARKS can be set by the player or factory set (Pre-recorded QD's).

When a PAUSE MARK is set the music will stop at that point. To start the PR-100 again press PLAY.

PAUSE MARKS can be used to:

- 1) divide one short song from another on the same recording.
- 2) pause the playback of a song while a piece of music is played manually on the master keyboard (Cadenza, Rubato, obbligato section).
- 3) pause the playback of a tune in between different movements.
- 4) pause between exercises in educational music pre-recorded by teachers.



#### d) PAUSE MARK Set

To set a pause mark in a particular song.

- (1) Position the song at the measure you wish to set the PAUSE MARK using FWD or BWD button.
- (2) Press REC button while keeping both STOP button and QD-EXECUTE button depressed. (A PAUSE MARK will be set).

(A PAUSE MARK can be set only at the beginning of the measure.)

A maximum of twenty PAUSE MARKS can be set within the same song.

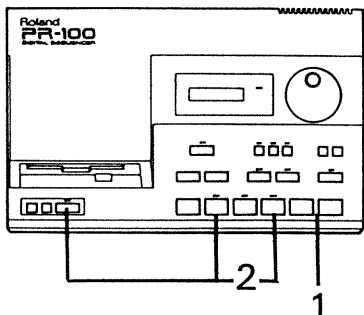

#### e) PAUSE MARK Delete

A PAUSE MARK which has been previously set can be cancelled:

- (1) By using GWD/FWD buttons go to the beginning of the measure which includes the PAUSE MARK you wish to cancel.
- (2) Press RESET button while keeping both the STOP button and QD-EXECUTE button depressed. (The PAUSE MARK will be cancelled).

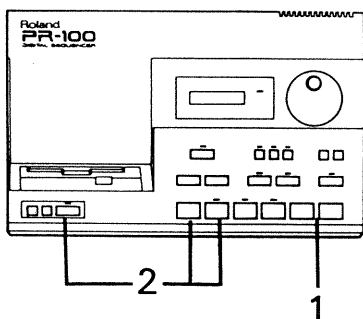

#### f) Jump PAUSE MARK

To jump to a particular PAUSE MARK forward or backward:

- (1) Press FWD or BWD button while keeping STOP button depressed.

(The PR-100 will jump to the nearest PAUSE MARK. In case of no PAUSE MARK being set, the PR-100 will jump to the beginning or end of the song.)

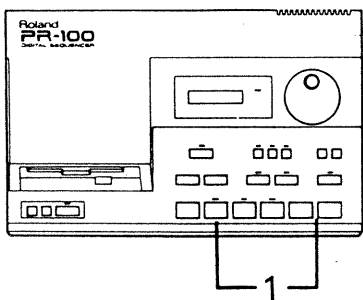

## 10. QD-OPTIONAL MODES

### a) QD-Model check

By inserting a QD into the Disk Drive, it is possible to check whether the QD has data saved on it and what instrument was used to store the data.

- (1) Press LOAD button while keeping STOP button depressed. The display will indicate "Check QD" and the QD-EXECUTE LED will begin to flash.

Check QD

- (2) Press QD-EXECUTE button. The display will indicate "Checking" and change to show the format of the QD inserted:

Checking

Example: If the data on the QD was stored from PR-100, the display will indicate "MC-03".  
If the Roland S-10 sampler keyboard was used to store the data, the display will indicate "S10".

MC-03

S10

In case of QD's that have been used on other manufacturer's products to store data, and are inserted in the PR-100, "CheckERR" is indicated in the display.

CheckERR

- (3) Press STOP button to return to 'Stand-By' mode.

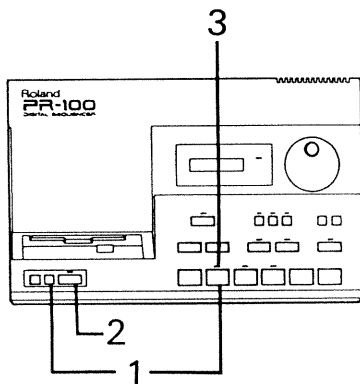

### b) QD-Verify

After loading or saving QD's, the data in the PR-100 can be checked against that on the QD:

- (1) Press SAVE button while keeping STOP button depressed. The display will indicate "VerifyQD" and the QD-EXECUTE LED will begin to flash.

VerifyQD

- (2) Press QD-EXECUTE button. The display will indicate "Verify.." and change to : "Complete" when the data in the PR-100 corresponds to the data on the QD.

Verify..

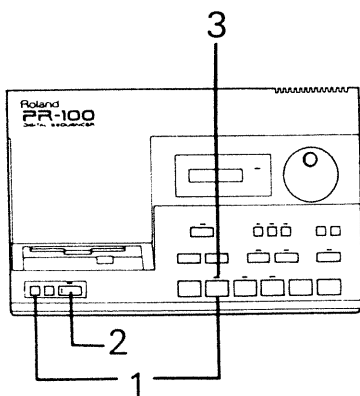

Complete

- (3) Press STOP button to return to 'Stand-By' mode. If the data in the PR-100 does not correspond to that on the QD, the display will indicate "VerifyEr".

VerifyEr

### c) Exchange Tracks and SAVE

Although from the panel there are only two visible Tracks, TRACK SELECT button 1 & 2, the PR-100 has a total of five Tracks, Two main TRACKS (1&2), two Sub Tracks (3 & 4) and a Rhythm Track.

The two main tracks is where you will execute most of your own recording. The two Sub Tracks are used mainly for the purpose of storing pre-recorded music from Pre-recorded Quick Disks but can be exchanged with Tracks 1 & 2 to store extra possibilities on recording. The Rhythm track is solely used to store pre-recorded rhythm data which can be temporarily muted but cannot be changed in any way.

To exchange Sub Tracks 3 & 4 with Tracks 1 & 2:

- (1) Press SAVE button while keeping EXECUTE button depressed. The display will ask "Ex&Save?" and QD-EXECUTE LED will begin to flash.

Ex&Save?

- (2) Press QD-EXECUTE button. The display will indicate "ExSaving".

ExSaving

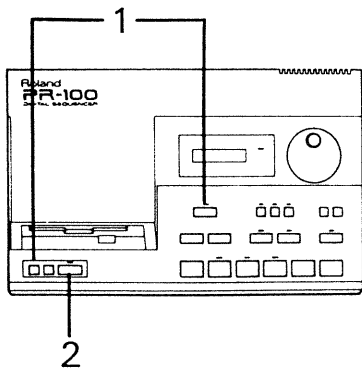

When the PR-100 has finished saving (disk indicator light is turned off), re-load QD into PR-100.

Tracks 1 & 2 will now become Sub Tracks 3 & 4, and Sub Tracks 3 & 4 will now become Tracks 1 & 2 and will have all the functional capabilities as explained in this manual.

## 11. OPTIONAL ACCESSORIES

The following accessories are available from your Roland dealer:

### FOOT SWITCH (DP-2)

This small compact switch permits you to Start/Stop recording and playback and Punch-In/Out recording with your foot.

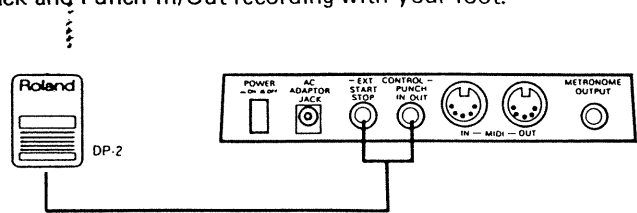

PRE-RECORDED QUICK DISKS

ADDITIONAL BLANK QUICK DISKS

ADDITIONAL MIDI CABLES

## ADDITIONAL FUNCTION

### QUANTIZE

The PR-100 also includes a special feature called "Quantize". When you record a performance into the PR-100 via MIDI, it is possible for the PR-100 to actually "correct" small timing errors. This is done by arithmetically dividing each measure into small quantities of time, and is hence called "quantizing" the measure. For example, a measure may be divided into 16th notes, so that no matter how you play, the result will be exact 16th notes. Obviously, this will make some performances much easier. If you need to record a drum part in strict time from the keyboard, or you simply wish to play a part that is either too fast or too hard, then "Quantize" can provide some spectacular results.

Furthermore, the "Quantize" featured in the PR-100 is unique, in that it happens automatically. However, you will need to turn it ON. Then, every time you record a specific part, the PR-100 will immediately begin to correct it, the moment you press the STOP button. To turn on the Quantize function, simply follow this procedure:

### IF YOU WISH TO RECORD WITH QUANTIZE

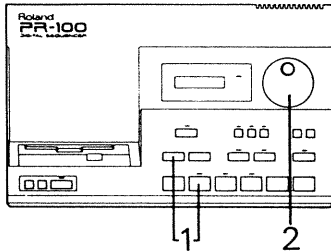

1. While holding down the STOP button, press the MERGE button. The display will show "Qua = OFF", and the EXECUTE light will begin to flash.

Qua = OFF

2. Rotate the Alpha-DIAL to select the Quantize resolution, that is, the size of the smallest "quantity" which you wish to appear in the measure. There are five possibilities as shown below:

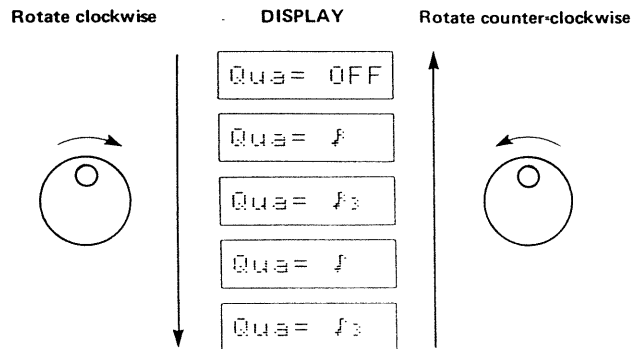

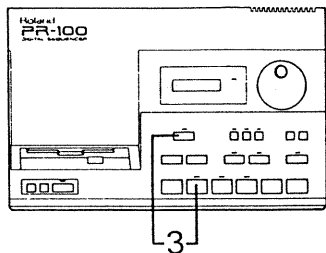

3. Press the EXECUTE button to confirm this choice and return to the "Stand-By" mode.

OR

Press the STOP button to cancel any change and return to the "Stand-By" mode.

4. Record the part. When you have finished recording, the display will briefly say "Quantize", and then return to the "Stand-By" mode.

---

**Special Notes:**

Whenever the PR-100 is turned off, it returns to the Quantize = OFF position. Consequently, you will always need to turn this function on when turning on the PR-100, if you need Quantize.

Also, the Quantize function can correct small timing errors, but it cannot repair serious mistakes. However, once a part has been Quantized, it is a simple matter to return to particular sections that were impossible to Quantize accurately, and then use the Punch-In function described in the manual.

1. RECOGNIZED RECEIVE DATA

1.1 Memorized messages while in RECORD mode

Status	Second	Third	Description	
1000 nnnn	0kkk kkkk	0vvv vvvv	Note OFF	*1
1001 nnnn	0kkk kkkk	0000 0000	Note OFF	
1001 nnnn	0kkk kkkk	0vvv vvvv	Note ON vvvvvvv = 1 - 127	
1010 nnnn	0kkk kkkk	0vvv vvvv	Polyphonic Key Pressure	*2
1011 nnnn	0ccc cccc	0vvv vvvv	Control Change	*2
1100 nnnn	0ppp pppp		Program Change	*2
1101 nnnn	0vvv vvvv		Channel Pressure	*2
1110 nnnn	0vvv vvvv	0vvv vvvv	Pitch Bend Change	*2
1111 0000	... ..	1111 0111	Exclusive message	*2
1111 0110			Tune Request	

1.2 Recognized only

Status	Second	Third	Description	
1011 nnnn	0111 1011	0000 0000	ALL NOTES OFF	*3
1011 nnnn	0111 1100	0000 0000	OMNI OFF	*4
1011 nnnn	0111 1101	0000 0000	OMNI ON	*4
1011 nnnn	0111 1110	000m mmmm	MONO ON	*4
1011 nnnn	0111 1111	0000 0000	POLY ON	*4
1111 0010	0ppp pppp	0ppp pppp	Song Position Pointer	*5,6

1.3 Recognized messages for sync.

Status	Description	
1111 1000	Timing Clock	*6
1111 1010	Start	*6
1111 1011	Continue	*6
1111 1100	Stop	*6

- notes : \*1 Memorized as  
1001 nnnn 0kkk kkkk 0000 0000.
- \*2 Memorized when corresponding function is set to ON.
- \*3 When all notes are not OFF, this unit creates OFF's for those notes.
- \*4 Recognized as only an ALL NOTES OFF.
- \*5 Recognized while in STAND BY mode.
- \*6 When SYNC is set at EXT.

2. TRANSMITTED DATA

- 2.1 All memorized messages are transmitted on Playing.
- 2.2 All received messages are transmitted if SOFT THRU is ON.
- 2.3 Created messages

Status	Second	Third	Description	
1011 nnnn	0111 1011	0000 0000	ALL NOTES OFF	*1
1011 nnnn	0111 1100	0000 0000	OMNI OFF	*2
1011 nnnn	0111 1111	0000 0000	POLY ON	*2
1111 0010	0ppp pppp	0ppp pppp	Song Position Pointer	*3
1111 1000			Timing Clock	*3
1111 1010			Start	*3
1111 1011			Continue	*3
1111 1100			Stop	*3
1111 1110			Active Sensing	

- notes : \*1 When all notes turn to off.
- \*2 When power is first applied, these MODE MESSAGES are transmitted for all channels (1-16).
- \*3 When CLK is set at ON.

# MIDI Implementation Chart

Function...		Transmitted	Recognized	Remarks
Basic Channel	Default Changed	all ch X	all ch 1-16 each	not BASIC ch
Mode	Default Messages Altered	Mode 3 OMNI OFF, POLY *****	<del>X</del> X	**
Note Number	True Voice	0-127 *****	0-127 0-127	
Velocity	Note ON Note OFF	O X 9n v=0	O X	
After Touch	Key's Ch's	O O	* *	
Pitch Bender		O	*	
Control Change	0-121	O	*	
Prog Change	True #	O *****	* 0-127	
System Exclusive		O	*	
System Common	Song Pos Song scl True	* X O	O (SYNC=EXT) X O	
System Real Time	Clock Comands	* *	O (SYNC=EXT) O (SYNC=EXT)	
Aux Message	Local ON/OFF All Notes OFF Active Sense Reset	O O (123) O X	O O (123-127) X X	
Notes		* Can be set to O or X manually. ** When power is first applied, OMNI OFF, POLY ON are sent for all channels (1-16).		

Mode 1 : OMNI ON, POLY  
Mode 3 : OMNI OFF, POLY

Mode 2 : OMNI ON, MONO  
Mode 4 : OMNI OFF, MONO

O : Yes  
X : No



## Information

- Please use this AC adaptor only with the specified device.
- Please use the AC Adaptor of an appropriate voltage (120, 220 or 240) depending on the voltage system in your country.
- When the device is not to be used for a long period, be sure to disconnect the AC adaptor (Power Supply Unit) from the wall outlet.
- When you need repair service, call your local Roland Service Station as shown below or the authorized Roland distributor in your country.

### U.S.A.

Roland Corp US  
7200 Dominion Circle  
Los Angeles, CA.90040-3647  
U.S.A.  
☎ (213) 685-5141

### CANADA

Roland Canada Music Ltd.  
(Head Office)  
13880 Mayfield Place,  
Richmond  
British Columbia  
Canada V6V 2E4  
☎ (604) 270-6626

Roland Canada Music Ltd.  
3469-rue Ashby  
St-Laurent,  
Quebec H4R 2C1  
☎ (514) 335-2009

Roland Canada Music Ltd.  
Unit B12-1515 Matheson Blvd  
Mississauga, Ontario L4W 2P5  
☎ (416) 625-4880

### AUSTRALIA

Roland Corporation  
(Australia) Pty. Ltd.  
(Head Office)  
38 Campbell Avenue  
Dee Why West, NSW 2099  
Australia  
☎ (02) 982-8286

Roland Corporation  
(Australia) Pty. Ltd.  
(Melbourne Office)  
50 Garden Street  
South Yarra, Victoria 3141  
Australia  
☎ (03) 241-1254

### NEW ZEALAND

Roland Corporation  
(NZ) Ltd.  
9 Nugent Street, Grafton  
Auckland 3  
New Zealand  
☎ (09) 398-715

### UNITED KINGDOM

Roland (UK) Ltd.  
Great West Trading Estate  
983 Great West Road  
Brentford, TW8 9DN,  
Middlesex, England  
☎ (01) 568 4578

### WEST GERMANY

Roland Elektronische  
Musikinstrumente  
Handelsgesellschaft mbH.  
Oststrasse 96,  
2000 Norderstedt  
West Germany  
☎ 040/526 0090

### BELGIUM/HOLLAND LUXEMBOURG

Roland Benelux N.V.  
Houtstraat 1  
B-2431 Oevel-Westerlo  
Belgium  
☎ 014-58 45 35

### DENMARK

Roland Scandinavia A/S  
Norre Sogade 49, 1370  
Copenhagen K.  
Denmark  
☎ (01) 11 31 11

### SWEDEN

Roland Scandinavia A/S  
Storskarsgatan 4  
115 29 Stockholm  
Sweden  
☎ 08-65 32 40/65 32 50

### NORWAY

Benum Music A/S  
Haakon den godes Vei 14  
N-0319 Oslo 3, Norway  
(Box 145 Vinderen, N-0319  
Oslo 3 Norway)  
☎ 02 141266

### FINLAND

OY Musiikki Fazer Musik AB  
Takomotie 3  
00380 Helsinki 38, Finland  
☎ 05 56551

### ITALY

Roland Italy S.p.A.  
Via Gallarate 58  
20151 Milano  
Italy  
☎ 02-3086849

### SWITZERLAND

Musitronic AG  
Gerberstrasse 5, CH-4410  
Liestal  
Switzerland  
☎ 061/91 16 15

### FRANCE

Musikengro  
102, Avenue Jean-Jaures  
69007 Lyon Cedex 07  
☎ (7) 858-54 60

Musikengro  
(Paris Office)  
Centre Region Parisienne  
41 rue Charles-Fourier, 94400  
Vitry s/Seine  
☎ (1) 680 86 62

### SPAIN

Vietronic S.A.  
Bohvia 239  
08020 Barcelona  
☎ 93-307 47 12

### AUSTRIA

E. Dematte & Co.  
Nue-Rum Siemens-Strasse 4  
A-6021 Innsbruck box 591  
☎ (05222) 63 451

### GREECE

A. ANDREADES & Co. I.T.D.  
2 Phidiou street,  
GR 10026B Athens  
☎ 3620130

PR-100

'87-7-C3-21(M)

 Roland

 Roland

---

**PR-100**  
DIGITAL SEQUENCER

---

**REVIEW OF OPERATING INSTRUCTIONS**

# Panel Discription

## 1. Front Panel

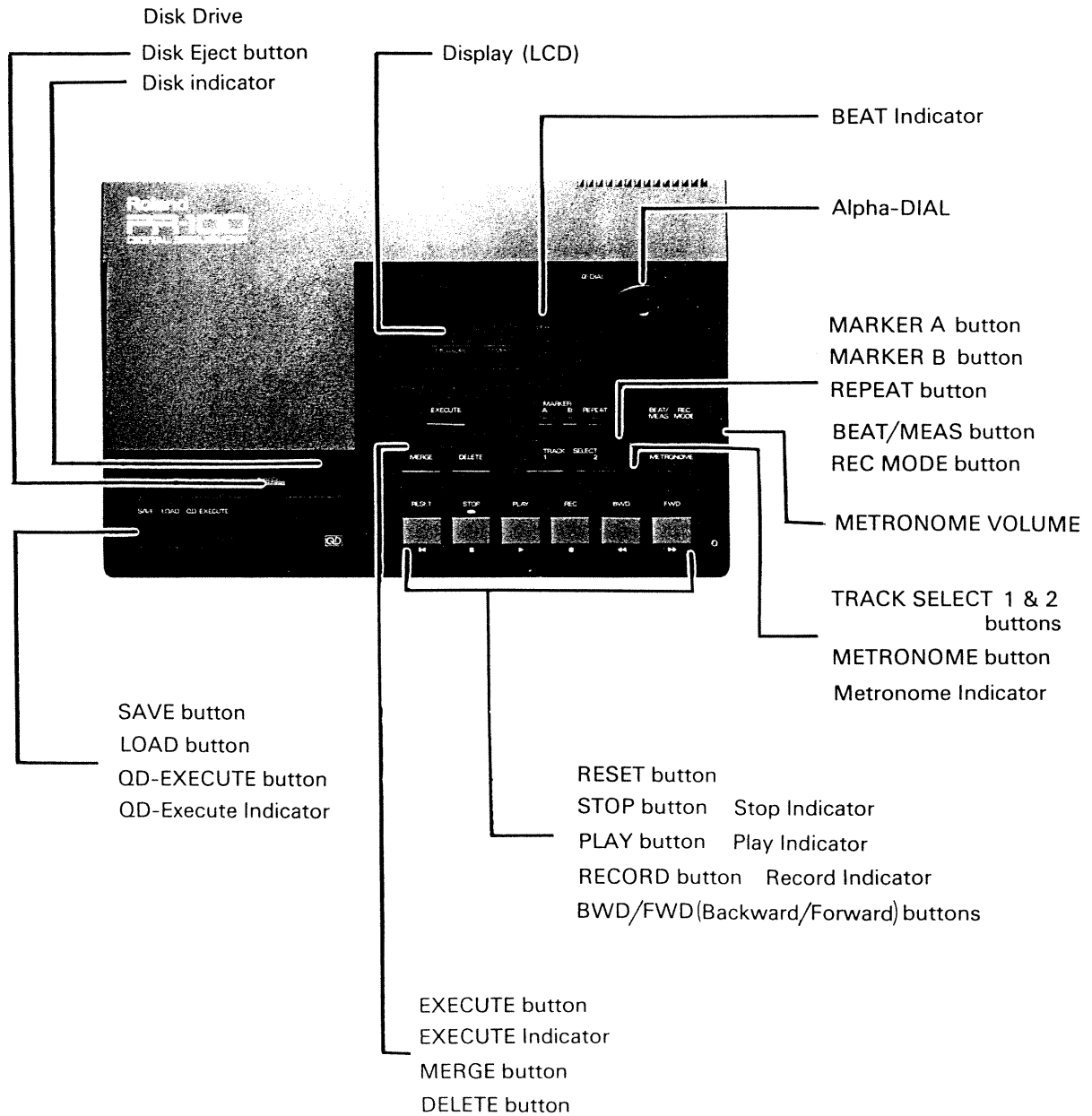

## 2. Rear Panel

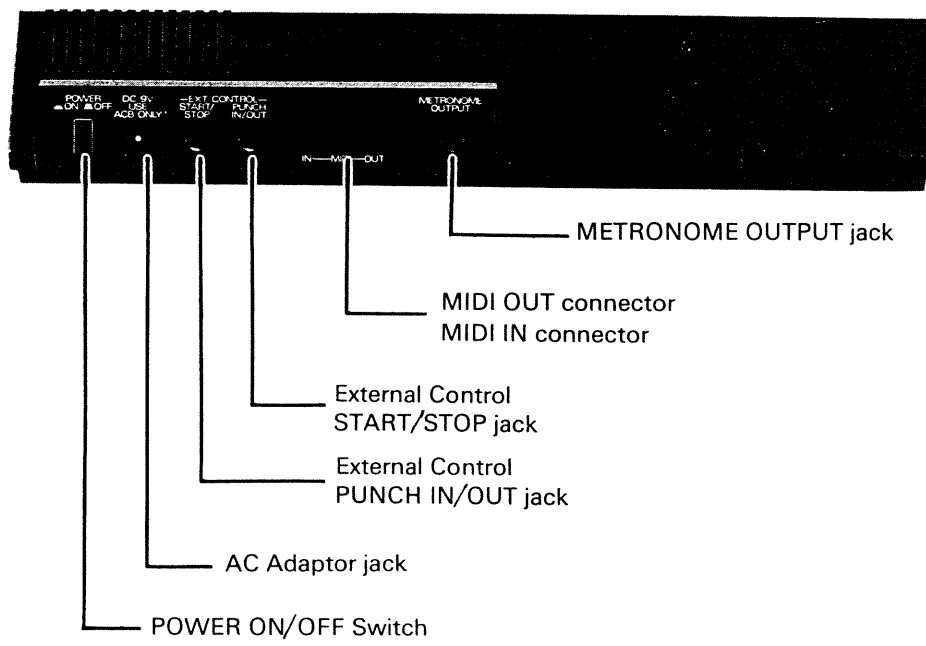

## 'STAND BY' MODE OF THE PR-100

When the display shows as below, the PR-100 is in the 'Stand By' mode. All recording, playing, saving and loading functions start from the 'Stand By' mode. After these functions have been executed, the PR-100 returns to the 'Stand By' mode.

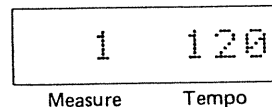

## BASIC OPERATION - PART 1

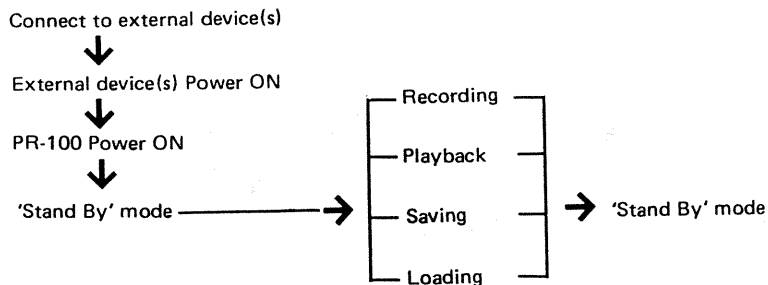

## RECORDING

### a) Key-On-Start

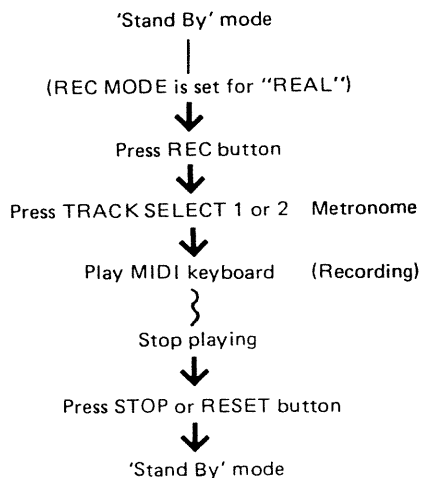

### b) Manual Start with Count-In

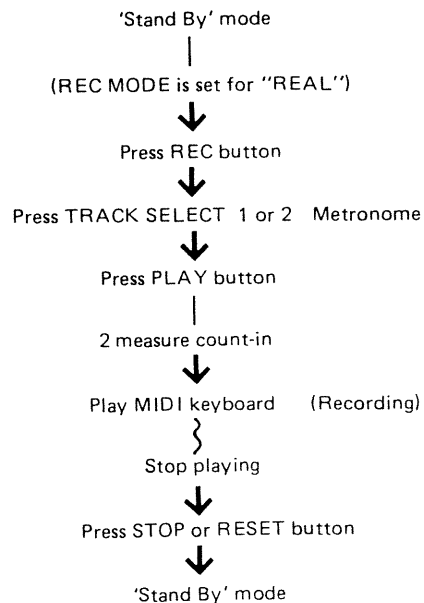

### c) Foot Switch Start



### OVERDUBBING



### BEAT / MEAS

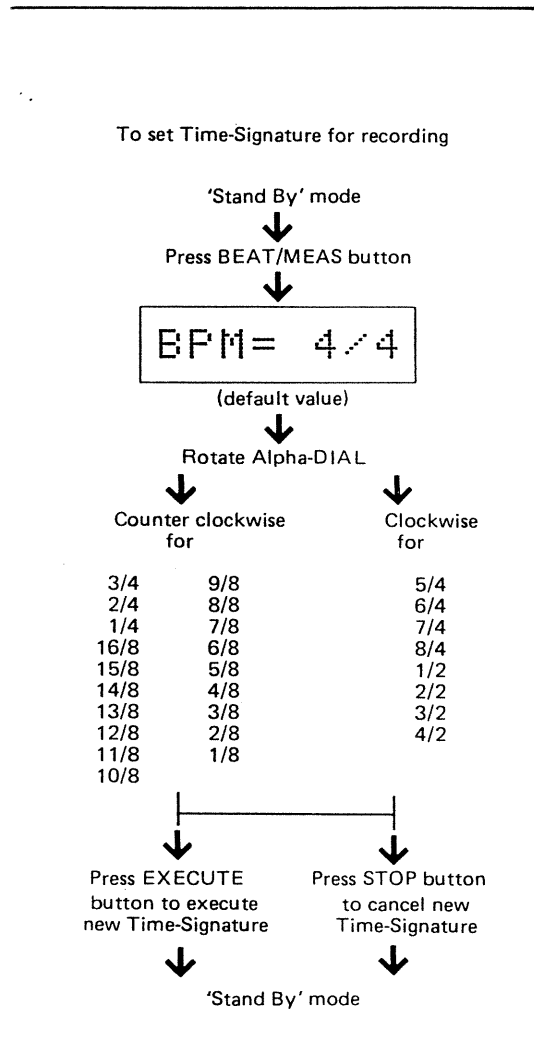

## OPTIONAL MODES

### a) Transpose (while playing or stopped)

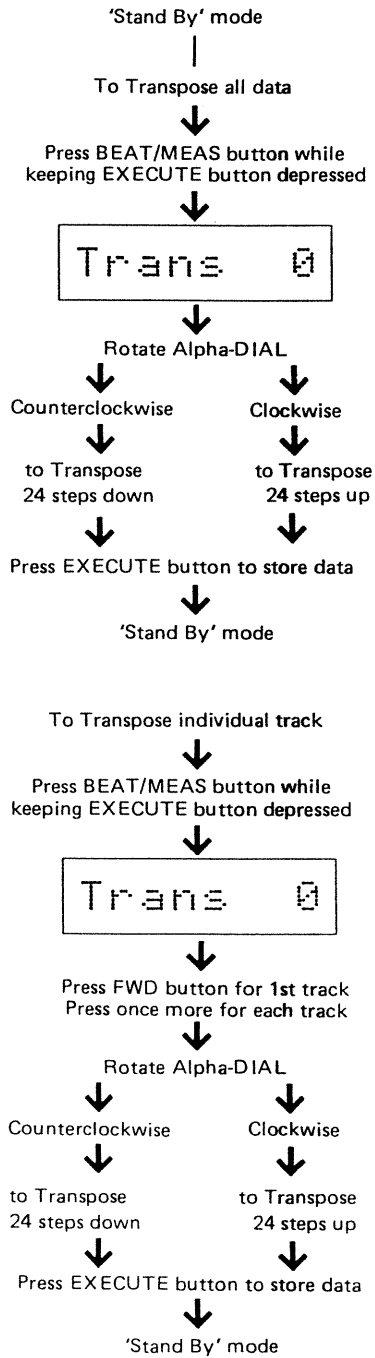

## PLAYBACK

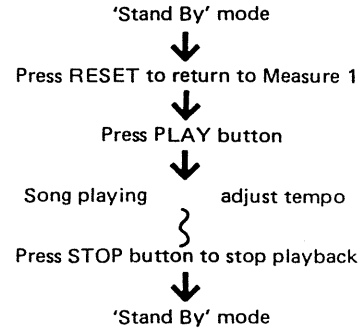

### Start Playback with Foot Switch

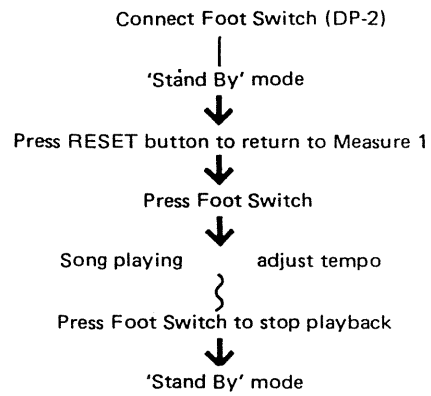

### a) Forward and Backward

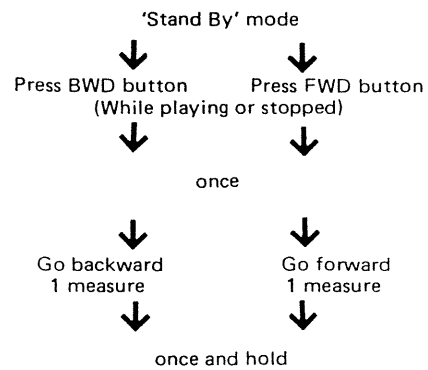



↓                      ↓  
 Fastwind              Fastwind  
 backwards              forwards

**b) METRONOME**

Press METRONOME button  
 ↓  
 Adjust volume with control

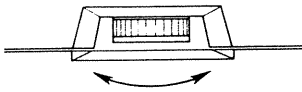

**c) BEAT Indicator**

(Recording or Playback)

First beat — flashes red  
 (Down beat)

Remainder beats — flash green

**d) Tempo change**

Rotate Alpha-DIAL  
 (while playing or stopped)  
 ↓                      ↓  
 Clockwise              Counterclockwise  
 ↓                      ↓  
 Tempo faster              Tempo slower

**e) Track Mute**

To mute Track 1              To mute Track 2  
 ↓                      ↓  
 Press TRACK 1              Press TRACK 2  
 button                      button  
 ↓                      ↓  
 To hear tracks, press same button again

**f) MARKERS A & B**

Go to desired measure  
 ↓  
 Press MARKER A — LED will light  
 ↓  
 Go to desired measure  
 ↓  
 Press MARKER B — LED will light

**g) Jump to MARKER**

(while playing or stopped)  
 ↓  
 Press the lit MARKER button A or B

**h) Cancel MARKER A or B**

↓  
 Press MARKER A or B  
 while pressing EXECUTE button

**i) Repeat MARKER A & B**

(while playing or stopped)  
 Press REPEAT button  
 ↓  
 Song will repeat

- a) Beginning to End — if no MARKER set
- b) MARKER A to End — if MARKER A set
- c) Beginning to MARKER B — if MARKER B set
- d) MARKER A to MARKER B — if MARKER A & B set

j) Restore original Tempo

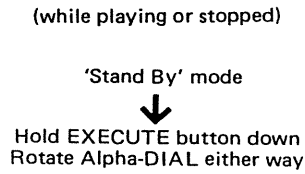

k) Mute Sub Tracks

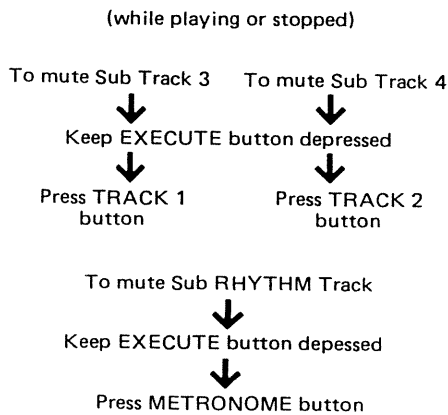

Summary of muting procedure

Track 1	= Press TRACK 1
Track 2	= Press TRACK 2
Sub Track 3	= Press EXECUTE + TRACK 1
Sub Track 4	= Press EXECUTE + TRACK 2
Sub Track Rhythm	= Press EXECUTE + METRONOME

BASIC OPERATION - PART 2

EDIT

a) Delete

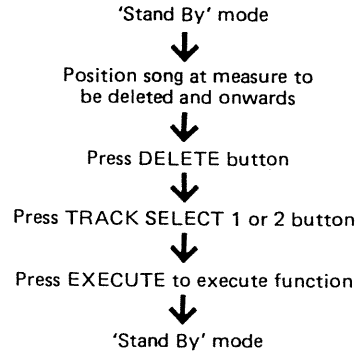

b) MERGE

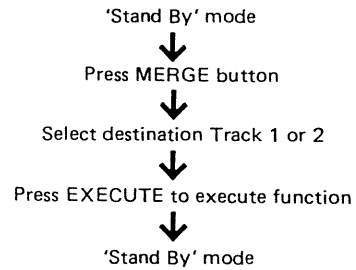

c) Punch-In/Out Recording using MARKER A & B

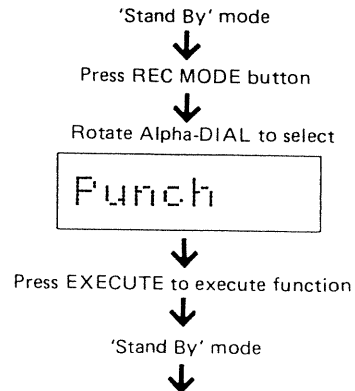

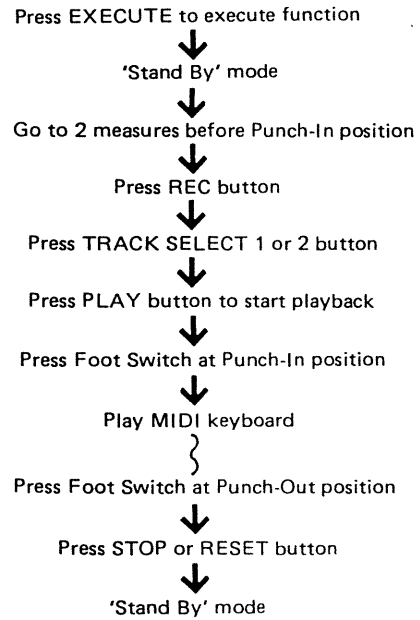
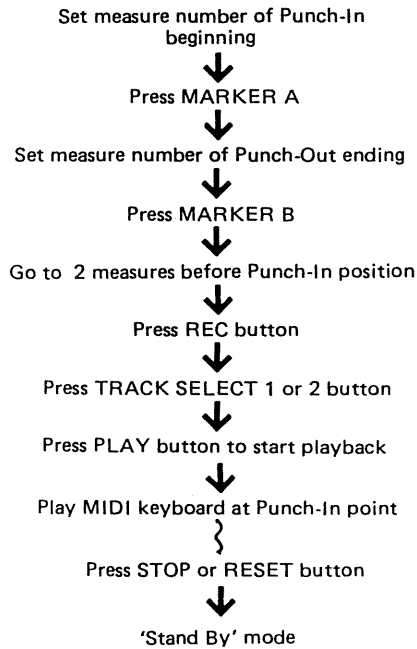

d) using optional Foot Switch

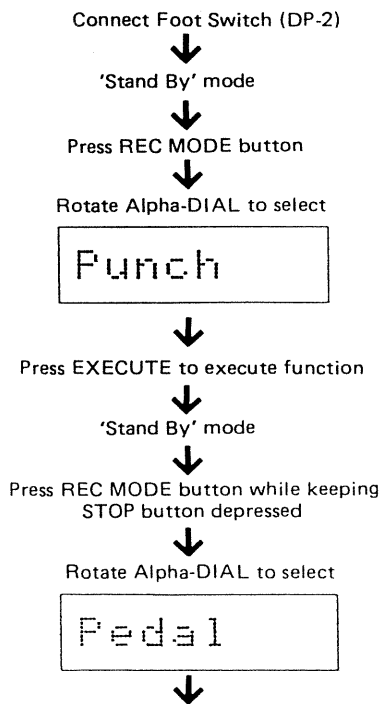

Quick Disk (QD) – Load

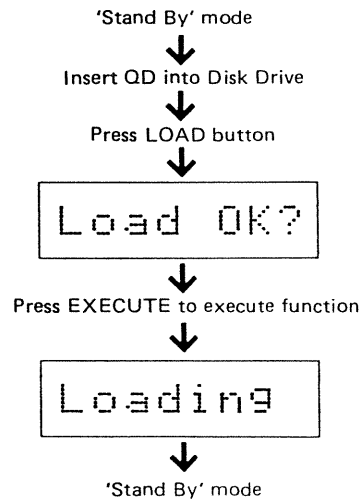

### Quick Disk (QD) – Save

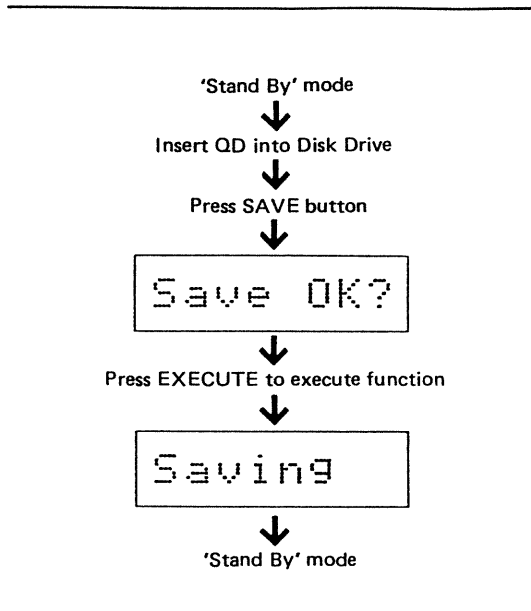

### ADVANCED OPTIONAL MODES

#### a) All Clear

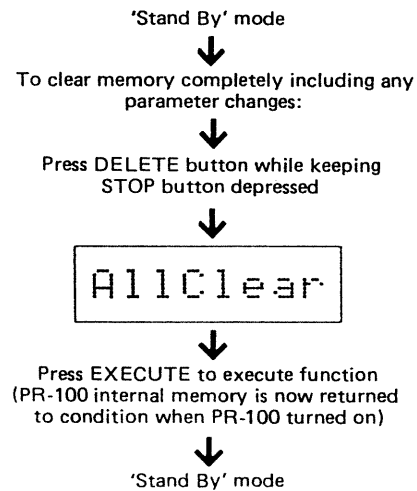

#### b) Memory Consumption

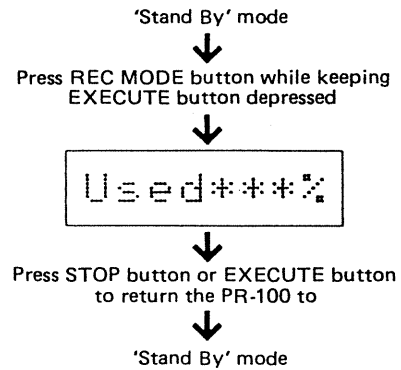

#### c) PAUSE MARK Set

(Maximum PAUSE MARKS is twenty)

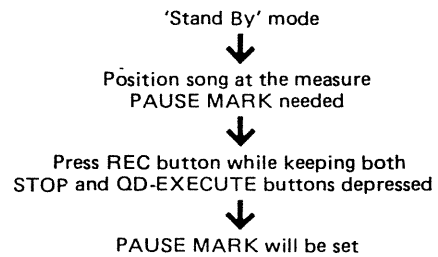

#### d) PAUSE MARK Delete

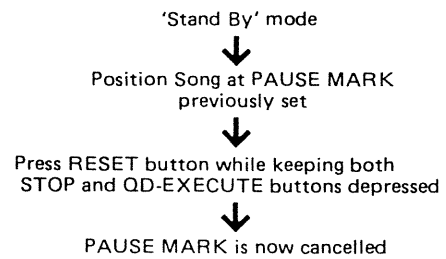

e) Jump to PAUSE MARK

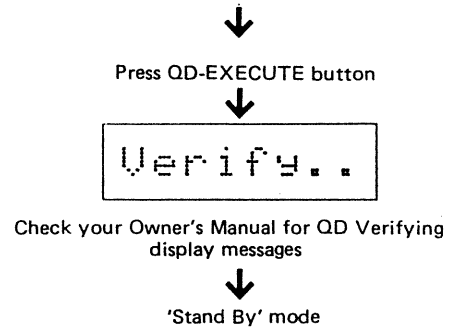
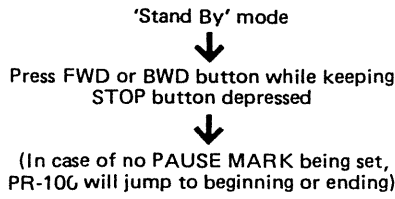

QD OPTIONAL MODES

a) QD-Model Check

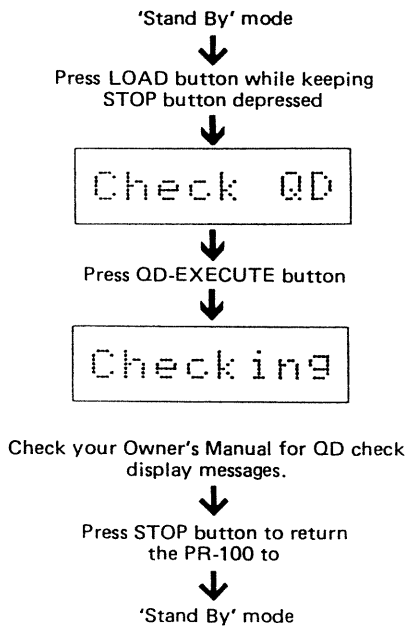

b) QD-Verify

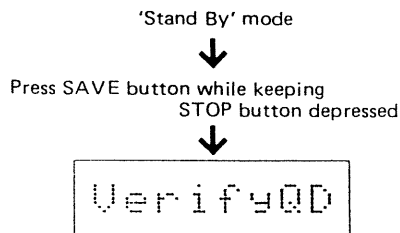

Exchange Tracks and SAVE

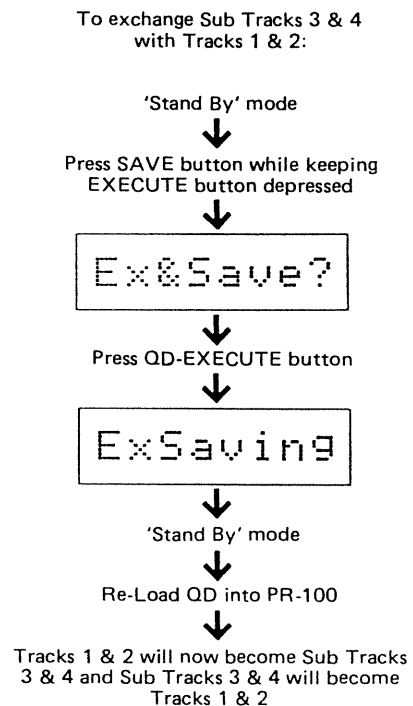

## MIDI CONFIGURATION MEMORY

### a) SOFT THRU

Press BEAT/MEAS button while keeping  
STOP button depressed

THRU OFF

Rotate Alpha-DIAL clockwise to change  
value to

THRU ON

Press EXECUTE button while keeping  
REC button depressed to store change  
permanently

-or-

Press EXECUTE button to store change  
temporarily

### b) SYNC MODE

Press BEAT/MEAS button while keeping  
STOP button depressed

Press FWD button once to change  
parameter to

SYNC INT

Rotate Alpha-DIAL clockwise to change  
value to

SYNC OUT

Press EXECUTE button while keeping  
REC button depressed to store change  
permanently

-or-

Press EXECUTE button to store change  
temporarily

### c) Transmit MIDI Clock

Press BEAT/MEAS button while keeping  
STOP button depressed

Press FWD button twice to change  
parameter to

CLK OFF

Rotate Alpha-DIAL clockwise to change  
value to

CLK ON

Press EXECUTE button while keeping  
REC button depressed to store change  
permanently

-or-

Press EXECUTE button to store change  
temporarily

### d) After-Touch

Press BEAT/MEAS button while keeping  
STOP button depressed

Press FWD button three times to change  
parameter to

AFT ON

Rotate Alpha-DIAL counterclockwise  
to change value to

AFT OFF

Press EXECUTE button while keeping  
REC button depressed to store change  
permanently

-or-

Press EXECUTE button to store change  
temporarily

### e) Pitch Bend

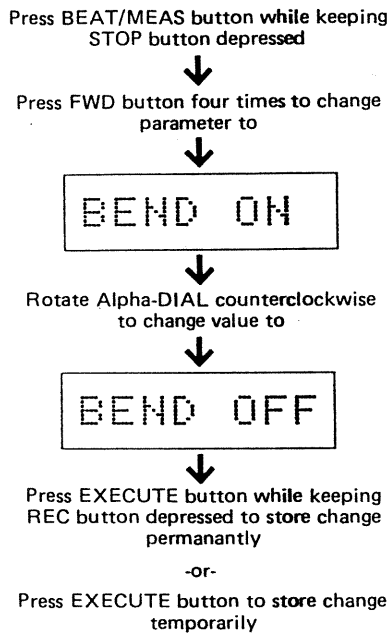

### g) Program Change

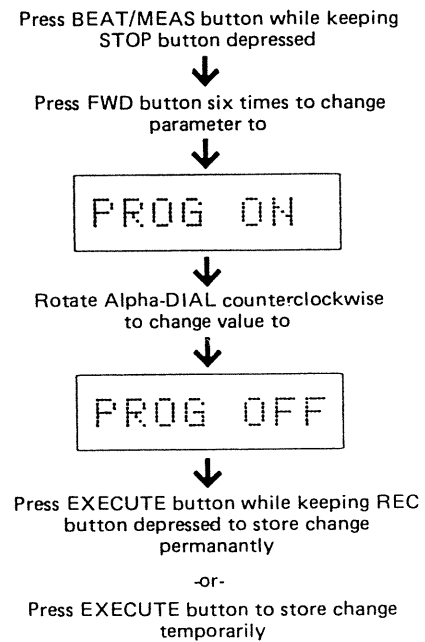

### f) Control Change

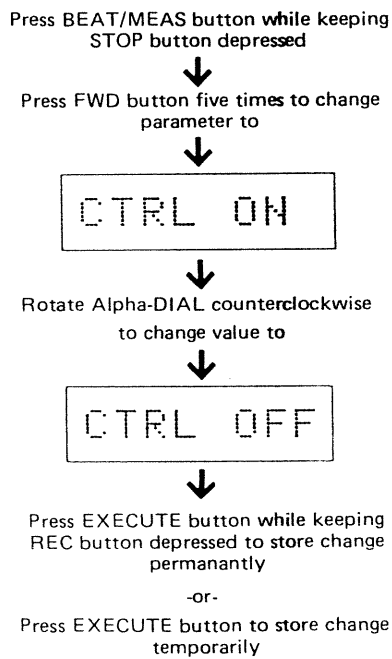

### h) System Exclusive

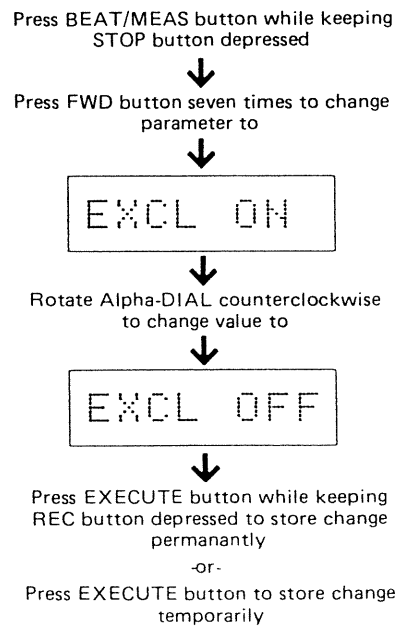

**Summary of MIDI parameters and  
preset ( default ) values**

THRU OFF	(default)	SOFT THRU
SYNC INT	(default)	SYNC MODE
CLK OFF	(default)	Transmit MIDI Clock
AFT ON	(default)	Receive After-Touch (Channel/Keys)
BEND ON	(default)	Receive Pitch Bend
CTRL ON	(default)	Receive Control Change
PROG ON	(default)	Receive Program Change
EXCL ON	(default)	Receive System Exclusive

To change parameters use FWD/BWD button  
To change values: use Alpha-DIAL



For "ON" or "EXT", rotate Alpha-DIAL  
clockwise and for "OFF" or "INT" rotate  
Alpha-DIAL counterclockwise



Press EXECUTE button while keeping  
REC button depressed to store change  
permanently

-or-

Press EXECUTE button to store change  
temporarily

**ERROR MESSAGES**

Error 1	– Main Memory error
Error 2	– MIDI CONFIGURATION MEMORY error
Full	– Overloading the memory capacity in recording
Load ERR	– The QD is totally blank – The QD was once used and loaded on other Roland products – The QD was once used and loaded on other manufacturers – Totally impossible for the Disk Drive to read because of the QD being damaged or faulty
Save ERR	– Accurate saving is not possible
Protect	– The protect tab of the QD is broken off.
Verify ER	– Data in PR-100 does not corre- spond to data on QD when QD-Verify feature has been executed
Mismatch	– In loading the data saved on both sides of a QD, and when the same side of the QD is inserted again or different QD is inserted.
Cannot !	– Impossible to save data onto the QD because of protection
Ejected !	– QD is ejected under loading or saving conditions
Check ERR	– The QD is totally blank – The QD was once used and loaded on other Roland products – The QD was once used and loaded on other manufacturers

For a complete tour of the Roland PR-100 Digital Sequencer and its unique  
features, please refer to your Owner's Manual.





