

KORG

POLY-800

*PROGRAMMABLE
POLYPHONIC SYNTHESIZER*

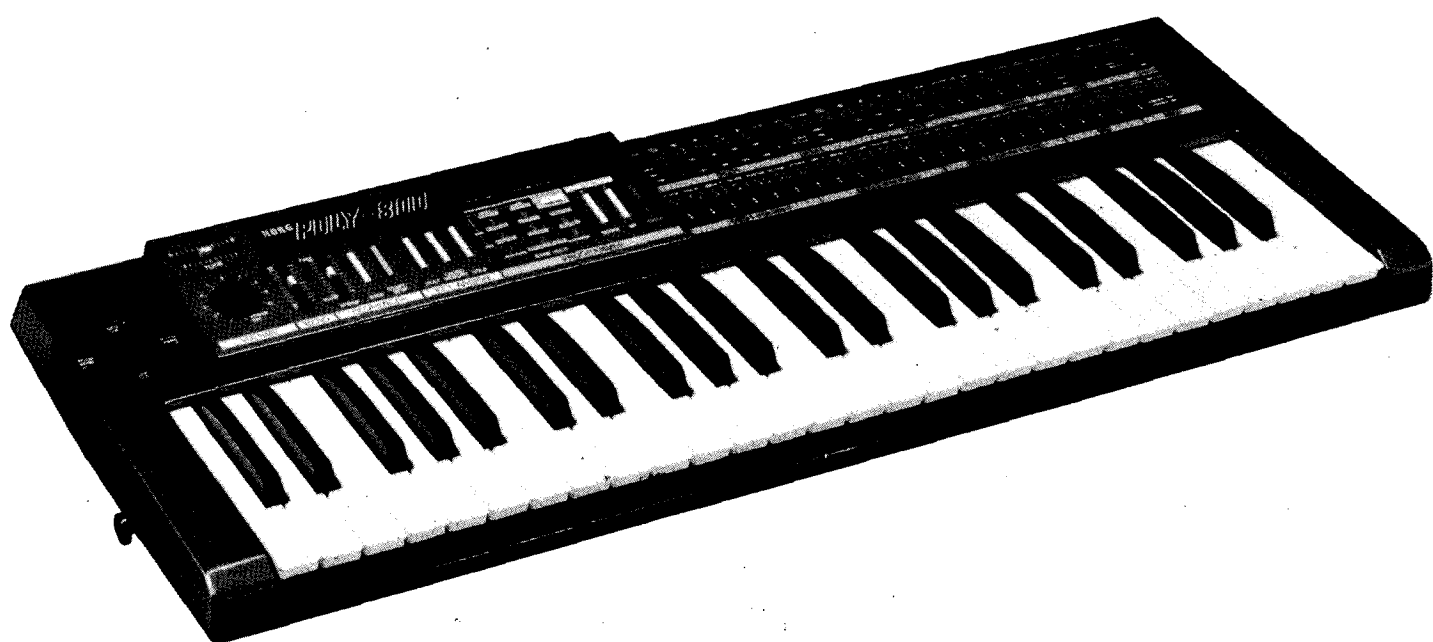

@ £1-95
N10

OWNER'S MANUAL

KORG PROGRAMMABLE POLYPHONIC SYNTHESIZER

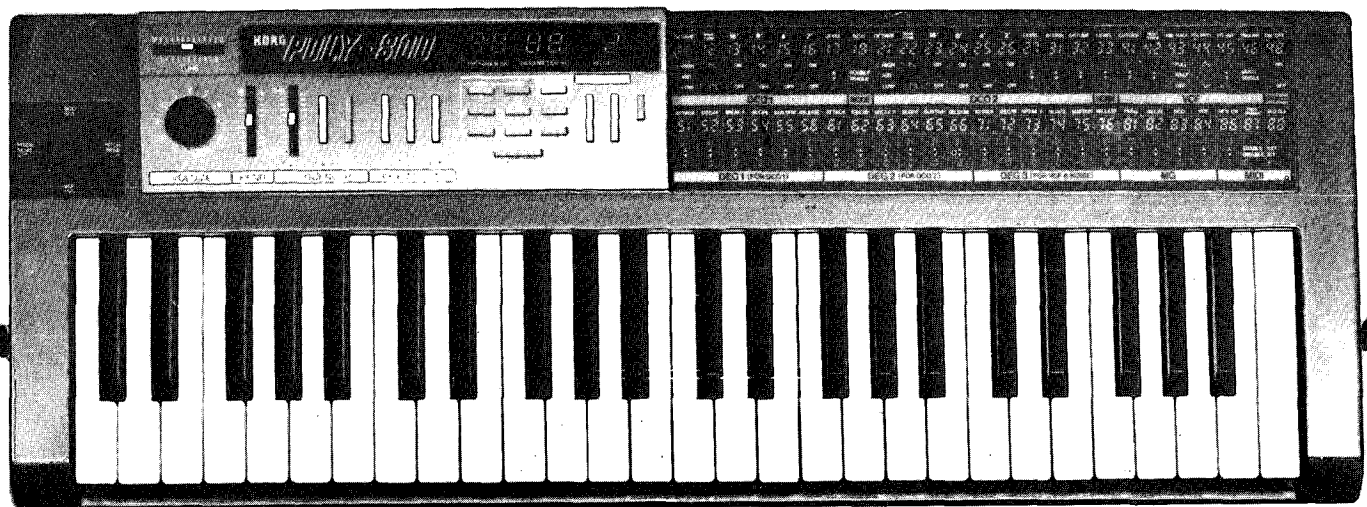

Thank you and congratulations on your choice of the KORG Poly-800. This instrument has been engineered for highest quality sounds and superb reliability. To obtain optimum performance from your new KORG Poly-800, please read this manual carefully before using.

FEATURES OF THE KORG

POLY-800

1. EIGHT SEPARATELY-ARTICULATED "VOICES" offer full polyphonic capabilities.
2. EIGHT DIGITAL-CONTROLLED OSCILLATORS (DCOs) ensure outstanding pitch stability.
3. NINE ADVANCED 6-STAGE DIGITAL ENVELOPE GENERATORS (DEGs) — 1 per DCO and 1 for Noise and VCF — provide a significant improvement over conventional EGs. They help create highly realistic piano/percussive sounds and many new effects.
4. "DOUBLE" playing mode provides rich, complex layered sounds by pairing two different DCOs and DEGs per voice. "WHOLE" mode provides full eight-note playing capability.
5. 64 DIFFERENT PROGRAMS offer a wide range of excellent sounds.
6. STEREO CHORUS provides smooth, warm ambience.
7. Built-in POLYPHONIC SEQUENCER stores and performs up to 256 notes. It can be started, stopped, and remotely clocked using standard MIDI signals.
8. MUSICAL INSTRUMENT DIGITAL INTERFACE (MIDI) bus sends and receives key data (pitches and gates), pitch bends, program changes, and full sequencer control.
 - MIDI allows a Poly-800 to be linked with a second Poly-800 or another MIDI keyboard for rich layering effects.
 - A MIDI compatible home computer (or similar equipment) connected to a Poly-800 can provide extended polyphonic sequencing, music transcription, and many other functions, with suitable software.
9. DIGITAL ACCESS CONTROL provides precise push button control over every program parameter, for creating and editing programs.
 - A large 6 digit LED Display offers complete data readout.
 - Full editing capabilities allow memorized sound programs to be easily changed, temporarily or permanently.
 - PROGRAM UP jack lets you change programs in sequence without taking your hands off the keyboard.
 - The Digital Access system provides accurate sound recall, excellent repeatability, and a minimum of front panel "clutter".
10. New "BANK HOLD" function allows quick single-button access to programs or parameters within the same bank.
11. CHORD MEMORY lets you play parallel harmonies using only 1 key, and also provides monophonic bass and solo articulation. HOLD mode provides sustained "Hands-Off" sound. POLY mode provides normal four and eight voice playing.
12. 14 SECOND TAPE INTERFACE allows many sets of PROGRAMS and SEQUENCER data to be rapidly saved or loaded from cassette. The large, prompting alphanumeric display gives complete information about tape operations. Operation is so fast and easy that all 64 programs can be changed live between songs.
13. NOISE GENERATOR adds "breath noise" for more realistic instrument sound and also can be used for many kinds of special effects.
14. Lightweight (10 lb.), battery/AC operated package can be worn on stage (using built-in strap pegs), or moved and played ANYWHERE.
 - The Poly-800 and a good quality "wireless" transmitter allows you total on-stage mobility ... a first for a programmable polyphonic synthesizer!

TABLE OF CONTENTS

• IMPORTANT NOTES	5
• FRONT PANEL NOMENCLATURE	6
• REAR PANEL NOMENCLATURE	8
• BASIC CONNECTIONS	10
• FUNCTION AND OPERATIONS	11
1. INITIAL SETUP	11
2. SELECTING PROGRAMS	11
3. SOUND SYNTHESIS	13
3-1 What is a Synthesizer	13
3-2 What is a Program	13
3-3 Digital access control system	13
3-4 Poly-800 Synthesizer Modules and Parameters	14
3.4.1. DCO 1	14
3.4.2. MODE	15
3.4.3. DCO 2	16
3.4.4. NOISE	16
3.4.5. VCF	17
3.4.6. CHORUS	18
3.4.7. DEG	19
3.4.8. MG	21
3.4.9. MIDI	21
4. CREATING SOUNDS	23
4-1 Overview	23
4-2 Editing programs	23
4-3 Writing programs to memory	25
4-4 Moving programs	26
5. PERFORMANCE FEATURES	28
5-1 Tune	28
5-2 Joystick	28
5-3 Key assign mode	28
5-4 Sequencer	29
5-5 Program Up Footswitch	32
6. MUSICAL INSTRUMENT DIGITAL INTERFACE (MIDI)	33
7. TAPE INTERFACE	35
7-1 Saving program and sequencer data on tape	35
7-2 Recorded data tones	36
7-3 Verify	36
7-4 Loading data into the Poly-800	38
8. POWER SUPPLY	40
8-1 Battery life	40
8-2 Replacing batteries	40
• SPECIFICATIONS	41
• OPTIONS	42

IMPORTANT NOTES

To ensure long life for the Poly-800, the following precautions should be taken:

LOCATION:

To avoid malfunction, do not use or leave the Poly-800 in the following locations for long periods of time:

- In direct sunlight.
- In extremely high or low temperature or humidity.
- In dusty or sandy places.

MUSICAL INSTRUMENT - HANDLE WITH CARE!

- The Poly-800 may malfunction if excessive force is applied to the switches and/or knobs or if it is dropped.

CLEANING:

- Use only a soft dry cloth to clean the surface of the Poly-800. NEVER use benzene, thinners or similar solvents.

INTERFERENCE FROM OTHER ELECTRICAL APPLIANCES

The Poly-800 uses advanced digital circuitry which may occasionally malfunction due to interference produced by fluorescent lamps, other digital equipment, or electrical appliances with built-in motors. We recommend that you use the Poly-800 as far as possible from such appliances. If any irregularities occur, turn the power switch off, wait about 30 seconds, then turn the power on again. This should help return the Poly-800 to its normal operating condition.

MEMORY BACKUP

- Sound and sequencer program data stored in Poly-800 memory are protected by a built-in battery powered circuit so that they will not be lost or erased when power is turned off. Under normal conditions (0 ~ 40°C) the battery will protect memory for more than five years from the date of manufacture. If you find that memory contents are lost after turning off the power and then turning it on again, please contact your nearest KORG dealer distributor or service center.
- The Poly-800's TAPE INTERFACE SYSTEM is an excellent safeguard against loss of memory. In addition to providing access to virtually unlimited programs, you may easily reload memory (should it become erased) using the Tape Interface system and the supplied Program Data Tape. It's always a good idea to Save any original programs on tape to protect them against accidental loss.

WARRANTEE

The Poly-800 is warranted by the manufacturer against defects in materials or workmanship. The specific conditions and terms of the warrantee are listed on the enclosed warrantee registration card.

INSTRUCTIONS

To obtain the best possible results from your Poly-800, please read this manual carefully. Keep your Owner's Manual in a safe place for future reference.

"NOTICE"

Because the Poly-800's case is constructed of a light weight, high impact "ABS" material, it's possible for electrostatic discharges to occur which may cause a temporary malfunction. Connecting the unit to an amplifier, mixer etc. (to provide a proper ground connection) BEFORE turning the power on will help ensure reliable operation.

FRONT PANEL NOMENCLATURE

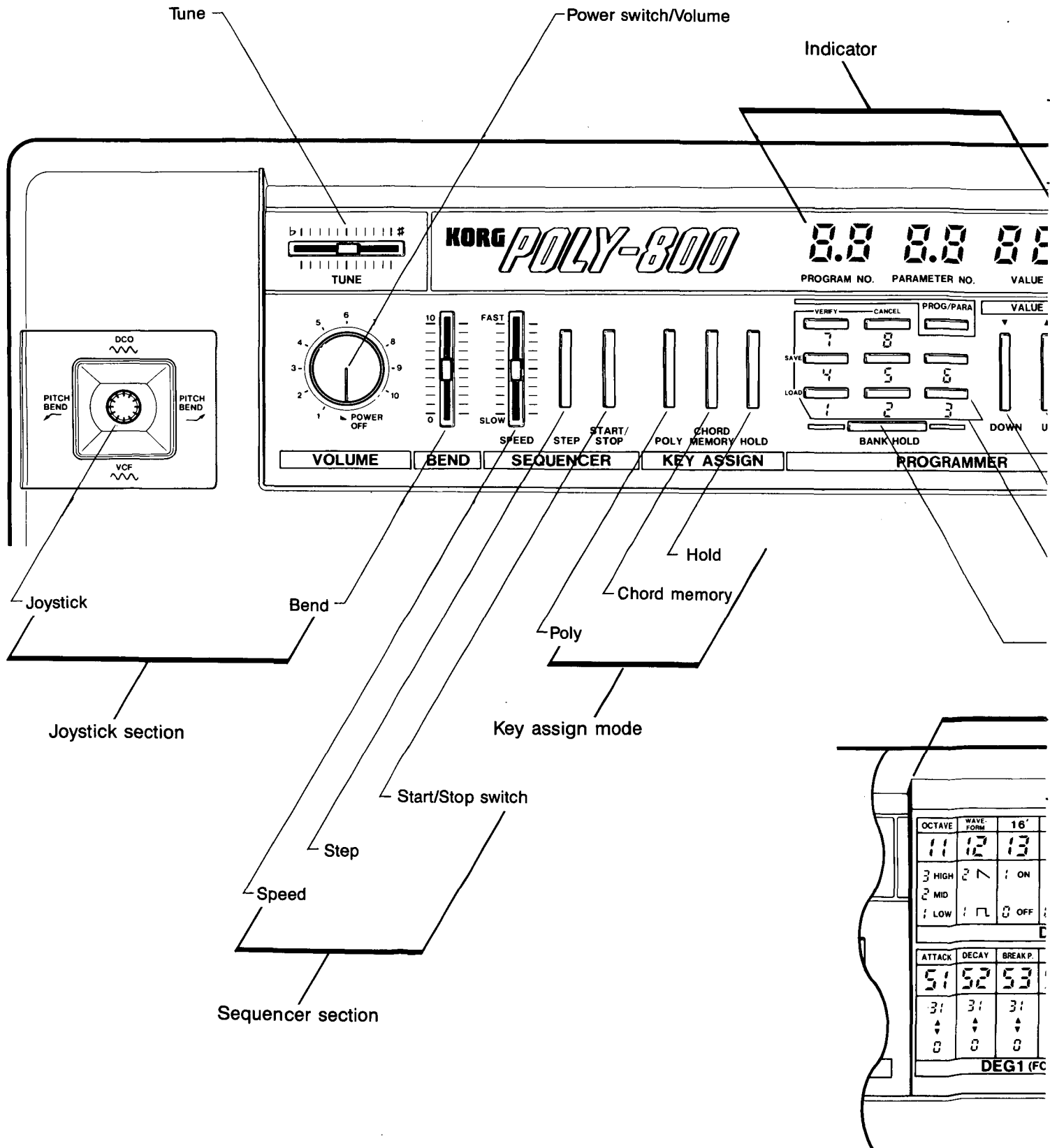

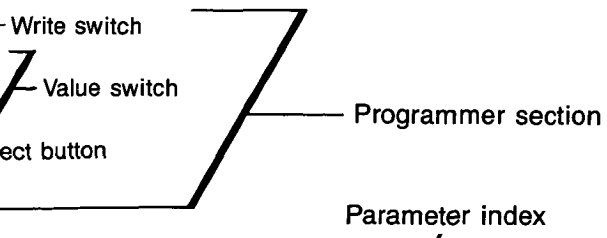
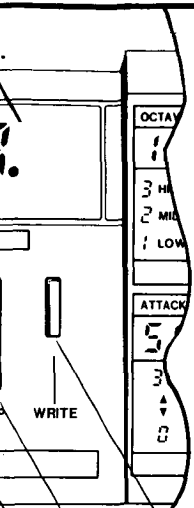
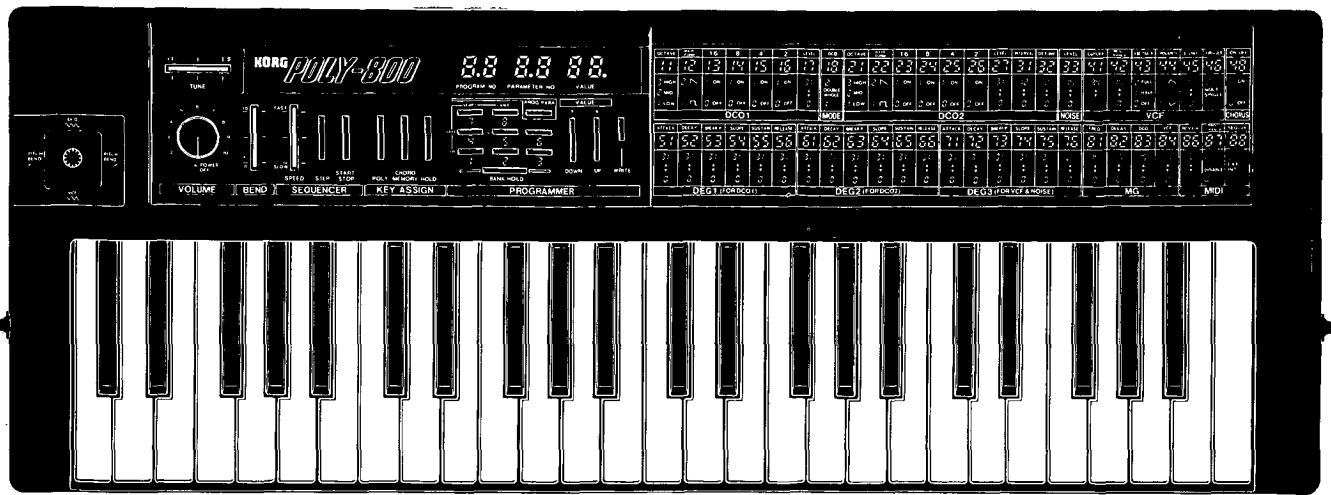

8'	4'	2'	LEVEL	DCO	OCTAVE	WAVE-FORM	16'	8'	4'	2'	LEVEL	INTERVAL	DETUNE	LEVEL	CUTOFF	RESONANCE	KBD TRACK	POLARITY	EG INT	TRIGGER	ON/OFF
14	15	16	17	18	21	22	23	24	25	26	27	31	32	33	41	42	43	44	45	46	48
ON	ON	ON	31	2	3 HIGH	2 ^	ON	ON	ON	ON	31	12	3	15	99	15	2 FULL	2 ^	15	2	ON
OFF	OFF	OFF	0	1	2 MID	1 v	OFF	OFF	OFF	OFF	0	0	0	0	0	0	1 HALF	1 v	0	1	OFF
CO1				MODE	DCO2								NOISE	VCF				CHORUS			
SLOPE	SUSTAIN	RELEASE	ATTACK	DECAY	BREAK P.	SLOPE	SUSTAIN	RELEASE	ATTACK	DECAY	BREAK P.	SLOPE	SUSTAIN	RELEASE	FREQ	DELAY	DCO	VCF	RCV CH	PROG CHANGE	SEQ CLK
54	55	56	61	62	63	64	65	66	71	72	73	74	75	76	81	82	83	84	86	87	88
31	31	31	31	31	31	31	31	31	31	31	31	31	31	31	15	15	15	15	15	1	2
0	0	0	0	0	0	0	0	0	0	0	0	0	0	0	0	0	0	0	0	0	1
RDC01				DEG2 (FOR DCO2)								DEG3 (FOR VCF & NOISE)				MG		MIDI			

REAR PANEL NOMENCLATURE

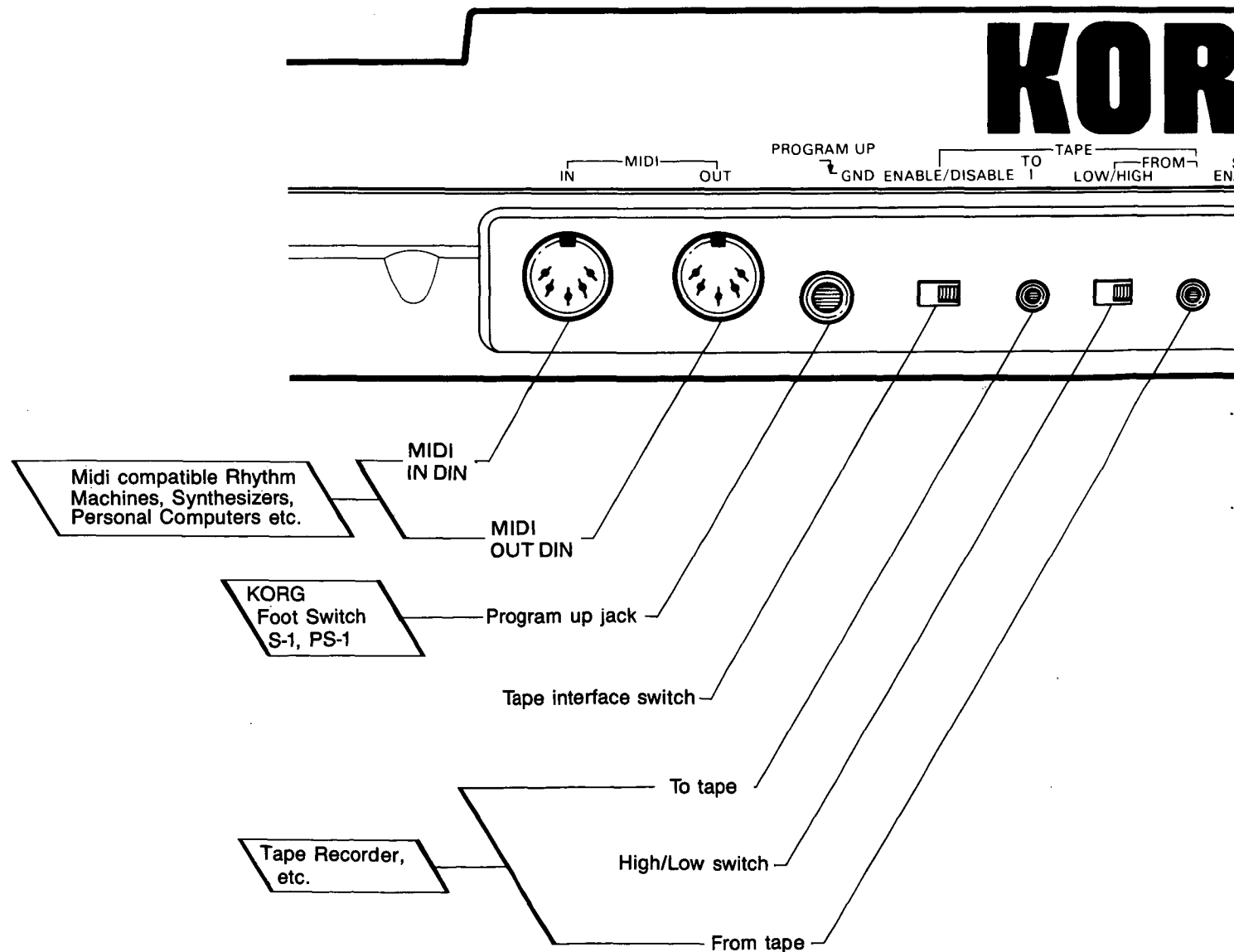
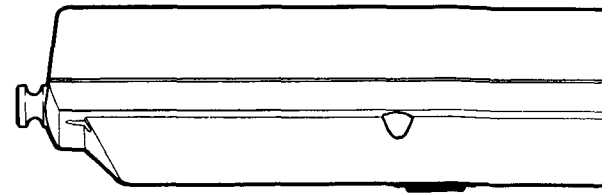

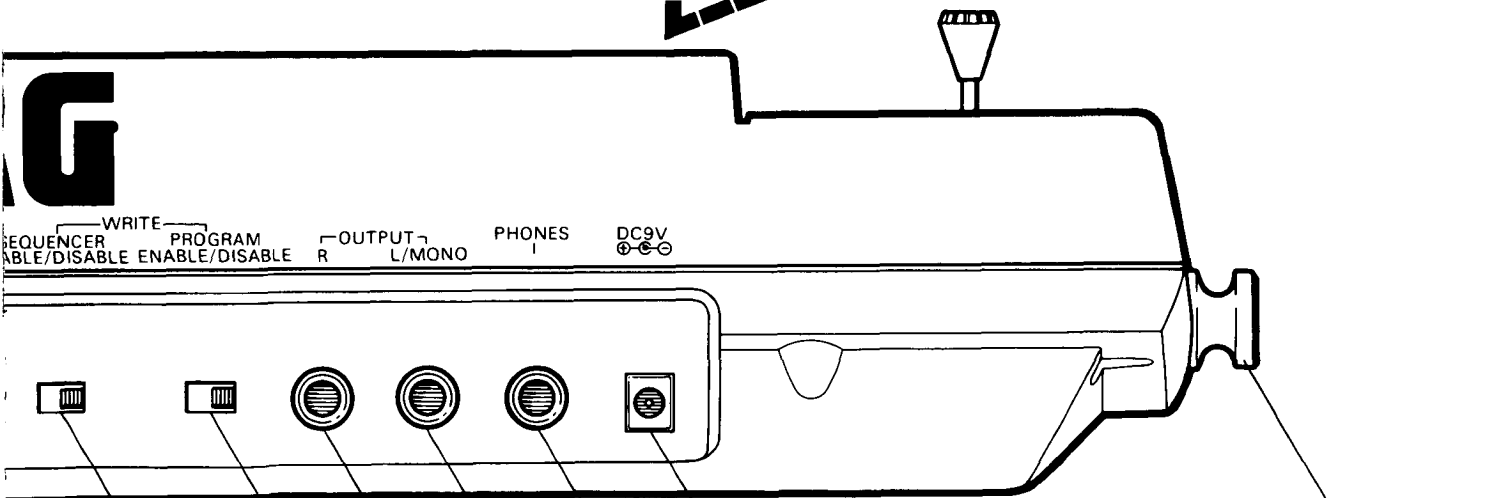
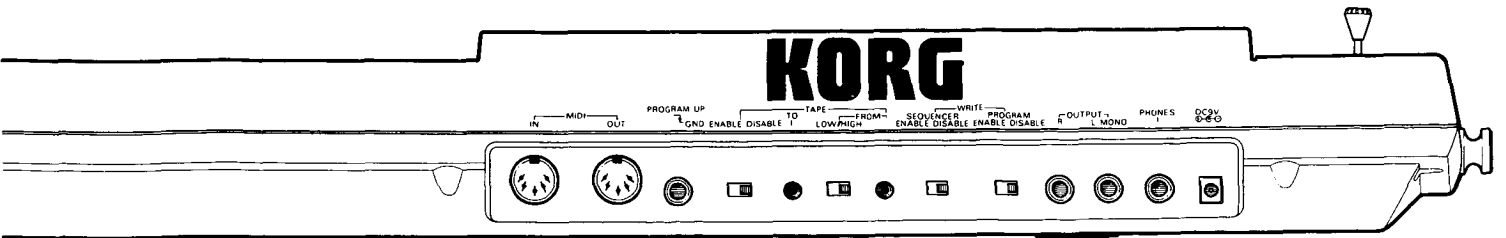

Strap peg

AC adaptor jack

Headphone jack

Stereo Headphones

Output (L/Mono)

Output (R)

SDD-3000 etc.
SD-400

KMX-8 etc.
MM-25

Program write switch

Sequencer write switch

BASIC CONNECTIONS

1. Make sure that the Power Switch is turned off (VOLUME control fully counterclockwise).

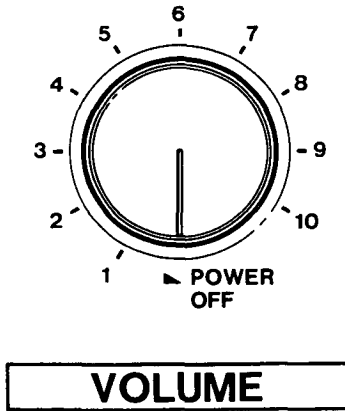

2. Either batteries or the supplied AC adaptor can be used as the main power source.

- When using an AC adaptor, use only the supplied KORG 9V AC adaptor (designed to be used with local voltage) to avoid possible damage.
- Connect the AC adaptor to the Poly-800 rear panel DC 9V jack, and then plug the AC Adaptor into an AC wall socket.

3. When using an amplifier or mixer, connect the Poly-800 rear panel output jack(s) to the amplifier or mixer input jack(s).

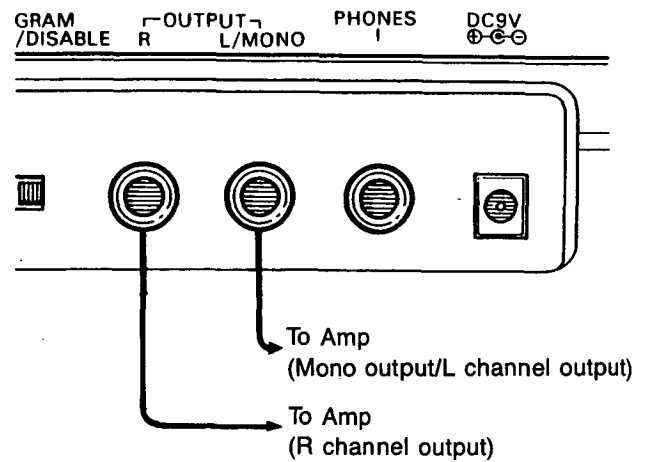

4. When using headphones:

- Plug headphones into PHONES jack.

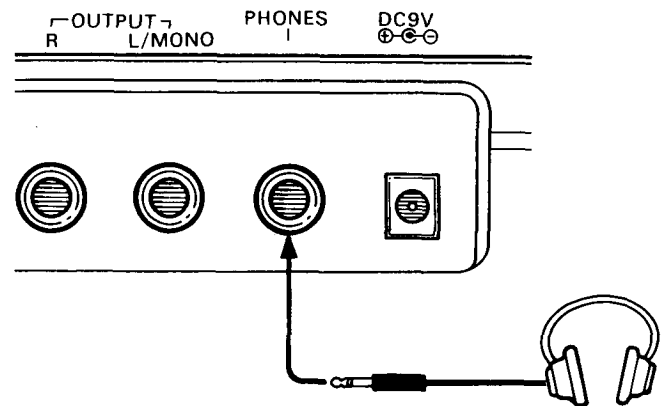

FUNCTION AND OPERATIONS

1. INITIAL SETUP

When setting up the Poly-800, please follow the procedure below.

1. Make sure that everything is properly connected as described in Basic Connections, with all power turned OFF.
2. Set the Program and Sequencer WRITE switches and the TAPE switch (on the rear panel) to the DISABLE position.

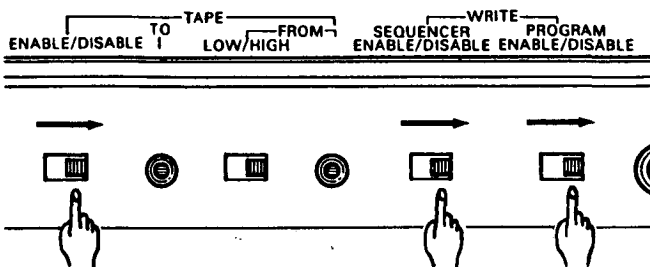

3. Turn on the power switch. (If you are using an amplifier, turn the amp Volume all the way down BEFORE turning on the power.) The front panel LED Display will display the following message:

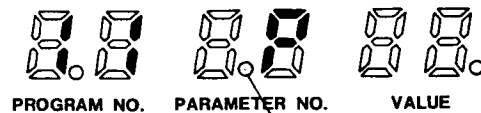

This dot lights up in DOUBLE MODE (4 Voices)

4. If you are using an amplifier, first set the amplifier Volume to a suitable position, and then adjust the Poly-800 VOLUME control for the desired level. If the sound becomes harsh or distorted, turn down the Poly-800 VOLUME and/or the amp Volume.

2. SELECTING PROGRAMS

Any of the 64 different sounds programmed into the Poly-800's memory may be instantly selected. Each program location is identified by a two digit "Program Number", which is used whenever a program is stored, recalled or moved from one location (Program Number) to another.

(1) Program Numbers

A program number is a two digit number ranging from 11 to 88 (the digits 0 and 9 are not used). The first digit indicates the Program "Bank", and the second number indicates the individual program WITHIN that Program Bank. For example, Program Number 36 would be program #6 in bank 3. The 64 program locations are arranged in 8 banks or groups of 8 programs each:

Program numbers	Number of programs	Total
11 ~ 18	8	64
21 ~ 28	8	
31 ~ 38	8	
41 ~ 48	8	
51 ~ 58	8	
61 ~ 68	8	
71 ~ 78	8	
81 ~ 88	8	

(2) Selecting Programs

When the Power switch is turned on, the LED Display shows the following:

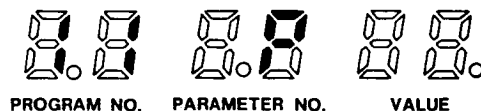

The display indicates Program Number "11" and the "POLY" mode, the normal playing mode, have been selected.

NOTE:

The eight number buttons are used both to SELECT PROGRAMS and to SELECT PARAMETERS within a program. When the Poly-800 is turned on, Program Select mode is automatically chosen (only three characters shown in the Display). The PROG/PARA button is used to switch between the two modes.

IF ALL 6 DIGITS ARE DISPLAYED, YOU ARE IN PARAMETER MODE AND SHOULD PRESS THE "PROG/ PARA" BUTTON BEFORE SELECTING A NEW PROGRAM.

Now try selecting a different program.

1. Select any number from 11 to 88.

Examples: Selecting program number 23.

Press the Number Select Button 2, and the indicator will display the following;

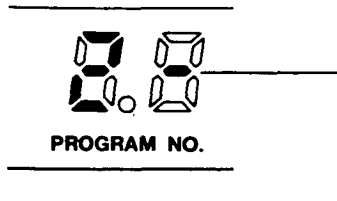

The dash in the right hand digit position means that the Poly-800 is waiting for you to select the second digit. (The old program will sound until the second digit is entered.)

NOTE:

If the first digit was selected incorrectly, just press the desired Number Select Button (2 in the example) twice so that the correct Program Number appears in the left-hand digit position. Then enter the correct second digit to finish selecting the desired program.

2. Press the Number Select Button 3 to select the second digit, and make sure that the DISPLAY shows 23. You can now play Program 23.



3. Try selecting and listening to any of the 64 pre-programmed factory programs, in any order you like. You'll find that with a little practice you can select any desired program very quickly. The Bank Hold features, described below, makes program selection even easier in live performance situations.

(3) Bank Hold

The Bank Hold feature allows the current Program Bank Number (left-most digit) to be "held". This enables you to select any of the eight programs in that bank with a single press of a button, for the fastest possible program access.

EXAMPLE: Selecting Bank 2

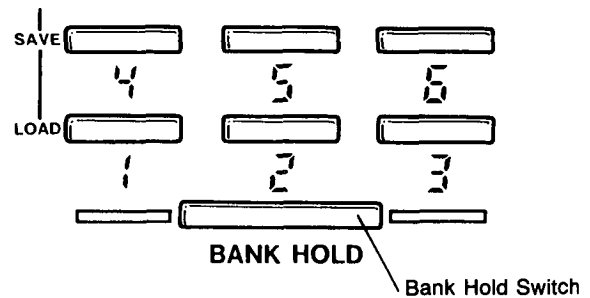

Select any program between 21 and 28 (or simply press " 2 ") and then press Bank Hold. The DISPLAY will show the following:

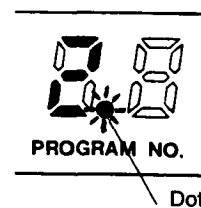

You may now select any of the eight programs from 21 to 28 by simply pressing a single digit between " 1 " and " 8 ". As long as the small LED dot next to the Bank digit is lit, you can ONLY select programs between 21 and 28.

To change Banks, or cancel the Bank Hold function, simply press the Bank Hold switch again. The small LED dot will go out, and the regular two-digit selection mode will be restored.

(4) Program Up

The PROGRAM UP jack (connected to an optional footswitch) allows you to change programs in sequence without taking your hands off the Keyboard. This jack accepts "switch triggers" from a footswitch or other external source.

3. SOUND SYNTHESIS

3.1 What is a Synthesizer

A synthesizer is a set of modules or "building blocks" that can be used together to create many different types of sounds. In all synthesizers, there are three basic types of modules: sound SOURCES, sound MODIFIERS, and sound CONTROLLERS.

The basic sound SOURCES used in the Poly-800 are eight Digital Controlled Oscillators (DCOs). The DCOs produce the actual pitches, and the selected DCO WAVEFORM (and selection of 2', 4' Harmonics etc.) has a large effect on the tonal quality (timbre) of the sound. A NOISE source is also provided.

The sound MODIFIERS for the Poly-800 are the Voltage Controlled Amplifiers (VCAs), the Voltage Controlled Filter (VCF), and the Stereo Chorus. Sound modifiers take the basic sound produced by the sound sources and shape or "fine tune" the sound into its final form — what you actually hear.

- The VCF modifies the blend of overtones (and brightness) in the sound.
- The VCAs control the changes in volume level which provide individual note articulation ... how each note attacks, decays, etc.
- The Stereo Chorus provides extra warmth and "thickness" for almost any sound.

The sound CONTROLLERS don't produce or modify any sounds directly — they tell the sources and modifiers what to do. Controllers in the Poly-800 include the Keyboard and Key Assigner, advanced 6-stage Envelope Generators, Modulation Generator, Programmer, Joystick and MIDI Interface.

Without controllers, there would be no way of coordinating the different modules in the synthesizer to produce useful sounds.

MIDI (Musical Instrument Digital Interface) is actually an EXTERNAL Controller, which allows different instruments and equipment to be coordinated for a wide range of new possibilities.

3.2 What is a Program

Each of the sources, modifiers and controllers described above have several PARAMETERS (variable settings such as Waveform, Cutoff, Attack Time, etc.).

A "Program" is the particular collection of Parameter settings that results in a specific desired sound.

3.3 Digital Access Control System

On many synthesizers, knobs must be turned to adjust the Parameters, and it's hard to tell what the exact values are — especially when you're editing an existing program, the most common way of creating new programs.

On the Poly-800, each parameter and its value are expressed by a pair of numbers:

- The PARAMETER NUMBER (middle two digits of the six digit DISPLAY) identifies a particular Parameter, which is like a single control knob on other synthesizers (Filter Cutoff, for example, is Parameter 41 on the Poly-800).
- The VALUE (righthand two digits) is like the current setting of that control knob, or Parameter (e.g., Filter Cutoff can have a Value between 0 and 99).

The eight Number Buttons (also used for Program Selection), UP and DOWN buttons and large LED Display make it easy to adjust and DOWN button and LED Display make it easy to adjust each program parameter precisely for the exact desired result. To change any aspect of a programmed sound, you simply:

- select a Parameter Number
- adjust its Value, using the UP and DOWN buttons
- repeat above to change other Parameters, as needed.

Further information is given in the section on "Creating Sounds".

Name of Parameter	OCTAVE	WAVE-FORM	16'	8'	4'	2'	LEVEL
Parameter number	11	12	13	14	15	16	17
Value	3 HIGH	2 N	1 ON	1 ON	1 ON	1 ON	31
	2 MID						▲
	1 LOW	1 FL	0 OFF	0 OFF	0 OFF	0 OFF	0
Section	DCO1						



3.4 POLY-800 SYNTHESIZER MODULES AND PARAMETERS

3.4.1 DCO 1

The basic sound sources of the Poly-800 are the eight Digitally Controlled Oscillators (DCOs), which offer precise frequency tuning and stability through the use of advanced integrated digital technology.

The Poly-800 DCOs operate on a principle of additive squarwave synthesis. Different waveforms are created by adding together, in different proportions, up to four squarewave Harmonics at octave intervals, from 16' to 2' (a four octave range.)

Each DCO then is separately articulated by its own 6-stage Digital Envelope Generator, which allows very complex and interesting sounds to be created, especially when two DCOs are combined per voice in DOUBLE Mode.

OCTAVE	WAVE-FORM	16'	8'	4'	2'	LEVEL
11	12	13	14	15	16	17
3 HIGH	2 	1 ON	1 ON	1 ON	1 ON	31
2 MID	1 	0 OFF	0 OFF	0 OFF	0 OFF	0
1 LOW						
DCO1						

PARAMETER NAMES AND FUNCTIONS



11 OCTAVE

Determines the basic pitch range over a three octave range (High, Middle, Low). By choosing different combinations of the Octave and Harmonics parameters, you can select a basic pitch range from 1' (highest) to 32' (lowest).

OCTAVE	VALUE
HIGH	3
MID	2
LOW	1

12 WAVEFORM

The Waveform parameter works together with the 16' - 2' Harmonics parameters (see below) to determine the basic tonal quality (timbre) of the oscillator. The Harmonics parameters turn each squarewave Harmonic ON and OFF. The Waveform parameter selects the actual LEVELS of the individual squarewave Harmonics which are added together to create the final waveform.

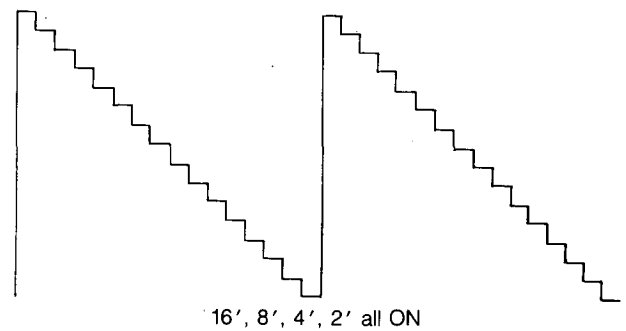
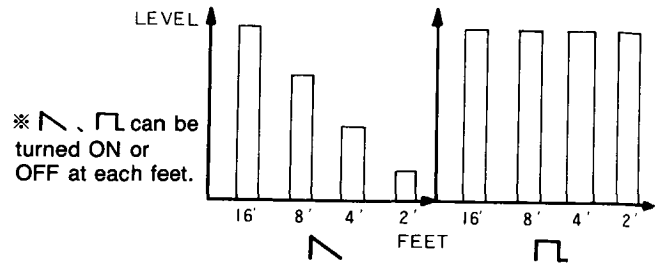

The Poly-800 provides a choice of two waveforms (harmonic levels): Squarewave () at Value 1, and Sawtooth () at Value 2.

• With a Waveform Value of 1, all of the squarewave Harmonics (that are turned ON) are added together at equal volume:

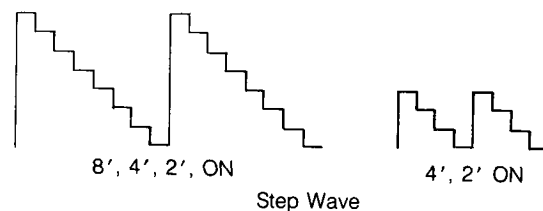

• With a Waveform Value of 2, each Harmonic (that is turned ON) is combined with a different relative volume (16' is loudest, 2' is softest):



WAVEFORM	VALUE
	2
	1

13 ~ 16 HARMONICS (16' 8' 4' 2')

The Harmonics parameters turn any combination of individual squarewave harmonics on and off, regardless of the Waveform Parameter Value. This allows a wide variety of different waveforms to be created. For example, you could add together just the

16' and 4' harmonics, at either the same level (Square Waveform), or with the 16' harmonic 3 times louder than the 4' harmonic (Sawtooth Waveform).

- When a Square Waveform is selected (Value of 1), and any single ONE of the Harmonics parameters is ON, a regular square wave is produced at the selected pitch range.

* Combining TWO OR MORE of the Harmonics with the Square Waveform selected produces octave doubling "effects."

- When the Waveform Value is 2, and ALL of the 16' - 2' Harmonics are turned ON, the DCO waveform will be a close approximation of a sawtooth waveform.

16'	8'	4'	2'	LEVEL
ON	ON	ON	ON	1
OFF	OFF	OFF	OFF	0

* With all Harmonics turned ON, the basic pitch range will be selected by the Octave parameter (11). However, several types of modified sawtooth waveforms are available by turning OFF 1 or 2 of the higher Harmonics, and higher-pitched sawtooths are available by turning OFF the 16' or 16' & 8' Harmonics.

17 LEVEL

The maximum level of DCO 1 can be adjusted over a range of 0 (off) to 31 (full). This is useful both for adjusting the overall volume to match other programs, and for balancing DCO 1 and DCO 2 in Double Mode.

LEVEL	VALUE
MAXIMUM	31
↓	↓
MINIMUM	0

NOTE:
 Since each DCO is articulated by its own Digital Envelope Generator, the LEVEL parameter actually determines how loud the DCO will be when the DEG reaches its Attack peak.

3.4.2 MODE

The DCO MODE parameter determines the basic architecture of the Poly-800:

- WHOLE Mode 8 individual voices with 1 DCO and 1 DEG per voice. (LED Dot OFF)
- DOUBLE Mode 4 individual voices with 2 DCOs and 2 DEGs per voice. (LED Dot ON)

The LED Dot next to the Key Assign Mode Display always shows whether the currently selected Program is in WHOLE Mode or DOUBLE Mode:

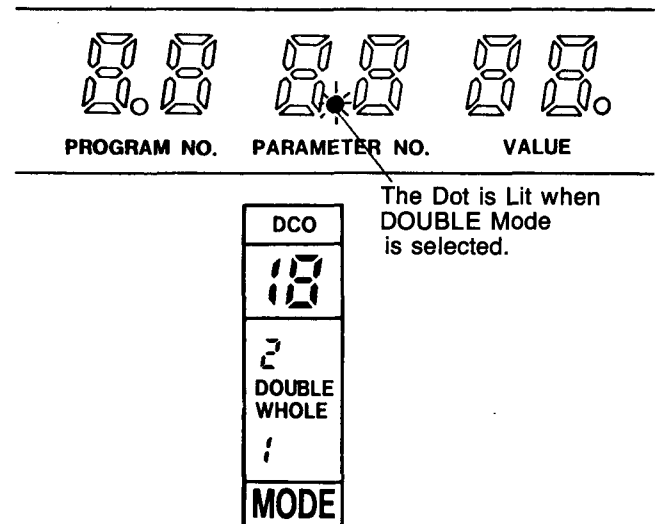

In WHOLE Mode, all 8 DCOs are controlled by the DCO 1 Parameters (11 - 17), and the 8 related DEGs are all controlled by the DEG 1 Parameters (51 - 58).

Trying to access any DCO 2 or DEG 2 Parameters (21 - 32 and 61 - 68) will produce a blank readout in the Value display, to show that they are not currently being used. However, the previous values of these parameters are still saved in memory, and will be available again when DOUBLE Mode is selected.

In DOUBLE Mode, 4 DCOs and DEGs are controlled by the DCO 1 and DEG 1 parameters, and the other 4 DCOs and DEGs are controlled by the DCO 2 and DEG 2 parameters. Exceptionally dynamic and realistic sounds result from using a SEPARATELY programmed 6-stage Digital Envelope Generator to control EACH of the two DCOs that are "layered" together for each note.)

MODE	VALUE
DOUBLE (4 Voices)	2
WHOLE (8 Voices)	1

3.4.3 DCO 2 (DOUBLE Mode only)

DCO 2 can be combined with DCO 1 to produce a wide variety of warm, thick sounds. The DCO 2 parameters are only active in DOUBLE Mode (see description of MODE Parameter, above).

OCTAVE	WAVE-FORM	16'	8'	4'	2'	LEVEL	INTERVAL	DETUNE
21	22	23	24	25	26	27	31	32
3 HIGH	2	1 ON	1 ON	1 ON	1 ON	31	12	3
2 MID								
1 LOW	1	0 OFF	0 OFF	0 OFF	0 OFF	0	0	0
DCO2								

PARAMETER NAMES AND FUNCTIONS

21 OCTAVE

Similar to DCO 1. The three octave range includes High, Middle and Low.

22 WAVEFORM

Similar to DCO 1. There is a choice of square wave () , or sawtooth () .

23-26 HARMONICS (16' 8' 4' 2')

Similar to DCO 1. Each of the four squarewave harmonics may be individually turned ON or OFF.

#27 LEVEL

Similar to DCO 1. DCO 2 is controlled by DEG 2, not by DEG 1.

LEVEL	VALUE
Max.	31
↑	↑
Min.	0

31 INTERVAL

The pitch of DCO 2 may be transposed or "offset" so that it sounds at a constant interval above DCO 1. The range of this parameter is a full octave in semitone steps (0-12).

- When Interval Value equals 0, DCO 1 and DCO 2 are in Unison. When the Value equals 7, DCO 2 will be a perfect 5th (7 semitones) above DCO 1.

- With a Value of 12, DCO 2 will be an octave higher than DCO 1. This is useful for extending the range of the Keyboard, or for tuning the two DCOs to be three octaves apart.

INTERVAL	VALUE
1 Octave	12
↓	↓
Perfect Dominant	0

NOTE:

The Octave and Harmonics parameters also affect the relative tuning of the DCOs. For example, if Interval equals 7 but DCO 1 Octave equals 'Low' and DCO 2 Octave equals 'Middle', then DCO 2 will actually be a perfect 4th BELOW DCO 1, not a perfect 5th above DCO 1. This would also happen if both DCOs were set to the same Octave, but the DCO 1 16' Harmonic was turned OFF.

32 DETUNE

The Detune parameter provides fine pitch adjustment of DCO 2 relative to DCO 1. Detuning DCO 2 creates a 'fatter' sound because of the slight pitch differences between the two oscillators.

- Detune Values can range from '0' (no detuning) to '3' (full detuning).

DETUNE	VALUE
Pitch difference from DCO 1	3
Max.	↑
↓	↓
Same pitch as DCO 1	0

3.4.4 NOISE

The White Noise Generator can be used for a variety of special effects, either by itself or mixed with the DCOs. Unlike any other synthesizer, the Poly-800 can "envelope" or articulate Noise SEPARATELY from the oscillators, which can be used to add small amounts of "breath noise" to simulated acoustic instrument sounds.

- The LEVEL parameter sets the MAXIMUM noise level over a range of 0 (off) to 15 (full).
- Noise level is also controlled by Digital Envelope Generator 3 (DEG 3), which also controls the VCF. The Noise LEVEL parameter actually determines how loud Noise will be when DEG 3 reaches its Attack peak.

LEVEL
33
15
↑
0
NOISE

LEVEL	VALUE
Noise level	15
Max.	↑
↓	↓
Min.	0

3.4.5 VCF

The Voltage Controlled Filter (VCF) controls tonal quality (timbre) by selectively removing and emphasizing different overtones of the DCO waveforms. The VCF used in the Poly-800 is a LOW PASS filter: it passes over tones BELOW the Cutoff Frequency and reduces or removes completely the overtones ABOVE the Cutoff Frequency. When RESONANCE is turned up, any overtones very close to the Cutoff Frequency will be emphasized.

Cutoff Frequency is the most important parameter of the VCF. Varying the Cutoff Frequency changes the blend of overtones, resulting in a timbre change (which helps create dynamic and "lifelike" sounds). Cutoff Frequency is determined by the CUTOFF (41), KBD TRACK (43), POLARITY (44) and EG INT (45) parameters. It can be also affected by DEG 3 and/or by the Modulation Generator (MG).

CUTOFF	RESONANCE	KBD TRACK	POLARITY	EG INT	TRIGGER
41	42	43	44	45	46
99	15	2 FULL	2 ^	15	2
▲	▲	! HALF		▲	MULTI
▼	▼	0 OFF	! v	▼	SINGLE
0	0			0	!
VCF					

PARAMETER NAMES AND FUNCTIONS

41 CUTOFF

This parameter directly sets the Cutoff Frequency of the low pass filter.

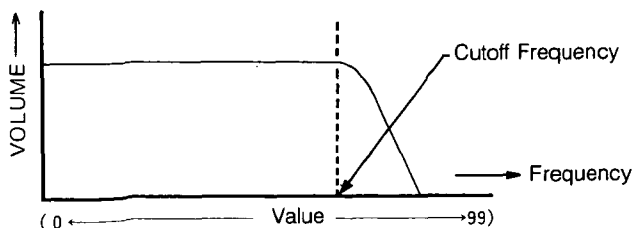

When the Cutoff Value is set to 99 (assuming both KBD TRACK (43) and EG INT (45) are set to 0), all waveform overtones from the DCOs are passed without any effect, and the sound is very bright.

As Cutoff Value is reduced, more and more harmonics are cut off, producing a more rounded or less bright sound.

When the Cutoff Frequency Value is near 0, nearly all of the waveform is filtered out, resulting in almost no sound.

Timbre	Value
Bright, unchanged timbre of DCO waveform	99
↓	↑
Soft timbre	
↓	↓
Almost no sound	0

42 RESONANCE

Resonance emphasizes the harmonics near the Cutoff Frequency, producing a characteristic "wah" or "band pass" type of sound.

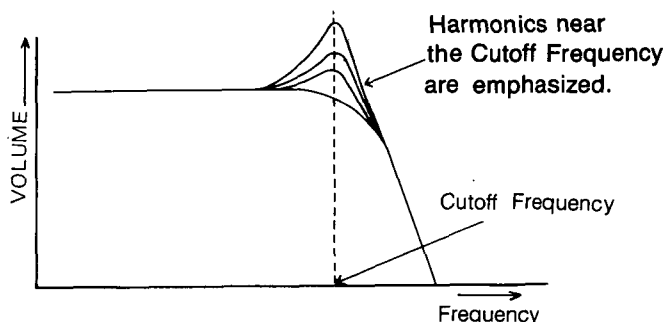

The higher the Value, the stronger the effect of the Filter on the tonal quality (timbre). Resonance can produce typical synthesizer "wah-wah" sounds, helps make instrumental sounds more realistic, and generally provides a good variety of subtle and dramatic effects.

Effect on tone quality	Value
Large (very peaky sound)	15
↓	↑
Small	
↓	↓
None	0

43 KBD TRACK

Keyboard Tracking controls how the VCF Cutoff Frequency changes as you play up and down the keyboard. There are three Values: Full, Half and Off.

Full (2) Cutoff Frequency rises and falls in EXACT PROPORTION to the pitch of the HIGHEST note sounding at any given time (whether played on the keyboard or produced by the Chord Memory feature). This tends to keep timbre (tonal quality) relatively constant as you play up and down the keyboard.

Half (;) Cutoff changes only 1 HALF OCTAVE FOR EVERY OCTAVE change in the highest note played. This tends to make lower notes brighter (more overtones) than higher notes, since the VCF cuts out more and more overtones as the pitch of a note rises.

OFF () Cutoff is NOT AFFECTED by keyboard pitch. Lower notes are much brighter than higher notes, as explained above.

KBD TRACK	VALUE
100%	2
50%	1
OFF	0

The next three parameters, POLARITY, EG INT and TRIGGER, all affect the way that the VCF "envelopes" or changes timbre over the life of a single note. These contours (produced by DEG 3) are very important in creating expressive sounds. Getting a sound "just right" will often require you to go back and forth between ALL of the VCF parameters several times, since they all interact in producing the final sound.

44 POLARITY

The Polarity parameter determines how the Cutoff Frequency is affected by Digital Envelope Generator #3.

- When Polarity equals $\overset{\curvearrowright}{\sim}$, the Cutoff Frequency is swept UP during the attack portion of the envelope, and down during the decay portion etc., for a "normal" envelope effect.
- When Polarity equals $\overset{\curvearrowleft}{\sim}$, the Cutoff Frequency is swept DOWN during the attack portion of the envelope (the envelope is inverted).
- If EG INT (45) is zero, the Polarity parameter has no effect, regardless of its setting.

POLARITY	VALUE
$\overset{\curvearrowright}{\sim}$	2
$\overset{\curvearrowleft}{\sim}$	1

45 EG INT

EG Intensity controls how much the VCF Cutoff Frequency is affected (swept) by Digital Envelope Generator #3 (DEG 3). (The Polarity parameter controls which direction the VCF is swept in.)

- EG Intensity has a range of $\overset{\curvearrowright}{\sim}$ (no sweep) to $\overset{\curvearrowright}{\sim}$ (maximum sweep).

EG INT	VALUE
Sweep deep	15
↓	↕
Sweep shallow	
↓	
None	0

46 TRIGGER

Selects one of two keyboard triggering modes for DEG 3, which controls the VCF (as well as Noise).

Single (;) DEG 3 will be triggered by the FIRST note played, causing a normal Attack - Decay - Break Point - Slope cycle to sweep the VCF. The Envelope attack cycle will NOT be retriggered (restarted) by any new keys played until ALL keys are released and a new "first key" is played.

This allows you to use your playing style to control when new VCF attacks will occur. For example, legato playing could produce smooth even sounds, while staccato playing could produce sharp percussive sounds.

Multi ($\overset{\curvearrowright}{\sim}$) DEG 3 will be triggered whenever a new note is played, even if other keys are still being held down.

This mode allows fast and fluid playing without having to lift fingers off precisely to produce a consistent sound.

TRIGGER	VALUE
Multi	2
Single	1

NOTE:

The Trigger parameter only affects DEG 3. DEG 1 and 2 are always triggered whenever a new note is assigned to the corresponding DCO.

3.4.6 CHORUS

The built in Stereo Chorus produces a warm, subtle ambience that enriches many types of sounds. It is especially effective when headphones or both line outputs (panned separately) are used. The Chorus effect may be programmed ON or OFF.



CHORUS	VALUE
ON	1
OFF	0

3.4.7 DEG

The Poly-800 has nine Digital Envelope Generators (DEGs). 8 of the DEGs (DEG 1 or DEG 1 & 2) control the volumes of the 8 individual DCOs, providing individual articulation (attack, decay, etc.) for each note. The remaining DEG (DEG 3) dynamically changes the VCF Cutoff and Noise level.

ATTACK	DECAY	BREAK P.	SLOPE	SUSTAIN	RELEASE
51	52	53	54	55	56
31	31	31	31	31	31
▲	▲	▲	▲	▲	▲
0	0	0	0	0	0

DEG1 (FOR DCO1)

ATTACK	DECAY	BREAK P.	SLOPE	SUSTAIN	RELEASE
61	62	63	64	65	66
31	31	31	31	31	31
▲	▲	▲	▲	▲	▲
0	0	0	0	0	0

DEG2 (FOR DCO2)

ATTACK	DECAY	BREAK P.	SLOPE	SUSTAIN	RELEASE
71	72	73	74	75	76
31	31	31	31	31	31
▲	▲	▲	▲	▲	▲
0	0	0	0	0	0

DEG3 (FOR VCF & NOISE)

All Digital Envelope Generators use an advanced 6 stage design. In addition to the normal Attack, Decay, Sustain and Release functions, they include BREAK POINT and SLOPE functions, which control an extra envelope stage that can create either a second attack or a second decay.

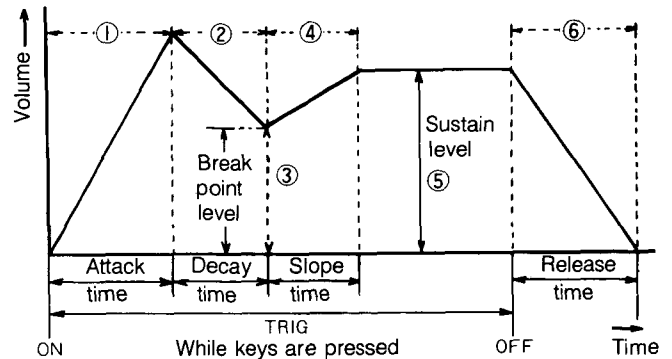

NOTE:

All three DEGs have the same types of parameters, and all parameters have the same range (0 - 31).

These newly designed DEGs provide highly improved percussive and instrumental sounds and many new special effects.

In WHOLE Mode, the 8 DEGs that provide DCO articulation (Volume Envelopes) are all controlled by the DEG 1 parameters (51 - 56), so that all notes are articulated in a similar way. In this mode the DEG 2 parameters have no effect (and appear blank if you try to access them).

In DOUBLE Mode, two DCOs and two DEGs are assigned to each note. Each DEG (and DCO) may be programmed separately, creating a wide range of complex, dynamic sounds. DCO 1 is controlled by DEG 1 (51 - 56) and DCO 2 is controlled separately by DEG 2 (61 - 66). (See section on DCO MODE for further information).

PARAMETER NAMES AND FUNCTIONS

51 · 61 · 71 ATTACK (Rate)

Controls how long it takes for the envelope contour to rise from zero to its maximum level after the key is depressed.

NOTE:

The maximum envelope level can correspond to the maximum DCO or Noise volume (as set by LEVEL parameters 17, 27, 33). It can also correspond to the highest (or lowest) VCF Cutoff Frequency (as set by POLARITY (44) and EG INT (45)).

52 · 62 · 72 DECAF (Rate)

Determines the rate at which the envelope contour falls from the maximum (Attack) level to the BREAK POINT level, after the ATTACK phase is completed.

- If BREAK POINT equals 31, the DECAF parameter has no effect. There needs to be at least a 1 number difference in starting & ending Levels for Rate parameters to have an effect (the Attack peak is always 31.) The bigger the difference, the longer the actual time produced by a given DECAF value.

* For example, assume DECAF is 31, with BREAK POINT (B.P.)= 30, the actual Decay cycle lasts about 0.5 seconds. With B.P.= 29, it lasts about 1.2 seconds (DECAF= 31). At B.P.= 25, it lasts about 3 seconds, and at 20, about 5 seconds.

- * SLOPE and RELEASE are similarly affected by changes to BREAK POINT and/or SUSTAIN levels. The bigger the difference between starting & ending levels, the longer the actual time produced by a particular Rate value.

- Slope has no effect when Break Point and Sustain are set to the same value.

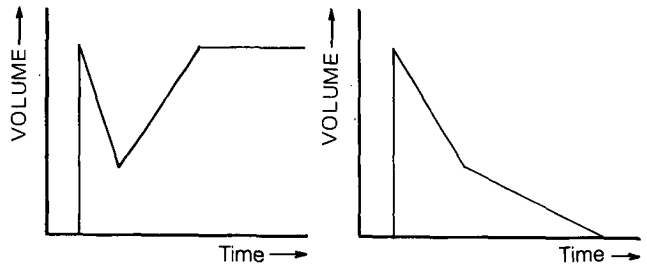

Compressor Guitar Sound, using a second attack.

Piano-type Envelope, using a second decay.

55 · 65 · 75 SUSTAIN (Level)

Determines the constant envelope level at which the sound is sustained after the Attack, Decay and Slope phases are completed, for as long as the key is kept depressed.

53 · 63 · 73 BREAK P. (Break Point, Level)

Determines the envelope level at which the Decay rate changes to the Slope rate. This allows complex two-part decay or decay/attack transients to be created (see Slope description below for examples).

- If the Break Point level is set to maximum (31), the extra envelope stage is effectively disabled, and the envelope becomes a conventional ADSR type. (In this case, SLOPE is used instead of DECAF to set the actual decay rate from the ATTACK peak to the SUSTAIN level.)

- You can also produce a regular ADSR by setting BREAK POINT to the same value as SUSTAIN level. This method allows DECAF to control the decay rate, but requires you to change BREAK POINT whenever you change SUSTAIN.

56 · 66 · 76 RELEASE (Rate)

Determines the rate at which the envelope contour falls from the Sustain level to zero after the key is released.

- If the envelope has not yet reached the Sustain level (if still in the Attack, Decay or Slope phase), then the envelope level will fall from its CURRENT value to zero at the Sustain rate.
- As with Decay and Slope, changing the Sustain level automatically changes the actual Release TIME (because Release is a rate.).

54 · 64 · 74 SLOPE (Rate)

Determines the rate at which the envelope contour moves from the BREAK POINT level to the SUSTAIN level.

- If the Break Point level is LOWER than the Sustain level, then SLOPE functions as a second ATTACK (the envelope moves UP towards the Sustain level).
- If the Break Point level is HIGHER than the Sustain level, then SLOPE functions as a second DECAF (the envelope moves DOWN towards the Sustain level).

Attack time	Decay time	Break point level	Slope time	Sustain level	Release time	VALUE
Long	Long	Highest	Long	Highest	Long	31
↑	↑	↑	↑	↑	↑	↑
Short	Short	0	Short	0	Short	0

3.4.8 MG

The Modulation Generator (MG) is a low frequency control oscillator used for regular, cyclic modulation of DCO pitch and VCF cutoff frequency. The MG can be used for vibrato, growl, automatic wah-wah and other "repetitive" effects. MG effects can be programmed into a given sound, added during performance with the Joystick, or both.

PARAMETER NAMES AND FUNCTIONS

FREQ	DELAY	DCO	VCF
01	02	03	04
15	15	15	15
▲	▲	▲	▲
▼	▼	▼	▼
0	0	0	0
MG			

81 FREQ

Frequency determines the speed of the cyclic variation in pitch or tone quality (vibrato, wah-wah, etc.). Frequency has a range of 0 - 15; the higher the value, the faster the speed.

Vibrato/Wah-Wah speed	VALUE
Fast	15
↑	↑
Slow	0

82 DELAY

Delay determines the delay (if any) between the time when you play the key and the time when vibrato, wah-wah, etc. begins. Delay has a range of 0 - 15.

With a value of 0, the effect begins as soon as you play the key. The greater the value, the longer the delay before the effect begins. (Depressing additional keys while holding one or more down does NOT retrigger the delay function.)

Delay of MG	VALUE
Long	15
↑	↑
No delay: the effect begins as soon as the key is played	0

NOTE:
Delay also affects modulation added through the Joystick.

83 DCO

Determines vibrato depth (depth of DCO frequency modulation)

Vibrato depth	Value
Deep	15
↑	↑
No effect	0

84 VCF

Determines depth of Cutoff Frequency modulation (wah-wah or "growl" effect, etc.)

Wah-Wah depth	VALUE
Deep	15
↑	↑
No effect	0

3.4.9 MIDI

The Musical Instrument Digital Interface allows control signals of many kinds to be exchanged between MIDI-compatible synthesizers, sequencers, rhythm machines, personal computers, etc. (See Section 6, MIDI, for further details).

RCV CH.	PROG CHANGE	SEQ CLK
05	07	08
15	1	2
▲	ENABLE	EXT
▼	DISABLE	INT
1	0	1
MIDI		

These MIDI parameters are not stored in individual Program Numbers differently from the other parameters.

PARAMETER NAMES AND FUNCTIONS

86 RCV CH (Receive Channel)

There can be up to 16 separate CHANNELS of MIDI signals on a single MIDI bus line (5 pin DIN cable). The RECEIVE CHANNEL parameter determines which channel the Poly-800 will respond to (the other channels will be ignored, even if they're carrying MIDI signals).

When connecting two Poly-800s together, selecting Channel 1 on the second keyboard will cause it to sound the notes physically played on the first keyboard. Selecting Channel 2 will cause the receiving keyboard to sound the notes played by the sequencer in the first keyboard. In either case, the second keyboard will still sound notes played on IT'S keyboard.

This parameter will stay even if you turn off the power.

RECEIVING CHANNEL	VALUE
CH.16	16
↓	↓
CH.1	1

87 PROG CHANGE (Program Change)

The Poly-800 MIDI interface can transmit and receive Program Changes, if desired. With PROG CHANGE set to ENABLE (Value 1), the Poly-800 will respond to any Program Change codes received over the selected MIDI channel. With PROG CHANGE set to DISABLE (Value 2), the Poly-800 will IGNORE any Program Change codes received over MIDI.

With two Poly-800s (or other compatible keyboards) linked together using MIDI, you can change programs on either unit and the other will change to the same program number. By moving different programs into the same program numbers on each unit (i.e., Prog. 3 is strings on one unit, brass on the second), two different programs can be "layered" together.

When you link two Poly-800s together, set PROG CHANGE on both units to the ENABLE position (Value 1). The PROG CHANGE parameter controls reception of Program Change signals.

This parameter will be reset to DISABLE when the power is turned on.

PROG CHANGE	VALUE
Program change	1
↓	↓
No change	0

NOTE:

If you want one unit to control the other, but not vice versa, use only one MIDI cable to connect the two units. Use the MIDI OUT jack on the master unit, and the MIDI IN jack on the remote unit.

88 SEQ CLK (Sequencer Clock)

Determines how the Polyphonic Sequencer is controlled.

INT (;) The front panel SPEED control and the START/STOP switch control the Sequencer.

EXT (⌂) Clock and control signals received over the MIDI bus control the Sequencer.

This parameter will be reset to INT when the power is turned on.

SEQ CLK	VALUE
External clock	2
↓	↓
Internal clock	1

4. CREATING SOUNDS

New sounds are created on the Poly-800 by changing or EDITING old programs. Since the Digital Control system provides complete, detailed information about all programs in memory, no Manual mode (found in older synthesizers) is needed.

4.1 OVERVIEW

To create a new sound, first select one of the 64 existing programs that's close to what you want (if no program is close, any program may be used as a starting point). Next, select individual parameters of that program (from the Parameter Table) and edit them, one at a time, until the sound matches your mental image as closely as possible. By adjusting the various parameters, you can create virtually any type of sound you want.

The sound created at this point is a TEMPORARY edit of the original program.

The original program is still in memory, and the temporary edit will be ERASED if you reselect the original program or select a new program.

- To make the temporary edit PERMANENT, you must WRITE the edited program into one of the 64 Program Numbers (the program memory).
- The same Program Number can be used (erasing the original program), or a different Program Number can be used (saving the original program, but erasing a different one).

The procedures for creating sounds and storing them in memory will now be described in detail.

NOTE:
You can also use the procedures below for "fine tuning" sounds to compensate for room acoustics, amplifier characteristics, etc., as well as for creating new sounds.

4.2 EDITING PROGRAMS

4.2.1 Select a Program

Select a sound from the program memory that resembles the kind of sound that you want (or choose any sound), using the Number Select Buttons (see section 2, Selecting Programs, if you're not sure how to do this).

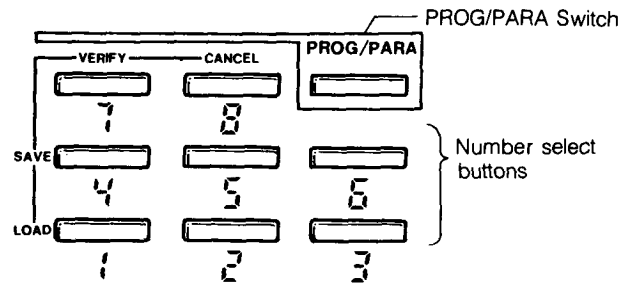

4.2.2 Select Parameter Mode

Press the PROG/PARA switch to select Parameter Mode.

The middle two digits show the current PARAMETER NUMBER, and the right two digits show the current VALUE of the Parameter.

4.2.3 Select a Parameter

All Parameters are referred to by a two digit number ranging from 11 to 88 (just like Program Numbers).

Look up the number of a Parameter that you think should be changed in the Parameter Table, and enter it using the Number Select Buttons (1 - 8).

EXAMPLE: Selecting VCF Cutoff (41)

By looking in the Parameter Table, you'll find that all the VCF parameters start with the number '4', and that VCF Cutoff is 41.

1. First, press Number Select button 4.

The DISPLAY will show something like the following:

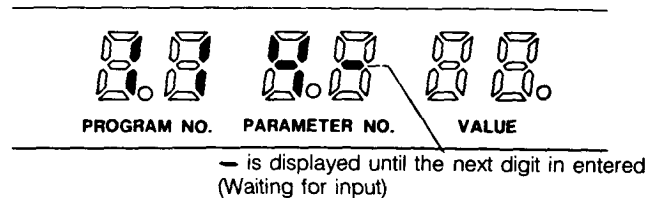

- A horizontal line appears until you select the next digit (which means the programmer is waiting for an input).
- If the first digit selected was wrong, simply press the '4' button TWO times, so that the number 44 appears in the left hand digit of the Parameter Number Display.

- Next, push the Number Select button \downarrow . The VCF Cutoff Parameter has now been selected.

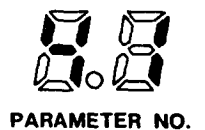

NOTE:

If you enter numbers that are not in the Parameter Table (28 or 35, for example), the number will be accepted but the VALUE section of the Display will be blank. This will also happen if you try to access DCO 2 or DEG 2 parameters in WHOLE Mode (they are only available in DOUBLE Mode).

4.2.4 Edit the Parameter

The UP and DOWN switches in the Value section are used to change the Value of the selected parameter. The current value of the parameter is shown in the VALUE section of the Display:

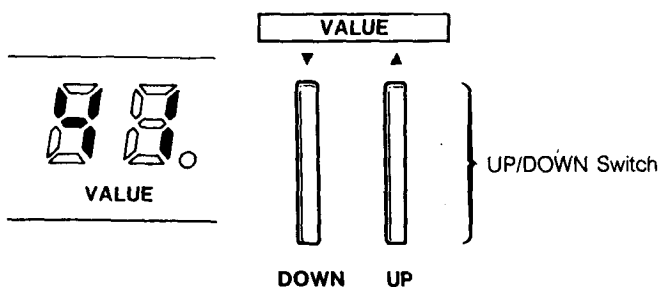

Press the UP button to INCREASE the value; press the DOWN button to DECREASE the value. If you press and release either of these buttons quickly, the value will change one step at a time. If you keep either button depressed, the value will increase or decrease rapidly after a short pause.

NOTE:

If the VCF Cutoff Value is reduced to near $\frac{1}{2}$, the volume of the sound will also be reduced.

When you select a Parameter and then change it, a small LED dot will turn on in the lower right corner of the VALUE Display:

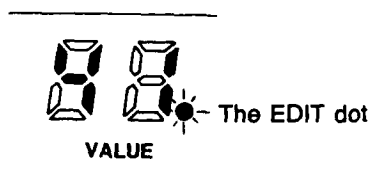

This dot shows that the parameter Value has been changed; if you restore the parameter to its previous Value, the dot will go out. However, if you leave the new value in place (LED dot is on), select another parameter, and then reselect the first (altered) parameter — the LED dot will NOT turn on.

The LED dot only shows when a Parameter has been changed since you selected it. It DOESN'T tell you whether or not the Parameter Value is the same as in the original ("permanent") program being edited.

4.2.5 Edit the Remaining Parameters

After editing one parameter to your satisfaction, repeat steps 3 and 4 for the next parameter, and so on. Continue editing parameters (re-editing if necessary) until the desired sound is achieved.

- If you don't like the edited sound, you can cancel ALL of the edits and restore the original programmed sound. Just press the PROG/PARA switch to select Program Mode, and re-select the original Program Number.
- To make the edited version PERMANENT, you must write it into memory (see Section 4.3 below).

4.2.6 Using the BANK HOLD Feature

The BANK HOLD feature allows the current Parameter Bank number (left hand digit of the Parameter Display) to be "held". This enables you to select any of the Parameters in that bank with a single press of a button, for easy editing of a particular Poly-800 Module.

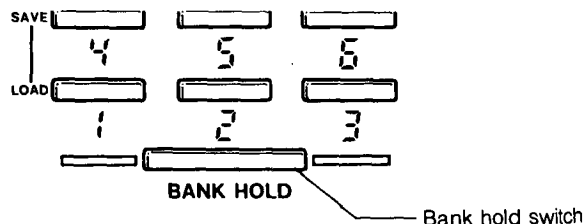

EXAMPLE: Editing the VCF Parameters

- Select any VCF Parameter (such as Cutoff, 4) as explained above, and then press the BANK HOLD switch. The Display will show the following:

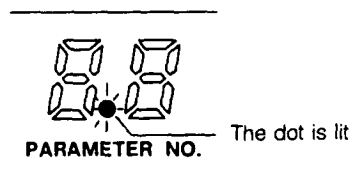

- You may now select any of the VCF parameters by pressing one of the Number buttons. For example, press '3' to select KBD TRACK, '5' to select EG INT, and so on. You may also press '8' to select the Chorus ON/OFF Parameter. (Pressing '7' will result in a blank VALUE Display.)
- Press BANK HOLD again to cancel the Bank Hold function and return to the normal two-digit selection method.

4.3 WRITING PROGRAMS TO MEMORY

To make any edited or newly created sound PERMANENT, you must write it into one of the 64 Program Numbers in the memory (11 - 88).

The memorized programs are protected by the batteries, and will not be erased when the power switch is turned off. (See the MEMORY BACKUP section, P.5, for further information).

NOTE:
You can only WRITE the currently selected sound to memory. If you have already reselected the original version, the edited version is lost.

MEMORY WRITE PROCEDURE

- Set the Program Write switch on the rear panel to the ENABLE position.

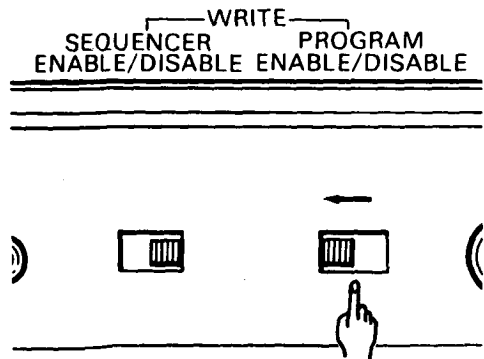

- Make a mental note of the current Program Number, if you want to write an edited version "over" the original program.

- Press the red WRITE button. The Program Number in the Display will be replaced by a pair of flashing lines, to show that you are in Write mode.

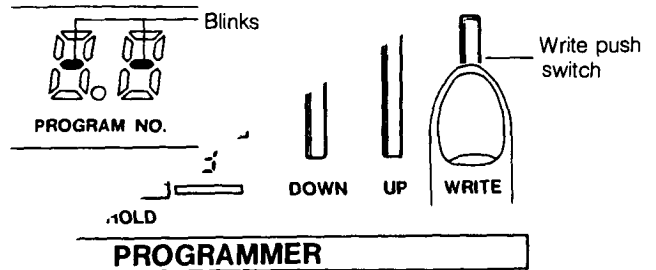

- Press the Number buttons to select the Program Number where you want to store the edited sound.

EXAMPLE:

To store the edited sound in Program Number 34, press the Number Select buttons 3 and then 4. After button '3' is pressed, the DISPLAY will show the following:

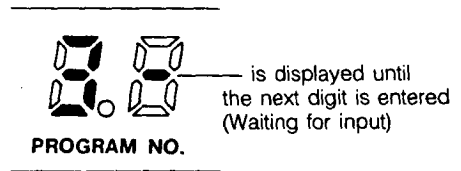

NOTE:
At this point (before the second button is pressed), the "old" sound in memory is still unchanged. If you pressed the wrong number for the first digit (AND ARE ABOUT TO ERASE THE WRONG PROGRAM):

- switch the rear panel Program Write switch to the DISABLE position
- switch it back to the ENABLE position
- press the red WRITE button again
- then press the correct Number buttons ('3' and then '4')

The edited sound is now stored in Program Number 34.

- Set the rear panel Program Write switch to the DISABLE position.

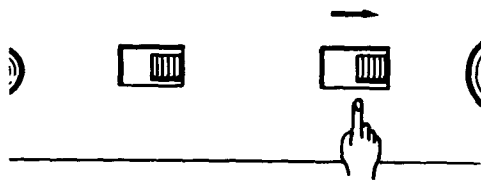
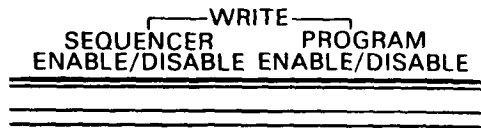

NOTE:

Protecting Memory

After **WRITING** a program to memory, it's a good idea to always set the Program Write switch to **DISABLE**. This prevents accidental erasure or change of your programs (and, of course, doesn't interfere with selecting programs at all).

IT'S ALWAYS A GOOD IDEA TO SAVE YOUR PROGRAMS ON TAPE FOR FURTHER PROTECTION (see Section 7).

4.4 MOVING PROGRAMS

Programs in memory may be easily copied or moved from one Program Number to another. the basic procedure is:

- select the program you want to copy
- press the red **WRITE** button
- enter the Program Number that you want to copy the program into

4.4.1 COPYING A SINGLE PROGRAM

- Set the rear panel Program Write switch to **ENABLE**.

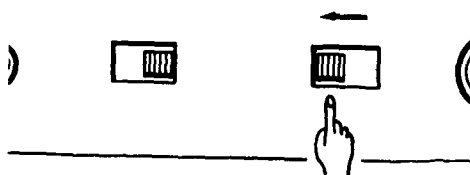
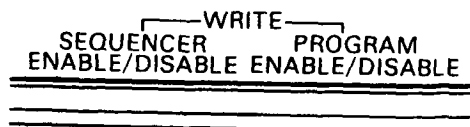

- Select the program you want to move, using the Number buttons.

EXAMPLE

If you want to move the sound in Program Number **111** to a different program number, press the **PROG/PARA** button (if necessary) to select Program mode (so that only three digits are showing in the Display). Then, select Program Number **11** in the normal way.

- Press the red **WRITE** button. The typical blinking Display should result.

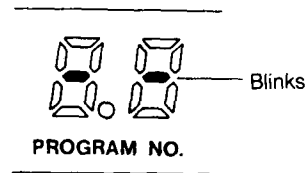

- Select the destination Program Number (where you want to copy the program you selected in step 2).

EXAMPLE

To copy the program to Program Number **23**, enter **'23'** using the Number buttons.

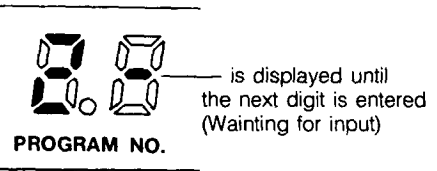

- A horizontal line appears after the first digit is selected (which means the programmer is waiting for an input).
- If you pressed the wrong number for the first digit (AND ARE ABOUT TO ERASE THE WRONG PROGRAM):
 - * switch the rear panel Program Write switch to the **DISABLE** position, and switch it back to the **ENABLE** position
 - * reselect the program you want to copy, then press the red **WRITE** button again
 - * finally, press the correct Number buttons ('**2**' and then '**3**')

When the program has been copied to Program Number **23**, the Display will show the following:

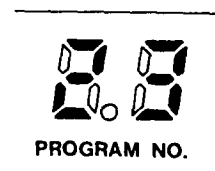

At this point, the sound originally stored in Program Number 23 has been erased, and the same sound is stored in two Program Numbers, 11 and 23.

5. Set the rear panel Program Write switch to the DISABLE position.

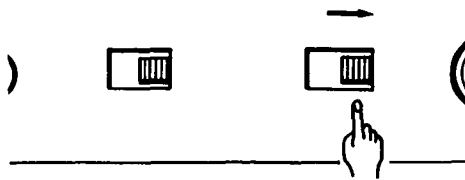
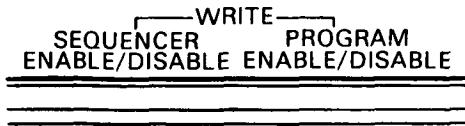

5. Copy program 55 into 42. This opens up 55.
6. 43 is full, but it's not what you want. Copy 43 to 55, then copy 73 to 43. Now, 43 is what you wanted, the OLD program in 43 is safe in 55, and 73 is open for further moves.
7. Continue this process by moving 44 to 73, 13 to 44, 45 to 13, 11 to 45, 46 to 11, and 83 to 46.

Now, the six programs you wanted are all in Bank 4, in the proper order — and the six programs that were there before are safe, but scattered all through Program Memory. If you like, you can keep on in this manner until every program is exactly where you want it to be.

- After all programs have been moved as desired, return the rear panel WRITE switch to the DISABLE position.
- You can use the Tape Interface to save many different arrangements of programs, for different songs or sets of songs.
- Once the programs are organized in this way, you can use the PROG UP footswitch to easily move through the programs.

4.4.2 MOVING SEVERAL PROGRAMS

It's often convenient to rearrange a number of programs into the order you want to use them in for performance. As an example, assume that you want to use programs 42, 55, 73, 13, 11 and 83 for a particular song, in that order.

1. Select a "free" location (for example, 54).

NOTE:
To move programs, you must have at least 1 "free" Program Number which holds a program YOU DON'T MIND LOSING. If there are no free locations, write down all the parameter values for one program, use that Program Number as the "free" location, and re-enter the parameter values you wrote down after you finish moving programs into their final order.

2. Pick a Program Bank to contain the sequence of programs (for example, Bank 4).
3. Since you don't want program 41 in your sequence, copy it into the "free" location (54) as described above. This opens up Program Number 41 for the first program that you DO want.
4. Copy program 42 into 41. This opens up location 42.

5. PERFORMANCE FEATURES

The Poly-800 provides many useful performance features, including the Tune control, Joystick; Key Assign modes (Poly, chord Memory and Hold); Polyphonic Sequencer; and Program Up footswitch.

5.1 TUNE

Adjusts the basic pitch of the Poly-800 to match other instruments. Moving the slider towards '♯' raises the pitch; moving it towards '♭' lowers the pitch.

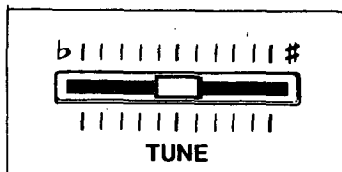

5.2 JOYSTICK

For easy pitch bending and performance control over vibrato and filter effects. You can combine effects by moving the Joystick diagonally.

Moving the Joystick to the right or left raises or lowers the entire keyboard pitch. The maximum pitch bend depth is determined by the BEND slider (and is not stored in memory).

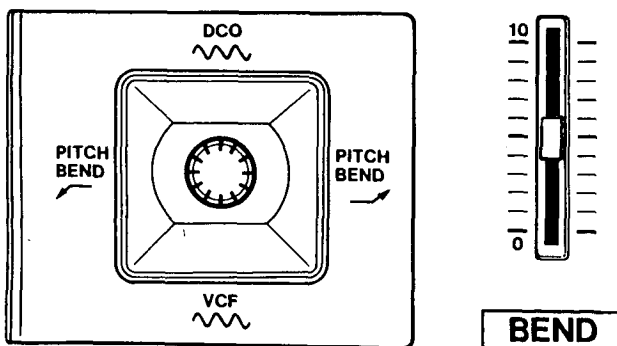

Moving the Joystick upward adds vibrato; moving it downward adds VCF modulation effects ("wah-wah" or "growl"). Since all Joystick modulation is produced by the programmable MG, the speed of the vibrato or VCF modulation is determined by Parameter 61 (MG FREQ).

5.3 KEY ASSIGN MODES

The POLY, CHORD MEMORY, and HOLD playing modes significantly extend the flexibility of the Poly-800.

5.3.1 POLY

Up to eight fully-articulated notes may be played and released independently (four in DOUBLE Mode). If you play more than eight (four), the more recent notes will "cancel out" the earliest notes still sounding. For example, if you play a low 'A' and then 7 more notes (8 notes total), playing an 8th note will "cancel" the low 'A' if it is still sounding.

In POLY Mode, the DISPLAY shows the following:

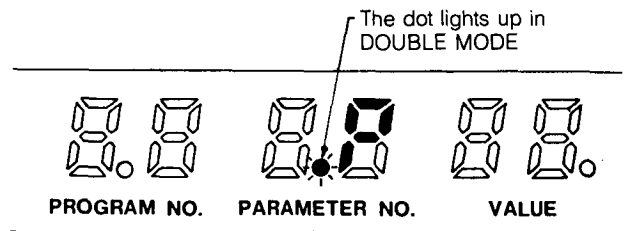

5.3.2 HOLD

When the Hold function is on, notes played will keep sounding indefinitely after the keys are released. Up to 8 notes may be held simultaneously (4 in DOUBLE Mode); playing more keys will cancel "older" notes and replace them with new notes. In HOLD Mode, the DISPLAY shows the following:

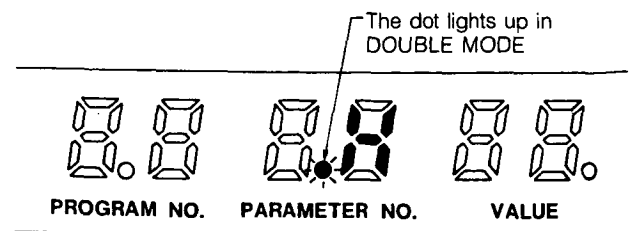

- Hold mode only operates when combined with Poly mode. If you are in Chord Memory mode and press the HOLD button, both Hold and Poly modes will be selected.
- In order for notes to be sustained indefinitely, the DEG SUSTAIN parameters (51, 61, 71) must be set somewhere above 0. If BREAK P. (53, 63, 73) is set to 0 but SUSTAIN is above 0, each note will die away and then attack again, automatically.

5.3.3 CHORD MEMORY

Any interval or chord formation of up to 8 notes (WHOLE mode) or 4 notes (DOUBLE mode) can be "memorized" and then reproduced by playing a single key. In CHORD MEMORY Mode, the DISPLAY shows the following:

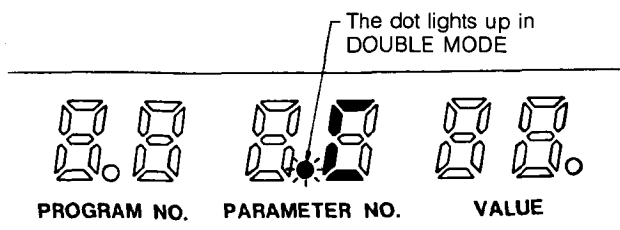

- When a chord containing 5 or more notes is memorized in WHOLE mode, and you then change to a program using DOUBLE mode, only the first 4 notes memorized will be reproduced. If you reselect a program using WHOLE Mode, the full memorized chord will be restored.
- Storing a single note into Chord Memory allows you to play monophonic lead or bass lines with last-note priority. This is very useful for trills, and for playing fast, clean lines with a long RELEASE time selected. The choice of Single or Multiple Keyboard TRIGGER ($\frac{4}{5}$) provides further control over monophonic lines.

USING CHORD MEMORY

1. Press HOLD to select the Hold function.
2. Play the desired interval or chord.
3. Press the CHORD MEMORY button. The interval or chord sustained by the Hold function is now stored into Chord Memory.

Example

Memorized chord	Notes played	Notes heard (reproduced)

NOTE:

Once a chord is programmed into Chord Memory, it will normally remain in memory until a new chord is programmed or the power is turned off. However, the memorized chord will be changed if Chord Memory mode is selected and you press either the POLY or the HOLD button WHILE YOU ARE PLAYING THE KEYBOARD.

5.4 SEQUENCER

The Polyphonic Sequencer can store and play back up to 256 notes, which can be monophonic lines, chords or any combination of the two. You can "play along" with the Sequencer during play back.

- In WHOLE Mode, the sequencer can record and play back chords of up to 8 notes.
- In DOUBLE Mode, you can record chords of up to 4 notes.

Trying to play back, in DOUBLE Mode, a sequence that you recorded in WHOLE Mode will result in some "lost" notes wherever more than 4 simultaneous notes were recorded.

- * The Sequencer will only operate in the POLY Key Assign Mode. Pressing CHORD MEMORY or HOLD while recording a sequence will create unpredictable effects.

5.4.1 TIMING VALUES

The Poly-800 Sequencer is a STEP TIME Sequencer.

- A STEP is a basic time unit, which is usually the same as the shortest note or rest in the sequence.
- It doesn't matter how long you hold down notes when you're recording a sequence. All notes will be played back with the same length. So, if you play a line using quarter notes, eighth notes, etc., it will be played back as all eighth notes — unless you use the STEP button to make some notes longer than other ones.

To have notes with different time values, you must TIE two or more steps together for each of the longer notes, using the STEP switch.

For example, assume you want to record a song that uses 16th notes, half notes and everything in between.

- A 16th note is the smallest time value, so it only requires 1 "step" (the smallest amount of time the sequencer recognizes).
- A half note equals eight 16th notes, and therefore lasts for 8 steps.
- Notes in between use smaller amounts. An 8th note = 2 steps; a quarter note = 4 steps, and so on.
- Rests are just "silent notes", so they take up the same number of steps as notes (8th rest = 2 steps, etc.).
- To work with triplets, you must use a different set of step values. A triplet 16th note would be 1 step, but an 8th note would be 3 steps, a quarter note 6 steps, etc. (2 steps would now be a triplet 8th note).

By doing a little planning before recording your sequence, you can work with almost any set of timing values.

5.4.2 MEMORY CAPACITY

- The Sequencer can record up to 256 "events". If you're recording a monophonic bass line where all notes are the same length, you can have up to 256 notes or rests in a row in your sequence (at 1 event per note or rest).
- Each note of a chord is recorded as a separate "event", so a four note chord requires 4 events (even though it all happens during 1 "step's" worth of time). A sequence made up only of 4 note chords could hold up to 64 chords (256 events/4 events per chord) before you ran out of memory, and it would last for 64 steps.
- TIED NOTES (see above) or chords take up 1 event per note plus 1 event for each step which extends the length of the chord. A four note chord TIED to last for 4 steps (i.e. a quarter note, if a 16th note=1 step), will take up 7 events. (That breaks down to 4 events for the 4 note chord on the 1st step, plus 1 event each for the extensions to the 2nd, 3rd and 4th steps).
- Rests take up 1 event per step — so a quarter rest would take up 4 events (and 4 steps) with a 16th note = 1 step.

5.4.3 WRITING A SEQUENCE

1. Preparations

1. Set the rear panel SEQUENCER WRITE switch to the ENABLE position.

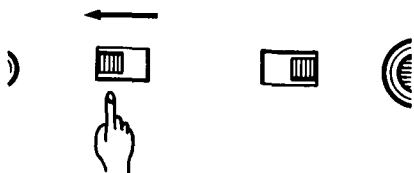
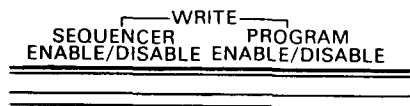

2. Press the Sequencer START/STOP button. The DISPLAY will show the following:

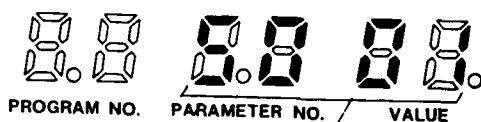

"S 001" stands for "Sequencer Mode, Step # 001. You can record up to 256 steps.

2. Writing a Note

Play the note and release it. When you release the note, the Step Number Display will increase by 1, showing that the note is recorded with a length of 1 step.

3. Writing a Chord

Play the chord, either all notes at once, or adding notes (for chords with large intervals) while keeping at least one key depressed all the time. The chord will be recorded (with a length of 1 step) when all keys have been released.

4. Writing a Tied Note or Chord

While holding down the key(s) for the note or chord, reach over and press the STEP switch once for every step you want to add to the length of the note (chord). Then, release all of the keys. For example, to record a 'C' chord that is four steps long:

- play and hold the 'C' chord
- press the STEP switch THREE times (the Step Number Display increases by 3 numbers)
- release the 'C' chord (the Step Number increases by 1 more number, for a total length of 4 steps).

5. Writing a Rest

Press the STEP button once WITHOUT playing any keys to insert a rest that's 1 step long. Press STEP several times to insert longer rests.

6. If You Make a Mistake

Press the START/STOP key to delete the last step you entered. If the mistake happened earlier (or if it's longer than 1 step), press START/STOP several times, until the Step Number Display shows a number before the mistake occurred.

7. Ending the Sequence

Return the rear panel SEQUENCER WRITE switch to the DISABLE position to end the sequence and leave the Record mode.

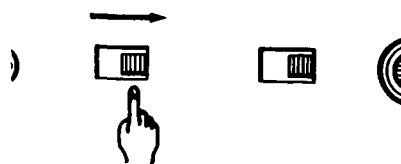
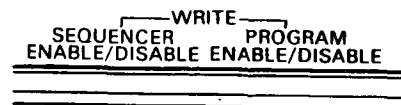

8. Reaching the End of Memory

The Sequencer can record up to 256 events (see MEMORY CAPACITY, above). When all the memory has been used up, the Sequencer will automatically leave the WRITE mode. (showing the same Display as the mode of SELECTING PROGRAMS.)

Make sure to set the rear panel SEQUENCER WRITE switch to the DISABLE position if this happens. Otherwise, pressing the START/STOP switch will erase your sequence and start recording a new one from Step # 1.

WRITING A SAMPLE SEQUENCE

For practice, try writing the following musical passage into the sequencer:



Since the smallest time value is a 16th note, and no triplets are used, you can use time values of 16th note = 1 step; 8th note = 2 steps, and dotted 8th note = 3 steps.

Example

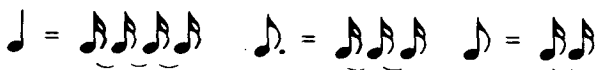

1. Put the Sequencer into WRITE mode as described above.
2. Play 'G' (above middle C), hold it, press the STEP switch once, and release the key, to enter 'G' as an 8th note. The Step Number Display should now read "5003" (S# = 003).

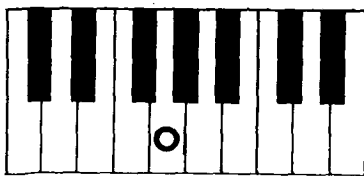

3. Play and hold 'A', press STEP once, and release the key to enter 'A' as an 8th note (S# = 005).

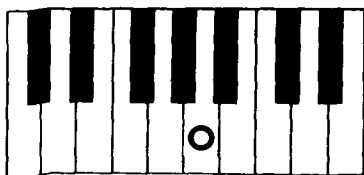

4. Press the STEP switch four times, without holding any keys down, to insert a quarter rest (S# = 009).

5. While holding down a chord ('F', 'A', 'C', 'E'), press STEP twice and then release the keys, to enter the chord with a length of a dotted 8th note (a "dotted 8th chord") (S# = 012).

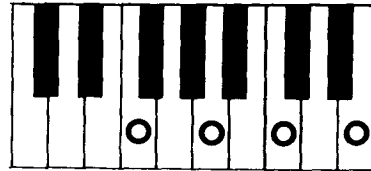

6. Play the chord ('F', 'A', 'C', 'E') again and release it, to enter it as a "16th chord" (S# = 013).
7. Press the STEP switch four times, without holding any keys down, to insert a quarter rest (S# = 017).
8. While holding down a chord ('F', 'A', 'B', 'E'), press STEP twice and then release the keys, to enter as a "dotted 8th chord" (S# = 020).

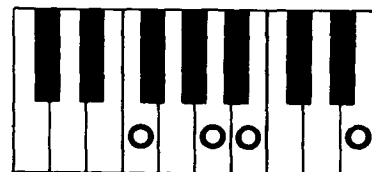

9. Play the chord ('F', 'A', 'B', 'E') again and release it, to enter a "16th chord" (S# = 021).
10. Press the STEP switch twice by itself, to insert an 8th rest (S# = 023).
11. Play 'G' and press STEP once to enter an 8th note (S# = 025).

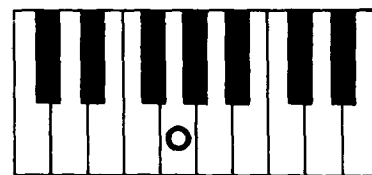

12. Play 'A' and press STEP once to enter an 8th note (S# = 027).

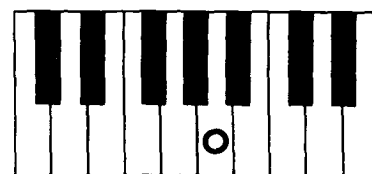

13. Play 'C' and press STEP once to enter an 8th note (S# = 029).

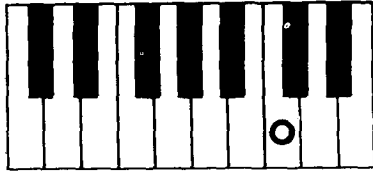

14. Play 'D' and press STEP once to enter an 8th note (S# = 031).

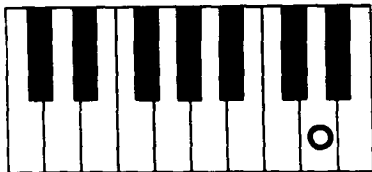

15. Play 'E' and press STEP once to enter an 8th note (S# = 033).

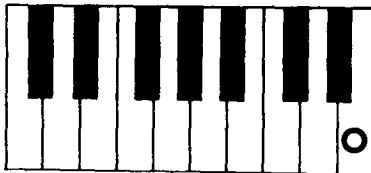

This completes writing the Sequence. Return the rear panel SEQUENCER WRITE switch to the DISABLE position.

- If you made any mistakes while writing the sequence, you can correct them using the START/STOP button as described above.

5.4.4 PLAYING BACK A SEQUENCE

1. Press the START/STOP switch once to begin playback.

As soon as the sequence reaches the end of the last note or rest you programmed, it returns to the beginning and repeats again.

The front panel SPEED slide control adjusts the rate at which the sequence plays back, over a wide range.

NOTE:

The sequencer can also be clocked over the MIDI bus (see Section 6, MIDI, P.33). In this mode, 6 MIDI clocks are equal to 1 sequencer step. Since MIDI clocks occur at a rate of 24 clocks per quarter note, each sequencer step = one 16th note when the sequencer is clocked by MIDI.

- When the Sequencer is set for an EXTERNAL (MIDI) clock (parameter 88), the front panel SPEED and START/STOP controls have no effect.

2. Press the START/STOP switch again to stop playback of the sequence.

5.5 PROGRAM UP FOOTSWITCH

The rear panel PROGRAM UP jack allows you to advance one program at a time (from program 11 to 12, for example) by using a footswitch or other "trigger" source. When the end of a particular Program Bank is reached, triggering the PROGRAM UP jack will go the beginning of the NEXT Bank. When the end of the LAST Program Bank is reached, triggering PROGRAM UP will select the FIRST Program #:

- With Program 28 selected, triggering PROGRAM UP selects 31.
- With Program 88 selected, triggering PROGRAM UP selects 11.

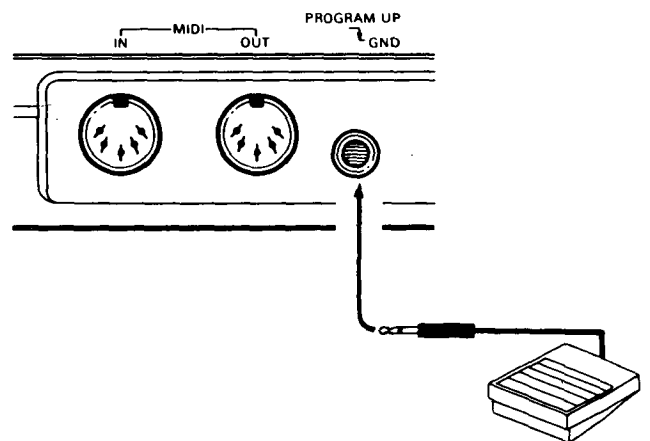

Connecting a footswitch (optional) to the PROGRAM UP jack allows you to keep both hands on the keyboard while changing sounds instantly, whenever desired.

- A FOOTSWITCH (KORG PS-1, S-1 etc.) is normally connected to the PROGRAM UP jack on the rear panel.
- A short-to-ground type trigger output (GND) from a rhythm or other device can also be connected, to synchronize program changes to an outside source.

6. MUSICAL INSTRUMENT DIGITAL INTERFACE (MIDI)

The Musical Instrument Digital Interface is a "universal language" which allows different types of musical equipment to talk to each other. It is the result of an agreement between many musical instrument manufacturers. It provides a uniform set of hardware and software specifications for linking many kinds of equipment for performance, studio use and other purposes.

MIDI-compatible equipment can include synthesizers, sequencers, rhythm units, personal computers, and other types of products.

The optional 5 pin DIN style MIDI connecting cable should be used for connecting the Poly-800 to another MIDI-compatible unit (maximum length: 15 meters (50')).

The Poly-800 can transmit and receive the following kinds of data over the MIDI bus.

1. Key Data (pitch of notes and when they begin & end)
 - from the Keyboard
 - from the Sequencer
2. Joystick data
3. Sequencer clock and START/STOP control signals
4. Program changes

NOTE:

If the unit connected to the Poly-800 does not include all of these functions, it will only be affected by the functions it has. For example, if the other unit lacks the MIDI pitch-bend function, moving the Poly-800 Joystick will bend the pitch of the Poly-800, but not the pitch of the other unit.

Several MIDI functions are set up as Poly-800 parameters, and can be changed by you. These include:

- Selecting whether the Poly-800 will receive information from ALL MIDI channels (called the "OMNI On" mode), or from a particular channel ("OMNI Off").
- selecting the Receive Channel (85). There can be up to 16 possible data Channels (sort of like tracks on a multi track recorder) on a single MIDI bus line.
 - * This allows several Poly-800s, playing different parts, to be hooked up on the same MIDI bus (when connected to an appropriate external sequencer or computer). Each "track" or Channel can carry a different set of chords, melodies, bass lines, etc.
- selecting whether or not the Poly-800 will and respond to Program Change commands. (87)
- selecting whether the Poly-800 Sequencer is controlled by the front panel SPEED and START/STOP controls, or by signals received over the MIDI bus. (88)

PLEASE REFER TO SECTION 3.4.9 ON MIDI PARAMETERS (P.21) FOR DETAILED INFORMATION ON THOSE FUNCTIONS AND HOW TO CHANGE THEM.

SAMPLE CONNECTIONS

1.a. ONE SYNTHESIZER CONTROLS THE OTHER.

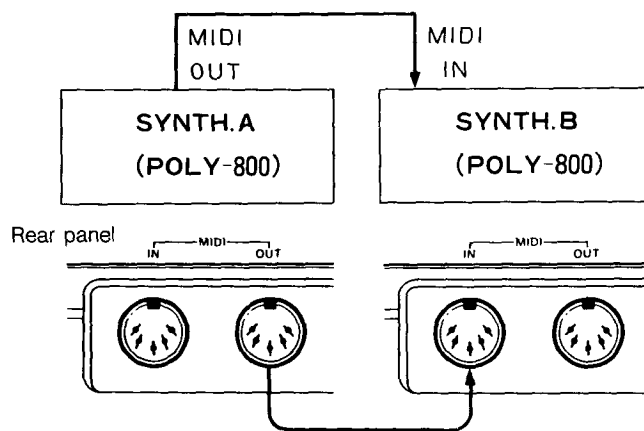

When two Poly-800s are connected together as in the above diagram, notes played on Synth A are duplicated by Synth B. Program number changes (when enabled on Synth B [parameter 87 = 1]), sequencer data, joystick data and "mode messages" can also be sent from A to B.

Synth A (the transmitting keyboard) **always** transmits keyboard note data on channel "1", and sequencer note data on channel "2", regardless of the setting of its Receive Channel Parameter (parameter "86"). Thus, Synth B may receive note data from Synth A's keyboard, sequencer, or BOTH, depending on Synth B's mode and Receive Channel settings. When the synths are first turned on, B will initially receive data on ALL MIDI channels (called the "OMNI On" mode). If the sequencer on Synth A is started (and Synth B is set to Receive Channels 1 or 2), then a message is sent Synth B so that Synth B will receive data only on one channel (called the "Multi-channel" or "OMNI Off" mode). The receive channel last selected by the user will be retained, even when power is turned off; therefore, the user may have to select a different channel, depending on the function desired (see below). The following summarizes the different MIDI operations of two Poly-800s connected together:

1. When Synth B is first turned on:
Synth B will receive BOTH Keyboard and Sequencer NOTE data (plus Program Change & Joystick data) from Synth A.
2. Select Receive Channel 1 on Synth B:
Synth B will receive Synth A's Keyboard, Program Change & Joystick data only.
3. Select Receive Channel 2 on Synth B:
Synth B will receive Synth A's Sequencer Note data (NOT Sequencer start/stop/timing data) only.

4. Select Receive Channel 3—16 on Synth B:
Synth B will receive BOTH Keyboard and Sequencer Note data, from Synth A.

To return the Poly-800 to "OMNI On" (receive all channel) mode, simply turn the Poly-800 off, wait a few seconds, and then turn on again.

- **Note on Using the Poly-800 in a multi instrument setup:**

As noted above, when a Poly-800 is first turned on, its mode is set to the "OMNI On" (receive data on all channels) mode. If you are going to use your Poly-800 and other MIDI synths, drum machines, etc., with a multi-channel sequencer or computer, then the sequencer/computer should normally send a mode change message to the Poly-800 and other synths to automatically change them to the MULTI CH (OMNI Off) mode.

If the sequencer or computer does not send such messages, you can manually change the Poly-800 to the MULTI CH (OMNI Off) mode by simply selecting the RECEIVE CH parameter (# "86"). [It is not necessary to **change** the channel number; merely selecting parameter 86 changes the Poly-800's mode.]

To return to the "OMNI On" mode, turn the Poly-800 off and then on again, as noted above.

1.b. SYNCHRONIZING THE SEQUENCERS IN KEYBOARDS 'A' AND 'B' (same connections as 1-a above).

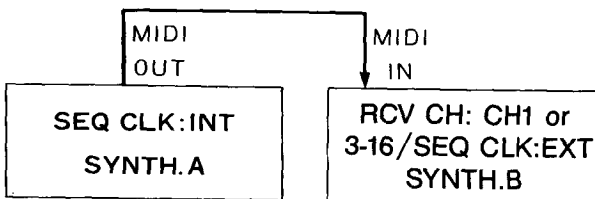

1. Write the same number of steps into both sequencers (if you want the Sequencers to remain locked together after the first repeat).
2. Set the SEQ CLK parameter (F5) of keyboard 'A' to INT (Value 1). Set SEQ CLK on keyboard 'B' to EXT (Value 2).
3. Set RCV CH (F5) of keyboard 'B' to a channel other than 2 (1 or 3-16).

Now, press the Sequencer START/STOP switch on keyboard 'A'. The two Sequencers will play back together in perfect 'sync'. You can start and stop both sequencers whenever you like with the 'A' START/STOP switch, and they will always restart in perfect sync "from the top".

The 'A' SPEED control sets the playback speed for both sequencers. (The 'B' START/STOP and SPEED controls have no effect on EITHER sequencer.)

- You can set 'A' and 'B' to different programs if you like.
- You can also replace either Synthesizer with a MIDI-Compatible drum unit, to 'sync' the drum unit to the Poly-800 or vice versa.

2. BOTH SYNTHESIZERS CONTROL EACH OTHER.

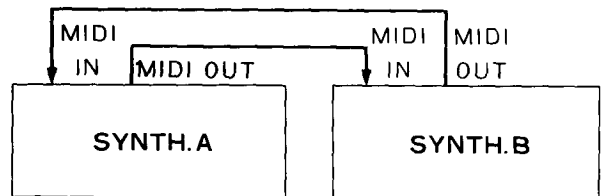

Using two MIDI cables as shown, you can link two Synthesizers together so that notes played on either keyboard will also be played on the other synthesizer.

As described above, the two units can use different programs. Each unit can also be set up to respond to either keyboard data, sequencer data program change and/or joystick data coming from the other unit.

3. USING AN EXTERNAL SEQUENCER (OR PERSONAL COMPUTER WITH INTERFACE) TO CONTROL THE POLY-800.

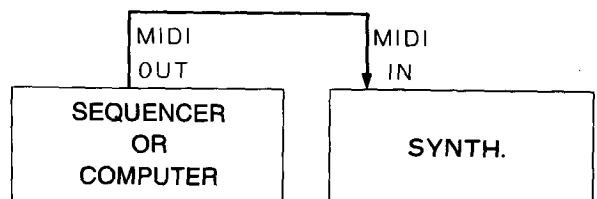

The Poly-800 can be used with any MIDI-compatible Sequencer (either real-time or step-time), or with a personal computer equipped with a MIDI interface and appropriate software.

When using an external unit to control the Poly-800, you must be careful not to try to play back more notes simultaneously than the Poly-800 can handle, or notes will be "lost".

- In WHOLE Mode, the Poly-800 can play back up to 8 notes simultaneously.
- In DOUBLE Mode, the Poly-800 can play back up to 4 notes simultaneously.

Two or more Poly-800s, set for different MIDI Receive Channels, can be connected to an appropriate unit to allow more than 8 (4) notes (and more than one programmed sound) to be played back simultaneously.

7. TAPE INTERFACE

The Tape Interface lets you SAVE the contents of both the Program Memory and the Sequencer data onto cassette tape at the same time. You can then LOAD either Program data, Sequencer data, or both from the tape into the Poly-800, whenever desired. The DISPLAY shows up to six different messages to keep you constantly informed of tape operations and possible problems. Loading is so fast (14 seconds) that you can even load new data between songs during a performance. The Tape Interface allows a library of many original sounds to be easily created and used.

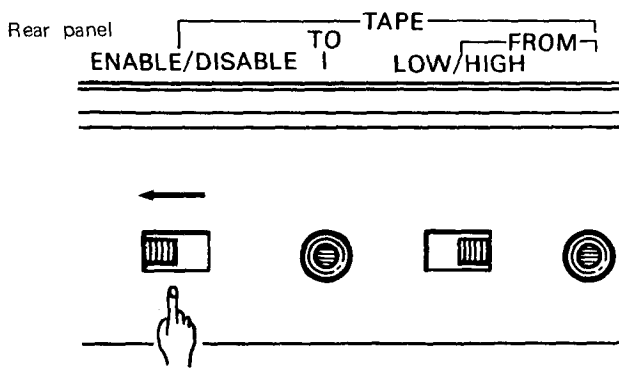

To use the Tape Interface, set the rear panel TAPE switch to the ENABLE position. The functions of the Number Select buttons '1', '4', '7' and '8' will change as follows:

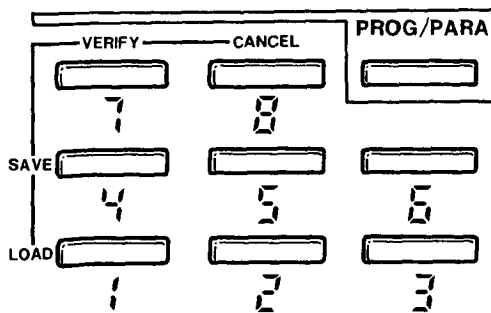

* **SAVE (4)**

Press this button to store both Program memory and the Sequencer data on tape.

* **LOAD (1)**

Press this button to load recorded Program and/or Sequencer data back into the Poly-800.

After data is LOADED, the previous contents of the Program memory and/or Sequencer will be erased.

* **VERIFY (7)**

This is used to check recorded data (after the SAVE procedure) to make sure that it is properly recorded on tape.

* **CANCEL (8)**

If an error occurs during the LOAD or VERIFY operations, the CANCEL button lets you start over again. Pressing CANCEL during SAVE, LOAD, or VERIFY operations will immediately cancel the operation.

7.1 SAVING PROGRAM & SEQUENCER DATA ON TAPE

1. Connect rear panel TO TAPE jack to the tape recorder input jack (MIC jack recommended).

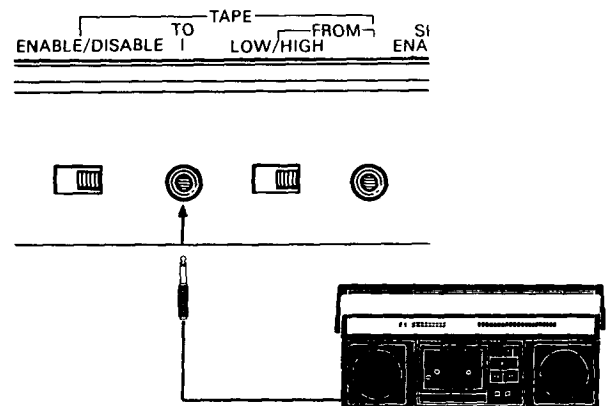

- MIC inputs commonly use either "mini" or standard phone type jacks. Use the optional accessory connecting cord and adaptor (as needed) to connect the cassette tape recorder.
- The Poly-800 Tape Interface is designed to be used with medium to good quality portable cassette recorders and cassette tapes. "Bargain basement" tape brands will generally causes problems, and "Walkman" type recorders & micro-cassette units may not have a sufficiently high output level.

2. Set the tape recorder to the Record mode, and let the tape advance until the leader tape is past the tape heads. Then press the recorder's PAUSE button.
3. Set rear panel TAPE ENABLE/DISABLE switch to the ENABLE position. The DISPLAY will show this message:

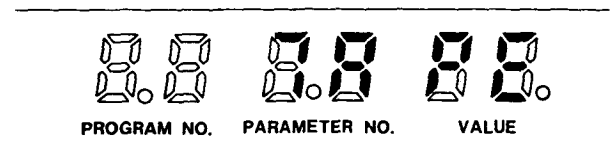

- The Poly-800 will now produce a "level setting" test tone at the TO TAPE jack (a medium pitched "ooo" sound). Using this tone, adjust the Record Level (Volume) setting on the tape recorder so that it is about 30 per cent lower than the level at which the signal distorts.
 - If the recorder has VU tape meters, adjust the record level control to obtain a reading around -5dB.

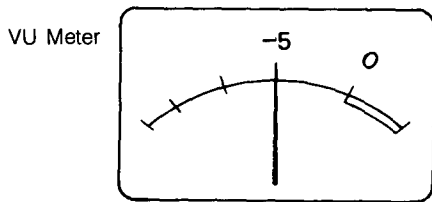

- When the recording level adjustment is completed, release the PAUSE button to begin recording. (You may want to record a short verbal message describing the program contents before you begin recording the actual data.)
- Press the SAVE button to begin transferring the Program and Sequencer data on the Poly-800 to the tape recorder.

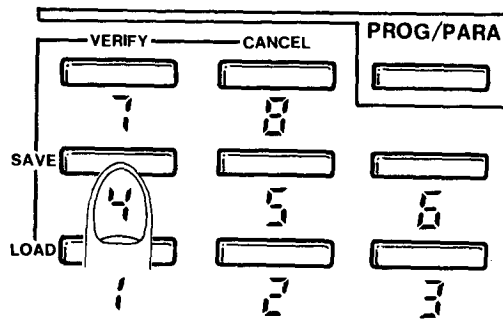

What you see on the display



- After about 14 seconds, the DISPLAY will change from SAVE to TAPE, and you should stop the tape recorder (if you're done making "safety" copies). All data has now been recorded on the tape.
 - To guard against accidental loss of your data, it's a good idea to repeat Step 6 several times to make "safety" copies of your data. Leave a five-second gap between recording so that you can find the beginning of each recording easily.
- Return the rear panel TAPE ENABLE/DISABLE switch to the DISABLE position.

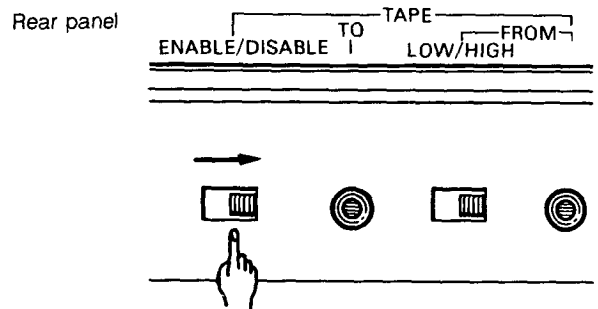

7.2 RECORDED DATA TONES

If you listen to a tape of recorded data, you will hear the following tones;

- Level set tone (lower-pitched "ooo")
- ↓
- Leader tone (high-pitched "eee")
- ↓
- Data tone (medium-pitched "aaa")
- ↓
- End tone (high-pitched "eee")
- ↓
- Level set tone (lower-pitched "ooo")

- Leader tone indicates the beginning of the SAVE operation.
- Data tone The actual digital data from the Poly-800 Programmer and Sequencer.
- End tone indicates end of the SAVE operation.

7.3 VERIFY

The VERIFY procedure should always be used after SAVE to make sure that the Program and Sequencer data has been recorded properly. It is also useful for determining the best playback level to use with your tape recorder.

- Connect Poly-800 rear panel FROM TAPE jack to the tape recorder output jack (EARPHONE or LINE OUT). Set FROM TAPE switch to HIGH (earphone) or LOW (line out), according to type of recorder output jack used.

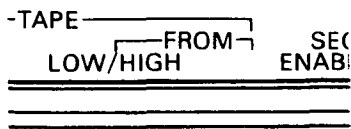

TAPE RECORDER OUTPUT JACK	HIGH/LOW
Line out (AUX)	LOW
Earphone out Headphone out	HIGH

- Rewind the tape to a little before the recording starts, and play it back.
 - Stop the tape (or press Pause) when you hear the beginning of the leader tone.
- Set the recorder Volume control to a medium level (around 5). If tone controls are provided (Treble and/or Bass), set them flat.
- Set rear panel TAPE ENABLE/DISABLE switch to the ENABLE position. The DISPLAY will show the following message:

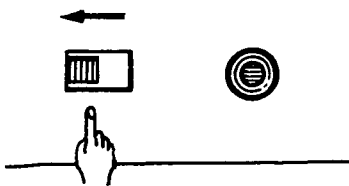
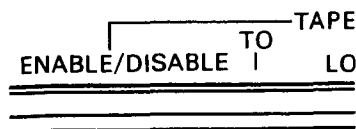

- Press the VERIFY button. The DISPLAY will show the following:

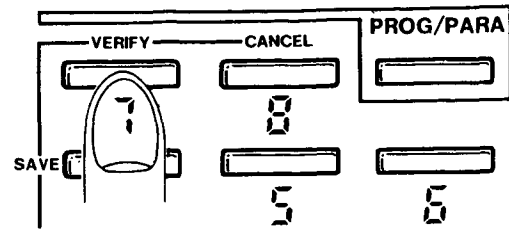
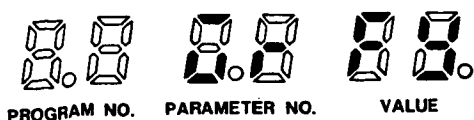

- Start tape recorder playback. It will take about 14 seconds to Verify the data. There are three possibilities:
 - The recorded data is GOOD (go to step 7).
 - There is an ERROR, and either the recorded data is bad or there is a level setting problem (go to step 8).
 - There is no apparent change (go to step 9).
- If the VERIFY operation was successful, the DISPLAY will show this message:



- Stop the tape recorder, and return the rear panel TAPE ENABLE switch to the DISABLE position.

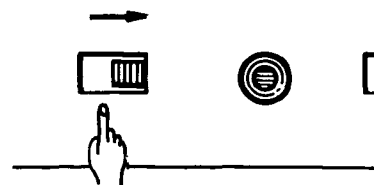
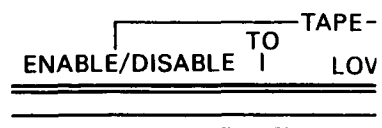

- If you got an Err (Error) indication, press the CANCEL button. You will obtain the normal TAPE message on the DISPLAY.

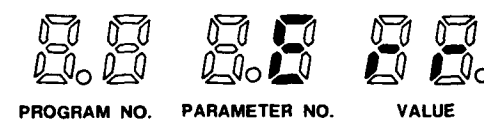

- Repeat the VERIFY procedure using different tape recorder Volume settings (1/2 to 1 number at a time).



You may also try changing the setting of the FROM TAPE "HIGH/LOW" switch.

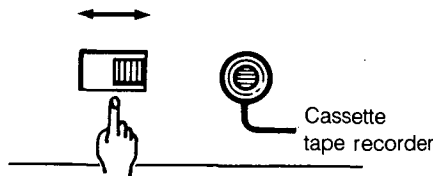
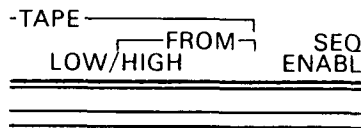

- When you find settings that work, write them down for future reference.

9. If the "Verify" message is still displayed 15 seconds after starting playback, either the recorder level is too low or there is a problem with the cables.

- Press the CANCEL button, set the recorder Volume somewhat higher, and repeat the VERIFY procedure from step 2.

IMPORTANT NOTES

- YOU WILL NOT GET A "GOOD" MESSAGE IF THE TAPE DATA IS DIFFERENT IN ANY WAY FROM THE DATA IN THE POLY-800, even if VERIFY has been performed properly and all settings are fine. This is because the VERIFY procedure checks to make sure that the Program and Sequencer data on the tape MATCHES the data in the Poly-800 memory.
- THINGS TO TRY if you repeat the VERIFY procedure several times and still do not get a "Good" indication:
 - * repeat the SAVE procedure using different recording levels. When you find a level that works, WRITE IT DOWN FOR FUTURE REFERENCE.
 - * try a different, higher quality brand of tape.
 - * make sure that the heads of your tape recorder are clean and demagnetized.
 - * try a different tape recorder
 - * check your batteries and AC adaptor. The Tape Interface may not work reliably with low batteries, with other than the recommended KORG AC adaptor, or at low line voltages.

7.4 LOADING DATA INTO THE POLY-800

Both Program and Sequencer data is always recorded on the tape. However, you can choose the data you want to LOAD back into the Poly-800:

- Program Data only
- Sequencer Data only
- Both Program and Sequencer Data

NOTE:

LOADING data from tape ERASES the corresponding data previously in the Poly-800.

1. Connect Poly-800 rear panel FROM TAPE jack to the tape recorder output jack (EARPHONE or LINE OUT). Set FROM TAPE switch to HIGH (earphone) or LOW (line out), according to type of recorder output jack used.

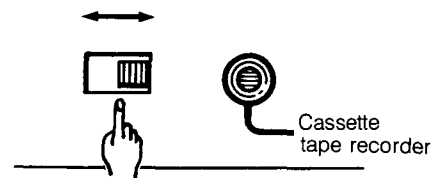
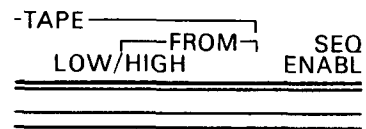

TAPE RECORDER OUTPUT JACK	HIGH/LOW
Line out (AUX)	LOW
Earphone	HIGH
Headphone	HIGH

2. Rewind the tape to a little before the recording starts, and play it back.
 - Stop the tape (or press Pause) when you hear the beginning of the leader tone.
3. Select proper settings for the tape recorder Volume and Tone controls and the rear panel FROM TAPE HIGH/LOW switch. (Use settings that produced a "Good" indication during VERIFY.)
4. Set rear panel TAPE ENABLE/DISABLE switch to the ENABLE position.

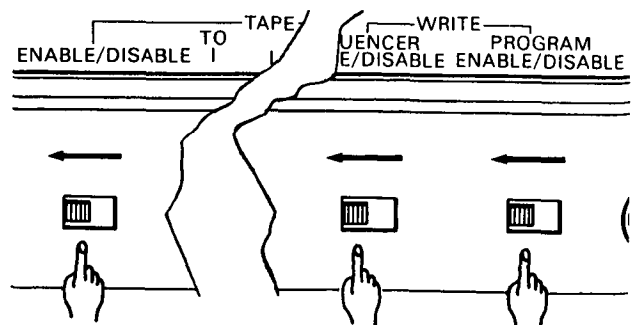

5. Select whether Program data, Sequencer data or both will be loaded.
 - To LOAD Program data, set the rear panel PROGRAM WRITE switch to the ENABLE position.
 - To LOAD Sequencer data, set the rear panel SEQUENCER WRITE switch to the ENABLE position.
 - If you don't want to LOAD Program data (or Sequencer data), make sure that the appropriate WRITE switch is in the DISABLE position.

6. Press the LOAD button:

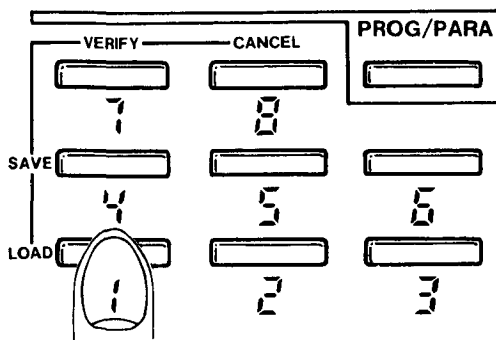

What you see on the display

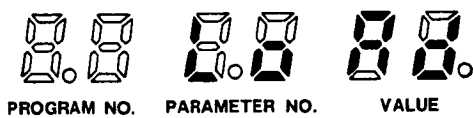

7. Start tape recorder playback. It takes about 14 seconds to LOAD data.
8. If the LOAD operation was successful, the DISPLAY will show this message:



- Stop the tape recorder, and return rear panel TAPE and WRITE switches to the DISABLE position.

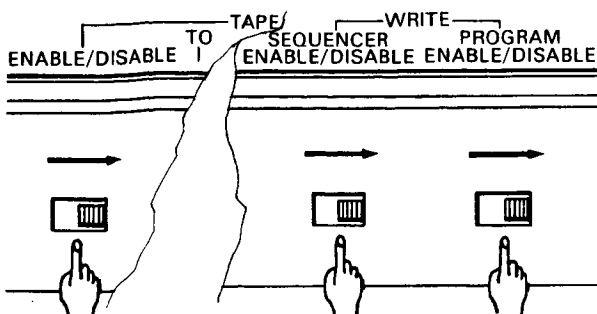

9. If you get a "Err" (Error) message, or if the DISPLAY doesn't change at all after about 15 seconds, press the CANCEL button and repeat the LOAD procedure from step 2, using different volume settings.

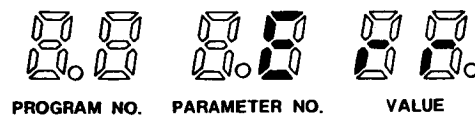

- Steps 8 and 9 of the VERIFY procedure offer further suggestions that work just as well for LOADING data into the Poly-800.

NOTE:

After you have finished using the Tape Interface, set the rear panel TAPE switch to the DISABLE position (and make sure all WRITE switches are also set to DISABLE).

You will not be able to play the Poly-800 if the TAPE switch is left in the ENABLE position.

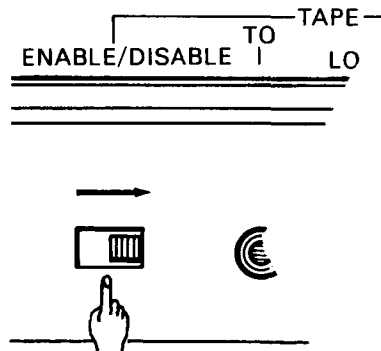

8. POWER SUPPLY

The Poly-800 uses six C-type (1.5V) batteries as its built-in power source. The 9V AC adapter (supplied) should generally be used to help extend battery life.

- Be sure to use only the recommended KORG 9V AC adapter (rated at 300 mA). Other types of adapters may cause malfunctions and can even damage the Poly-800.
- Make sure that you are using the correct KORG adapter for your local line voltage. Unusually high or low line voltage can also cause malfunctions.

8.1 BATTERY LIFE





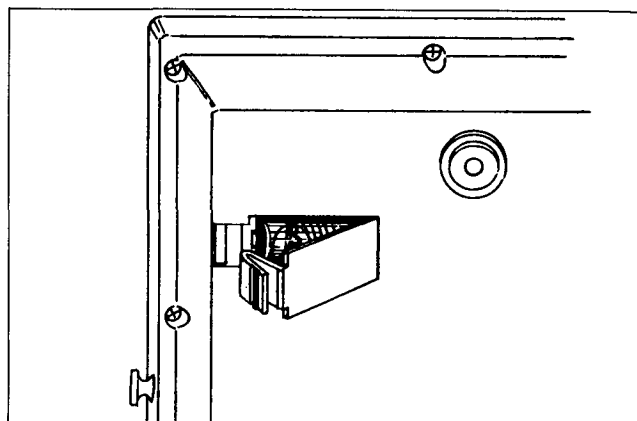

- The batteries will last for 4 hours of continuous use. When Headphones are used, the batteries will last a little bit less.
- The batteries are almost dead when the DISPLAY goes blank. They should be replaced fairly soon to avoid losing Program and Sequencer memory. However, you can safely wait a day or so to do this **AS LONG AS YOU DON'T LEAVE THE POLY-800 TURNED ON**, since even nearly dead batteries can supply enough current to safeguard the memory — as long as they aren't run down any further.

8.2 REPLACING THE BATTERIES

1. Turn off the POWER switch and disconnect the AC adapter from the Poly-800 if it's being used.
2. Remove the cover from the battery compartment in the bottom of the Poly-800.
3. Remove the dead batteries and insert the new ones (you have about 4 - 5 minutes before Program and Sequencer memory is lost).
4. Snap the cover back on the battery compartment.



SPECIFICATIONS

● Keyboard	49 keys (C-C), Normal or Reverse Color	● Key assign mode	POLY, CHORD MEMORY, HOLD
● Voice	8 Voice (WHOLE mode) 4 Voice (DOUBLE mode)	● Programs	64 (11 to 88)
● DCO1	Octave (LOW, MID, HIGH), Waveform ( , ), 16' 8' 4' 2' (ON/OFF) Level (0 - 31)	● Programmer	Number select buttons (1-8), PROGRAM/PARAMETER, BANK HOLD, UP, DOWN, WRITE switches
● DCO2	Octave (LOW, MID, HIGH), Waveform ( , ), 16' 8' 4' 2' (ON/OFF) Level adjustment, Interval (0 - 12 semitones), Detune (-20 cents MAX)	● Display	Program Number, Parameter Number, Parameter Value, Bank hold indicator, Edit indicator
● DCO Mode	(WHOLE, DOUBLE)	● Tape interface	Save, Load, Verify, Cancel
● Noise	Level (0 - 15) (White noise)	● Input jacks	FROM TAPE (HIGH/LOW), PROGRAM UP ( GND)
● VCF	Cutoff Frequency (0 - 99), Resonance (0 - 15), Keyboard Track (OFF, HALF, FULL), EG Intensity (0 - 15), EG Polarity ( , ), Trigger mode (for DEG3 only) (SINGLE, MULTI)	● Output jacks	Output (R, L/MONO), HEADPHONES, TO TAPE.
● Chorus	ON/OFF	● Tape switch	ENABLE/DISABLE
● DEG1 (FOR DCO1)	Attack time, Decay time, Break Point level, Slope time, Sustain level, Release time (ALL 0 - 31).	● Write switch	Program (ENABLE/DISABLE) Sequencer (ENABLE/DISABLE)
● DEG2 (FOR DCO2)	Attack time, Decay time, Break Point level, Slope time, Sustain level, Release time (ALL 0 - 31).	● MIDI jacks	IN, OUT
● DEG3 (FOR VCF & NOISE)	Attack time, Decay time, Break Point level, Slope time, Sustain level, Release time (ALL 0 - 31).	● DC 9V	AC adapter jack (300 mA minimum; use only recommended KORG adapter)
● MG	Frequency, Delay time, DCO intensity, VCF intensity (ALL 0 - 15).	● Strap pegs	2
● MIDI	Receive Channel (1 - 16), Program Change (ENABLE/DISABLE), Sequencer Clock (INT, EXT)	● Dimensions	W: 780 mm (31") × D: 286 mm (11.25") × H: 89 mm (3.5")
● TUNE	+/- 50 cents	● Weight	4.3 kg (10 lbs) (including batteries)
● Power	OFF, Master VOLUME	● Accessories	AC 9V adapter, Cassette tape of Factory Preload Programs, Shielded audio cord (2.5 m), batteries (UM-2 × 6)
● Joystick	X axis (+/- Pitch bend); + Y axis (DCO modulation); - Y axis (VCF modulation)		
● Bend	Maximum Pitch BEND (+/- 700 cents (Perfect 5th) MAX)		
● Sequencer	START/STOP, STEP, SPEED (Slow - Fast)		

OPTIONS

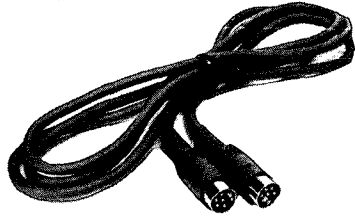

• MIDI CONNECTION CORD

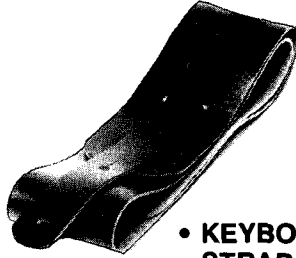

• KEYBOARD STRAP

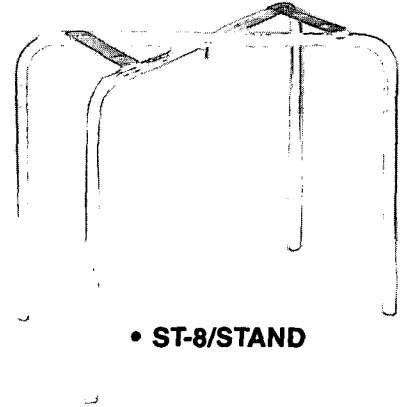

• ST-8/STAND

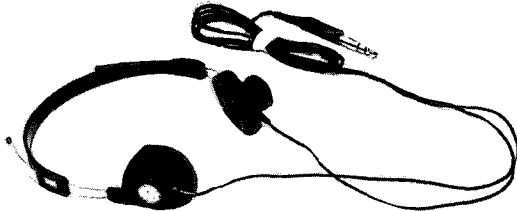

• KH-1/STEREO HEADPHONES

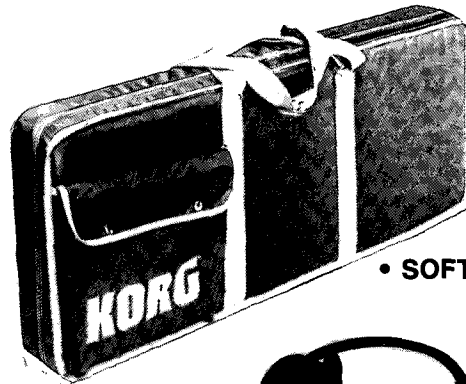

• SOFT CASE

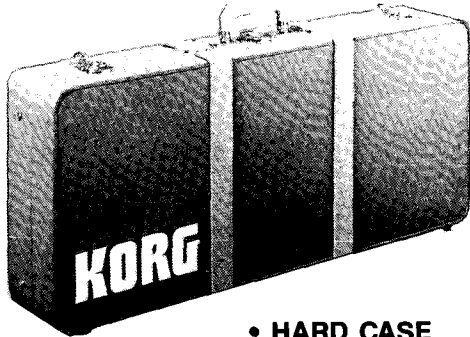

• HARD CASE



• PS-1/PEDAL SWITCH

NOTICE

KORG products are manufactured under strict specifications and voltages required by each country. These products are warranted by the KORG distributor only in each country. Any KORG product not sold with a warrantee card or carrying a serial number disqualifies the product sold from the manufacturer's/distributor's warrantee and liability. This requirement is for your own protection and safety.

KORG

KEIO ELECTRONIC LABORATORY CORP.
15-12, Shimotakaido 1-chome, Suginami-ku, Tokyo 168

© KEIO ELECTRONIC LABORATORY CORP. 1985

6007GH PRINTED IN JAPAN