

TABLE OF CONTENTS

	Page
INTRODUCTORY NOTE	1
CHAPTER 1 HOW TO USE THIS MANUAL	2
CHAPTER 2 INTRODUCTION TO THE COMPUTER	5
Description of System	5
Key and Switch Operations	6
Modes	7
All RESET Button	10
Contrast Control	11
Cell Replacement	11
CHAPTER 3 USING AS A CALCULATOR	15
Start Up	15
Shut Down	15
Auto OFF	15
Calculations in the CAL Mode	16
How to Read the Display	20
Basic Operations	22
Scientific Calculations in the CAL mode	25
Use of Parenthesis	28
Decimal Places	28
Priority level in the CAL Mode	29
Statistical Calculation	35
1. Single-variable Statistical Calculation	36
2. Two-variable Statistics and Linear Regression	37
Calculation Range	41
Matrix Calculation Function	44
Manual Calculation in the BASIC Mode	55
How to Manually Calculate	56
Recalling Entries	57
Errors	60
Serial Calculations	61
Negative Numbers	63
Compound Calculations and Parentheses	63
Using Variables in Calculations	64
Chained Calculations	66
Error Message	66
Scientific Notation	66

Limits	67
Last Answer Feature	68
Length of Formula	70
Scientific Calculations in the BASIC mode	70
Direct Calculation Feature	74
Priority in Manual Calculation	76
CHAPTER 4 CONCEPTS AND TERMS OF BASIC	77
String Constants	77
Hexadecimal Numbers	77
Variables	78
Fixed Variables	79
Simple Variables	80
Array Variables	81
Variables in the Form of A ()	84
Expressions	85
Numeric Operators	86
String Expressions	86
Relational Expressions	86
Logical Expressions	87
Parentheses and Operator Precedence	89
RUN Mode	90
Functions	90
CHAPTER 5 PROGRAMMING THE COMPUTER	91
Programs	91
BASIC Statement	91
Line Numbers	91
BASIC Verbs	92
BASIC Commands	92
Modes	92
Beginning to Program on the COMPUTER	93
Example 1 – Entering and Running a Program	93
Example 2 – Editing a Program	94
Example 3 – Using Variables in programming	96
Example 4 – More Complex Programming	98
Storing Programs in the Memory	99
CHAPTER 6 SHORT CUTS	101
The DEF Key and Labelled Programs	101
Template	102

CHAPTER 7	USING CE-126P PRINTER/CASSETTE INTERFACE	103
	Using Printer	103
	Using Cassette Interface	105
	Cassette Tape Recorder	105
	Operating the Cassette Interface and Recorder	107
	Tape Notes	110
CHAPTER 8	BASIC REFERENCE	111
	Commands	115
	Verbs	131
	Functions	176
	Pseudovariables	176
	Numeric Functions	179
	String Functions	185
CHAPTER 9	TROUBLESHOOTING	187
	Machine Operation	187
	BASIC Debugging	189
CHAPTER 10	MAINTENANCE OF THE COMPUTER	191
APPENDICES	193
APPENDIX A	Error Messages	193
APPENDIX B	Character Code Chart	197
APPENDIX C	Formatting Output	199
APPENDIX D	Expression Evaluation and Operator Priority	203
APPENDIX E	Key Functions in Basic Mode	205
APPENDIX F	Specifications	211
APPENDIX G	Using Programs Written on Other PC Models	213
PROGRAM EXAMPLES	219
INDEX	241

INTRODUCTORY NOTE

Welcome to the world of **SHARP** owners!

Few industries in the world today can match the rapid growth and technological advances being made in the field of personal computers. Computers which just a short time ago would have filled a huge room, required a Ph.D. to program, and cost thousands of dollars, now fit in the palm of your hand, are easily programmed, and cost so little that they are within the reach of nearly everyone.

Your new **SHARP** COMPUTER was designed to bring you all of the latest state-of-the-art features of this computing revolution and it incorporates many advanced capabilities:

- * **SCIENTIFIC CALCULATOR** – It had been normal to use two different tasks, scientific calculation (including statistics) and computing, before this computer. But now only one tool is enough. The computer operates both as a scientific calculator and a pocket computer incorporating many programmed scientific functions plus BASIC command keys for simple programming.
- * **MEMORY SAFEGUARD** – The computer remembers stored programs and variables even when you turn it off.
- * **Battery-powered operation for true portability.**
- * **AUTO POWER OFF** function which conserves the batteries by turning the power off if no activity takes place within a specified time limit.
- * An expanded version of BASIC which provides formatted output, two dimensional arrays, variable length strings, and many other advanced features.
- * **CE-126 printer/cassette interface** is provided.

Congratulations on entering an exciting and enjoyable new world. We are sure that you will find this purchase one of the wisest you have ever made. The **SHARP COMPUTER** is a powerful tool, designed to meet your specific mathematical, scientific, engineering, business, and personal computing needs. With the **SHARP COMPUTER** you can begin NOW providing the solutions you'll need tomorrow!

CHAPTER 1

HOW TO USE THIS MANUAL

This manual is designed to introduce you to the capabilities and features of your **COMPUTER** and to serve as a valuable reference tool. Whether you are a "first-time user" or an "old hand" with computers, you should acquaint yourself with the **COMPUTER** by reading and working through Chapters 2 through 6.

- * Chapter 2 describes the physical features of the **COMPUTER**.
- * Chapter 3 demonstrates the use of the **COMPUTER** as a scientific calculator.
- * Chapter 4 defines some terms and concepts which are essential for BASIC programming, and tells you about the special considerations of these concepts on the **COMPUTER**.
- * Chapter 5 introduces you to BASIC programming on the **COMPUTER**, showing you how to enter, correct, and run programs.
- * Chapter 6 discusses some short cuts that make using your new **COMPUTER** easier and more enjoyable.

Chapter 8 is a reference section covering all the commands, verbs, and functions of BASIC that are grouped and alphabetically arranged within each group for your convenience.

Experienced BASIC programmers may go direct from Chapter 6 to Chapter 8 to learn the specific features of BASIC as implemented on the **COMPUTER**. Since every dialect of BASIC is somewhat different, read through this material at least once before starting serious programming.

If you have never programmed in BASIC before, we suggest that you buy a separate book on beginning BASIC programming or attend a BASIC class, before trying to work through these chapters. This manual is not intended to teach you how to program.

The remainder of the manual consists of:

- * Chapter 7 — Basic information on the optional CE-126P Printer/Cassette interface.
- * Chapter 9 — A troubleshooting guide to help you solve some operating and programming problems.
- * Chapter 10 — The care and maintenance of your new **COMPUTER**.

Detailed Appendixes provide you with useful charts, comparisons, and special discussions concerning the use and operation of the **COMPUTER**.

How to Use this Manual

Using the Hard Cover

When the computer is not being used, place the hard (plastic) cover over the operation panel of the computer.

- When the computer is to be used

Remove the hard cover from the computer as shown in figure below.

Step ①

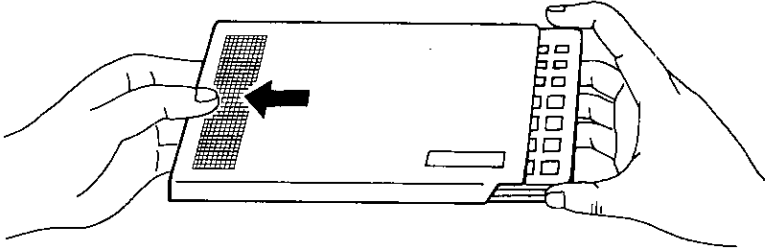

Step ②

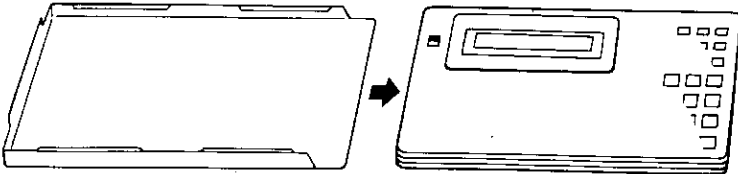

- When the computer is not used

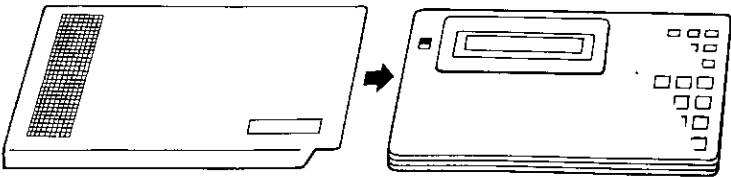

CHAPTER 2

INTRODUCTION TO THE COMPUTER

Description of System

The SHARP COMPUTER system consists of:

- * 77-character keyboard.
- * 24-digit display.
- * Powerful BASIC in 72K-byte ROM.
- * 8-bit CMOS processor.
- * Option: CE-126P Printer/Cassette Interface

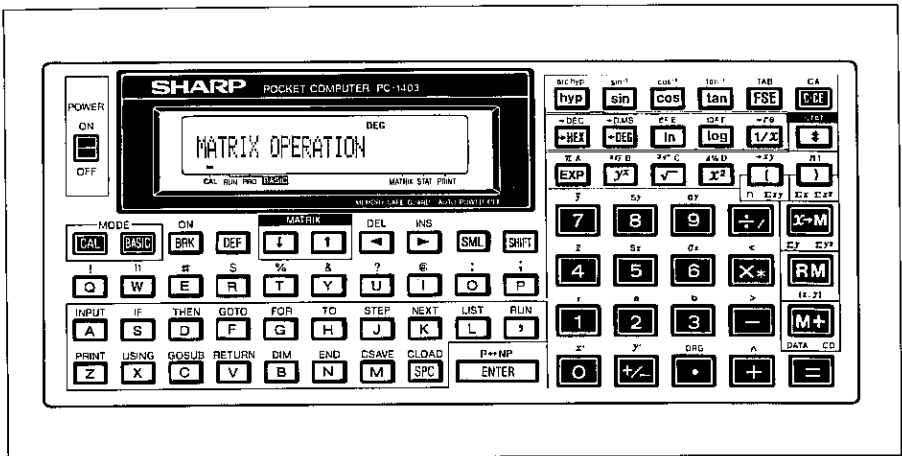

To familiarize you with the placement and functions of parts of the **COMPUTER** keyboard, we will now take up each section of the keyboard. First, just locate the keys and read the description of each. In Chapter 3 we will begin using your new machine.

Key and Switch Operations

This **COMPUTER** has 77 keys and one slide switch on its panel. Each key function is identified by various letters, numbers, or symbols inscribed on or above the keys.

(1) Power on

To begin with, turn your computer on.

The **POWER** switch is located at the upper left corner of the computer. Slide the switch to the **ON** position.

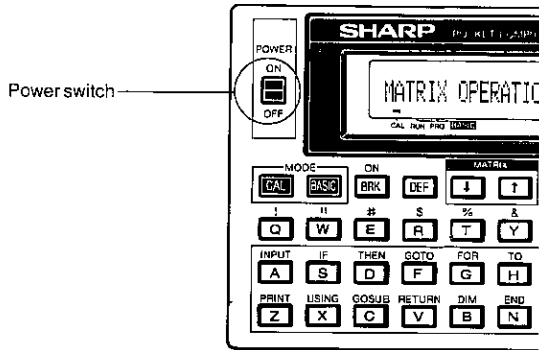

You will see the following initial information in the display:

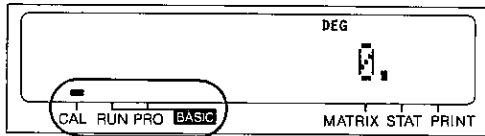

A dash (—) indicator in the lower left area of the display shows the mode in which the computer is now set. When this computer has just been turned on, it functions as a calculator. To show that the computer is in the calculator mode, a dash indicator appears above the **CAL** (**CAL**culator) label.

For calculator operations in the **CAL** mode, refer to **CHAPTER 3, USING THE COMPUTER AS A CALCULATOR**.

Modes

The computer can operate basically in three different modes. One mode is the CAL mode, in which you can use your computer just like a calculator.

Another mode is the RUN mode, in which you can execute your program or manual calculation using BASIC commands.

The third mode is the PRO mode, which allows you to store your program into the computer or correct or amend a stored program.

Switching between these modes can be accomplished by the green **CAL** and **BASIC** keys. The selected mode is identified with a dash (—) indicator displayed just above the CAL, RUN, PRO, or BASIC label in the lower left area of the display.

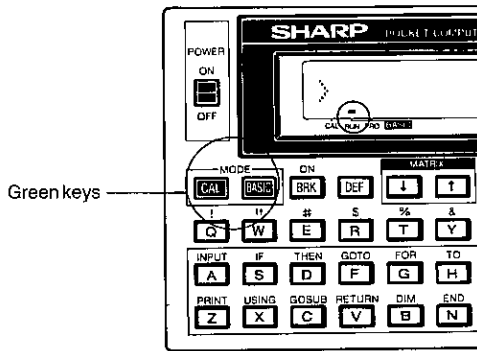

Now switch your computer off, then on again. The CAL mode will be selected.

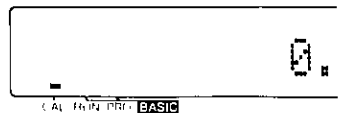

If you press the **BASIC** key when in the CAL mode, the RUN mode will be selected.

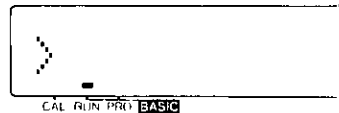

If you press the **BASIC** key when in the RUN mode, the PRO mode will be selected.

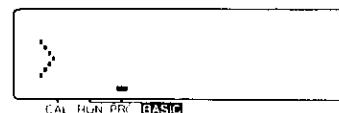

Introduction to the Computer

Thus the RUN and PRO modes are selected alternately each time you press the **BASIC** key.

The computer will return to the CAL mode if you press the **CAL** key.

Mode switching

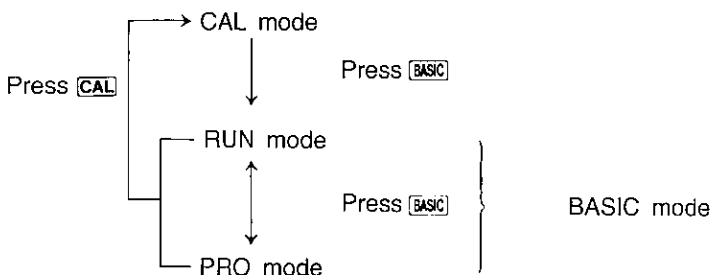

1. CAL mode

Now let's operate the keys.

Set your computer in CAL mode first. In CAL mode the keys and functions shown at right can be used for calculation.

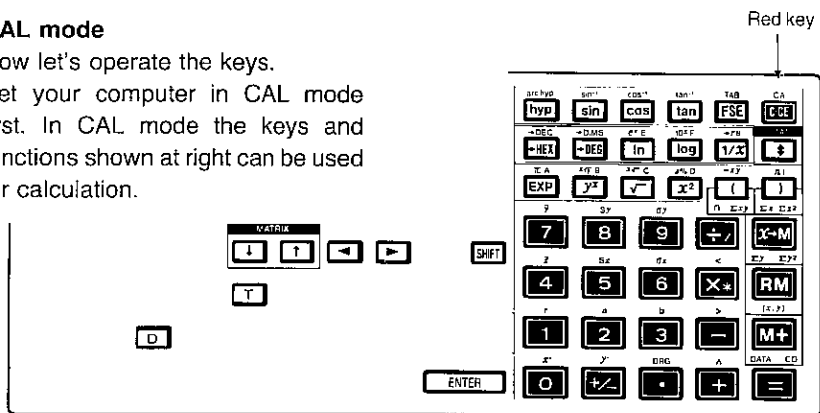

Display

C-CE (Red key)	→	0.
1 2	→	12.
+	→	12.
3	→	3.
=	→	15.

2. RUN and PRO modes

Change the CAL mode to RUN or PRO by using the **BASIC** key, and press the following keys while watching the display:

In RUN and PRO modes the keys shown below can be used for calculations.

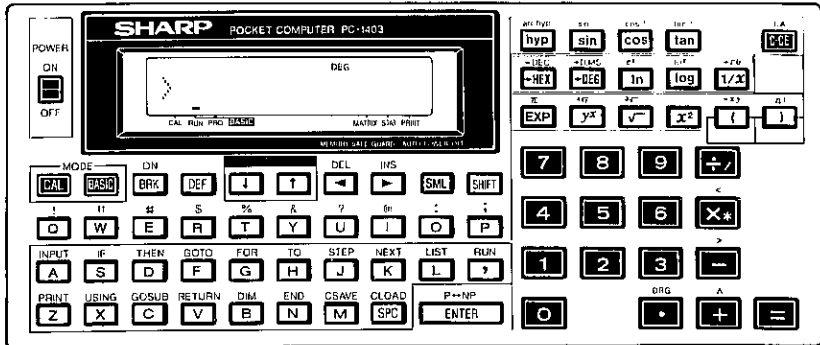

Example:

PRINT Z	USING X	GOSUB C	→	ZXC_		
r 1	a 2	DRG .	b 3	→	ZXC12.3_	
CA C-CE				→	>	
INPUT A	=	\bar{x} 4	$\hat{+}$	S_x 5	→	A=4 + 5_
						↑ Cursor

If you press an alphabet or number key, the item denoted on the key will be entered. When you wish to enter the character or symbol denoted in brown above each key, press the yellow **SHIFT** key before operating the key.

CA C-CE	SHIFT	PRINT Z	→	PRINT_	
SHIFT	W	($\sqrt{\quad}$	→	PRINT " $\sqrt{\quad}$ _

The **SHIFT** key is used to enter the characters or symbols inscribed in brown above each key that has two or three functions. If you repeatedly press the **SHIFT** key, the SHIFT symbol at the top of the display will go on and off. The SHIFT symbol indicates that the **SHIFT** key is activated and the characters in brown can be entered.

All RESET Button

ALL RESET: Reset button. This button is used to reset the computer when Clear (C-CE) or CA is not sufficient to correct a problem.

To reset the computer, hold down any key on the keyboard and simultaneously press the RESET button on the back. This preserves all programs and variables in memory.

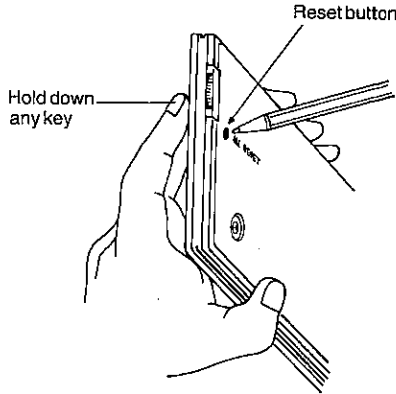

Note: When you press the RESET button, keep pressing it for at least 2 or 3 seconds. If you press the button for a shorter duration, the RESET button may not be activated.

Press the RESET button with a pointed object such as a ballpoint pen. Do not use easily broken points, such as mechanical pencils or the tips of needles, nor points thicker than the hole for the button.

If you get no response from any key even when the above operation is performed, push the RESET button only and the following message will appear on the display.

JUST
MEMORY ALL CLEAR O.K.?

Then press one of the **ENTER**, **Y**, and **=** keys.

Note: If none of the keys is pressed for about 2 minutes after the above display, the COMPUTER is automatically powered off.

This operation will clear all the memory contents (program and data), so do not press the RESET button without depressing any key unless absolutely necessary.

Contrast Control

Your computer has on its right side when viewed from the front, a control for adjusting the contrast of the display. Adjust the display for visibility.

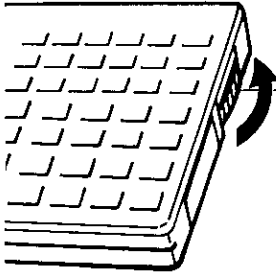

Contrast Control

Turn the control in the arrow direction (counterclockwise) for a higher contrast and in the opposite direction (clockwise) for a lower contrast.

Cell Replacement

The **COMPUTER** normally operates on the two built-in lithium cells.

When replacing the cells, following these cautionary instructions will eliminate many problems:

- Always replace both cells at the same time.
- Do not mix a new cell with a used cell.
- Use only the specified type of lithium cells (CR-2032) (two required).

When to Replace the Cells

If the display is dim and difficult to see when viewed from the front even after the contrast control has been turned counterclockwise as far as it goes, the cell voltage is too low. In this case, replace the cells promptly.

Note: If you are using the optional CE-126P cassette interface, save your programs and data in memory onto a cassette tape before replacing the cells.

How to Replace the Cells

- (1) Turn off the computer by sliding the power switch to the OFF position.
- (2) Remove the screws from the back cover with a small phillips screwdriver. (Fig. 1)

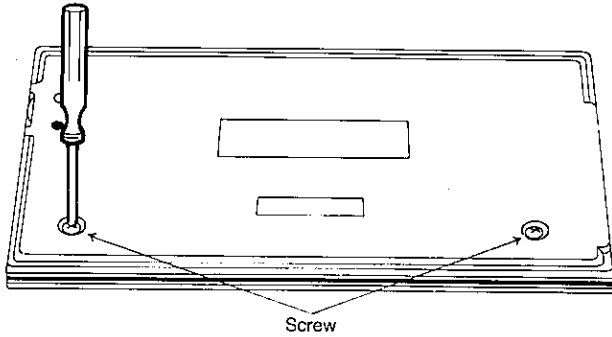

Fig. 1

- (3) Remove the cell cover by sliding it in the arrow direction shown in Figure 2.

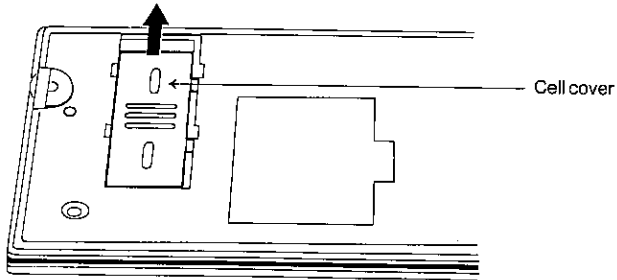

Fig. 2

- (4) Replace the two cells (Fig. 3).

Always replace both of the cells at the same time

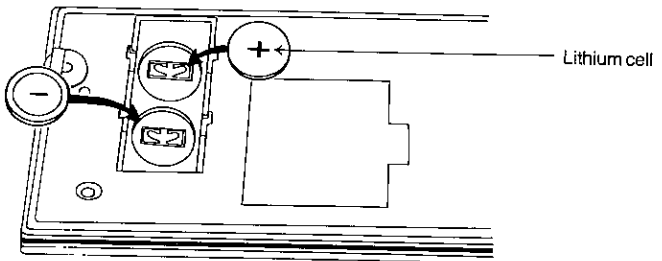

Fig. 3

- (5) Replace the cell cover by sliding it in the reverse direction of the arrow shown in Figure 2.
- (6) Hook the claws of the back cover into the slits of the computer proper. (Fig. 4)

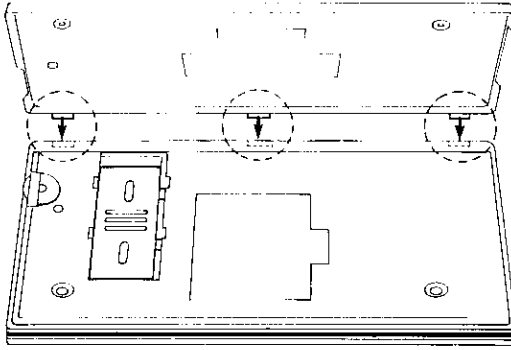
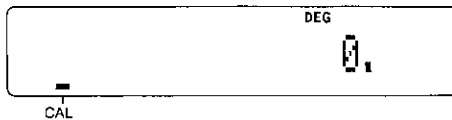

Fig. 4

- (7) Push the back cover in slightly while replacing the screws.
- (8) Turn on the computer by sliding the power switch to the ON position and press the RESET button to clear the computer. And then press **ENTER**.
The display should look like this:



If the display is blank or display any symbol other than " _ 0.", remove the cells and install them again, then check the display.

Note: Keeping a dead cell in the computer may result in damage to the computer from solution leakage of the cell. Remove a dead cell promptly.

CAUTION: Keep cell out of reach of children.

CHAPTER 3

USING AS A CALCULATOR

Now that you are familiar with the layout and components of your new **SHARP COMPUTER**, we will begin investigating its exciting capabilities.

Because the **COMPUTER** allows you the full range of calculating functions, plus the increased power of BASIC programming abilities (useful in more complex calculations), it is commonly referred to as a "smart" calculator. That, of course, makes you a "smart" user!

(Before using the **COMPUTER**, be sure that the two lithium cells supplied as an accessory have been correctly installed.)

Start Up

To turn ON the **COMPUTER**, slide the power switch up.

When you wish to use your **COMPUTER** as a scientific calculator, place the **COMPUTER** in the CAL mode. The CAL mode is selected when the **COMPUTER** is switched on or the **CAL** key is pressed. When the CAL mode has been selected, a dash (-) indicator will appear just above the CAL label in the lower left area of the display

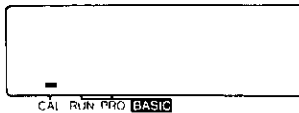

If the dash (-) indicator is above the RUN or PRO label, press the **CAL** key or turn the power off and then on again to select the CAL mode.

Shut Down

To turn off the **COMPUTER**, slide the power switch to the OFF position.

Each time you turn off the machine, the display will be cleared.

Auto OFF

To conserve on battery power, the **COMPUTER** automatically turns off when no keys have been pressed for about 11 minutes. (Note: The **COMPUTER** will not AUTO OFF while you are executing a program.)

To restart the **COMPUTER** after an AUTO OFF, press the **ON** **BRK** key located at the right of the green **BASIC** key.

Using as a Calculator

Note that the computer returns to the CAL mode when the **ON** **BRK** key is pressed after the AUTO OFF.

Calculations in the CAL Mode

In the CAL mode, the keys and functions shown at right can be used for calculation.

Note: In the CAL mode, the results of calculations cannot be output on the printer.

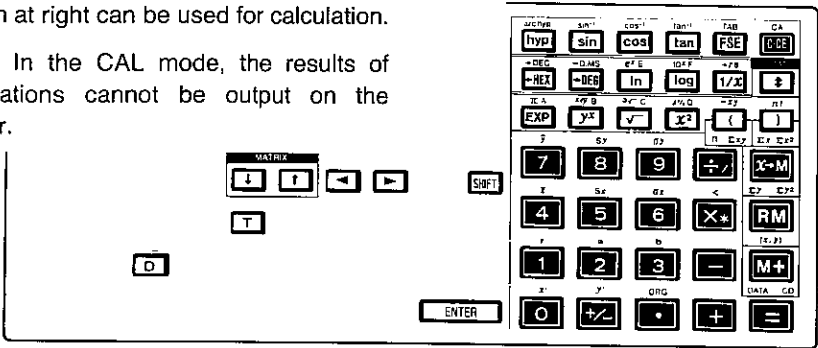

Now let us try some simple calculations. Press the following keys while watching the display:

Input

r	a	b
1	2	3

+

ax	Sx	x̄
6	5	4

=

↑

Press the equal key

Display

123.
123.
654.
777.

(123 + 654 = 777)

Did you get the correct answer? If you didn't, turn the computer off, then on again, and try the same calculation.

Now let us call the value of pi (π).

Symbol " π " is inscribed just above the **EXP** key in brown. The functions identified by brown letters can be used by first pressing the yellow **SHIFT** key, and then pressing the required function key.

Now press **SHIFT** **EXP** .

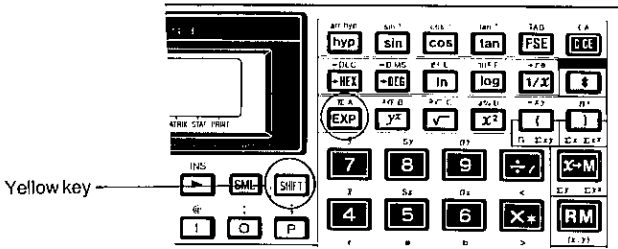

Input

SHIFT EXP

Display

3.141592654

($\pi \approx 3.141592654$)

What you see in the display is the value of π .

Next, let us compute 10^4 . For this calculation, you should use the function 10^x . This function is also identified by a brown letter, so the SHIFT key must be pressed before the function key is pressed:

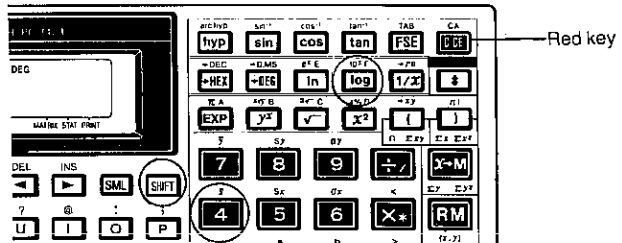

Input

SHIFT 4 SHIFT log

Display

10000.

($10^4 = 10000$)

The following outlines the major key functions:

* **C-CE** (clear) (red key)

If this key is pressed immediately after numeric data is entered or the contents of the memory are recalled, that data will be cleared. In any other case, operation of the **C-CE** key will clear the operators and/or numeric data that have been entered. The contents of the memory are not cleared with the **C-CE** key operation.

Using as a Calculator

Input	Display	Input	Display
123 $+$ 456	456.	6 \times 2 $+$	12.
C-CE	0.	C-CE	0.
789 $=$	912.	6 \div 2 $+$	3.
	(123 + 789 = 912)	5 $=$	8.

The C-CE key may also be used to clear an error.

Input	Display
5 \div 0 $=$	0. E ← Error symbol
C-CE	0.

* FSE (display mode switch)

This key is used to switch the display mode for the result of a calculation from the floating point decimal system (normal mode) to the fixed point decimal, scientific notation, or engineering notation system, or vice versa.

Input	Display
23 \times 1000 $=$	23000. (Normal)
FSE	FIX 23000.000 (FIX)
FSE	SCI 2.300E 04 (SCI)
FSE	ENG 23.000E 03 (ENG)

* TAB (specifies the number of decimal places)

This key is used to specify the number of decimal places when used in conjunction with a numeral key. Turn off the power switch and then on again. Press FSE key and the display will show "0.000" (FIX mode).

Input	Display
SHIFT FSE 2	FIX 0.00

(1) Specifies 2 decimal places.

5 \div 8 =

FIX 0.63

(2) Specifies 5 decimal places.

Input: SHIFT F5E 5

Display: FIX 0.62500

(2)

* **DRG** (specifies angular unit.)

This key is used to specify the angular units for numeric data used in trigonometric functions, inverse trigonometric functions, or coordinates conversion.

Input

Display

DEG (Degrees)

SHIFT DRG

RAD (Radians)

SHIFT DRG

GRAD (Grads)

SHIFT DRG

DEG (Degrees)

$$180^\circ = \pi \text{ (rad)} = 200^g$$

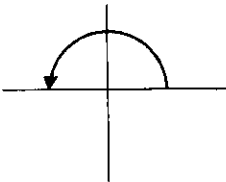

DEG: Degree [°]

RAD: Radian [rad]

GRAD: Grad [g]

* 0 to 9, ., EXP and +/-

EXP: Used to enter a number in exponential form (the display shows "E" following the number entered).

Using as a Calculator

Input	Display
4 $\frac{\pi}{A}$ $\frac{1}{EXP}$ 3	4.E 03 (4×10^3)
$\frac{1}{=}$	4000.
$\frac{1}{+/-}$	-4000.

$\frac{1}{+/-}$: Used to enter a negative number (or to reverse the sign from negative to positive).

Input	Display
1.23 $\frac{1}{+/-}$	-1.23
$\frac{1}{EXP}$ 5 $\frac{1}{+/-}$	-1.23E-05 (-1.23×10^{-5})
$\frac{1}{=}$	-0.0000123
$\frac{1}{+/-}$	0.0000123

How to Read the Display

This section describes the display formats and symbols used in the CAL mode.

Normal display format

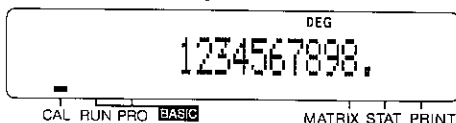

Exponential display format

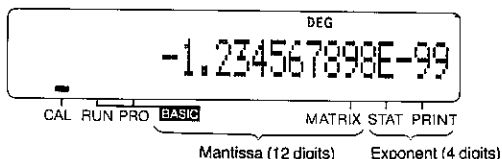

The computer has a 24-digit display, of which 16 digits are used to display numbers. In the CAL mode, calculation results are normally displayed in the floating decimal point system. If the result is smaller than 0.000000001 or greater than 999999999 (greater than -0.000000001 or smaller than -999999999), it is displayed in exponential format. In the exponential format, the mantissa part of a number is displayed to 12 significant digits, while the exponent part is displayed to 4 significant digits (including a decimal point, sign, and symbol).

Display symbols

The following describes the symbols and indicators that appear in the display to show the mode, status, or condition of the computer.

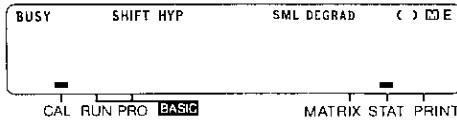

The computer uses the symbols and indicators shown above, whose meanings are the following:

SHIFT: This word comes on when the **SHIFT** key is activated, indicating that the second function of a key identified by a brown label can be selected. To release the SHIFT mode, press the **SHIFT** key a second time.

HYP: This word comes on when the **hyp** key is pressed, indicating that a hyperbolic function has been selected. If **SHIFT** **hyp** are pressed, a phrase, SHIFT HYP, comes on to indicate that an inverse hyperbolic function has been selected.

SML: This word comes on when the **SML** key is pressed, indicating that the lower case mode for the alphabetic characters is selected.

DEG

RAD

GRAD: These words are selected sequentially each time **SHIFT** **DRG** keys are operated. Each of these words indicates the angular units for trigonometric functions, inverse trigonometric functions, and coordinates conversion, respectively.

DEG: Degree [°]

RAD: Radian [rad]

GRAD: Grad [g]

(180 deg. = π rad = 200g)

(): This symbol comes on when parentheses are used in a calculation formula by means of the **()** key.

M : This symbol comes on when a number other than zero is stored in the calculation memory, to indicate that the memory is in use.

E: This symbol comes on if an error has occurred. The error can be cleared by operating the **C-CE** key.

Using as a Calculator

STAT: Pressing the **SHIFT** **STAT** keys in the CAL mode causes a dash (-) indicator to appear just above the STAT label in the lower right area of the display. The STAT stands for statistics and indicates that the computer is in the STAT (statistical calculation) mode.

CAL: If a dash (-) indicator appears just above the CAL label in the lower left area of the display, it indicates that the computer is in the CAL (calculation) mode.

BUSY: This indicator comes on while the computer is performing an arithmetic operation.

MATRIX: Pressing **SHIFT** **↓** or **SHIFT** **↑** in the CAL mode causes a dash indicator (-) to appear above the MATRIX label in the lower right area of the display. The MATRIX indicator indicates that the computer is ready to perform a matrix operation.

To release the MATRIX mode, press either key combination a second time.

Basic Operations

This section describes the basic operations of the computer in the CAL mode. Before starting, turn on the power of your computer. First, press the **CAL** key to place the computer in the CAL mode. Then press **C-CE** **C-CE**, and make sure that the display shows the following initial information.

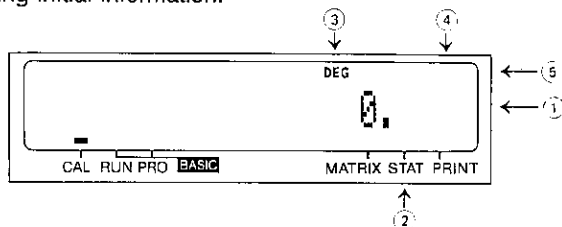

If not, read the following description and take the necessary action:

- ① More than one zero is displayed (e.g., 0.00):
The number of fractional digits is being specified. Clear the TAB setting by turning off the power switch then on again. The COMPUTER is now in the normal display mode.
- ② A dash (-) indicator is displayed at the STAT or MATRIX label:
The computer is in the statistical calculation mode. Press **SHIFT** **STAT** to release the STAT mode. Press **SHIFT** **↓** or **SHIFT** **↑** to release the MATRIX mode.
- ③ RAD or GRAD is displayed instead of DEG:
The RAD, GRAD, and DEG indicate angular units for display data. Any of these symbols may be displayed unless a trigonometric function, inverse trigonometric function, or coordinate conversion is to be executed. Each of these symbols can be sequentially selected by operating **SHIFT** **DRG**.

- (4) Symbol \boxed{M} is displayed:

Numeric data is already in the memory. This symbol can be cleared by $\boxed{C-CE}$ $\boxed{[x\rightarrow M]}$.

- (5) All symbols displayed in the upper area of the display can be cleared with the $\boxed{C-CE}$ key, with the exception of those described in the above items (3) and (4).

In this manual, the key functions are shown as follows:

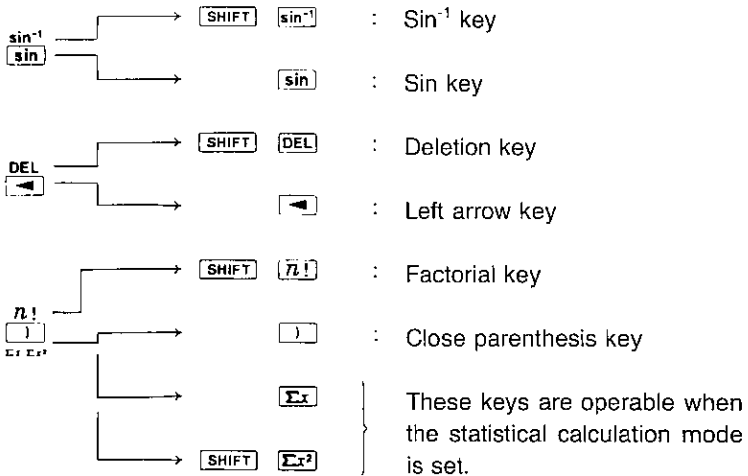

1. Addition, Subtraction

Key in the following: $12 \boxed{+} 45.6 \boxed{-} 32.1 \boxed{+} 789 \boxed{-} 741 \boxed{+} 213 \boxed{=}$
 Answer: 286.5

2. Multiplication, Division

a. Key in the following: $841 \boxed{\times} 586 \boxed{\div} 12 \boxed{=}$
 Answer: 41068.83333

b. Key in the following: $427 \boxed{+} 54 \boxed{\times} 32 \boxed{\div} 7 \boxed{-} 39 \boxed{\times} 2 \boxed{=}$
 Answer: 595.8571429

Note that multiplication and division have priority over addition and subtraction. In other words, multiplication and division will occur before addition and subtraction.

Using as a Calculator

Constant Multiplication: The first number entered is a constant.

Key in: 3 \times 5 $=$

Answer: 15

Key in: 10 $=$

Answer: 30

Constant Division: The number entered after the division sign is a constant.

Key in: 15 \div 3 $=$

Answer: 5

Key in: 30 $=$

Answer: 10

Note: The machine places some calculations in pending status depending on their priority levels. Accordingly, in successive calculations the operator and numerical value of the calculation last performed in the computer are handled as a calculating instruction and a constant for the next calculation, respectively.

$a + b \times c =$ $+bc$ (Constant addition)

$a \times b \div c =$ $\div c$ (Constant division)

$a \div b \times c =$ $\frac{a}{b} \times$ (Constant multiplication)

$a \times b - c =$ $-c$ (Constant subtraction)

3. Memory Calculations

The independently accessible memory can be accessed by using the three keys: $\boxed{X \rightarrow M}$, \boxed{RM} , $\boxed{M+}$. Before starting a calculation, clear the memory by pressing $\boxed{C-CE}$ and $\boxed{X \rightarrow M}$.

Key in: 12 $+$ 5 $M+$ Answer: 17

To subtract, key in: 2 $+$ 5 $=$ $+/-$ $M+$

Answer to this equation: -7

Key in \boxed{RM} to recall memory: 10 is displayed.

Key in: 12 \times 2 $=$ $X \rightarrow M$

Answer: 24 (Also takes place of 10 in memory)

Key in: 8 \div 2 $M+$

Answer: 4 \boxed{RM} : 28

Note: Memory calculations are impossible in the STAT (Statistical calculation) mode.

When subtracting a number from the memory, press the $\boxed{+/-}$ and $\boxed{M+}$ keys.

Scientific Calculations in the CAL mode

To perform trigonometric or inverse trigonometric functions, and coordinates conversion, designate the angular unit for the calculation. The angular unit "DEG, RAD, or GRAD" is designated by the SHIFT and DRG keys.

1. Trigonometric functions

Set the angular unit to "DEG".

Calculate: $\text{Sin } 30^\circ + \text{Cos } 40^\circ =$

Key in the following: 30 sin + 40 cos =

Answer: 1.266044443

Calculate: $\text{Cos } 0.25\pi$

Set the angular unit to "RAD".

Key in: .25 X SHIFT PI = cos (Remember to use the SHIFT key.)

Answer: 0.707106781

2. Inverse Trigonometric Functions:

Calculate: $\text{Sin}^{-1} 0.5$

Set the angular unit to "DEG".

Key in: .5 SHIFT sin^{-1}

Answer: 30

Calculate: $\text{Cos}^{-1} -1$

Set the angular unit to "RAD".

Key in: 1 +/- SHIFT cos^{-1} To enter a negative number, press the +/- key after a number.

Answer: 3.141592654 (Value of π)

The calculation results of the respective inverse trigonometric functions will be displayed within the following limits.

$$\theta = \sin^{-1} \chi, \theta = \tan^{-1} \chi$$

$$\theta = \cos^{-1} \chi$$

$$\text{DEG: } -90 \leq \theta \leq 90 [^\circ]$$

$$\text{DEG: } 0 \leq \theta \leq 180 [^\circ]$$

$$\text{RAD: } -\pi \leq \theta \leq \pi \text{ [rad]}$$

$$\text{RAD: } 0 \leq \theta \leq \pi \text{ [rad]}$$

$$\text{GRAD: } -100 \leq \theta \leq 100 \text{ [g]}$$

$$\text{GRAD: } 0 \leq \theta \leq 200 \text{ [g]}$$

3. Hyperbolic and Inverse Hyperbolic Functions

Calculate: $\text{Sinh } 4$

Key in: 4 hyp sin

Answer: 27.2899172

Calculate: $\text{Sinh}^{-1} 9$

Key in: 9 SHIFT archyp sin

Answer: 2.893443986

4. Power Functions

Calculate: 20^2

Key in: 20 X^2

Answer: 400

Using as a Calculator

Calculate: 3^3 and 3^4

Key in: 3 $\boxed{y^x}$ 3 $\boxed{=}$

Answer: 27

Key in: 3 $\boxed{y^x}$ 4 $\boxed{=}$

Answer: 81

5. Roots

Calculate: $\sqrt{25}$

Key in: 25 $\boxed{\sqrt{\quad}}$

Answer: 5

Calculate: Cubic root of 27

Key in: 27 $\boxed{\text{SHIFT}}$ $\boxed{\sqrt[3]{\quad}}$

Answer: 3

Calculate: Fourth root of 81

Key in: 81 $\boxed{\text{SHIFT}}$ $\boxed{\sqrt[4]{\quad}}$ 4 $\boxed{=}$

Answer: 3

6. Logarithmic Functions

Calculate: $\ln 21$, $\log 173$

Natural Logarithms:

Key in: 21 $\boxed{\ln}$

Answer: 3.044522438

Common Logarithms:

Key in: 173 $\boxed{\log}$

Answer: 2.238046103

7. Exponential Functions

Calculate: $e^{3.0445}$

Key in: 3.0445 $\boxed{\text{SHIFT}}$ $\boxed{e^x}$

Answer: 20.99952881 (21 as in item "6" above)

Calculate: $10^{2.238}$

Key in: 2.238 $\boxed{\text{SHIFT}}$ $\boxed{10^x}$

Answer: 172.9816359 (173 as in item "6" above)

8. Reciprocals

Calculate: $1/6 + 1/7$

Key in: 6 $\boxed{1/x}$ $\boxed{+}$ 7 $\boxed{1/x}$ $\boxed{=}$

Answer: 0.309523809

9. Factorial

Calculate: $69!$

Key in: 69 $\boxed{\text{SHIFT}}$ $\boxed{n!}$

Answer: 1.711224524E 98 ($=1.711224524 \times 10^{98}$)

Note that the section on Errors deals with the calculation limits of the computer.

Calculate: ${}_8P_3 = \frac{8!}{(8-3)!} =$

Key in: 8 $\boxed{\text{SHIFT}}$ $\boxed{n!}$ $\boxed{\div}$ $\boxed{(}$ 8 $\boxed{-}$ 3 $\boxed{)}$ $\boxed{\text{SHIFT}}$ $\boxed{n!}$ $\boxed{=}$

Answer: 336

10. Percent calculations

Calculate: 45% of 2,780 ($2,780 \times \frac{45}{100}$)

Key in: 2780 $\boxed{\times}$ 45 $\boxed{\text{SHIFT}}$ $\boxed{\%}$

Answer: 1251

Calculate: $\frac{547 - 473}{473} \times 100$

Key in: 547 $\boxed{-}$ 473 $\boxed{\text{SHIFT}} \boxed{\Delta\%}$

Answer: 15.6448203

11. Angle/Time conversions

To convert an angle given in the sexagesimal system (degrees/minutes/seconds) to its decimal equivalent, a value in degrees must be entered as an integer and values in minutes and seconds as decimal fractions, respectively.

Convert $12^\circ 47' 52''$ to its decimal equivalent.

Key in: 12.4752 $\boxed{\text{DEG}}$

Answer: 12.79777778

When converting an angle in decimal degrees to its sexagesimal equivalent (degrees/minutes/seconds), the answer is broken down: integer part = degrees; 1st and 2nd decimal digits = minutes; 3rd and 4th digits = seconds; and the 5th digit and up = fractional seconds.

Convert 24.7256 to its sexagesimal equivalent (degrees/minutes/seconds)

Key in: 24.7256 $\boxed{\text{SHIFT}} \boxed{\text{DMS}}$

Answer: 24.433216 or $24^\circ 43' 32''$

A racehorse has the track times of 2 minutes 25 seconds, 2 minutes 38 seconds, and 2 minutes 22 seconds. What is the average running time of the horse?

Key in: .0225 $\boxed{\text{DEG}} \boxed{+}$.0238 $\boxed{\text{DEG}} \boxed{+}$.0222 $\boxed{\text{DEG}} \boxed{=}$

Answer 1: 0.123611111

Key in: $\boxed{\div}$ 3 $\boxed{=}$

Answer 2: 0.041203703

Key in: $\boxed{\text{SHIFT}} \boxed{\text{DMS}}$

Answer 3: 0.022833333 or the average time is 2 minutes 28 seconds

12. Coordinates Conversion

Converting rectangular coordinates to polar ($x, y \rightarrow r, \theta$)

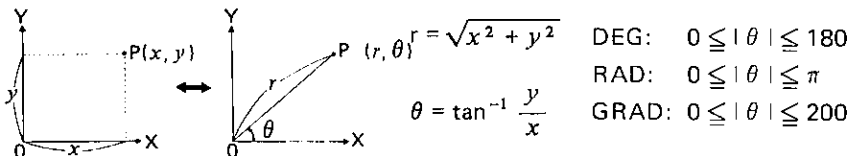

Solve for $x = 6$ and $y = 4$

Angular unit: DEG

Key in: 6 $\boxed{\div}$ 4 $\boxed{\text{SHIFT}} \boxed{\rightarrow r \theta}$

Answer: 7.211102551 (r)

Key in: $\boxed{\div}$

Answer: 33.69006753 (θ)

Calculate the magnitude and direction (phase) in vector $i = 12 + j9$

Key in: 12 $\boxed{\div}$ 9 $\boxed{\text{SHIFT}} \boxed{\rightarrow r \theta}$

Answer: 15 (r)

Key in: $\boxed{\div}$

Answer: 36.86989765 (θ)

Using as a Calculator

Converting polar coordinates to rectangular ($r, \theta \rightarrow x, y$)

Solve for P ($14, \pi/3$), $r = 14$, $\theta = \pi/3$)

Angular unit: RAD

Key in: **SHIFT** **π** **\div** 3 **=** **\downarrow** 14 **\uparrow** **SHIFT** **$\rightarrow xy$**

Answer: 7.000000002 (x)

Key in: **\downarrow**

Answer: 12.212435565 (y)

In the above example, $\theta = \pi/3$ is input first and is replaced with $r = 14$ by pushing the **\downarrow** key after r is input.

Use of Parenthesis

The parentheses keys are needed to cluster together a series of operations when it is necessary to override the priority system of algebra. When parentheses are in use on the **COMPUTER**, the symbol “()” will appear in the display.

Calculations in parentheses have priority over other calculations. Parentheses in the CAL mode can be used up to 15 times in a single level. A calculation within the innermost set of parentheses will be performed first.

Calculate: $12 + 42 \div (8 - 6)$

Key in: 12 **+** 42 **\div** **(** 8 **-** 6 **)** **=**

Answer: 33

Calculate: $126 \div [(3 + 4) \times (3 - 1)]$

Key in: 126 **\div** **(** **(** 3 **+** 4 **)** **\times** **(** 3 **-** 1 **)** **)** **=**

Answer: 9

Note: The **)** keys located just before the **=** or **M+** key can be omitted.

Decimal Places

The **SHIFT** and **TAB** keys are used to specify the number of decimal places in the calculation result. The number of decimal places after the decimal point is specified by the numeral key (**0** ~ **9**) pressed after the **SHIFT** and **TAB** keys. In this case, the display mode must be FIX (fixed decimal point), SCI (scientific notation), or ENG (engineering notation).

SHIFT **TAB** **0** → Designates 0 decimal place.
(The 1st decimal place is rounded.)

SHIFT **TAB** **1** → Designates 1 decimal place.
(The 2nd decimal place is rounded.)

SHIFT **TAB** **9** → Designates 9 decimal places.
(The 10th decimal place is rounded.)

To clear the TAB setting (designation of the decimal places), turn off the power switch and then on again. The display is now in the normal display mode.

Example:

SHIFT **TAB** **9** → 0.055555556 (FIX mode)
◦ **5** **[÷]** **9** **[=]** (The 10th decimal place is rounded.)

FSE → 5.555555556E-02 (SCI mode)
 (The 10th decimal place of the mantissa part is rounded.)

SHIFT **TAB** **3** → 5.556E-02 (SCI mode)
 (The 4th decimal place of the mantissa part is rounded.)

FSE → 55.556E-03 (ENG mode)

FSE → 0.055555555
 This is determined by the computer in the form of $5.555555555 \times 10^{-2}$. Rounding the 11th digit of the mantissa results in $5.555555556 \times 10^{-2}$. When changed to the floating decimal point display, the rounded part may not be displayed as in this example.

Priority Levels in CAL Mode

The machine is provided with a function that judges the priority levels of individual calculations, which permits keys to be operated according to a given mathematical formula. The following shows the priority levels of individual calculations.

Level Operations

- (1) Functions, such as \sin , x^2
- (2) y^x , $\sqrt[y]{x}$
- (3) x , \div (Calculations which are given the same priority level are executed in their sequence of input.)
- (4) $+$, $-$
- (5) $=$, $M+$, $\Delta\%$

Using as a Calculator

Ex. Key operation and sequence of calculation in $5 + 2 \times \sin 30 + 24 \times 5^3 =$

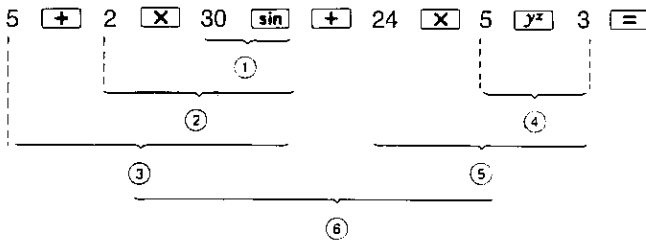

The numbers ① ~ ⑥ indicate the sequence in which the calculations are carried out.

When calculations are executed from the higher priority one in sequence, a lower priority one must be set aside. The machine is provided with a memory area for up to eight levels of pending operations.

As the memory area can also be used in a calculation including parentheses, calculations can be performed according to a given mathematical formula unless the levels of parentheses and/or pending operations exceed 8 in total.

- Single-variable functions are calculated immediately after key operation without being retained. (x^2 , $1/x$, $n!$, \rightarrow DEG, \rightarrow DMS, etc.)

Calculation without using parentheses

Ex. $1 + 2 =$

Pending of 1 level

①

$1 + 2 \times 3 =$

Pending of 2 levels

①

②

$1 + 2 \times 3^{y^x} 4 =$

Pending of 3 levels

①

②

③

$1 + 2 \times 3^{y^x} 4 \div 5$

With the y^x pressed, 3 calculations remain pending. Pressing the \div key executes the calculations of "y^x" highest in priority level and "x" identical in priority level. After the \div key is pressed, the other 2 calculations will remain pending.

①

②

③

②

Using as a Calculator

Hex numbers A through F can be entered by first placing your computer in the Hex mode (with **[+HEX]** key), then pressing the respective keys shown in figure.

The symbol HEX indicates that the numeric data shown in the display is a hex number, and that you can perform any basic arithmetic operations on hex numbers.

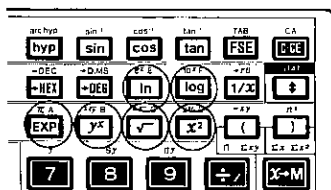

To clear the Hex mode, operate **[SHIFT] [DEC]**. You cannot clear it with the **[C-CE]** key.

1. Decimal to hex conversion

Example: Convert decimal number 30 into its hexadecimal equivalent:

Key in: 30 **[+HEX]** Answer: **1E. HEX**

To perform a new conversion, temporarily clear the HEX mode with **[SHIFT] [DEC]**.

Example: Convert decimal number -2, into its hexadecimal equivalent.

Temporarily clear the HEX mode with **[C-CE] [SHIFT] [DEC]**.

Key in: **[2] [+/-] [+HEX]**

Answer: **FFFFFFFE. HEX**

- If you attempt decimal-to-hex conversion on a negative decimal number, the computer internally performs "two's complement" calculation and shows the result in 16's complement.
- The **[+/-]** key may be used to reverse the positive or negative sign of the numeric data now in the display. If the sign of a positive hex number is reversed, the complement of the positive number will be obtained in the display.

Example: Convert decimal number 123.4 into its hexadecimal equivalent.

Key in: **[SHIFT] [DEC] 123.4 [+HEX]**

Answer: **7B. HEX**

- If a decimal number having a fractional part is converted into a hex number, the fractional part of the decimal number is truncated and only its integer part is converted into a hex number.

2. Hex to decimal conversion

Example: Convert hex number 2BC into its decimal equivalent

Key in: **C-CE** **-HEX** 2 B C **SHIFT** **-DEC**

Answer:

700.

Example: Convert hex number FFFFFFFF12 into its decimal equivalent:

Key in: **C-CE** **-HEX** FFFFFFFF 12 **SHIFT** **-DEC**

Answer:

FFFFFFFF12. HEX

-238.

- If any of hex numbers FFFFFFFF to FDABF41C01 is converted into its decimal equivalent, the corresponding decimal number will become negative.

3. Hexadecimal calculations

Hexadecimal calculations can be done after your computer is placed in the Hex mode. Press **C-CE** **-HEX** and the symbol HEX will be displayed.

Example: $A4 + BA =$

Key in: A4 **+** B A **=**

Answer:

15 E. HEX

(350 in decimal)

Example: $8 \times 3 =$

Key in: 8 **x** 3 **=**

Answer:

18. HEX

(24 in decimal)

Example: $(12 + D) \times B =$

Key in: **C-CE** () 12 **+** D () **x** B **=**

Answer:

155. HEX

(341 in decimal)

Using as a Calculator

Example: 43A - 3CB =
 +)A38 - 2FB =

Total

Key in: **C-CE** **X↔M**

4 3 A **-** 3 C B **M+**

Answer: 7F. HEX

A 3 8 **-** 2 F B **M+**

Answer: 73D. HEX

RM

Answer: 7AC. HEX

For hex calculations, you should note the following points:

- In hex calculations, the computer ignores all fractional parts. This means that the decimal point key, **◊**, is meaningless even if pressed for a hex calculation.
- If an intermediate result in successive hex calculations includes a fractional part, an error will result.

Example: B **÷** 3 **X** ... Error (Symbol "E" is displayed.)

If a fractional part is in the result of the final calculation, it will be truncated and only the integer part of the result will be displayed.

Example: B **÷** 3 **=** ... 3. HEX

- In the Hex mode, the **+/-** key may be used to obtain a complement for the hex number now shown in the display.

Example: A B **+/-** → FFFFFFFF55. HEX

+/- → AB. HEX

- In the Hex mode, the function keys on the computer are not usable.
- When the computer is in the STAT or MATRIX mode (a dash (-) indicator is shown at the STAT or MATRIX label), neither conversion between decimal and hex numbers nor a hex calculation is executable.

Statistical Calculations

To perform statistical calculation, press the **[SHIFT]** and **[STAT]** keys (under the red **[C-CE]** key) in the CAL mode, a dash (—) indicator will appear just above the “STAT” label in the lower right area of the display. The “STAT” stands for STATISTICS, and indicates that the computer is in the statistical calculation mode.

When the computer is in the RUN or PRO mode, press the **[CAL]** and then **[SHIFT]** **[STAT]** to perform a statistical calculation.



Display a dash indicator in this position by pressing the **[SHIFT]** and **[STAT]** keys.

Keys that are used mainly in the statistical calculation mode.

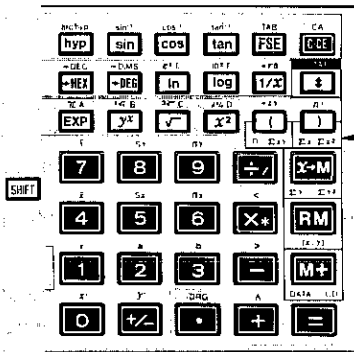

When a statistical calculation is performed, the following statistics are automatically stored in the memory area for fixed variables used in the BASIC mode. And these statistics can be used in the BASIC mode, because these statistics are retained even when the statistical calculation mode is reset. These statistics are cleared when the statistical calculation mode is reset and then set again for another statistical calculation.

Memory	Z	Y	X	W	V	U
Statistic	n	Σx	Σx^2	Σxy	Σy	Σy^2

Using as a Calculator

To clear previous statistical inputs and calculations, reset the statistical calculation mode once and set this mode again. Otherwise, when a new statistical calculation is performed, incorrect answers will be obtained.

When the statistical calculation mode is set, the following cannot be performed:

- * Memory calculation
- * Calculation with parentheses
- * Coordinates conversion
- * Conversion between hexadecimal and decimal numbers
- * Hexadecimal calculation

1. Single-variable Statistical Calculation

The following statistics are obtainable in a single-variable statistic calculation:

- (1) n : Number of samples
- (2) Σx : Sum total of samples
- (3) Σx^2 : Sum of squares of samples
- (4) \bar{x} : Mean value of samples $\bar{x} = \frac{\Sigma x}{n}$
- (5) s_x : Standard deviation with population parameter taken to be "n-1".

$$s_x = \sqrt{\frac{\Sigma x^2 - n\bar{x}^2}{n-1}}$$

(Used to estimate the standard deviation of a population from the sample data extracted from that population.)

- (6) σ_x : Standard deviation with population parameter taken to be "n".

$$\sigma_x = \sqrt{\frac{\Sigma x^2 - n\bar{x}^2}{n}}$$

(Used when all the populations are taken as sample data or when finding the standard deviation of a population with samples taken as that population.)

Data for single-variable statistic calculations are input by the following key operations:

- (1) Data **DATA** (used to enter data one by one)
- (2) Data **X** Frequency **DATA** (used to enter two or more of the same data)

Example:

Calculate standard deviation, mean, and variance $(s_x)^2$ from the following data:
Set the computer in the statistical calculation mode.

Value	35	45	55	65
Frequency	1	1	5	2

As each sample is entered, the number of data of that sample will appear at the right of the display.

	<u>Key in:</u>	<u>Display</u>
	[SHIFT] [STAT]	0.
35	[DATA]	1.
45	[DATA]	2.
55×5	[DATA]	7.
65×2	[DATA]	9.

- Notes:**
1. After all the data have been entered, statistics such as mean value, standard deviation, etc., may be obtained in any desired order.
 2. After a mean value, standard deviation, or any other statistic has been obtained as an intermediate result, more data can be entered and statistical calculations can be performed continuously on additional data entry.

	<u>Key in:</u>	<u>Display:</u>
Mean:	[SHIFT] [\bar{x}]	53.88888889
Standard Deviation:	[SHIFT] [Sx]	9.279607271
Variance:	[x^2]	86.11111111

Correct Data (CD): The last data entry in the above example is an error and must be changed to 60×2.

	<u>Key in:</u>	<u>Display:</u>
65	[X] 2 [SHIFT] [CD]	7.
60	[X] 2 [DATA]	9.

2. Two-variable Statistics and Linear Regression

In addition to the statistics for both variables x and y which are the same as those of x in single-variable statistics, the sum of the products of samples $\sum xy$ is obtained in two-variable statistics. Two-variable statistics make possible the development of a relationship (correlation) between two sets of data. Each pair of data has x and y values. From these sets of data a line of regression can be established. The relationship of the two sets of data by use of the straight line method is called Linear Regression. In Linear Regression there are three important values, r , a , and b .

The equation of the straight line is $y = a + bx$, where a is the point at which the line crosses the Y-axis and b is the slope of the line.

The correlation coefficient r shows the relationship between two sets of data. A perfect correlation between two values is an r equal to 1 (-1 is a perfect negative correlation); in other words, by knowing the value of one variable you can predict with 100% accuracy the value of the other variable. The further the value of r is from 1, the less reliable will your predictions be. The following table can be used as a set of definitions of the values of the correlation coefficient:

Using as a Calculator

	Value of r	Call it	
Positive Correlation	}	+0.80 to +1.00	Extra High
		+0.60 to +0.80	High
		+0.40 to +0.60	Moderate
		+0.20 to +0.40	Low
Negative Correlation	}	-0.20 to +0.20	Nil
		-0.20 to -0.40	Low
		-0.40 to -0.60	Moderate
		-0.60 to -0.80	High
		-0.80 to -1.00	Extra High

r : Correlation coefficient

$$r = \frac{S_{xy}}{\sqrt{S_{xx} \cdot S_{yy}}}$$

a: $a = \bar{y} - b\bar{x}$

b: $b = \frac{S_{xy}}{S_{xx}}$

Coefficient of linear
regression equation
 $y = a + bx$

$$\left[\begin{array}{l} S_{xx} = \sum x^2 - \frac{(\sum x)^2}{n} \\ S_{yy} = \sum y^2 - \frac{(\sum y)^2}{n} \\ S_{xy} = \sum xy - \frac{\sum x \cdot \sum y}{n} \end{array} \right]$$

Example 1: If we know a student's mark in mathematics, can we predict the mark in English?

The exam marks for five students chosen at random are given in the following table:

Student No.	Mark in Math.	Mark in English
n	x	y
1	82	79
2	53	50
3	61	87
4	74	96
5	51	73
6	51	73

Key in:

Display

82 $\{x,y\}$ 79 $\overline{\text{DATA}}$

53 $\{x,y\}$ 50 $\overline{\text{DATA}}$

61 $\{x,y\}$ 87 $\overline{\text{DATA}}$

74 $\{x,y\}$ 96 $\overline{\text{DATA}}$

51 $\{x,y\}$ 73 $\overline{\text{X}}$ 2 $\overline{\text{DATA}}$

1.

2.

3.

4.

6. (Note: To input multiple identical samples, proceed as indicated.)

SHIFT r	0.571587901
SHIFT a	34.26190476 (y-axis)
SHIFT b	0.678571428 (slope)

The value of 0.571587901 for r indicates that the correlation is moderate. The equation for the straight line for this data is $y = 34.26 + 0.68x$ when truncated to second decimal places.

<u>Key in:</u>	<u>Display</u>
90 SHIFT y'	95.33333333

If we had a student whose mark in mathematics was 90, the student would have a mark of 95 in English based on this analysis.

Example 2: Is weight a good predictor of longevity among men 65 years of age? In 1950, 10 men, each six feet tall, were selected for an experiment to determine if their weight effected their life span.

Sample	1	2	3	4	5	6	7	8	9	10
Age at death	72	67	69	85	91	68	77	74	70	82
Weight at age 65	185	226	200	169	170	195	175	174	198	172

<u>Key in:</u>	<u>Display</u>
SHIFT STAT	0.
72 {x,y} 185 DATA	1.
67 {x,y} 226 DATA	2.
(Continue to place in all data)	⋮
SHIFT r	-0.79292617

The value for r indicates a relatively high negative correlation. A higher weight means a shorter life span. To graph the regression line, coefficients a and b are used.

SHIFT a	321.9292125 (y-axis)
SHIFT b	-1.795088908 (slope)

Predict the age of death of a 6-foot man weighing 190 pounds in 1950.

190 **SHIFT** **x'** 73.4945283 years

To reach age 90, what should a man's weight be in 1960?

90 **SHIFT** **y'** 160.3712108 pounds

To reach age 150, what should a man's weight be? Obviously, the answer will make no sense, indicating the danger of carrying a straight-line extrapolation too far.

Using as a Calculator

CAUTION

The following statistical data obtained in the CAL mode can be used in the BASIC mode.

Memory	Z	Y	X	W	V	U
Statistic	n	Σx	Σx^2	Σxy	Σy	Σy^2

When performing calculations using this statistical data, use the RUN mode.

For example, to determine the sum of squares (S^2) of four pieces of data, 205, 221, 226, and 220, operate your computer as follows:

$$\begin{aligned}
 S^2 &= \Sigma (x - \bar{x})^2 \\
 &= \Sigma x^2 - n\bar{x}^2 \\
 &= \Sigma x^2 - \frac{1}{n} (\Sigma x)^2
 \end{aligned}$$

- Enter the data in the CAL mode.

CAL SHIFT STAT

0.

205 DATA 221 DATA

226 DATA 220 DATA

4.

- Change the CAL mode to RUN and calculate S^2 .

BASIC

>

X - Y * Y / Z _

X - Y * Y / Z _

ENTER

246.

Calculation Range

Four arithmetic calculations:

1st operand, 2nd operand, and

calculation result: $\pm 1 \times 10^{-99} \sim \pm 9.999999999 \times 10^{99}$ and 0

Scientific functions:

Functions	Dynamic range	Note
$\sin x$ $\cos x$ $\tan x$	DEG: $ x < 1 \times 10^{10}$ RAD: $ x < \frac{\pi}{180} \times 10^{10}$ GRAD: $ x < \frac{10}{9} \times 10^{10}$ In $\tan x$, however, the following cases are excluded. DEG: $ x = 90(2n - 1)$ RAD: $ x = \frac{\pi}{2}(2n - 1)$ $n = \text{integer}$ GRAD: $ x = 100(2n - 1)$	
$\sin^{-1} x$ $\cos^{-1} x$	$-1 \leq x \leq 1$	
$\tan^{-1} x$	$ x < 1 \times 10^{100}$	
$\ln x$ $\log x$	$1 \times 10^{-99} \leq x < 1 \times 10^{100}$	$(\ln x = \log_e x)$
e^x	$-1 \times 10^{100} < x \leq 230.2585092$	$(e \approx 2.718281828)$
10^x	$-1 \times 10^{100} < x < 100$	
$y^x (\wedge)$	<ul style="list-style-type: none"> • $y > 0$: $-1 \times 10^{100} < x \log y < 100$ • $y = 0$: $x > 0$ • $y < 0$: x: integer or $\frac{1}{x}$: odd number $-1 \times 10^{100} < x \log y < 100$ 	$y^x = 10^{x \cdot \log y}$
$\sqrt[x]{y}$	<ul style="list-style-type: none"> • $y > 0$: $-1 \times 10^{100} < \frac{1}{x} \log y < 100$, $x \neq 0$ • $y = 0$: $x > 0$ • $y < 0$: x or $\frac{1}{x}$: integer ($x \neq 0$) $-1 \times 10^{100} < \frac{1}{x} \log y < 100$ 	$\sqrt[x]{y} = 10^{\frac{1}{x} \cdot \log y}$
$\sqrt[3]{x}$	$ x < 1 \times 10^{100}$	
$\sinh x$ $\cosh x$ $\tanh x$	$-227.9559242 \leq x \leq 230.2585092$	
$\sinh^{-1} x$	$ x < 1 \times 10^{50}$	
$\cosh^{-1} x$	$1 \leq x < 1 \times 10^{50}$	
$\tanh^{-1} x$	$ x < 1$	

Using as a Calculator

Functions		Dynamic range	Note
\sqrt{x}		$0 \leq x < 1 \times 10^{100}$	
x^2		$ x < 1 \times 10^{50}$	
$\frac{1}{x}$		$ x < 1 \times 10^{100}$ $x \neq 0$	
$n!$		$0 \leq n \leq 69$ (n: Integer)	
D.MS → DEG		$ x < 1 \times 10^{100}$	
DEG → D.MS		$ x < 1 \times 10^{100}$	
HEX → DEC		$0 \leq x \leq 2540BE3FF$ $FDABF41C01 \leq x \leq FFFFFFFF$	x is an integer in HEX mode
DEC → HEX		$ x \leq 9999999999$	x is an integer.
$x, y \rightarrow r, \theta$		$(x^2 + y^2) < 1 \times 10^{100}$ $\frac{y}{x} < 1 \times 10^{100}$	$r = \sqrt{x^2 + y^2}$ $\theta = \tan^{-1} \frac{y}{x}$
$r, \theta \rightarrow x, y$		$r < 1 \times 10^{100}$, $ r \sin \theta < 1 \times 10^{100}$ $ r \cos \theta < 1 \times 10^{100}$	$x = r \cos \theta$ $y = r \sin \theta$ θ is in the same condition as x of $\sin x, \cos x$.
Statistical calculation	DATA CD	$ x < 1 \times 10^{50}$ $ y < 1 \times 10^{50}$ $ \Sigma x < 1 \times 10^{100}$ $\Sigma x^2 < 1 \times 10^{100}$ $ \Sigma y < 1 \times 10^{100}$ $\Sigma y^2 < 1 \times 10^{100}$ $ \Sigma xy < 1 \times 10^{100}$ $ n < 1 \times 10^{100}$	
	\bar{x}	$n \neq 0$	
	S_x	$n \neq 1$ $0 \leq \frac{\Sigma x^2 - n\bar{x}^2}{n-1} < 1 \times 10^{100}$	
	σ_x	$n \neq 0$ $0 \leq \frac{\Sigma x^2 - n\bar{x}^2}{n} < 1 \times 10^{100}$	
	\bar{y}	$n \neq 0$	
	S_y	$n \neq 1$ $0 \leq \frac{\Sigma y^2 - n\bar{y}^2}{n-1} < 1 \times 10^{100}$	
	σ_y	$n \neq 0$ $0 \leq \frac{\Sigma y^2 - n\bar{y}^2}{n} < 1 \times 10^{100}$	

Functions		Dynamic range	Note
Statistical calculation	r	$n \neq 0$ $0 < (\Sigma x^2 - n\bar{x}^2) \cdot (\Sigma y^2 - n\bar{y}^2) < 1 \times 10^{100}$ $\left \Sigma xy - \frac{\Sigma x \cdot \Sigma y}{n} \right < 1 \times 10^{100}$ $\left \frac{\Sigma xy - \frac{\Sigma x \cdot \Sigma y}{n}}{\sqrt{(\Sigma x^2 - n\bar{x}^2) \cdot (\Sigma y^2 - n\bar{y}^2)}} \right < 1 \times 10^{100}$	
	b	$n \neq 0$ $0 < \Sigma x^2 - n\bar{x}^2 < 1 \times 10^{100}$ $\left \Sigma xy - \frac{\Sigma x \cdot \Sigma y}{n} \right < 1 \times 10^{100}$ $\left \frac{\Sigma xy - \frac{\Sigma x \cdot \Sigma y}{n}}{\Sigma x^2 - n\bar{x}^2} \right < 1 \times 10^{100}$	
	a	a is the same condition as b, and $ \bar{y} - b\bar{x} < 1 \times 10^{100}$	
	y'	$ a + bx < 1 \times 10^{100}$	
	x'	$\left \frac{y - a}{b} \right < 1 \times 10^{100}$	

For the accuracy of functions other than shown above, the error is ± 1 at the 10th digit, as a rule. (In the scientific notation system, the error is ± 1 at the lowest digit of mantissa display.)

However, the accuracy will become low around singular points and inflection points of functions.

Therefore, errors are accumulated in each stage of the continuous calculations, causing the accuracy to deteriorate. (The same applies to other continuous calculations made by the computer such as y^x and $\sqrt[x]{y}$.)

Matrix Calculation Function

In the CAL mode, the COMPUTER has a function to calculate matrixes or their determinant values.

A matrix is a rectangular array a_{ik} ($i = 1, 2 \dots, m, k = 1, 2 \dots, n$) of a given set of numbers ($m \times n$ elements) as shown below.

$$\begin{bmatrix} a_{11} & a_{12} \dots a_{1n} \\ a_{21} & a_{22} \dots a_{2n} \\ a_{m1} & a_{m2} \dots a_{mn} \end{bmatrix}$$

With this computer, such an array is expressed as matrix X , Y , or M . One of the sets of numbers which form a matrix is called a matrix element. Matrix element a_{11} is expressed as $X(1,1)$, $Y(1,1)$, or $M(1,1)$. The horizontal arrangement of matrix elements is called a row while the vertical arrangement is called a column.

Matrix Configuration

With the COMPUTER, three matrixes X , Y , and M can be defined. Each matrix can be defined within a range of 1 to 99 both vertically (i.e., columns) and horizontally (i.e., rows). However, the total matrix size is dependent upon the memory capacity of the COMPUTER.

In addition, matrixes X , Y , and M are stored in the same memory area as BASIC arrays $X(*,*)$, $Y(*,*)$, and $M(*,*)$. In other words, the values of the matrix elements entered in the BASIC mode can be calculated in the CAL mode.







When entering the values of matrix elements in the BASIC mode, pay attention to the following points:

- (1) Matrix elements $X(i,k)$ correspond to BASIC array elements $X(i-1, k-1)$. For example, $X(1,2)$ correspond to array $X(0,1)$.
- (2) All the matrix element values stored in memory will be cleared by BASIC command RUN, CLEAR, or NEW.

Input of Matrix Element

In the CAL mode, pressing **SHIFT** **↓** or **SHIFT** **↑** causes the COMPUTER to enter the MATRIX mode. In this mode, you can enter the elements of a matrix for calculation of the matrix, as well as to have the computer perform matrix operations and display the matrix elements entered.

The keys and their functions used to enter and display matrix elements are as described below.

Key	Function
SHIFT 	<ul style="list-style-type: none"> • Puts the computer in the MATRIX mode. • Allows you to enter the elements of matrix X and then the elements of matrix Y, and the computer to calculate the matrixes. • Releases the computer from the MATRIX mode when these keys are pressed a second time.
SHIFT 	<ul style="list-style-type: none"> • Puts the computer in the MATRIX mode. • Allows the computer to perform matrix calculations. • Releases the computer from the MATRIX mode when these keys are pressed a second time.
ENTER	<ul style="list-style-type: none"> • Stores in memory the number of rows and number of columns which form a matrix and other matrix element data, and then the computer waits for the next data entry.
	<ul style="list-style-type: none"> • Shifts the cursor to the right by one column. (When the cursor is at the rightmost column, the cursor moves to the next element.)
	<ul style="list-style-type: none"> • Shifts the cursor to the left by one column. (When the cursor is at the leftmost column, the cursor moves to the preceding element.)
	<ul style="list-style-type: none"> • Shifts the cursor up by one row (i.e., to the element immediately above the current column). • Returns the computer to the previous step in operation.
	<ul style="list-style-type: none"> • Shifts the cursor down by one row (i.e., to the element immediately below the current column). • Puts the computer in the wait state for next step in operation.

When you input the respective elements of a matrix, you may use any of the keys that you use in the CAL mode for four basic operations and scientific calculations.

Example 1: To enter the following two matrixes:

$$X = \begin{bmatrix} 10/3 & -5 & 2 \\ 8 & 2 & 23 \end{bmatrix}$$

$$Y = \begin{bmatrix} 5/3 & 3 & 2 \\ -1 & 0 & -8 \end{bmatrix}$$

Using as a Calculator

Operation:

SHIFT **↓**

MATRIX:X(0 _ , 0)

Because matrix X is undefined, (0, 0) is displayed when the computer is put in the MATRIX mode.

2

MATRIX:X(2 _ , 0)

"2" is entered as the number of rows.

ENTER

MATRIX:X(2, 0 _)

3 **ENTER**

X(1, 1) 0.

Then enter the number of columns as "3" and define matrix X as a matrix with a size of (2, 3), and the computer is ready for your input of the value of element $X(1, 1)$.

10 **÷**

X(1, 1) 10.

3 **=**

X(1, 1) 3.333333333

ENTER

X(1, 2) 0.

After your input of element $X(1, 1)$, the computer waits for your input of the next element $X(1, 2)$.

5 **+/-**

X(1, 2) -5

ENTER 2

X(1, 3) 2.

ENTER 8

X(2, 1) 8.

ENTER 2

X(2, 2) 2.

ENTER 23

X(2, 3) 23.

ENTER

MATRIX:Y(0 _ , 0)

After you have completed the input of all the element data of matrix X , you must define the size of matrix Y and then enter the elements of matrix Y in the same manner as you did for matrix X .

2 **ENTER**

3

ENTER 5 \div 3 **=****ENTER** 3**ENTER** 2**ENTER** 1 $+/-$ **ENTER** 0**ENTER** 8 $+/-$ **ENTER****MATRIX:Y(2, 0 _)****MATRIX:Y(2, 3 _)****Y(1, 1)** 1.666666667**Y(1, 2)** 3.**Y(1, 3)** 2.**Y(2, 1)** -1.**Y(2, 2)** 0.**Y(2, 3)** -8.**MATRIX OPERATION**

On input of all the elements of matrix Y , the message "MATRIX OPERATION" will appear on the display, indicating that the COMPUTER is ready to perform matrix calculations. If only matrix X needs to be calculated, press **C-CE** **ENTER** when you input the number of rows and number of columns, respectively, for matrix Y .

Using as a Calculator

Matrix Calculations

While the message "MATRIX OPERATION" is on the display, pressing each of the following keys causes the COMPUTER to perform the matrix operation designated by the key.

Key	Function
$\boxed{+}$	<p>$X + Y \rightarrow X$: Performs addition.</p> <p>The result of adding matrix X to matrix Y becomes new matrix X. To perform addition, matrixes X and Y must be equal to each other in both the number of rows and the number of columns.</p>
$\boxed{-}$	<p>$X - Y \rightarrow X$: Performs subtraction.</p> <p>The result of subtracting some elements of matrix Y from the corresponding elements of matrix X becomes the corresponding elements of new matrix X.</p> <p>To perform subtraction, matrixes X and Y must be equal in both the number of rows and the number of columns.</p> <p>(Example)</p> $\begin{bmatrix} 2 & 3 \\ 5 & 2 \end{bmatrix} - \begin{bmatrix} 1 & 6 \\ 3 & -1 \end{bmatrix} = \begin{bmatrix} 1 & -3 \\ 2 & 3 \end{bmatrix}$
$\boxed{\times}$	<p>$X \cdot Y \rightarrow X$: Performs multiplication.</p> <p>To perform multiplication, the number of columns in matrix X must be equal to the number of rows in matrix Y.</p>
$\boxed{\div}$	<p>$X \cdot Y^{-1} \rightarrow X$: Performs the multiplication of matrix X and inverse matrix Y.</p> <p>To perform this operation, the number of columns in matrix X must be equal to the number of rows in matrix Y^{-1}.</p>
$\boxed{1/x}$	<p>$X^{-1} \rightarrow X$: Performs the inverse matrix calculation of matrix X.</p> <p>The result of this operation becomes new matrix X.</p> <p>To perform this operation, matrix X must be a square matrix (which has the same number of rows as the number of columns).</p>
n $\boxed{+}$	<p>$n + X \rightarrow X$: Performs the addition of scalar n to matrix X elements.</p> <p>In this operation, n is added to each element of matrix X.</p> <p>NOTE: Mathematically, such an operation as this does not exist. The addition of scalars is one of the features unique to the COMPUTER.</p>

Key	Function
n \ominus	<p>$n - X \rightarrow X$: Performs the subtraction of matrix X elements from scalar n.</p> <p>In this operation, each element of matrix X is subtracted from n and the result becomes the corresponding elements of new matrix X.</p> <p>NOTE: Mathematically, such an operation as this does not exist. The subtraction of scalars is another feature unique to the COMPUTER.</p> <p>(Example)</p> $2 - \begin{bmatrix} 1 & 6 \\ 3 & -1 \end{bmatrix} \rightarrow \begin{bmatrix} 1 & -4 \\ -1 & 3 \end{bmatrix}$
n \times	<p>$n \cdot X \rightarrow X$: Performs the multiplication of matrix X elements by scalar n.</p>
n \div	<p>$n \cdot X^{-1} \rightarrow X$: Performs the multiplication of inverse matrix X^{-1} elements by scalar n.</p> <p>To perform this operation, matrix X must be a square matrix.</p>
\updownarrow	<p>$X \longleftrightarrow Y$: Exchange matrix X for matrix Y.</p>
\top	<p>$X^t \rightarrow X$: Performs the transposition of matrix X, giving the transposed matrix as new matrix X.</p>
D	<p>$X \rightarrow X$ (Display): Displays the value of the determinant of matrix X.</p> <p>To perform this operation, matrix X must be a square matrix.</p>
$+/-$	<p>$-X \rightarrow X$: Reverses the positive or negative sign of each element of matrix X.</p>
X^2	<p>$X \cdot X \rightarrow X$: Perform the squaring of matrix X.</p> <p>To perform this operation, matrix X must be a square matrix.</p>
$X \rightarrow M$	<p>$X \rightarrow M$: Stores the value of matrix X in the memory location of matrix M (while clearing the previous contents of matrix M).</p> <p>This key is used when you wish to retain the value of matrix X even after the matrix calculation.</p>

Using as a Calculator

Key	Function
RM	$M \rightarrow X$: Invokes the memory contents of matrix M into matrix X (while clearing the previous contents of matrix X .)
M+	$X + M \rightarrow M$: Adds the value of matrix X cumulatively to the memory contents of matrix M . To perform this operation, matrixes X and M must be equal to each other in both the number of rows and the number of columns.

- Note:**
- Pressing the **BRK** key during the execution of a matrix calculation causes the calculation to be suspended. At this point, the values of matrixes X , Y , and M will be retained as those before the execution of the calculation.
 - Press the n **1/x** **X** in this order to perform the division of matrix X elements by scalar n .
 - If most of the elements of a matrix have the same value, execute the n **+** operation with all the matrix elements set as 0 and then correct only the value of each element having a value other than n . This will facilitate the input of the matrix elements.

On completion of the matrix calculation, the message "MATRIX OPERATION" appears again on the display, indicating that the COMPUTER is ready for the next matrix calculation. After the determinant value of matrix X is displayed by pressing the **D** key, the message "MATRIX OPERATION" will appear again if you press one of the **↓**, **↑**, **←**, **→**, **C-CE**, and **ENTER** keys.

Example 2: To calculate $X + Y$, using the values of the respective elements of matrixes X and Y entered (stored in memory) in Example 1

$$X = \begin{bmatrix} 10/3 & -5 & 2 \\ 8 & 2 & 23 \end{bmatrix}$$

$$Y = \begin{bmatrix} 5/3 & 3 & 2 \\ -1 & 0 & -8 \end{bmatrix}$$

Operation:

+

MATRIX OPERATION

X+Y→X

(The message "BUSY" appears indicating that the computer is performing a calculation.)

MATRIX OPERATION

Now, let's see the result of addition.

↓

MATRIX: X(2 —, 3)

↓

X(1, 1) 5.

▶

X(1, 2) -2.

SHIFT ↓

∅.

The COMPUTER is now released from the MATRIX mode.

If you press any of the numeric keys or the \square key while the message "MATRIX OPERATION" is being displayed, the COMPUTER can perform scalar calculations.

Example 3: To calculate $1/25 * X \rightarrow X$, using the calculation result of matrix X in Example 2

Operation:

SHIFT ↑

MATRIX OPERATION

2

SCALAR 2.

5

SCALAR 25.

1/x

SCALAR 0.04

X

0.04 * X → X

MATRIX OPERATION

↓

MATRIX: X(2 —, 3)

↓

X(1, 1) 0.2

SHIFT ↑

∅.

Example 4: To solve the following simultaneous linear equations with three unknowns using matrix calculations

$$\begin{cases} 2x + 5y - z = -1 \\ x - y + 4z = 12 \\ 3x + 2y + z = 9 \end{cases}$$

Example 5: To solve for the inverse matrix of $\begin{bmatrix} 3 & 1 \\ 1 & 1/3 \end{bmatrix}$

This matrix is not a regular matrix and thus has no inverse matrix theoretically. With any computer, however, the value $1/3$ is input as "0.333" and thus an inverse matrix exists, resulting in the following.

$$\begin{bmatrix} 3 & 1 \\ 1 & 0.33\dots3 \end{bmatrix}^{-1} = \begin{bmatrix} -33\dots3 & 1.E10 \\ 1.E10 & -3.E10 \end{bmatrix}$$

So the results obtained by computers may have such an error. Please note that verification by any other method may be required depending on how matrix calculations will be applied.

In the above example, when you obtain the determinant value by multiplying the original matrix X by 3, you can confirm that matrix X is not a regular matrix because the result of the multiplication becomes 0 ($\begin{vmatrix} 3 & 3 \\ 3 & 3 \end{vmatrix} = 0$).

Note: Because a matrix calculation will not be completed by a single operation (e.g., one-time multiplication), it will take some time to complete the calculation. It will take about 6 seconds to solve for the inverse matrix of a unit matrix consisting of 7 rows and 7 columns. This calculation time varies depending on the values of matrix elements.

Memory Capacity Required for Matrix Calculations

- Because matrix calculations share the same memory area as that used for BASIC programs, unused memory capacity (i.e., capacity determinable by MEM **ENTER** in BASIC mode) must be larger than the capacity determined by the following formula:

$$\begin{aligned} &[(\text{No. of rows of matrix } X) \times (\text{No. of columns of matrix } X) \times 8 + 7] \text{ bytes} \\ &+ [(\text{No. of rows of matrix } Y) \times (\text{No. of columns of matrix } Y) \times 8 + 7] \text{ bytes} \\ &+ [(\text{No. of rows of matrix } M) \times (\text{No. of columns of matrix } M) \times 8 + 7] \text{ bytes} \\ &+ [(\text{No. of rows of resultant matrix}) \times (\text{No. of columns of resultant matrix}) \times 8 + 7] \text{ bytes} \end{aligned}$$

Using as a Calculator

However, when neither matrix Y nor matrix M is used, the values (no. of rows and no. of columns) in brackets of each unused matrix will be treated as 0 for the capacity calculation. The resultant matrix is only required during the calculation and will be cleared on completion of the calculation. For information, no resultant matrix is required for the execution of $X \rightarrow M$, $R M$, or \downarrow . Two resultant matrixes are required for matrix operations using \div and $n \div$, since these operations involve two calculations (i.e., inversion and multiplication).

- If the message "MEMORY OVER" appears on the display while in the MATRIX mode, erase the variables or programs used in BASIC in order to increase the unused memory capacity for matrix calculations.

Example 6: To calculate the multiplication of the following two matrixes ($X \cdot Y \rightarrow X$)

$$X = \begin{bmatrix} 2 & 3 \\ 5 & 1 \end{bmatrix} \quad Y = \begin{bmatrix} 8 & 30 \\ 7 & 15 \end{bmatrix}$$

(matrix M undefined)

The required memory capacity will be calculated as follows:

$$[2 \times 2 \times 8 + 7] + [2 \times 2 \times 8 + 7] + [2 \times 2 \times 8 + 7] = 117 \text{ bytes}$$

Matrix X Matrix Y Resultant matrix

Printing of Matrixes

To print the data (e.g., value of each element) of matrix X , prepare and execute the following program. If you execute the program by typing "RUN" and pressing **ENTER**, however, all the matrix data will be cleared from memory. So be sure to execute the program with the **DEF** key.

```
100 "M":INPUT "ROW";II
110 INPUT "COLUMN";JJ
120 FOR I=0 TO II-1
130 FOR J=0 TO JJ-1
140 LPRINT "X{";I+1;" ";J+1;"=";X(I,J)
150 NEXT J:NEXT I:END
```

If the data of matrix Y or M is to be printed, change "X" at the two places in line 140 of the above program to read "Y" or "M".

(Operation) Press the **DEF** **M** keys in the RUN mode, and the designated matrix data will be output on the printer.

Error Messages

If an error occurs during the calculation of a matrix, one of the following messages appears on the display, together with the "E" (Error) sign. Press the \square key to release the COMPUTER from the error condition and the "E" sign will go off and the message "MATRIX OPERATION" will appear on the display. At this point, the matrix data before the execution of the matrix calculation is retained in memory.

Error Message	Cause of Error
IMPOSSIBLE CALCULATION	<ul style="list-style-type: none"> • Matrixes do not match in size. Matrixes do not match in size in addition, subtraction, or multiplication, or an attempt was made to calculate the inverse matrix, or to perform the squaring, of a matrix which is not a square matrix.
MEMORY OVER	<ul style="list-style-type: none"> • Insufficient memory In $X \rightarrow M$ operation, memory space is not enough to store matrix M, or no work area is available for arithmetic operation.
DIVISION BY ZERO	<ul style="list-style-type: none"> • 0 (zero) is used as divisor. In an inverse matrix calculation, an attempt was made to divide a number by zero.
OVER FLOW	<ul style="list-style-type: none"> • Overflow has occurred during an arithmetic operation.

Manual Calculations in BASIC Mode

What is Manual Calculation?

The **COMPUTER** may be basically used in two ways. One way lets you store in advance the whole calculation procedure or steps into the computer's memory as a program, then lets the computer automatically execute it later. The other lets you calculate step by step through manual key operations. The latter is called a manual calculation.

Of course, in the CAL mode, all calculations are performed manually, but here only those performed in the BASIC mode (RUN or PROGRAM mode) are called manual calculations.

Using as a Calculator

How to Manually Calculate

Let's try manual calculation in the RUN mode. Press the BASIC key to place your computer in the RUN mode.

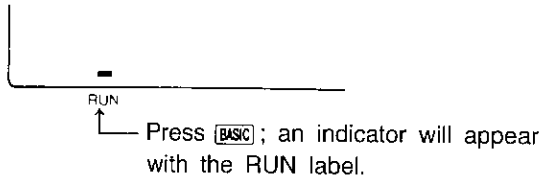

In the RUN mode, the key functions shown in the following figure are operative. (The same is true in the PROgram mode.)

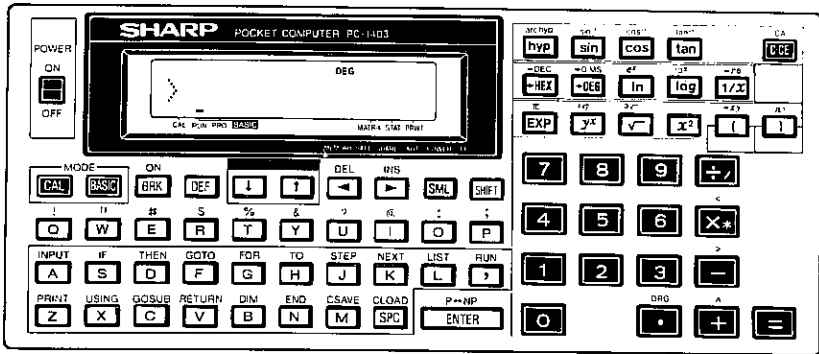

Before going into operation examples, let's touch on some important points in operation.

Whereas we usually use operators $+$, $-$, \times , or \div for our mathematical calculations on paper, we don't use the operators \times and \div for our arithmetic operations in BASIC. Instead of \times and \div , we use an asterisk ($*$) and slash ($/$), respectively.

The operators $*$ and $/$ can be entered by pressing **X*** and **+/** keys, respectively. **To get the result of a manual calculation, operate the **ENTER** key instead of **=** key.**

Do not use dollar signs or commas when entering a calculation formula or expression into the COMPUTER. These characters have special meaning in the BASIC programming language. Now try these simple arithmetic examples. Remember to clear with the **C-CE** between calculations.

Input	Display
5 0 + 5 0 ENTER	100.
1 0 0 - 5 0 ENTER	50.
6 0 * 1 0 ENTER	600.
3 0 0 / 5 ENTER	60.
1 0 SHIFT ^ 2 ENTER	100.
2 * SHIFT π ENTER	6.283185307
√ 6 4 ENTER	8.

Recalling Entries

Even after the **COMPUTER** has displayed the results of your calculation, you can display your last entry again. To recall, use the left (←) and right (→) arrows.

The left arrow, (←), recalls the expression that has the cursor positioned after its last character.

The right arrow, (→), recalls the expression that has the cursor positioned "on top of" its first character.

Remember that the left and right arrows are also used to position the cursor within a line. The right and left arrows are very helpful in editing (or modifying) entries without having to retype the entire expression.

You will become familiar with the use of the right and left arrows in the following examples. Now, take the role of the manager and perform the calculations as we discuss them.

As the head of personnel in a large marketing division, you are responsible for planning the annual sales meeting. You expect 300 people to attend the three-day conference. For part of this time, the sales force will meet in small groups. You believe that groups of six would be a good size. How many groups would this be?

Input	Display
3 0 0 / 6 ENTER	50.

Using as a Calculator



On second thought, you decide that groups containing an odd number of participants might be more effective. Recall your last entry, using the  key

Input



Display

300/6_

To calculate the new number of groups, you must replace the six with an odd number. Five seems to make more sense than seven. Because you recalled by using the  arrow, the cursor is positioned at the end of the display. Use the  to move the cursor one space to the left.

Input



Display

300/6

Notice that after you move the cursor it becomes a flashing block . Whenever you position the cursor "on top of" an existing character, it will be displayed as a flashing cursor.

Type in a 5 to replace the 6. One caution in replacing characters—once you type a new character over an existing character, the original is gone forever! You cannot recall an expression that has been typed over.

Input

5

ENTER

Display

300/5_

60.

Sixty seems like a reasonable number of groups, so you decide that each small group will consist of five participants.

Recall is also useful to verify your last entry, especially when your results do not seem to make sense. For instance, suppose you had performed this calculation:

Input

3 0 / 5 ENTER

Display

6.

Even a tired, overworked manager like you realizes that six does not seem to be a reasonable result when you are dealing with hundreds of people! Recall your entry using the \leftarrow .

Input



Display

30/5

Because you recalled by using the \leftarrow , the flashing cursor is now positioned over the first character in the display. To correct this entry you wish to insert an added zero. Using the \rightarrow , move the cursor until it is positioned over the zero. When making an INSert, you position the flashing cursor over the character **before** which you wish to make the insertion.

Input



Display

30/5

Use the INSert key to make space for the needed character.

Input



Display

3 0/5

Pressing INSert moves all the characters one space to the right, and inserts a bracketed open slot. The flashing cursor is now positioned over this open space, indicating the location of the next typed input. Type in your zero. Once the entry is corrected, display your new result.

Input



Display

300/5

60.

On the other hand, suppose that you had entered this calculation:

Input

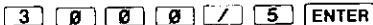

Display

600.

Using as a Calculator

The results seem much too large. If you only have 300 people attending the meeting, how could you have 600 "small groups"? Recall your entry using the  .

Input



Display

3000/5

The flashing cursor is now positioned over the first character in the display. To correct this entry eliminate one of the zeros. Using the , move the cursor to the first zero (or any zero). When deleting a character, you position the cursor "on top of" the character to be deleted.

Input



Display

3000/5

Now use the DELEte key to get rid of one of the zeros.

Input



Display

300/5

Pressing DELEte causes all the characters to shift one space to the left. It deletes the character it is "on top of" and the space the character occupied. The flashing cursor stays in the same position indicating the next location for input. Since you have no other changes to make, complete the calculation.

Input



Display

60.

Note: Pressing the SPaCe key, when it is positioned over a character, replaces the character leaving a blank space. DELEte eliminates the character and the space it occupied.

Errors



Recalling your last entry is essential when you get the dreaded ERROR message. Let us imagine that, unintentionally, you typed this entry into the computer.

Input





Display

ERROR 1

Naturally you are surprised when this message appears! ERROR 1 is simply the computer's way of saying, "I don't know what you want me to do here". To find out what the problem is, recall your entry using either the  or  arrow.

InputDisplay

300 / / 5

When you use the  or  key, the flashing cursor indicates the point at which the computer got confused. And no wonder, you have too many operators! To correct this error use the DELete key.

Input

SHIFT DEL ENTER

Display

60.

If, upon recalling your entry after an ERROR 1, you find that you have omitted a character, use the INSert sequence to correct it.

When using the computer as a calculator, the majority of the errors you encounter will be ERROR 1 (an error in syntax). For a complete listing of error messages, see Appendix A.

Serial Calculations

The computer allows you to use the results of one calculation as part of the following calculation.

Part of your responsibility in planning this conference is to draw up a detailed budget for approval. You know that your total budget is \$150.00 for each attendant. Figure your total budget:

Input

3 0 0 * 1 5 0 ENTER

Display

45000.

Of this amount you plan to use 15% for the final night's awards presentation. When performing serial calculations, it is not necessary to retype your previous results, but DO NOT clear between entries (do not use the  at this time). What is the awards budget?

Input

* . 1 5

Display

45000.*.15_

Using as a Calculator

Notice that as you type in the second calculation ($\times .15$), the computer automatically displays the result of your first calculation at the left of the screen and includes it in the new calculation. In serial calculations, the entry must begin with an operator. As always, you end the entry with **ENTER** :

Note: The $\frac{\%}{\square}$ and $\frac{\Delta \times \square}{\square}$ keys cannot be used in the calculation. The $\frac{\%}{\square}$ key should be used as a character only and the $\frac{\Delta \times \square}{\square}$ key is inoperative.

Example: 45000 \times 15 **SHIFT** $\frac{\%}{\square}$ \rightarrow ERROR1

Input

ENTER

Display

6750.

Continue allocating your budget. The hotel will cater you dinner for \$4000:

Input

- **4** **0** **0** **0**

ENTER

Display

6750.-4000.

2750.

Decorations will be \$1225:

Input

- **1** **2** **2** **5** **ENTER**

Display

1525.

Finally, you must allocate \$2200 for the guest speaker and entertainment:

Input

- **2** **2** **0** **0** **ENTER**

Display

-675.

Obviously, you will have to change either your plans or your allocation of resources!

Negative Numbers

Since you want the awards dinner to be really special, you decide to stay with the planned agenda and spend the additional money. However, you wonder what percentage of the total budget will be used up by this item. First, change the sign of the remaining sum:

Input	Display
* [-] 1	- 675. * - 1 _
ENTER	675.

Now you add this result to your original presentation budget:

Input	Display
+ 6 7 5 0 ENTER	7425.

Dividing by 45000 gives you the percentage of the total budget this new figure represents:

Input	Display
/ 4 5 0 0 0 ENTER	0.165

Fine, you decide to allocate 16.5% to the awards presentation.

Compound Calculations and Parentheses

In performing the above calculations, you could have combined several of these operations into one step. For instance, you might have typed both these operations on one line:

$$675+6750/45000$$

Compound calculations, however, must be entered very carefully:

675+6750/45000 might be interpreted as

$$\frac{675+6750}{45000} \quad \text{or} \quad 675 + \frac{6750}{45000}$$

Using as a Calculator

When performing compound calculations, the computer has specific rules of expression evaluation and operator priority (see page 76). Be sure you get the calculation you want by using parentheses to clarify your expressions.

$$(675+6750)/45000 \text{ or } 675+(6750/45000)$$

To illustrate the difference that the placement of parentheses can make, try these two examples:

<u>Input</u>	<u>Display</u>
(6 7 5 + 6 7 5 0) / 4 5 0 0 0 ENTER	0.165
6 7 5 + (6 7 5 0 / 4 5 0 0 0) ENTER	675.15

Note: In BASIC (PRO or RUN) mode, the close parenthesis before the **ENTER** key cannot be omitted. In CAL mode, however, you can omit it before the **=** key.

Using Variables in Calculations

The computer can store up to 26 fixed variables under the alphabetic characters A to Z. If you are unfamiliar with the concept of variables, they are more fully explained in Chapter 4. You designate variables with an Assignment Statement:

$$A=5$$

$$B=-2$$

You can also assign the value of one variable (right) to another variable (left):

$$C = A + 3$$

$$D = E$$

A variable may be used in place of a number in any calculation.

Now that you have planned your awards dinner, you need to complete arrangements for your conference. You wish to allocate the rest of your budget by percentages also. First you must find out how much money is still available. Assign a variable (R) to be the amount remaining from the total:

Input

R **=** **4** **5** **0** **0** **0**
- **7** **4** **2** **5**

ENTERDisplay

$$R = 45000 - 7425 _$$

$$37575.$$

As you press **ENTER**, the computer performs the calculation and displays the new value of R. You can display the current value of any variable by entering the alphabetic character it is stored under:

Input**R** **ENTER**Display

$$37575.$$

You can then perform calculations using your variable. The value of (R) will not change until you assign it a new value.

You wish to allocate 60% of the remaining money to room rental:

Input

R ***** **.** **6** **0**

ENTERDisplay

$$R * .60 _$$

$$22545.$$

Similarly, you want allocate 25% of your remaining budget to conduct management training seminars:

Input

R ***** **.** **2** **5** **ENTER**

Display

$$9393.75$$

Variables will retain their assigned values even if the machine is turned OFF or undergoes an AUTO OFF. Variables are lost only when you:

- * assign a new value to the same variable.
- * type in CLEAR **ENTER** (not the clear key (**C-CE**)).
- * clear the machine using the RESET button.
- * change the batteries.

These are certain limitations on the assignment of variables, and certain programming procedures which cause them to be changed. See Chapter 4 for a discussion of assignment. See Chapter 5 for a discussion of the use of variables in programming.

Using as a Calculator

Chained Calculations

In addition to combining several operators in one calculation, the computer also allows you to perform several calculations one after another—without having to press **ENTER** before moving on. You must separate the equations with commas. Only the result of the **final** calculation is displayed. (Remember too that the maximum line length accepted by the computer is 80 characters including **ENTER**.)

You wonder how much money would have been available for rooms if you had kept to your original allocation of 15% for the awards dinner:

Input

R **=** **.** **8** **5** ***** **4** **5**
0 **0** **0** **,** **R** *****
. **6** **0**

Display

R = .85*45000, R*.60

Although the computer performs all the calculations in the chain, it displays only the final result:

Input

ENTER

Display

22950.

To find the value of R used in this calculation, enter R:

Input

R **ENTER**

Display

38250.

Error Message

If an error occurred as a result of a manual calculation, an error message will appear in the display such as:

ERROR 1 or ERROR 2

The error state can be cleared with either the **C-CE** or **◀** or **▶** key. If the **◀** or **▶** key is used to clear the error state, the portion of the formula where the error occurred is recalled in the display (see the description for the recall feature).

Scientific Notation

People who need to deal with very large and very small numbers often use a special exponential format called **scientific notation**. In scientific notation, a number is broken down into two parts.

Using as a Calculator

Under certain circumstances, when numbers will be used frequently, the computer uses a special compact form. In these cases, there are special limits imposed on the size of numbers, usually either 0 to 65535 or -32768 to $+32767$. Numbers within this range can be represented in 16 binary bits. The circumstances in which this form is used are noted in Chapter 8.

Last Answer Feature

In the case of the serial calculation, you could use the result of the calculation only as the first member of the subsequent calculation formula.

Refer to the following example.

<u>Input</u>	<u>Display</u>
3 $\boxed{+}$ 4 $\boxed{\text{ENTER}}$	$\boxed{7.}$
$\boxed{*}$ 5	$\boxed{7.*5_}$
$\boxed{\text{ENTER}}$	$\boxed{35.}$

Press $\boxed{\text{C-CE}}$, then the $\boxed{\downarrow}$ or $\boxed{\uparrow}$ key. If you operated these keys just after completing the calculation example above, you should see "35." in your display. The numeric data displayed is the result of the last calculation.

The computer can "remember" the last answer (result) obtained through a manual calculation, and recall it on its display with the $\boxed{\downarrow}$ or $\boxed{\uparrow}$ key.

In the case of the serial calculation described above, you could use the result of the previous calculation only as the first member of the subsequent calculation formula. With the last answer feature, however, you can place the result of the previous calculation in any position of the subsequent calculation formula.

Example: Use the result (6.25) of the operation, $50 \div 8$, to compute $12 \times 5 \div 6.25 + 24 \times 3 \div 6.25 =$:

Input	Display
50 [/] 8 [ENTER]	6.25 Last answer \rightarrow
12 [*] 5 [/] [\uparrow]	12*5/6.25_ Last answer recalled
[+] 24 [*] 3 [/] [\downarrow]	12*5/6.25+24*3/6.25_ Last answer recalled
[ENTER]	21.12
[C-CE] [\downarrow]	21.12_ The last answer is replaced with the result of the previous calculation by performing a manual calculation with the [ENTER] key.

As shown in this example, the last answer can be recalled as many times as required, but will be replaced with a new last answer resulting from the last calculation.

The last answer is not cleared by the [C-CE] or [SHIFT] [CA] key operation.

Note: The last answer cannot be recalled when the program execution is temporarily halted in other than the RUN mode, or when the program is under execution in the TRACE mode.

Using as a Calculator

Length of Formula









The length of a formula you can put into your computer has a certain limitation. With the computer, up to 79 key strokes can be used to enter a single calculation formula (excluding the **ENTER** key). If you attempt the 80th key stroke, the cursor () will start blinking on that character, indicating that the 80th key entry is not valid.

Scientific Calculations in the BASIC mode

This computer has many scientific functions which can be used in BASIC mode.

To perform scientific functions you must press **ENTER** at the end of the input, or your calculations will not be acted upon by the computer.

These functions will be described as follows:

Functions	Notation	Operation	Remark
Trigonometric functions			
sin	SIN		
cos	COS		
tan	TAN		
Inverse trigonometric functions			
\sin^{-1}	ASN		
\cos^{-1}	ACS		
\tan^{-1}	ATN		
Hyperbolic functions			
sinh	HSN		
cosh	HCS		
tanh	HTN		

Functions	Notation	Operation	Remark
Inverse hyperbolic functions			
\sinh^{-1}	AHS	SHIFT arChyp sin⁻¹	
\cosh^{-1}	AHS	SHIFT arChyp cos⁻¹	
\tanh^{-1}	AHT	SHIFT arChyp tan⁻¹	
Logarithmic functions			
\ln	LN	ln	$\log_e x$
\log	LOG	log	$\log_{10} x$
Exponential functions			
e^x	EXP	SHIFT e^x	$e \approx$ 2.718281828
10^x	TEN	SHIFT 10^x	
Reciprocal			
$\frac{1}{x}$	RCP	1/x	
Square			
x^2	SQU	x²	
Square root	$\sqrt{\quad}$ or SQR	√	
Cubic root	CUR	SHIFT ∛	
Factorial	FACT	SHIFT n!	
Pi	π or PI	SHIFT π	$\pi \approx$ 3.141592654
DMS → DEG	DEG	◀DEG	
DEG → DMS	DMS	SHIFT ◀DMS	
Power	y^x	SHIFT ^ or y^x	$y \wedge x : y^x$
Power root	$\sqrt[x]{y}$	SHIFT ∛	$y \text{ ROT } x : \sqrt[x]{y}$
Rectangular coordinates → Polar coordinates	POL	SHIFT ↔Pθ	

Using as a Calculator

Functions	Notation	Operation	Remark
Polar coordinates → Rectangular coordinates	REC	SHIFT ←xy	
Integer	INT	I N T	INT(x)
Absolute x	ABS	A B S	ABS(x)
Sign	SGN	S G N	SGN(x) x > 0 : 1 x = 0 : 0 x < 0 : -1
Modify (Rounding)	MDF	M D F	

Of these functions, the INT, ABS, SGN, and MDF can be entered by using letter keys. Some other functions may also be entered with letter keys. For example, "sin 30" may be entered either by operating **sin** 30 or **S** **I** **N** 30. For trigonometric and inverse trigonometric functions and coordinates conversion, the desired angular unit must be specified in advance. In manual calculations, angular units may be specified either by operating **SHIFT** **DRG** as in the CAL mode or with the following commands:

Angular unit	Command	Display Symbol	Description
Degree	DEGREE	DEG	Represents a right angle as 90 [°].
Radian	RADIAN	RAD	Represents a right angle as $\pi/2$ [rad].
Grad	GRAD	GRAD	Represents a right angle as 100 [g].

These commands are used to specify angular units in a program. For practice, use them in the following calculation examples:

Example: $\sin 30^\circ =$

Operation: DEGREE **ENTER** (Specifies "degrees" for angular unit.)

SIN 30 **ENTER**

DEG	0.5
-----	-----

Example: $\tan \frac{\pi}{4} =$

Operation: RADIAN **ENTER** (Specifies "radians" for angular unit.)

TAN (PI/4) **ENTER**

1.

Example: $\cos^{-1}(-0.5) =$

Operation: DEGREE **ENTER** (Specifies "degrees" for angular unit.)

ACS-0.5 **ENTER**

120.

(120°)

Example: $\log 5 + \ln 5 =$

Operation: LOG 5 + LN 5 **ENTER**

2.308407917

Example: $e^{2+3} =$

Operation: EXP (2 + 3) **ENTER**

(Do not use the **EXP** key.)

148.4131591

Example: $\sqrt[3]{4^3 + 5^3} =$

Operation: CUR (4 ^ 3 + 5 ^ 3) **ENTER**

5.738793548

Example: Convert 30 deg. 30 min. in sexagenary notation into its decimal equivalent (in degrees).

Operation: DEG 30.30 **ENTER**

30.5

(30.5 degrees)

Example: Convert 30.755 deg. in decimal notation into its sexagenary equivalent (in degrees, minutes, seconds).

Operation: DMS 30.755 **ENTER**

30.4518

(30 deg. 45 min. 18 sec.)

Example: Conversion from rectangular into polar coordinates: Determine polar coordinate (r,θ) for point P (3, 8) on a rectangular coordinate:

Operation: DEGREE **ENTER** (Specifies "degrees" for angular unit.)

POL (3, 8) **ENTER**

(r)

8.544003745

Z **ENTER**

(θ)

69.44395478

* The value of θ is stored in variable Z, and the value of r in variable Y.

Using as a Calculator

Example: Conversion from polar into rectangular coordinates: Determine rectangular coordinates (x, y) for point P (12, $4/5\pi$) on polar coordinates.

Operation: RADIAN **ENTER** Specifies "radians" for angular unit.)
 REC (12, (4/5*PI))

ENTER	(x)	-9.708203933
		(x \approx -9.7)
Z ENTER	(Y)	7.053423028
		(y \approx 7.1)

* The values of y and x are stored in variables Z and Y, respectively.

Note: For coordinates conversion, the conversion results are stored in variables Z and Y. Therefore, the previous contents of Z and Y (or Z\$ and Y\$) will be cleared.

- Reference -

Equations composed of logical operators (=, >, <, >=, <=, <>) can take on the values listed in the following table:

x and y represent numeric values.

=*	1 if $x = y$ 0 if $x \neq y$	>=	1 if $x \geq y$ 0 if $x < y$
>	1 if $x > y$ 0 if $x \leq y$	<=	1 if $x \leq y$ 0 if $x > y$
<	1 if $x < y$ 0 if $x \geq y$	<>	1 if $x \neq y$ 0 if $x = y$ ("<>" means " \neq ".)

* If, for example, "A = numeric value" or "B = formula" is used in a logical equation, the computer will not treat it as a logical equation but as an assignment statement for variables. When using an equal (=) sign for a logical equation, use it in the form of "numeric value = A" or "formula = B", with the exception of conditional expressions used in IF statements.

Direct Calculation Feature

In the manual calculations described up to now, we always used the **ENTER** key to terminate a formula and obtain the calculation result of the formula. However, you can directly operate the functions of the computer with the desired function key (without operating the **ENTER** key) when the objective numeric data is in the display.

Example: Determine $\sin 30^\circ$ and $8!$.

Operation: DEGREE **ENTER**

C-CE 30

30 _

sin

0.5

Operation: **C-CE** 8

8 _

SHIFT **7!**

40320.

Example: For $\tan^{-1} \frac{5}{12}$, first check the result of $\frac{5}{12}$, then determine $\tan^{-1} \frac{5}{12}$.

Operation: DEGREE **ENTER**

4.166666667E-01

5/12 **ENTER**

SHIFT **tan⁻¹**

22.61986495

It should be noted, however, that this "direct" calculation mode is not available for functions requiring the entry of more than one numeric value (binominal functions) such as power, power root, or coordinates conversion.

The direct calculation feature is not effective for formulas:

e.g., **C-CE** $5*4 \rightarrow 5*4$ _
log $\rightarrow 5*4\text{LOG}$ _

The direct calculation feature is effective only for numeric values. Therefore, if hex numbers A to F are entered for hex to decimal conversion, the direct calculation feature will remain inoperative. In such a case, use the ordinary manual calculation using the **ENTER** key.

Note: After a direct calculation is done, the recall feature is not operative. Operation of the **◀** or **▶** key will only display the cursor.

Using as a Calculator

Priority in Manual Calculations

In the BASIC mode, you can type in formulas in the exact order in which they are written, including parentheses or functions. The order of priority in calculation and treatment of intermediate results will be taken care of by the computer itself.

The internal order of priority in manual calculations is as follows:

- 1) Recalling variables or π .
- 2) Functions (SIN, COS, etc.)
- 3) Power (^) and power root (ROT)
- 4) Signs (+, -)
- 5) Multiplication and division (*, /)
- 6) Addition and subtraction (+, -)
- 7) Comparison of magnitude (>, >=, <, <=, <>)
- 8) Logical operations (AND, OR, NOT, and XOR)

Notes: • If parentheses are used in a formula, the operation given within the parentheses has the highest priority.

- Composite functions are operated from right to left ($\sin \cos^{-1} 0.6$).
- Chained power (3^{4^2} or 3^{4^2}) or power root are operated from right to left.
- For the above items 3) and 4), the last entry in the calculation formula has a higher priority.

(e.g.) $-2^4 \rightarrow -(2^4)$

$3^{-2} \rightarrow 3^{-2}$

CHAPTER 4

CONCEPTS AND TERMS OF BASIC

In this chapter, we will examine some concepts and terms of the BASIC language.

String Constants

In addition to numbers, there are many ways that the **SHARP COMPUTER** uses letters and special symbols. These letters, numbers, and special symbols are called characters. These characters are available on the computer.

```

1 2 3 4 5 6 7 8 9 0
A B C D E F G H I J K L M N O P Q R S T U V W X Y Z
! " # $ % & ( ) * + , - . / : ; < = > ? @ √ π ^

```

In BASIC, a collection of characters is called a **string**. For the computer to tell the difference between a string and other parts of a program, such as verbs or variable name, you must enclose the characters of the string in quotation marks ("").

The following are examples of string constants:

```

"HELLO"
"GOODBYE"
"SHARP COMPUTER"

```

The following are not valid string constants:

```

"COMPUTER      No ending quote
"ISN"T"        Quote can't be used within a string

```

Hexadecimal Numbers

The decimal system is only one of many different systems to represent numbers. Another which has become quite important when using computers is the hexadecimal numbering system. The hexadecimal system is based on 16 instead of 10. To write hexadecimal numbers, you use the familiar 0 to 9 and 6 more "digits": A, B, C, D, E, and F. These correspond to 10, 11, 12, 13, 14, and 15. When you want the computer to treat a number as hexadecimal, put an ampersand '&' character in front of the numeral:

```

&A = 10
&10 = 16
&100 = 256
&FFFF = 65535

```

Concepts and Terms of BASIC

Those with some computer background may notice that the last number (65535) is the same as the largest number in the special group of limits discussed in the paragraph "Limits" on page 67. Hexadecimal notation is never absolutely necessary in using the computer, but there are special applications where it is convenient.

Variables

Computers are made up of many tiny memory areas called bytes. Each byte can be thought of as a single character. For instance, the word byte requires four bytes of memory because there are four characters in it. To see how many bytes are available for use, simply type in MEM **[ENTER]**. The number displayed is the number of bytes available for writing programs. This technique works fine for words, but is very inefficient when you try to store numbers. For this reason, numbers are stored in a coded fashion. Thanks to this coding technique, your computer can store large numbers in only eight bytes. The largest number that can be stored is +9.99999999 E + 99.

The smallest number is +1.E-99. This gives you quite a range to choose from. However, if the result of a calculation exceeds this range, the computer will let you know by turning on the error annunciator and by displaying the error message in the screen. This annunciator is a small E in the upper right-hand corner of the screen. For the error message, refer to Appendix A. To see it right now type in:

9 **[EXP]** 99 * 9 **[ENTER]**

To get the computer working properly again, just press the **[C-CE]** key. But how do you go about storing all this information? It's really very easy. The computer likes to use names for different pieces of data. Let's store the number 556 into the computer. You may call this number by any name that you wish, but for this exercise, let's use the letter R. The statement, LET, can be used to instruct the computer to assign a value to a variable name but only in a program statement. However, the LET command is not necessary, so we will not use it very often. Now, type in R = 556 and press the **[ENTER]**. The computer now has the value 556 associated with the letter R. These letters that are used to store information are called **variables**. To see the content of the variable R, press the **[C-CE]** key, the letter R key, and the **[ENTER]** key. The computer responds by showing you the value 556 on the right of your screen. This ability can become very useful when you are writing programs and formulas.

Next, let's use the R variable in a simple formula. In this formula, the variable R stands for the radius of a circle whose area we want to find. The formula for the area of a circle is: $A = \pi * R^2$. Type in R **[SHIFT]** **[^]** 2 **[*]** **[SHIFT]** **[π]** **[ENTER]**. The result is 971179.3866. This technique of using variables in equations will become more understandable as we get into writing programs.

So far, we've only discussed numeric variables. What about storing alphabetic characters? Well, the idea is the same, but, so the computer will know the difference between the two kinds of variables, add a \$ to the variable name. For instance, let's store the word BYTE in the variable B\$. Notice the \$ after the B?

This tells the computer that the contents of the letter B are alphabetic, or string data.

To illustrate this, key in B **SHIFT** **R** = **SHIFT** **W** BYTE **SHIFT** **W** **ENTER**. The value BYTE is now stored in the variable B\$. To make sure of this, type in B **SHIFT** **R** **ENTER**. The screen shows BYTE. This time the display is on the left side of the screen, instead of the right.

Variables handled by the **SHARP COMPUTER** are divided into the following:

Variables	{	Numeric variables	{	Fixed numeric variables (A to Z)
				Simple numeric variables (AB, C1, etc.)
				Numeric array variables
				Fixed character variables (A\$ to Z\$)
		String variables	{	Simple character variables (BB\$, C2\$, etc.)
				Character array variables

Fixed Variables

The first section, fixed variables, is always used by the computer for storing data. It can be thought of as pre-allocated variable space. In other words, no matter how much memory your program uses up, you will always have at least 26 variables to choose from to store data in. This data can be one of two types: NUMERIC or STRING (alphabetic character). Fixed memory locations are eight bytes long and can be used for only one type of data at a time. To illustrate this, type in the following examples:

```
A = 123 ENTER
A$ ENTER
```

You get the message:

```
ERROR 9
```

This means that you have put numeric data into the area of memory called A and then told the computer to show you that information again as STRING data. This confuses the computer so it says that there is an error condition. Press the **C-CE** key to clear the error condition. Now try the following example:

```
A$ = "ABC" ENTER
A ENTER
```

Concepts and Terms of BASIC

Again, the computer is confused and gives the ERROR 9 message. Look at the figure shown below to see that the variable name A equals the same area in memory as the variable name A\$, and that B equals B\$, and so on for all the letters of the alphabet.

Figure:

A = A\$ = A(1) = A\$(1)
B = B\$ = A(2) = A\$(2)
C = C\$ = A(3) = A\$(3)
D = D\$ = A(4) = A\$(4)
E = E\$ = A(5) = A\$(5)
F = F\$ = A(6) = A\$(6)
G = G\$ = A(7) = A\$(7)
H = H\$ = A(8) = A\$(8)
I = I\$ = A(9) = A\$(9)
J = J\$ = A(10) = A\$(10)
K = K\$ = A(11) = A\$(11)
L = L\$ = A(12) = A\$(12)
M = M\$ = A(13) = A\$(13)
N = N\$ = A(14) = A\$(14)
O = O\$ = A(15) = A\$(15)
P = P\$ = A(16) = A\$(16)
Q = Q\$ = A(17) = A\$(17)
R = R\$ = A(18) = A\$(18)
S = S\$ = A(19) = A\$(19)
T = T\$ = A(20) = A\$(20)
U = U\$ = A(21) = A\$(21)
V = V\$ = A(22) = A\$(22)
W = W\$ = A(23) = A\$(23)
X = X\$ = A(24) = A\$(24)
Y = Y\$ = A(25) = A\$(25)
Z = Z\$ = A(26) = A\$(26)

Simple Variables

Simple variable names are specified by two or more alphanumeric characters, such as AA or B1. Unlike fixed variables, simple variables have no dedicated storage area in the memory. The area for simple variables is automatically set aside (within the program and data area) when a simple variable is first used.

Since separate memory areas are defined for simple numeric variables and simple character variables even if they have the same name, variables such as AB and AB\$, for example, may be used at the same time.

Whereas alphanumeric characters are usable for simple variable names, the first character of a variable name must always be alphabetic and uppercase. If more than two characters are used to define a variable name, only the first two characters are meaningful.

- Notes:**
- The functions and BASIC commands inherent to the computer are not usable as variable names.
e.g., PI, IF, TO, ON, SIN, etc.
 - Each simple character variable can hold up to 16 characters and symbols.

Array Variables

For some purposes, it is useful to deal with numbers as an organized group, such as a list of scores or a tax table. In BASIC these groups are called **arrays**. An array can be either **one-dimensional**, like a list, or **two-dimensional**, like a table.

To define an array, the DIM (short for dimension) statement is used. Arrays must always be "declared" (defined) before they are used (not like the single-value variables we have been using). The form for the numeric DIMension statement is:

DIM numeric-variable-name (size)

where:

numeric-variable-name is a variable name which conforms to the normal rules for numeric variable names previously discussed.

size is the number of storage locations and must be a number in the range 0 through 255. Note that when you specify a number for the size, you get one more location than you specified.

Examples of legal numeric DIMension statements are:

<p>DIM X(5) DIM AA(24) DIM Q5(0)</p>
--

The first statement creates an array X with 6 storage locations. The second statement creates an array AA with 25 locations. The third statement creates an array with one location and is actually rather silly since (for numbers at least), it is the same as declaring a single-value numeric variable.

It is important to know that array variable X and variable X are separate, and unique to SHARP. The first X denotes a series of numeric storage locations, and the second a single and different location.

Now that you know how to create arrays, you might be wondering how to refer to each storage location. Since the entire group has only one name, the way in which we refer to a single location (called an "element") is to follow the group name with a number in parentheses. This number is called "subscript". Thus, for example, to store the number 8 into the fifth element of our array X (declared previously), we would write:

X(4) = 8

Concepts and Terms of BASIC

If the use of 4 is puzzling, remember that the numbering of elements begins at zero and continues through the size number declared in the DIM statement.

The real power of arrays lies in the ability to use an expression or a variable name as a subscript.

To declare a character array, a slightly different form of the DIM statement is used:

DIM character-variable-name (size) * length

where:

character-variable-name is a variable name which conforms to the rules for normal character variables as discussed previously.

size is the number of storage locations and must be in the range 0 to 255. Note that when you specify a number, you get one more location than you specified.

*length is optional. If used, it specifies the length of each of the strings that compose the array. Length is a number in the range 1 to 80. If this clause is not used, the strings will have the default length of 16 characters.

Examples of legal character array declarations are:

```
DIM X$(4)
DIM NM$(10)*10
DIM IN$(1)*80
DIM R$(0)*26
```

The first example creates an array of five strings, each able to store 16 characters. The second DIM statement declares an array NM with eleven strings of 10 characters each. Explicit definition of strings smaller than the default helps to conserve memory space. The third example declares a two-element array of 80-character strings and the last example declares a single string of twenty-six characters.

Besides the simple arrays we have just studied, the computer allows "two-dimensional" arrays. By analogy, a one-dimensional array is a list of data arranged in a single column. A two-dimensional array is a table of data with rows and columns. The two-dimensional array is declared by the statement:

DIM numeric-variable-name (rows, columns)

or

DIM character-variable-name (rows, columns)*length

where:

rows specifies the number of rows in the array. This must be a number in the range 0 through 255. Note that when you specify the number of rows you get one more row than the specification.

columns specifies the number of columns in the array. This must be a number in the range 0 through 255. Note that when you specify the number of columns you get one more column than the specification.

The following diagram illustrates the storage locations that result from the declaration DIM T (2, 3) and the subscripts (now composed of two numbers) that pertain to each storage location:

	Column 1	Column 2	Column 3	Column 4
Row 0	T (0, 0)	T (0, 1)	T (0, 2)	T (0, 3)
Row 1	T (1, 0)	T (1, 1)	T (1, 2)	T (1, 3)
Row 2	T (2, 0)	T (2, 1)	T (2, 2)	T (2, 3)

Note: Two-dimensional arrays can rapidly eat up storage space. For example, an array with 25 rows and 35 columns uses 875 storage locations!

Arrays are very powerful programming tools.

The following table shows the number of bytes used to define each variable and the number used by each program statement.

Variable	Variable name	Data	
Numeric variable	7 bytes	8 bytes	
String variable	7 bytes	Array variable	Specified number
		Simple variable (two-character variable)	16 bytes

* For example, if DIM Z\$ (2,3)*10 is specified, 12 variables, each capable of storing 10 characters, are reserved. This requires 7 bytes (variable name) + 10 bytes (number of characters) × 12 = 127 bytes.

Concepts and Terms of BASIC

Element	Line number	Statement & function	Others, <input type="button" value="ENTER"/>
Number of bytes used	3 bytes	1 byte or 2 bytes	1 byte

Variables in the Form of A()

Whereas a data area on the computer's memory is set aside for fixed variables, it may also be used to define subscripted variables which have the same form as array variables.

There are 26 fixed variable names available, i.e., A through Z (A\$ through Z\$). Each of these names can be subscripted with numbers 1 through 26, such as A(1) – A(26) or A\$(1) – A\$(26). This means that variable A(1) may be used in place of variable A, A(2) in place of B, A(3) in place of C, and so forth.

However, if an array named A or A\$ has already been defined by the DIM statement, subscripted variables named A cannot be defined. For example, if array A is defined by DIM A(5), the locations for A(0) through A(5) are set aside in the program/data area. So if you specify variable A(2), it does not refer to fixed variable B, but refers to the array variable A(2) defined in the program/data area. If you specify A(9), it will cause an error since A(9) is outside the range of the dimension specified by the DIM A(5) statement.

In turn, if subscripted variables are already defined in the form of A(), it is not possible to define array A or A\$ by using the DIM statement, unless the definition for the subscripted variables is cleared with the CLEAR statement.

* Using subscripts in excess of 26:

If subscripts greater than 26 are used for subscripted variables A() when array A is not defined by a DIM statement, the corresponding locations in the program/data area are set aside for these A() variables. For instance, if you execute A(35) = 5, locations for variables A(27) to A(35) will be reserved in the program/data area.

While variables subscripted in excess of 26 are treated as array variables, they are subject to the following special restrictions:

(1) Locations for an array with the same name must be contiguous in the program/data area. Otherwise, an error will occur.

1Ø DIM B(2)

2Ø A(28)=5

3Ø BC--=12

4Ø A(30)=9

If this program is executed, the array named "A" is not defined in two consecutive segments in the program data area, and an error will result at line 40.

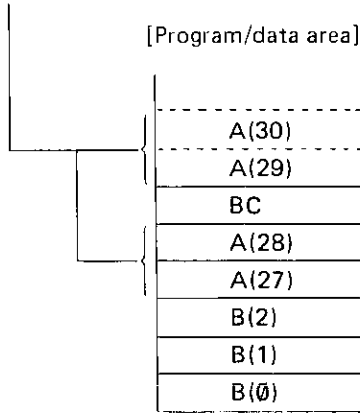

- (2) Numeric array variables and character array variables with the same subscript cannot be defined at the same time. For example, A(30) and A\$(30) cannot be defined at the same time as they use the same location in the program/data area.
- (3) Two dimensional arrays cannot be defined, nor is it possible to specify the length of character strings to be held in character array variables. For example, the length of a character string which can be held in character array variable A\$() is limited to seven characters or less.
- (4) Variables subscripted with zero (0) cannot be defined. If A(0) or A\$(0) is defined, an error will result.
- (5) When subscripts greater than A(27) or A\$(27) are first used, 7 bytes are used for the variable name, and 8 bytes are used for each variable.

Expressions

An **expression** is some combination of variables, constants, and operators which can be evaluated to a single value. The calculations which you entered in Chapter 3 were examples of expressions. Expressions are an intrinsic part of BASIC programs. For example, an expression might be a formula that computes an answer to some equation, a test to determine the relationship between two quantities, or a means to format a set of strings.

Concepts and Terms of BASIC

Numeric Operators

The computer has five **numeric operators**. These are the arithmetic operators which you used when exploring the use of the computer as a calculator in Chapter 3:

- + Addition
- Subtraction
- * Multiplication
- / Division
- ^ Power

A **numeric expression** is constructed in the same way that you entered compound calculator operations. Numeric expressions can contain any meaningful combination of numeric constants, numeric variables, and these numeric operators:

$(A * B) ^ 2$
 $A(2,3) + A(3,4) + 5.0 - C$
 $(A/B) * (C+D)$

String Expressions

String expressions are similar to numeric expressions except that there is only one string operator – concatenation (+). This is the same symbol as used for plus. When used with a pair of strings, the + attaches the second string to the end of the first string and makes one longer string. You should take care in making more complex string concatenations and other string operations because the work space used by the computer for string calculations is limited to only 79 characters.

Note: String quantities and numeric quantities cannot be combined in the same expression unless one uses one of the functions which convert a string value into a numeric value or vice versa:

"15" + 10 is illegal
"15" + "10" is "1510", not "25"

Relational Expressions

A relational expression compares two expressions and determines whether the stated relationship is True or False. The relational operators are:

- > Greater Than
- >= Greater Than or Equal To
- = Equals
- <> Not Equal To
- <= Less Than or Equal To
- < Less Than

The following are valid relational expressions:

A < B
 C(1,2) >= 5
 D(3) <> 8

If A was equal to 10, B equal to 12, C(1,2) equal to 6, and D(3) equal to 9, all of these relational expressions would be True.

Chapter strings can also be compared in relational expressions. The two strings are compared character by character according to their ASCII value starting at the first character (see Appendix B for ASCII values). If one string is shorter than the other, a 0 or NUL will be used for any missing positions. All of the following relational expressions are True:

"ABCDEF" = "ABCDEF"
 "ABCDEF" <> "ABCDE"
 "ABCDEF" > "ABCDE"

Relational expressions evaluate to either True or False. The computer represents True by a 1; False is represented by a 0. In any logical test, an expression which evaluates to 1 or more will be regarded as True, whereas one which evaluates to 0 or less will be considered False. Good programming practice, however, dictates the use of an explicit relational expression instead of relying on this coincidence.

Logical Expressions

Logical expressions are relational expressions which use operators AND, OR, XOR, and NOT. AND, OR, and XOR are used to connect two relational expressions; the values of the combined expressions are as shown in the following tables.

A AND B		Value of A	
		True	False
Value of B	True	True	False
	False	False	False

A OR B		Value of A	
		True	False
Value of B	True	True	True
	False	True	False

A XOR B		Value of A	
		True	False
Value of B	True	False	True
	False	True	False

Note: Value of A and B must be 0 (false) or 1 (true).

Concepts and Terms of BASIC

The XOR instruction cannot be used in combination with the AND or OR instruction in an expression. To execute expression $D=(A \text{ XOR } B) \text{ AND } C$, for example, divide the expression into two parts for execution: $D=A \text{ XOR } B$ and $D=D \text{ AND } C$.

- Decimal numbers can be expressed in the binary notation of 16 bits as follows:

Decimal notation	16-bit binary notation
32767	0111111111111111
:	:
3	0000000000000011
2	0000000000000010
1	0000000000000001
0	0000000000000000
-1	1111111111111111
-2	1111111111111110
-3	1111111111111101
:	:
-32768	1000000000000000

The negation (NOT) of a binary number 0000000000000001 is taken as follows:

NOT	0000000000000001
(Negative)→	1111111111111110

Thus, 1 is inverted to 0, and 0 to 1 for each bit, which is called "negation (NOT operation)." Then, the following will result when 1 and NOT 1 are added together:

	0000000000000001 (1)	
+) <u>1111111111111110</u>	(NOT 1) ones complement
	1111111111111111 (-1) twos complement

Thus, all bits become 1. According to the above number list, the bits become -1 in decimal notation, that is, $1 + \text{NOT } 1 = -1$.

The relationship between numerical value X and its negated (or inverted) value NOT X is:

$$X + \text{NOT } X = -1$$

This results in an equation of $\text{NOT } X = -X - 1$, i.e.,

$$\text{NOT } X = -(X + 1)$$

From the equation, the following results are obtained:

- NOT 0 = -1
- NOT -1 = 0
- NOT -2 = 1

More than two relational expressions can be combined with these operators. You should take care to use parentheses to make the intended comparison clear.

- (A<9) AND (B>5)
- (A>=10) AND NOT (A>20)
- (C=5) OR (C=6) OR (C=7)
- (X>=50) XOR (X<70)

The COMPUTER implements logical operators as "bitwise" logical functions on 16-bit quantities. (See note on relational expressions and True and False.) In normal operations, this is not significant because the simple 1 and 0 (True and False) which result from a relational expression uses only a single bit. If you apply a logical operator to a value other than 0 or 1, it works on each bit independently. For example, if A is 17 and B is 22, (A OR B) is 23:

$$\begin{array}{r}
 17 \text{ OR } 22 \text{ is } 10001 \text{ .. } 17 \\
 \quad \quad \quad 10110 \text{ .. } 22 \\
 \hline
 \quad \quad \quad 10111 \text{ .. } 23 \text{ in decimal number}
 \end{array}
 \left. \vphantom{\begin{array}{r} 17 \\ 22 \\ 23 \end{array}} \right\} \text{ OR operation}$$

17 and 22 are first converted into binary numbers. Then for each digit, logical 1 is left if either bit is 1. Otherwise, logical 0 is left.

For example, if A is 41 and B is 27, (A XOR B) is 50:

$$\begin{array}{r}
 41 \text{ XOR } 27 \text{ is } 101001 \text{ .. } 41 \\
 \quad \quad \quad 011011 \text{ .. } 27 \\
 \hline
 \quad \quad \quad 110010 \text{ .. } 50 \text{ in decimal number}
 \end{array}
 \left. \vphantom{\begin{array}{r} 41 \\ 27 \\ 50 \end{array}} \right\} \text{ XOR operation}$$

41 and 27 are first converted into binary numbers. Then, for each digit, logical 0 is left if both bits are 1 or 0.

If you are a proficient programmer, there are certain applications where this type of operation can be very useful. Beginner programmers should stick to clear, simple True or False relational expressions.

Parentheses and Operator Precedence

When evaluating complex expressions, the computer follows a predefined set of priorities which determine the sequence in which operators are evaluated. This can be quite significant:

Concepts and Terms of BASIC

$5 + 2 * 3$ could be
 $5 + 2 = 7$ or $2 * 3 = 6$
 $7 * 3 = 21$ $6 + 5 = 11$

The exact rules of "operator precedence" are given in Appendix D.

To avoid having to remember all these rules and to make your program clearer, always use parentheses to determine the sequence of evaluation. The above example is clarified by writing either:

$(5 + 2) * 3$ or $5 + (2 * 3)$

RUN Mode

In general, any of the above expressions can be used in the RUN mode well as in programming a BASIC statement. In the RUN mode an expression is computed and displayed immediately. For example:

Input

$(5 > 3)$ AND $(2 < 6)$

Display

The 1 means that the expression is True.

Functions

Functions are special components of the BASIC language which take one value and transform it into another value. Functions act like variables whose value is determined by the value of other variables or expressions. ABS is a function which produces the absolute value of its argument:

ABS (-5) is 5

ABS (6) is 6

LOG is a function which computes the log to the base 10 of its argument.

LOG (100) is 2

LOG (1000) is 3

A function can be used any place that a variable can be used. Many functions do not require the use of parentheses:

LOG 100 is the same as LOG (100)

You must use parentheses for functions which have more than one argument. Using parentheses always makes programs clearer.

See Chapter 8 for a complete list of functions available on the computer.

CHAPTER 5

PROGRAMMING THE COMPUTER

In the previous chapter, we examined some of the concepts and terms of the **BASIC** programming language. In this chapter, you will use these elements to create programs on the computer. Let us reiterate, however, that this is not a manual on how to program in **BASIC**. What this chapter will do is to familiarize you with the use of **BASIC** on your computer.

Programs

A **program** consists of a set of instructions to the computer. Remember the computer is only a machine. It will perform the exact operations that you specify. You, the programmer, are responsible for issuing the correct instructions.

BASIC Statements

The computer interprets instructions according to a predetermined format. This format is called a **statement**. You always enter **BASIC** statements in the same pattern. Statements must start with a line number:

```
10: PRINT "HELLO"  
20: END  
30:
```

Line Numbers

Each line of a program must have a unique line number—any integer between 1 and 65279. Line numbers are the reference for the computer. They tell the computer the order in which to execute the program. You need not enter lines in sequential order (although if you are a beginning programmer, it is probably less confusing for you to do so). The computer always begins execution with the lowest line number and moves sequentially through the lines of a program in ascending order.

When programming, it is wise to allow increments in your line numbering (10, 20, 30, ... 10, 30, 50, etc.). This enables you to insert additional lines if necessary.

CAUTION: Do not use the same line numbers in different programs. If you use the same line number, the oldest line with that number is deleted when you enter the new line.

BASIC Verbs

All BASIC statements must contain **verbs**. Verbs tell the computer what action to perform. A verb is always contained within a program, and as such is not acted upon immediately.

```
10: PRINT "HELLO"  
20: END  
30:
```

Some statements require or allow an **operand**:

```
10: PRINT "HELLO"  
20: END  
30:
```

Operands provide information to the computer telling it what data the verb will act upon. Some verbs require operands; with other verbs they are optional. Certain verbs do not allow operands. (See Chapter 8 for a complete listing of BASIC verbs and their use on the computer.)

BASIC Commands

Commands are instructions to the computer which are entered outside of a program. Commands instruct the computer to perform some action with your program or to set modes which affect how your programs are executed.

Unlike verbs, commands have immediate effects—as soon as you complete entering the command (by pressing the **ENTER** key), the command will be executed. Commands are not preceded by a line number:

```
RUN  
NEW  
RADIAN
```

Some verbs may also be used as commands. (See Chapter 8 for a complete listing of BASIC commands and their use on the computer.)

Modes

The RUN mode is used to execute the programs you create.

The PROgram mode is used to enter and edit your programs.

Beginning to Program on the Computer

After all your practice in using the computer as a calculator, you are probably quite at home with the keyboard. From now on, when we show an entry, we will not show every keystroke. Remember to use **[SHIFT]** to access characters above the keys and **[ENTER]** KEY.

Now you are ready to program.

Slide the POWER SWITCH to the ON position and then press the **[BASIC]** key twice. You will see the following initial information in the display.



The above display shows that the computer is in PROgram mode.

(If a dash indicator is at the CAL or RUN label, press the **[BASIC]** key once or twice.) Enter the NEW command.

Input

NEW **[ENTER]**

Display

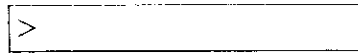

The NEW command clears the computer's memory of all existing programs and data. The prompt appears after you press **[ENTER]**, indicating that the computer is awaiting input.

Example 1 – Entering and Running a Program

Make sure the computer is in the PRO mode and enter the following program:

Input

10 PRINT "HELLO"

Display

10 PRINT "HELLO" –

Notice that when you press **[ENTER]**, the computer displays your input, automatically inserting a colon (:) between the line number and the verb. Verify that the statement is in the correct format.

Now press the **[BASIC]** key to set the RUN mode.



Input

RUN **[ENTER]**

Display

HELLO

Programming the Computer

Since this is the only line of the program, the computer will stop executing at this point. Press **ENTER** to get out of the program and reenter RUN if you wish to execute the program again.

Example 2 – Editing a Program

Suppose you wanted to change the message that your program was displaying, that is, you wanted to edit your program. With a single line program, you could just retype the entry, but as you develop more complex programs, editing becomes a very important component of your programming. Let's edit the program you have just written.

Are you still in the RUN mode? If so change to the PROgram mode.

You need to recall your program in order to edit it. Use the Up Arrow (**↑**) to recall your program. If your program was completely executed, the **↑** key will recall the last line of the program. If there was an error in the program, or if you used the BREAK (**BRK**) key to stop execution, the **↑** key will recall the line in which the error or BREAK occurred. To make changes in your program, use the **↑** key to move up in your program (recall the previous line) and the **↓** key to move down in your program (display the next line). If held down, the **↑** and **↓** keys will scroll vertically, that is, they will display each line moving up or down in your program.

You will remember that to move the cursor within a line, you use the **▶** (right arrow) and **◀** (left arrow). Using the **▶** key, position the cursor over the first character you wish to change:

Input

↑

◀◀◀◀◀

Display

10: PRINT "HELLO"

10 PRINT "HELLO"

Notice that the cursor is now in the flashing block form indicating that it is "on top of" an existing character. Type in:

Input

GOOD"!

Display

10 PRINT "GOOD"!_

Don't forget to press **ENTER** at the end of the line. If you now change to the RUN mode by pressing **BASIC** and enter the RUN command, the following appears:

Input

RUN **ENTER**

Display

ERROR 1 IN 10

This is a new kind of error message. Not only is the error type identified (our old friend the syntax error) but the line number in which the error occurs is also indicated.

Press the **[ESC]** and then return into the PROgram mode. You must be in the PROgram mode to make changes in a program. Using the **[↑]**, recall the last line of your program.

Input

Display

[↑]

10: PRINT "GOOD" !

The flashing cursor is positioned over the problem area. In Chapter 4, you learned that when entering string constants in BASIC, all characters must be contained within quotation marks. Use the **[DEL]** key to eliminate the "!":

Input

Display

[SHIFT] [DEL]

10 PRINT "GOOD" _

Now let's put the "!" in the correct location. When editing programs, DELEte and INSert are used in exactly the same way as they are in editing calculations (see Chapter 3). Using the **[←]**, position the cursor on top of the character which will be the first character following the insertion.

Input

Display

[←]

10 PRINT "GOOD" _

Press the **[INS]** key. A **[]** will indicate the spot where the new data will be entered:

Input

Display

[SHIFT] [INS]

10 PRINT "GOOD" []

Type in the !. The display looks like this:

Input

Display

!

10 PRINT "GOOD!"

Remember to press **[ENTER]**, so the correction will be entered into the program.

NOTE: If you wish to DELEte an entire line from your program, just type in the line number and the original line will be eliminated.

Example 3 – Using Variables in Programming

If you are unfamiliar with the use of numeric and string variables in BASIC, reread these sections in Chapter 4.

Using variables in programming allows much more sophisticated use of the computer's computing abilities.

Remember, you assign numeric fixed variables using any letters from A to Z:

```
A = 5
```

To assign a string variable, you also use a letter, followed by a dollar sign. **Do not use the same letter in designating a numeric and a string fixed variable.** You cannot designate A and A\$ in the same program.

Remember that each string fixed variable must not exceed 7 characters in length:

```
A$ = "TOTAL"
```

The value assigned to a variable can change during the execution of a program, taking on the value typed in or computed during the program. One way to assign a variable is to use the INPUT verb. In the following program, the value of A\$ will change in response to the data typed in answer to the inquiry "WORD?".

Enter this program:

```
10 INPUT "WORD?"; A$
20 B= LEN (A$)
30 PRINT "WORD _IS _"; B; " _LTRS"
40 END
```

↑
_____ means space

Before you RUN the program, note several new features. Line 30 of this program exceeds the 24-character maximum of the computer's display. When a line is longer than 24 characters (up to the 79-character maximum), the computer moves the characters to the left as the 24-character maximum is exceeded. This does not destroy the previous input. This move to the left is referred to as horizontal scrolling.

The second new element in this program is the use of the END statement to signal the completion of a program. END tells the computer that the program is completed. It is always good programming practice to use an END statement.

As your programs become more complex, you may wish to review them before beginning execution. To look at your program, use the LIST command. LIST, which can only be used in the PROgram mode, displays programs beginning with the lowest line number.

Try listing this program:

Input

Display

LIST

10: INPUT "WORD?"

Use the and keys to move through your program until you have reviewed the entire program. To review a line which contains more than 24 characters, move the cursor to the extreme right of the display and the additional characters will appear on the screen. After checking your program, run it:

Input

Display

RUN

WORD?_

HELP

WORD IS 4. LTRS

>

This is the end of your program. Of course, you may begin it again by entering RUN. However, this program would be a bit more entertaining if it presented more than one opportunity for input. We will now modify the program, so it will keep running without entering RUN after each answer.

Return to the PRO mode and use the up or down arrow (or LIST) to reach line 40.

You may type 40 to delete the entire line or use the key to position the cursor over the E in END. Change line 40 so that it reads:

40: GOTO 10

Now RUN the modified program.

The GOTO statement causes the program to loop (keep repeating the same operation). Since you put no limit on the loop, it will keep going forever (an "infinite" loop). To stop this program, hit the BREAK () key.

When you have stopped a program using the key, you can restart it using the CONT command. CONT stands for CONTInue. With the CONT command, the program will restart on the line that was being executed when the key was pressed.

Example 4 – More Complex Programming

Although the computer has a factorial function, we will use an example of the factorial computation in this section to explain more complex programming. The following program computes N Factorial (N!). The program begins with 1 and computes N! up to the limit which you enter. Enter this program.

```
100 F = 1: WAIT 118
110 INPUT "LIMIT?"; L
120 FOR N = 1 TO L
130 F = F * N
140 PRINT N, F
150 NEXT N
160 END
```

Several new features are contained in this program. The WAIT verb in line 100 controls the length of time that displays are held before the program continues. The numbers and their factorials are displayed as they are computed. The time they appear on the display is set by the WAIT statement to approximately 2 seconds, instead of waiting for you to press **ENTER**.

Also in line 100, notice that there are two statements on the same line separated by a colon (:). **You may put as many statements as you wish on one line, separating each by a colon, up to the 80-character maximum including **ENTER**.** Multiple statement lines can make a program hard to read and modify, however, so it is a good programming practice to use them only where the statements are very simple or there is some special reason to want the statements on one line.

Also in this program, we have used the FOR verb in line 120 and the NEXT verb in line 150 to create a loop. In Example 3, you created an "infinite" loop which kept repeating the statements inside the loop until you pressed the **BRK** key. With the FOR/NEXT loop, the computer adds 1 to N each time execution reaches the NEXT verb. It then tests to see if N is larger than the limit L. If N is less than or equal to L, execution returns to the top of the loop and the statements are executed again. If N is greater than L, execution continues with line 160 and the program stops.

You may use any numeric variable in a FOR/NEXT loop. You also do not have to start counting at 1 and you can add any amount at each step. See Chapter 8 for details.

We have labeled this program with line numbers starting with 100. Labeling programs with different line numbers allows you to have several programs in memory at one time. To RUN this program instead of the one at line 10 enter:

```
RUN 100
```

In addition to executing different programs by giving their starting line number, you can give programs an alphabetical name and start them with the **DEF** key (see Chapter 6).

You will notice that while the program is running, the BUSY indicator is lit at those times that there is nothing on the display. RUN the program a few more times and try setting N at several different values.

Storing Programs in Memory

Programs remain in memory when you turn off the computer, or it undergoes an AUTO OFF. Even if you use the **BRK** , **C-CE** , or **CA** key, the programs will remain in memory.

Programs are lost from memory only when you:

- * enter NEW before beginning programming.
- * initialize the computer using the RESET button.
- * create a new program using the SAME LINE NUMBERS as a program already in memory.
- * change the batteries.

This brief introduction to programming on the computer should serve to illustrate the exciting programming possibilities of your new computer.

CHAPTER 6 SHORT CUTS

The computer includes several features which make programming more convenient by reducing the number of keystrokes required to enter repetitive material.

One such feature is in the availability of abbreviations for verbs and commands (see Chapter 8).

This chapter discusses the additional feature which can eliminate unnecessary typing—the **DEF** key. (DEF is short for “DEFINE”.)

The DEF Key and Labeled Programs

Often you will want to store several different programs in the computer memory at one time. (Remember that each must have unique line numbers.) Normally, to start a program with a RUN or GOTO command, you need to remember the beginning line number of each program (see Chapter 8). But, there is an easier way! You can label each program with a letter and execute the program using only two keystrokes. This is how to label a program and execute it using DEF:

Note: Put a label on the first line of each program that you want to reference.

The label consists of a single character in quotes, followed by a colon (:).

```
10: "A": PRINT "FIRST"
20: END
30: "B": PRINT "SECOND"
40: END
```

Any one of the following characters can be used: A, S, D, F, G, H, J, K, L, ', Z, X, C, V, B, N, M, and SPC. Notice that these are the keys in the bottom two rows of the alphabetic portion of the keyboard.

Note: To execute the program, instead of typing RUN 80 or GOTO 10, you need only press the **DEF** key and then the letter used as a label. In the above example, pressing **DEF** and then 'B' would cause 'SECOND' to appear on the display.

When DEF is used to execute a program, variables and mode settings are affected in the same way as when GOTO is used. See Chapter 8 for details.

Short Cuts

Template

One template is provided with the computer. You can use this template to help you remember frequently used **DEF** key assignments.

For example, if you have one group of programs which you often use at the same time, label the programs with letters and mark the template and set it over the two bottom rows of the keyboard so that you can easily begin execution of any of the programs with two keystrokes.

Example:

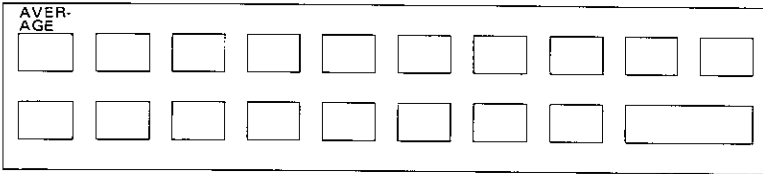

CHAPTER 7 USING CE-126P PRINTER/CASSETTE INTERFACE

The optional **CE-126P** Printer/Cassette Interface allows you to add a printer and to connect a cassette recorder to your **SHARP COMPUTER**.

The **CE-126P** features:

- * 24-column thermal printer.
- * Convenient paper feed and tear bar.
- * Simultaneous printing of calculation results as desired (except in the CAL mode)
- * Easy control of display or printer outputs in BASIC.
- * Built-in cassette interface with remote function.
- * Manual and programmed control of recorder for storing programs and data
- * Dry battery operation for portability.

For connecting the computer to the CE-126P, refer to the instruction manual supplied with the CE-126P.

Using Printer

If you are using the computer for manual calculations in BASIC mode, you may use the CE-126P to simultaneously print the results of your calculations.

Using the Options

CAUTION:

The results obtained by the direct calculation feature in manual calculations cannot be printed. Calculation results in the CAL mode also cannot be printed.

Printing is easily accomplished by pressing the **SHIFT** key and then the **ENTER** key (P↔NP) while in the RUN mode.

The printer indicator (a dash symbol) will appear just above the "PRINT" label in the lower right area of the display. After this, when you press the **ENTER** at the end of a calculation, the contents of the display will be printed on one line and the results will be printed on the next. For example:

Input

300/50

ENTER

Paper

300/50

6.

You may print output on the printer from within BASIC programs by using the LPRINT statement (see Chapter 8 for details). LPRINT can be used in the same form as the PRINT statement. The difference is that if you PRINT something longer than 24 characters to the display, there is no way for you to see the extra characters. With the LPRINT verb, the extra characters will be printed on a second, and possibly a third, line as is required.

Programs which have been written with PRINT can be converted to work with the printer by including a PRINT=LPRINT statement in the program (see Chapter 8 for details). All PRINT statements following this statement will act as if they were LPRINT statements. PRINT=PRINT will reset this condition to its normal state. This structure may also be included in a program in an IF statement allowing a choice of output at the time the program is used.

You may also list your programs on the printer with the LLIST command (see Chapter 8 for details). If used without line numbers, LLIST will list all program lines currently in memory in their numerical order by line number. A line number range may also be given with LLIST to limit the lines which will be printed. When program lines are longer than 24 characters, two or more lines may be used to print one program line. The second and succeeding lines will be indented four or six characters so that the line number will clearly identify each separate program line. (Line number, 1 to 999: four-character indentation, over 999: six-character indentation)

Caution:

- In case an error (ERROR code 8) occurs due to a paper jam, remove the jam by pulling the paper toward the paper cutter and tearing off the paper. Then press the **C-CE** key to clear the error condition.

- When the printer is exposed to strong external electrical noise, it may print numbers at random. If this happens, depress the **[BRK]** key to stop the printing. Turn the **CE-126P** power off and on, and then press the **[C-CE]** key. Pressing the **[C-CE]** key will return the printer to its normal condition.
- When the printer causes a paper jam or is exposed to strong external electrical noise while printing, it may not operate normally and only the symbol "BUSY" is displayed. If this happens, depress the **[BRK]** key to stop printing. (Remove the paper jam.) Turn the **CE-126P** power off and on, and then press the **[C-CE]** key.
- When the **CE-126P** is not in use, turn off the printer switch to conserve the battery life.

Using Cassette Interface

Using this cassette interface will allow you to store programs and data from the computer onto cassette tape. Once on tape, you can load these programs and data back into the computer with a simple procedure.

Connecting the CE-126P to a tape recorder

Only these three connections are necessary:

1. Red plug into the MICrophone jack on the cassette recorder.
2. Gray plug into the EARphone jack on the cassette recorder.
3. Black plug into the REMote jack on the cassette recorder.

Cassette Tape Recorder

If you intend to use a cassette tape recorder, the following are the minimum tape recorder requirements for interfacing with the **CE-126P**:

Using the Options

Item	Requirements
1. Recorder Type	Any tape recorder, standard cassette or microcassette recorder, may be used in accordance with the requirements outlined below.
2. Input Jack	The recorder should have a minijack input labeled "MIC". Never use the "AUX" jack.
3. Input Impedance	The input jack should be a low impedance input (200~1,000 ohms).
4. Minimum Input level	Below 3 mV or -50 dB
5. Output Jack	Should be a minijack labeled "EXT.(EXTernal speaker)", "MONITOR" "EAR (EARphone)" or equivalent.
6. Output Impedance	Should be below 10 ohms.
7. Output Level	Should be above 1 V (practical maximum output above 100 mV).
8. Distortion	Should be within 15% within a range of 2 kHz through 4 kHz.
9. Wow and Flutter	0.3% maximum (WRMS)
10. Others	Recorder motor speed should not fluctuate.

* In case the miniplug provided with the **CE-126P** is not compatible with the input/output jacks of your tape recorder, special line conversion plugs commercially available may be used.

Note: Some tape recorders may reject connection due to different specifications. Those tape recorders having distortion, increased noise, and power deterioration after long years of use may not show satisfactory results owing to change in their electrical characteristics.

Operating the Cassette Interface and Recorder

1. Recording (saving) onto magnetic tape

See Tape Notes.

- (1) Turn off the REMOTE switch on the CE-126P.
- (2) Enter a program or data into the computer.
- (3) Load a tape into the tape recorder.
Determine the position on the tape where you want to record the program.
 - When using a tape, be sure the tape moves past the clear leader (nonmagnetic mylar material).
 - When using a tape already partially recorded, search for a location where no recording exists.
- (4) Connect the Interface's red plug to the tape recorder's MIC jack and the black plug to the REM jack.
- (5) Turn on the REMOTE switch.
- (6) Simultaneously press the RECORD and PLAY buttons on the tape recorder (to put it in RECORD mode).
- (7) Input recording instructions (CSAVE statement, PRINT# statement), and press the **ENTER** key for execution.

First set the computer in the "RUN" or "PRO" mode. Next operate the following keys: **C** **S** **A** **V** **E** **SHIFT** **"** file name **SHIFT** **"** **ENTER**.

(To write the contents of data memory onto tape, operate keys as follows: e.g.,

P **R** **I** **N** **T** **SHIFT** **#** **ENTER** .

e.g., **C** **S** **A** **V** **E** **SHIFT** **"** **A** **A** **SHIFT** **"** **ENTER**)

When you press the **ENTER** key, tape motion will begin, leaving about an 8-second no-signal blank. (A long pip sounds for a while at the beginning.) After that, the file name and its contents are recorded (with continuous short beep sounds).

- (8) When the recording is complete, the PROMPT symbol (>) will be displayed and the tape recorder will automatically stop. Now you have your program on tape (it still is in the computer also).

When data is to be automatically recorded by program execution (PRINT# statement, not manual operation), set up steps (1) thru (6) before executing the program.

To aid you in locating programs on tapes, use the tape counter on the recorder.

Using the Options

2. Verifying the computer and tape contents

See Tape Notes.

After loading or transferring a program to or from tape, you can verify that the program on tape and program in the computer are identical (and thus be sure that everything is OK before continuing your programming or execution of programs).

- (1) Turn off the REMOTE switch.
- (2) With cassette in the recorder, operate the tape motion controls to position tape at the point just before the appropriate file name to be checked.
- (3) Connect the gray plug to the EARphone and the black plug to the REMote jacks.
- (4) Turn on the REMOTE switch.
- (5) Press the PLAY button of the recorder.
- (6) Input a CLOAD? statement and start execution with **ENTER** key. Do this as follows: Set the computer in the "RUN" or "PRO" mode.

Enter the following keys:—

C **L** **O** **A** **D** **SHIFT** **?** **SHIFT** **"** **A** **A** **SHIFT** **"** **ENTER**

The file name which you used previously.

The computer will automatically search for the specified file name and will compare the contents on tape with the contents in memory.

During the verification, the mark "*" is shown at the rightmost digit of the display. The "*" will disappear when the verification is completed. While a file name is being retrieved, no "*" will be displayed as the verification has not started yet.

(The same occurs when the first program is read without a file name.)

If the programs are verified as being identical, a PROMPT symbol (>) will be displayed on the computer.

If the programs differ, execution will be interrupted and Error code 8 will be displayed. If this occurs, try again.

3. Loading from a magnetic tape

See Tape Notes.

To load, transfer, or read out programs and data from magnetic tape into the computer, use the following procedure.

- (1) Turn off the REMOTE switch.
- (2) Load the tape in the tape recorder. Move the tape to a point just before the portion to be read out.

- (3) Connect the gray plug to the EAR jack on the tape recorder, and the black plug to the REM jack.
In using a tape recorder having no REM terminal, press the PAUSE button to make a temporary stop.

(4) Turn on the REMOTE switch.

(5) Push the PLAY button on the tape recorder (to put unit in playback mode).

Set the VOLUME control to middle or maximum.

If the tape recorder does not function properly when the volume is set to maximum, turn the volume down and try again.

Set Tone to maximum treble.

- (6) Input transfer instructions (CLOAD statement, INPUT# statement), and press **ENTER** key for execution.

Put the computer in the "RUN" mode. Then operate the following keys:

C **L** **O** **A** **D** **SHIFT** **"** file name **SHIFT** **"** **ENTER** .

(To load the contents of the data memory, operate keys as follows:

e.g., **I** **N** **P** **U** **T** **SHIFT** **#** **ENTER** .

e.g., **C** **L** **O** **A** **D** **SHIFT** **"** **A** **A** **SHIFT** **"** **ENTER** .)

The specified file name will be automatically searched for and its contents will be transferred into the computer.

The "*" appears while loading the designated CSAVED program from the tape to the computer's memory.

(The same occurs when the first program is read without a file name.)

The "*" disappears when the load is performed completely.

- (7) When the program has been transferred, the computer will automatically stop the tape motion and display the PROMPT (>) symbol.

To transfer data (INPUT# statement) in the course of a program, set up steps (1) thru (5) prior to executing the program.

Notes:

- If an error occurs (error code "8" is displayed), start over from the beginning.

If the error continues, adjust volume slightly up or down.

- If the error code is not displayed but the tape motion continues (while the computer is displaying the symbol "BUSY"), transfer is not being properly executed.

Press **ON BRK** key ("break") to stop the tape. Repeat steps from the beginning.

- If the error remains or the tape continues to run after several attempts to correct the problem, try cleaning and demagnetizing the recorder's tape head.

Tape Notes

- (1) For any transfer or verification, use the tape recorder that was used for recording. If another tape recorder is used, transfer or verification may not be possible.
- (2) Always use only the highest quality tape for programs and data storage (economy grade audio type tape may not provide the proper characteristics for digital recordings).
- (3) Keep the tape heads and other parts that contact tape clean. Use a cassette cleaner tape for this purpose.
- (4) Volume setting – Set to middle or maximum level
Volume level can be very important when reading in data from the recorder; make slight adjustments as required to obtain error-free data transfer. A slight adjustment either up or down may help produce perfect results every time.
- (5) Be sure all connections between the computer and cassette interface are secure. And be sure the connections between interface and recorder are secure and free of foreign matter.
- (6) If problems occur when using AC power for the **CE-126P** and/or the recorder, use battery power instead (sometimes the AC power connection adds some “hum” to the signal which may upset proper digital recording).
 - To connect the AC adaptor to the **CE-126P**, turn the **CE-126P** power off and then connect the adaptor to the **CE-126P**.
- (7) Tone control – Set to maximum treble.
- (8) When recording programs or data on used tape, erase some beginning portion of the used tape before writing and then execute the BASIC command for recording. (Make sure that the previous program is completely erased without any portion remaining.)

CHAPTER 8

BASIC REFERENCE

This chapter is divided into three sections:

- Commands:** Instructions which are used outside a program to change the working environment, perform utilities, or control programs
- Verbs:** Action words used in programs to construct BASIC statements
- Functions:** Special operators used in BASIC programs to change one variable to another

Commands and verbs are arranged alphabetically within each category in the respective sections. Each entry is on a separate page for easy reference. Functions are grouped into three categories and arranged alphabetically within each category. The contents of each section are listed on the following three pages so that you can quickly identify the category to which an operator belongs.

Commands

Program Control

CONT
DELETE
GOTO*
NEW
RENUM
RUN

Cassette Control

CLOAD
CLOAD?
CSAVE
INPUT#*
MERGE
PRINT#*

Debugging

LIST
LLIST
TROFF*
TRON*

Variables Control

CLEAR*
DIM*
MEM*

Angle Mode Control

DEGREE*
GRAD*
RADIAN*

Others

BEEP*
MDF*
PASS
RANDOM*
USING*
WAIT*

* These commands are also BASIC verbs. Their effect as commands is identical to their effect as verbs so they are not described in the Commands section. See the Verbs section for more information.

VerbsControl and Branching

CHAIN
 END
 FOR...TO...STEP
 GOSUB
 GOTO
 IF...THEN
 NEXT
 ON...GOSUB
 ON...GOTO
 RETURN
 STOP

Others

BEEP
 DEGREE
 GRAD
 MDF
 RADIAN
 RANDOM
 REM
 TROFF
 TRON

Assignment and Declaration

CLEAR
 DIM
 LET

Input and Output

AREAD
 CSAVE
 DATA
 INPUT
 INPUT#
 LPRINT
 PAUSE
 PRINT
 PRINT#
 READ
 RESTORE
 USING
 WAIT

Functions

Pseudovariables

INKEY\$
MEM
PI

String Functions

ASC
CHR\$
LEFT\$
LEN
MID\$
RIGHT\$
STR\$
VAL

Numeric Functions

ABS
ACS
AHC
AHS
AHT
ASN
ATN
COS
CUR
DEG
DMS
EXP
FACT
HCS
HSN
HTN
INT
LN
LOG
POL
RCP
REC
RND
ROT
SGN
SIN
SQR
SQU
TAN
TEN

COMMANDS

1 CLOAD

2 CLOAD "filename"

Abbreviations: CLO., CLOA.

See also: CLOAD?, CSAVE, MERGE, PASS

Purpose

The CLOAD command is used to load a program saved on cassette tape.

Use

The first format of the CLOAD command clears existing programs in memory and loads the first program stored on the tape, starting at the current position.

The second format of the CLOAD command clears the memory, searches the tape for the program whose name is given by "filename", and loads the program.

If the computer is in PROgram or RUN mode, program memory is loaded from the tape.

Examples

CLOAD

Loads the first program from the tape.

CLOAD "PRO3"

Searches the tape for the program named 'PRO3' and loads it.

- Notes:**
1. If the designated file name cannot be retrieved before the tape reaches the end, the computer will continue to search the file name. In this case, stop the retrieval function by pressing the **OH** **BRK** key. This applies to MERGE, CHAIN, CLOAD? and INPUT# commands to be described later.
 2. If an error occurs during execution of CLOAD or CHAIN command (described later), the program stored in the computer will be invalid.

- During the loading, an asterisk "*" is shown at the far right digit position of display. The "*" will disappear when the loading is completed. While a file name is being retrieved, no "*" will be displayed as the loading has not started yet. (The same occurs when the first program is read without a file name.)

1 CONT

Abbreviations: C., CO., CON.

See also: RUN, STOP verb

Purpose

The CONT command is used to continue a program which has been temporarily halted.

Use

When the STOP verb is used to halt a program during execution, the program can be continued by entering CONT in response to the prompt.

When a program is halted using the **BRK** key, the program can be continued by entering CONT in response to the prompt.

CONT also functions when the program is temporarily interrupted due to a command such as PRINT.

Examples

CONT Continues an interrupted program execution.

- 1 CSAVE
- 2 CSAVE "filename"
- 3 CSAVE, "password"
- 4 CSAVE "filename", "password"

Abbreviations: CS., CSA., CSAV.

See also: CLOAD, CLOAD?, MERGE, PASS.

Purpose

The CSAVE command is used to save a program to cassette tape.

Use

The first format of the CSAVE command writes all of the programs in memory onto the cassette tape without a specified file name.

The second format of the CSAVE command writes all of the programs in memory onto the cassette tape and assigns the indicated file name.

The third format of the CSAVE command writes all of the programs in memory onto the cassette tape without a specified file name and assigns the indicated password. Programs saved with a password may be loaded by anyone, but only someone who knows the password can list or modify the programs. (See discussion under PASS command.)

The fourth format of the CSAVE command writes all of the programs in memory onto the cassette tape and assigns them the indicated file name and password.

Examples

CSAVE "PRO3", "SECRET" Saves the programs now in memory onto the tape under the name 'PRO3', protected with the password 'SECRET'.

1 **DELETE** [starting line number][,[ending line number]]

Abbreviations: DEL., DELE., DELET.

See also: NEW, PASS

Purpose

The DELETE command is used to delete a program line or program lines. This command is effective for manual operation in the PROgram mode.

Use

If both the starting and ending line numbers are specified, all the program lines between the two numbers inclusive are deleted. If either of the two specified line numbers is not found, an error occurs.

If only the starting line number is specified, that line number alone is deleted.

If the starting line number and comma (,) are specified, the starting line number and all the subsequent line numbers are deleted.

If the comma (,) and ending line number are specified, all the lines from the beginning of the program to the ending line number are deleted.

If both the starting and ending line numbers are omitted, an error occurs.

When the DELETE command is executed while a program file is being read based on the MERGE command, the DELETE command works on the program last read.

The DELETE command is ignored when any password is set in the program.

Example

DELETE 100, Deletes line 100 and all the subsequent line numbers.

Commands
GOTO

1 **GOTO** expression

Abbreviations: G., GO., GOT.

See also: RUN

Purpose

The GOTO command is used to start the execution of a program.

Use

The GOTO command can be used in place of the RUN command to start program execution at the line number specified by the expression.

GOTO differs from RUN in five respects:

- 1) The value of the interval for WAIT is not reset.
- 2) The display format established by USING statements is not cleared.
- 3) Variables and arrays are preserved.
- 4) PRINT=LPRINT status is not reset.
- 5) The pointer for READ is not reset.

Execution of a program with GOTO is identical to execution with the **DEF** key.

Examples

GOTO 100 Begins program execution at line 100.

1 LIST

2 LIST line number

3 LIST "label"

Abbreviations: L., LI., LIS.

See also: LLIST

Purpose

The LIST command is used to display a program.

Use

The LIST command may only be used in the PROgram mode.

- * With format 1, the program is displayed from its first line until the display is full.
- * With format 2, the program is displayed from the line of the specified line number until the display is full.

If the line for the specified number does not exist, the program will be displayed from the line with the next largest number which does exist.

- * With format 3, the program is displayed from the line written with the specified label until the display is full.
- * When programs are merged with the MERGE command, the LIST command functions for the last program.

However, if the label specified in format 3 does not exist in the last program, it is searched for in sequence from the first program. If the specified label is found, the line containing it is displayed.

- * If a password has been set, the LIST command is ignored.

Examples

LIST 100 Displays line number 100.

Commands

LLIST

- 1 **LLIST**
- 2 **LLIST** expression
- 3 **LLIST** expression 1, expression 2
- 4 **LLIST** expression,
- 5 **LLIST**, expression

Abbreviations: LL., LLI., LLIS.

See also: LIST

Purpose

The LLIST command is used for printing a program on the optional printer.

Use

The LLIST command may be used in the PROgram or RUN mode.

The first format prints all of the programs in memory.

The second format prints only the program line whose line number is given by the expression.

The third format prints the statements from the line number with the nearest line equal to or greater than the value of expression 1 to the nearest line equal to or greater than the value of expression 2. There must be at least two lines between the two numbers.

The fourth format prints all program lines beginning with the line whose number is given by the expression.

The fifth format prints all program lines up to, and including, the line whose number is given by the expression.

* When programs are merged with the MERGE command, the LLIST command functions for the last program. To list a program stored earlier, execute:

```
LLIST "label",
```

If a password has been set, the LLIST command is ignored.

Example

LLIST 100,200 Lists the statements between line numbers 100 and 200.

1 MERGE
 2 MERGE "filename"
 (effective for the manual operation in the PROgram or RUN mode)
 Abbreviations: MER., MERG.
 See also: CLOAD

Purpose

The MERGE command is used to load a program saved on cassette tape and merge it with the program existing in memory.

Use

The MERGE command retains the program already stored in the **COMPUTER** and then loads a program recorded on the tape. Therefore, several different programs can be stored in the **COMPUTER** at the same time.

Example

When programs with file names PRO-1, PRO-2, and PRO-3 are to be stored, PRO-1 is stored using the CLOAD command, whereas PRO-2 and PRO-3 are transferred to the computer using the MERGE command. The state of the storage is as follows.

(Tape)

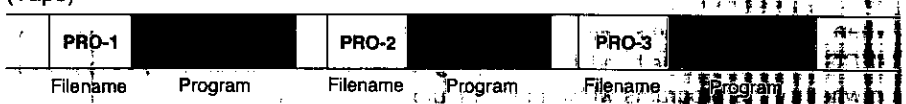

CLOAD "PRO-1"

ENTER

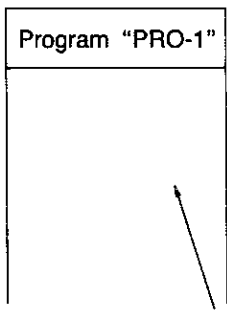

MERGE "PRO-2"

ENTER

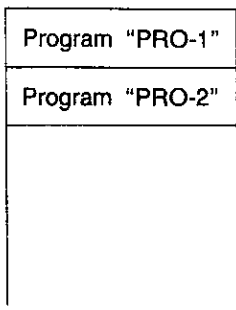

MERGE "PRO-3"

ENTER

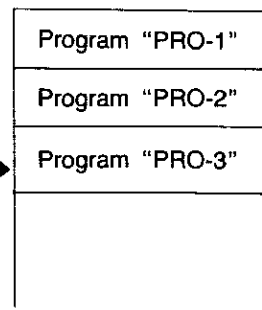

Transfer the first program to the computer using the CLOAD command.

Commands

MERGE

Programs loaded using the MERGE command are stored as in the example. The programs are handled by their line numbers as follows.

- If the first line number of the program loaded using the MERGE command is larger than the last line number of the previously loaded program, the two programs are considered to be a single program.
- If the first line number of the program loaded using the MERGE command is smaller than the last line number of the previously loaded program, the two programs are considered separate.

In the example above, where the line numbers for programs PRO-1, PRO-2, and PRO-3 are 10 to 200, 50 to 150, and 160 to 300, respectively, PRO-1 and PRO-2 are considered separate. PRO-2 and PRO-3 are considered to be a single program with line numbers 50 to 300.

- * Loading programs with the MERGE command may result in two or more programs in the computer with the same line numbers. In this case, the executed RUN or GOTO (RUN expression, GOTO expression) is valid only for the last merged program. There will be no way to execute the preceding program(s).

Therefore, put a label to the beginning of a program to be executed and execute the program using a DEF (defined) key.

Note, however, that only the last merged program can be edited after the MERGE command has been executed and that the program(s) loaded earlier cannot be edited. Therefore, add the label to the program before merging the next program.

Merging password-protected programs

When loading programs with passwords (password-protected programs) using the MERGE command, the handling of the programs differs as outlined below, depending on whether the programs within the computer are protected.

When protected

Password-protected programs cannot be loaded.

When not protected

If password-protected programs are loaded using the MERGE command, all programs within the computer become protected.

When the programs within the computer are protected, even programs without passwords become password-protected when loaded using the MERGE command.

Executing merged programs

"A"	PRO-1
"B"	PRO-2
"C"	PRO-3

The figure shows the memory when PRO-1 is loaded after which PRO-2 and PRO-3 are loaded using the MERGE command. If a program is started using RUN or GOTO (RUN expression or GOTO expression), PRO-3 will be executed. On the other hand, if started using RUN "label", GOTO "label", or a DEF (defined) key, the specified label is searched for from the beginning of PRO-3 within the computer.

If not found in PRO-3, the search proceeds in PRO-1. If also not found in PRO-1, PRO-2 is searched. If the label is found, the program is executed from the labeled line.

Note that since the label is searched for in this manner, if a label used in PRO-1 and PRO-2 is also used in PRO-3, PRO-1 and PRO-2 cannot be executed.

Commands

NEW

1 NEW

Abbreviations: none

See also: CLEAR, PASS

Purpose

The NEW command is used to clear existing programs and data in memory.

Use

When used in the PROgram mode, the NEW command clears all programs and data (array variables, simple variables, and fixed variables) which are currently in memory. (The programs with passwords cannot be cleared.)

The NEW command is not defined in the RUN mode and will result in an ERROR 9.

Examples

NEW Clears programs and data in memory.

1 PASS "character string"

Abbreviations: PA., PAS.

See also: CLOAD, CSAVE, DELETE, NEW, RENUM

Purpose

The PASS command is used to set and cancel passwords.

Use

Passwords are used to protect programs from inspection or modification by other users. A password consists of a character string no more than seven characters long. The seven characters may be alphabetic or one of the following special symbols:

! # \$ % & () * + - / , . : ; < = > ? @ $\sqrt{\quad}$ π \wedge

Note: Do not use any BASIC command or verb as a password.

Once a PASS command has been given, the programs in memory are protected. A password-protected program cannot be examined or modified in memory. It cannot be sent to tape or listed with LIST or LLIST, nor is it possible to add or delete program lines. If several programs are in memory and PASS is entered, all programs in memory are protected. The only way to remove this protection is to execute another PASS command with the same password.

Note: When a password with more than seven characters is declared, only the first seven characters are valid and are set or removed from protection.

Press **ENTER** right after the password.

Writing characters or symbols after a password results in an error and the password cannot be canceled.

(example) PASS"ABCDEFGH":A=123 **ENTER** → Error 1

Examples

PASS "SECRET" Establishes the password 'SECRET' for all programs in memory.

Commands

RENUM

1 **RENUM** [new line number][,[old line number][,increment]]

Abbreviations: REN., RENU.

Purpose

The RENUM command is used to renumber program lines. This command is effective for manual operation in the PRO (Program) mode.

Use

This command renumbers old line numbers in the specified step increments, starting from the specified new line number.

If the values of new line number and increment are omitted, 10 is assumed for both. If old line number is omitted, renumbering starts from the first line of the program. If the specified old line number is not found, an error occurs.

Example 1: RENUM

Renumbers all the program lines in increments of 10 steps from line 10.

Example 2: RENUM 100, 50, 10

Changes old line number 50 to new line number 100 and renumbers subsequent line numbers in increments of 10 steps.

The RENUM command automatically changes all line number references following GOTO, GOSUB, IF~THEN, ON~GOTO, ON~GOSUB, RESTORE, etc., to reflect the new line numbers. In this case, however, an error will result if expression (e.g., GOTO 2*50). If an error occurs due to such incorrect line number reference, renumbering of the incorrect line number cannot be effected by RENUM. In such a case, temporarily rewrite the command containing an incorrect line number to a REM statement, and correct it (perhaps, change to ON~GOTO) after the execution of the RENUM command.

The RENUM command cannot be executed if the number of lines to be renumbered exceeds 65279, or if the specification requires a change in the execution order of program lines (for example, an attempt is made to execute RENUM 15, 30 when three program lines 10, 20, and 30 exist).

It will take a little while to complete the execution of RENUM on a large program. If you press the **BRK** key to interrupt the program while one asterisk (*) is appearing at the rightmost end of the display, the program will return to the original condition before the execution of RENUM. However, this interruption by the **BRK** key will be ignored when two asterisks (***) are on the display.

The work area of "number of program lines \times 4 bytes" is used only when the RENUM command is executed. By renumbering program lines, line number references by GOTO, GOSUB, etc., also change. As a result, the original program may have an increase in the number of bytes used. In other words, new line GOTO 200 uses one byte more than old line GOTO 20. The RENUM command cannot be executed if the remaining capacity of the work area becomes short due to the increase in the number of bytes used. In such a case, clear variables from memory by the CLEAR command and you may be able to execute RENUM.

(See APPENDIX A for error messages related to RENUM.)

Commands

RUN

1 **RUN**

2 **RUN** line number

Abbreviations: R., RU.

See also: GOTO, MERGE

Purpose

The RUN command is used to execute a program in memory.

Use

The first format of the RUN command executes a program beginning with the lowest numbered statement in memory.

The second format of the RUN command executes a program beginning with the specified line number.

* When programs are merged with the MERGE command, the last merged program will be executed with format 1 or "RUN expression" in format 2.

RUN differs from GOTO in five respects:

- 1) The value of the interval for WAIT is reset.
- 2) The display format established by USING statements is cleared.
- 3) Variables and arrays other than the fixed variables are cleared.
- 4) PRINT=PRINT status is set.
- 5) The pointer for READ is reset to the beginning DATA statement.

Execution of a program with GOTO is identical to execution with the DEF key. In all three forms of program execution, FOR/NEXT and GOSUB nesting is cleared.

Examples

RUN 100 Executes the program which begins at line number 100.

Verbs

1 **AREAD** variable name

Abbreviations: A., AR., ARE., AREA.

See also: INPUT verb and discussion of the use of the DEF key in Chapter 6

Purpose

The AREAD verb is used to read in a single value to a program which is started using the **DEF** key.

Use

When a program is labeled with a letter so that it can be started using the **DEF** key, the AREAD verb can be used to enter a single starting value without the use of the INPUT verb. The AREAD verb must appear on the first line of the program following the label. If it appears elsewhere in the program, it will be ignored. Either a numeric or string variable may be used, but only one can be used per program.

To use the AREAD verb, type the desired value in the RUN mode, press the **DEF** key, followed by the letter which identifies the program. If a string variable is being used, it is not necessary to enclose the entered string in quotes.

Examples

```
10 "X": AREAD N
20 PRINT N^2
30 END
```

Entering "7 **DEF** X" will produce a display of "49".

Notes: 1. When the display indicates PROMPT (">") at the start of program execution, the designated variable is cleared.

2. When the contents are displayed by PRINT verb at the start of program execution, the following is stored:

Example: When the program below is executed;

```
10 "A": PRINT "ABC", "DEFG"  
20 "S": AREAD A$: PRINT A$  
RUN mode  
DEF A → ABC      DEFG  
DEF S → DEFG
```

- When the display indicates PRINT Numeric expression, Numeric expression, or PRINT "String", "String", the contents displayed last are stored.
- When the display indicates PRINT Numeric expression; Numeric expression; Numeric expression..., the contents displayed first (on the extreme left) are stored.
- When the display indicates PRINT "String"; "String"; "String"..., the contents of the "String" designated last (on the extreme right) are stored.

1 BEEP expression

Abbreviations: B., BE., BEE.

Purpose

The BEEP verb is used to produce an audible tone.

Use

The BEEP verb causes the **COMPUTER** to emit one or more audible tones at 4 kHz. The number of beeps is determined by the expression, which must be numeric (positive number less than 9.999999999E+99). The expression is evaluated, but only the integer part is used to determine the number of beeps.

BEEP may also be used as a command using numeric literals and predefined variables. In this case, beeps occur immediately after the **ENTER** key is pressed.

Examples

1Ø A=5 B\$="9"

2Ø BEEP 3

Produces 3 beeps.

3Ø BEEP A

Produces 5 beeps.

4Ø BEEP(A+4)/2

Produces 4 beeps.

5Ø BEEP B\$

This is illegal and will produce an ERROR 9 message.

6Ø BEEP -4

Produces no beeps, but does not produce an error message.

For example, let's assume you have three program sections named PRO-1, PRO-2, PRO-3. Each of these sections ends with a CHAIN statement.

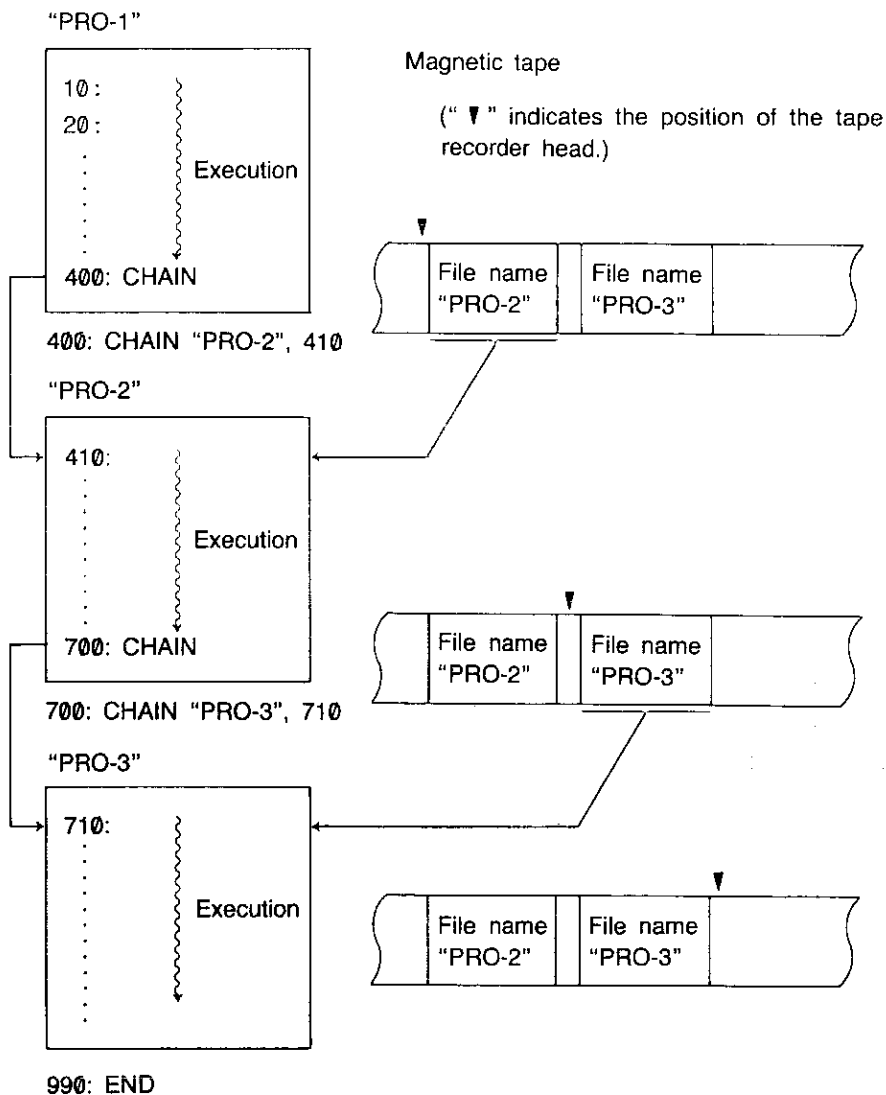

During execution, when the computer encounters the CHAIN statement, the next section is called into memory and executed. In this manner, all of the sections are eventually run.

Note: When a program containing a CHAIN command is loaded from a tape by the MERGE command, check to be sure that the CHAIN command is correct.

Verbs
CLEAR

1 CLEAR

Abbreviations: CL., CLE., CLEA.

See also: DIM

Purpose

The CLEAR verb is used to erase all variables which have been used in the program and to reset all preallocated variables to zero or null.

Use

The CLEAR verb recovers space which is being used to store variables. This might be done when the variables used in the first part of a program are not required in the second part and available space is limited. CLEAR may also be used at the beginning of a program when several programs are resident in memory and you want to clear out the space used by execution of prior programs.

CLEAR does not free the space used by the variable A-Z, A\$-Z\$, or A(1)-A(26) (without DIM declaration) since they are permanently assigned (see Chapter 4). CLEAR does reset numeric variables to zero and string variables to null.

Examples

10 A=5: DIM C(5)

20 CLEAR Frees the space assigned to C() and resets A to zero.

1 DATA expression list

Where: expression list is: expression

or: expression, expression list

Abbreviations: DA., DAT.

See also: READ, RESTORE

Purpose

The DATA verb is used to provide values for use by the READ verb.

Use

When assigning initial values to an array, it is convenient to list the values in a DATA statement and use a READ statement in a FOR...NEXT loop to load the values into the array. When the first READ is executed, the first value in the first DATA statement is returned. Succeeding READs use succeeding values in the sequential order in which they appear in the program, regardless of how many values are listed in each DATA statement or how many DATA statements are used.

DATA statements have no effect if encountered in the course of regular execution of the program, so they can be inserted wherever it seems appropriate. Many programmers like to include them immediately following the READ which uses them. If desired, the values in a DATA statement can be read a second time by using the RESTORE statement.

Examples

10 DIM B(10)

Sets up an array.

20 WAIT 128

30 FOR I=1 TO 10

40 READ B(I)

Loads the values from the DATA statement into B(). B(1) will be 10, B(2) will be 20, B(3) will be 30, etc.

50 PRINT B(I)

60 NEXT I

70 DATA 10,20,30,40,50,60

80 DATA 70,80,90,100

90 END

Verbs
DEGREE

1 DEGREE

Abbreviations: DE., DEG., DEGR., DEGRE.

See also: GRAD and RADIAN

Purpose

The DEGREE verb is used to specify the unit of angle to decimal degrees.

Use

The **COMPUTER** has three forms for representing values in angular units—decimal degrees, radians, and grads. These forms are used in specifying the arguments to the SIN, COS, and TAN functions and in returning the results from the ASN, ACS, and ATN functions.

The DEGREE function changes the unit of angle for all values to decimal degrees until a GRAD or RADIAN verb is used. The DMS and DEG functions can be used to convert values in decimal degrees into sexagesimal equivalent (degrees, minutes, seconds) and vice versa.

Examples

10 DEGREE

20 X=ASN 1 X now has a value of 90, i.e., 90 degrees, the arc sine of 1.

30 PRINT X

1 DIM dim list

Where: dim list	is: dimension spec. or: dimension spec., dim list
and: dimension spec.	is: numeric dim spec. or: string dim spec.
and: numeric dim spec	is: numeric name (size)
and: string dim spec	is: string name (dims) or: string name (dims)*len
and: numeric name	is: valid numeric variable name
and: string name	is: valid string variable name
and: dims	is: size or: size, size
and: size	is: number of elements
and: len	is: length of each string in a string array

Abbreviations: D., DI.

Purpose

The DIM is used to reserve space for numeric and string array variables.

Use

Except for arrays in the form: A(), A\$(), and simple variable like A1 or B2\$, a DIM verb must be used to reserve space for any array variable.

The maximum number of dimensions in any array is two; the maximum size of any one dimension is 255. In addition to the number of elements specified in the dimension statement, one additional "zeroth" element is reserved. For example, DIM B(3) reserves B(0), B(1), B(2), and B(3). In two dimensional arrays there is an extra "zeroth" row and column.

In string arrays, one specifies the size of each string element in addition to the number of elements. For example, DIM B\$(3)*12 reserves space for 4 strings which are each a maximum of 12 characters long. If the length is not specified, each string can contain a maximum of 16 characters.

When a numeric array is dimensioned, all values are initially set to zero; in a string array, the values are set to null.

For the array A and A\$ DIM declaration, refer to the paragraph discussing variables.

Verbs

DIM

Array variables can be cleared (or set undefined) with the CLEAR command. When the program is started using the RUN command, array variables are automatically cleared.

The variable name once declared cannot be declared again. When a program once executed is executed again with the GOTO command on using the **DEF** key, the same variable name as formerly declared will be declared again if the line with the DIM command is executed. In this case, clear the array variable with the CLEAR command and then declare it again.

Examples

1Ø DIM B(1Ø)

Reserves space for a numeric array with 11 elements.

2Ø DIM C\$(4, 4)*1ØØ

Reserves space for a two dimensional string array with 5 rows and 5 columns; each string will be a maximum of 10 characters.

1 END

Abbreviations: E., EN.

Purpose

The END verb is used to signal the end of a program.

Use

When multiple programs are loaded into memory at the same time, a mark must be included to indicate where each program ends so that execution does not continue from one program to another. This is done by including an END verb as the last statement in the program.

Examples

```
10 PRINT "HELLO"  
20 END  
30 PRINT "GOODBYE"  
40 END
```

With these programs in memory a 'RUN 10' prints 'HELLO', but not 'GOODBYE'. 'RUN 30' prints 'GOODBYE'.

Verbs FOR...TO

1 **FOR** numeric variable=expression 1 **TO** expression 2
2 **FOR** numeric variable=expression 1 **TO** expression 2
 STEP expression 3

Abbreviations: F. and FO.; STE.

See also: NEXT

Purpose

The FOR verb is used in combination with the NEXT verb to repeat a series of operations a specified number of times.

Use

The FOR and NEXT verbs are used in pairs to enclose a group of statements which are to be repeated. The first time this group of statements is executed, the loop variable (the variable named immediately following the FOR) has the value of expression 1.

When execution reaches the NEXT verb, the loop variable is increased by the step size and then this value is tested against expression 2. If the value of the loop variable is less than or equal to expression 2, the enclosed group of statements is executed again, starting with the statement following the FOR. In the first form, the step size is 1; in the second form, the step size is given by expression 3. If the value of the loop variable is greater than expression 2, execution continues with the statement which immediately follows the NEXT. Because the comparison is made at the end, the statements within a FOR/NEXT pair are always executed at least once.

Expression 1, expression 2, and expression 3 must be in the range of $-9.999999999E99$ to $9.999999999E99$. If the value of expression 3 is zero, FOR/NEXT loop will be infinite.

The loop variable may be used within the group of statements, for example, as an index to an array, but care should be taken in changing the value of the loop variable.

Programs should be written so that they never jump from outside a FOR/NEXT pair to a statement within a FOR/NEXT pair. Similarly, programs must never leave a FOR/NEXT pair by jumping out. Always exit a FOR/NEXT loop via the NEXT statement. To do this, set the loop variable to a value higher than expression 2.

The group of statements enclosed by a FOR/NEXT pair can include another pair of FOR/NEXT statements which use a different loop variable as long as the enclosed pair is completely enclosed; i.e., if a FOR statement is included in the group, the matching NEXT must also be included. FOR/NEXT pairs may be "nested" up to five levels deep.

Examples

```
10 FOR I=1 TO 5
20 PRINT I
30 NEXT I
```



This group of statements prints the numbers 1, 2, 3, 4, 5.

```
40 FOR N=10 TO 0 STEP -1
50 PRINT N
60 NEXT N
```



This group of statements counts down 10, 9, 8, 7, 6, 5, 4, 3, 2, 1, 0.

```
70 FOR N=1 TO 10
80 X=1
90 FOR F=1 TO N
100 X=X*F
110 NEXT F
120 PRINT X
130 NEXT N
```



This group of statements computes and prints N factorial for the numbers from 1 to 10.

Note: The execution of the FOR-NEXT loop does to the end even if it jumps out of the loop. Therefore, note that a nesting error of the FOR-NEXT loop (ERROR 5) may result depending on the program (programs which execute the FOR command a number of times).

1 GOSUB expression

Abbreviations: GOS., GOSU.

See also: GOTO, ON..GOSUB, ON...GOTO, RETURN

Purpose

The GOSUB verb is used to execute a BASIC subroutine.

Use

When you wish to execute the same group of statements several times in the course of a program or use a previously written set of statements in several programs, it is convenient to use the BASIC capability for subroutines using the GOSUB and RETURN verbs.

The group of statements is included in the program at some location where they are not reached in the normal sequence of execution. A frequent location is after the END statement which marks the end of the main program. At those locations in the main body of the program—where subroutines are to be executed—include a GOSUB statement with an expression which indicates the starting line number of the subroutine. The last line of the subroutine must be a RETURN. When GOSUB is executed, the **COMPUTER** transfers control to the indicated line number and processes the statements until a RETURN is reached. Control is then transferred back to the statement following the GOSUB.

A subroutine may include a GOSUB. Subroutines may be “nested” in this fashion up to 10 levels deep.

The expression in a GOSUB statement may not include a comma, e.g., ‘A(1, 2)’ cannot be used. Since there is an ON...GOSUB structure for choosing different subroutines at given locations in the program, the expression usually consists of just the desired line number. When a numeric expression is used, it must evaluate to a valid line number, i.e., 1 to 65279, or an ERROR 4 will occur.

Example

```
10 GOSUB 100
```

```
20 END
```

```
100 PRINT "HELLO"
```

```
110 RETURN
```

When this program is run it prints the word ‘HELLO’ one time.

1 **GOTO** expression

Abbreviations: G., GO., GOT.

See also: GOSUB, ON...GOSUB, ON...GOTO

Purpose

The GOTO verb is used to transfer control to a specified line number.

Use

The GOTO verb transfers control from one location in a BASIC program to another location. Unlike the GOSUB verb, GOTO does not "remember" the location from which the transfer occurred.

The expression in a GOTO statement may not include a comma, e.g., 'A(1,2)' cannot be used. Since there is an ON...GOTO structure for choosing different destinations at given locations in the program, the expression usually consists of just the desired line number, i.e., 1 to 65279, or an ERROR 4 will occur.

Well designed programs usually flow simply from beginning to end, except for subroutines executed during the program. Therefore, the principal use of the GOTO verb is as a part of an IF...THEN statement.

Examples

```
10 INPUT A$.
20 IF A$="Y" THEN GOTO 50
30 PRINT "NO"
40 GOTO 60
50 PRINT "YES"
60 END
```

This program prints 'YES' if a 'Y' is entered and prints 'NO' if anything else is entered.

1 GRAD

Abbreviations: GR., GRA.

See also: DEGREE and RADIAN

Purpose

The GRAD verb is used to specify the unit of angle to grads.

Use

The **COMPUTER** has three forms for representing values in angular units—decimal degrees, radians, and grads. These forms are used in specifying the arguments to the SIN, COS, and TAN functions and in returning the results from the ASN, ACS, and ATN functions.

The GRAD function changes the unit of angle for all values to grads until a DEGREE or RADIAN verb is used. Grad represents an angular measurement in terms of percent gradient, i.e., a 45° angle is a 50^g gradient.

Examples

To solve for the values of a sine, in the respective angular units, first specify "D" for degrees, "R" for radians, or "G" for grads and then enter the angle of the sine.

```
10 INPUT "DEG=D, RAD=R, GRAD=G?" ;A$
20 IF A$="D" THEN 100
30 IF A$="R" THEN 200
40 GRAD :GOSUB 300:GOTO 40
100 DEGREE :GOSUB 300:GOTO 100
200 RADIAN :GOSUB 300:GOTO 200
300 INPUT "SIN ?";B
310 PRINT "SIN" ;B;"=";SIN B
320 RETURN
```

1 IF condition **THEN** statement

2 IF condition statement

Abbreviations: none for IF; T, TH., THE.

Purpose

The IF...THEN verb pair is used to execute or not to execute a statement depending on conditions at the time the program is run.

Use

In the normal running of BASIC programs, statements are executed in the sequence in which they occur. The IF...THEN verb pair allows decisions to be made during execution so that a given statement is executed only when desired. When the condition part of the IF statement is true, the statement is executed; when it is false, the statement is skipped.

The condition part of the IF statement can be any relational expression as described in Chapter 4. It is also possible to use a numeric expression as a condition, although the intent of the statement will be less clear. Any expression which evaluates to zero or a negative number is considered false; any which evaluates to a positive number is considered true.

The statement which follows the THEN may be any BASIC statement, including another IF...THEN. If it is a LET statement, the LET verb itself must appear.

The two formats of the IF statement are identical in action, but the first format is clear.

Examples

```

10 INPUT "CONTINUE?"; A$
20 IF A$="YES" THEN GOTO 10
30 IF A$="NO" THEN GOTO 60
40 PRINT "YES OR NO, PLEASE"
50 END

```

This program continues to ask 'CONTINUE?' as long as 'YES' is entered; it stops if 'NO' is entered, and complains otherwise.

Verbs INPUT

1 **INPUT** input list

Where: input list

is: input group

or: input group, input list

and: input group

is: var list

or: prompt, var list

and: var list

or: prompt, var list

is: variable

or: variable, var list

and: prompt

is: any string constant

Abbreviations: I., IN., INP., INPU.

See also: INPUT#, READ, PRINT

Purpose

The INPUT verb is used to enter one or more values from the keyboard.

Use

When you want to enter different values each time a program is run, use the INPUT verb to enter these values from the keyboard.

In its simplest form the INPUT statement does not include a prompt string; instead a question mark is displayed at the left edge of the display. A value is then entered, followed by the **ENTER** key. This value is assigned to the first variable in the list. If other variables are included in the same INPUT statement, this process is repeated until the list is exhausted.

If a prompt is included in the INPUT statement, the process is exactly the same except that, instead of the question mark, the prompt string is displayed at the left edge of the display. If the prompt string is followed by a semicolon, the cursor is positioned immediately after the prompt. If the prompt is followed by a comma, the prompt is displayed. Then when a key is pressed, the display is cleared and the first character of the input is displayed at the left edge.

When a prompt is specified and there is more than one variable in the list following it, the second and succeeding variables are prompted with the question mark. If a second prompt is included in the list, it is displayed for the variable which immediately follows it.

If the **ENTER** key is pressed and no input is provided, the variable retains the value it had before the INPUT statement.

Examples

- 1Ø INPUT A
Clears the display and puts a question mark at the left edge.
- 2Ø INPUT "A=";A
Displays 'A=' and waits for input data.
- 3Ø INPUT "A=",A
Displays 'A='.
When data is input, 'A=' disappears and the data is displayed starting at the left edge.
- 4Ø INPUT "X=?";X,"Y=?";Y
Displays 'X=?' and waits for first input.
After **ENTER** is pressed, display is cleared and 'Y=?' is displayed at the left edge.

Note: Clear the error during input for the INPUT command by pressing the **C-CE** key and then input the correct data.

Verbs INPUT

1 INPUT # var list

2 INPUT # "filename"; var list

Where: var list is: variable
 or: variable, var list

Abbreviations: I. #, IN. #, INP. #, INPU. #

See also: INPUT, PRINT #, READ

Purpose

The INPUT # verb is used to enter values from the cassette tape.

Use and Examples

The following variable types can be specified in the INPUT # statement:

- (1) Fixed variables—A, B, C, A(7), D*, A(20)*, etc.
- (2) Simple variables—AA, B3, CP\$, etc.
- (3) Array variables—S(*), HP(*), K\$(*), etc.

1) Transferring data to fixed variables

To transfer data from tape to fixed variables, specify the variable names in the INPUT # statement.

```
INPUT # "DATA 1" ; A, B, X, Y
```

This statement transfers data from the cassette file named "DATA1" to the variables A, B, X, and Y in that order.

To fill all the available fixed variables and, if defined, the extended variables (A(27) and beyond) with data transferred from tape, specify the first variable with an asterisk (*) subscripted to it.

```
INPUT # "D-2"; D*
```

This statement transfers the contents of the tape file "D-2" to variables D through Z and to A(27) and beyond.

```
INPUT # A(10)* (without DIM declaration)
```

This statement transfers the data of the first file found after the tape was started, to the variables A(10) and beyond (to J through Z and A(27) and beyond).

Notes: 1. If an array named A is already defined by the DIM statement, it is not possible to define subscripted fixed variables in the form of A().

2. Data transfer to fixed variables and extended variables (A(27) and beyond) will continue until the end of the source data file on the tape is reached, but if the computer's memory becomes full, an error (ERROR 6) results.

2) Data transfer to simple variables

Data in a tape file can be transferred to simple variables by specifying the desired simple variable names in the INPUT # statement.

```
INPUT # "DM-1"; AB, Y1, XY$
```

This statement transfers data from the tape file named "DM-1" to simple variables AB, Y1, and XY\$.

- Notes:**
1. Numeric data must be transferred to numeric simple variables, and character data must be simple character variables. Cross-transfer is not allowed.
 2. Locations for simple variables must be set aside in the program data area before the INPUT statement is executed. If not, an error will result. Use assignment statements to reserve the locations for simple variables.

AA=0 Use appropriate numeric values or characters in
B1\$="A" assignment statements to reserve locations for
INPUT AA, B1\$ variables.

3) Data transfer to array variables

To transfer data from a tape file to array variables, specify the array name in the INPUT # statement in the form of array name(*).

```
50 DIM B(5)
60 INPUT # "DS-4"; B(*)
```

This statement transfers data from the tape file named "DS-4" to the variables (B(0) through B(5)) in array B.

- Note:**
1. Numeric data must be transferred to numeric array variables with the same length as that of the data, character data must be transferred to character array variables with the same length as that of the data. If this rule is not observed, an error will result.
 2. Locations for array variables must be set aside in the program data area before the INPUT # statement is executed. If not, an error will result. Use the DIM statement to define the array in advance.

—CAUTION—

If the number of variables specified in the INPUT statement does not agree with the amount of data recorded on the tape, the following will happen:

- * If the number of pieces of data recorded on the tape file (to be transferred) is greater than the number of specified variables, data transfer will be performed to the last variable, and the remaining data will be ignored.
- * If the number of pieces of data recorded in the tape file (to be transferred) is smaller than the number of specified variables, all the file data will be transferred to the variables to the end of the file, and the remaining variables will maintain their previous contents. In this case, however, the computer will continue to wait for data transfer from the tape. To halt this state, you should operate the **ON** **BRK** key.
- * If the INPUT statement is executed with no variable name specified in it, an error (ERROR 1) will result.

1 LET variable=expression

2 variable=expression

Abbreviations: LE.

Purpose

The LET verb is used to assign a value to a variable.

Use

The LET verb assigns the value of the expression to the designated variable. The type of the expression must match that of the variable, i.e., only numeric expressions can be assigned to numeric variables and only string expressions can be assigned to string variables. To convert from one type to the other, one of the explicit type conversion functions, STR\$ or VAL, must be used.

The LET verb may be omitted in all LET statements except those which appear in the THEN clause of an IF...THEN statement. In this one case the LET verb must be used.

Examples

10 I=10

Assigns the value '10' to I.

20 A=5*I

Assigns the value '50' to A.

30 X\$=STR\$(A)

Assigns the value '50' to X\$

40 IF I>=10 THEN LET Y\$=X\$+".00"

Assigns the value '50.00' to Y\$.

Verbs
LPRINT

For printer CE-126P

1	LPRINT	{ expression character string }			
2	LPRINT	{ expression character string }	,	{ expression character string }	
3	LPRINT	{ expression character string }	;	{ expression character string }	;...; { expression character string }

Abbreviations: LP., LPR., LPRI., LPRIN.

See also: PRINT, USING

Purpose

The LPRINT verb is used to print information on the printer CE-126P.

Use

In format 1, numerics are right justified and alphabets are printed from the left side of the paper. A line feed command is automatically executed when one line contains more than 24 characters.

In format 2, the 24 columns of one line are divided into two groups of 12 columns, and data is printed symmetrically around the comma.

A numeric value within the 12-column (digit) range is printed at the far right of the display, while a character value (string value) is printed starting at the far left. If the value to be printed exceeds 12 columns, the numeric value is printed with the least significant digit(s) of its decimal fraction part truncated so the value is within 12 digits, and the characters value is printed from the first 12 characters (from the left).

In format 3, the values are printed from the left edge of the paper. If the value to be printed exceeds 24 columns, a new line is automatically performed. Up to a maximum of 96 characters can be printed.

Note: Do not use any BASIC command or verb as a string expression.

Examples

```
10 A=10:B=20:X$="ABCDE":Y$="XYZ"  
20 LPRINT A  
30 LPRINT X$  
40 LPRINT A,B  
50 LPRINT X$;A;B  
60 LPRINT
```

1 **MDF** expression

Abbreviation: MD.

See also: USING

Purpose

The MDF verb is used to round up the value of an expression.

Use

The MDF is a function used to round the value of an expression to the number of decimal places specified by the USING command.

This verb is effective only when the number of decimal places is specified for a value by the USING command.

Example

Display

USING "###.###"

MDF (0.5/9)

0.056

10 USING "###.###"

20 A=MDF (5/9)

30 PRINT A

40 USING

50 PRINT A, 5/9

60 END

RUN **ENTER**

0.556

ENTER

0.556 5.55555E-01

Verbs NEXT

1 **NEXT** numeric variable

Abbreviations: N., NE., NEX.

See also: FOR

Purpose

The **NEXT** verb is used to mark the end of a group of statements which are being repeated in a **FOR/NEXT** loop.

Use

The use of the **NEXT** verb is described under **FOR**. The numeric variable in a **NEXT** statement must match the numeric variable in the corresponding **FOR**.

Examples

```
1Ø FOR I=1 TO 1Ø  
2Ø PRINT I  
3Ø NEXT I
```

Print the numbers from 1 to 10 each time the **ENTER** is pressed.

1 **ON** expression **GOSUB** expression list

Where: expression list is: expression

or: expression, expression list

Abbreviations: O.; GOS., GOSU.

See also: GOSUB, GOTO, ON...GOTO

Purpose

The ON...GOSUB verb is used to execute one of a set of subroutines depending on the value of a control expression.

Use

When the ON...GOSUB verb is executed, the expression between ON and GOSUB is evaluated and reduced to an integer. If the value of the integer is 1, the first subroutine in the list is executed as in a normal GOSUB. If the expression is 2, the second subroutine in the list is executed, and so forth. After the RETURN from the subroutine, execution proceeds with the statement which follows the ON...GOSUB.

If the expression is zero, negative, or larger than the number of subroutines provided in the list, no subroutine is executed and execution proceeds with the next line of the program.

NOTE: Commas cannot be used in the expressions following the GOSUB. The **COMPUTER** cannot distinguish between commas in expressions and commas between expressions.

Examples

```
10 INPUT A
20 ON A GOSUB 100, 200, 300
30 END
100 PRINT "FIRST"
110 RETURN
200 PRINT "SECOND"
210 RETURN
300 PRINT "THIRD"
310 RETURN
```

An input of 1 prints "FIRST"; 2 prints "SECOND"; 3 prints "THIRD".
Any other input does not produce any print.

Verbs ON...GOTO

1 ON expression **GOTO** expression list

Where: expression list is: expression

or: expression, expression list

Abbreviations: O.: G., GO., GOT.

See also: GOSUB, GOTO, ON...GOSUB

Purpose

The ON...GOTO verb is used to transfer control to one of a set of locations depending on the value of a control expression.

Use

When the ON...GOTO verb is executed, the expression between ON and GOTO is evaluated and reduced to an integer. If the value of the integer is 1, control is transferred to the first location in the list. If the expression is 2, control is transferred to the second location in the list, and so forth.

If the expression is zero, negative, or larger than the number of locations provided in the list, execution proceeds with the next line of the program.

NOTE: Commas cannot be used in the expressions following the GOTO. The **COMPUTER** cannot distinguish between commas in expressions and commas between expressions.

Examples

```
10 INPUT A
20 ON A GOTO 100, 200, 300
30 GOTO 900
100 PRINT "FIRST"
110 GOTO 900
200 PRINT "SECOND"
210 GOTO 900
300 PRINT "THIRD"
310 GOTO 900
900 END
```

An input of 1 prints 'FIRST'; 2 prints 'SECOND'; 3 prints 'THIRD'. Any other input does not produce any print.

- 1 **PAUSE** print expr
- 2 **PAUSE** print expr, print expr
- 3 **PAUSE** print expr; print list; ...; print list

Where: print list is: print expr
 or: print expr; print list
 and: print expr is: expression
 or: USING clause; expression

The USING clause is described separately under USING.

Abbreviations: PAU., PAUS.

See also: LPRINT, PRINT, USING, WAIT

Purpose

The PAUSE verb is used to print information on the display for a short period.

Use

The PAUSE verb is used to display prompting information, results of calculations, etc. The operation of PAUSE is identical to PRINT except that after PAUSE the **COM-PUTER** waits for a short preset interval of about 0.85 second and then continues execution of the program without waiting for the **ENTER** key or the WAIT interval.

The first form of the PAUSE statement displays a single value. If the expression is numeric, the value is printed at the far right of the display. If it is a string expression, the display is made starting at the far left.

In format 2, the display unit is divided into groups of 12 columns. The values are displayed, in sequence, from the first specified value.

In this case too, within a range of 12 columns, the numeric value of an expression is displayed from the right end of the display and characters are displayed from the left side.

- The number of the values (items) specified in format 2 must be within 2.
- If the specified value exceeds 12 columns, the following is performed.
 - 1) When the numeric value exceeds 12 digits, the least significant digit(s) is truncated.
 - 2) When the characters exceed 12 columns, only the first 12 characters (from the left) are displayed.

Verbs
PAUSE

In format 3, the specified value is displayed continuously from the left side of the display.

Examples

10 A=10: B=20: X\$="ABCDEF":
Y\$="XYZ"

Display

20 PAUSE A

10.

30 PAUSE X\$

ABCDEF

40 PAUSE X\$,B

ABCDEF 20.

50 PAUSE Y\$;X\$

XYZABCDEF

60 PAUSE A*B

200.

Note: Do not use any BASIC command or verb as a character string in a PAUSE statement.

Verbs
PRINT

In format 3, the specified value is displayed continuously from the left side of the display.

Note: Do not use any BASIC command or verb as a character string in a PRINT statement.

Examples

Display

```
10 A=123:B=456:X$="ABCDEF":  
   Y$="VWXYZ"  
20 PRINT X$,B
```

ABCDEF	456.
--------	------

```
30 PRINT A;B
```

123.456.

```
40 PRINT X$;A
```

ABCDEF123.

```
50 PRINT Y$;B
```

VWXYZ456.

1 PRINT # "var list"
 2 PRINT # "filename" ; var list

Where: var list is: variable
 or: variable, var list

Abbreviations: P. #, PR. #, PRI. #, PRIN. #

See also: INPUT #, PRINT, READ

Purpose

The PRINT # verb is used to store values on the cassette tape.

Use and Examples

The following variable types can be used for variable names:

- (1) Fixed variables—A, B, X, A(26), C*, A(10)*, etc.
- (2) Simple variables—AA, B2, XY\$, etc.
- (3) Array variables—B(*), CD(*), NS(*), etc.

1) Saving fixed variable contents onto tape

The contents of fixed variables can be saved onto tape by specifying the desired variable names (separated by commas) in the PRINT # statement.

```
PRINT # "DATA 1" ; A, B, X, Y
```

This statement saves contents of variables A, B, X, and Y into tape file named "DATA 1".

If you wish to save the contents of the specified fixed variable and all the subsequent fixed variables, subscript that variable name with an asterisk*.

```
PRINT # "D-2"; D*      This statement saves the contents of fixed variables D
                        through Z (and of extended variables A(27) and
                        beyond, if defined) into the tape file named "D-2".
```

```
PRINT E,X$,A(30)*     This statement saves the contents of the fixed variables
                        E and X$ and of the extended variables A(30) and all the
                        remaining variables, onto the tape without file name.
```

Note: Subscripted fixed variable names A(1) through A(26) can be specified in the PRINT # statement in much the same way as A through Z (or A\$ through Z\$). However, if array A is already defined by the DIM statement, A() cannot be used to define subscripted fixed variables.

Verbs
PRINT #

2) Saving simple variable (two-character variable) contents

The contents of simple variables can be saved onto tape by specifying the desired variable names.

PRINT # "DM-1"; AB, Y1, XY\$

This statement saves the contents of the simple variables AB, Y1, and XY\$ into the tape file named 'DM-1'.

3) Saving array variable contents

The contents of all variables of a specific array can be saved onto tape by specifying the array name subscripted by an asterisk enclosed in parentheses (*).

PRINT # "DS-2";X(*),YS(*)

This statement saves the contents of all the elements (X(0),X(1), ...) of the array X, and of all the elements (X\$(0), Y\$(1), ...) of the array Y\$, into the tape file name 'DS-2'.

Note: It is not possible to save the contents of only one specific element of an array. While fixed variables or subscripted fixed variables in the form of A() allow you to save only one specific element of such a variable, an array (such as A), defined by the DIM statement, allows you to save in the same manner as other arrays.

* If the PRINT # statement is executed with no variable names specified, an error (ERROR 1) will result.

–CAUTION–

The locations for extended variables such as A(27) and beyond, simple variables, and/or array variables must be set aside in the program/data area before the PRINT # statement is executed. Otherwise, the execution of the PRINT # statement for undefined variables will result in an error.

1 RADIANT

Abbreviations: RAD., RADI., RADIA.

See also: DEGREE, GRAD

Purpose

The RADIANT verb is used to change the unit of angle to radians.

Use

The **COMPUTER** has three forms for representing values in angular values—decimal degrees, radians, and grads. These forms are used in specifying the arguments to the SIN, COS, and TAN functions and in returning the results from the ASN, ACS, and ATN functions.

The RADIANT function changes the unit of angle for all values to radians until a DEGREE or GRAD verb is used. Radian represents an angular measurement in terms of the length of the arc with respect to a radius, i.e., 360° is 2π radians since the circumference of a circle is 2π times the radius.

Examples

1Ø RADIANT

2Ø X=ASN 1

3Ø PRINT X

X now has a value of 1.570796327 or $\pi/2$, the arc sine of 1.

Verbs
RANDOM

1 RANDOM

Abbreviations: RA., RAN., RAND., RANDO.

Purpose

The RANDOM verb is used to reset the seed for random number generation.

Use

When random numbers are generated using the RND function, the **COMPUTER** begins with a predetermined "seed" or starting number. The RANDOM verb resets this seed to a new randomly determined value.

The starting seed will be the same each time the **COMPUTER** is turned on, so the sequence of random numbers generated with RND is the same each time, unless the seed is changed. This is very convenient during the development of a program because it means that the behavior of the program should be the same each time it is run, even though it includes an RND function. When you want to have the numbers be truly random, the RANDOM statement can be used to make the seed itself random.

Examples

1Ø RANDOM
2Ø X=RND 1Ø

When run from line 20, the value of X is based on the standard seed. When run from line 10, a new seed is used.

1 READ variable list

Where: variable list is: variable
 or: variable , variable list

Abbreviations: REA.

See also: DATA, RESTORE

Purpose

The READ verb is used to read values from a DATA statement and assign them to variables.

Use

When assigning initial values to an array, it is convenient to list the values in a DATA statement and use a READ statement in a FOR...NEXT loop to load the values into the array. When the first READ is executed, the first value in the first DATA statement is returned. Succeeding READs use succeeding values in the sequential order in which they appear in the program, regardless of how many values are listed in each DATA statement or how many DATA statements are used.

If desired, the values in a DATA statement can be read a second time by using the RESTORE statement.

Examples

10 DIM B (10)

Set up an array.

20 WAIT 32

30 FOR I=1 TO 10

40 READ B(I)

Loads the values from the DATA statement into B()—

50 PRINT B(I)*2

B(1) is 10, B(2) is 20, B(3) is 30, etc.

60 NEXT I

70 DATA 10 20 30 40 50 60

80 DATA 70 80 90 100

90 END

Verbs
REM

1 **REM** remark

Abbreviations: none

Purpose

The REM verb is used to include comments in a program.

Use

Often it is useful to include explanatory comments in a program. These can provide titles, names of authors, dates of last modification, usage notes, reminders about algorithms used, etc. These comments are included by means of the REM statement.

The REM statement has no effect on the program execution and can be included anywhere in the program. Everything following the REM verb in that line is treated as a comment.

Example

```
10 REM THIS LINE HAS NO EFFECT
```

1 RESTORE

2 RESTORE expression

Abbreviations: RES., REST., RESTO., RESTOR.

See also: DATA, READ

Purpose

The RESTORE verb is used to reread values in a DATA statement or to change the order in which these values are read.

Use

In the regular use of the READ verb, the **COMPUTER** begins reading with the first value in a DATA statement and proceeds sequentially through the remaining values. The first form of the RESTORE statement resets the pointer to the first value of the first DATA statement, so that it can be read again. The second form of the RESTORE statement resets the pointer to the first value of the first DATA statement whose line number is greater than the value of the expression.

Examples

10 DIM B(10)

Sets up an array.

20 WAIT 32

30 FOR I=1 TO 10

40 RESTORE

50 READ B(I)

Assign the value 20 to each of the elements of B().

60 PRINT B(I)*I

70 NEXT I

80 DATA 20

90 END

Verbs RETURN

1 RETURN

Abbreviations: RE., RET., RETU., RETUR.

See also: GOSUB, ON...GOSUB

Purpose

The RETURN verb is used at the end of a subroutine to return control to the statement following the originating GOSUB.

Use

A subroutine may have more than one RETURN statement, but the first one executed terminates the execution of the subroutine. The next statement executed will be the one following the GOSUB or ON...GOSUB which calls the subroutine. If a RETURN is executed without a GOSUB, an ERROR 5 will occur.

Examples

```
10 GOSUB 100
20 END
100 PRINT "HELLO"
110 RETURN
```

When run, this program prints the word "HELLO" one time.

1 STOP

Abbreviations: S., ST., STO.

See also: END, CONT

Purpose

The STOP verb is used to halt execution of a program for diagnostic purposes.

Use

When the STOP verb is encountered in program execution, the **COMPUTER** execution halts and a message is displayed such as 'BREAK IN 200' where 200 is the number of the line containing the STOP. STOP is used during the development of a program to check the flow of the program or examine the state of variables. Execution may be restarted using the CONT command.

Example

10 STOP Causes "BREAK IN 10" to appear in the display.

Verbs TROFF

1 TROFF

Abbreviations: TROF.

See also: TRON

Purpose

The TROFF verb is used to cancel the trace mode.

Use

Execution of the TROFF verb restores normal execution of the program.

Examples

```
1Ø TRON
2Ø FOR I=1 TO 3
3Ø NEXT I
4Ø TROFF
```

When run, this program displays the line numbers 10, 20, 30, 30, 30, and 40 as the  is pressed.

1 TRON

Abbreviations: TR., TRO.

See also: TROFF

Purpose

The TRON verb is used to initiate the trace mode.

Use

The trace mode provides assistance in debugging programs. When the trace mode is on, line number of each statement is displayed after each statement is executed. The **COMPUTER** then halts and waits for the Down Arrow key to be pressed before moving on to the next statement. The Up Arrow key may be pressed to see the statement which has just been executed. The trace mode continues until a TROFF verb is executed or the key operation of the **SHIFT** and **CA** **CCE** is performed.

Examples

10 TRON

20 FOR I=1 TO 3

30 NEXT I

40 TROFF

When run, this program displays the line numbers 10, 20, 30, 30, and 40 as the  is pressed.

Verbs USING

1 USING

2 USING "editing specification"

Abbreviations: U., US., USI., USIN.

See also: LPRINT, PAUSE, PRINT

Purpose

The USING verb is used to control the format of displayed or printed output.

Use

The USING verb can be used by itself or as a clause within an LPRINT, PAUSE, or PRINT statement. The USING verb establishes a specified format for output which is used for all output which follows until changed by another USING verb.

The editing specification of the USING verb consists of a quoted string composed of some combination of the following editing characters:

- # Right justified numeric field character
- Decimal point
- ^ Used to indicate that numbers should be displayed in scientific notation
- & Left justified alphanumeric field

For example, "####" is an editing specification for a right justified numeric field with room for 3 digits and the sign. In numeric fields, a location must be included for the sign, even if it will always be positive.

Editing specifications may include more than one field. For example "####&&&&" could be used to print a numeric and a character field next to each other.

If the editing specification is missing, as in format 1, special formatting is turned off and the built-in display rules pertain.

Examples

	<u>Display</u>
10 A=125:XS="ABCDEF"	
20 PRINT USING "##.##^";A	1.25E 02
30 PRINT USING "&&&&&&&";XS	ABCDEF
40 PRINT USING "####&&";A;XS	125ABC

(See APPENDIX C for further guide to the use of USING.)

1 **WAIT** expression

2 **WAIT**

Abbreviations: W., WA., WAI.

See also: PRINT

Purpose

The **WAIT** verb is used to control the length of time that displayed information is shown before program execution continues.

Use

In normal execution, the **COMPUTER** halts execution after a **PRINT** command until the **ENTER** key is pressed. The **WAIT** command causes the **COMPUTER** to display for a specified interval and then proceed automatically (similar to the **PAUSE** verb). The expression which follows the **WAIT** verb determines the length of the interval. The interval may be set to any value from 0 to 65535. Each increment is about one fifty-ninth of a second. **WAIT 0** is too fast to be read reasonably; **WAIT 65535** is about 19 minutes. **WAIT** with no following expression resets the **COMPUTER** to the original condition of waiting until the **ENTER** key is pressed.

Example

10 **WAIT 59** Causes **PRINT** to wait about 1 second.

FUNCTIONS

Pseudovariabes

Pseudovariabes are a group of functions which take no argument and are used like simple variables wherever required.

1 INKEY\$

INKEY\$ is a string pseudovariabes which has the value of the last key pressed on the keyboard. **ENTER**, **C-CE**, **SHIFT**, **DEF**, **SML**, **↑**, **↓**, **▶**, **◀**, **CAL**, **BASC**, and scientific function keys all have a value of null. INKEY\$ is used to respond to the pressing of individual keys without waiting for the ENTER key to end the input.

```
5 WAIT 50
10 A$=INKEY$
20 B=ASC A$
30 IF B=0 THEN GOTO 10
40 IF B ...
```

Lines 40 and beyond contain tests for the key and the actions to be taken (for example: 40 PRINT A\$). On first executing the program, the value of INKEY\$ is null, since the last key pressed was **ENTER**.

- If an INKEY\$ command is written at the beginning of the program, the start key may be read (by the INKEY\$ command) when the program is started. For example, in the following program

```
10"Z" : Z$=INKEY$
```

...

The **Z** key may be read when the program is started by pressing the **DEF Z** keys.

1 MEM

Abbreviations: M., ME.

Purpose

To obtain the number of free bytes in the program/data area.

Use

Obtains the number of free bytes (area not used by a program, array variables, or simple variables) in the program/data area.

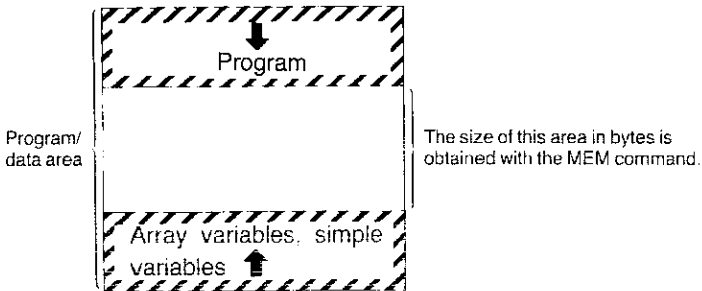

Reference

The program size (in bytes) can be obtained by the following operation.

Example:

RUN mode

```
CLEAR ENTER (Clears the simple variables, array variables, etc.)
6878-MEM ENTER ← displays the number of bytes in the program
```

Functions
Pseudovariabes

1 PI

PI is a numeric pseudovariabes which has the value of PI. It is identical to the use of the special PI character (π) on the keyboard. Like other numbers, the value of PI is kept to 10-digit accuracy (3.141592654).

Numeric Functions

Numeric functions are a group of mathematical operations which take a single numeric value and return a numeric value. They include trigonometric functions, logarithmic functions, and functions which operate on the integer and sign parts of a number. Many dialects of BASIC require that the argument to a function be enclosed in parentheses. The **COMPUTER** does not require these parentheses, except when it is necessary to indicate what part of a more complex expression is to be included in the argument.

LOG 100+100 will be interpreted as:

(LOG 100)+100 not LOG (100+100)

1 **ABS** numeric expression

ABS is a numeric function which returns the absolute value of the numeric argument. The absolute value is the value of a number without regard to its sign. ABS - 10 is 10.

1 **ACS** numeric expression

ACS is a numeric function which returns the arc cosine of the numeric argument. The arc cosine is the angle whose cosine is equal to the expression. The value returned depends on whether the **COMPUTER** is in decimal degree, radian, or grad mode for angles. ACS.5 is 60 in the decimal degree mode.

1 **AHC** numeric expression

AHC is a numeric function which returns arc-hyperbolic cosine of the numeric argument. AHC 5 is 2.29243167.

1 **AHS** numeric expression

AHS is a numeric function which returns arc-hyperbolic sine of the numeric argument. AHS 6 is 2.491779853.

1 **AHT** numeric expression

AHT is a numeric function which returns arc-hyperbolic tangent of the numeric argument.

Functions

Numeric Functions

1 **ASN** numeric expression

ASN is a numeric function which returns the arc sine of the numeric argument. The arc sine is the angle whose sine is equal to the expression. The value returned depends on whether the **COMPUTER** is in decimal degree, radian, or grad mode for angles. ASN.5 is 30 in the decimal degree mode.

1 **ATN** numeric expression

ATN is a numeric function which returns the arc tangent of the numeric argument. The arc tangent is the angle whose tangent is equal to the expression. The value returned depends on whether the **COMPUTER** is in decimal degree, radian, or grad mode for angles. ATN 1. is 45 in the decimal degree mode.

1 **COS** numeric expression

COS is a numeric function which returns cosine of the angle argument. The value returned depends on whether the **COMPUTER** is in decimal degree, radian, or grad mode for angles. COS 60 is 0.5 in the decimal degree mode.

1 **CUR** numeric expression

CUR is a numeric function which returns cubic root of its argument. CUR 8 is 2.

1 **DEG** numeric expression

The DEG function converts an angle argument in DMS (Degrees, Minutes, Seconds) format to DEG (Decimal Degrees) form. In DMS format the integer portion of the number represents degrees, the first and second digits of the decimal represent minutes, the third and fourth digits of the decimal represent seconds, and any further digits represent decimal seconds. For example, $55^{\circ} 10' 44.5''$ is represented as 55.10445. In DEG format the integer portion is degrees and the decimal portion is decimal degrees. DEG 55.10445 is 55.17902778.

1 **DMS** numeric expression

DMS is a numeric function which converts an angle argument in DEG format to DMS format (see DEG). DMS 55.17902778 is 55.10445.

1 **EXP** numeric expression

EXP is a numeric function which returns the value of e (2.718281828—the base of the natural logarithms) raised to the value of the numeric argument. EXP 1 is 2.718281828.

1 **FACT** numeric expression

FACT is a numeric function which returns the factorial of its argument. FACT 5 is 120.

1 **HCS** numeric expression

HCS is a numeric function which returns the hyperbolic cosine of the numeric argument. HCS 5 is 74.20994852.

1 **HSN** numeric expression

HSN is a numeric function which returns the hyperbolic sine of the numeric argument. HSN 4 is 27.2899172.

1 **HTN** numeric expression

HTN is a numeric function which returns the hyperbolic tangent of the numeric argument. HTN 1 is 0.761594156.

1 **INT** numeric expression

INT is a numeric function which returns the integer part of its numeric argument. INT PI is 3.

1 **LN** numeric expression

LN is a numeric function which returns the logarithm to the base e (2.718281828) of its numeric argument. LN 100 is 4.605170186).

1 **LOG** numeric expression

LOG is a numeric function which returns the logarithm to the base 10 of its numeric argument. LOG 100 is 2.

Functions

Numeric Functions

1 **POL** (numeric expression, numeric expression)

POL is a numeric function which converts numeric arguments in rectangular coordinates format to polar coordinate format.

The first numeric argument indicates the distance from the y-axis and the second numeric argument indicates the distance from the x-axis. The values converted, the distance and the angle in the polar coordinates, are assigned to the fixed variables Y and Z, respectively. The angle converted depends on whether the **COMPUTER** is in decimal degree, radian, or grad mode for angles. POL (3, 4) is (5, 53.13010235) in decimal degrees.

1 **RCP** numeric expression

RCP is a numeric function which returns the reciprocal of its numeric argument. RCP 5 is 0.2.

1 **REC** (numeric expression, numeric expression)

REC is a numeric function which converts numeric arguments in polar coordinates format to rectangular coordinates format.

The first numeric argument indicates the distance and second numeric argument indicates the angle which depends on whether the **COMPUTER** is in decimal degree, radian, or grad mode for angles. The values converted, the distances from the y-axis and the x-axis, are assigned into the fixed variables Y and Z, respectively. REC (7, 50) is (4.499513268, 5.362311102) in decimal degrees.

1 **RND** numeric expression

RND is a numeric function which generates random numbers. If the value of the argument is less than one but greater than or equal to zero, the random number is less than one and greater than or equal to zero. If the argument is an integer greater than or equal to 1, the result is a random number greater than or equal to 1 and less than or equal to the argument. If the argument is greater than or equal to 1 and not an integer, the result is a random number greater than or equal to 1 and less than or equal to the smallest integer which is larger than the argument. (In this case, the generation of the random number changes depending on the value of the decimal portion of the argument.)

Argument	----- Result -----	
	Lower Bound	Upper Bound
.5	$0 <$	< 1
2	1	2
2.5	1	3

The same sequence of random numbers is normally generated because the same "seed" is used each time the **COMPUTER** is turned on. To randomize the seed, see the **RANDOM** verb.

1 numeric expression **ROT** numeric expression

ROT is a numeric function which returns the power root of its argument.

125 **ROT** 3 is 5.

(i.e.: $\sqrt[3]{125}$ should be entered as 125 **ROT** 3.)

1 **SGN** numeric expression

SGN is a numeric function which returns a value based on the sign of the argument. If the argument is positive, the result is 1; if the argument is zero, the result is 0; if the argument is negative, the result is -1. **SGN** -5 is -1.

1 **SIN** numeric expression

SIN is a numeric function which returns the sine of the angle argument. The value returned depends on whether the **COMPUTER** is in decimal degree, radian, or grad mode for angles. **SIN** 30 is 0.5 in decimal degrees.

1 **SQR** numeric expression

SQR is a numeric function which returns the square root of its argument. It is identical to the use of the special square root symbol ($\sqrt{\quad}$) on the keyboard. **SQR** 4 is 2.

1 **SQU** numeric expression

SQU is a numeric function which returns the square of its numeric argument. **SQU** 3 is 9.

Functions
Numeric Functions

1 **TAN** numeric expression

TAN is a numeric function which returns the tangent of its angle argument. The value returned depends on whether the **COMPUTER** is in decimal degree, radian, or grad mode for angles. TAN 45 is 1 in decimal degrees.

1 **TEN** numeric expression

TEN is a numeric function which returns the value of 10 (the base of the common logarithms) raised to the value of its numeric argument.
TEN 3 is 1000.

String Functions

String functions are a group of operations used for manipulating strings. Some take a string argument and return a numeric value. Some take a string argument and return a string. Some take a numeric value and return a string. Some take a string argument and one or two numeric arguments and return a string. Many dialects of BASIC require the argument of a function to be enclosed in parentheses. The **COMPUTER** does not require these parentheses, except when it is necessary to indicate what part of a more complex expression is to be included in the argument. String functions with two or three arguments all require the parentheses.

1 ASC string expression

ASC is a string function which returns the numeric character code value of the first character in its argument. The chart of character codes and their relationship to characters is given in Appendix B. ASC "A" is 65. The **COMPUTER** uses ASCII codes and their characters.

1 CHR\$ numeric expression

CHR\$ is a string function that returns the character which corresponds to the numeric character code of its argument. The chart of character codes and their relationship to characters is given in Appendix B. CHR\$ 65 is "A".

i LEFT\$ (string expression, numeric expression)

LEFT\$ is a string function which returns the leftmost part of the string in the first argument. The number of characters returned is determined by the numeric expression. LEFT\$ ("ABCDEF", 2) is "AB".

1 LEN string expression

LEN is a string function which returns the length of the string argument. LEN "ABCDEF" is 6.

1 MID\$ (string expression, num. exp. 1, num. exp. 2)

MID\$ is a string function which returns a middle portion of the string in the first argument. The first numeric argument indicates the first character position to be included in the result. The second numeric argument indicates the number of characters that are to be included. MID\$ ("ABCDEF", 2,3) is "BCD".

Functions
String Functions

1 **RIGHTS** (string expression, numeric expression)

RIGHT is a string function which returns the rightmost part of the string in the first argument. The number of characters returned is determined by the numeric expression. **RIGHTS** ("ABCDEF", 3) is 'DEF'.

1 **STR\$** numeric expression

STR\$ is a string function which returns a string which is the character representation of its numeric argument. It is the reverse of **VAL**. **STR\$** 1.59 is '1.59'.

1 **VAL** string expression

VAL is a string function which returns the numeric value of its string argument. It is the reverse of **STR\$**. The **VAL** of a nonnumber is zero. **VAL** "1.59" is 1.59.

Note: The character string convertible by **VAL** function to a numerical value consists of numerals (0 to 9), symbols (+ and -) and a symbol (E) indicating an exponential portion. No other characters and symbols are included. If a character string includes other characters and symbols, any character string on the right of that character string will be ignored. If included in a character string, a space is usually regarded as nonexistent.

CHAPTER 9 TROUBLESHOOTING

This chapter provides you with some hints on what to do when your **SHARP COMPUTER** does not do what you expect from it. It is divided into two parts—the first part deals with general machine operation and the second with BASIC programming. For each problem, there are a series of remedies suggested. You should try each of these, one at a time, until you have solved the problem.

Machine Operation

If:	Then You Should:
There is nothing on the display after you have turned on the machine	<ol style="list-style-type: none"> 1. Check to see that the power switch is in the ON position. 2. Press the ON BRK key to see if AUTO POWER OFF has been activated. 3. Replace the batteries. 4. Adjust the contrast control.
There is a display, but no response to keystrokes	<ol style="list-style-type: none"> 1. Press C-CE key to clear. 2. Press CA (SHIFT C-CE) key to clear. 3. Turn the power OFF and ON again. 4. Hold down any key and push RESET button. 5. Push RESET button without pressing any key.
You get no response after you have typed in a calculation or answer	<ol style="list-style-type: none"> 1. Press ENTER key.
The machine displays something and stops while you are running a BASIC program	<ol style="list-style-type: none"> 1. Press ENTER key.
Your calculation entered is displayed in BASIC statement format (colon after the first number)	<ol style="list-style-type: none"> 1. Change the mode from PROgram to RUN for calculations.

Troubleshooting

If:	Then You Should:
You get no response from any keys	<ol style="list-style-type: none"><li data-bbox="519 156 952 212">1. Hold down any key and push RESET button.<li data-bbox="519 220 957 435">2. If you get no response from any key even after the above operation, push RESET button. Then, press Y , E , or ENTER in response to "MEMORY CLEAR O.K.?" message. This will clear the programs and data in memory.

BASIC Debugging

When entering a new BASIC program, it is usual for it not to work the first time. Even if you are simply keying in a program that you know is correct, such as those provided in this manual, it is usual to make at least one typing error. If it is a new program of any length, it will probably contain at least one logic error as well. Following are some general hints on how to find and correct your errors.

You run your program and get an error message:

1. Go back to the PROgram mode and use the or the key to recall the line with the error. The cursor will be positioned at the place in the line where the **COMPUTER** got confused.
2. If you can't find an obvious error in the way in which the line is written, the problem may lie with the values which are being used. For example, CHR\$(A) will produce a space if A has a value of 1. Check the value of each variable in either the RUN or the PROgram mode by typing in the name of the variable followed by .

You RUN the program and don't get an error message, but it doesn't do what you expect.

3. Check through the program line by line using LIST and the and keys to see if you have entered the program correctly. It is surprising how many errors can be fixed by just taking another look at the program.
4. Think about each line as you go through the program as if you were the computer. Take sample values and try to apply the operation in each line to see if you get the result that you expected.
5. Insert one or more extra PRINT statements in your program to display key values and key locations. Use these to isolate the parts of the program that are working correctly and the location of the error. This approach is also useful for determining which parts of a program have been executed. You can also use STOP to temporarily halt execution at critical points so that several variables can be examined.
6. Use TRON and TROFF, either as commands or directly within the program to trace the flow of the program through individual lines. Stop to examine the contents of critical variables at crucial points. This is a very slow way to find a problem, but sometimes it is also the only way.

CHAPTER 10 MAINTENANCE OF THE COMPUTER

To insure trouble-free operation of your **SHARP COMPUTER**, we recommend the following:

- * Always handle the **COMPUTER** carefully as the liquid crystal display is made of glass.
- * Keep the computer in an area free from extreme temperature changes, moisture, or dust. During warm weather, vehicles left in direct sunlight are subject to high temperature buildup. Prolonged exposure to high temperature may cause damage to your computer.
- * Use only a soft, dry cloth to clean the computer. Do not use solvents, water, or a wet cloth.
- * To avoid battery leakage, remove the batteries when the computer will not be used for an extended period of time.
- * If service should be required on this equipment, use only a SHARP servicing dealer, SHARP approved service facility, or SHARP repair service where available.
- * If the computer is subjected to strong static electricity or external noise, it may "hang up" (all keys become inoperative). If this occurs, press the RESET button while holding down any key. (See Troubleshooting.)
- * Keep this manual for further reference.

APPENDIX A Error Messages

There are nine different error codes built into the **COMPUTER**. The following table will explain these codes.

Error Number	Meaning
1	<p>Syntax error</p> <ul style="list-style-type: none"> This means that the COMPUTER can't understand what you have entered. Check for things such as semicolons on the ends of PRINT statements, misspelled words, and incorrect usages. <p style="text-align: center;">3*/2</p>
2	<p>Calculation error</p> <p>Here you have probably done one of three things:</p> <ol style="list-style-type: none"> Tried to use too large a number. Calculation results are greater than 9.999999999E 99. Tried to divide by zero. 5/0 An illogical calculation has been attempted. LN -30 or ASN 1.5
3	<p>DIMension error/Argument error</p> <ul style="list-style-type: none"> Array variable already exists. Array specified without first dimensioning it. Array subscript exceeds size of array specified in DIM statement. DIM B(256) Illegal function argument. This means that you have tried to make the COMPUTER do something that it just can't handle. The time interval specified for the WAIT verb is greater than 65535. WAIT 66000

APPENDIX A
Error Messages

4 Line number error

Here you have probably done one of two things:

1. Tried to reference a nonexistent line number with a GOTO, GOSUB, RUN, LIST, THEN, or the like.
2. Tried to use too large a line number. The maximum line number is 65279.

5 Nesting error

Subroutine nesting exceeds 10 levels.

FOR loop nesting exceeds 5 levels.

RETURN verb without a GOSUB, NEXT verb without a FOR, or READ verb without a DATA.

Buffer space exceeded.

6 Memory overflow

Generally this error happens when you've tried to DIMension an array that is too big for memory. This can also happen when a program becomes too large.

7 PRINT USING error

This means that you have put an illegal format specifier into a USING statement.

8 I/O device error

This error can happen only when you have the optional printer and/or cassette recorder connected to the **COMPUTER**. It means that there is a problem with communication between the I/O device and the **COMPUTER**.

9 Other errors

This code will be displayed whenever the computer has a problem that isn't covered by one of the other eight error codes. One of the most common causes for this error is trying to access data in a variable in one fashion (e.g., A\$) while the data was originally stored in the variable in another fashion (e.g., A).

ERRORS RELATED TO RENUM

Error message	Description
ERROR 1	A syntax error exists in the RENUM command.
ERROR 1 IN line number	A line number reference is missing from the command specifying the jump destination (e.g., GOTO, GOSUB, etc.).
ERROR 3 IN line number	A line number greater than 65279 is encountered during the execution of the RENUM command. The length of one program line exceeds 79 bytes.
ERROR 4	The specified old line number does not exist in the program.
ERROR 4 IN line number	The line number specified as the jump destination does not exist in the program file.
ERROR 6	Memory capacity is insufficient to execute the RENUM command, or becomes short during the renumbering process.
ERROR 9	An attempt was made to execute the RENUM in other than PRO (Program) mode. An attempt was made to change the execution order of program lines by specifying the new line number lower than the line number immediately before the old line number.
ERROR 9 IN line number	The line number specified as the jump destination is inappropriate, because it uses a variable, expression, or function (i.e., incorrect line number reference).

APPENDIX B CHARACTER CODE CHART

The following chart shows the conversion values for use with CHR\$ and ASC. The column shows the first hex character or the first four binary digits (i.e., bits); the row shows the second hex character or the second four bits. The upper left corner of each box contains the decimal number for the character. The lower right shows the character. If no character is shown, then it is an illegal character on the **COMPUTER**.

For example, the character "A" is decimal 65 or hex 41 or binary 01000001. The character '√' is decimal 252 or hex FC or binary 11111100.

Notes:

- The characters for character codes 92(&5C), 249(&F9), and 250(&FA) appearing on the computer display differ from the characters for these codes printed by optional printers CE-126P.
- The character printed for character code 92(&5C) shown in the following table is  with the CE-126P printer.
- When using the CE-126P printer, do not use code 0(&00).
- Any codes other than 0 (&00) through 31 (&1F) not used for characters are printed as spaces.
- Codes 249 (&F9) and 250 (&FA) are spaces.

APPENDIX B
Character Code Chart

First 4 Bits

Hex Binary	0	1	2	3	4	5	6	7	8	E	F
	0000	0001	0010	0011	0100	0101	0110	0111	1000	1110	1111
0	0	16	32	48	64	80	96	112	128	224	240
0000	NUL		SPACE	␣	@	P	q	p			
1	1	17	33	49	65	81	97	113	129	225	241
0001			!	1	A	Q	a	q			
2	2	18	34	50	66	82	98	114	130	226	242
0010			"	2	B	R	b	r			
3	3	19	35	51	67	83	99	115	131	227	243
0011			#	3	C	S	c	s			
4	4	20	36	52	68	84	100	116	132	228	244
0100			\$	4	D	T	d	t			
5	5	21	37	53	69	85	101	117	133	229	245
0101			%	5	E	U	e	u			♣
6	6	22	38	54	70	86	102	118	134	230	246
0110			&	6	F	V	f	v			♥
7	7	23	39	55	71	87	103	119	135	231	247
0111			'	7	G	W	g	w			♦
8	8	24	40	56	72	88	104	120	136	232	248
1000			{	8	H	X	h	x			♠
9	9	25	41	57	73	89	105	121	137	233	249
1001			}	9	I	Y	i	y			♣
A	10	26	42	58	74	90	106	122	138	234	250
1010			*	:	J	Z	j	z			□
B	11	27	43	59	75	91	107	123	139	235	251
1011			+	;	K	!	k	!			π
C	12	28	44	60	76	92	108	124	140	236	252
1100			,	<	L	\	l	!			√
D	13	29	45	61	77	93	109	125	141	237	253
1101			-	=	M]	m	!			
E	14	30	46	62	78	94	110	126	142	238	254
1110			.	>	N	^	n	~			
F	15	31	47	63	79	95	111	127	143	239	255
1111			/	?	O	-	o				

S e c o n d 4 B i t s

APPENDIX C FORMATTING OUTPUT

It is sometimes important or useful to control the format as well as the content of the output. The **COMPUTER** controls display formats with the **USING** verb. This verb allows you to specify:

- the number of digits
- the location of the decimal point
- the scientific notation format
- the number of string characters

These different formats are specified with an “output mask”. This mask may be a string constant or a string variable:

```
10: USING "####"  
20: M$="&&&&&&"  
30: USING M$
```

When the **USING** verb is used with no mask, all special formatting is canceled.

```
40: USING
```

A **USING** verb may also be used within a **PRINT** statement:

```
50: PRINT USING M$; N
```

Wherever a **USING** verb is used, it will control the format of all output until a new **USING** verb is encountered.

Numeric Masks

A numeric **USING** mask may only be used to display numeric values, i.e., numeric constants or numeric variables. If a string constant or variable is displayed while a numeric **USING** mask is in effect, the mask will be ignored. A value that is to be displayed must always fit within the space provided by the mask. The mask must reserve space for the sign character, even when the number will always be positive. Thus a mask that shows four display positions may only be used to display numbers with three digits.

Specifying Number of Digits

The desired number of digits is specified using the '#' character. Each '#' in the mask reserves space for one digit. The display or print always contains as many characters as are designated in the mask. The number appears to the far right of this field; the remaining positions to the left are filled with spaces. Positive numbers therefore always have at least one space at the left of the field. Since the **COMPUTER** maintains a maximum of 10 significant digits, no more than 11 '#' characters should be used in a numeric mask.

When the total number of columns of the integer part specified exceeds 11, this integer part is regarded as 11 digits in the **COMPUTER**.

NOTE: In all examples in this appendix, the beginning and end of the displayed field will be marked with an 'I' character to show the size of the field.

<u>Statement</u>	<u>Display</u>
10: USING "####"	(Set the COMPUTER to the RUN mode, type RUN, and press ENTER .)
20: PRINT 25	25
30: PRINT -350	-350
40: PRINT 1000	ERROR 7 IN 40

Notice that the last statement produced an error because 5 positions (4 digits and a sign space) were required, but only 4 were provided in the mask.

Specifying a Decimal Point

A decimal point character, '.', may be included in a numeric mask to indicate the desired location of the decimal point. If the mask provides more significant decimal digits than are required for the value to be displayed, the remaining positions to the right will be filled with zeros. If there are more significant decimal digits in the value than in the mask, the extra digits will be truncated (**not** rounded):

<u>Statement</u>	<u>Display</u>
10: USING "####.##"	
20: PRINT 25	25.00
30: PRINT -350.5	-350.50
40: PRINT 2.547	2.54

Specifying Scientific Notation

A “^” character may be included in the mask to indicate that the number is to be displayed in scientific notation. The ‘#’ and ‘.’ characters are used in the mask to specify the format of the “characteristic” portion of the number, i.e., the part which is displayed to the left of the **E**. Two ‘#’ characters should always be used to the left of the decimal point to provide for the sign character and one integer digit. The decimal point may be included, but is not required. Up to 9 ‘#’ characters may appear to the right of the decimal point. Following the characteristic portion, the exponentiation character, **E**, will be displayed followed by one position for the sign and two positions for the exponent. Thus, the smallest scientific notation field would be provided by a mask of “##^” which would print numbers of the form ‘2E 99’. The largest scientific notation field would be “##.#####^” which would print numbers such as ‘-1.234567890 E -12’:

<u>Statement</u>	<u>Display</u>
10: USING “###.##^”	
20: PRINT 2	2. 00 E 00
30: PRINT -365.278	-3. 65 E 02

Specifying Alphanumeric Masks

String constants and variables are displayed using the ‘&’ character. Each ‘&’ indicates one character in the field to be displayed. The string will be positioned at the left end of this field. If the string is shorter than the field, the remaining spaces to the right will be filled with spaces. If the string is longer than the field, the string will be truncated to the length of the field:

<u>Statement</u>	<u>Display</u>
10: USING “&&&&&&”	
20: PRINT “ABC”	A B C
30: PRINT “ABCDEFGHI”	A B C D E F

Mixed Masks

In most applications, a USING mask will contain either all numeric or all string formatting characters. However, both types of characters may be included in one USING mask for certain purposes. In such cases, each switch from numeric to string formatting characters or vice versa marks the boundary for a different value. Thus, a mask of "#####&&&&" is a specification for displaying two separate values—a numeric value which is allocated 5 positions and a string value which is allocated 4 positions:

<u>Statement</u>	<u>Display</u>
1Ø: PRINT USING "####.##&&"; 25; "CR"	25. 00CR
2Ø: PRINT -5.789; "DB"	-5. 78DB

Remember that a USING format once specified is used for all outputs which follow until canceled or changed by another USING verb.

APPENDIX D

EXPRESSION EVALUATION AND OPERATOR PRIORITY

When the **SHARP COMPUTER** is given a complex expression, it evaluates the parts of the expression in a sequence determined by the priority of the individual parts of the expression. If you enter the expression:

$$100 / 5 + 45$$

as either a calculation or as a part of a program, the **COMPUTER** does not know whether you meant:

$$\frac{100}{5 + 45} = 2 \quad \text{or} \quad \frac{100}{5} + 45 = 65$$

Since the **COMPUTER** must have some way to decide between these options, it uses its rules of operator priority. Because division has a higher "priority" than addition (see below), it will choose to do the division first and then the addition, i.e., it will choose the second option and return a value of 65 for the expression.

Operator Priority

Operators on BASIC mode of the **SHARP COMPUTER** are evaluated with the following priorities from highest to lowest:

Level	Operation
1	Parentheses
2	Variables and Pseudovariables
3	Functions
4	Exponentiation (^), (ROT)
5	Unary minus, negative sign (-)
6	Multiplication and division (*, /)
7	Addition and subtraction (+, -)
8	Relational operators (<, <=, =, <>, >=, >)
9	Logical operators (AND, OR, NOT, XOR)

When there are two or more operators at the same priority level, the expression will be evaluated from left to right. (The exponentiation will be evaluated from right to left.) Note that with $A+B-C$, for example, the answer is the same whether the addition or the subtraction is done first.

When an expression contains multiple nested parentheses, the innermost set is evaluated first and evaluation then proceeds outward.

APPENDIX D

Expression Evaluation and Operator Priority

For levels 3 and 4, the last entry has a higher priority.

$$\begin{aligned}\text{For example: } -2 \wedge 4 &\rightarrow -(2^4) \\ 3 \wedge -2 &\rightarrow 3^{-2}\end{aligned}$$

Sample Evaluation

Starting with the expression:

$$((3+5-2)*6+2)/10 \wedge \text{LOG } 100$$

The **COMPUTER** would first evaluate the innermost set of parentheses. Since '+' and '-' are at the same level, it would move from left to right and would do the addition first:

$$((8-2)*6+2)/10 \wedge \text{LOG } 100$$

Then it would do subtraction:

$$((6)*6+2)/10 \wedge \text{LOG } 100$$

or:

$$(6*6+2)/10 \wedge \text{LOG } 100$$

In the next set of parentheses, it would do the multiplication first:

$$(36+2)/10 \wedge \text{LOG } 100$$

And then the addition:

$$(38)/10 \wedge \text{LOG } 100$$

or:

$$38/10 \wedge \text{LOG } 100$$

Now that the parentheses are cleared, the LOG function has the highest priority so it is done next:

$$38/10 \wedge 2$$

The exponentiation is done next:

$$38/100$$

And last of all, the division is performed:

$$0.38$$

This is the value of the expression.

APPENDIX E

KEY FUNCTIONS IN BASIC MODE

**ON
BRK**

(ON)

Used to turn the **COMPUTER** power on when the auto power off function is in effect.

(BREAK)

- Depression of this key during program execution functions as a BREAK (**ON
BRK**) key and causes to interrupt the program execution.
- When pushed during manual execution of an input/output command such as BEEP, CLOAD, etc., execution of the command is interrupted.

SHIFT

- This yellow key is used to designate a second function (that inscribed in brown above each key).

Ex. **SHIFT** **U** → ? is input.

C-CE

- Used to clear the contents of the entry and the display. (Error release)

SHIFT

CA

- Used to not only clear the display contents, but to reset the computer to its initial state.

– Initial state –

- Resets the WAIT timer.
- Resets the display format. (USING format)
- Resets the TRON state (TROFF).
- Resets the PRINT = LPRINT.
- Resets error.

0

~ **9**

- Numeric keys

.

- Decimal point
- Used to enter an abbreviation for a command, verb, or function.
- Used to designate the decimal portion in USING format designation.

E

- Used to designate an exponent in scientific notation. (This is the letter E key.)

EXP

- Used to designate an exponent in scientific notation.



























/







- Division key

- Multiplication key
- Used to designate an array variable in the INPUT#, the PRINT#, etc.

APPENDIX E



Key Functions in BASIC Mode



-  • Addition key
-  • Subtraction key
-   • Used to enter CLOAD?
-   • Used to divide two or more statements in one line.
-  • Used to provide pause between two equations, and between variables or comments.
-   • Used to provide multi-display (two or more values/contents/displayed at a time).
 - Used to provide pause between the instruction and the variable.
-  • Used in assignment statements to assign the contents (number or character) on the right for the variable specified on the left.
 - Used when inputting logical operators in IF statement.
-  • When any one of eighteen keys (A, S, D, F, G, H, J, K, L, Z, X, C, V, B, N, M, ', SPaCe) is pushed after the depression of the  key, the computer starts to execute the program from the program line that has the same label as the key code depressed.
-  ~  • Letter keys. You are probably familiar with these keys from the standard typewriter keyboard. On the **COMPUTER** display, the characters appear in the uppercase.
- ,  • Used to input parentheses.
-   }
  } • Used when inputting logical operators in IF statement.
-  • Used to provide space when inputting programs or characters.
-   • Used for power calculation instructions.
 - Used to specify the floating decimal point system (exponent display) for numerical data in USING statement instructions.
-   • Used to designate Pi (π).
-  • Used to designate square root.









-   • Used to designate these symbols.
-  " : • Used to designate and cancel characters.
-  • Used to specify labels.
-  # : Used with USING statement, to provide the instruction to define the display format of numerical data.
-  % : • Used when assigning character variables.
-  & : • Used with USING statement, to provide the instruction to define the display format of character string.
- Used to designate hexadecimal number.

-  • Used to shift the cursor to the right (press once to advance one position, hold down for automatic advance).
- Used to execute playback instructions.
- Used to clear an error condition in manual operation.



-  • Used to shift the cursor to the left (press once to advance one position, hold down for automatic advance).
- Used to execute playback instructions.
- Used to clear an error condition in manual operation.



-   • Used to insert a space (appears) of 1-step capacity between the address (N) indicated by the cursor and the preceding address (N-1).



-   • Used to delete the contents of the address indicated by the cursor.

-   • Used to preset command and verb keys. Pressing  and then the letter (including comma and space) key below the command or verb desired followed by  key causes the designated command or verb to be entered into the **COMPUTER**.
-   } • Used to preset command and verb keys. Pressing  and then the letter (including comma and space) key below the command or verb desired followed by  key causes the designated command or verb to be entered into the **COMPUTER**.



-  • Used to set the CAL mode.







-  • Used to set the RUN mode when the CAL mode is set.
Used to set the PRO mode when the RUN mode is set.
The RUN and PRO modes are selected alternately each time you press the  key.

-   • Used to set the print or nonprint mode when an optional printer is connected with the **COMPUTER**.

-   • Used to designate an angular unit (DEG, RAD, or GRAD).

-  • Used to enter a hyperbolic function.

-   • Used to enter an inverse hyperbolic function.

-   } • Used to enter a function defined in each key.
-   } • Used to enter a function defined in each key.
-   } • Used to enter a function defined in each key.

APPENDIX E
Key Functions in BASIC Mode

ENTER

- Used to enter a program line into the computer.
- Used for writing a program.
- Used to request manual calculation or direct execution of a command statement by the computer.
- Used to enter a restart instruction after inputting data required by an INPUT statement or after executing a PRINT statement.

Refer to page 45 for the keys used for MATRIX operations.

The \uparrow and \downarrow keys have the following functions, depending on the designated mode, as well as the state of the computer.

Mode	State	\downarrow	\uparrow
RUN	Program being executed	/	/
	Program is temporarily interrupted	To execute the next line	To display the program line being executed or already executed, hold this key down.
	INPUT statement being executed		
	PRINT statement just now executed		
	Under break		
	Error condition during executing program	/	To display the error-producing line, hold this key down.
	TRON condition	To execute debugging operation	To display the program line being executed or already executed, hold this key down.
	Other conditions	To display an answer just previously calculated. (Last answer function)	Same as left
PRO	(When the mode is changed from RUN to PRO and program line is not being displayed)		
	Program is temporarily interrupted	To display the line interrupted	Same as left
	Error condition	To display the line with error	Same as left
	Other conditions	To display the first line	To display the last line
	(When the program line is being displayed)	To display the next program line	To display the preceding program line

Note: The following keys cannot be used in the BASIC mode (RUN or PRO mode).

FSE , SHIFT TAB , \downarrow , SHIFT STAT , $\text{SHIFT } \Delta\%$, $\text{x}\cdot\text{M}$, RM , $\text{M}+$, +/- , and keys used to obtain the statistics (i.e., n, x, etc.)

APPENDIX F SPECIFICATIONS

Model:	PC-1403 Pocket Computer		
Processor:	8-bit CMOS CPU		
Programming Language:	BASIC		
System ROM:			72K Bytes
Memory Capacity:	RAM:		
	System		Approx. 1.1K Bytes
	User		
	Fixed Memory Area (A ~ Z, A\$ ~ Z\$)		208 Bytes
	Program/Data Area		6878 Bytes
Stack:	Subroutine:	10 stacks	Function: 16 stacks
	FOR-NEXT:	5 stacks	Data: 8 stacks
Operators:	Addition, subtraction, multiplication, division, trigonometric and inverse trigonometric functions, logarithmic and exponential functions, angle conversion, square and square root, sign, absolute, integer, relational operators, logical operators, matrix operations.		
Numeric Precision:	10 digits (mantissa) + 2 digits (exponent).		
Editing Features:	Cursor left and right, line up and down, character insert, character delete.		
Memory Protection:	CMOS Battery backup.		
Display:	24-character Liquid Crystal Display with 5 × 7 dot pattern.		
Keys:	77 keys: Alphabetic, numerics, special symbols, functions, and user defined keys.		
Power Supply:	6.0V DC: Lithium cells.		
	Type: CR-2032×2		
Power Consumption:	6.0V DC @ 0.03W		
	Approximately 120 hours of continuous operation under normal conditions (based on 10 minutes of operation or program execution and 50 minutes of display per hour at a temperature of 20°C). The time may vary slightly depending on usage and the type of battery used.		
Operating Temperature:	0°C to 40°C		
Dimensions:	170(W)×72(D)×9.5(H) mm.		
	6-11/16"(W)×2-27/32"(D)×3/8"(H)		

APPENDIX F
Specifications

- Weight:** Approximately 150 g (0.33 lb) (with two cells)
- Accessories:** Hard cover, two lithium cells (built-in), keyboard template, operation manual.
- Option:** Printer/Cassette Interface (CE-126P)

APPENDIX G USING PROGRAMS WRITTEN ON OTHER PC MODELS

Programs written on the following computers can be used on the PC-1403 with slight modifications.

PC-1210 Series: PC-1210/11

PC-1245 Series: PC-1245/46/47

PC-1250 Series: PC-1250/51

PC-1260 Series: PC-1260/61

PC-1350 Series: PC-1350

PC-1401 Series: PC-1401/02

PC-1450 Series: PC-1450

PC-1460 Series: PC-1460

PC-2500 Series: PC-2500

Although the functions of these models all differ slightly, programs composed on any of these models can be used on the PC-1403 by making the modifications below.

- Notes:**
1. PC-1403 can read programs from tapes recorded with programs written on PC-1210 Series, PC-1245 Series, and PC-1250 Series computers, but programs written and recorded with PC-1403 cannot be read or used by computers in these three series.
 2. Program tapes for the PC-1245 Series and PC-1210 Series recorded with a number of programs loaded with the MERGE command cannot be used on the PC-1403. To use them, MERGE the programs individually into the PC-1403.
 3. Programs containing POKE or CALL commands written on the PC-1250 Series cannot be executed on the PC-1403. Execution of such programs may render all PC-1403 keys inoperable.

Modifications Required for PC-1245 Series (including PC-1250 Series) Programs

When using on the PC-1403 a program developed for the PC-1245 Series, the following modifications are necessary:

- (1) Multiplication without using the operator "*". On the PC-1245 Series, the operator (*) for multiplication may be omitted, such as AB for A*B or CD for C*D. On the PC-1403, however, the multiplication operator (*) cannot be omitted since the computer treats two consecutive characters, such as AB or CD, as simple variables. Use the specification on the right side of the following example:

e.g., $A = \text{SIN } BC \rightarrow A = \text{SIN } (B * C)$

- (2) Definition of subscripted variables (such as A()) by using the DIM statement: On the PC-1245 Series, if, for example, DIM A(30) is executed, memory locations for A(27) through A(30) are set aside as an extension of a fixed variable definition area. On the PC-1403, however, the execution of DIM A(30) reserves a separate memory area for array variables A(0) through A(30) for the array named A. When defining subscripted variables (such as A()) as an extension of fixed variables, use the specification on the right side of the following example:

$\text{DIM } A(30) \rightarrow A(30) = 0$

- (3) Data I/O statement for tape files: On the PC-1245 Series, the execution of, for instance, the PRINT# C statement saves the contents of the variable C and all the subsequent variables to a tape file. On the PC-1403, however, the execution of the same statement saves the contents of the variable C only. To save the contents of a specific variable and all the subsequent variables, use the specifications on the right side of the following examples:

e.g., $\text{PRINT\#A} \rightarrow \text{PRINT\#A*}$
 $\text{INPUT\#C} \rightarrow \text{INPUT\#C*}$

- (4) Value of a loop variable after completion of a FOR-NEXT loop: The value of a loop variable obtained after the execution of a FOR-NEXT loop completed on the PC-1403 is different from that obtained on the PC-1245 Series. If the value of a loop variable is used in a conditional expression in a PC-1245 Series program, increment it by one when it is used on the PC-1403.

e.g., 10 FOR I=0 TO 10

50 NEXT I

60 IF I=10 THEN 100

Modify the value of I in line 60 as follows:

60 IF I=11 THEN 100

(On the PC-1403, the value of a loop variable must be incremented by one step value. The number of loop execution cycles remains the same, however.)

(5) Redefining 

The equal  key does not function as a definable key on the PC-1403. Accordingly, a different key should be used in programs in which the equal key is defined.

e.g., 100 "="... 100 "N"....

(6) Exponent symbol "IE":

The PC-1403 uses the uppercase letter "E" for its exponent symbol. The following changes are required:





A=1.234 IE 5→A=1.234E5

B=IE 6→B=1E6

If a PC-1245 program is read from a tape file into the PC-1403, the change for the exponent symbol described just above will automatically be done by the PC-1403.

(7) The character codes of the PC-1245 Series are partially different from those of the PC-1403.

When the following codes are designated by the CHR\$ function, change the codes.

Character Code	PC-1245	PC-1403
39 (&27)		'
91 (&5B)		[
92 (&5C)	¥	\
93 (&5D)	π]
96 (&60)	E	'
250 (&FA)	-(Error)	
251 (&FB)	-(Error)	π
252 (&FC)	-(Error)	

Note: As shown above, the PC-1403 does not have the character IE.

Additional modifications

- (1) The PC-1245 Series uses a line number ranging from 1 to 999, whereas the PC-1403 has an extended line number ranging from 1 to 65279. Therefore, the line number uses 3 bytes in RAM (PC-1245 Series uses 2 bytes). The modification is carried out automatically when the program is loaded through the cassette tape. However, there is a possibility of memory overflow (ERROR 6) when loading or executing a long program. Further, when a single line is close to 80 bytes long, this modification may result in the erasing of the end of the line.
- (2) If the tape stops or the read alarm stops when reading a program from a tape with PC-1245 Series programs, the computer will remain busy for 1 or 2 seconds and two asterisks will appear in the display.
This is because the computer is modifying the line numbers as described in (1) above.

Modifications Required for PC-1210 Series

To use PC-1210 Series programs on the PC-1403, they must be modified in the same way as PC-1245 Series programs except items (2) and (7). In addition, the following modifications are necessary.

- (1) IF statement

If, for example,

```
50 IF A>L PRINT "A" (display "A" if A>L)
```

is found in the program for the PC-1210 Series Pocket Computers, it is interpreted as

```
50 IF A>LPRINT "A" (Print out "A" if A>)
```

and results in an error when it is entered through the keyboard.

The error occurs because a command which does not exist in the PC-1210 Series does in fact exist in the PC-1403. To solve this problem, insert a THEN command into the IF statement as follows.

```
50 IF A>L THEN PRINT "A"
```

(2) Specified format in USING

The function of the USING command differs between the PC-1403 and the PC-1210 Series as follows.

Example:

```
10 A = -123.456
20 PAUSE USING "####.##"; A
30 PAUSE A, USING "####"; A
```

Executing this program displays the following.

*PC-1210/PC-1211

	-123.45
-123	-123

*PC-1403

	-123.45
-123.45	-123

For the execution of line 30 in the PC-1210 Series, the display on the left side also follows the displayed format on the right side. In the PC-1403, the display follows the previous specified format. This applies not only to the PAUSE command, but also to the PRINT and LPRINT commands.

(3) Omitting “)”

In the PC-1210 Series, the “)” which comes immediately before the ENTER or : (colon) can be omitted. It cannot be omitted in the PC-1403. Therefore, be sure to add the “)” to the program, if omitted.

(4) Print command

The PC-1403 has a PRINT command for displays and an LPRINT command for printing. However, all PRINT commands can be used for printing if PRINT = LPRINT is specified.

The PC-1210 Series does not have the LPRINT command. To print using a PC-1210 Series program, add PRINT = LPRINT to the program or, execute manually.

(5) Variables

When the RUN command has been executed in the PC-1210 Series, all variables are retained. In the PC-1403, however, all variables from A(27) and upwards are cleared.

Therefore, if there is a need to retain variables at the start of program execution, start the program execution using the GOTO command or function defined keys.

Modifications Required for PC-1260 Series

- (1) Character Code modification
Character code 96 (&60) is a space in PC-1260 Series but is a left single quote (') in PC-1403. Accordingly, when the CHR\$ command is used to specify a space with character code 96, change this code to character code 32 (&20).
- (2) CLS, CURSOR commands
PC-1403 does not have the CLS or CURSOR display commands. Deletion and modification of these commands in any programs containing these are required.

Modifications Required for PC-1401, PC-1450, and PC-1460 Series

Programs written on PC-1401, PC-1450 and PC-1460 Series computers can be used without modification on the PC-1403.

Modifications Required for PC-1350 and PC-2500 Series

PC-1403 does not contain the following commands. Any program containing these must be modified.

CLS, CURSOR, MEM\$, GCURSOR, GPRINT, LINE, POINT, PRESET, PSET, (TEST)

Programming Examples

Having read the description of each of the various functions in the preceding chapters, you have by now gained a knowledge of a number of program commands. However, in order for you to have a command of developing application programs in BASIC language, it is absolutely necessary that you write and execute your own practical application programs as well as those explained in this manual.

Just as you can improve your driving skill by actually operating the steering wheel or your tennis game by swinging the racket, proficiency in programming can only be attained by practicing as many programs as possible, regardless of the degree of your skill at each practice.

It is also very important for you to refer to programs developed by others. In this chapter, some programming examples using various commands in "BASIC" language are introduced to your reference.

For better understanding of the programming examples in this chapter, the conventions used in such examples are explained as follows:

① PROGRAM LIST

All the program lists contained in the programming examples are provided using the hard-copy outputs from the CE-126P printer in actual size.

② PROGRAM CAPACITY

At the end of each program list, the capacity of the program itself is indicated in number of bytes.

③ PRINTOUT

For a program requiring a printout, the output of the program executed using the CE-126P printer is given in actual size.

④ MEMORY CONTENTS

In the table of memory contents in each program example, variables with predetermined use are indicated by their specific use and those without predetermined use (e.g., those to be stored in the work area to retain intermediate results of a calculation, etc.) are indicated by the checkmark "√".

SHARP CORPORATION and/or its subsidiaries assume no responsibility or obligation for any financial losses or damages that may be incurred from using any of the examples of programs described in this manual. When using these programs, be aware that these programs may not fully satisfy your purpose or some programs may not be as precise as you wish them to be. Therefore, please carefully check the data in each of the program examples you use and confirm that they meet your requirements. If not, please modify them as required to meet your purpose before using them.

CONTENTS

Program Title	Page
• Conversions between Orthogonal Coordinates and Polar Coordinates	222
• Calculation of Area of N-sided Polygon	227
• A Circle Osculating Two Circles	234
• Number Guessing Game	238

PROGRAM TITLE: Conversions between Orthogonal Coordinates and Polar Coordinates

This is a very useful program for effecting conversions between orthogonal coordinates and polar (spherical) coordinates in three dimensions. When each data for conversion is input, the result of the conversion is obtained according to the unit of angle which is effective at that time.

■ HOW TO OPERATE

1. Press **DEF** **A** (for conversion to polar coordinate from orthogonal coordinates).

When the value of each of orthogonal coordinates x , y , and z is input according to the display, the value of each of polar coordinates r , θ , and ϕ appears on the screen in the order named and then the program ends.

2. Press **DEF** **B** (for conversion to orthogonal coordinates from polar coordinates).

When the value of each of polar coordinates R , θ , and ϕ is input, each value of x , y , and z appears on the screen in the order named and then the program ends.

Note: When the unit of angle specification is DEG, the result of a conversion is obtained in units of degrees. Likewise, when the angular unit specified is RAD, conversion is performed in units of radians.

■ REMARKS

1. Conversion to polar coordinates from orthogonal coordinates $r=0$ and θ =indefinite if $r=y=0$

$$r = \sqrt{x^2 + y^2 + z^2}$$

$$\theta = \sin^{-1} (z/r)$$

$$\phi = \tan^{-1} (y/x) \text{ if } x > 0$$

$$\phi = 90^\circ \text{ if } x = 0 \text{ and } y \geq 0$$

$$\phi = -90^\circ \text{ if } x = 0 \text{ and } y < 0$$

$$\phi = \tan^{-1} (y/x) + 180^\circ \text{ if } x < 0 \text{ and } y \geq 0$$

$$\phi = \tan^{-1} (y/x) - 180^\circ \text{ if } x < 0 \text{ and } y < 0$$

2. Conversion to orthogonal coordinates from polar coordinates

$$x = r \cos \theta \cdot \cos \phi$$
$$y = r \cos \theta \cdot \sin \phi$$
$$z = r \sin \theta$$

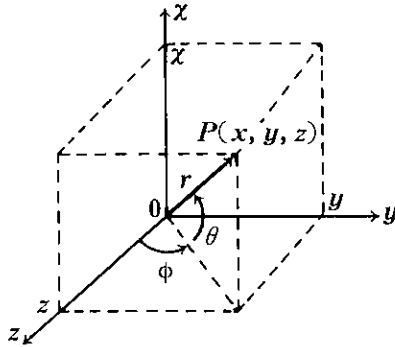

■ EXAMPLES

1. Convert orthogonal coordinates to polar coordinates

$$x = -1$$
$$y = 2$$
$$z = -3$$

Angular unit specification: DEG

2. Convert polar coordinates to orthogonal coordinates

$$r = 3.741657387$$
$$\theta = -53.30077479$$
$$\phi = 116.5650512$$

Angular unit specification: DEG

■ KEY OPERATION SEQUENCE

[Orthogonal coordinates → Polar coordinates]

1. **DEF** **A**

$x = _$

2. **-1** **ENTER**

$y = _$

3. **2** **ENTER**

$z = _$

4. **-3** **ENTER**

r

5. **ENTER**

3.741657387

6. **ENTER**

THETA

7. **ENTER**

-53.30077479

8. **ENTER**

PHI

9. **ENTER**

116.5650512

10. **ENTER**

>

[Polar coordinates → Orthogonal coordinates]

1. **DEF** **B**

$r = _$

2. **3.741657387** **ENTER**

THETA = $_$

3. **-53.30077479** **ENTER**

PHI = $_$

4. **116.5650512** **ENTER**

x

5. **ENTER**

-1.000000001

6. **ENTER**

y

7. **ENTER**

2.

8. **ENTER**

z

9. **ENTER**

-3.

10. **ENTER**

>

■ PROGRAM LIST

```

10:"A":INPUT "x=";X
20:INPUT "y=";Y
30:INPUT "z=";Z
40:R=SQR (X*X+Y*Y+Z*Z):
  IF R=0 PAUSE "r=0 Un
  defined":END
50:C=ASN (Z/R):IF X>0
  LET F=ATN (Y/X):GOTO
  80
60:A=(Y=0)+SGN Y:IF X=0
  LET F=A*ACS 0:GOTO 8
  0
70:F=ATN (Y/X)+A*ACS -1
80:WAIT :PRINT "r":
  PRINT R:PRINT "THETA
  ":PRINT C:PRINT "PHI
  ":PRINT F:END
90:"B":INPUT "r=";R
100:INPUT "THETA=";C
110:INPUT "PHI=";F
120:Y=R*COS C:X=Y*COS F:
  Y=Y*SIN F:Z=R*SIN C
130:WAIT :PRINT "x":
  PRINT X:PRINT "y":
  PRINT Y:PRINT "z":
  PRINT Z:END

```

300 Bytes

■ MEMORY CONTENTS

A	√
C	θ
F	φ
R	r
X	x-coordinate
Y	y-coordinate
Z	z-coordinate

■ FLOWCHARTS

(Orthogonal coordinates → Polar coordinates)

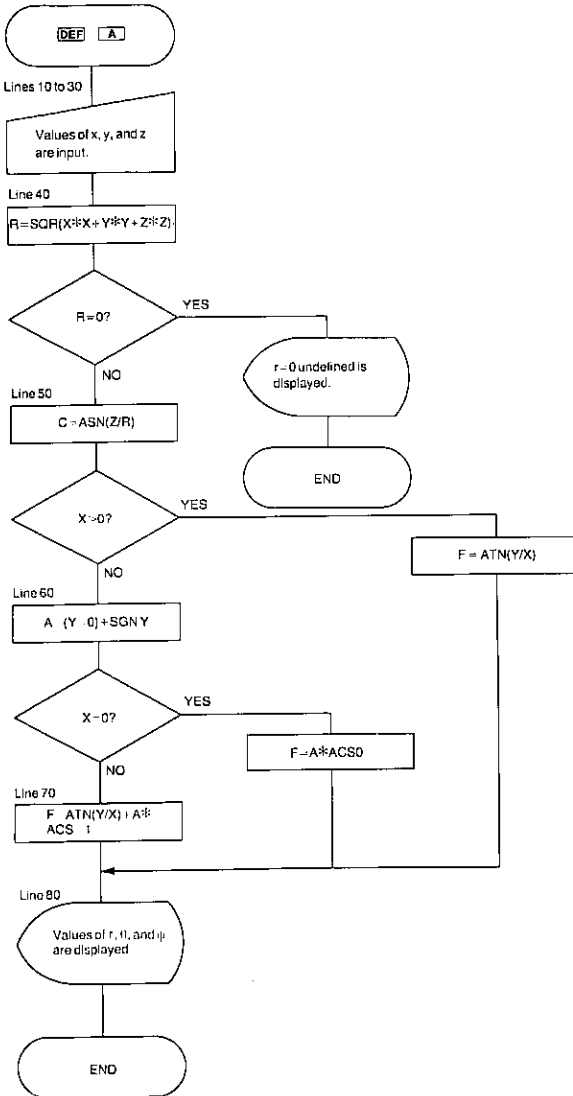

(Polar coordinates → Orthogonal coordinates)

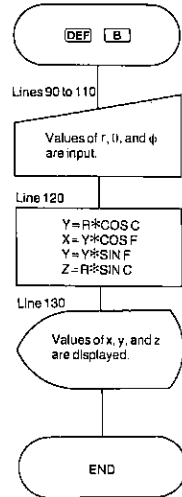

Any polygon is theoretically an aggregation of triangles. By utilizing this theory, let us calculate the area of a polygon. This program figures out the area of a polygon by dividing the polygon into triangles, calculating the area of each triangle, and obtaining the sum total of the areas of all the triangles.

■ HOW TO OPERATE

1. Press **DEF** **[A]** . (Program starts)
Input the number of vertexes (i.e., points) and the coordinates x and y of each vertex according to the display.
2. Next, press **DEF** **[B]** .
Input the vertex number (i.e., point number) of each of the three vertexes of the triangle according to the display, and the area of the triangle will be printed out. When you press **ENTER** before entering the vertex number, the sum total of the areas of all the triangles is output on the printer.
3. If you press **DEF** **[C]** , the sum total of all the triangle areas will be cleared and then the program ends.

Note: The number of vertexes may be stored up to the following limits:
255 vertexes

■ REMARKS

$$S = \sqrt{s(s-a)(s-b)(s-c)}$$

$$s = \frac{a+b+c}{2}$$

Area of triangle $S' = \frac{1}{2} hL$

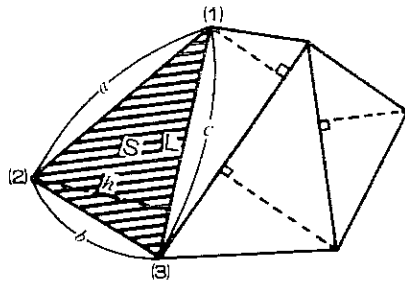

where
L: Base length (the longest of sides a, b, and c)
h: Height (Figures are truncated to three decimal places.)

■ EXAMPLE

Figure out the area of a 4-sided polygon as shown below.

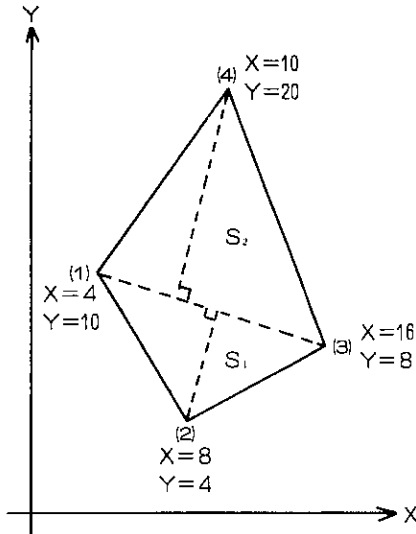

■ PRINTOUT

```

Point 1x= 4
Point 1y= 10
Point 2x= 8
Point 2y= 4
Point 3x= 16
Point 3y= 8
Point 4x= 10
Point 4y= 20
  1-2-3
A=          7.211
B=          8.944
C=         12.166
H=          5.260
S=        31.996580
  1-3-4
A=         12.166
B=         13.416
C=         11.662
H=          9.838
S=        65.993304

*TS*=      97.989884
    
```

■ KEY OPERATION SEQUENCE

<Input coordinates X and Y of each vertex>

1. **DEF** **A**

Numbers=_

2. 4 **ENTER**

Point 1x=

?

3. 4 **ENTER**

Point 1y=

?

⋮

Input data in the same manner as above.

⋮

4. 20 **ENTER**

>

<Input vertex (Point) Nos. of each triangle>

1. **DEF** **B**

Point=_

2. 1 **ENTER**

Point=_

3. 2 **ENTER**

Point=_

4. 3 **ENTER**

Point=_

5. 1 **ENTER**

Point=_

6. 3 **ENTER**

Point=_

7. 4 **ENTER**

Point=_

8. **ENTER**

>

<Clearing of sum total of triangle areas>

1. **DEF** **C**

**** TS CLEAR ****

>

■ PROGRAM LIST

```
10:"A":USING :CLEAR :
  WAIT 0
20:INPUT "Numbers=";N
30:IF N<1 BEEP 2:GOTO 2
  0
40:DIM X(N-1),Y(N-1),B$(
  (0))
50:FOR I=0 TO N-1
60:B$(0)="x=":GOSUB 360
70:INPUT X(I):B$(0)="x=
  "+STR$ X(I):GOSUB 3
  70:GOTO 90
80:N=I:END
90:B$(0)="y=":GOSUB 360
  :INPUT Y(I)
100:B$(0)="y= "+STR$ Y(I
  ):GOSUB 370:NEXT I
110:BEEP 1:END
120:"B":USING :INPUT "Po
  int=";0,"Point=";P,"
  Point=";Q:GOTO 140
130:GOTO 310
140:IF (Q<1)+(Q>N)+(P<1)
  +(P>N)+(Q<1)+(Q>N)<>
  0 GOTO 120
150:C=X(0-1):D=Y(0-1):E=
  X(P-1):F=Y(P-1):G=X(
  Q-1):H=Y(Q-1)
160:X=E-C:Y=F-D:GOSUB 33
  0
170:A=X:X=G-E:Y=H-F:
  GOSUB 330
180:B=X:X=C-G:Y=D-H:
  GOSUB 330
190:C=X:IF A>X LET X=A
200:IF B>X LET X=B
210:I=(A+B+C)/2:S=SQR (I
  *(I-A)*(I-B)*(I-C))
220:J= INT ((2*S/X)*10^3
  )/10^3:L=X:GOSUB 340
230:X=L:S=X*J/2:K=K+S:L=
  A:GOSUB 340
240:A=L:L=B:GOSUB 340
250:B=L:L=C:GOSUB 340
260:C=L:L=S:GOSUB 350
270:S=L:L=K:GOSUB 350
280:K=L:LPRINT " ";STR$
  0+"-"+STR$ P+"-"+
  STR$ Q
290:LPRINT "A= "; USING
  "#####.###";A
300:LPRINT "B= ";B:
  LPRINT "C= ";C:
  LPRINT "H= ";J:
  LPRINT USING "#####
  #####.#####";"S= "
  ;S:GOTO 120
310:LPRINT "":LPRINT "*T
  S*="; USING "#####
  ##.#####";K:END
320:"C":K=0:USING :PAUSE
  " ** TS CLEAR **":
  END
330:X=SQR (X*X+Y*Y):
  RETURN
340:L= INT (L*1000+.5)/1
  000:RETURN
350:L= INT (L*1000000)/1
  000000:RETURN
360:PAUSE "Point ";STR$
  (I+1);B$(0):RETURN
370:LPRINT "Point ";STR$
  (I+1);B$(0):RETURN
```

962 Bytes

■ MEMORY CONTENTS

A	a
B	b
C	x_1, \checkmark
D	y_1
E	x_2
F	y_2
G	x_3
H	y_3
I	S
J	h
K	Σs
L	\checkmark
N	Number of vertexes
O	\checkmark
P	\checkmark
Q	\checkmark
S	S
X	\checkmark
Y	\checkmark
X(N-1)	x-coordinate
Y(N-1)	y-coordinate
B\$(0)	\checkmark

■ FLOWCHARTS

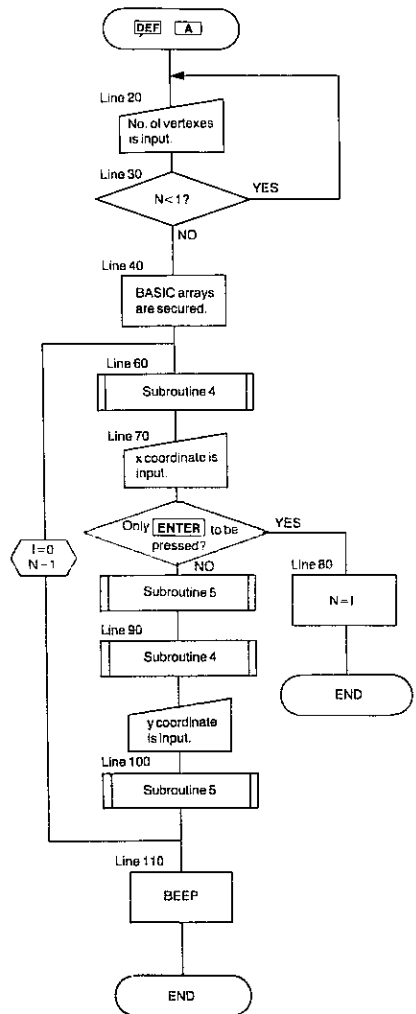

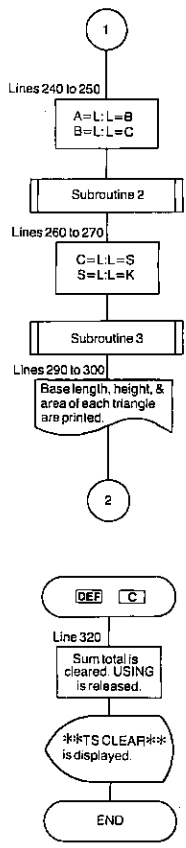
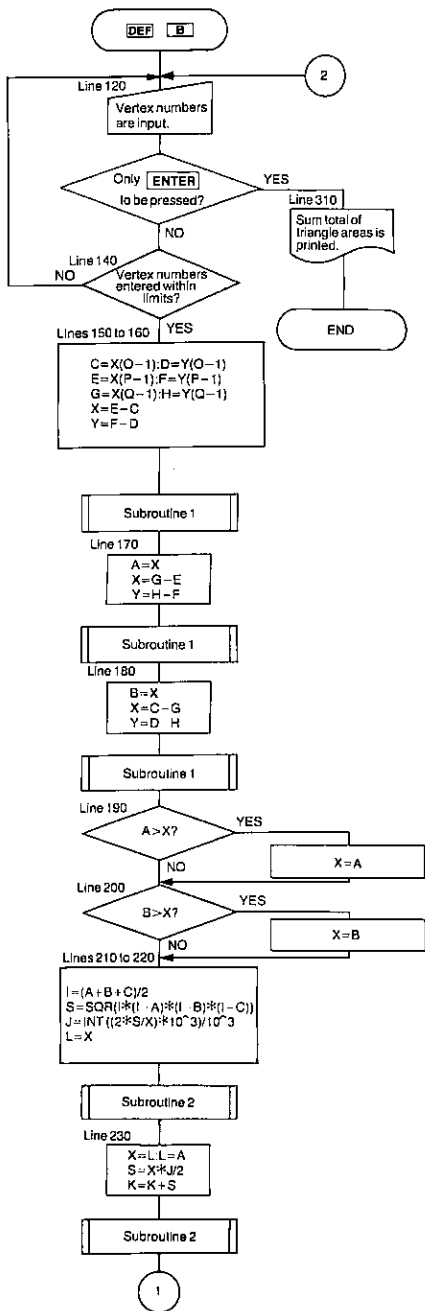

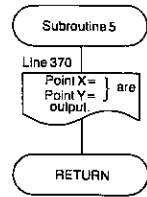
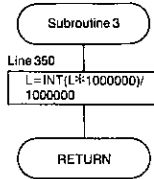
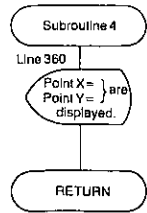
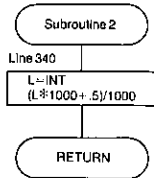
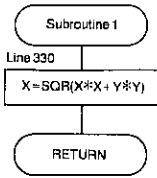

PROGRAM TITLE: A Circle Osculating Two Circles

There are two adjoining circles to both of which another circle is tenderly adhering. Will a warm feeling begin to bud there? Such a way of looking at these circles may bring a light touch to your study of geometry. This program finds out the center of a circle osculating two circles and the coordinates of the two points of contact by inputting the center coordinates and radius of each of the two circles together with three discriminating conditions.

■ HOW TO OPERATE

1. Press **DEF** **A** . (Program starts)
2. Input the center coordinates (x_1 and y_1) of circle C_1 and radius R_1 , the center coordinates (x_2 and y_2) of circle C_2 and radius R_2 , and the radius R of the circle osculating circle C_1 and C_2 according to the display.

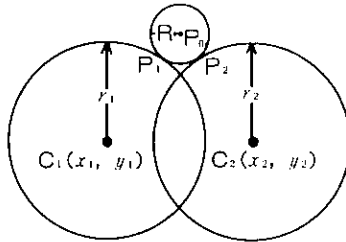

3. Then input the value of each of the following three discriminating conditions:

Conditions		Value
(1)	When the circle to solve with respect to circle C_1 is osculating externally	1
	When the circle to solve with respect to circle C_1 is osculating internally	-1
(2)	When the circle to solve with respect to circle C_2 is osculating externally	1
	When the circle to solve with respect to circle C_2 is osculating internally	-1
(3)	When the circle is on the left side as circle C_2 is viewed from circle C_1	1
	When the circle is on the right side as circle C_2 is viewed from circle C_1	-1

When all the above data is input, the center coordinates of the circle osculating circles C_1 and C_2 and the coordinates of points of contact P_1 and P_2 are displayed on the screen in the order named. Then, the program ends.

■ EXAMPLE

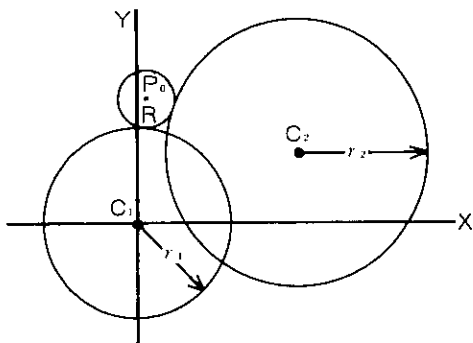

C1: $x_1=0, y_1=0, r_1=30$
 C2: $x_2=50, y_2=20, r_2=40$
 $R=10$

Discriminating conditions
 (1) 1 (osculating externally)
 (2) 1 (osculating externally)
 (3) 1 (on left side)

■ KEY OPERATION SEQUENCE

1. DEF A

C1 x=_

2. 0 ENTER

C1 y=_

3. 0 ENTER

C1 r=_

:

Input data in the same manner as above.

:

4. 10 ENTER

C1. OUT:1 IN:-1=_

5. 1 ENTER

C2. OUT:1 IN:-1=_

6. 1 ENTER

LEFT:1 RIGHT:1-1=_

7. 1 ENTER

P0 x= 4.08

8. ENTER

P0 y= 39.79

9. ENTER

P1 x= 3.06

10. ENTER

P1 y= 29.84

11. ENTER

P2 x= 13.27

12. ENTER

P2 y= 35.83

13. ENTER

>

PROGRAM LIST

```

10:"A":DEGREE:INPUT"C
  1 x=";A
20:INPUT"C1 y=";B
30:INPUT"C1 r=";Q
40:INPUT"C2 x=";D
50:INPUT"C2 y=";E
60:INPUT"C2 r=";P
70:INPUT"R=";S
80:INPUT"C1.OUT:1 IN:-
  1=";Q
90:INPUT"C2.OUT:1 IN:-
  1=";R
100:INPUT"LEFT:1 RIGHT:
  -1=";G
110:F=P+R*S:C=Q+Q*S:H=D-
  A:I=E-B:J=SQR(H*H+I
  *I):K=ACS(H/J):IF Q
  >I LET K=-K
120:L=ACS((C*C+J*J-F*F)
  /2/C/J)
130:N=K+G*L:M=A+C*COS N:
  N=B+C*SIN N:X=Q*(A-M
  ):Y=Q*(B-N):GOSUB 24
  0
140:IF((Q=-1)*(S>0))=1
  LET W=W+180
150:H=M+S*COS W:I=N+S*
  SIN W:X=R*(D-M):Y=R*
  (E-N):GOSUB 240
160:IF((R=-1)*(S>P))=1
  LET W=W+180
170:J=M+S*COS W:K=N+S*
  SIN W
180:M=M+SGN M*.005:N=N+
  SGN N*.005
190:H=H+SGN H*.005:I=I+
  SGN I*.005
200:J=J+SGN J*.005:K=K+
  SGN K*.005
210:PRINT"P0 x=";USING
  "#####.##";M:
  PRINT"P0 y=";N
220:PRINT"P1 x=";H:
  PRINT"P1 y=";I
230:PRINT"P2 x=";J:
  PRINT"P2 y=";K:END
240:W=ACS(X/SQR(X*X+Y*
  Y)):IF Q>Y LET W=-W
250:RETURN

```

653 Bytes

MEMORY CONTENTS

A	x_1
B	y_1
C	$\sqrt{\quad}$
D	x_2
E	y_2
F	$\sqrt{\quad}$
G	Discriminating condition (3)
H	P_1x
I	P_1y
J	P_2x
K	P_2y
L	$\sqrt{\quad}$
M	P_0x
N	P_0y
O	r_1
P	r_2
Q	Discriminating condition (1)
R	Discriminating condition (2)
S	R
W	$\sqrt{\quad}$
X	$\sqrt{\quad}$
Y	$\sqrt{\quad}$

■ FLOWCHART

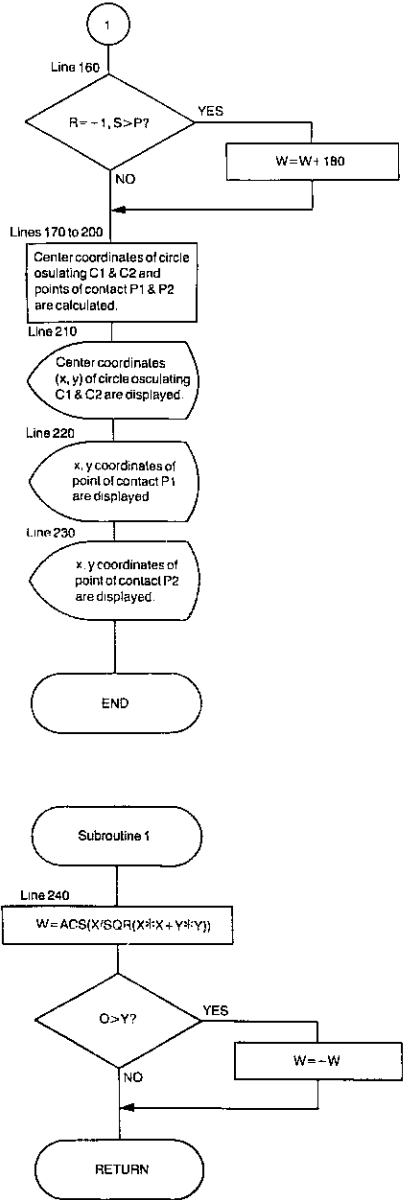
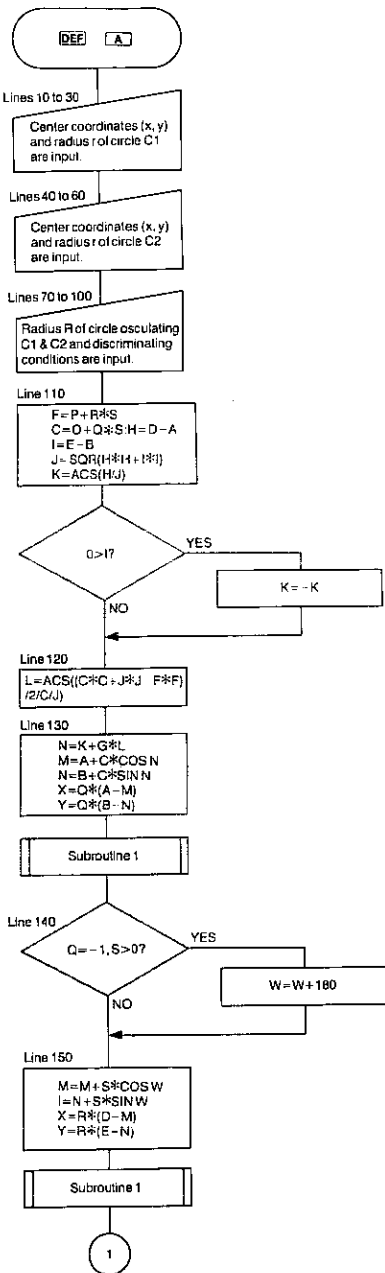

PROGRAM TITLE: Number Guessing Game

This program is designed to allow you to play a game of guessing a 3-digit number to be generated randomly from the computer. Don't study too much for examinations. Try this game for a change. Now, let us see how many attempts you must make before you can make a hit!

■ HOW TO OPERATE

1. Press **DEF** **A** . (Program starts)
2. "X=" will be displayed on the screen. Now, input a 3-digit number which you think the computer might have generated. Then, the screen will display the number of attempts you made and the 3-digit number you entered, followed by a comment (about 1 second later).

For example,

- Comment: 1 1

If the display reads as shown above, the first number (1) following comment tells you that one digit of the 3-digit number you have input matches the random number generated with respect to its digit position and value. The second number (1) tells you that one digit of the 3-digit number you have input matches the random number generated with respect to its value only.

- Comment: 3 0

If the display reads as shown above, all three digits of the number you have input match the random number generated with respect to their digit positions and values. When you make a hit, the message "VERY GOOD!" and the number of attempts you made before the hit appear on the screen. Then, the program ends.

Note: Remember you can only input a 3-digit number.

■ KEY OPERATION SEQUENCE

1. DEF [A]

X=_

2. 123 [ENTER]

1 123

Comment:0 1

X=_

3. 145 [ENTER]

2 145

Comment:1 0

X=_

Input data in the same manner as above.

4. 305 [ENTER]

6 305

Comment:3 0

VERY GOOD! 6

>

■ PROGRAM LIST

```

10:"A":CLEAR :RANDOM :Y
   =1
20:FOR A=2 TO 4:A(A)=
   RND 10-1:NEXT A:IF (
   B=C)+(C=D)+(D=B)<>0
   THEN 20
30:BEEP 1:INPUT "X=":X
40:USING :PAUSE Y:X
50:FOR A=6 TO 8:A(A)=X-
   INT (X/10)*10:X= INT
   (X/10):NEXT A
60:J=0:L=6:P=0
70:FOR A=2 TO 4:IF A(A)
   =A(L) LET J=J+1
80:GOSUB 110:GOSUB 110:
   M=F:F=G:G=H:H=M:L=L-
   2:NEXT A
90:PAUSE "Comment:"
   USING "####":J:P:IF
   J<>3 LET Y=Y+1:GOTO
   30
100:BEEP 2:PRINT "VERY G
   OOD ! ":Y:END
110:L=L+1:IF A(A)=A(L)
   LET P=P+1
120:RETURN
    
```

309 Bytes

■ MEMORY CONTENTS

A	✓
B	✓
C	3-digit number
D	✓
F	✓
G	✓
H	✓
J	Comment
L	✓
M	✓
P	Comment
X	Input value
Y	Number of attempts

INDEX

&	77	CE-126P	103
*	86	Cell replacement	11
+	86	CHAIN	134
-	86	CHR\$	185
/	86	CLEAR	136
	86	CLOAD	115
$\sqrt{\quad}$	183	CLOAD?	116
<	86	Clear key	17
◀	57	CONT	117
<=	86	COS	180
◁▷	86	CSAVE	118
=	86	CUR	180
>	86	Cursor	9
▶	57	Cassette tape	110
>=	86	Character Code Chart	197
π	178	Commands	92
↑	94	DATA	137
↓	94	DEF key	101
A() variables	84	DEG	180
ABS	179	DEGREE	138
ACS	179	DELETE	119
AHC	179	DELeTe key	95
AHS	179	DIM	139
AHT	179	Direct calculation feature	74
ALL RESET	10	DMS	180
AND	87	Debugging	189
AREAD	131	Display	20
ASC	185	END	141
ASN	180	ENTER key	56
ATN	180	EXP	181
Array variables	81	Edition calculations	56
Auto off (Auto Power Off)	15	Editing programs	94
BASIC key	7	Error Messages	193
BASIC mode	8	Expressions	85
BEEP	133	FACT	181
CA key	205	Fixed variables	79
CAL key	7	FOR..TO...STEP	142
CAL mode	8	Formatting output	199
C.CE key	205	Functions	90

GOSUB	144	ON...GOSUB	157
GOTO	120, 145	ON...GOTO	158
GRAD	146	OR	87
Hard cover	4	Operator priority (BASIC) mode	203
HCS	181	Operators	86
HSN	181	P ↔ NP	104
HTN	181	PASS	127
IF...THEN	147	PAUSE	159
INKEY\$	176	PI	178
INPUT	148	PRINT	161
INPUT#	150	PRINT#	163
INSert key	59	PROgram mode	7
INT	181	Parentheses	89
LEFT\$	185	POL	182
LEN	185	Printer	103
LET	153	Priority (CAL mode)	29
LIST	121	Program	91
LLIST	122	Pseudovariables	176
LN	181	RADIAN	165
LOG	181	RANDOM	166
LPRINT	154	RCP	182
Labeled programs	101	READ	167
Last answer feature	68	REC	182
Limits of numbers	67	Relational expressions	86
Line numbers	91	REM	168
Linear regression	37	RENUM	128
Logical expressions	87	RESET	10
MATRIX operations	44	RESTORE	169
MEM	177	RETURN	170
MID\$	186	RIGHT\$	186
Maintenance	191	RND	182
Manual calculations	55	RUN	130
Masks	199	RUN mode	90
MDF	155	Range of numbers	67
Memory Protection	127	Relational expressions	86
MERGE	123	ROT	183
NEW	126	Scientific notation	66
NEXT	156	SGN	183
NOT	87	SHIFT key	16
Numeric expressions	86	Simple variable	80
Numeric functions	179	SIN	183
Numeric variables	79	Single-variable statistics	36
ON (Start up)	15	SQR	183

SQU	183
STOP	171
STR\$	186
Statements	91
Statistical calculations	35
String expressions	86
String function	185
String variables	79
Subroutines	144
TAN	184
TEN	184
TROFF	172
TRON	173
Tape Recorder	105
Template	102
Troubleshooting	187
Two-variable statistics	37
USING	174
VAL	186
Variables	78
Verbs	92, 113, 131
WAIT	175

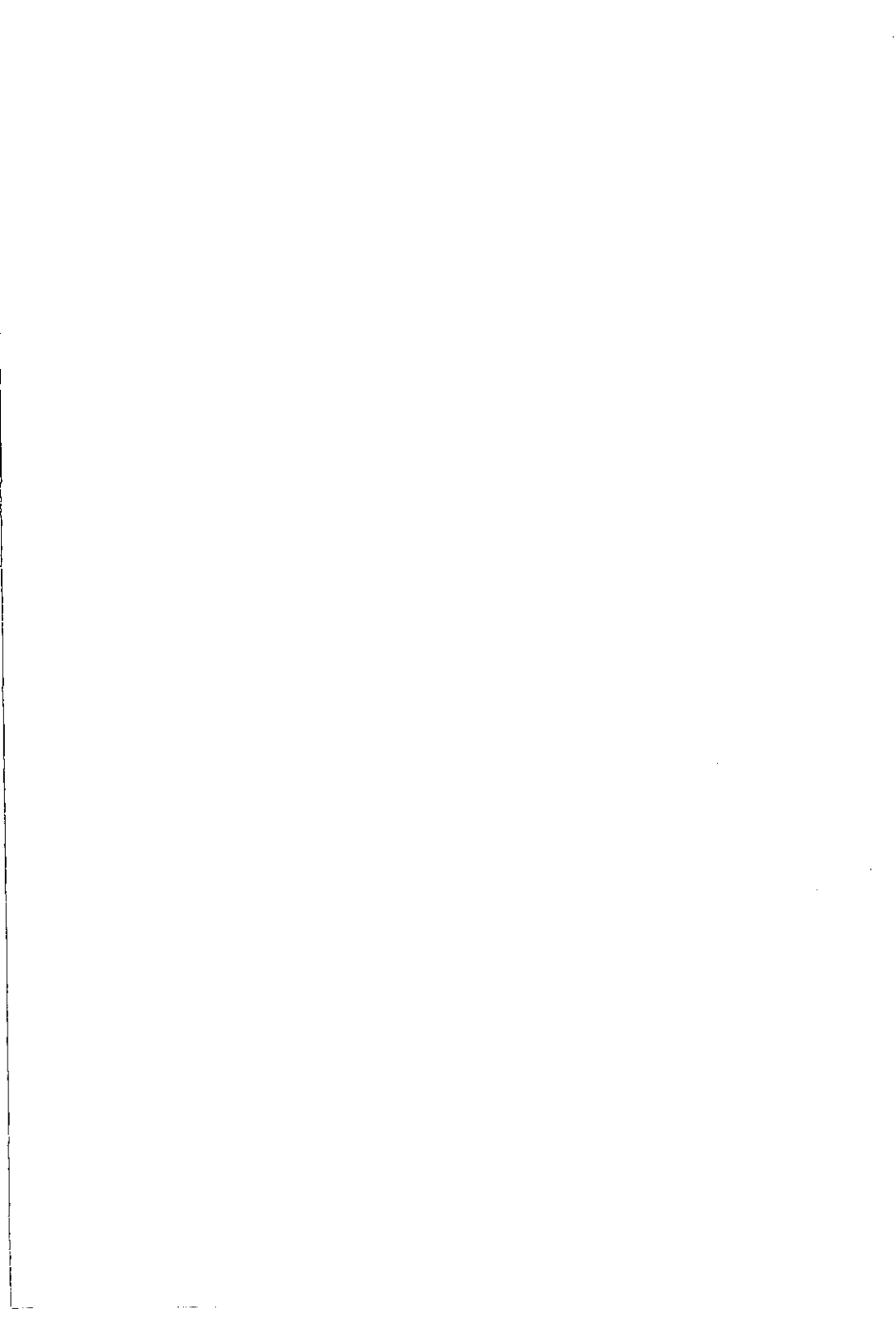

SHARP CORPORATION

OSAKA, JAPAN

1986 © SHARP CORPORATION
PRINTED IN JAPAN/IMPRIMÉ AU JAPON
1G0.5T(TINSE1066ECZZ) 10