

CASIO®

# OWNER'S MANUAL

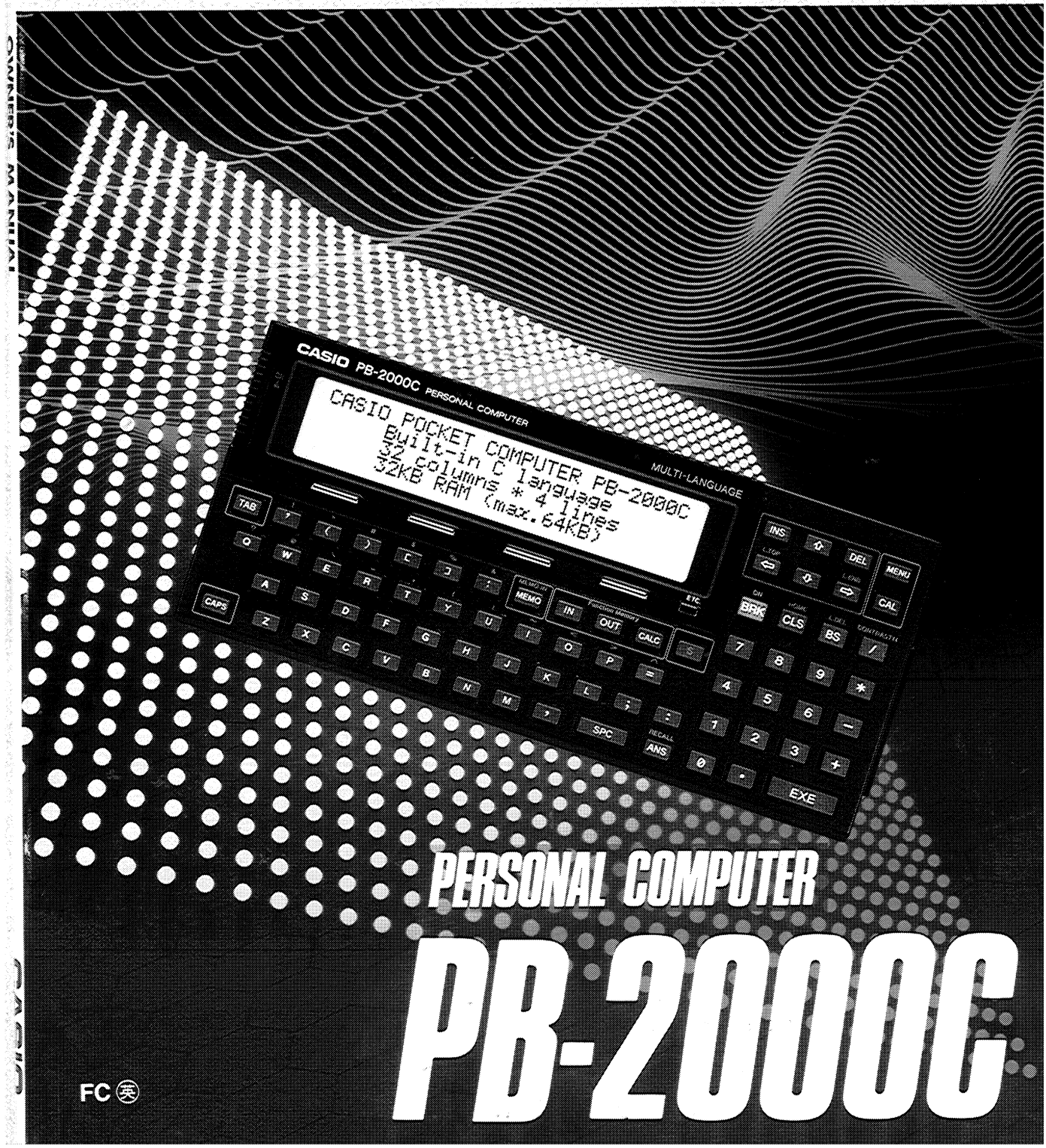

## PERSONAL COMPUTER **PB-2000C**

FC (英)

**CASIO®**

# **OWNER'S MANUAL**

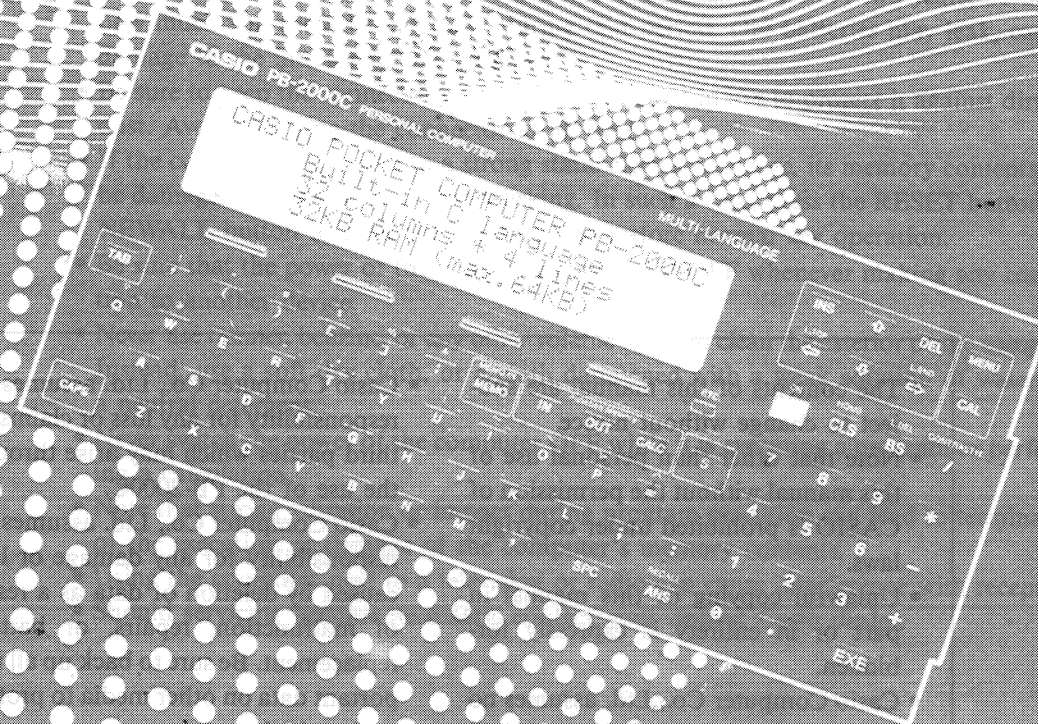

**PERSONAL COMPUTER**  
**PB-2000C**

## Introduction

Congratulations upon your selection of the Casio PB-2000C C programming language computer. This manual covers the basic operation, calculation function, formula memory function, data bank function, and peripherals of the PB-2000C. For detailed information on the C function, please refer to the separate Introduction to the C Programming Language manual supplied with the PB-2000C.

Always keep this manual in a safe place for reference when using the PB-2000C.

- |   |  |
|---|--|
| <ul style="list-style-type: none"> <li>• The contents of this manual are subject to change without notice.</li> <li>• Note that other than personal use of this manual without the permission of CASIO is prohibited under copyright laws.</li> <li>• Unlawful copying of this manual in part or in entirety is expressly forbidden.</li> <li>• Casio Computer Co., Ltd. assumes no responsibility for any damage or loss resulting from the use of this manual.</li> </ul> | <ul style="list-style-type: none"> <li>• Casio Computer Co., Ltd. assumes no responsibility for any loss or claims by third parties which may arise through the use of the PB-2000C.</li> <li>• Casio Computer Co., Ltd. assumes no responsibility for any damage or loss caused by deletion of data as a result of malfunction, repairs, or battery replacement. Be sure to back up all important data on other media to protect against its loss.</li> </ul> |
|---|--|

## Precautions

Your PB-2000C is made possible thanks to Casio's advanced engineering and stringent quality controls. Carefully note the following precautions to ensure that your PB-2000C gives you the many years of outstanding performance for which it is designed.

- Your computer is composed of precision electronic components. Never try to take it apart.
- Do not drop the computer, and avoid strong impact and sudden temperature changes. Be especially careful to avoid exposure to high temperatures, humidity, and dust.
- The response of the display may slow down or even fail completely in extremely low temperatures. This is no need for worry, because normal operation should return when the unit warms up.
- Never connect any type of devices to the connector besides those expressly specified in this manual.
- Be sure to replace the batteries of the computer at least once every two years, no matter how much you used the computer during that period. Old batteries may leak, causing damage to the interior of the computer.
- Be sure to keep the connector covered when it is not in use to protect it against dirt and dust. Avoid touching the connector at all times.
- If the computer is exposed to a strong static electrical charge, its memory contents may be damaged or the keys may stop working. In such a case, press the RESET button and NEWALL button to clear the memory and restore normal key operation.
- Be sure that the power of the computer is switched OFF whenever making any connection to another device.
- Never use thinner, benzine, or any other volatile agent to clean the exterior of the computer. Instead, use a soft dry cloth, or a cloth dampened with a weak solution of water and a neutral detergent.
- Never switch the power of the computer OFF while it is executing a program or performing a calculation.
- Note that strong vibration or impact during program execution can lead to termination of the execution or damage of the computer's memory contents.
- Using the computer next to a television or radio can cause interference with reception.
- Should servicing become necessary, contact your nearest Casio dealer.

## About this manual

This manual explains the basic operation of the PB-2000C, along with a simple introduction to C. In addition, you will find important information on using the PB-2000C's calculation, formula memory, and data bank function, as well as how to connect with optional devices.

Chapter 1 is titled **Getting Acquainted** because it provides you with the basic information you need to begin to use the PB-2000C effectively. Included are the system configuration, a general guide that describes each key and its function, and a full explanation of the keyboard.

Chapter 2 is called **Getting Started** because it is at this point that you actually switch the PB-2000C on and start some hands-on operation. Here, you will learn how to use the C function, the calculator function, the formula memory function and the data bank function.

We called Chapter 3 **Getting Bigger** because in this chapter you will be introduced to the versatile expandability of the PB-2000C with the addition of a number of optional equipment. You will see how the PB-2000C can be made much more powerful with the addition of optional ROM cards, an expansion RAM pack, an interface unit, and printers.

Chapter 4 is titled **Getting Technical**, since it contains such technical information as a character code table and error message table.

We strongly recommend that you read this manual first to acquaint yourself with the basic operation of the PB-2000C before moving on to the Introduction to the C Programming Language manual.

## Contents

Introduction .....	ii
Precautions .....	iii
About this manual .....	iv

---

### Chapter 1 Getting Acquainted 1

---

<b>1-1 Unpacking</b> .....	2
<b>1-2 General guide</b> .....	2
Key functions .....	3
Using the hard case .....	6
<b>1-3 Power supplies</b> .....	7
To replace the main power supply batteries .....	7
To replace the backup power supply battery .....	8
To connect the optional AC adaptor .....	8
The Auto Power OFF function .....	9
<b>1-4 Resetting the computer</b> .....	9
To reset the hardware (RESET) .....	9
To reset the hardware and clear memory (NEWALL) .....	10
<b>1-5 Adjusting the display contrast</b> .....	10
To adjust the display contrast .....	10
<b>1-6 About the keyboard</b> .....	11
Using the accessory overlay .....	12
<b>1-7 How data is displayed</b> .....	12
About the display .....	12
Physical lines and logical lines .....	13
About the virtual screen .....	14

---

### Chapter 2 Getting Started 15

---

<b>2-1 About menus and modes</b> .....	16
To switch power ON .....	16
To display the function key menu (MENU mode) .....	16
To display the next function key menu .....	17
Basic operation of the calculator function (CAL mode) .....	18
Basic operation of the formula memory function (CAL mode) .....	19
Basic operation of the data bank function (MEMO IN mode) .....	20

<b>2-2 Using the C function</b> .....	<b>22</b>
To use the C interpreter.....	22
To use the C editor.....	22
<b>2-3 Using the calculator function</b> .....	<b>23</b>
Entering operators.....	23
How calculation results are displayed.....	23
Using variables correctly.....	24
Performing manual calculations.....	24
To perform arithmetic calculations.....	24
To enter a value as a negative.....	25
To enter an exponent.....	25
To use a result at the beginning of the next calculation.....	25
To use a result within the next calculation.....	26
Performing calculations using variables.....	26
To perform a calculation using variables.....	26
Editing formulas.....	27
To insert a character.....	27
To delete a character using [DEL].....	28
To delete a character using [ES].....	28
To delete a series of characters.....	29
Performing scientific function calculations.....	29
Trigonometric and inverse trigonometric functions.....	30
Hyperbolic and inverse hyperbolic functions.....	32
Logarithmic and exponential functions.....	33
Decimal↔Hexadecimal conversion.....	34
Decimal↔Sexagesimal conversion.....	34
<b>2-4 Using the formula memory function</b> .....	<b>36</b>
To store a formula.....	36
To recall a formula.....	37
To execute a formula.....	37
To edit a stored formula.....	37
To clear the formula memory.....	38
<b>2-5 Using the data bank function</b> .....	<b>39</b>
To enter the MEMO IN mode.....	39
To enter data into the data bank.....	39
Editing data bank data.....	41
To scroll through and select data bank records.....	41
To insert a record between two existing records.....	41
To edit the data in a record.....	42
To delete a record.....	43

Locating specific data in the data bank.....	43
To locate specific data in the data bank.....	44
To search for data in the CAL mode.....	45
To delete a data bank file.....	45
Sample data bank applications.....	47
Telephone Directory.....	47
Using the data bank with the formula memory function.....	48
<b>2-6 Using files</b> .....	<b>49</b>
What is a "file"?.....	49
About filenames.....	49
About the file display.....	49
To load a file.....	50
Using preset files.....	50
Using an automatic execute file.....	50
<b>2-7 Using the menus</b> .....	<b>51</b>
About the menu display.....	51
How to use each menu selection.....	51
[c ].....	51
[newc ].....	51
[edit ].....	51
[disk ].....	51
[name ].....	53
[kill ].....	54
[load ].....	54
[save ].....	61
[data ].....	66
[l]list ].....	68
[merge ].....	68
[preset ].....	68
[C/S ].....	70
[set ].....	71
[memory].....	72

---

**Chapter 3 Getting Bigger 75**

---

<b>3-1 Optional ROM cards</b> .....	<b>76</b>
Loading an optional ROM card.....	76
To remove a ROM card from the computer.....	76
To load a ROM card into the computer.....	77

<b>3-2 RP-33 expansion RAM pack</b> .....	<b>78</b>
Loading the RAM pack.....	78
To load the RAM pack.....	79
<b>3-3 MD-100 Interface Unit</b> .....	<b>80</b>
To connect the computer to the MD-100.....	80
Using floppy disks.....	81
To load a floppy disk into the drive.....	81
To remove a floppy disk from the drive.....	81
Formatting disks.....	82
To format a disk.....	82
RS-232C interface.....	82
Baud rate.....	83
Centronics interface.....	84
<b>3-4 FA-7 Interface Unit</b> .....	<b>85</b>
To connect the computer to the FA-7 interface unit.....	85
Using the cassette interface.....	86
To connect a tape recorder to the interface unit.....	86
Load operation troubleshooting.....	87
RS-232C interface.....	87
Centronics interface.....	87
<b>3-5 FP-100 Plotter Printer</b> .....	<b>88</b>
To connect the computer to the FP-100 plotter printer.....	88
<b>3-6 FP-40 Character Printer</b> .....	<b>89</b>
To connect the computer to the FP-40 printer.....	89

---

**Chapter 4 Getting Technical 91**

---

<b>Error messages</b> .....	<b>92</b>
<b>Character code table</b> .....	<b>94</b>
<b>Order of operations</b> .....	<b>95</b>
<b>Digit capacities</b> .....	<b>95</b>
<b>Rounding</b> .....	<b>95</b>
<b>Specifications</b> .....	<b>96</b>
<b>Index</b> .....	<b>98</b>

---

# Chapter 1

---

## Getting Acquainted

**C**hapter 1 provides you with the basic information you need to begin to use the PB-2000C effectively. Included are the system configuration, a general guide that describes each key and its function, and a full explanation of the keyboard. If you are already familiar with the operation of a pocket computer, you can skim through this section picking up any pointers you need.

---

## 1-1 Unpacking

When unpacking the PB-2000C, be sure to check that all of the following items are included. If something is missing, contact your dealer immediately.

1. PB-2000C
2. Hard case
3. Owner's Manual
4. Introduction to the C Programming Language manual
5. Three CR2032 lithium batteries for main power supply
6. One CR1220 battery for backup power supply
7. Dummy card (to protect ROM card connectors)
8. C command overlay sheet

## 1-2 General guide

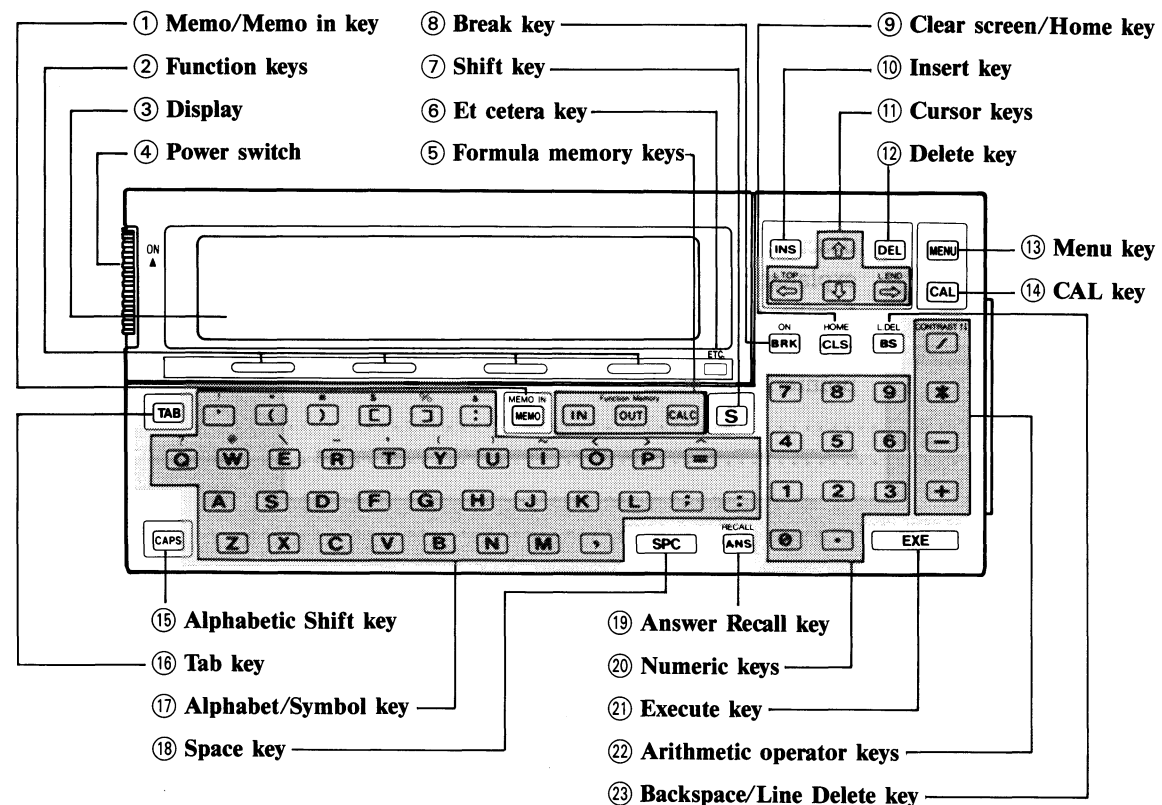

## Key functions

- ① **Memo/Memo in key** (MEMO IN)  
Use to input memo data, search for memo data, etc. See Chapter 2 for details.
- ② **Function keys** ( ) ( ) ( ) ( )  
Use to execute the functions shown at the bottom of the display in the function key menu, or the preset files in preset filename menu of the CAL mode.
- ③ **Display**  
32-column × 4-line (192 × 32 dots) dot matrix (6 × 8 dots/character) display.
- ④ **Power switch**  
Slide in the direction indicated by the arrow to switch power ON, and in the opposite direction to switch power OFF.
- ⑤ **Formula memory keys** (IN, OUT, CALC)  
These keys are used with the formula memory function. See Chapter 2 for details.
- ⑥ **Et cetera key** (ETC)  
Use to change the menu display for each function in the menu mode.
- ⑦ **Shift key** (S)  
Use to change the character or function of each key to the one marked above the key (i.e. **SHIFT** Q inputs the character ?, **SHIFT** A inputs the function **static**). You can cancel a shift without entering anything (and change the cursor back to normal) by pressing **SHIFT** again.  
(Throughout this manual, this key is represented by **SHIFT** in order to distinguish it from the alphabetic **S** key.)
- ⑧ **Break key** (ON BRK)  
Use to interrupt such operations as execution of programs and output to a printer. Also, press this key to restore power when it is interrupted by the Auto Power OFF function (see page 9).
- ⑨ **Clear screen/Home key** (HOME CLS)  
Use to clear all characters and symbols from the virtual screen (see page 14) and bring the cursor to the upper left corner of the display. Press this key following **SHIFT** to bring the cursor to the upper left corner (HOME position) of the virtual screen (see page 14) without clearing it. Note that this key cannot be used while the computer is in the MENU mode.  
While the computer is in the C interpreter or C editor, press this key to clear the logical line in which the cursor is currently located. See the Introduction to the C Programming Language manual for details on using the C interpreter and C editor.

⑩ **Insert key (INS)**

Use to insert a space at the current cursor location. If you hold down this key, spaces are repeatedly inserted at high speed until you release the key.

While the computer is in the C editor, press this key to switch between insert and overwrite. See the Introduction to the C Programming Language manual for details on using the C editor.

⑪ **Cursor keys (←<sup>TOP</sup>, →<sup>END</sup>, ↑, ↓)**

Each time you press these keys, the cursor moves respectively one line-up/down, or one character left/right on the display. Holding any of these keys down moves the cursor in the respective direction at high speed. In the MENU mode, use these keys to specify a file (see page 49).

SHIFT ←<sup>TOP</sup> moves cursor to beginning (LINE TOP) of the logical line in which the cursor is currently located. SHIFT →<sup>END</sup> moves cursor to end (LINE END) of the logical line in which the cursor is currently located.

⑫ **Delete key (DEL)**

Use to delete the character at the current cursor location. All of the characters to the right of the cursor position are shifted to the left to fill in the space created by the deletion. Holding this key down repeatedly deletes characters at high speed until you release the key.

⑬ **Menu key (MENU)**

Use this key in the MENU mode to display the names of all of the files currently stored in the memory of the computer.

⑭ **CAL key (CAL)**

Use this key in the CAL mode to perform formula memory calculations or scientific function calculations.

⑮ **Alphabetic Shift key (CAPS)**

Use to switch from the default option uppercase alphabetic characters to lower-case. The lower-case selection remains in effect until you press this key again.

⑯ **Tab key (TAB)**

Use to move the cursor a preset number of spaces from its current location. See page 71 for details on setting the tab value.

⑰ **Alphabet/Symbol keys**

Use to enter alphabetic characters and symbols.

⑱ **Space key (SPC)**

Use to enter a space.

⑲ **Answer Recall key (RECALL ANS)**

Use this key in the CAL mode to recall the last calculation result obtained with a manual calculation.

⑳ **Numeric keys (0~9, .)**

Use to enter numeric values.

㉑ **Execute key (EXE)**

Use to obtain the result of a manual calculation, to enter data, and to evaluate a C program.

㉒ **Arithmetic operator keys (/, \*, -, +)**

Use these keys to enter the four arithmetic operators for addition (+), subtraction (-), multiplication (\*) and division (/).

㉓ **Backspace/Line Delete key (←<sup>DEL</sup> BS)**

Use to delete the character to the left cursor location. All of the characters to the right, from the cursor position are shifted to the left to fill in the space created by the deletion. Following SHIFT, pressing this key deletes all of the characters to the right, from the cursor position.

<Right side>

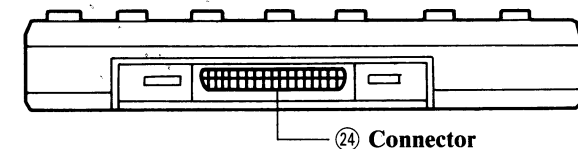
㉔ **Connector**

This connector is used only when connecting the computer to an interface unit (MD-100 or FA-7). Keep this connector covered whenever it is not being used.

<Bottom>

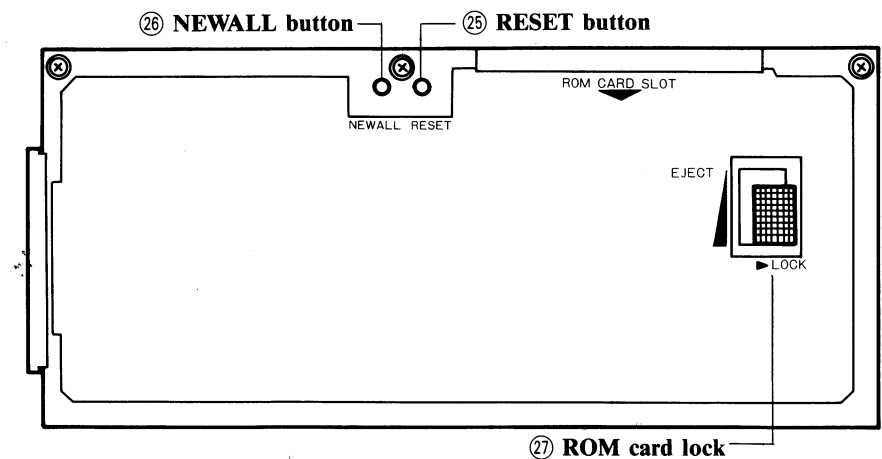



②⑤ **RESET button** (RESET)

Use this button to perform a hardware reset and initialize the computer after an operational failure caused by static electricity (see page 9 for procedure).

②⑥ **NEWALL button** (NEWALL)

Use this button to clear all data and programs currently stored in the memory of the computer (see page 10 for procedure).

②⑦ **ROM card lock**

Slide in the direction of the arrow marked LOCK to lock a ROM card in the computer, and in the direction of the arrow marked EJECT to eject a ROM card from the computer.

<Top >

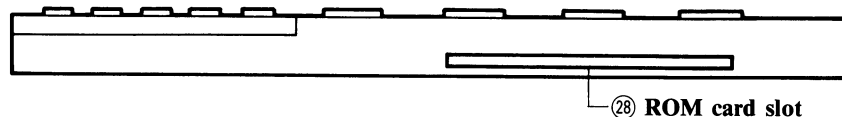

②⑧ **ROM card slot**

Load optionally available ROM cards into the computer by inserting them into this slot. Ensure that the ROM card is positioned correctly when loading, and never force it.

**Using the hard case**

You can insert the computer into and remove it from the accessory hard case as illustrated below. The computer must be inside of the accessory hard case whenever it is connected to the optional MD-100 or FA-7 interface unit.

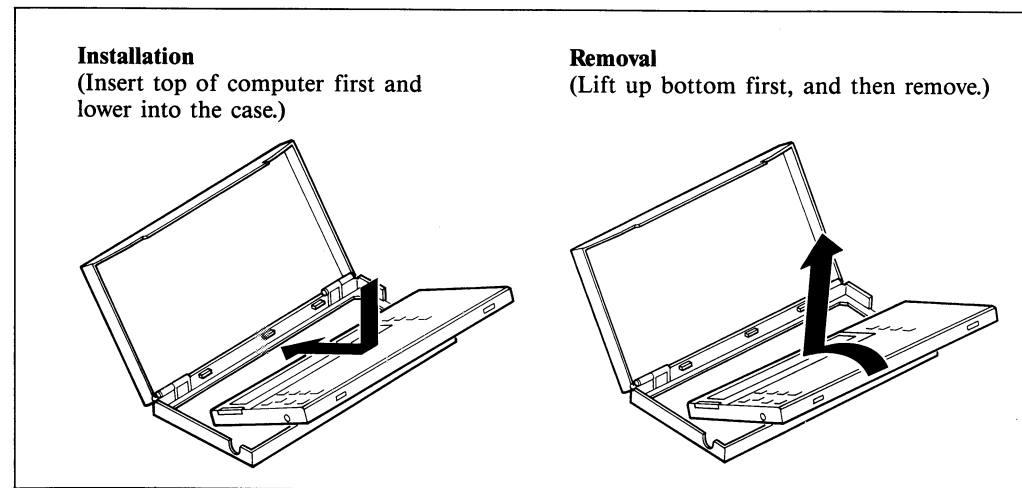

**1-3 Power supplies**

Three CR2032 lithium batteries power the main power supply of the PB-2000C, and one CR1220 lithium battery provides memory backup power. In place of the main power supply batteries, the PB-2000C can also be powered by an optional AC adaptor (AD-4175). Replace batteries using the procedure described below when the display becomes dim during program execution, even after you adjust contrast (see page 10), or every two years regardless of how much you have used the computer during that period.

- To avoid the loss of programs and data stored in memory, never remove both the main power supply batteries (or disconnect the AC adaptor) and the backup power supply battery at the same time.
- If, for some reason, both the main power supply batteries and the backup power supply battery are removed from the computer or fail to supply power simultaneously, you will have to reset the computer after you replace batteries (see **Resetting the computer**).

**To replace the main power supply batteries**

1. Switch the power of the computer OFF, remove the three screws holding the back cover in place, and then remove the back cover.

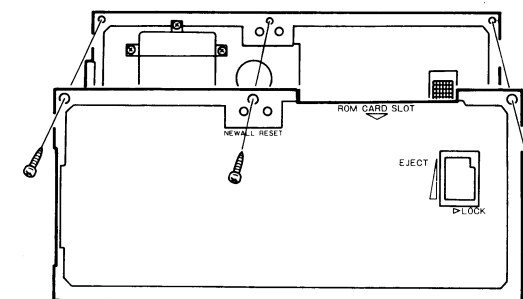

2. Remove screw A that holds the main battery holder in place, and then remove the main battery holder.

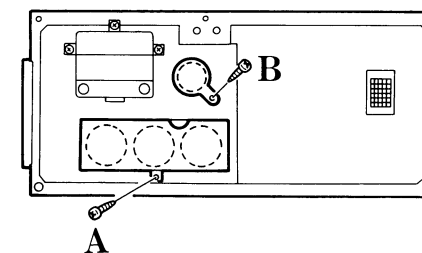

3. Turn the computer over and the battery should drop out easily.
4. Load a new set of three batteries after wiping them off with a soft, dry cloth. Load them into the computer ensuring that their positive ⊕ poles are facing up.

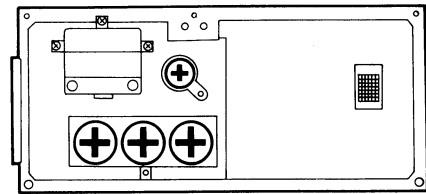

5. Replace the main battery holder and secure it in place using screw **A**.
6. Replace the back cover of the computer and switch power ON.

- Since the backup battery was not removed during this procedure, all program and data stored in memory should still be present.

### To replace the backup power supply battery

1. Switch the power of the computer OFF, remove the three screws holding the back cover in place, and then remove the back cover.
2. Remove screw **B** that holds the backup battery holder in place, and then remove the backup battery holder.
3. Turn the computer over and the batteries should drop out easily.
4. Load a new battery after wiping it off with a soft, dry cloth. Load it into the computer ensuring that its positive ⊕ pole is facing up.
5. Replace the backup battery holder and secure it in place using screw **B**.
6. Replace the back cover of the computer and switch power ON.

### To connect the optional AC adaptor

1. Plug the AC adaptor into a standard household AC outlet (mains).
2. Ensuring that the power of the computer is switched OFF, insert the plug of the AC adaptor into the ADP jack on the side of the computer.

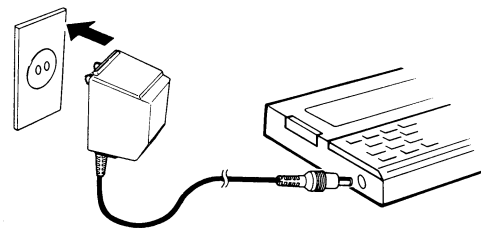

### Important

Note the following points concerning the power supplies of the PB-2000C.

- Be sure of the following point to avoid trouble with operation or damage to the computer due to leaking of battery fluid:
  - ▶ Be sure that batteries are loaded with their positive ⊕ poles facing up.
  - ▶ Never mix battery types.
  - ▶ Never mix old and new batteries.
  - ▶ Danger! Never charge, short, or try to disassemble batteries, and do not subject them to strong heat.
- Never dispose of batteries by burning them. This can cause the batteries to explode.
- The computer will switch off automatically to protect memory contents when the power of the main power supply batteries drops below a certain level. Should this happen, immediately replace batteries or connect the AC adaptor.
- *Keep batteries out of the reach of small children. If a battery is accidentally swallowed, contact a physician immediately.*

### The Auto Power OFF function

- The Auto Power OFF function of you PB-2000C helps you conserve valuable power by automatically switching power OFF if no operation is performed for a preset period of time.
- The default option for the Auto Power OFF time is 6 to 7 minutes, but you can specify a different time using the procedure described on page 71.
- Activation of the Auto Power OFF function does not affect memory contents.
- To restore power that has been cut off by the Auto Power OFF function, press the **BRK** key. If the **BRK** key does not restore power, it may indicate that battery power is low (see page 7).

## 1-4 Resetting the computer

The PB-2000C has both a hardware reset (RESET) and a combined hardware/memory reset (NEWALL).

### To reset the hardware (RESET)

1. Switch the power of the computer ON.
2. Hold down the RESET button with a thin, pointed object.

- The above operation should be performed when the computer stops working or when program execution suddenly halts because of the presence of large amounts of static electricity. The RESET operation does not affect memory contents.

## To reset the hardware and clear memory (NEWALL)

**First a word of warning:** The following operation will clear all of the data and programs stored in the memory of the PB-2000C. Be sure that you no longer need anything that is in memory or that you have another record of it before proceeding with the following operation.

1. Switch the power of the computer ON.
2. Hold down the NEWALL button with a thin, pointed object.

- The computer should enter the CAL mode after the memory contents are cleared.
- If it appears that the contents of the memory are not cleared after you perform this operation, perform the RESET operation first, and then the NEWALL operation again.

## 1-5 Adjusting the display contrast

Use the following procedure to adjust the contrast of the display to make it easier to read.

### To adjust the display contrast

1. Press **SHIFT** followed by the **CONTRAST++** key.
2. Press **↑** to make the screen darker, or **↓** to make it lighter.

- If the display fails to become darker when you press the **↑** key, it may indicate that battery power is low. In this case, replace batteries as soon as possible (see page 7).

## 1-6 About the keyboard

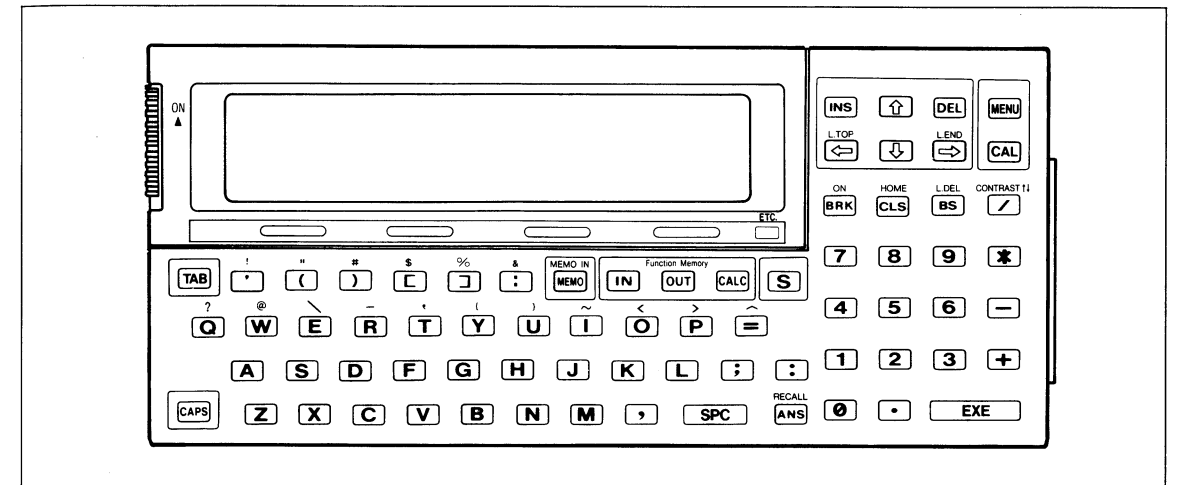

The PB-2000C features two shift keys. You should use the **CAPS** key to shift between uppercase and lowercase characters.

The **SHIFT** key, on the other hand, is used to enter special symbols and C functions directly from the keyboard. Note the following:

Key input	Result
<b>A</b>	A (immediately following NEWALL)
<b>CAPS A</b>	a
<b>SHIFT A</b>	static

## Using the accessory overlay

A special keyboard overlay comes with your PB-2000C to make it possible for you to easily keep track of the C commands that can be entered following the **SHIFT** key. Simply place the overlay on the keyboard during C programming and remove it during normal operation.

### Overlay sheet

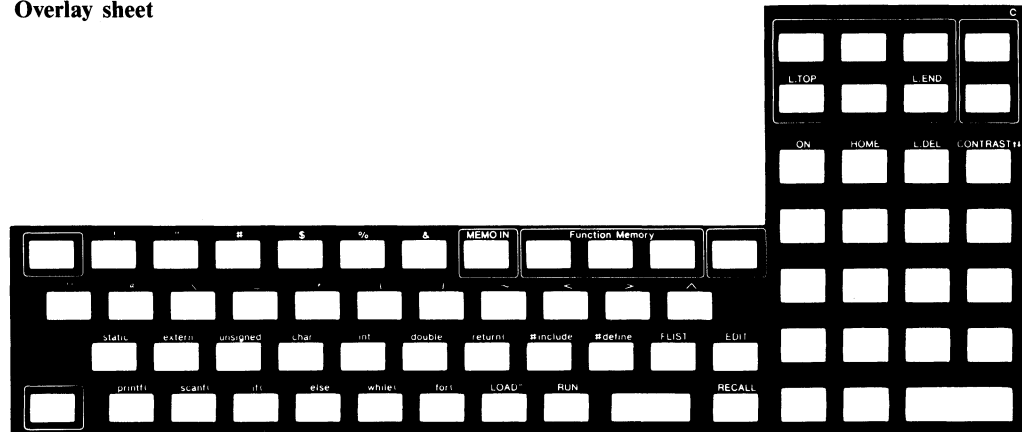

## Physical lines and logical lines

You must remember to distinguish in your mind between physical lines and logical lines.

A **physical line** is a line of characters as they appear on the display. Since the capacity of the display is 32 columns  $\times$  4 lines, the maximum length of a physical line is 32 characters.

A **logical line**, on the other hand, is defined as a line of characters as handled internally by the computer.

Each logical line can consist of several physical lines, and the maximum length of a logical line is 255 characters.

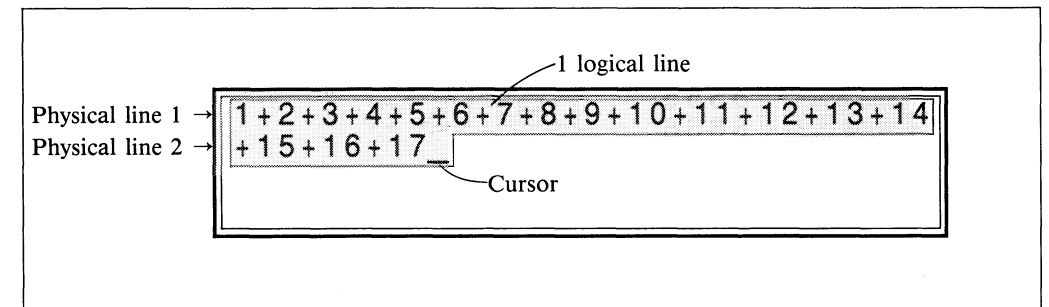

Note that the operation **SHIFT** **←** moves the cursor to the beginning of the logical line, while **SHIFT** **→** moves it to the end of the logical line.

## 1-7 How data is displayed

### About the display

The display of the PB-2000C contains 32 columns and 4 lines (192  $\times$  32 dots). Each character is made up from a 6  $\times$  8-dot matrix.

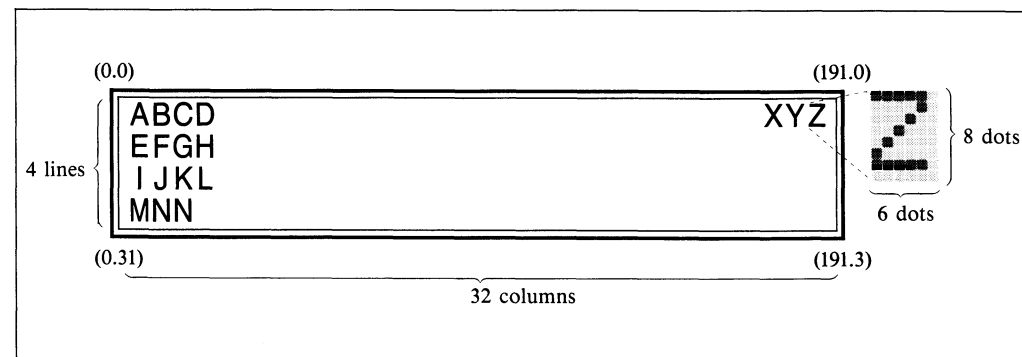

## About the virtual screen

Though you can see only four lines of data at a time on the display, the *virtual screen* of the PB-2000C actually holds 8 lines. To imagine the relationship between the display and the virtual screen, think of the virtual screen as an 8-line piece of paper laying flat on a table. On top of it is a larger piece of paper, with a square cut out that lets you see only four lines of the paper on the bottom. You can slide the cut out up and down to see everything that is on the 8-line sheet, but only four lines at a time.

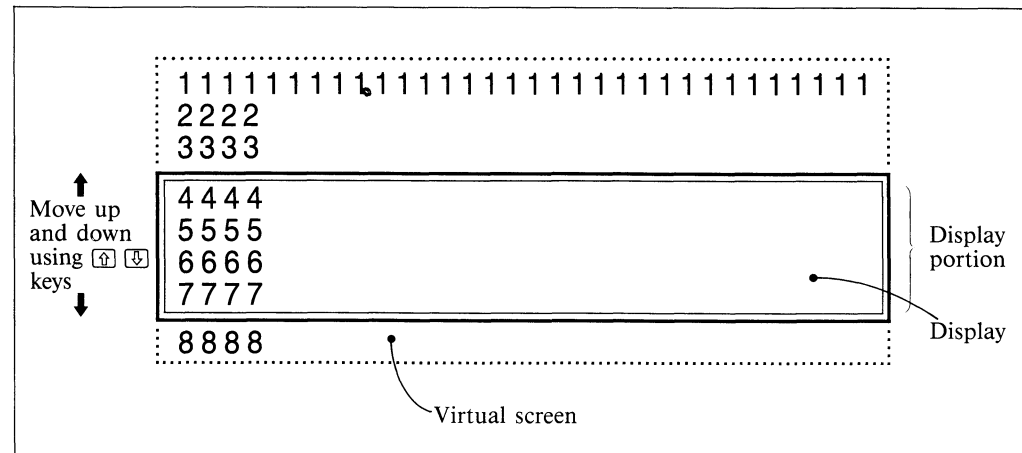

# Chapter 2

## Getting Started

**C**hapter 2 is where you actually switch the PB-2000C on and start some hands-on operation. Here, you will learn how to use the C function, the calculator function, the formula memory function and the data bank function.

## 2-1 About menus and modes

The operations of the PB-2000C can be broadly broken down into the four following functions:

- C function
- Calculator function
- Formula memory function
- Data bank function

Let's have a look at some basic operations that makes these functions available to you.

### To switch power ON

Slide the power switch to the ON position and the cursor will appear on the display.

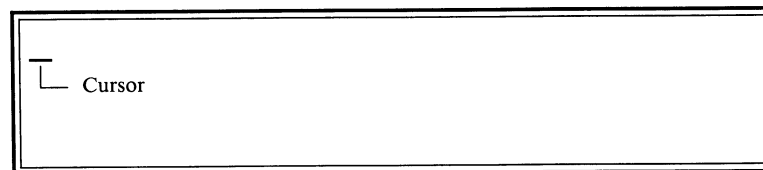

This is the CAL mode which is the default setting for the PB-2000C. Later you will see how you can change the initial mode that is activated each time you switch power ON (see page 71).

### To display the function key menu (MENU mode)

Press the **MENU** key to enter the MENU mode and make the function key menu appear at the bottom of the display.

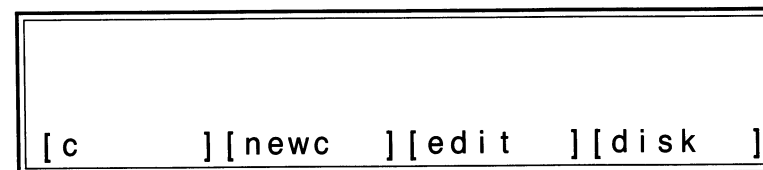

This particular menu is used with the C function and when editing or storing data.

Each of the menu selections corresponds to the function key immediately below it. The actual meanings of the menu selections will be provided later in this manual, but let it now suffice to say that the function key on the left executes the menu selection on the left, the second function key from the left executes the second menu selection from the left, etc.

### To display the next function key menu

Press the **ETC** key to the right of the function keys to proceed to the next function key menu.

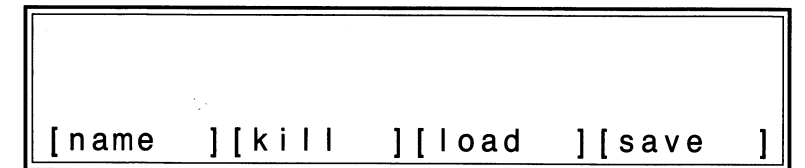

This function key menu is used to assign name to files (files contain data and programs) and delete existing filenames.

Press the **ETC** key to proceed to the next function key menu.

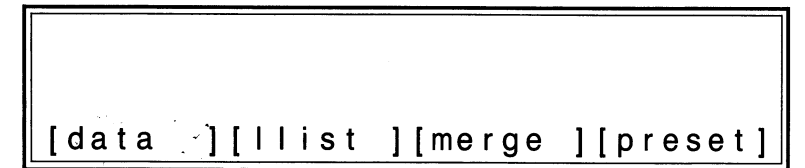

Press the **ETC** key again for the next function key menu.

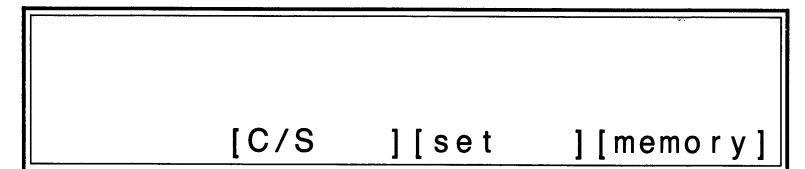

Finally, press the **ETC** key one more time to return to the original function key menu. This is the basic operation to change the functions assigned to each function key and to display the corresponding function key menu. Later in this manual, we will see exactly how each of these functions can be used to make operation of the PB-2000C quick and easy. Here, let's review one more time what we have seen in this section.

**Menu display**

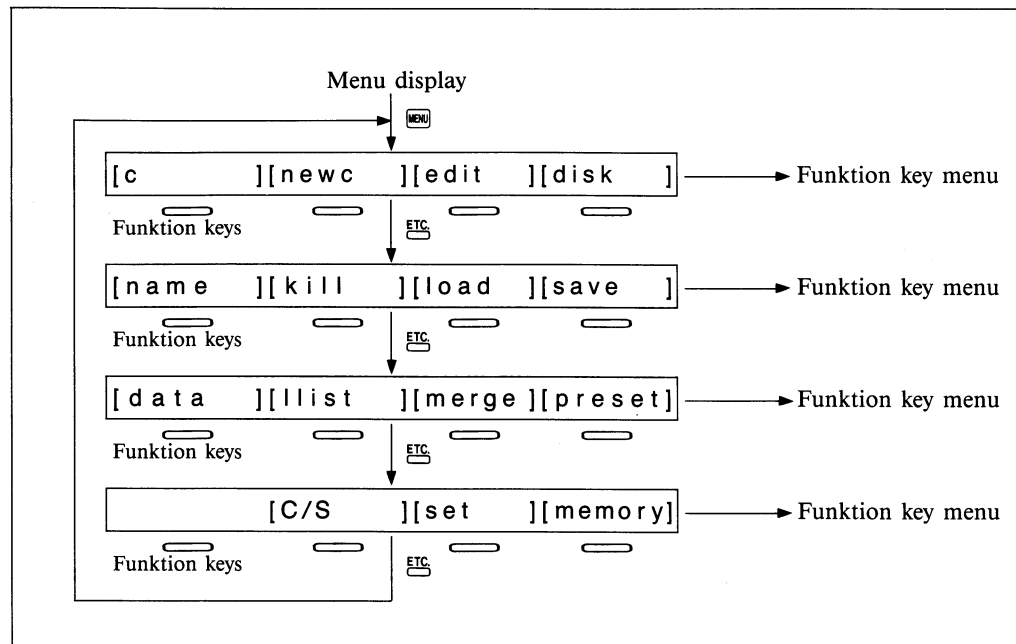

**Basic operation of the calculator function (CAL mode)**

When you want to use the computer as a calculator, press the **[CAL]** key to enter the CAL mode. This clears the function key menu from the screen and causes the cursor to appear in the upper left.

**[CAL]**

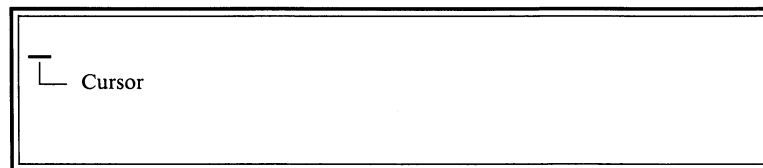

Now let's try performing the calculation "2.5+3.5-2=". Enter the calculation just as it is written, from left to right, but press **[EXE]** for "=".

2.5 **[+]** 3.5 **[-]** 2 **[EXE]**

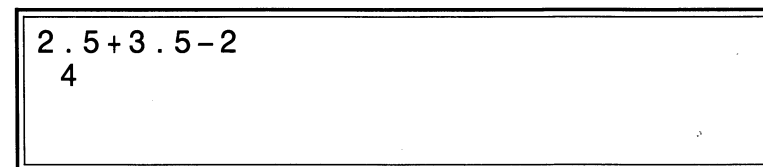

This is the basic operation in the CAL mode for addition, subtraction, multiplication and division, as well as for trigonometric function and logarithmic calculations. Press **[CAL]** to enter, input the calculation and then press **[EXE]**. Details concerning each type of calculation are given in the section titled **Using the calculator function**.

**Basic operation of the formula memory function (CAL mode)**

The formula memory function of the PB-2000C lets you store a formula in memory. Then when you execute the formula, the computer asks you for values to assign to the variables and calculates the results.

Let's say, for example, that we wish to calculate the selling price of a number of articles. The standard formula for such a calculation is:

$$\text{SELLING PRICE} = \text{PURCHASE PRICE} \div (1 - \text{PROFIT}\%)$$

To make this easier to input, we will shorten it to:

$$\text{SELL} = \text{PURCHASE} / (1 - \text{PROFIT})$$

First press **[CAL]** to enter the CAL mode, or press **[CLS]** to clear the screen if you are continuing from another example in the CAL mode.

Next, enter the formula exactly how it is written, from left to right:

**[CAL]** **[CLS]**

SELL **[=]** PURCHASE **[/]** ( **[1]** **[-]** PROFIT **[)]**

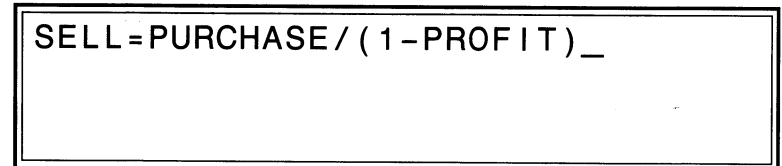

After you enter the formula, press the **[IN]** key to store it in memory.

**[IN]**

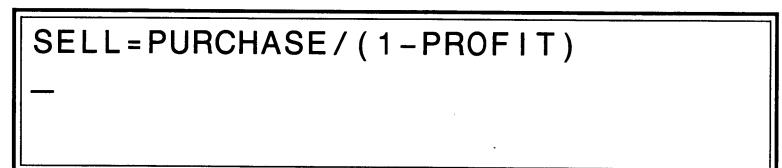

Now we will execute the calculation, assuming that the purchase price is \$1000 and the profit rate is 0.3 (30%).

Press the **[CAL]** key to begin execution of the calculation, and the computer asks you for input of a value for the first variable.

**[CAL]**

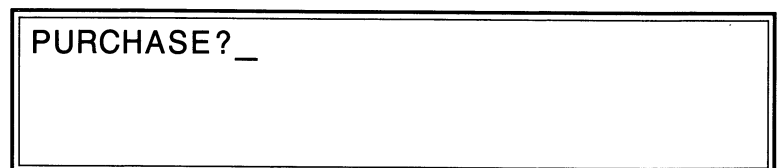

Enter the purchase price and press  $\boxed{\text{EXE}}$ . Then, in answer to the next prompt, enter the profit rate and press  $\boxed{\text{EXE}}$  again. The selling price is instantly calculated and displayed.

1000  $\boxed{\text{EXE}}$   
0.3  $\boxed{\text{EXE}}$

```
PURCHASE?1000
PROFIT?0.3
SELL= 1428.571429
```

Let's continue with a purchase price of \$960 and a profit rate of 0.25 (25%).

$\boxed{\text{CALC}}$   
960  $\boxed{\text{EXE}}$   
0.25  $\boxed{\text{EXE}}$

```
PURCHASE?960
PROFIT?0.25
SELL= 1280
```

Once you store a formula in memory, you can execute it as many times as you want. Later we will see how the  $\boxed{\text{OUT}}$  key can also be used to recall the currently stored formula for execution and editing. See the section titled **Using the formula memory function** for full details.

### Basic operation of the data bank function (MEMO IN mode)

The data bank function of the PB-2000C can be used to enter and store data for instant recall when you need it. Here, let's store the following data:

CASIO 262-347-4811

First, press  $\boxed{\text{SHIFT}} \boxed{\text{MEMO IN}}$  to enter the MEMO IN mode.

$\boxed{\text{SHIFT}} \boxed{\text{MEMO IN}}$

```
—
< 1 >
```

Record number

Enter the data you wish to store in the data bank. Be sure to press  $\boxed{\text{EXE}}$  at the end.

CASIO  $\boxed{\text{SPC}}$   
262  $\boxed{\text{—}}$  347  
 $\boxed{\text{—}}$  4811  $\boxed{\text{EXE}}$

```
CASIO 262-347-4811
```

< 1 >

The data item (CASIO 262-347-4811) that you enter here is stored under Record #1. The record number is incremented by one each time you enter another data item. Later, in the section titled **Using the data bank function** you will see how to search for specific data items, as well as how to edit and delete data.



## 2-2 Using the C function

Your PB-2000C features a C editor that gives you powerful C interpreter and program development capabilities. For detailed information on operations and an introduction to using C, refer to the separate Introduction to the C Programming Language manual.

### To use the C interpreter

1. Press the  key to display the following menu.



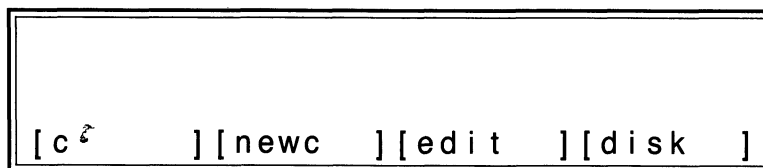

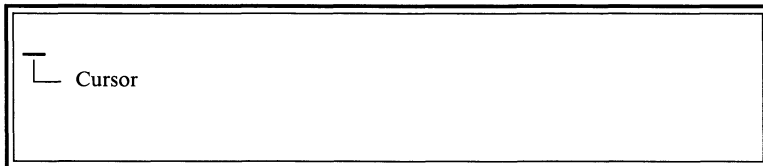

2. Press the function key under [c] to enter the C interpreter.

[c]



3. To return to the original menu, press the  key again.

### To use the C editor

1. Press the  key to display the following menu.



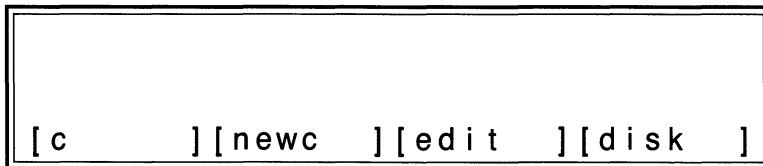

2. Press the function key under [newc] to create an unnamed file and enter the C editor. If another unnamed file already exists in memory, this operation enters the file editor for that file.

[newc]

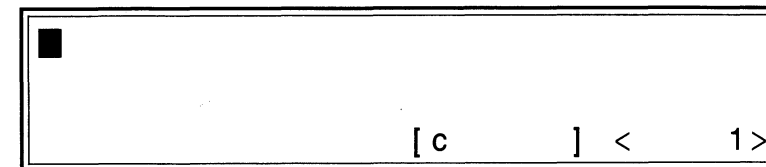









3. To return to the original menu, press the  key again.

## 2-3 Using the calculator function

### Entering operators

Use the following keys to enter mathematical operators, which are represented on the display as noted:

Operation	Key	Display
Positive sign		+
Negative sign		-
Addition		+
Subtraction		-
Multiplication		*
Division		/
Powers	 	^

### How calculation results are displayed

Calculation results are displayed using one of the three following display formats, depending upon the size of the value:

Value	Display
Integer whose absolute value is less than $1 \times 10^{10}$	Integer format
Value with decimal portion up to 10 digits long	Decimal format
Value other than that described above	Exponential format

## Using variables correctly

- Your PB-2000C can handle numeric variables only. This means that you can assign only numeric values to a variable, never text.
- Variable names can be any combination of uppercase or lowercase characters and numbers, except for two restrictions:
  - The first position of the variable name must be a character, never a number.
  - The first characters of the variable name cannot be a scientific function name.

### Example

5S — Illegal because of the “5” in the initial position.

S5 — Allowed.

SINK — Illegal because “SIN” in a scientific function name (sine).

KSIN — Allowed, because “SIN” is not at the beginning of the variable name.

- The following operation clears all of the values currently assigned to all variables:  
CLEAR  $\square$

## Performing manual calculations

The following examples illustrate how to perform each type of manual calculation.

### To perform arithmetic calculations

Enter the calculation just as it’s written, from left to right.

#### Example

Calculation:  $9 + 7.8 \div 6 - 3.5 \times 2 = 3.3$

Input: 9  $\square$  7.8  $\square$  6  $\square$  3.5  $\square$  2  $\square$

```
9 + 7.8 / 6 - 3.5 * 2
3.3
```

### To enter a value as a negative

Press the  $\square$  key immediately before entering the value you want entered as a negative.

#### Example

Calculation:  $56 \times (-12) \div (-2.5) = 268.8$

Input: 56  $\square$  12  $\square$  2.5  $\square$

```
56 * - 12 / - 2.5
268.8
```

### To enter an exponent

Press  $\square$  immediately before entering the value you want entered as an exponent.

#### Example

Calculation:  $(4.5 \times 10^{75}) \times (-2.3 \times 10^{-78}) = -0.01035$

Input: 4.5  $\square$  75  $\square$  2.3  $\square$  78  $\square$

```
4.5E75 * - 2.3E-78
-0.01035
```

### To use a result at the beginning of the next calculation

After obtaining a result by pressing the  $\square$  key, simply continue with the next calculation.

#### Example

Calculation:  $(23 + 456) \times 567 = 271593$

Input: 23  $\square$  456  $\square$  567  $\square$

```
23 + 456
479
479 * 567
271593
```

### To use a result within the next calculation

After obtaining a result by pressing the  $\boxed{\text{EXE}}$  key, press  $\boxed{\text{ANS}}$  (answer key) at the point in the next calculation where you want the previous result used.

#### Example

**Calculation:**  $81.2 \div (5.6 + 8.9) = 5.6$

**Input:**  $5.6 \boxed{+}$   $8.9 \boxed{\text{EXE}}$   $81.2 \boxed{/}$   $\boxed{\text{ANS}}$   $\boxed{\text{EXE}}$

```
5 . 6 + 8 . 9
14 . 5
81 . 2 / 14 . 5
5 . 6
```

### Performing calculations using variables

Since you can use variables in calculations with the PB-2000C, repeat calculations in which one a value is constant become quicker and easier.

### To perform a calculation using variables

First assign a value to a variable, and then include the variable in place of the value within the calculation.

#### Example

Look at the following series of calculations:

$2 \times 3.1415 + 5 =$   
 $3 \times 3.1415 + 6 =$   
 $4 \times 3.1415 + 7 =$   
 $5 \times 3.1415 + 8 =$

Input would become much easier if we designate  $x = 3.1415$  and then enter the calculations in algebraic format:

$2x + 5 =$   
 $3x + 6 =$   
 $4x + 7 =$   
 $5x + 8 =$

1. First, assign the value 3.1415 to variable x.

**Operation:**  $X \boxed{=}$   $3.1415 \boxed{\text{EXE}}$

```
X = 3 . 1415
```

2. Next, perform each calculation using algebraic format.

**Operation:**  $2 \boxed{*}$   $X \boxed{+}$   $5 \boxed{\text{EXE}}$   
 $3 \boxed{*}$   $X \boxed{+}$   $6 \boxed{\text{EXE}}$

```
2 * X + 5
11 . 283
3 * X + 6
15 . 4245
```

$4 \boxed{*}$   $X \boxed{+}$   $7 \boxed{\text{EXE}}$   
 $5 \boxed{*}$   $X \boxed{+}$   $8 \boxed{\text{EXE}}$

```
4 * X + 7
19 . 566
5 * X + 8
23 . 7075
```

### Editing formulas

#### To insert a character

1. Use the cursor keys to move the cursor to the character that will follow (be to the right) of the character that you insert.

$\boxed{\leftarrow}$  . . . . .  $\boxed{\rightarrow}$

```
( 25 + 75 ) * 5
```

2. Press the **INS** key to open up a space.

**INS**

(\_25+75)\*5

3. Enter the desired character.

1

(1\_25+75)\*5

### To delete a character using **DEL**

1. Use the cursor keys to move the cursor to the character that you wish to delete.

← . . . . ←

ABCDEFG

2. Press the **DEL** key to delete the character at the current cursor location.

**DEL**

ABCEFG

### To delete a character using **BS**

1. Use the cursor keys to move the cursor to the character that is to the right of the character that you wish to delete.

← ← ←

ABCDEFG

2. Press the **BS** key to delete the character to the left of the current cursor location.

**BS**

ABCEFG

### To delete a series of characters

1. Use the cursor keys to move the cursor to the location of the the character that is at the left end of the series of characters that you wish to delete.

← ← ←

ABCDEFG

2. Press the **SHIFT** followed by the **LDEL** key to delete all of the characters in the current logical line starting from the current cursor location.

**SHIFT** **LDEL**

ABCD\_

### Performing scientific function calculations

Here we will learn how to perform a variety of scientific function calculations through a number of actual examples. Only a few representative example calculations will be shown for each scientific function type. Page 35 shows a table of all of the scientific functions that the PB-2000C can perform.

## Trigonometric and inverse trigonometric functions

The trigonometric and inverse trigonometric functions let you calculate the sine, cosine, tangent, arcsine, arccosine, and arctangent of values.

The PB-2000C is capable of performing trigonometric and inverse trigonometric functions using a unit of angular measurement in degrees, radians or grads.

$$90^\circ \text{ (degrees)} = \frac{\pi}{2} \text{ (radians)} = 100 \text{ (grads)}$$

Always confirm that the current unit of angular measurement setting is the one you want before you begin your calculation. Once you select a unit of angular measurement, it remains in effect until you make another selection or you press the NEWALL button (default=degrees).

### To select degrees

Enter ANGLE 0 and press  $\boxed{\text{EXE}}$ .

### To select radians

Enter ANGLE 1 and press  $\boxed{\text{EXE}}$ .

### To select grads

Enter ANGLE 2 and press  $\boxed{\text{EXE}}$ .

## To calculate the sine of a value

Calculation:  $\sin 30^\circ = 0.5$

Input: ANGLE 0  $\boxed{\text{EXE}}$   
SIN 30  $\boxed{\text{EXE}}$

```
ANGLE0
SIN30
0.5
```

## To use $\pi$ in a calculation

Calculation:  $\cos \frac{\pi}{3} = 0.5$

Input: ANGLE 1  $\boxed{\text{EXE}}$   
COS (PI/3)  $\boxed{\text{EXE}}$

```
ANGLE1
COS(PI/3)
0.5
```

## To combine two functions

Calculation:  $2 \sin \frac{\pi}{3} + \cos \frac{\pi}{3} = 2.232050808$

Input: ANGLE 1  $\boxed{\text{EXE}}$   
 $2 * \text{SIN}(\text{PI}/3) + \text{COS}(\text{PI}/3)$   $\boxed{\text{EXE}}$

```
ANGLE1
2*SIN(PI/3)+COSPI/3)
2.232050808
```

## To calculate the tangent of a value

Calculation:  $\tan 60^\circ = 1.732050808$

Input: ANGLE 0  $\boxed{\text{EXE}}$   
TAN 60  $\boxed{\text{EXE}}$

```
ANGLE0
TAN60
1.732050808
```

## To calculate the arcsine of a value

Calculation:  $\sin^{-1} 0.5 = 30^\circ$

Input: ANGLE 0  $\boxed{\text{EXE}}$   
ASN 0.5  $\boxed{\text{EXE}}$

```
ANGLE0
ASN0.5
30
```

## To perform division within a function

Calculation:  $\cos^{-1} \frac{2^{0.5}}{2} = 45^\circ$

Input: ANGLE 0  $\boxed{\text{EXE}}$   
ACS (2^0.5/2)  $\boxed{\text{EXE}}$

```
ANGLE0
ACS(2^0.5/2)
45
```

**To change the angle unit after a result is obtained**

Calculation:  $\tan^{-1}\sqrt{3}=60^\circ=1.047197551 \left(\frac{\pi}{3}\right)$

Input: ANGLE 0   
 ATNSQR 3   
 ANGLE 1   
 ATNSQR 3

```
ANGLE0
ATNSQR3
60
ANGLE1
```

⋮

```
60
ANGLE1
ATNSQR3
1.047197551
```

**Hyperbolic and inverse hyperbolic functions**

The hyperbolic and inverse hyperbolic functions let you calculate the hyperbolic sine, hyperbolic cosine, hyperbolic tangent, hyperbolic arcsine, hyperbolic arccosine, and hyperbolic arctangent of values.

As with trigonometric and inverse trigonometric functions be sure to confirm the current unit of angular measurement specification before you perform a calculation.

**To calculate the hyperbolic sine of a value**

Calculation:  $\sinh 5=74.20321058$

Input: HYP SIN 5

```
HYP SIN5
74.20321058
```

**To calculate the hyperbolic arccosine of a value**

Calculation:  $\cosh^{-1}1.5=0.9624236501$

Input: HYP ACS 1.5

```
HYP ACS1.5
0.9624236501
```

**Logarithmic and exponential functions**

The logarithmic functions let you calculate the natural logarithm and common logarithm of values, while the exponential function lets you calculate the exponent of values.

**To calculate the common logarithm of a value**

Calculation:  $\log_{10}100=2$

Input: LGT 100

```
LGT100
2
```

**To calculate the natural logarithm of a value**

Calculation:  $\log_e 123=4.812184355$

Input: LOG 123

```
LOG123
4.812184355
```

**To calculate the exponent of a value**

Calculation:  $e^5=148.4131591$

Input: EXP 5

```
EXP5
148.4131591
```

### Decimal ↔ Hexadecimal conversion

This function lets you convert values between the decimal and hexadecimal number systems.

#### To convert from hexadecimal to decimal

Calculation:  $10_{(16)} = 16_{(10)}$

Input: &H10

```
&H10
16
```

#### To convert from decimal to hexadecimal

Calculation:  $1000_{(10)} = 3E8_{(16)}$

Input: HEX\$ (1000)

```
HEX$ (1000)
03E8
```

### Decimal ↔ Sexagesimal conversion

This function lets you convert values between the decimal and sexagesimal number systems.

#### To convert from decimal to sexagesimal

Calculation:  $12.3456^\circ = 12^\circ 20' 44.16''$

Input: DMS\$ (12.3456)

```
DMS$ (12.3456)
12°20'44.16
```

### To convert from sexagesimal to decimal

Calculation:  $12^\circ 34' 56'' = 12.58222222^\circ$

Input: DEG (12,34,56)

```
DEG (12,34,56)
12.58222222
```

### Table of Functions

Function Name	Formula	Format	Calculation Range
Trigonometric	sin	SIN (expression)	$-1440^\circ < \text{expression} < 1440^\circ$ ( $8\pi\text{rad}$ , 1600grad)
	cos	COS (expression)	$-1440^\circ < \text{expression} < 1440^\circ$ ( $8\pi\text{rad}$ , 1600grad)
	tan	TAN (expression)	$-1440^\circ < \text{expression} < 1440^\circ$ ( $8\pi\text{rad}$ , 1600grad)
			* Except when $ \text{expression}  = (2n-1) \times 1$ right angle (n=integer)
Inverse Trigonometric	$\sin^{-1}$	ASN (expression)	$ \text{expression}  \leq 1$ , $-90^\circ \leq \text{ASN}(\text{expression}) \leq 90^\circ$
	$\cos^{-1}$	ACS (expression)	$ \text{expression}  \leq 1$ , $0^\circ \leq \text{ACS}(\text{expression}) \leq 180^\circ$
	$\tan^{-1}$	ATN (expression)	$ \text{expression}  < 10^{100}$ , $-90^\circ \leq \text{ATN}(\text{expression}) \leq 90^\circ$
Hyperbolic	sinh	HYP SIN (expression)	$ \text{expression}  \leq 230.2585092$
	cosh	HYP COS (expression)	$ \text{expression}  \leq 230.2585092$
	tanh	HYP TAN (expression)	$ \text{expression}  \leq 10^{100}$ , $-1 \leq \text{HYP TAN}(\text{expression}) \leq 1$
Inverse Hyperbolic	$\sinh^{-1}$	HYP ASN (expression)	$ \text{expression}  < 5 \times 10^{99}$
	$\cosh^{-1}$	HYP ACS (expression)	$1 \leq  \text{expression}  < 5 \times 10^{99}$
	$\tanh^{-1}$	HYP ATN (expression)	$ \text{expression}  < 1$
Exponential	$e^x$	EXP (expression)	$-227 \leq \text{expression} \leq 230.2585092$
Natural logarithm	$\log_e X$	LOG (expression)	$\text{expression} > 0$
Common logarithm	$\log_{10} X$	LGT (expression)	$\text{expression} > 0$
Square root	$\sqrt{X}$	SQR (expression)	$\text{expression} \geq 0$
Hexadecimal to decimal conversion	&H	&H (hexadecimal string)	Hexadecimal number up to 4 digits long
Decimal to hexadecimal conversion	HEX\$	HEX\$ (expression)	$-32769 < \text{expression} < 65536$
Decimal to sexagesimal conversion	DMS\$	DMS\$ (expression)	$ \text{expression}  < 10^5$
Sexagesimal to decimal conversion	DEG	DEG (degrees [, minutes [, seconds]])	$ \text{DEG}(X, Y, Z)  < 10^{100}$

## 2-4 Using the formula memory function

The formula memory function of the PB-2000C lets you use a single formula for multiple calculations. Simply store the formula in memory and then supply values for the variables as the computer prompts you on the display. The formula memory function is available in the CAL mode only, and is controlled using the following keys:

- IN** : Press this key to store the formula that is currently on the display into the formula memory.
- OUT** : Press this key to display the formula currently stored in the formula memory.
- CALC** : Press this key to execute the formula.

To see exactly how the formula memory function works, let's use it to complete the following table:

A	B	P=A*B	Q=A/B
4.27	1.17		
8.17	6.48		
6.07	9.47		
2.71	4.36		
1.98	3.62		

Press the **CAL** key to make sure that you are in the CAL mode perform the following steps.

### To store a formula

Enter the first formula (P=A\*B) just as it is written, from left to right. Add a colon at the end, and then enter the second formula (Q=A/B).

**Input:** P=A \* B : Q=A/B **IN**

P=A\*B:Q=A/B  
\_

Connecting two formulas creates a *multistatement*. The computer treats each formula separately.

### To recall a formula

Let's say that you clear the display for some reason by pressing the **CLS** key. You can then recall the stored formula back to the display by pressing the **OUT** key.

**Input:** **CLS**  
**OUT**

P=A\*B:Q=A/B\_

### To execute a formula

Press the **CALC** key to execute the formula. Enter a value for each prompt that appears. Remember that you have to press **EXE** after each value your enter.

**Input:** **CALC** 4.27 **EXE**  
1.17 **EXE**  
**EXE**

A?4.27  
B?1.17  
P= 4.9959  
Q= 3.64957265

You can also press the **EXE** key to proceed to the next calculation.

**Input:** **EXE** 8.17 **EXE**  
6.48 **EXE**  
**EXE**

A?8.17  
B?6.48  
P= 52.9416  
Q= 1.260802469

Continue with the rest of the A and B values in the table. Press the **BRK** key when you want to exit the calculation.

### To edit a stored formula

Let's say that we want to add R=A+B at the end of our stored multistatement.

- Recall the stored formula after clearing the display.

**Input:** **CLS** **OUT**

P=A\*B:Q=A/B\_



2. Add : R=A+B to the end of the multistatement. Remember to include the colon.

**Input:**  $\boxed{=}$  R=A+B

P=A\*B : Q=A / B : R=A+B\_

3. Press  $\boxed{IN}$  to store the newly created multistatement.

Try entering a few values to see what happens. Press the  $\boxed{BRK}$  key when you want to exit the calculation.

### To clear the formula memory

Whenever you press the  $\boxed{IN}$  key, anything shown on the display replaces the current contents of the formula memory. Therefore, when you want to clear the memory, simply press  $\boxed{CLS}$  to clear the display and then press  $\boxed{IN}$ . This stores a cleared display in the formula memory, effectively erasing anything that is stored there.

#### Important

- Although it is possible to store up to 256 characters in the formula memory, the limitation on formulas executed by the  $\boxed{CALC}$  key is 255 characters. This means that you should keep formulas to a maximum length of 255 characters.
- If the data stored in the formula memory does not make up a formula, an error occurs when you press the  $\boxed{CALC}$  key.
- The same variables that are available with the calculator function (see page 24) can be used with the formula memory function.
- Results produced by a formula stored in the formula memory can be used in subsequent calculations. While the result is displayed, press  $\boxed{+}$ ,  $\boxed{-}$ ,  $\boxed{*}$ ,  $\boxed{/}$  or  $\boxed{SHIFT}$   $\boxed{=}$  as required to proceed with the next calculation.
- The  $\boxed{CALC}$  can only be used in the CAL mode, and is not operational in any other mode.

## 2-5 Using the data bank function

The data bank function of the PB-2000C lets you store large volumes of data for instant recall whenever you need a specific piece of information.

### To enter the MEMO IN mode

Press  $\boxed{SHIFT}$  followed by  $\boxed{MEMO IN}$  to tell the computer that the data you are about to enter is for storage in the data bank. Data entered in the MEMO IN mode is always stored in a file named "MEMO.S". If there is no MEMO.S file when you enter the MEMO IN mode, the computer automatically creates one to store the data you are about to enter. If there is already a MEMO.S file, the computer enters it whenever you press  $\boxed{SHIFT}$   $\boxed{MEMO IN}$ .

#### Note

The computer allows only one MEMO.S file at a time, but you can create multiple data bank files by changing the name of the current MEMO.S file to another name. To change the name, follow the procedure described on page 53.

### To enter data into the data bank

Press  $\boxed{SHIFT}$  followed by  $\boxed{MEMO IN}$  to tell the computer to enter the MEMO IN mode because the data you are about to enter is for storage in the data bank. If nothing is stored in the data bank when you perform this operation, the display appears as follows:

**Input:**  $\boxed{SHIFT}$   $\boxed{MEMO IN}$

—  
< 1 >

The number in the lower right corner is the *record number*, and it tells you what record is currently shown on the display. Since this is your first entry into the data bank, you are in Record #1.

#### Note

If the display of your computer does not appear as the one illustrated above, it may be because there is already data stored in your data bank. To delete the data, you have to delete the MEMO.S file (see page 45).

Enter any characters that you wish to store in Record #1 of the data bank, pressing the  $\boxed{EXE}$  at the end.

Input: CASIO 

CASIO	<	1	>
-------	---	---	---

At this time the cursor will disappear from the display of Record #1. Now, if you input more data, the display will automatically change to Record #2 for the new data.

Input: PB-2000C 

PB-2000C	<	2	>
----------	---	---	---

Now enter "ABCDEFGH IJKLMNOPQRSTUVWXYZabcdefgh" for Record #3. Note that this becomes two lines on the display, so this record contains one logical line made up of two physical lines (see page 13).

 ABCDEFGHIJK  
 LMNOPQRSTU  
 VWXYZ   
 abcdefg 

ABCDEFGHIJK LMNOPQRSTU VWXYZ abcdefgh	<	3	>
--	---	---	---

Finally, enter "ABC  DEF" for Record #4. This again is only one logical line, though there are two physical lines on the display.

Input: ABC  DEF 

ABC DEF	<	4	>
------------	---	---	---

You can continue entering records using the procedure outlined above. The following are the only restrictions:

- The number of records that can be stored is only limited by the size of the PB-2000C memory capacity.
- Each record can hold up to 255 characters (8 lines) of data.

## Editing data bank data

This section will tell you how to insert, edit, and delete data contained in the data bank, but first let's see how we can locate specific data by scrolling through the records currently stored.

### To scroll through and select data bank records

1. While the computer is in the MEMO IN mode, perform one of the following key operations to scroll through the records currently stored in memory.

- Scrolls up to the next physical line.
- Scrolls down to the next physical line.
- Scrolls up to the next logical line.
- Scrolls down to the next logical line.
- Moves the cursor to the next word.

The record number shown on the display indicates the currently selected record, which is the record currently at the top of the display.

2. Perform one of the editing operations described below. The operation you perform affects the currently selected record (i.e. the record whose number is shown in the lower right of the display).

### To insert a record between two existing records

Confirm that the computer is in the MEMO IN mode and select the record that will immediately precede the record you wish to insert (i.e. to insert between Record #3 and Record #4, select Record #3). Then enter the data for the record you are inserting and press .

As an example, let's insert a record that contains the data "POCKET COMPUTER" between Record #1 ("CASIO") and Record #2 ("PB-2000C").

1. Since we wish to insert the new record after Record #1, we scroll through the records and select Record #1 (indicated by "CASIO" being at the top of the display and 1 indicated as the record number).

Input:      

CASIO			
PB-2000C			
ABCDEFGHIJK LMNOPQRSTU VWXYZ abcdefgh	<	1	>

2. Enter the words "POCKET COMPUTER" as the data to be included in the inserted record. Note that this data will be the new Record #2.

**Input:** POCKET COMPUTER

```
POCKET COMPUTER_
< 2>
```

3. Finally, press **EXE** to store the new record.

**Input:** **EXE**

```
POCKET COMPUTER
PB-2000C
ABCDEFGHIJKLMNOPQRSTUVWXYZabcdef
< 2>
```

### To edit the data in a record

Confirm that the computer is in the MEMO IN mode and select the record that you wish to edit. Press **⇐** (**⇒**) to display the cursor. Then edit the contents of the record and press **EXE**. As an example, let's change the contents of Record #2 from "POCKET COMPUTER" to "PERSONAL COMPUTER".

1. Scroll through the records to select Record #2 ("POCKET COMPUTER").

```
POCKET COMPUTER
PB-2000C
ABCDEFGHIJKLMNOPQRSTUVWXYZabcdef
< 2>
```

2. Press **⇐** (**⇒**) to display the cursor. Then press **⇐** once to move the cursor to the "O" of "POCKET", and then perform the following operation to make the change.

**Input:** **⇒** ERSON **INS** A **INS** L

```
PERSONAL_COMPUTER
< 2>
```

3. Finally, press **EXE** to store the edited record.

### To delete a record

Confirm that the computer is in the MEMO IN mode and select the record that you wish to delete. Press **⇐** (**⇒**) to display the cursor. Then press **CLS** to clear the display and then press **EXE**.

As an example, let's delete Record #4.

1. Scroll through the records to select Record #4.

```
ABCDEFGHIJKLMNOPQRSTUVWXYZabcdef
gh
ABC
< 4>
```

2. Press **⇐** (**⇒**) so that Record #4 only is shown on the display.  
3. Press **CLS** to clear the contents of Record #4 from the display

**⇒** **CLS**

```
-
< 4>
```

4. Finally, press **EXE**.

**EXE**

```
ABC
DEF
< 4>
```

### Locating specific data in the data bank

With your PB-2000C, you can enter characters contained in the record that you want to recall, and then the computer automatically locates and displays all records that contain sets of letters of numbers that begin with the specified characters. This makes location of specific records quick and easy.

### To locate specific data in the data bank

Confirm that the computer is in the MEMO IN mode and enter the characters (up to eight) that you want to search for. Then press the **MEMO** key.

As an example, let's search for all records that contain sets of characters that start with the letter "P".

1. Enter the letter "P".

P

P_	<	5	>
----	---	---	---

2. Press the **MEMO** key.

**MEMO**

<b>P</b> PERSONAL COMPUTER	<	2	>
PB-2000C			
ABC			

You can press the **MEMO** key to display the next set of characters that starts with the letter "P".

#### Important

- Though it is possible to enter more than eight characters for the search, only the initial eight are used by the computer.
- The computer searches for all sets of characters that start with the characters you specify. Here, a *set* is defined as a series of characters (letters or numbers) at the beginning of a logical line, or a series of characters preceded by a space. If a record contains the following four sets of characters, the computer will consider all of them a match if you tell the computer to search for the letter "A".

A BCD	A BEF	A BGH	A
↓	↓	↓	↓
①	②	③	④

- You cannot specify a space as the first character of those you want to find.
- If the characters that you specify cannot be found, the computer will stand by at the last record.

### To search for data in the CAL mode

You can also search for data stored in the data bank while the calculator is in the CAL mode. Here, let us search for all of the records that contain logical lines that start with the letters "PB".

1. Press **CAL** to enter the CAL mode.

**CAL**

_
---

2. Enter the letters "PB".

PB

PB_
-----

3. Press **MEMO** to search for the specified characters.

**MEMO**

<b>PB</b> -2000C
ABC
DEF

### To delete a data bank file

1. Press the **MENU** key, and one of the two following displays will appear:

No memo file currently exists

**MENU**

[c	][newc	][edit	][disk	]
----	--------	--------	--------	---

Memo file currently stored in memory.

**MEMU**

```
MEMO . S
[c ][newc ][edit ][disk ]
```

2. Press the **ETC** key to change the function key menu.

**ETC**

```
MEMO . S
[name ][kill ][load ][save ]
```

3. Press the function key under the **[kill ]** selection in the function key menu. At this time, the computer confirms that you really want to delete the data bank file.

**[kill ]**

```
MEMO . S
kill?y/n
```

4. Enter **[Y]** or **[EXE]** to delete the file.

If you press **[N]** here, the computer returns to the previous menu.

## Sample data bank applications

### Telephone Directory

The data bank function of the PB-2000C is handy for keeping track of telephone numbers. Let's enter the names and numbers of the following five individuals:

John Anderson	242-583-1234
Bob Casey	343-493-7386
Eric Martin	819-212-6602
Ray Taylor	733-375-6221
Ken Lloyd	949-717-1007

1. Press **[SHIFT]** **[MEMO IN]** to enter the MEMO IN mode, and enter each name and number.

```
ANDERSON JOHN 242-583-1234
< 1>
```

⋮

```
LLOYD KEN 949-717-1007
< 5>
```

2. Now you can tell the computer to display the number for anyone you wish by simply entering the name and pressing **[MEMO]**.

L **[MEMO]**

```
LLOYD KEN 949-717-1007
```

### Using the data bank with the formula memory function

By combining the data bank and formula memory function capabilities of the PB-2000C, you can build up a library of useful formulas in the data bank for instant recall and execution when you need them. For example, let's store the following formula for calculation of the interest paid on time deposits.

$$\text{INTEREST} = \text{DEPOSIT} \times \text{ANNUAL RATE} \times \text{NUMBER OF MONTHS} / 12$$

1. First, enter the formula and store it in the data bank.

Input:  $\text{SHIFT}$   $\text{MEMO}$  INTEREST  $\text{=}$  DEPOSIT  $\text{*}$  ANNUAL\*  $\text{/}$  100  $\text{*}$  MONTHS  $\text{/}$  12  $\text{EXE}$

```
INTEREST=DEPOSIT*ANNUAL/100*MONT
HS/12
< 1 >
```

\* ANNUAL is used as a variable name instead of ANNUAL RATE because a space cannot be included in a variable name.

2. Now, switch power OFF and then ON again. Enter the word "INTEREST" and press  $\text{MEMO}$  to search for and recall the formula from the data bank.

Input: INTEREST  $\text{MEMO}$

```
INTEREST=DEPOSIT*ANNUAL/100*MONT
HS/12
```

3. Next, press the  $\text{IN}$  key to store the recalled formula in the formula memory.

4. Press  $\text{CALC}$  to execute the formula that is now in the formula memory, and enter values for the variables as the computer asks for them.

Input:  $\text{CALC}$  10000  $\text{EXE}$  3.2  $\text{EXE}$  6  $\text{EXE}$

```
DEPOSIT?10000
ANNUALRATE?3.2
MONTHS?6
INTEREST= 160
```

## 2-6 Using files

### What is a "file"?

Basically, a *file* is a container within the computer's memory for programs and data. Each file has its own *filename*, so that you and the computer can easily identify a file using its name. A file is created automatically whenever you enter a program or data into the computer. Except for data bank files, you can give program and data files any name you like (see page 53). Data bank files are named MEMOS automatically.

### About filenames

The following shows the filename format used by the PB-2000C.

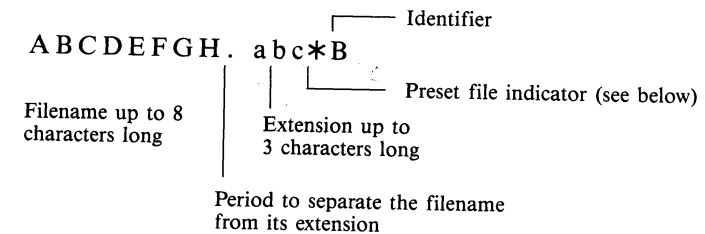

The *identifier* is a single letter that indicates the type of information stored inside of the file.

Filename	Identifier	Contents	Remarks
AAA . S	S	Sequential data file	
BBB . C	C	C file	
CCCC . P	P	Prolog file	Available with optional ROM card.
DDDD . B	B	BASIC file	
EEEE . R	R	Random data file	

• Note that you cannot use a period or colon within the filename.

### About the file display

The computer will display the filenames for all of the files currently stored in memory. Only six filenames can be displayed at one time, so use the cursor keys to scroll through the files when there are more than six in memory.

Filename display

```
CASIO . S EXAMPLE1 . S
ADDRESS . S math . C
INV-2 . C
[c ][newc ][edit ][disk ]
```

## To load a file

1. Press **[MENU]** to enter the MENU mode.
2. Use the cursor keys to select the file that you want to load. The currently selected file is highlighted on the display.
3. Press the **[EXE]** key. If the currently selected file contains a program, the program is executed. If it contains sequential data, the computer enters the DATA EDIT mode (see page 66).

## Using preset files

When you specify a file as a *preset file*, its name will be shown at the bottom of the display whenever the computer is in the CAL mode. Then you can execute the program contained in the file by simply pressing the function key that is below the filename. You can specify up to four files as preset files, and the name of each file that you specify as a preset file is marked by an asterisk in front of its identifier. For details on how to specify a file as a preset file or to cancel a preset file specification, see page 69.

### Important

If a sequential data file is specified as a preset file, the computer will enter the DATA EDIT mode (see page 66) when its corresponding function key is pressed in the CAL mode.

## Using an automatic execute file

You can specify a file to execute automatically each time you switch the power of the computer ON. All you have to do is name the desired file "AUTO.EXE" using the **[name ]** procedure described on page 53.

### Important

If a sequential data file is specified as the automatic execute file, the computer will enter the DATA EDIT mode (see page 66) when you switch the power of the computer ON.

## 2-7 Using the menus

### About the menu display

Press the **[MENU]** key to enter the MENU mode and make the function key menu appear at the bottom of the display. There are a total of 15 function key menu selections divided into groups of four. To move from one set of menu selections to the next, press the **[ESC]** key. To select a displayed menu selection, simply press the function key underneath it.

### Important

The contents of the function key menus may change when an optional ROM card is loaded into the PB-2000C. For details, refer to the instructions contained with each ROM card.

### How to use each menu selection

This section tells you about all of the operations that become available when you make a function key menu selection. In all cases, the currently selected file is understood to be the one whose name is highlighted on the display.

#### [ c ]

Press the function key under this selection to enter the C interpreter. For details on using the C editor, see the separate Introduction to the C Programming Language manual.

#### [ newc ]

Press the function key under this selection to create a new, unnamed C file and enter the C interpreter. If an unnamed C file already exists in memory, the computer will enter the editor for that file.

#### [ edit ]

Press the function key under this selection to enter the C editor or DATA EDIT mode for the currently selected file. For details on the DATA EDIT mode, see page 66.

#### [ disk ]

This menu selection is only used when the optional MD-100 interface unit is connected to the PB-2000C. Press the function key under this selection to display the disk menu for the handling of files stored on the floppy disk currently loaded into the drive.

**Important**

The disk menu will not appear if a floppy disk drive is not correctly connected to the computer or when a disk is not inserted into a connected drive. Selecting **[disk ]** in these instances displays on “NR error”. Press the **[MENU]** key to clear the error and return to the main menu.

The following are the functions that are available in the disk menu.

**[ name ]**

Press the function key under this selection to change the name of the currently selected disk file. See page 53 for details.

**[ kill ]**

Press the function key under this selection to delete the currently selected disk file. See page 54 for details.

**[ load ]**

Press the function key under this selection to load the currently selected file from the disk. See page 54 for details.

- Loaded files are always given priority. This means that if you load a file that has a filename which is identical to a file in the computer’s memory, the file in memory will be deleted and replaced with the file loaded from the disk drive.
- If the size of a sequential file loaded from a disk drive is greater than the amount of memory available, the file will load until memory capacity is exceeded, and then an “OM error” will occur.

**[EXE]**

Press the **[EXE]** key to load the currently selected file from the floppy disk and then enter the C interpreter. If the currently selected file is a sequential data file, however, the computer will enter the DATA EDIT mode after the file is loaded.

**Important**

Never change the floppy disk while the disk menu is shown on the display. Doing so may damage the data stored on the disk. Always return to the main menu before changing the floppy disk.

**[ name ]**

Press the function key under this selection to change the name of the currently selected file.

**To change the name of a file**

1. Use the cursor keys to change the current selection so that the filename you wish to change is highlighted.

```

CASIO . C
[ name ] [ kill ] [ load ] [ save ]
  
```

2. Press the function key under **[name ]**. The prompt “new name?” will appear to ask you what name you wish to give to the selected file.

**[name ]**

```

CASIO . C
new name?_
  
```

3. Enter the new name. If you change your mind at this point, you can press **[EXE]** without entering a name to return to the main menu.

EXAMPLE 1

```

CASIO . C
new name?EXAMPLE1_
  
```

4. Press the **[EXE]** key.

**[EXE]**

```

EXAMPLE1 . C
[ name ] [ kill ] [ load ] [ save ]
  
```



- Use the same procedure to give a name to an unnamed file.
- No two files may have identical names and extensions. For example:

CASIO.001		CASIO.001		CASIO.001	
CASIO.001	Illegal	CASIO.002	Legal	MISC.001	Legal

- The **[name ]** function does not operate unless a filename is selected.

### **[kill ]**

Press the function key under this selection to delete the currently selected file.

### To delete a file

1. Use the cursor keys to change the current selection so that the name of the file you wish to delete is highlighted.

```
CASIO . C
[ name ] [ kill ] [ load ] [ save ]
```

2. Press the function key under **[kill ]**. The prompt "kill?y/n?" will appear to confirm whether you really wish to delete the selected file.

**[kill ]**

```
CASIO . C
kill?y/n
```

3. Press the **[Y]** key or **[EXE]** key to proceed with the deletion or the **[N]** key to return to the main menu.

- The **[kill ]** function does not operate unless a filename is selected.

### **[load ]**

Press the function key under this selection to load a file stored on cassette tape or a floppy disk into the computer's memory. This selection is also used to load files from a personal computer or other device via the RS-232C interface.

### To load a file from a cassette tape

1. Connect the optional FA-7 Interface Unit, load a cassette tape that contains the file you wish to load, and press the PLAY button on the cassette tape recorder. When using a tape recorder without a REMOTE jack, press the PLAY button of the tape recorder after Step 5 below.
2. Press the function key under **[load ]**, and the following display will appear.

**[load ]**

```
EXAMPLE1 . C
load" [RS232C] [MT ]
```

3. Press the function key under **[MT ]** to specify that you wish to load a cassette tape file. At this time the **[RS232C]** and **[MT ]** selections disappear from the display, and "CAS0:" appears.

**[MT ]**

```
EXAMPLE1 . C
load"CAS0:_"
```

4. Enter the name of the file you want to load.

CASIO

```
load"CAS0:CASIO_
```

5. Press the **[EXE]** key. The computer will search through the tape to find the file you specified. Each time it locates a file, it displays its name. When it locates the file that has the same name as the one you entered, it loads it into memory.

**[EXE]**

```
CASIO . C
load"CAS0:CASIO
```

6. After the load operation is complete, the main menu appears on the display, with the name of the newly loaded file highlighted.

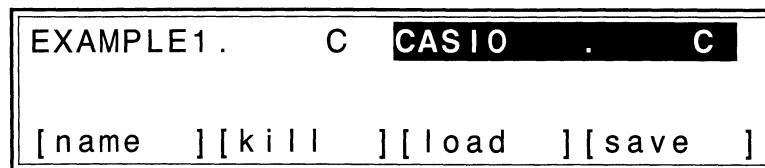

- Loaded files are always given priority. This means that if you load a file that has a filename which is identical to a file in the computer's memory, the file in memory will be deleted and replaced with the file loaded from the cassette tape. An unnamed file loaded from a cassette tape will also replace an unnamed file stored in computer's memory.
- If you press the **[EXE]** key without entering a filename in Step 4 of the procedure, the computer will automatically load the first file that it finds on the cassette tape, regardless of its name.
- The speed at which devices pass data is called the *baud rate*, which expresses data interchange in bits per second (bps). With the FA-7 Interface Unit, the baud rate setting is made using switches on the back of the unit. Whenever you load a file from cassette tape into the PB-2000C's memory, the baud rate setting must match that used when the file was saved, so you should keep a record of the baud rates you use when saving files.

Baud Rate (bps)	Switch Setting
2400	
1200	
600	
300	

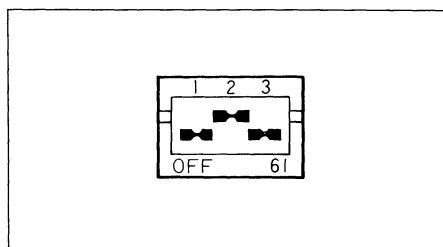

- If you have trouble when loading data from a cassette tape, try changing the setting of the PHASE switch on the right side of the FA-7 Interface Unit from NOR to REV.

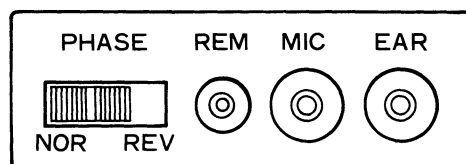

- Before starting the load operation, be sure that the cassette tape is correctly inserted into the recorder.
- If you have multiple files stored on a tape, you should keep records of the counter readings where each of the files start. Then you can fast forward the tape so that the playback head is near the beginning of the file you wish to load before beginning the load operation.
- When loading files, set the volume of the recorder to a very high setting, preferably maximum.

### To load a file from a floppy disk

1. Connect the optional MD-100 Interface Unit and insert a floppy disk that contains the file you wish to load.
2. Press the function key under **[load ]**, and the following display will appear.

**[load ]**

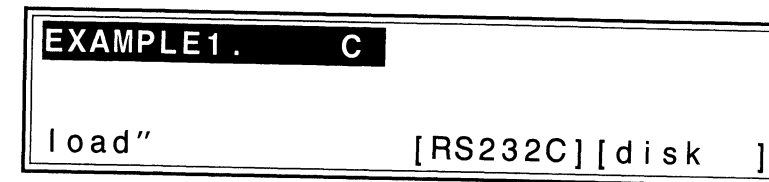

3. Press the function key under **[disk ]** to specify that you wish to load a floppy disk file. At this time the **[RS232C]** and **[disk ]** selections disappear from the display, and "0:" appears.

**[disk ]**

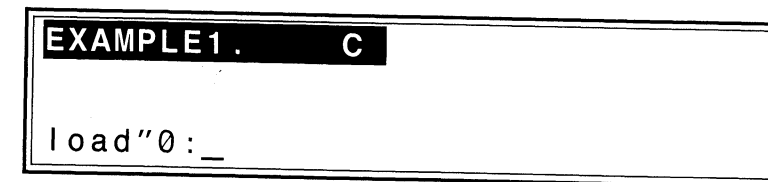

4. Enter the name of the file you want to load.

CASIO

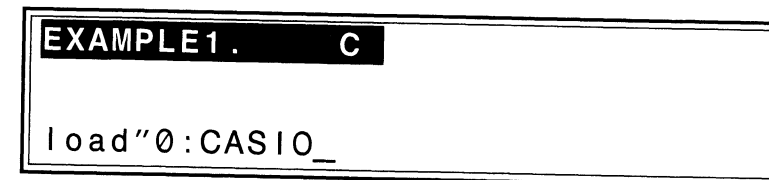

5. Press the **[EXE]** key. After the load operation is complete, the main menu appears on the display, with the name of the newly loaded file highlighted.

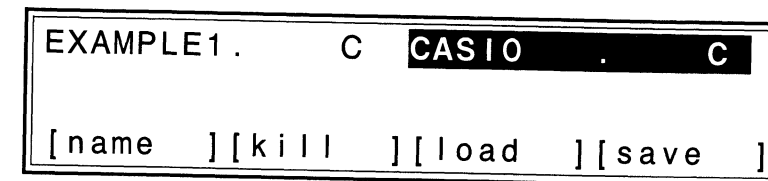

- Loaded files are always given priority. This means that if you load a file that has a filename which is identical to a file in the computer's memory, the file in memory will be deleted and replaced with the file loaded from the disk drive.

### To load a file via the RS-232C interface

1. Connect the optional FA-7 or MD-100 Interface Unit.
2. Set the RS-232C switch on the left side of the interface unit to the ON position.

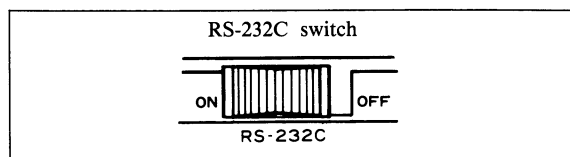

3. Press the function key under **[load ]**, and one of the two following displays will appear. If you are using the FA-7 Interface Unit

**[load ]**

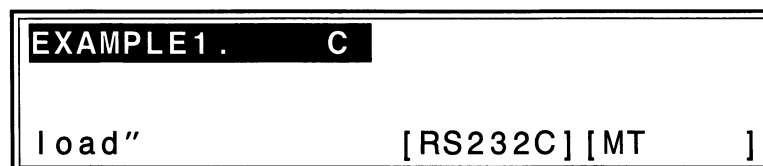

If you are using the MD-100 Interface Unit

**[load ]**

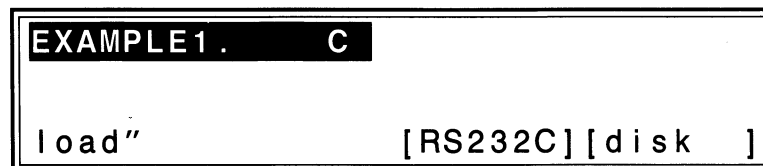

4. Press the function key under **[RS232C]** to specify that you wish to load file via the RS-232C interface. At this time, the display appears as follows.

**[RS232C]**

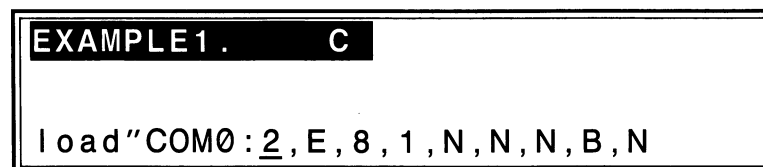

Each of these characters represent a *parameter*. See the section titled **About parameters** below for details.

5. To continue with the file load in accordance with the current parameters, press the **[EXE]** key. The file is loaded as an unnamed file, and when the load operation is complete, the computer returns to the main menu with the new file highlighted.

### About parameters

*Parameters* are settings that are necessary to allow two different computers or other data handling devices exchange information. If the parameters of the two devices trying to establish a connection do not match, they will not be able to exchange data.

When the parameters appear in Step 4 in the procedure above, you can use the cursor keys to move the cursor left and right through the parameters. You can enter values and letters from the PB-2000C's keyboard to change the parameters to the settings described below. After you set the parameters, press the **[EXE]** to perform the load operation in accordance with the parameters you have specified.

**Example:** load''COM0:2,E,8,1,N,N,N,B,N

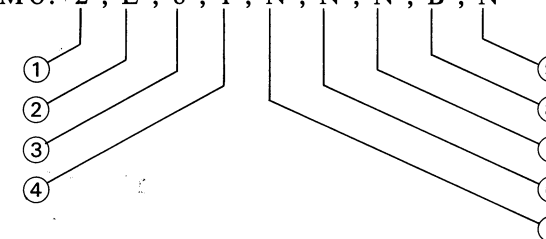

#### ① Baud Rate

0	1	2*	3	4	5	6	7
75 bps	150 bps	300 bps	600 bps	1200 bps	2400 bps	4800bps	9600 bps

\* Default setting (following reset)

#### ② Parity bit

N	E*	O
None	Even	Odd

\* Default setting

#### ③ Character bit length

7	8*
7 bits	8 bits

\* Default setting

#### ④ Stop bit length

1*	2
1 bit	2 bits

\* Default setting

## ⑤ CTS signal control

C	N*
Yes	Ignore

\* Default setting

## ⑥ DSR signal control

D	N*
Yes	Ignore

\* Default setting

## ⑦ CD signal control

C	N*
Yes	Ignore

\* Default setting

## ⑧ Buffer busy control

B*	N
Yes	Ignore

\* Default setting

## ⑨ SI/SO control

S	N*
Yes	Ignore

\* Default setting

- When the baud rate is set at 9600bps, the character bit length must be 8 bits.
- Files loaded via the RS-232C interface are always loaded as unnamed sequential files.
- Loading of files via the RS-232C interface is terminated when character code 1A (H) is received. If character code 1A (H) is not received, you can manually terminate file load by pressing the **[BRK]** key.

**[ save ]**

Press the function key under this selection to store a file to cassette tape, floppy disk, or the memory of the PB-2000C. This function can also be used to send files from the PB-2000C to a personal computer or other device.

**To save to memory**

This procedure makes it possible to make a duplicate of a file in memory, under a different name.

1. Use the cursor keys to change the current selection so that the name of the file you wish to save is highlighted.

```

EXAMPLE1.  C
[ name  ][ kill ][ load  ][ save  ]

```

2. Press the function key under **[save ]**, and one of the three following displays will appear.

If you are not using an interface unit.

**[save ]**

```

EXAMPLE1.  C
save "EXAMPLE1.

```

If you are using the FA-7 Interface Unit.

**[save ]**

```

EXAMPLE1.  C
save"  [RAM  ][RS232C][MT  ]

```

If you are using the MD-100 Interface Unit.

**[save ]**

```

EXAMPLE1.  C
save"  [RAM  ][RS232C][disk ]

```

- Press the function key under **[RAM ]** to specify that you wish to save the selected file in RAM if you are using the FA-7 or MD-100.

[RAM ]

```
EXAMPLE1. C
save "EXAMPLE1.
```

- Be sure to change the filename, and then press **[EXE]**.

CASIO

**[DEL]** **[DEL]** **[DEL]**

```
EXAMPLE1. C
save "CASIO_
```

**[EXE]**

```
EXAMPLE1. C CASIO . C
[name ][kill ][load ][save ]
```

- Unnamed files and files that do not contain data cannot be saved.
- A "BF error" occurs if you try to save a file to RAM without first changing its filename.

### To save a file to a cassette tape

- Connect the optional FA-7 Interface Unit, load a cassette tape, and simultaneously press the PLAY and REC buttons on the cassette tape recorder. When using a tape recorder without a REMOTE jack, press the PLAY and REC buttons of the tape recorder after Step 4 below.
- Use the cursor keys to change the current selection so that the name of the file you wish to save is highlighted.

```
EXAMPLE1. C
[name ][kill ][load ][save ]
```

- Press the function key under **[save ]**, and the following display will appear.

[save ]

```
EXAMPLE1. C
save" [RAM ][RS232C][MT ]
```

- Press the function key under **[MT ]** to specify that you wish to save the file to a cassette tape. At this time the **[RAM ]**, **[RS232C]** and **[MT ]** selections disappear from the display, and "CAS0:" appears.

[MT ]

```
EXAMPLE1. C
save"CAS0:_
```

- If you wish to change the filename under which the file will be saved on the cassette tape, change the name and press **[EXE]**.  
If you wish to save the file with the same filename, simply press the **[EXE]** key.
- After the save operation is complete, the main menu appears on the display.

```
EXAMPLE1. C
[name ][kill ][load ][save ]
```

- Unnamed files and files that do not contain data cannot be saved.

### To save a file to a floppy disk

- Connect the optional MD-100 Interface Unit and insert a floppy disk.
- Use the cursor keys to change the current selection so that the name of the file you wish to save is highlighted.

```
EXAMPLE1. C
[name ][kill ][load ][save ]
```

3. Press the function key under [save ], and the following display will appear.

[save ]

```
EXAMPLE1. C
save" [RAM ][RS232C][disk ]
```

4. Press the function key under [disk ] to specify that you wish to save to a floppy disk. At this time the [RAM ], [RS232C] and [disk ] selections disappear from the display, and "0:" appears.

[disk ]

```
EXAMPLE1. C
save"0:EXAMPLE1.
```

5. If you wish to change the filename under which the file will be saved on the floppy disk, change the name and press **EXE**.  
6. After the save operation is complete, the main menu appears on the display.

```
EXAMPLE1. C
[name ][kill ][load ][save ]
```

- Unnamed files and files that do not contain data cannot be saved.

### To save a file via the RS-232C interface

1. Connect the optional FA-7 or MD-100 Interface Unit.
2. Set the RS-232C switch on the left side of the interface unit to the ON position.

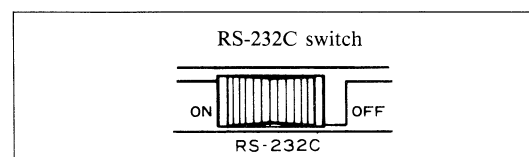

3. Use the cursor keys to change the current selection so that the name of the file you wish to save is highlighted.

```
EXAMPLE1. C
[name ][kill ][load ][save ]
```

4. Press the function key under [save ], and one of the two following displays will appear.

If you are using the FA-7 Interface Unit

[save ]

```
EXAMPLE1. C
save" [RAM ][RS232C][MT ]
```

If you are using the MD-100 Interface Unit

[save ]

```
EXAMPLE1. C
save" [RAM ][RS232C][disk ]
```

5. Press the function key under [RS232C] to specify that you wish to save file via the RS-232C interface. At this time, the display appears as follows.

[RS232C]

```
EXAMPLE1. C
save"COM0:2,E,8,1,N,N,N,B,N
```

Each of these characters represent a *parameter*. See the section titled **About parameters** on page 59 for details.

6. If you wish to change the filename under which the file will be saved via RS-232C interface, use the cursor keys to change the name and press **EXE**.  
If you wish to save the file with the same filename, just press the **EXE** key.

7. After the save operation is complete, the main menu appears on the display.

```
EXAMPLE1. C
[ name ] [ kill ] [ load ] [ save ]
```

### [ data ]

Press the function key under this selection to enter the DATA EDIT mode for editing of a sequential data file. If an unnamed sequential data file already exists in memory, that file is automatically entered and its first line is displayed. If an unnamed file does not exist, one is created automatically.

#### To search for data in the DATA EDIT mode

We will demonstrate the [search] function using the following display.

1. Press the function key under [data] to enter the DATA EDIT mode.

```
[ data ]
SALESDEPT, CASIO 242-681-1111
MARKETING, CASIO 242-681-1112
PURCHASING, CASIO 242-681-1121
[ search ] [ next ] [ delete ] < 1 >
```

2. Press the function key under [search]. At this time the prompt "search?" appears to ask you for the data you wish to search for.

```
[ search ]
SALESDEPT, CASIO 242-681-1111
MARKETING, CASIO 242-681-1112
PURCHASING, CASIO 242-681-1121
search?_ < 1 >
```

3. Enter the data you wish to find (up to eight characters long) and press **EXE** to begin the search.

```
ABC SPC CO
SALESDEPT, CASIO 242-681-1111
MARKETING, CASIO 242-681-1112
PURCHASING, CASIO 242-681-1121
search?ABC CO_ < 1 >
```

**EXE**

```
SALES DIVISION, ABC CO 367-141-11
ADVERTISING DEPT, ABC CO 367-141-
[ search ] [ next ] [ delete ] < 4 >
```

4. Press the function key under [next] to search for the next occurrence of the characters you specified.

[ next ]

```
ADVERTISING DEPT, ABC CO 367-141-
1114
ACCOUNTING DEPT, ABC CO 367-141-1
[ search ] [ next ] [ delete ] < 5 >
```

5. When you find the place you are searching for, press the **⇐** or **⇒** key to exit the search.

- Though it is possible to enter more than eight characters for the search, only the initial eight are used by the computer.
- You cannot specify a space as the last character of those you want to find.
- If the characters that you specify cannot be found, the computer will display the last record of the sequential data file.

#### To delete records in the DATA EDIT mode

1. Press the function key under [delete]. At this time the prompt "delete?" appears to ask you what is the record number of the record you wish to delete.

[ delete ]

```
SALESDEPT, CASIO 242-681-1111
MARKETING, CASIO 242-681-1112
PURCHASING, CASIO 242-681-1121
delete?_ < 1 >
```

The following examples show the possible entries in response to the "delete?" prompt.

[ delete ]	<b>2</b> <b>EXE</b>	deletes Record 2
[ delete ]	<b>2</b> <b>-</b> <b>5</b> <b>EXE</b>	deletes Records 2 through 5
[ delete ]	<b>-</b> <b>5</b> <b>EXE</b>	deletes Records 1 through 5
[ delete ]	<b>2</b> <b>-</b> <b>EXE</b>	deletes Record 2 onward

**[ llist ]**

Press the function key under this selection to output a file to a printer.

**To output a file to a printer**

1. Connect a printer and insert paper.
2. Use the cursor keys to change the current selection so that the name of the file you wish to print is highlighted.

```
EXAMPLE1 . C
[data ][llist ][merge ][preset]
```

3. Press the function key under [llist ]. The menu display clears and printing begins. When printing is complete, the computer returns to the main menu.

- The [llist ] function is not available when there are no files contained in the memory of the computer or when a printer is not connected.
- The computer stands by if the printer goes off line or if a printer error occurs.

**[ merge ]**

Press the function key under this selection to merge a file from memory, cassette tape or floppy disk to the end of the currently selected file. You can also use this function to merge a file from another device via the RS-232C interface.

A file from cassette tape can only be merged with the latest file stored to memory of the PB-2000C (i.e. the last filename on the filename menu). If you want to merge a file from cassette tape to a file in memory that is not the latest one stored, simply make a renamed copy of the file in RAM (see page 61), so that the renamed copy becomes the latest file stored.

**To merge files**

The procedure to merge files is identical to that used for the [load ] operation described on page 54.

**[ preset ]**

Press the function key under this selection to specify the currently selected file as a preset file, or to cancel a preset file specification.

**To specify a file as a preset file**

1. Use the cursor keys to change the current selection so that the name of the file you wish to specify as a preset file is highlighted.

```
CASIO . C
[data ][llist ][merge ][preset]
```

2. Press the function key under [preset]. At this time an asterisk will appear before the identifier to indicate that the currently selected file is now a preset file.

[preset]

```
CASIO . *C
[data ][llist ][merge ][preset]
```

- You can specify up to four files as preset files.
- Only the first six characters of preset filenames are displayed in the preset filename menu of the CAL mode.
- You can switch display of the preset filename menu ON and OFF by pressing the  key.

**To cancel a preset file specification**

1. Use the cursor keys to change the current selection so that the name of the preset file you wish to cancel is highlighted.

```
CASIO . *C
[data ][llist ][merge ][preset]
```

2. Press the function key under [preset]. At this time the asterisk before the identifier of the preset file will disappear to indicate that the currently selected file is no longer a preset file.

[preset]

```
CASIO . C
[data ][llist ][merge ][preset]
```



**To execute a preset file**

1. Press the **[CAL]** key to enter the CAL mode. The first six characters of the filenames of the files that you have specified as preset files appear in the preset filename menu at the bottom of the display.

```

_
[CASIO ][EXAMPL][INV-2 ]

```

2. Press the function key under name of the preset file you wish to execute. At this time the computer enters the C interpreter and loads the selected file. If the files you execute is a sequential data file, the computer enters the DATA EDIT mode. For details on the C function, refer to the separate Introduction to the C Programming Language manual.

**[C/S ]**

Press the function key under this selection to change the identifier of the currently selected filename.

**To change the identifier of a filename**

1. Use the cursor keys to change the current selection so that the name of the filename whose identifier you wish to change is highlighted.

```

CASIO . S EXAMPLE1 . S
ADDRESS . S math . C
INV-2 . C
[C/S ][set ][memory]

```

2. Press the function key under **[C/S ]** to change the identifier of the currently selected filename. Each press changes the identifier in the sequence C → S → C, etc.

- This function cannot be used if there are any unnamed files with an identifier of C and S currently in memory.

This operation should only be used when loading a ROM card into the PB-2000C. If you install a ROM card for Prolog, for example, all C file (files with the C identifier) are automatically deleted from memory. If you change the identifier of a C file to S before loading the new ROM card, the contents of the file are protected.

**[set ]**

Press the function key under this selection to display the current operational status of the computer. You can also make various changes in the operational status to suit your individual needs.

**To change the operational status of the computer**

1. Press the function key under **[set ]** to display the operational status of the computer.

[set ]

```

key beep (Y/N) tab (1-8)
sw on(Cal/Menu) APO (2-255)
error stop(Y/N)
>Y,8,C,7,Y

```

2. Use the cursor keys to move the cursor left and right along the bottom line of the display, and make changes in the status by entering the proper characters as described below. Skip this step if you do not wish to change the operational status.
3. Press the **[EXE]** key to return to the main menu.

**Operational status settings**

The default setting for the operational status is Y,8,C,7,Y following the NEWALL operation. You can change the settings in accordance with the following.

**1. key beep (Y/N)**

- Y — Beep sound produced each time you press a key.
- N — No beep sound.

**2. tab (1~8)**

The value indicates the number of spaces to be entered when the **[TAB]** key is pressed.

**3. sw on (Cal/Menu)**

- C — Computer automatically enters the CAL mode when you switch power ON.
- M — Computer automatically enters the MENU mode when you switch power ON.

**4. APO (2 — 255)**

The value indicates the number of minutes that pass before activation of the Auto Power OFF function.

**5. error stop (Y/N)**

- Y — Error message displayed and execution terminated when execution of a C program is interrupted by an error.
- N — Error message not displayed and execution continues when execution of a C program is interrupted by an error.
- See the separate Introduction to the C Programming Language manual for further details.

**[ memory ]**

Press the function key under this selection to check the memory status of the computer.

**To change the memory status of the computer**

1. Press the function key under **[memory]**. At this time, the general memory status display will appear. The meaning of each value is described below.

General memory status display

<memory>	c	file	work
26111	20992	4095	1024
free		1011	900
c, file?_20992, 4095			

2. Use the cursor keys to move the cursor left and right a between the C area and file area values on the bottom of the display, and make changes in the values by entering values. Note the restrictions in this operation in the section **Understanding the memory status display**, below.  
Skip to step 3 if you do not wish to change the general memory values.
3. Press the **[EXE]** key to re-display the general memory status display again with the newly changed values. At this time, you can make further changes as in Step 2, above.
4. Press the **[EXE]** key to proceed to the C area memory status display.

C area memory status display

<c>	code	symbol	stack
20992	5248	5248	10496
free	2156	3175	9650
code, symbol?_5248, 5248			

5. Use the cursor keys to move the cursor left and right between the code area and symbol area values on the bottom of the display, and make changes in the values by entering values. Note the restrictions in this operation in the section **Understanding the memory status display**, below.  
Skip to Step 7 if you do not wish to change the memory values.
6. Press the **[EXE]** key to re-display the C area memory status display again with the newly changed values. At this time, you can make further changes as in Step 5, above.
7. Press **[EXE]** to return to the main menu display.

**Understanding the memory status displays****1. General memory status display**

- The second line of this display shows the total user area capacity (in bytes), as well as a breakdown (from left to right) of the memory capacities of the C area, file area, and work area. The third line shows the amount of memory that is yet unused (free) in the file and work areas.
- You can change the values in the fourth line of the display by entering the desired values for the C area and file area. The work area value is produced by the following calculation:

$$\text{work area} = \text{user area} - \text{C area} - \text{file area}$$

$$1024 = 26111 - 20992 - 4095 \text{ (in example display)}$$

- Whenever you change the C area value, the C area contents are deleted.
- The file area value cannot be made less than that required for storage of files currently in memory.
- To increase the file area without decreasing the work area, decrease the size of the C area.
- All variables currently being used in the CAL mode are deleted when any change is made in the general memory status display.

**2. C area memory status display**

- The second line of this display shows the total C area capacity (in bytes), as well as a breakdown (from left to right) of the memory capacities of the code area, symbol area, and stack area. The third line shows the amount of memory that is yet unused (free) in the code, symbol and stack areas.
- You can change the values in the fourth line of the display by entering the desired values for the code area and symbol area. The stack area value is produced by the following calculation:

$$\text{stack area} = \text{C area} - \text{code area} - \text{symbol area}$$

$$10496 = 20992 - 5248 - 5248 \text{ (in example display)}$$

- Whenever you change a value in this display, the C area contents are deleted.

**Important**

- The following table shows the default values for the various memory areas following the NEWALL operation.

Memory area	32K byte RAM	64K byte RAM
User area (fixed)	26111	58879
work	1024	1024
file	4095	8191
C	20992	49664
code	5248	12416
symbol	5248	12416
stack	10496	24832

- The minimum value for the C area is 4,096 bytes.
- A portion of the code, symbol and stack areas are used internally by the computer even following the NEWALL operation.
- When you change the C area value, memory is reserved in the following ratio: code=1: symbol=1: stack=2.
- The work area requires at least 256 bytes.
- The code area requires at least 512 bytes.
- The symbol area requires at least 512 bytes.
- The stack area requires at least 1,024 bytes.
- A "BS error" occurs if area values are specified outside of their specified ranges.

See the Introduction to the C Programming Language manual for details on changing the memory size and the contents held in each area.

# Chapter 3

## Getting Bigger

In this chapter you will be introduced to the versatile expandability of the PB-2000C with the addition of a number of optional accessories. You will see how the PB-2000C can be made much more powerful with the addition of optional ROM cards, an expansion RAM pack, an interface unit, and printer.

## 3-1 Optional ROM cards

Besides C, the PB-2000C is capable of running Prolog and BASIC when you install the corresponding optional ROM card.

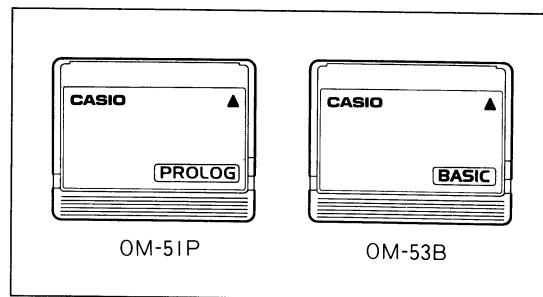

### Loading an optional ROM card

Before handling the optional ROM cards, be sure to first touch a doorknob or other metal object to discharge any static electricity that may be built up on your fingertips. Static electricity can damage the internal circuitry of the ROM card.

The following procedures start with the removal of a ROM card, because even if you have never used a ROM card before, there should be a dummy card loaded inside of the ROM card slot. This dummy card is present to protect the connectors inside of the slot, and should be removed before you load a ROM card.

### To remove a ROM card from the computer

1. Switch the power of the PB-2000C OFF.
2. Slide the ROM card lock on the back of the computer to the left as illustrated.

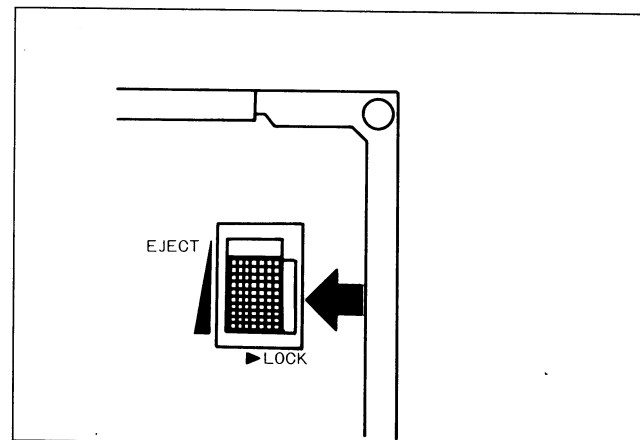

3. Slide the ROM card lock up, in the direction indicated by the EJECT arrow. This will eject any ROM card or dummy card currently loaded in the ROM card slot.

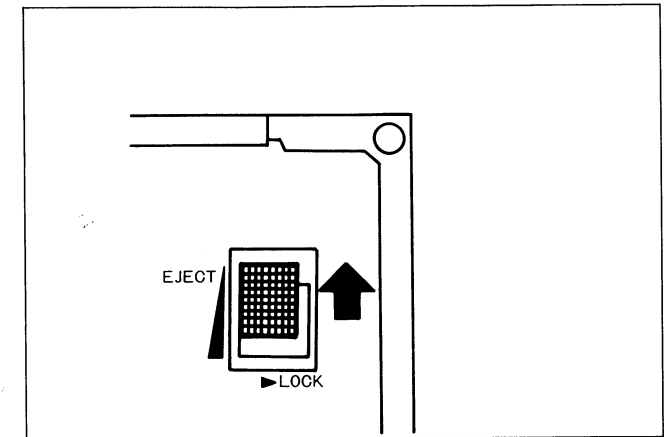

- Keep the dummy card handy in case you later wish to remove the ROM card. The dummy card protects internal connectors from dirt and dust, and should always be loaded whenever you remove a ROM card from the PB-2000C.

### To load a ROM card into the computer

1. Switch the power of the PB-2000C OFF.
2. Position a ROM card as shown in the illustration and insert the card into the ROM card slot. Gently insert the card into the slot as far as it will go.

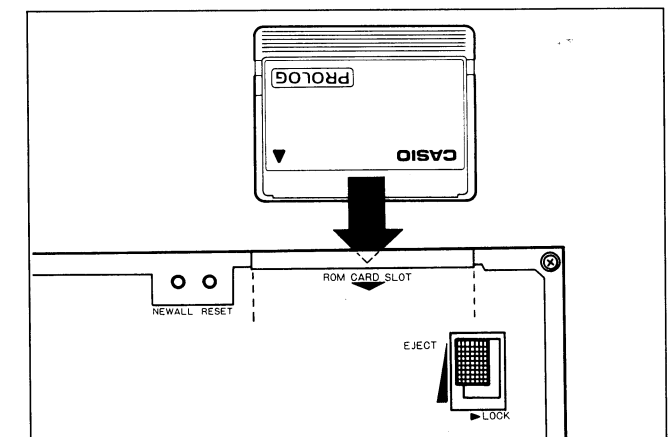

**Important:** Set the ROM card lock into the LOCK position when using built-in C even if the dummy card is not loaded in the computer.

3. Slide the ROM card lock on the back of the computer in the direction of the LOCK arrow.
4. Switch the power of the computer ON.

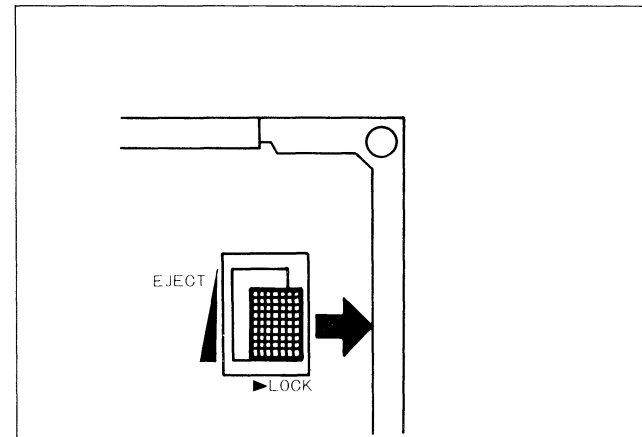

## 3-2 RP-33 expansion RAM pack

The 32K byte RAM of the PB-2000C can be expanded to 64K bytes with the addition of the optional RP-33 expansion RAM pack.

### Loading the RAM pack

Before handling the optional RAM pack, be sure to first touch a doorknob or other metal object to discharge any static electricity that may be built up on your fingertips. Static electricity can damage the internal circuitry of the RAM pack.

Note that after you load the RAM pack you will have to initialize both the hardware and memory of the computer. This will erase all files stored in memory. Be sure to make backup copies of all important data and programs before performing the initialization procedure.

### To load the RAM pack

1. Switch the power of the PB-2000C OFF.
2. Remove the three screws that hold the back cover of the computer in place, and remove the back cover.

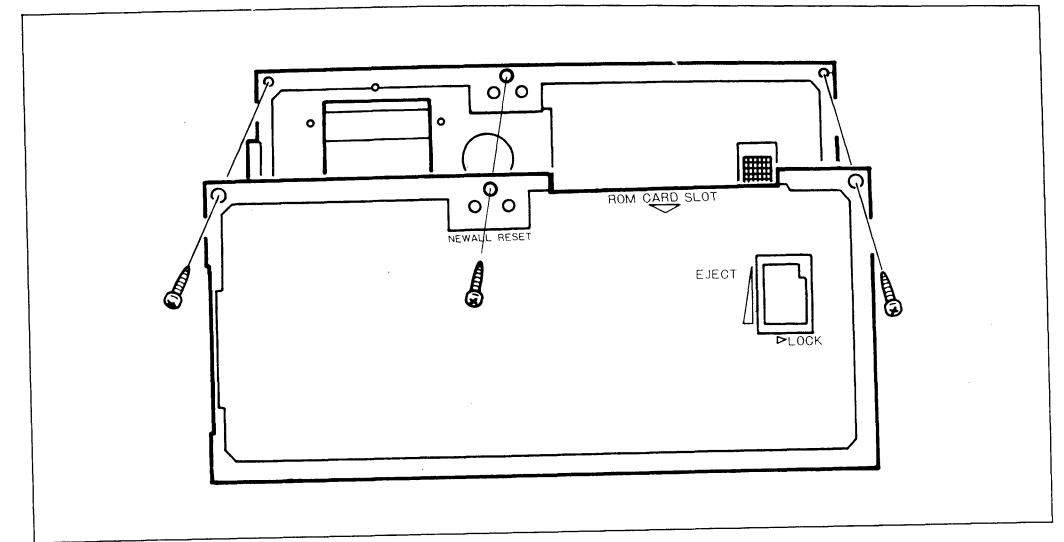

3. Install the RAM pack into the RAM pack socket, and secure it in place using the three screws provided (see illustration). When installing the screws, you will have to push down quite strongly on the RAM pack. The computer is designed this way to ensure proper contact between the RAM pack and the computer even if the computer is subjected to strong shock.

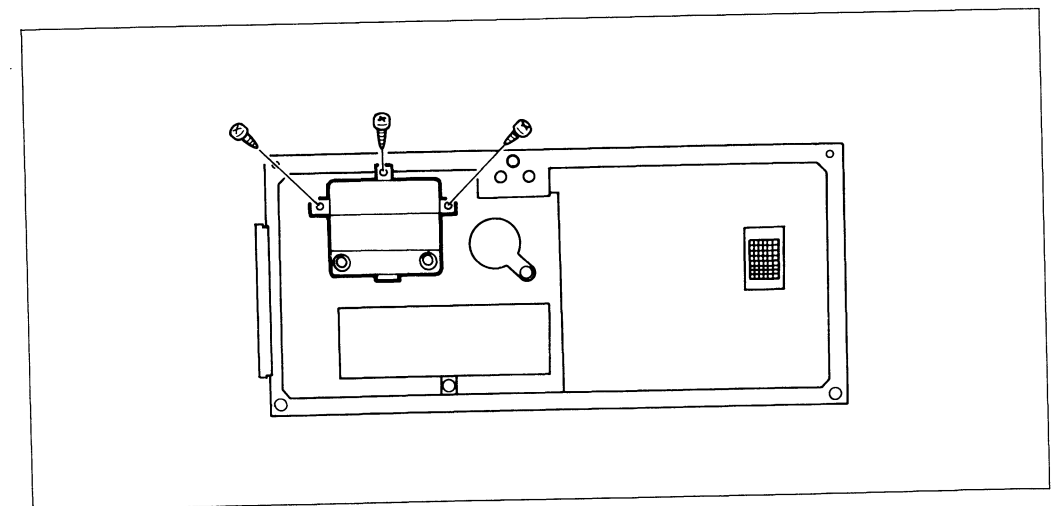

4. Replace the back cover of the computer.
5. Switch power ON and press the RESET button and the NEWALL button with a thin pointed object.

**Important**

- Be sure to press the NEWALL button whenever you install or remove the RAM pack. Otherwise, meaningless data may appear on the display.
- Dust, dirt or fingerprints on the PCB connector of the RAM pack connector may cause poor connection and improper operation. Be sure to protect the connector at all times.
- Whenever you remove the RAM pack from the computer, be sure to store it in its original case to protect it against dust and dirt.

### 3-3 MD-100 Interface Unit

The MD-100 Interface Unit provides the following three devices in a single unit:

- 3.5-inch floppy disk drive — for storage and retrieval of data using floppy disks.
- RS-232C interface — for data communications via an RS-232C cable.
- Centronics interface — for connection with a printer via a Centronics cable.

#### To connect the computer to the MD-100

Before beginning with the following procedure, be sure to first read the instructions that come with the MD-100.

1. Insert the computer into its accessory hard case (see page 6 for details). Never try to connect the computer directly. Doing so can damage connectors.
2. Switch the power of the computer OFF.
3. Slide the computer/hard case to the right along the guide at the front of the interface unit (see illustration). Gently but firmly press the computer/hard case against the interface unit connector.

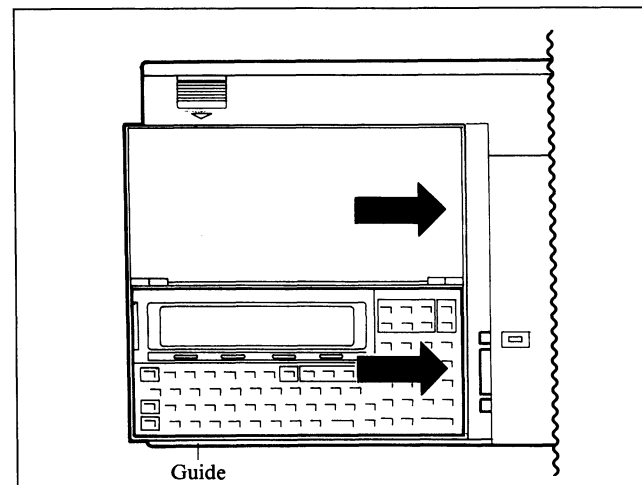

4. When the computer/hard case is as far to the right as it can go, set the lock on the MD-100 to the LOCK position.

5. Switch the power of the computer ON and confirm that the power indicator of the interface unit lights green.

- The power indicator of the interface unit will change to red when battery power becomes too low. At this time, either change batteries or switch to the AC adaptor as soon as possible, to avoid damage to files stored in memory.
- Be sure that the power of the computer is switched OFF before you connect it to or disconnect it from the interface unit.

#### Using floppy disks

##### To load a floppy disk into the drive

1. Position a floppy disk as should in the illustration and insert it into the drive.
2. Gently press on the end of the disk until it enters the drive as far as it can go.

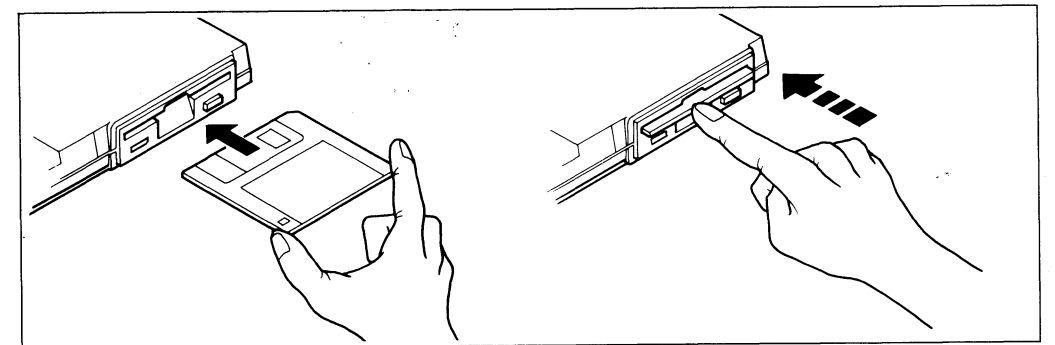

##### To remove a floppy disk from the drive

1. Before removing a floppy disk from the drive, be sure to check that the access lamp is not lit. If you remove a disk while the computer is accessing it (which is what a lit access lamp indicates), you can damage the disk or the data stored on it.
2. Press the eject button. The disk will pop partially out of the drive and stop. Grasp the disk and pull it the rest of the way out of the drive.

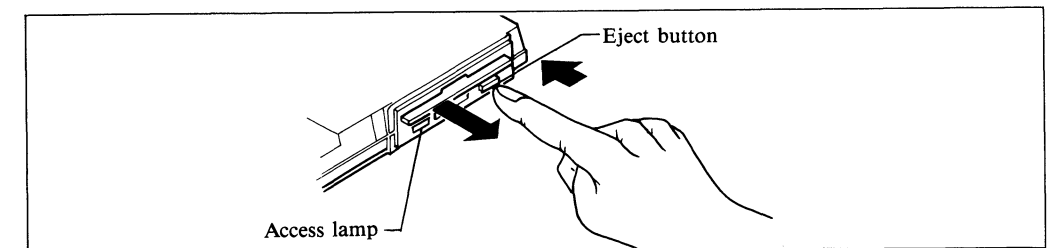

## Formatting disks

Before a disk can be used it must be *formatted*. The formatting operation puts that tracks on the disk into a style that the PB-2000C can write to and read from. You can also format a disk that contains data to completely erase everything stored on the disk.

### To format a disk

1. Load the disk to be formatted into the disk drive.
2. Press the **[CAL]** key to enter the CAL mode.
3. Enter **FORMAT [EXE]**.

The formatting operation will take about one minute.

## RS-232C interface

Before you can exchange files via the RS-232C interface, you must first switch it ON using the switch on the left side of the interface unit.

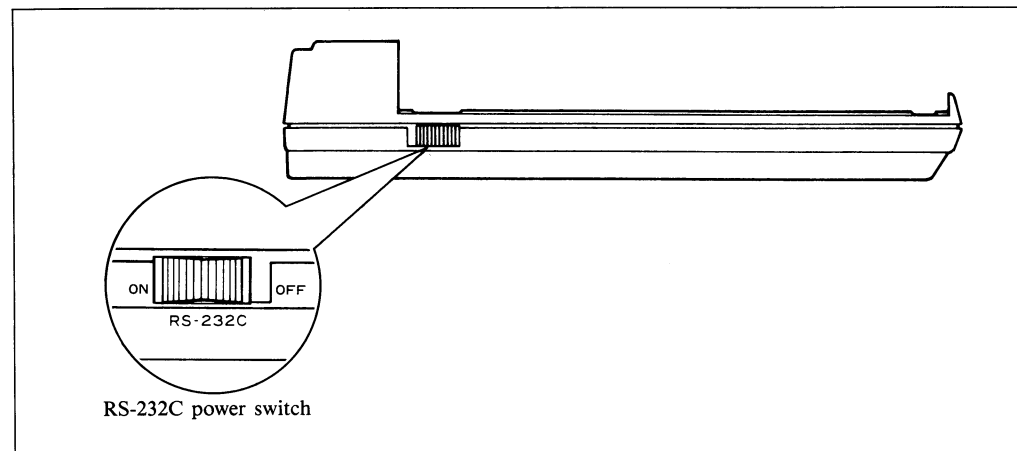

## Baud rate

The baud rate can be set by software or by setting the switches located on the back of the interface unit. The following table shows all of the possible switch settings.

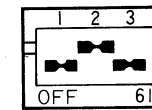

BPS	1	2	3
75	OFF	OFF	OFF
150	ON	OFF	OFF
300	OFF	ON	OFF
600	ON	ON	OFF
1200	OFF	OFF	ON
2400	ON	OFF	ON
4800	OFF	ON	ON
9600	ON	ON	ON

### Centronics interface

You can connect the PB-2000C to a Centronics standard printer via the Centronics interface of the MD-100. The following table shows the pin assignments for the required Centronics cable.

No.		Description	No.		Description
1	Out	STROBE	19		GND
2	Out	DATA 1	20		GND
3	Out	DATA 2	21		GND
4	Out	DATA 3	22		GND
5	Out	DATA 4	23		GND
6	Out	DATA 5	24		GND
7	Out	DATA 6	25		GND
8	Out	DATA 7	26		GND
9	Out	DATA 8	27		GND
10	In	ACKNLG	28		GND
11	In	BUSY	29		GND
12		NC	30		GND
13		NC	31	Out	INIT
14		NC	32	In	ERROR
15		NC	33		GND
16		NC	34		NC
17		NC	35		NC
18		NC	36		NC

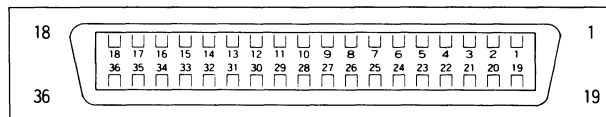

Control lines

- |           |                  |
|-----------|------------------|
| 1. STROBE | } Output control |
| 2. INIT   |                  |
| 3. ACKNLG | } Input control  |
| 4. BUSY   |                  |
| 5. ERROR  |                  |

### 3-4 FA-7 Interface Unit

The FA-7 Interface Unit provides the following three devices in a single unit:

- Cassette interface — for storage and retrieval of data using cassette tapes.
- RS-232C interface — for data communications via an RS-232C cable.
- Centronics interface — for connection with a printer via a Centronics cable.

#### To connect the computer to the FA-7 interface unit

Before beginning with the following procedure, be sure to first read the instructions that come with the FA-7 interface unit.

1. Insert the computer into its accessory hard case (see page 6 for details). Never try to connect the computer directly. Doing so can damage connectors.
2. Switch the power of the computer OFF.
3. Slide the computer/hard case to the right along the guide at the front of the interface unit (see illustration). Gently but firmly press the computer/hard case against the interface unit connector.
4. When the computer/hard case is as far to the right as it can go, set the lock on the FA-7 to the LOCK position.
5. Switch the power of the computer ON and confirm that the power indicator of the interface unit lights green.

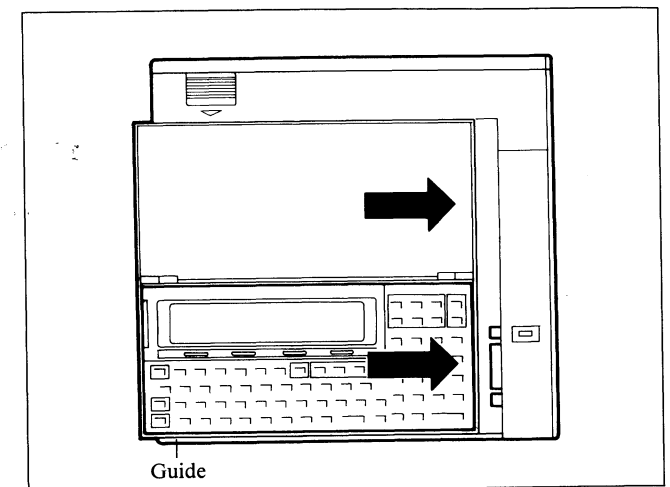

- The power indicator of the interface unit will change to red when battery power becomes too low. At this time, either change batteries or switch to the AC adaptor as soon as possible, to avoid damage to files stored in memory.
- Be sure that the power of the computer is switched OFF before you connect it to or disconnect it from the interface unit.



## Using the cassette interface

### To connect a tape recorder to the interface unit

1. Connect the cassette tape recorder to the interface unit using an optional SB-52 cable, as illustrated below.

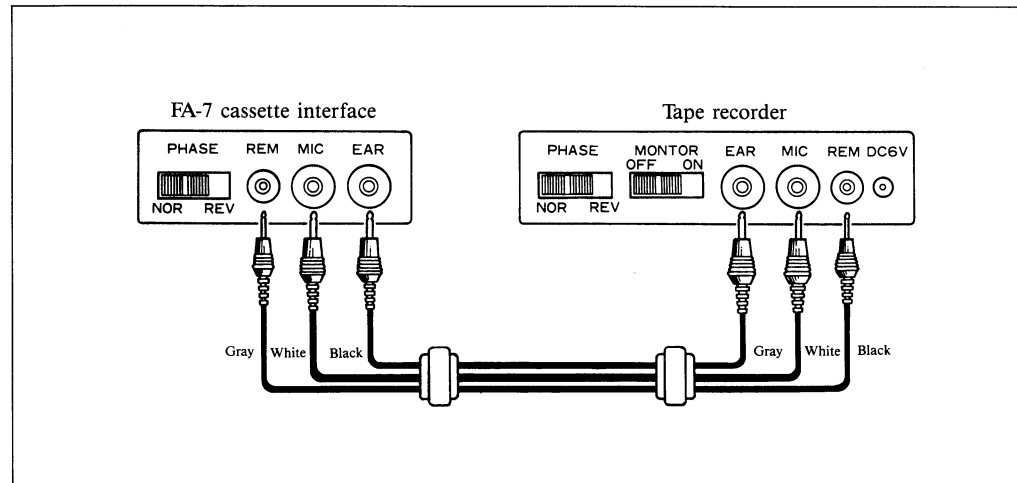

- If your tape recorder does not have an EAR jack, connect to the LINE OUT or similar jack.
- If your tape recorder does not have a MIC jack, connect to the LINE IN or similar jack.
- If your tape recorder does not have a REM jack, do not connect the gray plugs.
- Depending on the type of tape recorder you are using, you may have to experiment with the NOR/REV setting of the PHASE switch to find what setting provides the best results.
- The baud rate for data exchanges with the cassette recorder can be set to 300, 600, 1200, or 2400bps. The setting you use generally depends on the capabilities of your cassette tape recorder. If you try to set the baud rate outside of the range of 300~2400bps, an "AM error" will occur. See page 56 for details on setting the baud rate.

## Load operation troubleshooting

### No display while cassette tape moves

- Check that the computer, the FA-7 interface unit, the SB-52 cable and the tape recorder are correctly connected.
- Check the power supply of the interface unit. Remember, a red power indicator means low battery power.
- Be sure that the volume of the tape recorder is set at or near its maximum.
- Be sure that the baud rate is at the same setting as that used during the save operation.

### Filename displayed, but file is skipped by recorder which fast forwards to next file

- Check for mistakes in your specified filename. It must match exactly the name of the file you wish to load.

### Error occurs and cassette tape movement stops

- Check for damage or soiling of the tape. Data from damaged tapes cannot be loaded. Be sure to store tapes in their cases to protect against damage.
- Data from cassette tapes that contain excessive noise cannot be loaded. Keep tapes away from magnets (i.e. televisions, speakers, motors).

## RS-232C interface

The RS-232C interface of the FA-7 interface unit is identical to that of the MD-100 interface unit. See page 82 for details.

## Centronics interface

The Centronics interface of the FA-7 interface unit is identical to that of the MD-100 interface unit. See page 84 for details.

### 3-5 FP-100 Plotter Printer

The optional FP-100 is a 4-color plotter printer that prints data from the PB-2000C on A4 size paper.

#### To connect the computer to the FP-100 plotter printer

Before beginning with the following procedure, be sure to first read the instructions that come with the FP-100 plotter printer.

1. First connect the computer to an optional MD-100 or FA-7 interface unit.
2. Ensure that the power of the computer and the printer are switched OFF.
3. Connect the printer to the Centronics interface of the interface unit, using an optional SB-51 printer cable.

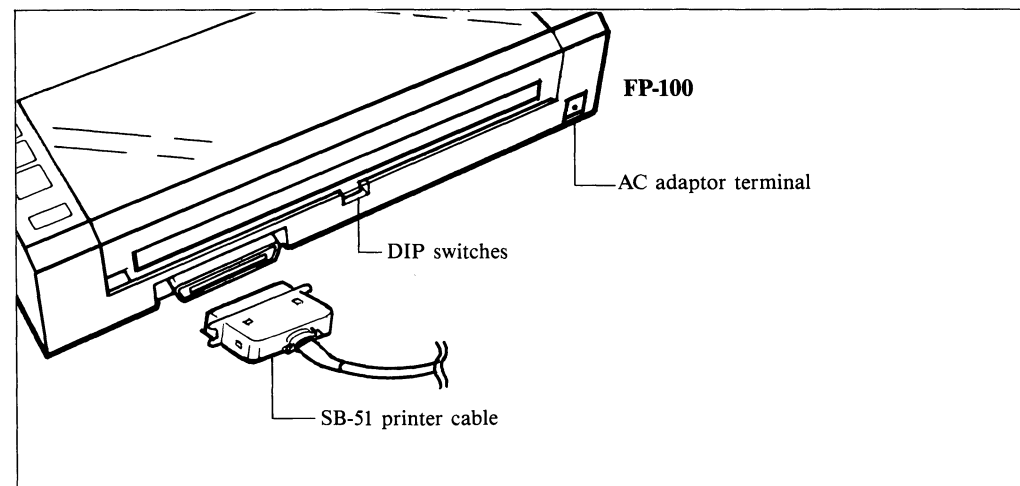

### 3-6 FP-40 Character Printer

The FP-40 is a thermal printer that lets you print data from the PB-2000C computer.

#### To connect the computer to the FP-40 printer

Before beginning with the following procedure, be sure to first read the instructions that come with the FP-40 printer.

1. First connect the computer to an optional MD-100 or FA-7 interface unit.
2. Ensure that the power of the computer and the printer are switched OFF.
3. Remove the connector cover and set the DIP switches of the printer. Set Switch 1 to OFF.
4. Install the SB-43 interface pack onto the printer, and secure in place with the screws provided.
5. Connect the printer to the Centronics interface of the interface unit, using an optional SB-51 printer cable.

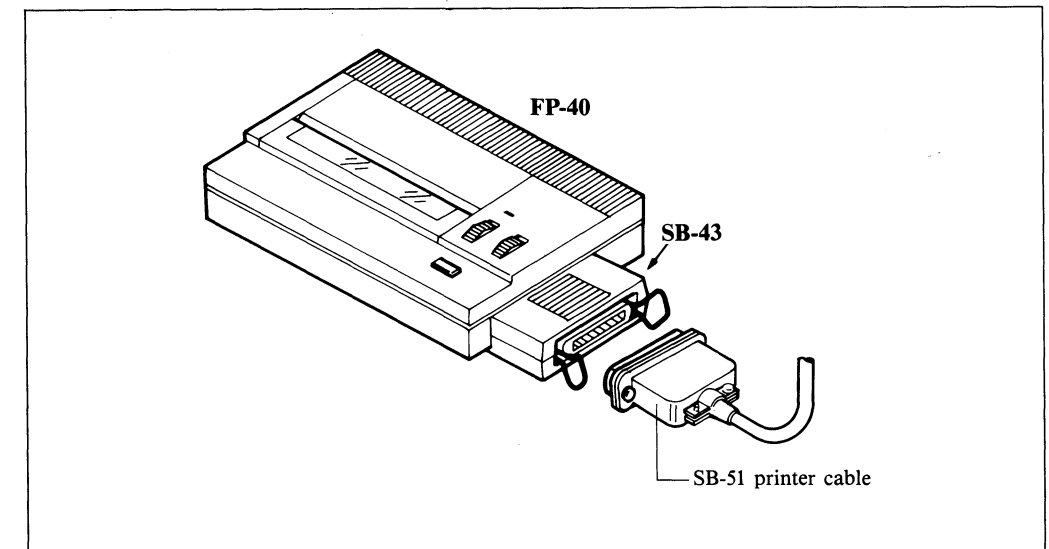

---

# Chapter 4

---

## Getting Technical

**T**his chapter contains such technical information as a character code table and error message table.

---

## Error messages

The following is a table of error messages that are not related to C interpreter. For C error messages, see the separate Introduction to the C Programming Language manual.

Message	Meaning	Countermeasures
OM error	Memory overflow	Execute the CLEAR command. Change the [memory] setting.
SN error	Syntax error	Check spelling of command names, etc.
TC error	Formula too complex.	Break formulas down into simpler parts.
BV error	Overflow of input/output buffer.  Logical line length exceeds 255 characters.	Set the RS-232C baud rate to a slower speed. Set XON/OFF for RS-232C. Keep logical lines within 255 characters.
NF error	Specified filename not found.	Check filename.
LB error	MD-100 battery power too low.	Change batteries. Use the AC adaptor.
NR error	Input/output cannot be performed.	Check input/output connections. Check to see if floppy disk is loaded in drive.
FL error	No space on floppy disk left for writing data.	Delete no longer needed files. Use a different floppy disk.
OV error	Calculation result or input exceeds allowable range.	Check calculation values.
MA error	Mathematical error, such as division by 0, etc. Scientific function argument outside of prescribed range.	Check calculation formulas and values.
BS error	Argument or parameter outside of prescribed range.	Check subscripts.
FC error	Illegal call of function or statement. Attempt to execute an unexecutable statement.	Check arguments and statements.
RW error	Incorrect operation of input/output device.	Check input/output device. Floppy disk needs formatting.
BF error	Illegal filename specification.	Check filename.

Message	Meaning	Countermeasures
UL error	Incorrect line number entered for [delete].	Enter line number correctly.
TM error	Mismatch of variable type and data type, or wrong type of argument used in scientific function.	Use correct format.
PR error	Attempt made to write to a write protected floppy disk.	Remove the write protection.
DA error	Attempt made to load data when no data is available.	Try again. Check data. Disk damaged and needs reformatting.
FM error	Disk damaged or not yet formatted.	Format disk.
OP error	Attempt made to access a file that is not opened.	Try again. Disk damaged and needs reformatting.
AM error	Cassette tape baud rate setting for load does not match setting used for save. Attempt made to access file that is neither C file or sequential file.	Use correct baud rate setting.  Files without identifier C or S cannot be accessed.
FR error	Framing error.	Check RS-232C or cassette tape connection, data communication method, etc.
PO error	Parity error or overrun error.	Check RS-232C or cassette tape connection, data communication method, etc. Use a slower baud rate setting.
DF error	Abnormal floppy disk drive operation.	If this error persists, the floppy disk drive may be faulty
?? error	Undefined error.	Computer is not operating correctly. Press the RESET and NEWALL buttons to initialize the hardware and memory.

Character code table

HEX	0	1	2	3	4	5	6	7	8	9	A	B	C	D	E	F
0		(ROLL DOWN) 0 16	SP 32	0 48	@ 64	P 80	' 96	p 112	Ç 128	É 144	á 160	⋮ 176	⌞ 192	⌚ 208	α 224	≡ 240
1	(ROLL UP) 1 17	(DEL) 33	! 49	1 65	A 81	Q 97	a 113	q 129	ü 145	æ 161	í 177	⌞ 193	⌚ 209	β 225	± 241	
2	(LINE TOP) 2 18	(INS) 34	" 50	2 66	B 82	R 98	b 114	r 130	é 146	Æ 162	ó 178	⌞ 194	⌚ 210	Γ 226	≥ 242	
3	3 19	35	# 51	3 67	C 83	S 99	c 115	s 131	â 147	ô 163	ú 179	⌞ 195	⌚ 211	π 227	≤ 243	
4	4 20	36	\$ 52	4 68	D 84	T 100	d 116	t 132	ä 148	ö 164	ñ 180	⌞ 196	⌚ 212	Σ 228	∫ 244	
5	(LINE DEL) 5 21	37	% 53	5 69	E 85	U 101	e 117	u 133	à 149	ò 165	Ñ 181	⌞ 197	⌚ 213	σ 229	∫ 245	
6	(LINE END) 6 22	38	& 54	6 70	F 86	V 102	f 118	v 134	â 150	û 166	ä 182	⌞ 198	⌚ 214	μ 230	÷ 246	
7	(BEL) 7 23	39	' 55	7 71	G 87	W 103	g 119	w 135	ç 151	ù 167	ö 183	⌞ 199	⌚ 215	τ 231	≈ 247	
8	(BS) (LINE C) 8 24	40	( 56	8 72	H 88	X 104	h 120	x 136	ê 152	ÿ 168	¿ 184	⌞ 200	⌚ 216	Φ 232	□ 248	
9	(TAB) 9 25	41	) 57	9 73	I 89	Y 105	i 121	y 137	ë 153	Ö 169	ˆ 185	⌞ 201	⌚ 217	Θ 233	· 249	
A	10 26	42	* 58	J 74	Z 90	j 106	z 122	è 138	Ü 154	ˆ 170	186	⌞ 202	⌚ 218	Ω 234	- 250	
B	(HOME) 11 27	43	+ 59	K 75	[ 91	k 107	{ 123	ı 139	¢ 155	½ 171	⌞ 187	⌚ 203	⌚ 219	δ 235	√ 251	
C	(CLS) (→) 12 28	44	< 60	L 76	\ 92	l 108	! 124	î 140	£ 156	¼ 172	⌞ 188	⌚ 204	⌚ 220	∞ 236	ⁿ 252	
D	(CR LF) (←) 13 29	45	= 61	M 77	] 93	m 109	} 125	ì 141	¥ 157	⅓ 173	⌞ 189	⌚ 205	⌚ 221	φ 237	² 253	
E	(↑) 14 30	46	> 62	N 78	^ 94	n 110	~ 126	Ä 142	Pt 158	¼ 174	⌞ 190	⌚ 206	⌚ 222	ε 238	■ 254	
F	(↓) 15 31	47	/ 63	O 79	_ 95	o 111	DEL 127	À 143	f 159	½ 175	⌞ 191	⌚ 207	⌚ 223	∩ 239	SP 255	

- Nothing is output for a blank boxes.
- Characters enclosed within parentheses indicate control codes and are not displayed.
- The values in the lower right indicate decimal equivalents of the hexadecimal control codes.

Order of operations

Calculations are performed by the computer in accordance with the following order of operations:

- ① Parenthetical operations
- ② Scientific functions
- ③ Powers
- ④ Positive/negative signs
- ⑤ Multiplication, division
- ⑥ Addition, subtraction

- In cases that multiple operations are of the same precedence, the operations are performed from left to right.
- Multiple scientific functions (i.e. sin cos60) are performed from right to left.
- A series of powers (i.e. 5 ^ 4 ^ 3) are calculated from left to right.

Example 2 + 4 \* COS (14 + 16) ^ 2 = 5

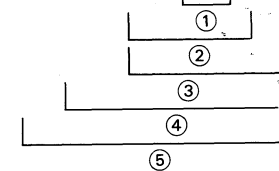

Digit capacities

- Internal calculations are performed using a 13-digit mantissa and 2-digit exponent. The value of π, however, is 11 digits only (3.1415926536).
- Calculation results are displayed using a 10-digit mantissa and 2-digit exponent.
- The maximum number of characters that can be entered for a single calculation is 255.

Rounding

Internal calculations are performed using a 13-digit mantissa, but arithmetic results are cut off when digits 11 through 13 are 049 or lower, and rounded up when digits 11 through 13 are 950 or greater.

## Specifications

**Model:** PB-2000C

**Basic calculation functions:**

Negative numbers, exponents, parenthetical arithmetic operations (with priority judgement function — true algebraic logic)

**Built-in functions:**

Trigonometric/inverse trigonometric functions (angular units: degrees, radians, grads), hyperbolic/inverse hyperbolic functions, logarithmic/exponential functions, square roots, powers, decimal-hexadecimal conversions, decimal-sexagesimal conversions

**Commands:**

CLEAR, FORMAT, ANGLE, PI ( $\pi$ )

**Calculation precision:**

$\pm 1$  at 10th digit of mantissa. However, errors may be cumulative for internal consecutive calculations when the following functions approach the values noted below:

$$\sin x \quad |X| = 90^\circ \times 2n$$

$$\cos x \quad |X| = 90^\circ \times (2n+1)$$

$$\tan x \quad |X| = 90^\circ \times n$$

**Calculation range:**

$\pm 1 \times 10^{-99} \sim \pm 9.999999999 \times 10^{99}$ , or 0. Internal calculations are performed with a mantissa up to 13 digits long.

**Programming language:** C

**Memory capacity:**

32k bytes standard, optionally expandable up to 64k bytes.

**Display capacity:**

10-digit mantissa (including negative sign), or 10-digit mantissa plus 2-digit exponent.

**Display elements:**

192  $\times$  32-dot (32-column  $\times$  4-line) dot matrix LCD

**Main component:**

C-MOS VLSI

**Power supply:**

Main power supply

Three CR2032 lithium batteries or AC adaptor (AD-4175)

Memory backup power supply

One CR1220 lithium battery

**Power consumption:** 0.09W

**Battery life:**

Main power supply

- Approximately 25 hours (continuous program execution).
- Approximately 35 hours (continuous display of 5555555555 at 20°C).

Memory backup battery

Approximately two years.

**Auto power OFF:**

Approximately 2 ~ 255 minutes (programmable)

**Ambient temperature range:**

0°C ~ 40°C (32°F ~ 104°F)

**Dimensions:**

15 (H)  $\times$  188 (W)  $\times$  83 (D) mm (5/8" (H)  $\times$  7 3/8" (W)  $\times$  3 1/4" (D))

**Weight:**

249g (8.8 oz) including batteries

**GUIDELINES LAID DOWN BY FCC RULES FOR USE OF THE UNIT IN THE U.S.A. (not applicable to other areas).**

**WARNING:** This equipment generates and uses radio frequency energy and if not installed and used properly, that is, in strict accordance with the manufacturer's instructions, may cause interference to radio and television reception. It has been type tested and found to comply with the limits for a Class B computing device in accordance with the specifications in Subpart J of Part 15 of FCC Rules, which are designed to provide reasonable protection against such interference in a residential installation. However, there is no guarantee that interference will not occur in a particular installation. If this equipment does cause interference to radio or television reception, which can be determined by turning the equipment off and on, the user is encouraged to try to correct the interference by one or more of the following measures:

- ....reorient the receiving antenna
- ....relocate the computer with respect to the receiver
- ....move the computer away from the receiver
- ....plug the computer into a different outlet so that computer and receiver are on different branch circuits.

If necessary, the user should consult the dealer or an experienced radio/television technician for additional suggestions. The user may find the following booklet prepared by the Federal Communications Commission helpful:

"How to Identify and Resolve Radio-TV Interference Problems"

This booklet is available from the US Government Printing Office, Washington D.C., 20402, Stock No.004-000-00345-4.

## Index

## A

AC adaptor 8  
 AM error 86  
 ANGLE 30  
 answer key 4, 26  
 arithmetic calculations 24  
 asterisk 69  
 AUTO.EXE 50  
   automatic execute file 50  
 Auto Power OFF 9  
   APO 71

## B

back-up 78  
 backup battery 7, 8  
 BASIC file 49  
 baud rate 56, 59, 83, 86  
 BF error 62  
 BS error 74  
 buffer busy control 60

## C

[c ] 22, 51  
 C area 72, 73, 74  
 C editor 22, 49  
 C file 70  
 C function 16, 22  
 C identifier 70  
 C interpreter 22  
 CAL mode 16, 18, 45  
 calculations using variables 26  
   calculations in algebraic format 26  
 calculator function 16, 23  
 [CAPS] key 11  
 CAS0 55, 63  
 Cassette interface 85, 86  
 CD signal control 60  
 Centronics cable 84, 85  
 Centronics interface 80, 84, 85, 87

character bit length 59  
 Character code 94  
 character printer 89  
 CLEAR 24  
 code area 73, 74  
 colon 49  
 common logarithm 35  
 communications 80, 85  
 contrast 10  
 [CONTINUE] key 10  
 [C/S ] 70  
 CTS signal control 60  
 cursor keys 4, 13

## D

[data ] 66  
 data bank 16, 39  
 data bank file 49  
 DATA EDIT mode 50, 51, 66, 70  
 decimal format 23  
 decimal↔hexadecimal conversion 34  
 decimal↔sexagesimal conversion 34  
 default 30, 59, 60  
 delete 4, 28, 43, 45, 54, 67  
   [BS] key 29  
   [LDEL] key 29  
 [delete] 67  
 digit 95  
 [disk ] 51, 57, 64  
 disk file 52  
 disk menu 51  
 display 12  
 DSR signal control 60  
 dummy card 2, 76

## E

[edit ] 51  
 edit a formula 37  
 error messages 92

error stop 72  
 [ETC] key 17  
 execute a formula 37  
 expansion RAM pack 78  
 exponent 25, 95  
 exponential format 23  
 exponential function 33  
 extension 49, 54

## F

FA-7 55, 58, 61, 62, 85  
 file 17, 49  
 file area 72, 74  
 file display 49  
 filename 49  
 floppy disk 51, 80, 81  
 format 82  
 formula memory 48  
 formula memory function 16, 19, 36  
 FP100 plotter printer 88  
 free area 73  
 function key 3, 17, 18  
 function key menu 16, 18, 50  
 function table 35

## H

hardware/memory reset 9  
 hyperbolic functions 32

## I

identifier 49, 70  
 initialize 78  
 insert 4, 27, 41  
 integer format 23  
 interface pack 89  
 Interface unit FA-7 55, 58, 61, 62, 85  
 Interface unit MD-100 61, 63, 80  
 inverse hyperbolic function 32  
 inverse trigonometric function 30

## K

key beep 71

[kill ] 46, 52, 54

## L

[l]list ] 68  
 [load ] 52, 54, 57, 58  
 load (cassette) 55  
 load (FD) 57  
 load a file 50, 52, 54, 58  
 locate specific data 43  
 logarithmic function 33  
 logical line 13, 40

## M

main power supply batteries 7  
 mantissa 95  
 manual calculations 24  
 MD-100 58, 61, 63, 80  
 memo file 46  
 MEMO IN mode 20, 39, 41  
 MEMO. S file 39, 49  
 [memory] 72  
 memory area 74  
 memory capacity 40, 52, 73, 96  
 memory reset 9  
 memory status 72, 73  
   C area memory status display 73  
   general memory status display 73  
 menu 16, 51  
 menu key 4  
 menu mode 16  
 menu display 51  
 [merge ] 68  
 [MT ] 55, 63  
 multistatement 36

## N

[name ] 52, 53  
 natural logarithm 35  
 NEWALL 5, 9, 10, 30, 74, 80  
 [newc ] 23, 51  
 [next ] 67  
 NR error 52

**O**

OM error 52  
operational status 71  
operators 23  
order of operations 95  
output/input controls 84  
overlay sheet 12

**P**

parameter 58, 59, 65  
parity bit 59  
PCB connector 80  
period 49  
PHASE switch 56, 86  
physical line 13, 40  
pin assignments 84  
plotter printer FP-100 88  
[preset] 68  
preset file 50, 68  
    cancel a preset file 69  
    execute a preset file 70  
    specify a file as a preset file 69  
printer 68  
printer cable 88, 89  
Prolog file 49

**R**

RAM 62  
[RAM ] 62  
RAM pack 78  
RAM pack socket 79  
Random data file 49  
recall a formula 37  
record number 21, 39  
RESET 5, 9, 80  
ROM card 76  
rounding 95  
[RS232C] 58, 63  
RS-232C cable 80, 85  
RS-232C interface 54, 64, 65, 80, 82, 85

**S**

[save ] 61, 64, 65

save to a cassette tape 62  
save to a floppy disk 63  
save to memory 61  
SB-43 interface pack 89  
SB-51 printer cable 88, 89  
SB-52 cable 86, 87  
scientific function calculations 29  
scroll 41  
search 45, 66  
[search] 66  
sequential data file 49, 52, 66, 70  
[set ] 71  
Shift key 3  
SI/SO control 60  
square root 35  
stack area 73, 74  
Stop bit 59  
store a formula 36  
sw on 71  
symbol area 73, 74

**T**

tab 71  
tape recorder 86  
Telephone directory 47  
trigonometric function 30

**U**

unnamed C file 51  
unnamed file 54, 56, 58, 62, 63, 70  
unnamed sequential data file 66  
user area 72, 73

**V**

value 23, 25  
variables 24, 26  
virtual screen 14

**W**

work area 73, 74



**CASIO®**