



Darkstalkers Revenge

©CAPCOM 1994, 1995 ALL RIGHTS RESERVED

OPERATORS MANUAL



WARNING

This game is for use in the United States of America and Canada. Sales, export or operation outside of these countries may be construed as copyright and trademark infringements and is strictly prohibited. Violators are subject to severe penalties and will be prosecuted to the full extent of the law.

CAPCOM[®] COIN-OP, INC.
3311 N. Kennicott Road
Arlington Heights, Illinois 60004
Phone: (708) 797-6100
Fax: (708) 797-6306

PM00123-KIT
062695

THANK YOU FOR PURCHASING NIGHTWARRIORS™ : DARKSTALKERS' REVENGE VIDEO KIT. WE INVITE YOU TO USE THE FOLLOWING MAILING ADDRESS, TELEPHONE OR FAX NUMBER FOR PARTS OR SERVICE INFORMATION CONCERNING THIS GAME:

**CAPCOM® COIN-OP, INC.
ATTN: FIELD SERVICE - VIDEO PRODUCTS
3311 N. KENNICOTT ROAD
ARLINGTON HEIGHTS, ILLINOIS 60004
PHONE: (708) 797-6100
FAX: (708) 797-6306**

IF YOU PURCHASED A COMPLETE KIT ("A" KIT), THE SERIAL NUMBERS OF YOUR GAME ARE LOCATED ON BOTH THE TOP "B" CARTRIDGE AND THE BOTTOM "A" CARTRIDGE (RECORD THEM HERE):

**A-BOARD SERIAL # _____
B-BOARD SERIAL # _____
AAMA SERIAL # _____**

IF YOU PURCHASED THE "B" KIT, RECORD THE FOLLOWING SERIAL NUMBERS FROM THE TOP OF THE CASE (B-BOARD):

**B-BOARD SERIAL # _____
AAMA SERIAL # _____**

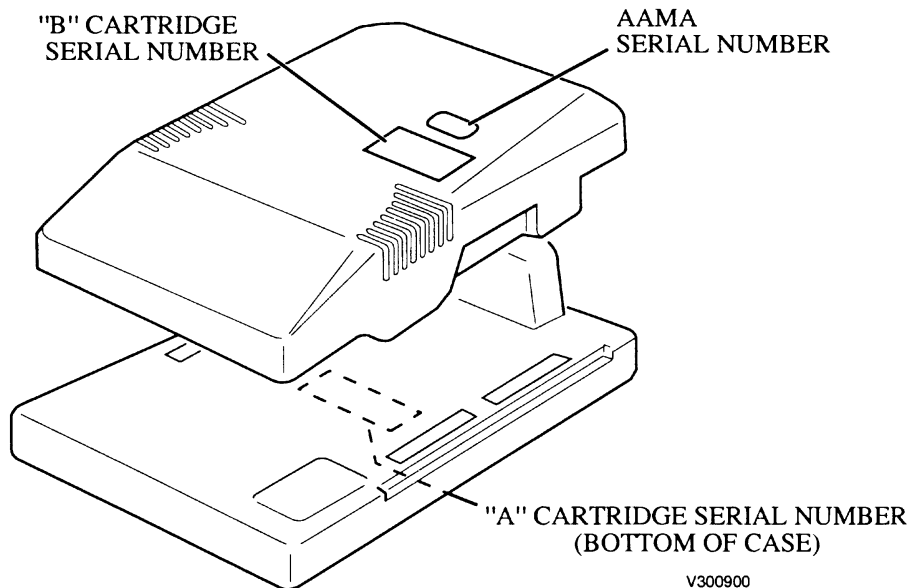

V300900

PLEASE HAVE THESE SERIAL NUMBERS AVAILABLE WHEN CONTACTING US FOR SERVICE INFORMATION.

TABLE OF CONTENTS

<i>Warranty Information</i>	i
<i>Kit Inspection</i>	1
<i>Kit Installation</i>		
“A” Kit Installation	3
Preparation	3
Installation	3
Marquee	3
Control Panel Wiring	4
Test Bracket	6
Game Cartridges	6
“B” Kit Installation	7
Preparation and Installation	7
<i>Test Mode</i>		
Test Menu	9
Accessing the Menu	9
How to Select an Item	9
Closing the Menu	9
Menu Item Descriptions	10
Configuration Menus	11
Accessing the Menus	11
Changing the Settings	13
Saving and Closing the Menu	13
Menu Option Settings	13
Menu Item Descriptions	15
<i>JAMMA Connections</i>	18
<i>Template : Control Panel Drill Hole(s)</i>		

LIMITED PRODUCT WARRANTY (APPLIES TO DOMESTIC SALES ONLY)

CAPCOM® COIN-OP, INC. (Seller), warrants only to the initial purchaser of its products, that the items listed below are free from defects in material and workmanship under normal use and service for the warranty periods specified:

- | | |
|--|--------------|
| A. CP System II Cartridges | One (1) Year |
| B. Electronic and Mechanical Components: | (90) days |

No other part of Seller's products are warranted.

Warranty periods are effective from the initial date of shipment from seller to its authorized distributors.

Seller's sole liability shall be, at its option, to repair or replace products which are returned to Seller during the warranty periods specified, provided:

- A. Seller is notified promptly upon discovery by buyer that stated products are defective.
- B. Such products are properly packaged and then returned, prepaid to Seller's designated plant.

This warranty does not apply to any parts damaged during shipment or handling, or due to improper installation or usage, or alteration. In no event shall Seller be liable for any anticipated profits, loss of profits, loss of use, incidental or consequential damages or any other losses incurred by the customer in connection with the purchase of a CAPCOM® COIN-OP, INC. product.

WARRANTY DISCLAIMER

EXCEPT AS SPECIFICALLY PROVIDED IN A WRITTEN CONTRACT BETWEEN SELLER AND PURCHASER, THERE ARE NO OTHER WARRANTIES, EXPRESSED OR IMPLIED, INCLUDING ANY IMPLIED WARRANTIES OF MERCHANTABILITY OR FITNESS FOR A PARTICULAR PURPOSE.

IMPORTANT NOTICE

THIS SHIPMENT HAS BEEN CAREFULLY INSPECTED AND PROPERLY PACKAGED BEFORE LEAVING THE FACTORY. WE CANNOT ASSUME RESPONSIBILITY FOR BREAKAGE THAT MAY OCCUR DURING TRANSPORTATION OF THE GAME. IF THIS GAME IS DAMAGED UPON RECEIPT FROM THE CARRIER, IMMEDIATELY NOTIFY THE CARRIER AND FILE A DAMAGE REPORT.

KIT INSPECTION

There are two kits available for conversion to *NightWarriors™: DarkStalkers' Revenge*, an "A" kit and a "B" kit. An "A" kit contains the complete game cartridges, all necessary graphics, and replacement joysticks and button switches. The "A" kit is intended for conversion of most JAMMA-compatible, horizontal screen cabinets.

The "B" kit is compatible only with current CAPCOM® System II games. It is similar to the "A" kit but does not include both cartridges (only the B cartridge is supplied). Also, additional conversion parts not included.

Check that all parts have been shipped with your kit. If any parts are missing, contact your distributor immediately.

PARTS LIST

"A" KIT	"B" KIT	PART NO.	DESCRIPTION	QTY.
√		A-00445	CP System II (A/B cartridges)	1
	√	A-00445B	CP System II (B cartridge)	1
√	√	GE1200	Monitor Card	1
√	√	AW00148	Marquee	1
√	√	06-0074	Overlay, Control Panel	1
√	√	AW00150	Decal, Joystick & Button Switches	1
√	√	AW00147	Decal, "CAPCOM® COIN-OP, INC." Cabinet	2
√	√	PM00123-KIT	Manual, Operators	1
√		03-0052	Cable, Auxiliary	1
√		GE2030	Joystick	2
√		16-0130	Switch, 1-Player Start Button (White)	1
√		16-0131	Switch, 2-Player Start Button (White)	1
√		16-0133	Switch, Punch/Kick Button (Red)	4
√		16-0134	Switch, Punch/Kick Button (Blue)	4
√		16-0136	Switch, Punch/Kick Button (Green)	4
√		03-0050	Bracket, Volume/Test	1
√		13-0066	Bracket, A-Cartridge Mounting	4
√		SC00104-05	Screw, Wood	4

CAUTION

Please read the following instructions to keep the PC board in good condition:

- Do not block the ventilation slots.
- Do not drop or bump the board.
- Do not spill any liquids on the case.
- Do not disassemble the case.



Ni-cd

ATTENTION

The product that you have purchased contains a rechargeable battery. The battery is recyclable. At the end of its useful life, under various state and local laws, it may be illegal to dispose of this battery into the municipal waste system. Check with your local solid waste official for details in your area for recycling options or proper disposal.

DISASSEMBLING THE CASE OR REMOVING THE STICKER MAY CAUSE THE TERMINATION OF YOUR REPAIR WARRANTY.

"A" KIT INSTALLATION

WARNING:

MAKE SURE ELECTRICAL POWER TO THE GAME IS OFF BEFORE STARTING THE KIT INSTALLATION.

Preparation

1. Disconnect and remove the old printed circuit board(s) from the cabinet.
2. Remove or open the control panel, and disconnect and remove the buttons and joystick(s) from the control panel.
3. Remove any covering from the control panel overlay, and then remove the control panel overlay.
4. Place the Drill Hole template over the control panel to determine where any new holes should go. Center punch any needed new holes on the control panel.
5. Cut out the new holes using a 1-3/16" hole saw.
6. If there is an additional control panel cover (such as plastic or lexan) that will be utilized, cut any additional holes using the same template.
7. Plug up unused holes with a wood dowel (1-1/8" diameter) and sand any rough edges.

Installation

Marquee Installation

8. Remove the marquee glass, old marquee overlay, and the old cabinet graphics.
9. Install the new marquee and replace the glass.

Control Panel Installation (See Figure 1)

Overlay

10. The control panel overlay in the kit is oversized to accommodate most control panel sizes. Center the

overlay on the control panel, leaving some excess material at the edges.

11. Remove the protective backing from the overlay and press it down on the control panel, keeping it properly aligned. Press it down firmly, smooth out any bubbles, and press it over the edges.

12. Trim any excess from the overlay. Place the drill hole template on top of the overlay, aligning it with the joystick holes. Pierce through the overlay at each control panel hole. Then, cut away overlay material covering the joystick and button holes. Remove the template and clean off the overlay.

13. Peel off the backings of the 6-button and joystick decals, align over the control panel holes, and press in place on the overlay (refer to the drill hole template for proper placement).

14. Install the control panel cover (if required).

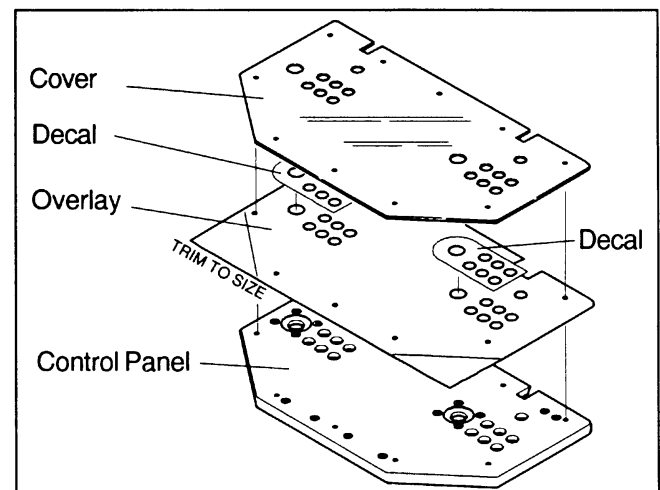

FIGURE 1
Overlay Installation

Reassembly of Components

15. Install all buttons and retaining rings on the control panel as shown in Figure 2. Install two RED buttons to the immediate right of each joystick, install two BLUE buttons to the right of the red ones, and install two GREEN buttons to the right of the blue ones.

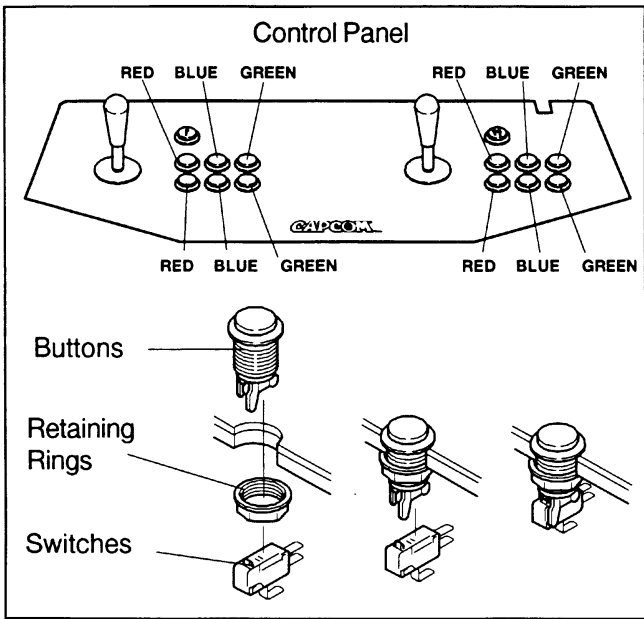

FIGURE 2
Control Panel Buttons and Switches

16. Notice that there are two white buttons. (See Figure 3.) Install the PLAYER ONE button on the top left-hand side of the control panel, and the PLAYER TWO button on the top right-hand side of the control panel. The WHITE buttons are START buttons.

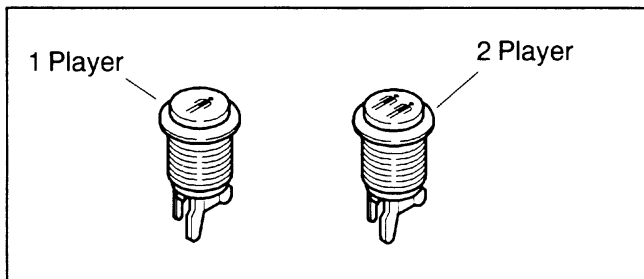

FIGURE 3
Function and Start Buttons

17. Install the switches on the buttons as shown in Figure 2. Orient the switches so that when a button is pressed, the red contact on the switch is depressed.

18. Install the joysticks on the control panel as shown in Figure 4.

Wiring

NOTE:

All switch wires used in this game must be wired to the normally-open connection on the switches. Each switch requires a ground wire on the common

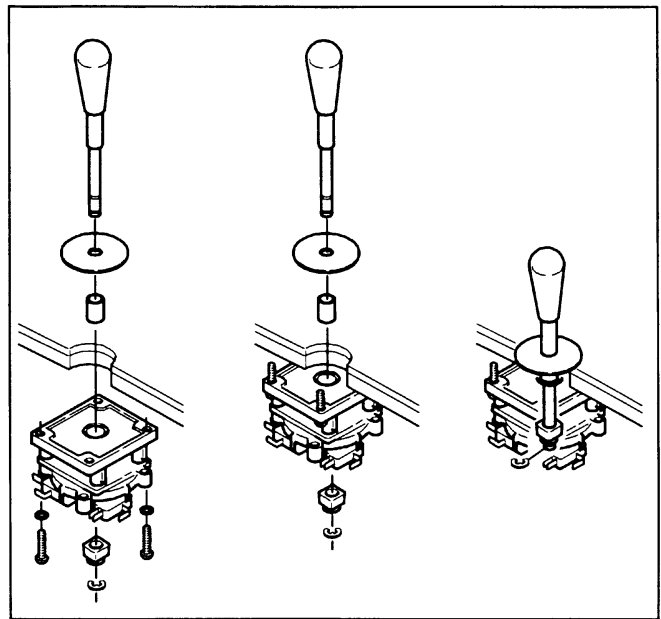

FIGURE 4
Joystick Installation

connector and the appropriate control or switch wire on the normally-open connector of the switch.

19. Reconnect the existing JAMMA connectors to the control panel according to the chart of Figure 5.

20. Connect the Player 1 and Player Kick buttons to the auxiliary JAMMA harness connectors shown in Figure 6. Make the connections according to the chart of Figure 7.

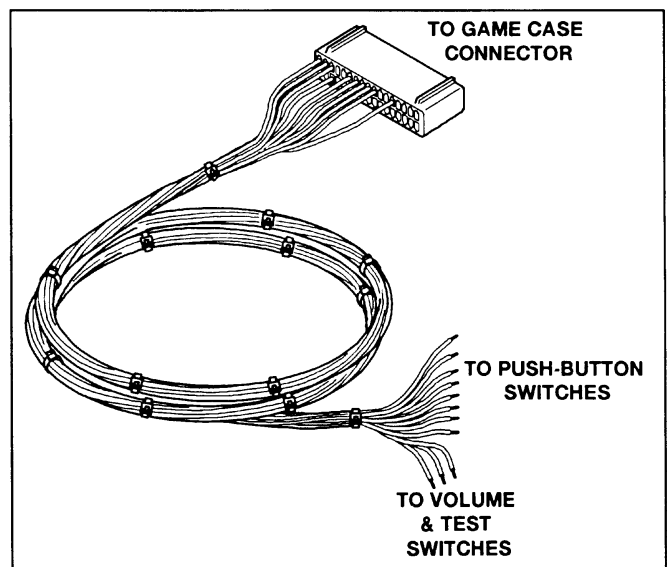

FIGURE 6
Auxiliary JAMMA Harness

JAMMA CONNECTOR REF.	*WIRE COLOR	CONNECTS TO	COMPONENT	FUNCTION
18	WHITE/BLACK	PLAYER 1	JOYSTICK	UP
19	WHITE/BROWN	PLAYER 1	JOYSTICK	DOWN
20	WHITE/RED	PLAYER 1	JOYSTICK	LEFT
21	WHITE/ORANGE	PLAYER 1	JOYSTICK	RIGHT
22	WHITE/YELLOW	PLAYER 1	PUNCH BUTTON	JAB
23	WHITE/GREEN	PLAYER 1	PUNCH BUTTON	STRONG
24	WHITE/BLUE	PLAYER 1	PUNCH BUTTON	FIERCE
V	VIOLET/BLACK	PLAYER 2	JOYSTICK	UP
W	VIOLET/BROWN	PLAYER 2	JOYSTICK	DOWN
X	VIOLET/RED	PLAYER 2	JOYSTICK	LEFT
Y	VIOLET/ORANGE	PLAYER 2	JOYSTICK	RIGHT
Z	VIOLET/YELLOW	PLAYER 2	PUNCH BUTTON	JAB
a	VIOLET/GREEN	PLAYER 2	PUNCH BUTTON	STRONG
b	VIOLET/BLUE	PLAYER 2	PUNCH BUTTON	FIERCE

Figure 5: JAMMA Wiring Connections

*** Wire Color Note:** Wire colors shown are according to the AAMA -AOMA Standard for wire color assignments; your harness may contain different colors than shown above.

AUXILIARY JAMMA CONNECTOR REF.	WIRE COLOR	CONNECTS TO	COMPONENT	FUNCTION
34	BLACK	PLAYER 1	KICK BUTTON	GROUND
19	BLUE	PLAYER 1	KICK BUTTON	SHORT
17	RED	PLAYER 1	KICK BUTTON	FORWARD
15	PINK	PLAYER 1	KICK BUTTON	ROUNDHOUSE
33	BLACK	PLAYER 2	KICK BUTTON	GROUND
21	GRAY/YELLOW	PLAYER 2	KICK BUTTON	SHORT
23	PINK/YELLOW	PLAYER 2	KICK BUTTON	FORWARD
9	PURPLE/YELLOW	PLAYER 2	KICK BUTTON	ROUNDHOUSE
29	GRAY/YELLOW	TEST BRACKET	VOLUME SWITCH	UP
30	PINK/YELLOW	TEST BRACKET	VOLUME SWITCH	DOWN
31	BLACK/WHITE	TEST BRACKET	VOLUME SWITCH	COMMON

Figure 7: Auxiliary JAMMA Wiring Connections

21. An optional Test/Volume bracket (see Figure 8) is included in this kit. Your cabinet may already contain this bracket. If you decide to install, the bracket should be mounted inside the coin door and on top of the cash box for easy access.

NOTE: The "A" game cartridge also contains the same Test and Volume functions found on the test bracket.

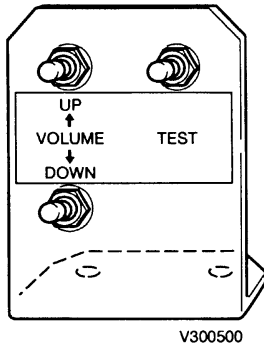

Figure 8: Test Bracket

Wiring of the Test Bracket requires connections to both the main JAMMA harness as well as the Auxiliary JAMMA harness (refer to Figure 9).

LEAD WIRE COLOR	SWITCH FUNCTION	CONNECTS TO
YELLOW	VOLUME-UP	AUX. JAMMA '29'(GRAY/YELLOW)
GREEN	GROUND	AUX. JAMMA '31'(BLACK/WHITE)
BLACK	VOLUME-DOWN	AUX. JAMMA '30'(PINK/YELLOW)
GREEN	GROUND	AUX. JAMMA '31'(BLACK/WHITE)
BROWN	TEST	JAMMA '15'
BLACK	GROUND	JAMMA 'A' or 'B' or 'e' or 'f' or '1' or '2' or '27' or '28'

Figure 9: Test Bracket Wiring Chart

GAME CARTRIDGE INSTALLATION

22. Install the four (4) mounting brackets to the underside of the "A" cartridge as shown in Figure 10.

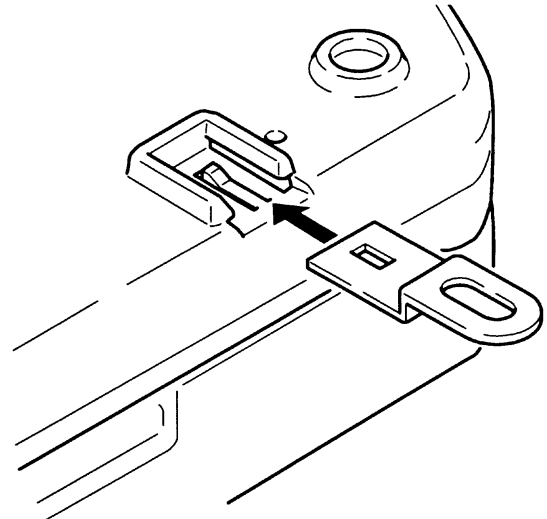

Figure 10: Mounting Bracket Installation

24. Using the supplied wood screws, fasten the game cartridge case to the control panel shelf, as shown in Figure 11.

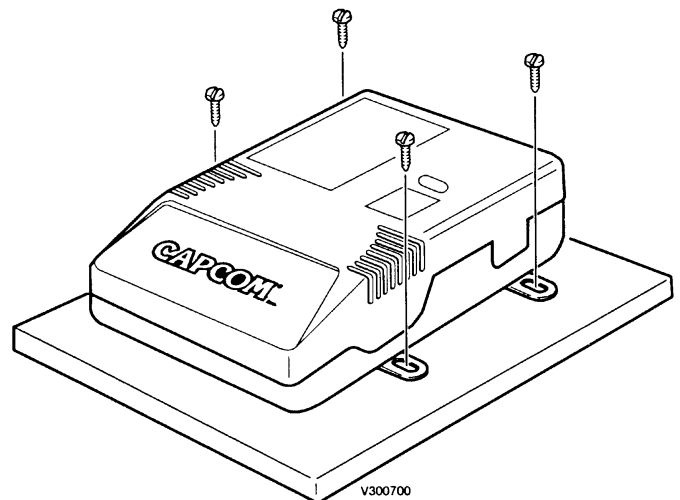

Figure 11: Case Mounting

25. Connect the JAMMA harness connector and the Auxiliary JAMMA cable connector to the "A" cartridge. If your cabinet is equipped with Q-SOUND, also attach the audio cables.



WARNING

Improper installation of the JAMMA harness connector to the game cartridge will cause damage to the enclosed PCB.

26. Power-up the game and set all operator adjustable options by pressing the **TEST** switch. Follow the instructions under the **Test Mode** section of this manual.

“B” KIT INSTALLATION

1. To install the kit graphics, you must follow the “A” Kit Preparation and Installation Procedure, steps 3 through 20.
2. To remove the existing “B” cartridge from the “A” cartridge, pull the case clamps apart. Carefully remove the old “B” cartridge and install the new “B” cartridge. Re-install the case clamps.



WARNING

FURTHER DISASSEMBLY OF EITHER GAME CARTRIDGE WILL VOID YOUR WARRANTY.

3. Power-up the game and set all operator adjustable options by pressing the **TEST** switch. Follow the instructions under the **Test Mode** section of this manual.

TEST MENU

The test menu allows you to test the functions and configure the game. These items include input devices such as joysticks, buttons and coin mechs, output devices such as monitor, speakers and meters. Through the Test Menu you can also access the Configuration Menu, where you can change the settings of the game.

1. ACCESSING THE TEST MENU

- **For a CAPCOM cabinet, or a cabinet equipped with a test switch:**
Make sure the game is on and push the test switch. The screen shown below will appear.
- **For a cabinet without a test switch:**
Push the test switch on the side of the "A" cartridge. (Refer to the inside back cover of the manual.)

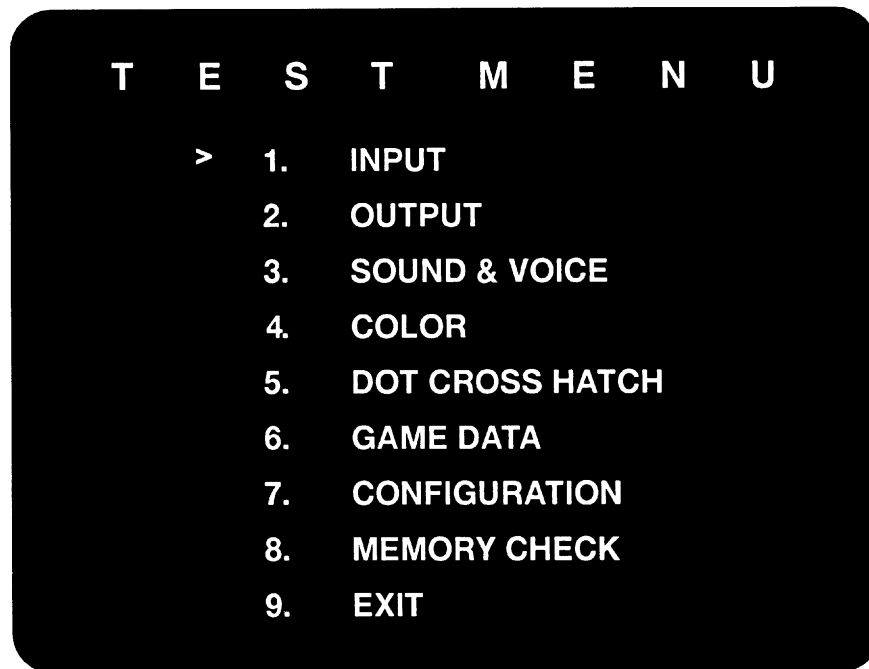

2. HOW TO SELECT AN ITEM

- Use the Player 1 Joystick to Move the arrow in front of the desired item and press the Player 1 JAB PUNCH button.
- To return to the test menu, push the Player 1 Start and Player 2 Start Buttons simultaneously.

The test menu automatically appears:

- After you exit the "7. CONFIGURATION MENU".
- After the memory is tested from the menu, "8. MEMORY CHECK".

3. CLOSING THE TEST MENU

To close the Test Menu, highlight "9. EXIT" and push the Player 1 JAB PUNCH button.

4. TEST MENU ITEM DESCRIPTIONS

INPUT	Used to test all the input switches, such as joysticks and buttons. The "0" changes to a "1" as the button is pushed or joystick is moved. Check connections and switches in case the "0" doesn't change to a "1" when depressed or moved.
OUTPUT	Used to test the coin meter and the coin lock
SOUND & VOICE	Select a code of SOUND or VOICE with the Player 1 Joystick. Push the Player 1 JAB PUNCH button to hear the sound of the selected code.
COLOR	Shows color bars of red, green, blue and white. Adjust RGB and brightness to obtain the optimum color balance and solid black background.
DOT CROSS HATCH	Used to test the screen size, focus and distortion.
GAME DATA	Counter information and the average of the game played time will be displayed. (Not user adjustable function. Automated data collection/display only.)
CONFIGURATION	Used to change the game play settings. Refer to the CONFIGURATION MENU section.
MEMORY CHECK	Used to test memory. "OK" appears when each block of memory passes test "ERROR" appears in case of malfunction. If "ERROR" appears, repeat the memory test. Contact your distributor if "ERROR" still appears.
EXIT	Select this item and push the Player 1 JAB PUNCH button to return to game play mode.

CONFIGURATION MENUS

The Configuration Menu is used to change various game settings such as level of difficulty, credits, sound configuration, etc. These settings are stored in memory on the PCB rather than DIP switches. To change configuration settings you must enter test mode and then access the Configuration Menu.

The Configuration Menu is divided into 2 sections. In the System Configuration section, you can change system credits, sound, and coin mech configuration. In the Game Configuration section, you can change game play difficulty level and game duration.

1. ACCESSING THE CONFIGURATION MENU

- From the Test Menu, move the arrow to “7. CONFIGURATION” and push the Player 1 JAB PUNCH button. The screen below will be displayed. A description of each option is discussed in the table below.

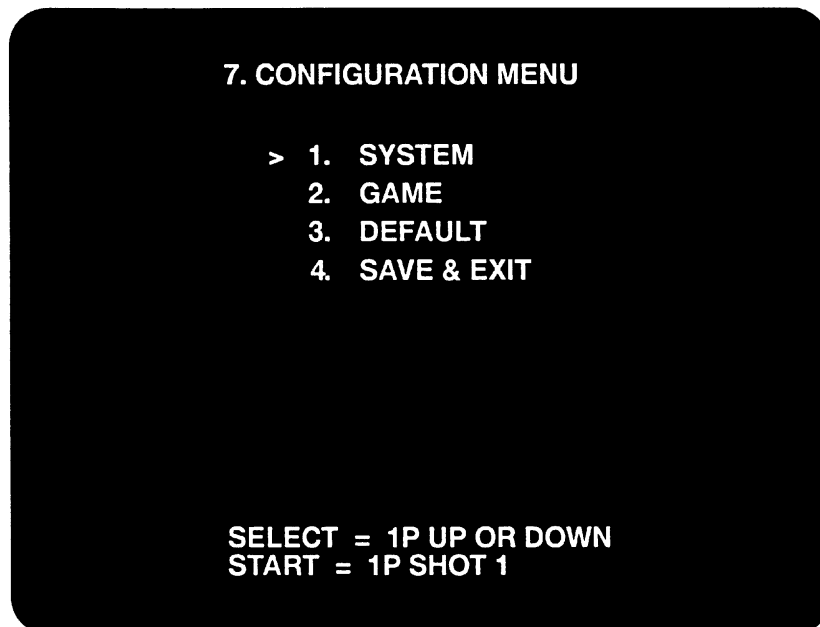

SYSTEM	Use this screen to change system configuration such as credits, monitor flip, sound and coin mech configuration.
GAME	Use this screen to change difficulty level, damage level, time count speed, maximum number of rounds and event type.
DEFAULT	Use this to return configuration to factory settings. To insure that settings are not defaulted by accident the Player 1 JAB PUNCH and Player 1 STRONG PUNCH buttons must be pressed at the same time.
SAVE & EXIT	Use this to save new configuration settings and exit to Test Menu.

To access the System or Game Configuration menus from the screen display, move the arrow with the joystick until it is to the left of the desired menu and press the Player 1 JAB PUNCH button. Below are samples of the System and Game Configuration Menus.

SYSTEM CONFIGURATION MENU

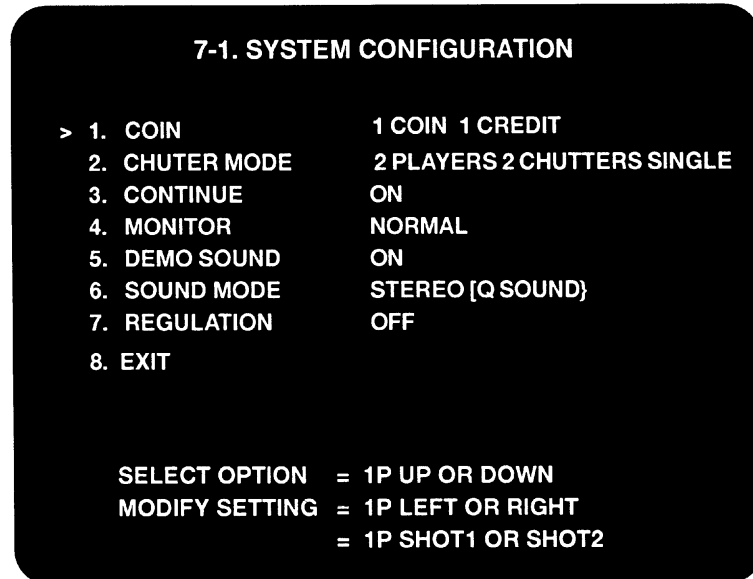

GAME CONFIGURATION MENU

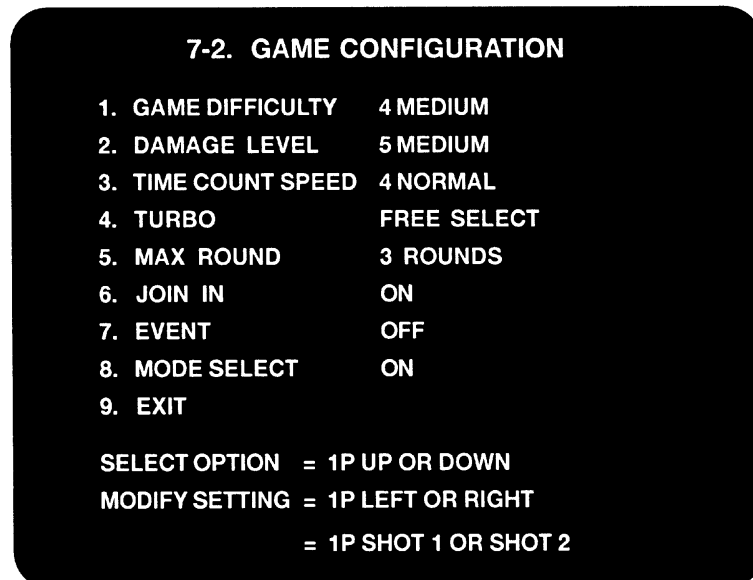

2. CHANGING THE CONFIGURATION SETTINGS

- Move the Player 1 Joystick UP or DOWN to highlight the desired option. Once the option is highlighted, move the Joystick LEFT or RIGHT, or press the Player 1 JAB PUNCH button to change the setting. Refer to the 4. Menu Option Settings section for option settings.

3. SAVING SETTINGS AND CLOSING THE MENU

- Once the configuration settings are changed in either the System or Game Configuration Menus, move the arrow to the EXIT option in each respective menu and press the Player 1 JAB PUNCH button. This will return you to the Configuration Menu.
- At the Configuration Menu move the arrow to **4. SAVE & EXIT** and press the Player 1 JAB PUNCH button. You will be returned to the Test Menu.
- A message “**SAVING NEW CONFIGURATION IN EEPROM**” appears while new settings are being saved. It takes one or two seconds to save the new settings. Do not turn off the power switch while saving is in process.
- From the Test Menu move the arrow to **9. EXIT** and press the Player 1 JAB PUNCH button. This will return you to game mode.

4. MENU OPTION SETTINGS

System Configuration Menu Settings

COIN	1 COIN 1 CREDIT	1 COIN 2 CREDITS	1 COIN 3 CREDITS	1 COIN 4 CREDITS	1 COIN 5 CREDITS
	1 COIN 6 CREDITS	1 COIN 7 CREDITS	1 COIN 8 CREDITS	1 COIN 9 CREDITS	2 COINS 1 CREDIT
	3 COINS 1 CREDIT	4 COINS 1 CREDIT	5 COINS 1 CREDIT	6 COINS 1 CREDIT	7 COINS 1 CREDIT
	8 COINS 1 CREDIT	9 COINS 1 CREDIT	2 COINS START 1 COIN CONTINUE	FREE PLAY	
CHUTER MODE	2 PLAYERS 2 CHUTERS SINGLE		2 PLAYERS 1 CHUTER SINGLE		
	2 PLAYERS 2 CHUTERS MULTI				
CONTINUE	ON		OFF		
MONITOR	FLIP		NORMAL		
DEMO SOUND	ON		OFF		
SOUND MODE	STEREO (Q SOUND)		MONAURAL		
REGULATION	ON		OFF		
EXIT					

Game Configuration Menu Settings

GAME DIFFICULTY	1 EASIEST	2 VERY EASY	3 EASY	4 MEDIUM	
	5 MEDIUMHARD	6 HARD	7 VERY HARD	8 HARDEST	
DAMAGE LEVEL	1 MINIMUM	2	3	4	
	5 MEDIUM	6	7	8	9 MAXIMUM
TIME COUNT SPEED	1 SLOW	2	3	4 NORMAL	
	5	6	7	8 FAST	
TURBO	FREE SELECT		ON	OFF	
MAX ROUND	1 ROUND		3 ROUNDS		5 ROUNDS
JOIN IN	ON			OFF	
EVENT	OFF			1 MATCH	
MODE SELECT	ON			OFF	
EXIT					

- Capcom recommended settings are in bold face.
- After you change the setting, make sure to select "EXIT" and push the Player 1 JAB PUNCH button.
- Choose STEREO (QSOUND) if your cabinet is equipped with the Qsound Speaker System, otherwise select MONAURAL for proper sound effect.

MENU ITEM DESCRIPTIONS

System Configuration Option Descriptions

COIN	Sets the charge per play
CONTINUE	Sets continuous play. ON: Continuous play is possible OFF: Continuous play is not possible
MONITOR FLIP	Flips the screen. If the screen appears upside down, change the setting. FLIP: Upside down NORMAL: Right side up
DEMO SOUND	Turns attract sound on or off.
SOUND MODE	STEREO or MONAURAL. STEREO: with QSOUND MONAURAL: without QSOUND QSOUND is available with CAPCOM QSOUND cabinets only. For other cabinet, please set to MONAURAL
CHUTE TYPE	Sets the number of player(s) and coin chutes. 1 CHUTE SINGLE With this setting, either player can start the game. 2 CHUTES SINGLE Two players use one coin chute to play at the same time. With this setting, the player whose coin was put in first starts the game. 2 CHUTES MULTI Two players use two coin chutes and play separately. With this setting, the game is started from the same side the coin chute was used.
EXIT	To save the setting changes and return to the CONFIGURATION MENU, highlight this item and push the PLAYER 1 START button.

Game Configuration Option Descriptions

DIFFICULTY	Sets the game difficulty level. There are eight levels of difficulty from EASY to EXPERT.
DAMAGE LEVEL	Sets the attack damage level. There are four levels of damage from LOW to MAXIMUM.
TIMER SPEED	Sets the speed of the countdown for the timer display. There are four speed levels from SLOW to FASTEST.
GAME SPEED	Sets the speed at which the characters fight.
MAX ROUND	Sets the number of rounds for winning. 1 ROUND: Winner of a single round wins. 3 ROUNDS: Winner of 2 out of 3 rounds wins. 5 ROUNDS: Winner of 3 out of 5 rounds wins.
EVENT	Turns on event mode. Useful for Championship Tournaments. OFF Normal setting. Sets the mode to normal operation. 1 MATCH Matches player with 1 credit. However, a win or a loss results in GAME OVER. CONTINUE is not available. SUDDEN DEATH The player that takes the initiative wins. One strike settles the fight. 1 MATCH & SUDDEN DEATH Sets to 1 MATCH mode as well as SUDDEN DEATH mode.
EXIT	Returns to the Configuration Menu.

JAMMA CONNECTIONS

SOLDER SIDE			COMPONENT SIDE
GND	A	1	GND
GND	B	2	GND
+5 VDC	C	3	+5 VDC
+5 VDC	D	4	+5 VDC
-5 VDC	E	5	-5 VDC
+12 VDC	F	6	+12 VDC
KEY	H	7	KEY
COIN COUNTER 2	J	8	COIN COUNTER 1
COIN LOCK 2	K	9	COIN LOCK 1
* LEFT SPEAKER (-)	L	10	*LEFT SPEAKER (+)
* RIGHT SPEAKER (-)	M	11	*RIGHT SPEAKER (+)
VIDEO GREEN	N	12	VIDEO RED
VIDEO SYNC	P	13	VIDEO BLUE
SERVICE 1	R	14	VIDEO GND
TILT SWITCH	S	15	TEST MODE
COIN 2	T	16	COIN 1
START 2	U	17	START 1
PLAYER 2 - UP	V	18	PLAYER 1 - UP
PLAYER 2 - DOWN	W	19	PLAYER 1 - DOWN
PLAYER 2 - LEFT	X	20	PLAYER 1 - LEFT
PLAYER 2 - RIGHT	Y	21	PLAYER 1 - RIGHT
PLAYER 2 - JAB	Z	22	PLAYER 1 - JAB
PLAYER 2 - STRONG	a	23	PLAYER 1 - STRONG
PLAYER 2 - FIERCE	b	24	PLAYER 1 - FIERCE
PLAYER 2 - SHORT	c	25	PLAYER 1 - SHORT
PLAYER 2 - FWD	d	26	PLAYER 1 - FWD
GND	e	27	GND
GND	f	28	GND

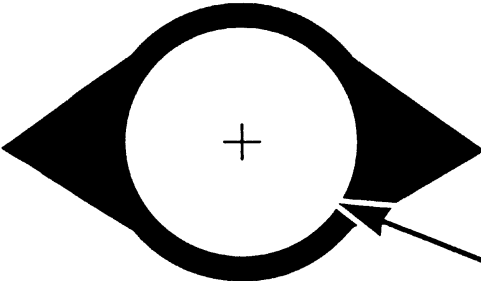

1-3/16" DRILL FOR
PLAYER HOLE

1-3/4" DRILL FOR
JOYSTICK HOLE

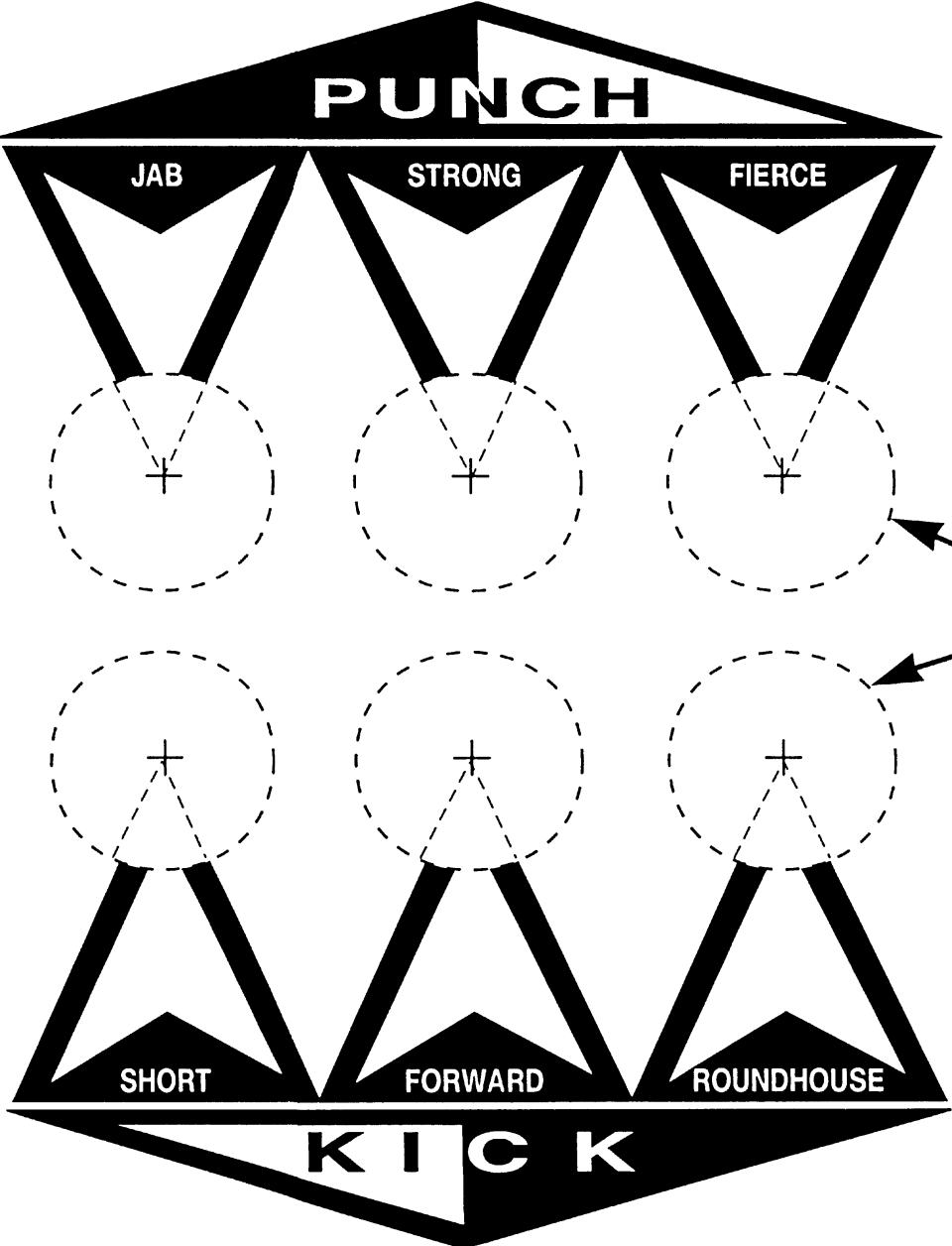
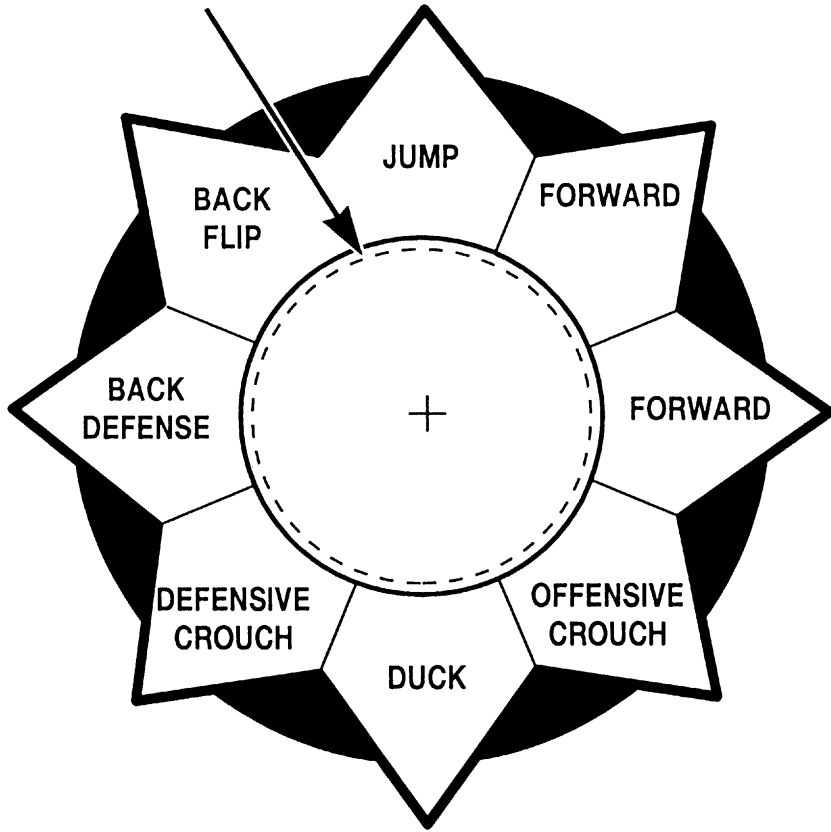

1-3/16" DRILL FOR
BUTTON HOLES



CAPCOM, INC.
3311 NORTH KENNICOTT RD
ARLINGTON HEIGHTS
ILLINOIS 60004

DRILL HOLE TEMPLATE, STREETFIGHTER ALPHA

V500100

DRAWN BY: JA

DATE: 06/16/95

REVISION NO:

REFERENCE INFORMATION

GAME CASE CONTROLS

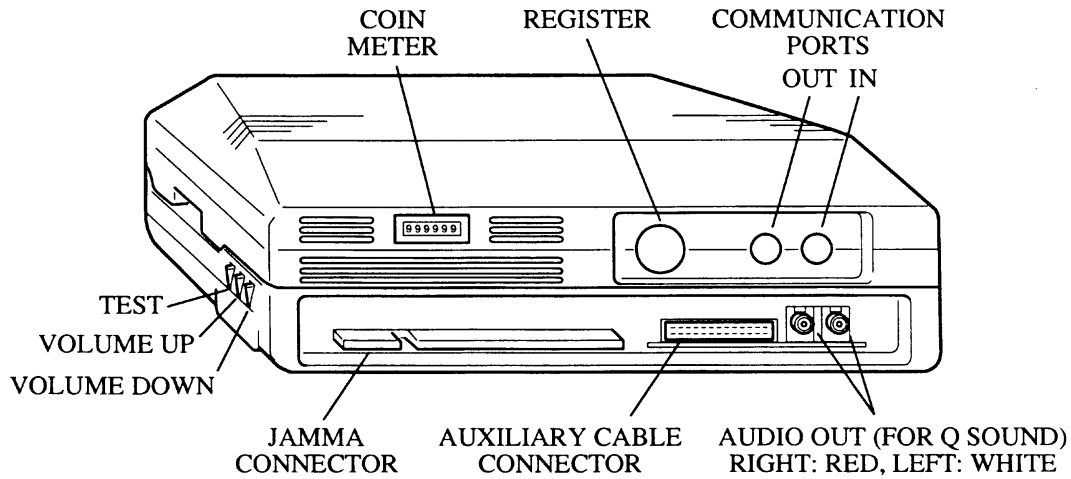

V300800

TYPICAL CONTROL PANEL LAYOUT OF *NightWarriors™ : DarkStalkers' Revenge*

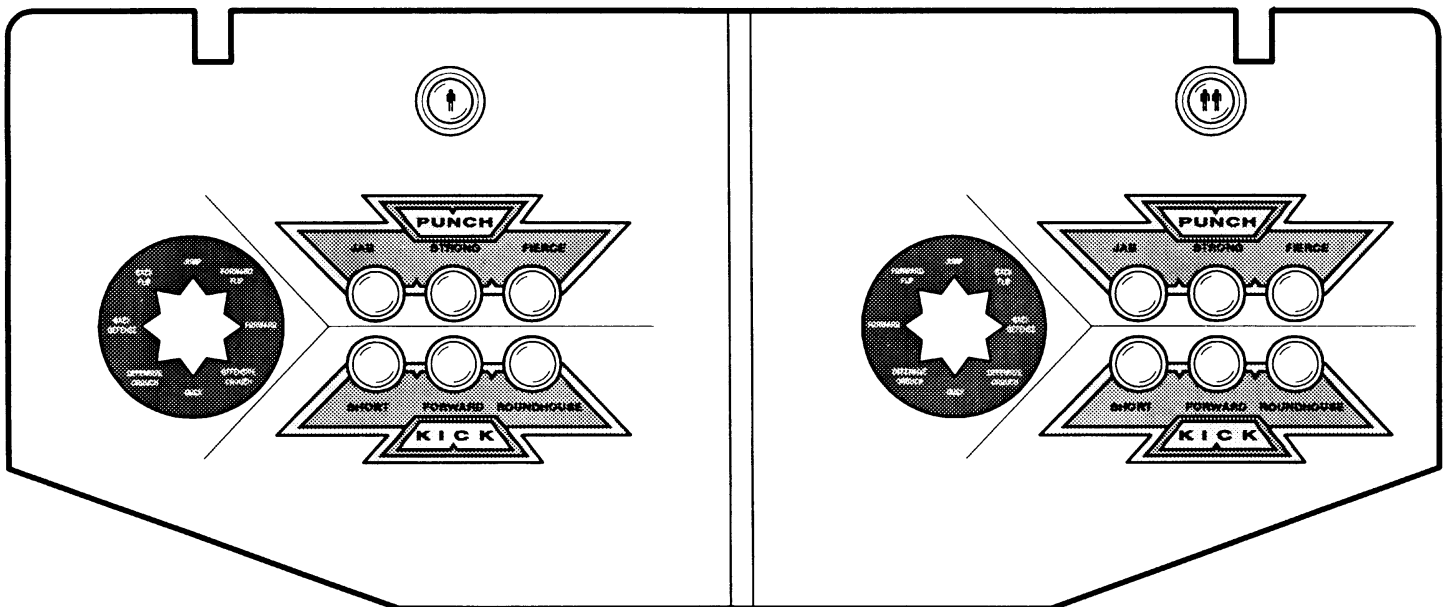

NOTICE

This equipment has been tested and found to comply with the limits for a Class A digital device, pursuant to Part 15 of the FCC Rules. These limits are designed to provide reasonable protection against harmful interference when the equipment is operated in a commercial environment. This equipment generates, uses, and can radiate radio frequency energy and, if not installed and used in accordance with the instruction manual, may cause harmful interference to radio communications. Operation of this equipment in a residential area is likely to cause harmful interference, in which case the user will be required to correct the interference at his own expense.

FBI



WARNING

Federal law provides severe civil and criminal penalties for the unauthorized reproduction, distribution, or exhibition of copyrighted audiovisual works and video games.

The Federal Bureau of Investigation investigates allegations of criminal copyright infringement.

CAPCOM[®] COIN-OP, INC.

3311 N. Kennicott Road
Arlington Heights, Illinois 60004

Phone: (708) 797-6100

Fax: (708) 797-6306