

Electronic user's guide released subject to "Nokia User's Guides Terms and Conditions, 7th June, 1998"

User's Guide



Issue 1

DECLARATION OF CONFORMITY

We, NOKIA MOBILE PHONES Ltd declare under our sole responsibility that the product NHM-6NX is in conformity with the provisions of the following Council Directive: 1999/5/EC.

A copy of the Declaration of Conformity can be found at http://www.nokia.com/phones/declaration_of_conformity/.

Copyright © Nokia Mobile Phones 2001. All rights reserved.

Reproduction, transfer, distribution or storage of part or all of the contents in this document in any form without the prior written permission of Nokia is prohibited.

US Patent No 5818437 and other pending patents. T9 text input software Copyright (C) 1997-2001. Tegic Communications, Inc. All rights reserved.

Nokia is a registered trademark of Nokia Corporation. Other product and company names mentioned herein may be trademarks or tradenames of their respective owners.

Navi and Nokia Xpress-on are trademarks of Nokia Mobile Phones. Nokia tune is a trademark of Nokia Corporation.

Nokia operates a policy of continuous development. Nokia reserves the right to make changes and improvements to any of the products described in this document without prior notice.

Under no circumstances shall Nokia be responsible for any loss of data or income or any special, incidental, consequential or indirect damages howsoever caused.

The contents of this document are provided "as is". Except as required by applicable law, no warranties of any kind, either express or implied, including, but not limited to, the implied warranties of merchantability and fitness for a particular purpose, are made in relation to the accuracy, reliability or contents of this document. Nokia reserves the right to revise this document or withdraw it at any time without prior notice

The availability of particular accessories may vary by region. Please check with the Nokia dealer nearest to you.

Copyright © 2004 Nokia. All rights reserved.

Quick and easy

Thank you for choosing this Nokia phone! These pages give some tips on using your phone. More detailed information is given throughout this user's guide.

■ Before using your phone

1. Insert a SIM card in the phone. See [Inserting a SIM card](#) on page 24.
2. Install and charge the battery. See [Inserting a SIM card](#) on page 24 and [Charging the battery](#) on page 27.
3. Switch on your phone by pressing and holding  (see page 28).
See also [Display indicators](#) on page 21.

■ Call functions

Making a call

Key in the area code and phone number, and press  (**Call**).





Ending a call

Press  (**End**).

Answering a call

Press  (**Answer**).

Redialling a phone number

Press  in standby mode, scroll to the desired number with  or , and press  (**Call**).

Adjusting the earpiece volume

Press  or  during a call.

Calling your voice mailbox





Press and hold  in standby mode. See also [Voice mailbox number \(Menu 2-9\)](#) on page 64.

Making a call by voice dialling

Add a voice tag to the desired phone number (see page 53). Press and hold  in standby mode, and say the voice tag to make a call.





■ Phone book functions

Quick save

Key in the phone number and press  or  to change the text above  to *Save*. Press  (*Save*).





Key in the name and press  (*OK*).

Quick find



Press  in standby mode, (key in the first letter of the name) and scroll with  or  to the desired name. Press and hold  to view the related phone number.

■ Entering or exiting a menu function

Entering

Press  (*Menu*). Scroll with  or  to the desired menu function and press  (*Select*). Repeat this for submenus and setting options.

Exiting

Press  to return to the previous menu level. Press and hold  to return to standby mode.

■ Other essential functions

Locking or unlocking the keypad

In standby mode, press  and then  quickly.

Setting the phone tones for different environments





Press  quickly, use  or  to scroll to the desired option, and press  (OK).

Table of contents

| | |
|---|-----------|
| Quick and easy..... | 3 |
| Table of contents..... | 6 |
| For your safety..... | 15 |
| General information | 17 |
| Stickers on the sales package | 17 |
| Security code | 17 |
| Network services..... | 17 |
| Accessories and batteries..... | 18 |
| 1. Your phone..... | 19 |
| Using the keys | 19 |
| Power key | 19 |
| Number keys | 19 |
| Navi key | 20 |
| Scroll keys..... | 20 |
| C key | 20 |
| Display indicators | 21 |
| Standby mode | 21 |
| Essential indicators related to menu functions..... | 22 |
| 2. Getting started | 24 |
| Inserting a SIM card | 24 |
| Using the SIM card | 24 |
| Inserting the SIM card in the phone | 24 |

| | |
|---|-----------|
| Charging the battery..... | 27 |
| Switching the phone on or off..... | 28 |
| Switching on..... | 28 |
| If the phone requests a PIN code or security code:..... | 28 |
| Switching off..... | 29 |
| Changing the Nokia Xpress-on™ covers..... | 29 |
| 3. Basic functions | 31 |
| Making a call..... | 31 |
| Switching to handsfree mode..... | 31 |
| International calls..... | 31 |
| Adjusting the earpiece volume..... | 32 |
| Muting the microphone..... | 32 |
| Redialling a last dialled number..... | 32 |
| Making a call using the phone book..... | 32 |
| Speed dialling a phone number..... | 33 |
| Making a new call during a call..... | 34 |
| Voice dialling..... | 34 |
| Making a conference call..... | 34 |
| Answering a call..... | 35 |
| Diverting or rejecting a call..... | 35 |
| Answering a new call during a call..... | 36 |
| Listening to voice messages..... | 36 |
| Locking the keypad..... | 37 |
| Selecting a ringing tone (Menu 5-1)..... | 38 |
| Adjusting all the phone tones by a single setting..... | 38 |
| Storing a phone number with a name..... | 38 |

| | |
|---|-----------|
| Writing text..... | 39 |
| By pressing a key once for each character (predictive text input) | 40 |
| Writing compound words..... | 42 |
| Selecting a dictionary for predictive text input..... | 42 |
| Turning predictive text input off..... | 42 |
| By pressing a key one or more times for each character (traditional text input) | 42 |
| 4. Using the menus..... | 44 |
| Accessing a menu function..... | 44 |
| By scrolling..... | 44 |
| By a shortcut | 45 |
| Exiting a menu function | 45 |
| List of menu functions | 46 |
| 5. Phone book (Menu 01)..... | 49 |
| Recalling a name and phone number (Menu 01-1) | 49 |
| Calling a service number (Menu 01-2)..... | 49 |
| Storing a name and phone number (Menu 01-3) | 50 |
| Erasing a name and phone number (Menu 01-4)..... | 50 |
| Editing a name and phone number (Menu 01-5)..... | 50 |
| Copying or moving a name and phone number (Menu 01-6)..... | 50 |
| Assigning a ringing tone to a phone number (Menu 01-7) | 50 |
| Sending and receiving a name and phone number (Menu 01-8)..... | 51 |
| Receiving a name and phone number..... | 51 |
| Options (Menu 01-9): Memory in use, Type of view, and Memory status..... | 51 |
| Selecting the memory for names and phone numbers (Memory in use)..... | 51 |
| Selecting the way the saved names and phone numbers are shown (Type of view)..... | 52 |
| Checking the amount of free space in the phone book (Memory status) | 52 |
| Assigning a phone number to a speed dial key (Menu 01-10) | 52 |
| Using the speed dialling keys | 53 |

| | |
|---|-----------|
| Voice dialling (Menu 01-11)..... | 53 |
| Adding a voice tag to a name and phone number..... | 54 |
| Making a call by saying a voice tag..... | 54 |
| Listening to a voice tag..... | 55 |
| Changing a voice tag..... | 55 |
| Erasing a voice tag..... | 55 |
| 6. Messages (Menu 2)..... | 56 |
| Writing and sending a text message (Menu 2-1)..... | 56 |
| Writing a message..... | 56 |
| Reading a text message (Inbox - Menu 2-2)..... | 58 |
| Viewing a message you have saved (Outbox - Menu 2-3)..... | 59 |
| Picture messages (Menu 2-4)..... | 59 |
| When you receive a picture message..... | 59 |
| When you view the message in this menu..... | 60 |
| Sending a picture message..... | 60 |
| Templates (Menu 2-5)..... | 60 |
| Smileys (Menu 2-6)..... | 61 |
| Message settings (Menu 2-7)..... | 61 |
| Set 1 (Menu 2-7-1)..... | 61 |
| Message centre number..... | 62 |
| Messages sent as..... | 62 |
| Message validity..... | 62 |
| Common (Menu 2-7-2)..... | 62 |
| Delivery reports..... | 62 |
| Reply via same centre..... | 63 |
| Character support..... | 63 |
| Info service (Menu 2-8)..... | 63 |

| | |
|--|-----------|
| Voice mailbox number (Menu 2-9) | 64 |
| Service command editor (Menu 2-10) | 64 |
| 7. Chat (Menu 3) | 65 |
| Starting a chat | 65 |
| 8. Call register (Menu 4) | 67 |
| Missed calls (Menu 4-1) | 68 |
| Received calls (Menu 4-2) | 68 |
| Dialled numbers (Menu 4-3) | 68 |
| Erase recent call lists (Menu 4-4) | 68 |
| Show call duration (Menu 4-5) | 68 |
| Show call costs (Menu 4-6) | 69 |
| Call cost settings (Menu 4-7) | 69 |
| Call cost limit | 69 |
| Show costs in | 70 |
| Prepaid credit (Menu 4-8) | 70 |
| 9. Tones (Menu 5) | 71 |
| Ringing tone (Menu 5-1) | 71 |
| Ringing volume (Menu 5-2) | 71 |
| Incoming call alert (Menu 5-3) | 71 |
| Composer (Menu 5-4) | 72 |
| Creating a new ringing tone | 72 |
| Receiving a ringing tone | 74 |
| Message alert tone (Menu 5-5) | 74 |
| Keypad tones (Menu 5-6) | 74 |
| Warning tones (Menu 5-7) | 74 |
| Vibrating alert (Menu 5-8) | 74 |
| Screen saver (Menu 5-9) | 75 |

| | |
|--|-----------|
| 10. Settings (Menu 6) | 76 |
| Call settings (Menu 6-1)..... | 76 |
| Automatic redial | 76 |
| Speed dialling | 76 |
| Call waiting options..... | 77 |
| Own number sending | 77 |
| Phone line in use | 77 |
| Automatic answer | 78 |
| Phone settings (Menu 6-2) | 78 |
| Language..... | 78 |
| Cell info display..... | 78 |
| Welcome note..... | 79 |
| Network selection..... | 79 |
| Lights..... | 79 |
| Confirm SIM service actions..... | 79 |
| Security settings (Menu 6-3)..... | 79 |
| PIN code request..... | 80 |
| Call barring service..... | 80 |
| Fixed dialling..... | 81 |
| Closed user group..... | 81 |
| Security level..... | 82 |
| Change access codes | 82 |
| Restore factory settings (Menu 6-4)..... | 83 |
| 11. Call divert (Menu 7) | 84 |
| Selecting a divert mode | 84 |

| | |
|--|-----------|
| 12. Games (Menu 8) | 86 |
| Adjusting the settings for all the games | 86 |
| Playing a game | 86 |
| Making a connection to the WAP service of Club Nokia | 87 |
| 13. Calculator (Menu 9) | 88 |
| Making a calculation | 88 |
| Making a currency conversion | 89 |
| Currency conversion in standby mode | 89 |
| 14. Reminders (Menu 10) | 90 |
| Adding a reminder | 90 |
| Viewing the reminders | 91 |
| Erasing a reminder | 91 |
| When the reminder time is reached | 91 |
| 15. Clock (Menu 11) | 92 |
| Alarm clock (Menu 11-1) | 92 |
| Clock settings (Menu 11-2) | 93 |
| Date setting (Menu 11-3) | 93 |
| Stopwatch (Menu 11-4) | 93 |
| Countdown timer (Menu 11-5) | 94 |
| Auto update of date and time (Menu 11-6) | 94 |
| 16. Profiles (Menu 12) | 95 |
| Selecting a profile for use | 95 |
| Changing the settings of a profile | 95 |

| | |
|--|------------|
| Settings available in a profile..... | 96 |
| Ringing tone..... | 96 |
| Ringing volume | 96 |
| Incoming call alert | 97 |
| Message alert tone..... | 97 |
| Keypad tones..... | 97 |
| Warning tones..... | 97 |
| Vibrating alert..... | 97 |
| Screen saver | 97 |
| Rename..... | 98 |
| Receiving a profile (profile name, ringing tone, and screen saver) | 98 |
| 17.WAP services (Services – Menu 13) | 99 |
| Basic steps for accessing and using a WAP service | 99 |
| Setting up the phone for a WAP service | 100 |
| Saving the settings received as a text message | 100 |
| Keying in the connection settings manually | 101 |
| Making a connection to a WAP service..... | 102 |
| Browsing the pages of a WAP service..... | 103 |
| General guidelines for using the keys..... | 104 |
| Ending a WAP connection | 105 |
| Adjusting the appearance settings of WAP pages..... | 105 |
| Saving and managing bookmarks..... | 106 |
| When no WAP connection is in progress..... | 106 |
| When a WAP connection is in progress | 107 |
| Emptying the cache memory..... | 107 |
| Security certificates | 107 |
| 18. SIM services (Menu 14) | 109 |

| | |
|--|-----|
| 19. Reference information | 110 |
| Sending DTMF tones | 110 |
| Access codes | 110 |
| Security code | 110 |
| PIN code | 111 |
| PIN2 code | 111 |
| PUK code | 111 |
| PUK2 code | 111 |
| Barring password | 112 |
| Battery information | 112 |
| Charging and discharging the battery | 112 |
| Using the batteries | 113 |
| Care and maintenance | 114 |
| Important safety information | 115 |
| Index | 119 |

For your safety



Read these simple guidelines. Breaking the rules may be dangerous or illegal. Further detailed information is given in this manual.



ROAD SAFETY COMES FIRST

Don't use a hand-held phone while driving; park the vehicle first.



INTERFERENCE

All wireless phones may get interference which could affect performance.



SWITCH OFF IN HOSPITALS

Follow any regulations or rules. Switch phone off near medical equipment.



SWITCH OFF IN AIRCRAFT

Wireless phones can cause interference. Using them on aircraft is illegal.



SWITCH OFF WHEN REFUELING

Don't use phone at a refuelling point. Don't use near fuel or chemicals.



SWITCH OFF NEAR BLASTING

Don't use phone where blasting is in progress. Observe restrictions, and follow any regulations or rules.



USE SENSIBLY

Use only in normal position (to ear). Don't cover the antenna unnecessarily.



USE QUALIFIED SERVICE

Only qualified service personnel must install or repair equipment.



ACCESSORIES AND BATTERIES

Use only approved accessories and batteries. Do not connect incompatible products.





CONNECTING TO OTHER DEVICES

When connecting to any other device, read its user guide for detailed safety instructions. Do not connect incompatible products.





MAKING CALLS

Ensure the phone is switched on and in service. Enter the phone number, including the area code, then press  (Call). To end a call press  (End). To answer a call press  (Answer).



EMERGENCY CALLS

Ensure the phone is switched on and in service. Press and hold  twice for several seconds to clear the display. Enter the emergency number, then press  (Call). Give your location. Do not end the call until told to do so.

General information

■ Stickers on the sales package

The stickers contain important information for service and customer support purposes. Keep these stickers in a safe and secure place.

■ Security code

The security code protects your phone against unauthorised use. This code is supplied with the phone. The preset code is 12345. Change the code (see [Change access codes](#) on page 82) and set the phone to request it (see [Security level](#) on page 82). Keep the new code secret and in a safe place, separate from the phone.

■ Network services

The wireless phone described in this guide is approved for use on the EGSM 900 and GSM 1800 networks.

Note that dual band functionality is a network dependent feature. Check with your local operator if you can subscribe to and use this functionality.

A number of features included in this guide are called Network Services. They are special services provided by wireless service providers. Before you can take advantage of any of these Network Services, you must subscribe to these service(s) from your home service provider and obtain instructions for their use.

■ Accessories and batteries

This apparatus is intended for use when supplied with power from ACP-7, ACP-8, LCH-9, and DCV-10. Other usage will invalidate any approval given to this apparatus and may be dangerous.



Warning! Use only batteries, chargers and accessories approved by the phone manufacturer for use with this particular phone model. The use of any other types will invalidate any approval or warranty applying to the phone, and may be dangerous.

For availability of approved accessories, please check with your dealer.

When you disconnect the power cord of any accessory, grasp and pull the plug, not the cord.

1. Your phone

This chapter introduces you to the keys and display indicators of the phone. More details are given throughout this user's guide.

■ Using the keys

Power key

Pressing and holding the **Ⓜ** key switches the phone on or off.

In standby mode, pressing this key briefly shows the list of profiles which allow you to set the phone tones for different environments.

In a menu function, pressing this key briefly turns on the lights for 15 seconds.



Number keys

0 to **9** allow you to key in numbers and letters.

***+** and **G#** are used for various purposes in different functions.

Navi key

The use of the phone is largely based on the Nokia Navi™ key (☺) below the display (2).

The function of this key varies according to the guiding text (1) shown above it.

In this user's guide, the ☺ symbol is followed by the related guiding text, e.g. ☺ (Menu) or ☺ (Select).

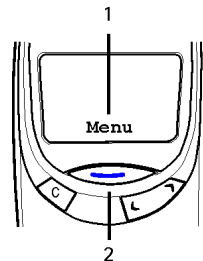

Scroll keys

In standby mode: ☺ shows the names and phone numbers saved in the phone book. ☺ shows the list of last dialed numbers.

In the menu: These keys browse through menus and settings.

When keying in a name or number or writing a text message:

☺ moves the cursor to the left and ☺ to the right.

During a call: These keys adjust the earpiece volume.



C key

When keying in a name or number: This key deletes the character to the left.

When pressed and held, it deletes all characters from the display.

In a menu function: This key returns to the previous menu level. Press and hold this key to exit the menu.

When you receive a call: Pressing this key rejects the call.

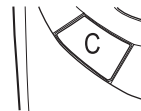



■ Display indicators

Display indicators inform you of the current operation of the phone.

Standby mode

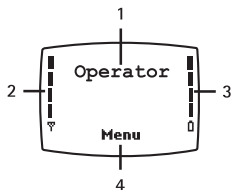
The indicators described below are shown when the phone is ready for use, with no characters keyed in by the user. When this screen is shown, the phone is in 'standby mode'.



1. Indicates in which cellular network the phone is currently used.
2. Shows the signal strength of the cellular network at your current location. The higher the bar, the stronger the signal.
3. Shows the battery charge level. The higher the bar, the more power left in the battery.
4. Shows the current function of the Nokia Navi™ key ()

Essential indicators related to menu functions

One or more of the following indicators may be shown when the phone is in standby mode:



Indicates that you have a call in progress.

See [Making a call](#) on page 31 and [Making a connection to a WAP service](#) on page 102.



Indicates that you have received a text or picture message.

See [Reading a text message \(Inbox - Menu 2-2\)](#) on page 58 and [Picture messages \(Menu 2-4\)](#) on page 59.



Indicates that the phone does not ring or beep when you receive a call since the "Incoming call alert" setting is set to *Off*.

See [Tones \(Menu 5\)](#) on page 71 and [Profiles \(Menu 12\)](#) on page 95.



Indicates that the phone's keypad is locked. See [Locking the keypad](#) on page 37.



Indicates that the alarm clock is on. See [Alarm clock \(Menu 11-1\)](#) on page 92.



Indicates that all your calls are diverted. See [Call divert \(Menu 7\)](#) on page 84.





Indicates that your calls are limited to a closed user group (network service). See [Closed user group](#) on page 81.

2

Indicates that you can make calls using phone line 2 only (network service). See [Phone line in use](#) on page 77.



Indicates that stopwatch timing is proceeding in the background. See [Stopwatch \(Menu 11-4\)](#) on page 93.

-  Indicates that the countdown timer is running in the background. See [Countdown timer \(Menu 11-5\)](#) on page 93.
-  Indicates that the name or phone number you have selected in the phone book is saved in the SIM card. See [Recalling a name and phone number \(Menu 01-1\)](#) on page 49.

2. Getting started

Before you can use your phone, you need to insert a SIM card in it, and then install and charge the battery.

■ Inserting a SIM card

The phone can only be used with a valid miniature plug-in SIM card. You can obtain the card from your network operator or service provider.

Using the SIM card

- Keep all miniature SIM cards out of small children's reach.
- The SIM card and its contacts can easily be damaged by scratches or bending, so be careful when handling, inserting or removing the card.

Inserting the SIM card in the phone

- Before installing the SIM card, always make sure that the phone is switched off and then remove the battery.

1. Remove the back cover:

Press the locking catch (1), slide the cover (2), and lift the cover off (3).

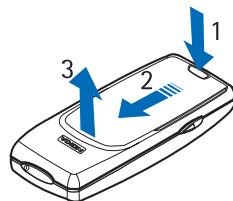
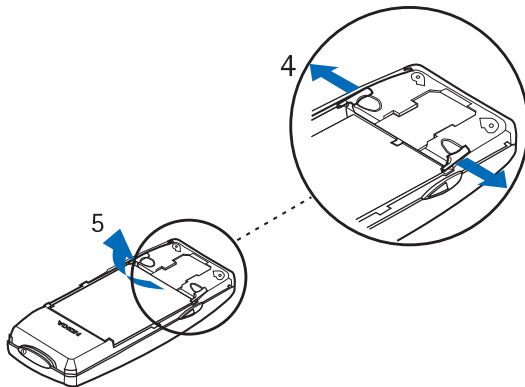
**2. Remove the battery:** Push the two release catches in the opposite directions (4) and remove the battery (5).

3. Insert the SIM card:

Slide the SIM card carefully into the SIM card slot (6).

Make sure that the golden connectors on the card are facing downwards and that the bevelled corner is on the left.

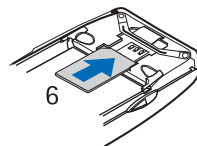
**4. Install the battery:**

Align the golden connectors on the battery with the corresponding connectors on the phone, and push the opposite end of the battery until it snaps into place (7).

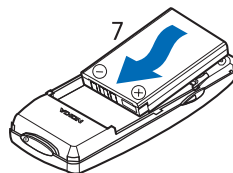
**5. Replace the back cover:**

Insert the two catches of the back cover in the corresponding slots in the phone (8), and slide the cover towards the bottom of the phone until it locks into place (9).

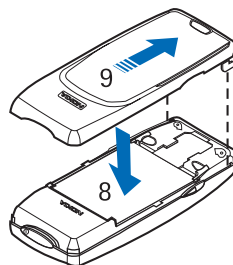

■ Charging the battery

- Do not charge the battery when either of the phone covers is removed. See also [Battery information](#) on page 112.
1. Connect the lead from the charger to the base of the phone.
 2. Connect the charger to an AC wall outlet. The battery indicator bar starts scrolling.
 - The phone can be used while charging if it is switched on.
 - If the battery is totally run down, it may take up to a few minutes before the charging indicator is shown.
 - The charging time depends on the charger and battery used and on how much power there is left in the battery. For example, charging the battery supplied with the phone may take up to six hours when using the ACP-7 charger.
 - If *Not charging* is displayed, charging is suspended. Wait for a while, disconnect the charger, plug it in again, and retry. If charging still fails, contact your dealer.
 3. When the battery is fully charged, the bar stops scrolling. Disconnect the charger from the AC outlet and the phone.

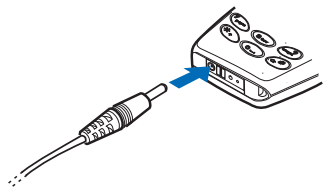

■ Switching the phone on or off

Switching on

Press and hold the **Ⓚ** key for a second.

If the phone requests a PIN code or security code:

Key in the code and press **Ⓚ** (OK).

See also [PIN code request](#) on page 80, [Security level](#) on page 82, and [Access codes](#) on page 110.



Warning! Do not switch on the phone when wireless phone use is prohibited or when it may cause interference or danger.



Note:

- Use the phone only with both covers mounted.
- Normal position: Hold the phone as you would any other telephone.
- Your phone has a built-in antenna (grey area in picture). As with any other radio-transmitting device, do not touch the antenna unnecessarily when the phone is switched on. Contact with the antenna affects call quality and may cause the phone to operate at a higher power level than otherwise needed. Not touching the antenna area during a call optimizes the antenna performance and the talk-time of your phone.



Switching off

Press and hold the **Ⓜ** key for a second.



Tip: Alternatively, press **Ⓜ** quickly in standby mode, scroll with **⏪** or **⏩** to *Switch off!*, and press **⏪** (OK).

■ Changing the Nokia Xpress-on™ covers

- Before changing the Nokia Xpress-on™ covers, always switch off the phone and disconnect it from the charger or any other device.
- Always store the phone with the covers attached. Read carefully [Care and maintenance](#) on page 114.

1. **Remove the back cover:** Press the locking catch (1), slide the cover (2), and lift it off the phone (3).

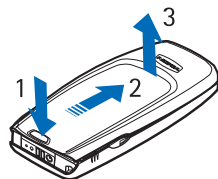

2. **Remove the front cover:** Gently pull the cover off the phone starting from the bottom of the phone (4).

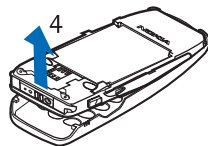

3. **Insert the keypad:** Insert the keypad mat in the front cover (5).

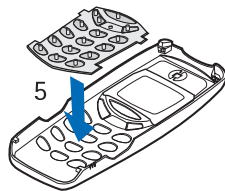

4. **Replace the front cover:** Align the top of the phone with the top of the front cover, and push the phone towards the cover until it locks into place (6).

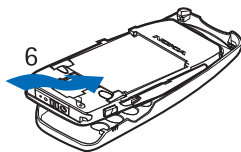

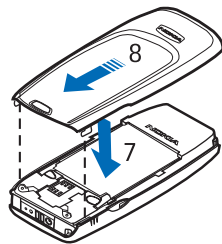

5. **Replace the back cover:** Insert the two catches of the back cover in the corresponding slots in the phone (7), and slide the cover until it locks into place (8).





3. Basic functions

■ Making a call

1. In standby mode, key in the phone number including the area code using the keys  to . The text **Menu** changes to **Call**.

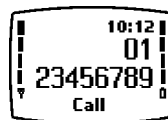
If you make a mistake, press  to delete the character to the left.



2. Press  (**Call**) and wait for the answer. The text **Call** changes to **End**.
3. Press  (**End**) to finish the call (or to cancel the call attempt).

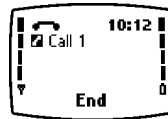



Switching to handsfree mode



When you are using the phone with the PPH-1 handsfree car kit, you can switch from handsfree mode to privacy mode by disconnecting the PPH-1 from the phone.

To switch back to handsfree mode, plug the PPH-1 into the phone.

International calls



1. In standby mode, press  twice quickly for the + character which replaces the international access code.
2. Enter the country code, area code (delete the leading 0 if necessary) and phone number.
3. Press  (**Call**) to call the number.

Adjusting the earpiece volume

You can adjust the earpiece volume during a call. Press  to increase and  to decrease the volume level.



Muting the microphone





To turn off the phone's microphone during a call: Press  and then  (**Options**), scroll to *Mute*, and press  (**Select**).

To turn on the microphone: Press  and then  (**Options**), scroll to *Unmute*, and press  (**Select**).

Redialling a last dialled number

You can redial any of the last 20 phone numbers that you have called or attempted to call. See also [Dialled numbers \(Menu 4-3\)](#) on page 68.

To redial one of these last dialled numbers:

1. In standby mode, press  once to view the list of dialled numbers.
2. Use  or  to scroll to the desired phone number or name.
3. Press  (**Call**) to call the number.

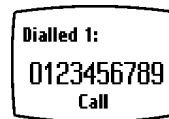







Making a call using the phone book





If you have saved a phone number in the phone book, you can dial it using the related name.

See page 50 for storing a phone number with a name.



1. Press  (**Menu**) in standby mode.

2. Press  (**Select**) (when *Phone book* is displayed).
3. Press  (**Select**) (when *Search* is selected).
4. Key in the first letter of the name (using the keys  to ) and press  (**OK**). For example, to view the first name starting with the letter "S", press  quickly four times.



You can skip this step if you like.

5. Scroll with  or  to the desired name. You can check the related phone number by pressing and holding .
6. Press  (**Call**).



Quick find: Press  in standby mode. The first name (and/or phone number) in the phone book is displayed. Find the desired name by first keying in its first letter and pressing  or .

Speed dialling a phone number

If you have assigned a phone number to one of the speed dialling keys  to , you can call this phone number in one of the following ways (in standby mode):





- Press the corresponding speed dialling key and then  (**Call**).
- If the *Speed dialling* function is on (see page 76): Press and hold the speed dialling key until the call is started.



Note that pressing and holding  calls your voice mailbox.





See also [Assigning a phone number to a speed dial key \(Menu 01-10\)](#) on page 52 and [Speed dialling](#) on page 76.



Making a new call during a call

You can have two calls in progress at the same time (network service).

1. During a call, press  to change the text above  from **End** to **Options**.
2. Press  (**Options**), scroll to *New call*, press  (**Select**), key in the phone number or recall it from the phone book, and press  (**Call**).

The existing call is put on hold. The active call is indicated by  and the held call by .

3. To switch between the two calls: Press  (**Options**), scroll to *Swap*, press  (**Select**).
4. To end the active call: Press  (**Options**), scroll to *End active call*, press  (**Select**). The held call becomes active.

To end both calls: Press  (**Options**), scroll to *End all calls*, press  (**Select**).





Voice dialling





You can dial a phone number by saying one or more words attached to it.

See [Voice dialling \(Menu 01-11\)](#) on page 53.

Making a conference call

Up to six persons can take part in a conference call (network service).

1. Make a call to the first participant.
2. During the call, press  and then  (**Options**). Scroll to *New call* and press  (**Select**) to make a call to the second participant. The first call is put on hold.
3. To join the first participant in the conference call, press  (**Options**), scroll to *Conference* and press  (**Select**).

- To add a new person to the call, repeat steps 2 and 3.
- To have a private conversation with one of the participants:
 - Press  (**Options**), scroll to *Private* and press  (**Select**). Scroll to the desired participant and press  (**OK**).
Once you have finished the private conversation, return to the conference call as described in step 3.
- Press  (**Options**) and select *End all calls*.

■ Answering a call

When somebody is calling you, the phone rings (if the *Incoming call alert* setting is not set to *Off*) and flashes its lights, and a related text is displayed.

If the network could not identify the caller, *Call* is displayed.

If the caller could be identified, the caller's phone number (or name if saved in the phone book) and *calling* are displayed.

- To answer the call, press  (**Answer**).

If the call was diverted from some other phone number, the > sign may be shown after *Call* or *calling* (network service).











- Press  (**End**) to finish the call.

Diverting or rejecting a call



If you do not want to answer the call, press . The caller will hear a "line busy" tone. If the *Divert when busy* function is activated (see page 84), the call is diverted e.g. to your voice mailbox.

Answering a new call during a call

When the *Call waiting options* function is on (see page 77), the phone beeps and displays a related text when you receive a new call. In a call list, a waiting call is indicated by ■■■.

1. Press  to change the text above  from **End** to **Options**.
2. Press  (**Options**), scroll to *Answer* and press  (**Select**). The other call is put on hold.
If you do not want to answer the call, select *Reject*.
3. To switch between the two calls: Press  (**Options**), scroll to *Swap*, and press  (**Select**).
4. To end the active call: Press  (**Options**), scroll to *End active call*, and press  (**Select**). The held call then becomes active.
To end both calls: Press  (**Options**), scroll to *End all calls*, press  (**Select**).

■ Listening to voice messages

1. In standby mode, press and hold  for a second to call your voice mailbox. You can obtain the voice mailbox number from your service provider.
2. If the phone asks for the number of the voice mailbox, key it in and press  (**OK**). See also [Voice mailbox number \(Menu 2-9\)](#) on page 64 and [Call divert \(Menu 7\)](#) on page 84.
3. Listen to the message(s) that you have received.
4. End the call by pressing  (**End**).



Tip: If the text **Listen** is shown above the  key, you can call your voice mailbox by pressing this key.





■ Locking the keypad

The keypad lock prevents keys from being accidentally pressed when, for example, the phone is in your pocket or handbag.

To turn the lock on:

In standby mode, press  (Menu) and then  quickly.

To turn the lock off:

Press  (Unlock) and then  quickly.



When the keypad is locked:







- The indicator  is shown
- You can answer, end or reject a call in the normal way.
During a call, you can operate the phone as usual.
- The HDC-5 headset can be used as usual.



Note: When the keypad is locked, calls may be possible to the emergency number programmed into your phone (112).

The number is displayed only when all the digits have been keyed in.

■ Selecting a ringing tone (Menu 5-1)

1. In standby mode, press  (**Menu**).
2. Scroll with  or  to *Tones* and press  (**Select**).
3. Scroll to *Ringing tone* and press  (**Select**).
4. Scroll to the desired ringing tone (a sample is sounded) and press  (**OK**) to select it.
5. Press and hold  to return to standby mode.





See also [Ringing tone \(Menu 5-1\)](#) on page 71.

■ Adjusting all the phone tones by a single setting

You can set the phone tones (e.g. ringing tone) and screen saver to function in the desired manner by selecting a setting group ('profile').

This makes it easy to adjust the tones for different environments and events (e.g. outdoor activities).

For more information, see [Tones \(Menu 5\)](#) on page 71 and [Profiles \(Menu 12\)](#) on page 95.

1. In standby mode, press the power key () quickly.
2. Scroll with  or  to the desired profile (e.g. to *Silent* to turn off the ringing tones).
3. Press  (**OK**) to confirm the setting.

■ Storing a phone number with a name

To save a new name and phone number in the phone book:

1. In standby mode, press  (**Menu**) (*Phone book* is displayed) and then  (**Select**).
2. Scroll with  to *Add name*, and press  (**Select**).

3. With the *Name*: text on the display, key in the desired name (see [Writing text](#) on page 39).
4. After you have written the name, press  (OK).
5. When *Phone number*: is displayed, key in the area code and the phone number that you want to save with the name.





If you make a mistake, press  to delete the digit to the left.



Tip: If you want to use the phone number when abroad, press  twice quickly for the + character and key in the country code, area code (delete the leading 0 if necessary) and phone number.



6. After you have written the phone number, press  (OK).
The name and phone number are saved in the phone book.
7. If you want to add a voice tag to the name and phone number, see [Voice dialling \(Menu 01-11\)](#) on page 53.



Quick save: In standby mode, key in the phone number. Press  or  to change the text above  to **Save**. Press  (**Save**). Key in the name and press  (OK).

■ Writing text

You can key in characters in two ways: by pressing a letter key once for each character (predictive text input) or by pressing a letter key one or more times for each character.

To exit from text input to standby mode at any time, press and hold  twice. Alternatively: Press  (**Options**), scroll to *Exit*, and press  (OK).

By pressing a key once for each character (predictive text input)

Predictive text input is an easy way to write for example text messages (see page 56) and reminder notes (see page 90). In this input method, you only need to press a key once for each character.

According to your keypresses, the phone tries to find the correct word from the currently selected dictionary. (For selecting a dictionary, see page 42.)

When you want to use predictive text input, check that  is shown at the top of the display.





You can switch between predictive and traditional text input by pressing  twice.



1. Write the desired word by pressing each key once for one letter.

For example, to write 'Nokia', press:



As you can see in the illustration above, the word changes after each keypress. Therefore, you do not need to pay much attention to what happens on the display before you have keyed in the whole word.



- To delete a character to the left, press . To clear the screen, press and hold this key.
- To switch between letter cases, press  repeatedly and check the indicator at the top of the display. For example, **abc** is shown when lower case is in use.
- To insert a punctuation mark, press  and then  repeatedly until the desired punctuation mark is shown.

- To insert a special character: Press and hold , scroll to the desired character, and press  (**Use**).
- To insert a number, press and hold the desired number key.
To insert several numbers, press and hold  and key in the numbers. For an alternative method, see step 3.

2. When you have finished writing the word, check that the word is correct.

If the word is correct: Press  or  and write the next word.

If the word is not correct: Press  repeatedly until the desired word appears. For an alternative method, see step 3.

If the ? character is shown after the word: There are no further words in the dictionary that correspond to your keypresses. To add a word into the dictionary: Press  (**Spell**), key in the word using traditional text input, and press  (**OK**).

If you want to change the previous word: Press  to highlight the word and edit it.

3. If the text **Options** is shown above , you can access the following options by pressing this key:

Matches: Shows a list of words that correspond to your keypresses. Scroll to the desired word and press  (**Use**).

Insert word: You can add a word to the dictionary manually. Write the word using traditional text input and press  (**OK**).



Insert number: You can key in numbers by pressing each number key once.

Insert symbol: You can select a special character from a list. Scroll to the desired character (such as %) and press  (**Use**).



Writing compound words

Write the first half of the word, press , and then write the second half.

Selecting a dictionary for predictive text input

1. In the *Write messages* menu (Menu 2-1), press  (**Options**).
2. Scroll to *Dictionary* and press  (**OK**).
3. Scroll to the desired language and press  (**OK**).



Turning predictive text input off

1. In the *Write messages* menu (Menu 2-1), press  (**Options**).
2. Scroll to *Dictionary* and press  (**OK**).
3. Scroll to *Dictionary off* and press  (**OK**).

By pressing a key one or more times for each character (traditional text input)

Traditional text input is commonly used in mobile phones. In this input method, you press a key repeatedly until the desired character appears.











When you want to use traditional text input, check that  is shown at the top of the display.

1. When writing text, press a number key ( to ) marked with the desired character one or more times until the character appears.

The available characters depend on the language selected for display texts (see Language on page 78).

Note that all available characters are not printed on the keys.

2. You can use the following functions to edit the text:

- To add a space, press .
- To add a punctuation mark or special character, press  repeatedly. Alternatively: Press , scroll to the desired character, and press  (Use).
- To move the cursor left or right, press  or , respectively.
- To delete the character to the left, press . To clear the screen, press and hold this key.
- To switch between upper and lower case, press  quickly.
- To add a number, press and hold the key labelled with the desired number. To switch between letters and numbers, press and hold . 123 is shown when numbers can be entered.
- To key in a character which is under the same key as the previous one, press  or  (or wait for one second) and key in the new character.









4. Using the menus

The phone offers a range of functions that allow you to tailor it to your needs.

These functions are arranged in menus and submenus which can be accessed by scrolling or using the appropriate shortcut.

■ Accessing a menu function

By scrolling

1. Press  (**Menu**) in standby mode.
2. Press  or  to scroll to the desired main menu, e.g. *Settings*, and press  (**Select**) to enter it.
3. If the main menu contains submenus, scroll to the desired one (e.g. *Call settings*) and press  (**Select**) to enter it.
4. Scroll to the desired function (e.g. *Speed dialling*) and press  (**Select**) to enter it.
5. Scroll to the desired setting (e.g. *Off*) and press  (**OK**) to confirm it.
If you do not want to change the setting, press .





By a shortcut

The menus, submenus and setting options are numbered and can be accessed by their shortcut number. The shortcut number is shown on the top right of the display.

1. Press  (Menu).
2. Key in quickly (within three seconds) the number of the menu you want to access.
Repeat this step for a submenu.
3. Within three seconds, key in the number of the desired function and setting option.

■ Exiting a menu function

You can return to the previous menu level by pressing  or exit the menu by pressing and holding .

■ List of menu functions

1. Phone book

1. Search
2. Service Nos. ¹
3. Add name
4. Erase
5. Edit
6. Copy
7. Assign tone
8. Send b'card
9. Options
 1. Memory in use
 2. Type of view
 3. Memory status
10. Speed dials
11. Voice tags

2. Messages

1. Write messages
2. Inbox

3. Outbox

4. Picture messages
5. Templates
6. Smileys
7. Message settings
 1. Set 1²
 1. Message centre number
 2. Messages sent as
 3. Message validity
 2. Common ³
 1. Delivery reports
 2. Reply via same centre
 3. Character support
8. Info service
9. Voice mailbox number ⁴
10. Service command editor

3. Chat

4. Call register

1. Missed calls

1. Shown only if supported by the SIM card.

2. The amount and names of sets may vary. Each set appears in its own submenu.

3. The shortcut number of this menu depends on the amount of sets available.

4. May not be shown if the voice mailbox number has been saved on the SIM card by your network operator or service provider.

2. Received calls
 3. Dialed numbers
 4. Erase recent call lists
 5. Show call duration
 1. Last call duration
 2. All calls' duration
 3. Received calls' duration
 4. Dialed calls' duration
 5. Clear timers
 6. Show call costs
 1. Last call cost
 2. All calls' cost
 3. Clear counters
 7. Call cost settings
 1. Call cost limit
 2. Show costs in
 8. Prepaid credit
5. Tones
 1. Ringing tone
 2. Ringing volume
 3. Incoming call alert
 4. Composer
 5. Message alert tone
6. Keypad tones
 7. Warning tones
 8. Vibrating alert
 9. Screen saver
6. Settings
 1. Call settings
 1. Automatic redial
 2. Speed dialling
 3. Call waiting options
 4. Own number sending
 5. Phone line in use
 6. Automatic answer ¹
 2. Phone settings
 1. Language
 2. Cell info display
 3. Welcome note
 4. Network selection
 5. Lights ²
 6. Confirm SIM service actions
 3. Security settings
 1. PIN code request
 2. Call barring service
 3. Fixed dialling
 4. Closed user group

1. Shown only when the phone is connected to the PPH-1 handsfree car kit or the HDC-5 headset.

2. Shown only when the phone is connected to the PPH-1 handsfree car kit.

5. Security level
6. Change access codes
4. Restore factory settings
7. Call divert ¹
 1. Divert all voice calls without ringing
 2. Divert when busy
 3. Divert if not answered
 4. Divert when phone off or no coverage
 5. Divert when off, no answer, or no coverage
 6. Cancel all divers
8. Games
9. Calculator
10. Reminders
11. Clock
 1. Alarm clock
 2. Clock settings
 3. Date setting
 4. Stopwatch
 5. Countdown timer
 6. Auto update of date and time
12. Profiles
13. Services
14. SIM services ²

1. The divert options that are not supported by your network operator may not be shown.



2. The availability, name and contents depend on the SIM card used.



5. Phone book (Menu 01)

Within the *Phone book* menu you can

- save phone numbers and their related names in your phone and the SIM card
- manage the saved names and phone numbers



To access this menu: In standby mode, press  (**Menu**) and then  (**Select**).

To enter the phone book during a call, press  to change the text above  to **Options**, press  (**Options**), and select *Phone book*.

■ Recalling a name and phone number (Menu 01-1)

With the *Search* function you can recall the desired name and phone number from the phone book to the display e.g. for calling. See also [Making a call using the phone book](#) on page 32.

When you browse through the names and phone numbers,  is shown on the top right if the currently selected name or phone number is saved in the SIM card.

■ Calling a service number (Menu 01-2)

With the *Service Nos.* function you can easily call the service numbers of your service provider. This menu is shown only if there are service numbers saved on your SIM card.

Select the desired service number and press  (**Call**) to call it.

■ Storing a name and phone number (Menu 01-3)



With the *Add name* function you can add names and phone numbers in the phone book. For more information, see page 38.

The phone supports SIM cards which can save up to 250 phone numbers and names. However, it depends on the SIM card how many numbers and names can be saved in it.

■ Erasing a name and phone number (Menu 01-4)

With the *Erase* function you can delete phone numbers and names from the phone book one by one (select *One by one*) or all at once (*Erase all*).

■ Editing a name and phone number (Menu 01-5)

With the *Edit* function you can modify the names and phone numbers saved in the phone book. Scroll to the desired name or phone number and press  (**Edit**). Edit the name and press  (**OK**). Edit the phone number and press  (**OK**). For keying in a name, see [Writing text](#) on page 39.

■ Copying or moving a name and phone number (Menu 01-6)

With the *Copy* function you can copy or move names and phone numbers from the phone to the SIM card (or vice versa) one by one or all at once.

■ Assigning a ringing tone to a phone number (Menu 01-7)



With the *Assign tone* function you can set the phone to play a specific ringing tone when you receive a call from a particular phone number.

Scroll to a name or phone number in the phone book and press  (Assign).

Scroll to the desired ringing tone (*Default* is the tone selected for the current profile in Menu 12) and press  (OK).

■ Sending and receiving a name and phone number (Menu 01-8)

With the *Send b'card* function you can send a name and phone number ("business card") from your phone book as a text message to another phone.

Select *Send b'card*, scroll to the name and phone number you want to send, and press  (Send). Enter the recipient's phone number or recall it from the phone book, and press  (OK).

Receiving a name and phone number

When somebody sends you a phone number and related name, you will hear a message tone and the text *Business card received* is displayed.

To view, save, or erase the number and name, press  (Options), scroll to the desired function, and press  (OK).

■ Options (Menu 01-9): Memory in use, Type of view, and Memory status

Selecting the memory for names and phone numbers (Memory in use)

You can select whether the names and phone numbers are saved in your phone (option *Phone*) or the SIM card (*SIM card*). Note that when you change the SIM card, the *SIM card* option is automatically selected.

Selecting the way the saved names and phone numbers are shown (Type of view)

You can define how the saved phone numbers and names are shown. The options are:

Name list: Shows three names at a time.

Name, number: Shows one name and phone number at a time.

Large font: Shows one name at a time in large font.

Checking the amount of free space in the phone book (Memory status)

You can check how many names and phone numbers can still be saved and are currently saved in the phone book.

■ Assigning a phone number to a speed dial key (Menu 01-10)

You can set any of the number keys  to  to work as a speed dialling key.

With the *Speed dials* function you can assign the desired phone number to one of these keys.

1. Scroll to the desired key and press  (**Assign**).

Assign is also shown when the phone has automatically assigned a phone number to a speed dialling key.

2. Search for the desired name and/or phone number from the phone book, and press  (**Select**) to select it.

You can view, change, or delete any assignments that you have made by first pressing  (**Options**) and then selecting the desired function.

Using the speed dialling keys

Either: In standby mode, press the desired speed dialling key and press  (Call).

Or if *Speed dialling* is on (see page 76): In standby mode, press and hold the desired speed dialling key until the call is started.

■ Voice dialling (Menu 01–11)

You can dial a phone number by saying one or several words ('voice tag') attached to it. The voice tag can be any spoken word, for example a name.

Before using voice dialling, note the following:

- Voice tags are stored in the phone and removed when you insert another SIM card into the phone.
- When recording a voice tag or making a call by saying a voice tag, hold the phone in the normal position near your ear. The phone must be in a service area with adequate cellular signal strength.
- Voice tags are not language dependent. They are dependent on the speaker's voice.
- Voice tags are sensitive to the background noise; record voice tags in a quiet environment.
- Very short names are not accepted; use long names and avoid similar names for different numbers.
- Eight phone numbers can have a voice tag attached at a time.

Note that the phone must be in a service area with adequate cellular signal strength. Also, you must say the name exactly as you said it when you recorded it. This may be difficult in, for example, a noisy environment or during an emergency, so you should not rely solely upon voice dialling in all circumstances.



Adding a voice tag to a name and phone number

1. In the *Voice tags* menu, select *Add voice tag* and then the name and phone number to which you want to add a voice tag.

Press Start, then speak after tone is displayed.

2. Press  (**Start**). The phone sounds a tone and *Please speak now* is briefly displayed.
3. Hold the phone near your ear and say clearly the word(s) you want to record as a voice tag.
4. After recording, the phone plays the recorded voice tag and saves it.

Making a call by saying a voice tag

1. In standby mode, press and hold  (**Menu**). The phone sounds a tone and *Please speak now* is displayed.
2. Say the desired voice tag clearly while you hold the phone in the normal position near your ear.
3. The phone plays the voice tag and dials the related phone number.
 - If no match for the voice tag is found or recognised, the phone will ask you to try again. Press  (**Yes**) to say the voice tag again, or  to return to standby mode.



When you use the HDC-5 headset

1. Press and hold the headset button until you hear a short tone.
2. Say the voice tag clearly.
3. The phone plays the voice tag and automatically dials the related phone number.

Listening to a voice tag



1. In the *Voice tags* menu, select *Playback*.
2. Scroll to the name or phone number whose voice tag you want to hear, and press  (**Select**).

Changing a voice tag

1. In the *Voice tags* menu, select *Change*.
2. Scroll to the name (or phone number) whose voice tag you want to change, and press  (**Select**).
3. Press  (**Start**) to start the recording. The phone sounds a tone and *Please speak now* is displayed.
4. Say the word(s) you want to record as a new voice tag. The phone plays the new voice tag and confirms that it has been saved.

If you press  (**Quit**) while the phone plays the voice tag or if the phone doesn't accept the word, for example if the word is too short, the original voice tag is deleted.



Erasing a voice tag

1. In the *Voice tags* menu, select *Erase*.
2. Scroll to the name (or phone number) whose voice tag you want to erase, and press  (**Erase**).
Erase voice tag? is displayed.
3. Press  (**OK**) to erase the voice tag.

6. Messages (Menu 2)

Within the *Messages* menu you can use various message functions related to voice, text and picture messages.





To access this menu: In standby mode, press  (**Menu**), scroll to *Messages*, and press  (**Select**).



■ Writing and sending a text message (Menu 2-1)

You can write and send multi-part text messages of almost three ordinary text messages in length (network service). Invoicing is based upon how many ordinary messages are needed for any multi-part message.

Before sending a message, make sure that the phone number of your message centre is saved in the phone (see [Message centre number](#) on page 62). You can obtain this number from your service provider.

To exit from this menu at any time to standby mode, press and hold  twice. Alternatively: Press  (**Options**), scroll to *Exit*, and press  (**OK**).



Writing a message

1. In the *Messages* menu, scroll with  or  to *Write messages* and press  (**Select**).
2. Write a message using predictive or traditional text input (see [Writing text](#) on page 39).



The number of available characters and the current part number are shown on the top right of the display. For example, 233/2 means that there are 233 characters left in total and that you are writing the second part of the message.



Tip: You can switch between the predictive and traditional text inputs by pressing  twice.

3. While writing the message, you can access a further set of functions by pressing  (**Options**). Scroll to the desired function and press  (**OK**).

Send: You can send the message to the desired recipient. Key in the recipient's phone number (or recall it from the phone book) and press  (**OK**). The message is sent using the set 1 in *Message settings* (see page 61).

Send to many: You can send the message to several recipients one after another. Scroll to the first recipient and press  (**Send**). Repeat this for each recipient. You can return to the message by pressing .

Template: You can use a preset message as a basis for your message.

Insert smiley: You can add a smiley character such as ":-)" to the message. Scroll to the desired smiley and press  (**Select**).

Dictionary: You can switch to traditional text input (select *Dictionary off*) or to predictive text input (select the desired language).

Send by set: You can select some other set of message settings than the set 1 (see page 61).

Save: Saves the message in *Outbox* (Menu 2-3).











Erase: Deletes all the characters from the message.

Exit: You can return to standby mode at any time.

■ Reading a text message (Inbox – Menu 2-2)



When you receive a new text message, you hear a message alert tone selected for the current profile, and the number of new messages as well as  are shown (in standby mode).

When  flashes, there is no more space for new messages. Use the *Erase* function in the *Inbox* menu (Menu 2-2) to free some space.

1. Press  (**Read**) to view the messages right away. To view the messages later, press  and enter the *Inbox* menu (Menu 2-2) when you want to do so.
2. Scroll with  or  to the desired message and press  (**Read**). Unread messages are indicated by .
3. Use  or  to browse through the message.
4. While reading the message, you can use the functions below. Press  (**Options**), scroll to the desired function, and press  (**OK**). The functions available are:

Erase: Deletes the message.

Reply: You can send a reply to the sender of the message. See [Writing and sending a text message \(Menu 2-1\)](#) on page 56.

Chat: You can have a conversation based on text messages with another party. Key in the nickname that you want to use in the chat, and press  (**OK**). Write the chat message and press  (**Options**) and select *Send* to send it. For more information, see [Chat \(Menu 3\)](#) on page 65.

Edit: You can modify the message. See [Writing text](#) on page 39.

Use number: Extracts a phone number from the message for calling or saving.

Forward: You can edit and forward the message to the desired phone number.

Details: Shows the sender's name and phone number, the message centre used for sending as well as the reception date and time.

■ Viewing a message you have saved (Outbox – Menu 2-3)

You can view the messages that you have saved in *Write messages* (Menu 2-1). Pressing  (**Options**) allows access to the same functions as in *Inbox* (Menu 2-2), except for *Reply*, *Chat*, and *Details*.

■ Picture messages (Menu 2-4)





With your phone, you can receive and send text messages that contain pictures. These messages are called picture messages. There are several preset picture messages available in the phone.

This function can be used only if it is supported by your network operator or service provider.

Note that:

- Each picture message is made up of several text messages. Therefore, sending one picture message may cost more than one text message.
- Since picture messages are saved in the phone, you cannot view them if you use the SIM card with another phone.
- Only phones that offer the picture message feature can receive and display picture messages.

When you receive a picture message



- To view the message immediately, press  (**View**). You can save the message by pressing  (**Save**) or delete it by pressing  twice.
- To view the message later in this menu: Press  and then  (**OK**) to save the message.

When you view the message in this menu

Pressing  (**Options**) allows access to the same functions as in *Inbox* (Menu 2-2), except for *Reply* and *Chat*.



With the *Edit text* function you can modify the text part of the message and send it further; see [Writing and sending a text message \(Menu 2-1\)](#) on page 56.



Sending a picture message

1. In the *Picture messages* menu, scroll to a picture message and press  (**View**).
2. If the displayed picture is the one you want, press  (**Options**), scroll to *Edit text* and press  (**Select**).

If the displayed picture is not the one you want, press  and repeat step 1.

3. Write the message.

To view the whole message before sending it, press  (**Options**), scroll to *Preview*, and press  (**OK**).

4. Press  (**Options**), scroll to *Send*, and press  (**OK**).

■ Templates (Menu 2-5)

Your phone offers some preset messages ('templates') that you can use when writing a message. Within this menu you can view, edit, and erase the templates.





Scroll to the desired template and press  (**Read**).

When the template is displayed, press  (**Options**) and then select whether you want to edit or erase the template.

While editing a template, pressing  (**Options**) allows access to a further set of functions, including *Send* and *Save*.

You can create a template from scratch by selecting one of the empty templates at the end of the template list.

■ Smileys (Menu 2-6)

With this function you can create smiley characters such as ":-)" that you can use when writing or replying to a message. Scroll to the desired smiley and press  (**Read**). The smiley can be any sequence of characters. Press  (**Options**) and select *Edit*. Change the smiley to your liking (press and hold  for special characters) and press  (**OK**). For editing, see [Writing and sending a text message \(Menu 2-1\)](#) on page 56.

■ Message settings (Menu 2-7)

The phone offers two kinds of message settings: settings specific to each settings group or 'set', and settings common to all text messages.

Set 1 (Menu 2-7-1) ¹

A set is a collection of settings needed for sending text and picture messages.

You can, for example, send a text message as a fax, if supported by your service provider, by simply selecting the set in which you have earlier defined the proper settings for fax transmissions.

Each set has its own submenu where you can change the settings described below.

1. The total number of sets depends on how many sets your SIM card offers.

Message centre number

You can save the phone number of the message centre used for sending text and picture messages. You obtain this number from your service provider.

Key in the phone number or recall it from the phone book, or edit the existing number, and press  (OK).

Messages sent as

You can request the network to convert your *Text* messages into *E-mail*, *Fax* or *Paging* format (network service).

In order to receive a converted message, the recipient must have the appropriate equipment, e.g. a fax machine.

Message validity

You can set the length of time that your text messages are stored at the message centre (network service).

Common (Menu 2-7-2) ¹

The settings in this submenu apply to all text messages that you send, irrespective of the chosen set.

Delivery reports

You can request the network to send delivery reports on your text messages (network service).

1. The shortcut number of this menu depends on the number of sets available. Here it is assumed that only one set is available.

Reply via same centre

When this function is on, the recipient of your text message can send you a reply via the same message centre as your original message (network service).

Character support

When the *Unicode* option is selected, you can send messages using special characters (such as ñ) in Romance and Slavic languages or Russian characters to a compatible phone, if supported by your network.

■ Info service (Menu 2-8)

With this network service you can receive messages on various topics (such as weather or traffic conditions) from your service provider.

For available topics and related topic numbers, contact your service provider.

If you select *On*, you will receive messages on the active topics. *Topic index* sets the phone to receive a list of available topics from the network.

If you select *Topics*, you can mark the topics as active or inactive, add a new topic to the topic list, or edit or erase the existing topics on the list.

If you select *Language*, you can select the language for the messages. Only messages in the selected language will be shown.

■ Voice mailbox number (Menu 2-9)

In a voice mailbox, callers can leave messages that you can listen to later (network service).

Within this menu you can save the phone number of your voice mailbox. Key in the number (obtained from the service provider) and press  (OK).

Note that this menu may not be shown if the voice mailbox number has been saved in the SIM card by your network operator or service provider.

Each phone line may have its own voice mailbox number (see [Phone line in use](#) on page 77).

For listening to voice messages, see page 36.

For diverting incoming calls to your voice mailbox, see page 84.



■ Service command editor (Menu 2-10)

You can send service requests to your service provider. Key in the desired characters. Press and hold  to switch between letters and numbers. Press  (Send) to send the request.

7. Chat (Menu 3)

With the *Chat* function you can have a conversation with other people using text messages.





To access this menu: In standby mode, press  (Menu), scroll to *Chat*, and press  (Select).

■ Starting a chat



You can start a chat either within this menu or by selecting the *Chat* option that you can access by pressing  (Options) while reading a received text message.

1. If you start a chat within this menu, key in the other person's phone number or recall it from the phone book (see [Making a call using the phone book](#) on page 32), and press  (OK).

If you have previously had a chat with the same person, the last 500 characters of this chat are shown.

2. Key in a nickname (see [Writing text](#) on page 39) that you want to use in the chat, and press  (OK).
3. Write your chat message as you would a normal text message, press  (Options), and select *Send* to send the message.

Pressing  (Options) allows access to the same functions as when writing a text message except for *Save* and *Send to many*. In addition, *Chat history* shows all the messages sent (indicated by "<" and your nickname) and received (indicated by ">" and the other person's nickname) during the current chat, and *Chat name* allows you to edit your nickname.

4. When you receive a reply from the other party, the reply message is shown above the message that you sent. Press  (OK) to clear the display, write your reply, and send it by pressing  (Options) and selecting *Send*. Repeat this for each chat message.

Note that the messages received during a chat are not saved in the *Inbox* menu.

8. Call register (Menu 4)

Within the *Call register* menu you can access the phone numbers registered automatically by the phone.



You can also view the approximate duration and cost of your calls, and manage the credit units in your prepaid SIM card.

To access this menu: In standby mode, press  (**Menu**), scroll to *Call register*, and press  (**Select**).

Options within Menus 4-1 to 4-3

With the options that you access by pressing  (**Options**) you can

- edit, view or call a registered phone number
- view the time of the call
- save the number in the phone book
- erase the number from the call list (not from the phone book)
- send a text message to the caller (*Send SMS*)

About missed and received calls

The phone registers missed and received calls if:

- the network allows showing the caller's phone number to the call recipient
- the phone is switched on and within the network's service area

■ Missed calls (Menu 4-1)

This function shows you the last 10 phone numbers from which somebody has tried to call you with no success (network service).



Tip: You can also view these phone numbers by pressing  (List) when a note about missed calls is displayed. The previously registered phone numbers are also shown.

■ Received calls (Menu 4-2)

This function shows the last 10 phone numbers from which you have accepted a call (network service).

■ Dialed numbers (Menu 4-3)

This function shows the last 20 phone numbers that you have called or attempted to call.

■ Erase recent call lists (Menu 4-4)

With this function you can delete all the phone numbers and names from Menus 4-1 to 4-3.

These phone numbers are also erased in the following cases:

- When you switch on the phone with a SIM card which is not one of the five cards used most recently with the phone.
- When you change the *Security level* setting (see page 82).

■ Show call duration (Menu 4-5)

With this function you can view the approximate duration of your outgoing and incoming calls.

You can reset these so-called call timers using the *Clear timers* function (Menu 4-5-5). For this you need the security code (see [Access codes](#) on page 110). Changing the SIM card does not clear the call timers.



Note: The actual time invoiced for calls by your service provider may vary, depending upon network features, rounding-off for billing, and so forth.

■ Show call costs (Menu 4-6)

With this network service you can view the approximate cost of your last call or all calls.

The costs are shown in terms of units specified within the *Show costs in* function (Menu 4-7-2).

Call costs are shown separately for each SIM card.



Note: The actual invoice for calls and services from your service provider may vary, depending upon network features, rounding-off for billing, taxes and so forth.

■ Call cost settings (Menu 4-7)

Call cost limit

You can limit the costs of calls to a certain amount of charging units or units of currency (network service).

You can make and receive charged calls as long as the specified cost limit is not exceeded. The number of remaining units is shown in standby mode.



To set the limit you may need the PIN2 code (see [Access codes](#) on page 110).

Note that when no more charging or currency units are left, only calls to the emergency number 112 may be possible.

Show costs in

The phone can show the remaining talk-time in terms of charging units or the desired currency. Contact your service provider for charging unit prices.

For this function you may need the PIN2 code (see [Access codes](#) on page 110).

If you selected *Currency*, key in the charging unit price, press  (OK), key in the currency name, and press  (OK).



■ Prepaid credit (Menu 4-8)

Within this menu you can view and change settings related to prepaid SIM cards (network service). When using a prepaid SIM card, you can make calls only when there are enough credit units on the SIM card.

With the *Credit info display* function you can set the phone to show the amount of remaining credit units when the phone is in standby mode.

Credit available shows the amount of remaining credit units.

Last event costs shows information about previous calls.

Recharge status shows the time and date when credit units were last recharged. Pressing  (More)  shows the expiry date of credit units.

9. Tones (Menu 5)

Within the *Tones* menu you can adjust the settings of the selected profile. You can also create ringing tones of your own using the *Composer* function.



See also [Profiles \(Menu 12\)](#) on page 95 and [Adjusting all the phone tones by a single setting](#) on page 38.

To access this menu: In standby mode, press  (**Menu**), scroll to *Tones*, and press  (**Select**).

■ Ringing tone (Menu 5-1)

Sets the ringing tone for voice calls. Scroll to the desired tone and press  (**OK**). The tones that you have received from somebody or that you have composed yourself can be found at the end of the tone list.

■ Ringing volume (Menu 5-2)

Sets the volume level for the ringing and message alert tones. Scroll to the desired level and press  (**OK**).

■ Incoming call alert (Menu 5-3)

Defines how the phone notifies you of incoming voice calls. The options are: *Ringing*, *Ascending*, *Ring once*, *Beep Once*, and *Off*.

When *Off* is selected, all phone tones are mute and  is displayed.

■ Composer (Menu 5-4)

You can compose a ringing tone of your own. The composed tones are shown last in the tone list.



Note: Your phone must be switched on to use this function. Do not switch on the phone when wireless phone use is prohibited or when it may cause interference or danger.

Creating a new ringing tone



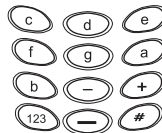

1. Scroll to the tone that you want to edit and press (**Select**).
2. Enter the desired notes. For example, press for note f (shown as *f*). The phone plays each note after it is entered (unless the phone tones are off).
3. To adjust the characteristics of the note:



- **Note duration:** shortens (-) and lengthens (+) the duration of the note or rest. The default duration is 1/4. The duration is shown in front of the note, e.g. *16d* denotes a note d with duration 1/16.

Pressing and holding a note key lengthens the note by half, indicated by a dot after the duration, e.g. *8.a*.

- **Rest:** inserts a rest (i.e. pause) of the same duration as the previous note. The default duration of a rest is one quarter note (1/4). The rest is indicated by the - character.
- **Octave:** sets the octave for new notes. The octave is shown as a number after the note (e.g. *e1*).
- **Pitch:** makes the note sharp (indicated by # in front of the note), e.g. *#f*. The pitch selection is not available for notes e and b.

- To edit the notes:
 -  and  move the cursor right or left, respectively.
 -  deletes a note or a rest to the left.
- After you have completed the tone, press  (**Options**), scroll to one of the functions below, and press  (**OK**).

Play: Plays back the notes.

Save: You can name the tone and add it to the end of ringing tone list.

Tempo: You can select the desired tempo for the tone (in beats per minute).

Send: You can send the tone that you created to a compatible phone.

Clear screen: Deletes all the notes from the display.

Exit: You can exit the Composer menu.

Example: Here is an example of a ringing tone. Enter the notes and play them as described above. Change the different aspects of the tone (notes, octave, duration, etc.) and consider how these changes affect the tone.

16.a2 16d2 16#f2 16a1 16d2 16#f2 8a2 1- 8-

16.b2 16d2 16#f2 16a1 16d2 16#f2 8a2 1- 8-

16.a2 16e2 16g2 16a1 16e2 16g2 8a2 1- 8-

16.e3 16#f2 16a2 16d2 16#f2 16a2 8d3 1- 8-

Receiving a ringing tone

When somebody sends you a ringing tone, you hear a message tone and the related text is displayed.

To play, save, or erase the tone, press  (**Options**), scroll to the desired function, and press  (**OK**).

■ Message alert tone (Menu 5-5)

Sets the alert tone for text messages. Scroll to the desired tone and press  (**OK**).

■ Keypad tones (Menu 5-6)

Sets the volume level for keypad tones. Scroll to the desired level and press  (**OK**).

■ Warning tones (Menu 5-7)

Sets the phone to sound a warning tone, for example when the battery is running out of power. This setting has no effect on the tones that are related to network services.

■ Vibrating alert (Menu 5-8)



Sets the phone to vibrate when you receive a voice call or a text message. You can also set the phone to first vibrate and then ring.

The vibrating alert is disabled when the phone is connected to a charger or a desktop stand.

■ Screen saver (Menu 5-9)

Sets the picture that is displayed in standby mode after a selected period of time (called 'timeout'). You can also use animated pictures as screen savers.

Select *Off*, *On* (previously selected screen saver is shown), *Timeout*, or *Screen saver*, and press  (OK).

If you selected *Screen saver*, the currently selected screen saver picture is shown. To change it, scroll to the desired picture and press  (Use). If you selected *Timeout*, scroll to the desired time and press  (OK).

The use of an animated picture as a screensaver uses power so it reduces the operation time of your phone. For downloading animated pictures, see the *View picture* function in [Browsing the pages of a WAP service](#) on page 103.

10. Settings (Menu 6)



Within the *Settings* menu you can adjust

- call settings (Menu 6-1)
- general phone settings (Menu 6-2)
- security settings (Menu 6-3)

You can reset the menu settings to their original values using the *Restore factory settings* function (Menu 6-4).



To access this menu: In standby mode, press  (**Menu**), scroll to *Settings*, and press  (**Select**).

■ Call settings (Menu 6-1)

Automatic redial

When this function is on, your phone will make up to ten attempts to connect the call after an unsuccessful call attempt.

Speed dialling

When this function is on, you can dial the names and phone numbers assigned to the speed dial keys  to  by pressing and holding the corresponding key.

Pressing and holding  dials your voice mailbox number.

Call waiting options

When this network service is activated, the network notifies you of a new incoming call while you have a call in progress. See [Answering a new call during a call](#) on page 36.

Own number sending

With this network service you can set your phone number to be displayed (*On*) or hidden (*Off*) from the person you are calling. When you select *Set by network*, the setting agreed with your service provider is used.

Phone line in use

The phone may be used with a SIM card which supports two subscriber numbers, i.e. phone lines. This is a network service.

Within this menu you can select the desired phone line (1 or 2) for making calls or prevent line selection. Calls on both lines can be answered irrespective of the selected line.

You will not be able to make calls if you select line 2 and you have not subscribed to this network service. When line 2 is selected, 2 is shown on the top left of the display in standby mode.

To allow or prevent the line selection you need the PIN2 code.



Tip: In standby mode, you can switch between the lines by pressing and holding .

Automatic answer

You can set the phone to answer an incoming call after one ring.

This function can be used when the phone is connected to the PPH-1 handsfree car kit or the HDC-5 headset. When using the car kit, note that some cigarette charger plugs do not provide power when the ignition is off.

This function does not work when the phone tones are set to *Off*.

■ Phone settings (Menu 6-2)

Language

You can select in which language the display texts are shown.

When *Automatic* is selected, the phone selects the language according to the information on the SIM card.

This setting also determines which characters are available when you write text, for example a name or text message.

Cell info display

With this network service you can set the phone to indicate when it is used in a cellular network based on Micro Cellular Network (MCN) technology. In such a network, local calls may cost less than otherwise.

Welcome note

You can write a message which is shown briefly when the phone is switched on.

Network selection

You can set the phone to automatically select one of the cellular networks available in your area (default setting), or you may select the desired network manually from a list of networks.

When selecting a network manually, the selected network must have a roaming agreement with your home network (i.e. the operator whose SIM card is in your phone). Otherwise the text *No access* is shown.

The phone will stay in manual mode until you select automatic mode or insert another SIM card in the phone.

Lights

You can set the display and keypad lights to be on or off. This setting is available when the phone is connected to the PPH-1 handsfree car kit.

Confirm SIM service actions

You can set the phone to show (*Asked*) or hide (*Not asked*) confirmation messages when you are using the SIM card services. See also [SIM services \(Menu 14\)](#) on page 109.

■ Security settings (Menu 6-3)

Your phone is equipped with a versatile security system to prevent unauthorised use of the phone and the SIM card.

PIN code request

You can set the phone to request the PIN code of your SIM card every time the phone is switched on. For this function you need the PIN code. See also [Access codes](#) on page 110.

Some SIM cards do not allow turning off the PIN code request.

Call barring service

With this network service you can restrict the making and receiving of calls with your phone. For this function you need the barring password that you obtain from your service provider.

1. Select one of the following call restrictions:

Outgoing calls: Calls cannot be made.

International calls: Calls cannot be made to foreign countries when in the home country.

International except to home country: When abroad, international calls cannot be made except for calls to the home country.

Incoming calls: Calls cannot be received.

Incoming calls when abroad: Calls cannot be received when abroad.

Cancel all barrings: Calls can be made and received with no restrictions. If you select this option, the following step will not be available.

2. Set the call restriction on (*Activate*) or off (*Cancel*), or check which types of calls are barred (*Status*).



Note: When calls are barred, calls may be possible to certain emergency numbers in some networks (e.g. 112 or other official emergency number).

Fixed dialling

You can restrict your outgoing calls to selected phone numbers, if allowed by your SIM card. For this function you need the PIN2 code (see [Access codes](#) on page 110).

When this function is on, you can only call phone numbers that are included in the fixed dialling list or that begin with the same digit(s) as a phone number on the list.

Within the *Numbers* function you can check the phone numbers (*Search*) and add new numbers to the list (*Add name*) as well as clear the list (*Erase all*).

Within the *Search* function you can edit, erase, or call the displayed phone number by first pressing  (*Options*) and then selecting the desired option.



Note: When fixed dialling is set on, calls may be possible to certain emergency numbers in some networks (e.g. 112 or other official emergency number).

Closed user group

With this network service you can specify a group of people whom you can call and who can call you.

Default resets the phone to use the group that the SIM card owner has agreed upon with the service provider.

To set this function on, you need to know the index number of the desired group. Contact your service provider.

When you have selected a closed user group, the  indicator and the index number of the given group are shown in standby mode.



Note: When calls are limited to closed user groups, calls may be possible to certain emergency numbers in some networks (e.g. 112 or other official emergency number).

Security level

You can set the phone to ask for the security code when a new SIM card is inserted in the phone (option *Phone*) or when you select the internal phone book (*Memory*).

("A new SIM card" means here a card that is not one of the five cards used most recently with the phone.)

For this function you need the security code (see [Access codes](#) on page 110).

Note that when you change this setting, all the recent calls lists in Menus 4-1 to 4-3 are cleared.

See also [Security code](#) on page 17, [Switching the phone on or off](#) on page 28, [Selecting the memory for names and phone numbers \(Memory in use\)](#) on page 51, and [Access codes](#) on page 110.

Change access codes

You can change the following access codes: security code, PIN code, PIN2 code, barring password. These codes can include the numbers 0 to 9 only.

The phone asks first for the current code and then for the new code twice.



Note: Avoid using access codes similar to the emergency numbers, such as 112, to prevent accidental dialling of the emergency number.

■ Restore factory settings (Menu 6-4)

You can reset the menu settings to their original values. For this you need the security code.



This function has no effect e.g. on the following functions:

- the names and phone numbers saved in the phone book
- text and picture messages
- phone numbers listed in the *Call register* menu
- call divert

11. Call divert (Menu 7)



Within the *Call divert* menu you can direct your incoming calls to your voice mailbox or some other phone number (network service).

To access this menu: In standby mode, press  (**Menu**), scroll to *Call divert*, and press  (**Select**).

■ Selecting a divert mode

1. Scroll to one of the following divert options and press  (**Select**):¹

Divert all voice calls without ringing

Divert when busy: The call is diverted when you have a call in progress or when you reject the call.

Divert if not answered: The call is diverted when you do not answer it.

Divert when phone off or no coverage: The call is diverted when your phone is switched off or outside of the network service area.

Divert when off, no answer, or no coverage: The call is diverted when you do not answer it, or your phone is busy, switched off, or outside of the network service area.

Cancel all divers: Sets all divert options off. If you select this option, the steps below will not be available.

2. Set the selected option on (*Activate*) or off (*Cancel*), check whether the divert option is activated (*Status*), or specify a delay for it (not available for all divert options).

1. The divert options that are not supported by your network operator may not be shown.

3. If you selected *Activate*, select where the incoming calls are to be diverted to (voice mailbox or another phone number).

If you selected *Status*, pressing  (**Number**) shows the phone number to which the calls are diverted.

Pressing  (**Detail**), if available, and then selecting *Delay* shows the time after which calls are diverted.

Several divert options may be active at the same time.

When all calls are diverted,  is shown in standby mode.

Each phone line may have its own divert settings. See also [Phone line in use](#) on page 77.





Tip: When you receive a call, pressing  diverts the call if *Divert when busy* is activated.

12. Games (Menu 8)

The phone offers you the following games to play: *Snake II*, *Space impact*, *Bantumi*, *Pairs II*, *Bumper*





To access this menu: In standby mode, press  (Menu), scroll to *Games*, and press  (Select).



Note: Your phone must be switched on to use this function. Do not switch on the phone when wireless phone use is prohibited or when it may cause interference or danger.



■ Adjusting the settings for all the games









1. In the *Games* menu, scroll to *Settings* and press  (Select).
2. Scroll to the desired setting and press  (Select).

You can set the sounds, lights, and vibrator (*Shakes*), and save the Club Nokia membership number. You need the membership number to use Club Nokia services, for example to send your high score. For more information on Club Nokia and the game services, visit www.club.nokia.com.

Note that when the *Vibrating alert* function is set off, the phone does not vibrate even if the *Shakes* function is on.

■ Playing a game

1. In the *Games* menu, scroll to *Select game* and press  (Select).
2. Scroll to the game that you want to play, and press  (Select).

3. Scroll to one of the following options and press  (**Select**). All the options may not be available for the selected game.
- **New game**: Starts a new game session.
 - **High scores**: Shows the highest scores so far. To send your score to the scoreboard on Club Nokia's Web site, scroll to the desired score and press  (**Submit**). The score is sent to Club Nokia via WAP connection.
 - **Instructions**: Shows a help text on how to play the game. You can scroll through the text with  or .
 - **Continue**: Resumes a game that you paused by pressing  or . Start the game by pressing any key except for , , or .
 - **Options**: You can adjust the settings (e.g. difficulty level) of the selected game.

■ Making a connection to the WAP service of Club Nokia

In the *Games* menu, scroll to *Game services* and press  (**Select**).

Your phone tries to connect to the WAP pages of Club Nokia by using the currently active set of connection settings.

If the connection fails and an error message (such as *Check service settings*) is displayed, you may not be able to access Club Nokia from the WAP service whose connection settings are currently active. In this case, enter the Services menu, activate some other set of connection settings (see [Making a connection to a WAP service](#) on page 102) and try to connect to Club Nokia again by using this *Game services* function.

For the availability of different WAP services, pricing and tariffs, contact your network operator and/or the WAP service provider.

13. Calculator (Menu 9)

The phone is provided with a basic four function calculator which can also be used for rough currency conversions.



The calculator has a limited accuracy and rounding errors may occur, especially in long divisions.









To access this menu: In standby mode, press  (**Menu**), scroll to *Calculator*, and press  (**Select**).









Note: Your phone must be switched on to use this function. Do not switch on the phone when wireless phone use is prohibited or when it may cause interference or danger.

■ Making a calculation

You can use the following keys for keying in a calculation:





-  - : Inserts a digit. To change the sign, press  (**Options**) and select *Change sign*.
- : Inserts a decimal point.
- : Deletes the digit to the left.
- : Press once (for +) to add, twice (for -) to subtract, three times (for *) to multiply and four times (for /) to divide. Alternatively, you can press  (**Options**) and select the desired function.
- For a total, press  (**Options**) and select *Equals*. Press and hold  to clear the display for a new calculation.

■ Making a currency conversion

- To set the exchange rate:
 - Press  (**Options**) and select *Exchange rate*.
 - Select either of the displayed exchange options and press  (**OK**).
For example, if you live in the UK and want to convert pounds sterling to French francs, select *Domestic unit expressed in foreign units*.
 - Key in the exchange rate and press  (**OK**).  inserts a decimal point.
- To make the conversion:
 - Key in the currency amount to be converted.
 - Press  (**Options**).
 - Scroll to *In domestic* or *In foreign*, and press  (**OK**). In the example above, you would select *In foreign* since you want to convert your domestic currency (pounds sterling) to a foreign currency (francs).

■ Currency conversion in standby mode

You can make currency conversions in standby mode. To use this function you need to first set the exchange rate in the Calculator menu.



- Key in the amount that you want to convert to the domestic or foreign currency. Press  for a decimal point (an asterisk appears).
- Press  or  twice. The text above  changes from **Call** to **Convert** and the asterisk changes to a decimal point.
- Press  (**Convert**).

You can return to standby mode by pressing  (**OK**).

14. Reminders (Menu 10)







With this memory aid you can save short text notes with an alarm. The phone starts alarming when the set date and time is reached.

To access this menu: In standby mode, press  (**Menu**), scroll to *Reminders*, and press  (**Select**).





Note: Your phone must be switched on to use this function. Do not switch on the phone when wireless phone use is prohibited or when it may cause interference or danger.





■ Adding a reminder

1. Scroll to *Add new* and press  (**Select**).
2. Write a note (see [Writing text](#) on page 39).
3. When the note is ready, press  (**OK**) for the options below. Scroll to the desired option and press  (**OK**).
 - *Alarm on*: Sets an alarm for the note. Key in the date and press  (**OK**), and then key in the time and press  (**OK**).
 - *Alarm off*: No alarm is set for the note.



■ Viewing the reminders

1. Scroll to *View all* and press  (**Select**).
2. Scroll to the desired note. You can press  (**Options**) for the following:
 - *Erase*: Deletes the note.
 - *Edit*: You can modify the note and the alarm date and time.
 - *Send*: You can send the note without alarm as a text message (SMS) to a compatible phone.

■ Erasing a reminder

1. Scroll to *Erase* and press  (**Select**).
2. Scroll to one of the following options and press  (**OK**):
 - *One by one*: Deletes the reminders one at a time. Select the reminder that you want to delete, and press  (**Erase**).
 - *All*: Deletes all the reminders. Press  (**Yes**) to confirm the removal.

■ When the reminder time is reached

If the phone is switched on, it sounds an alarm and flashes its lights and the reminder text. You can stop the alarm by pressing . If you press  (**Snooze**), the alarm stops for a few minutes.

If the phone is switched off, the reminder is displayed when you switch on the phone again.

15. Clock (Menu 11)



The phone is provided with a clock which can also be used as an alarm clock.

This menu also contains time settings, a stopwatch and a countdown timer.

To access this menu: In standby mode, press (Menu), scroll to *Clock*, and press (Select).

■ Alarm clock (Menu 11-1)

The phone can be set to alarm at the desired time.

If the alarm was off when you entered this function, key in the desired alarm time in hours and minutes, and press (OK).

If the alarm was on when you entered this function, select *On* to change the alarm time or *Off* to turn off the alarm.

When the alarm time is reached

The phone sounds an alert tone at the volume selected within the *Ringing volume* function (see page 71), and flashes its lights and the text *Alarm!*. You can stop the alarm by pressing any key.

If you let the phone alarm for one minute or press (Snooze), the alarm stops for a few minutes and then resumes.

If the alarm time is reached while the phone is switched off, the phone starts alarming. If you press any other key but (Snooze), the phone asks whether you want to activate the phone for calls. Press (Yes) to switch on the phone or to keep the phone switched off.



Note: Do not switch on the phone when wireless phone use is prohibited or when it may cause interference or danger.

■ Clock settings (Menu 11-2)

You can set the time display on or off, adjust the time, or select the 12-hour or 24-hour time format. When the time display is on, the time is shown in standby mode.

If the battery is removed from the phone, you may need to reset the time.

■ Date setting (Menu 11-3)

You can set the correct date for the built-in clock.

■ Stopwatch (Menu 11-4)





The stopwatch can be used for time measurement, for example in different sports.

The precision of the stopwatch is one hundredth of a second. The total measurement time is 10 hours at maximum.

Note that using the stopwatch consumes the battery and the phone's operating time will be reduced. Be careful not to let it run in the background when performing other operations with your phone.





Note: Your phone must be switched on to use this function. Do not switch on the phone when wireless phone use is prohibited or when it may cause interference or danger.

1. In this menu, press  (**Start**) to start timing.
2. To take the time, press  (**Stop**). When the timing is stopped, you can press  (**Options**) for the following functions. Scroll to the desired function and press  (**Select**).

Start: Restarts the timing from the previous stop time.

Reset: Stops the current timing and sets the time to zero.

Exit: Exits to standby mode. To continue the timing, enter this menu.

To set the timing to continue in the background, press  twice. While the time is running,  flashes in standby mode.

■ Countdown timer (Menu 11-5)

With the countdown timer you can set the phone to alarm after a certain time.



Note: Your phone must be switched on to use this function. Do not switch on the phone when wireless phone use is prohibited or when it may cause interference or danger.

To set the alarm time, key in the time in hours and minutes. Press  (**Start**) to start the timer.

To stop the timer or edit the time, enter this menu, select the desired function, and press  (**OK**).

When the timer is running,  is shown in standby mode.

If the alarm time is reached when the phone is in standby mode, the phone sounds a tone and flashes the related text. You can stop the alarm by pressing any key. If no key is pressed in 30 seconds, the alarm stops automatically.

■ Auto update of date and time (Menu 11-6)

This network service updates the clock in your phone in accordance with the current time zone.

If you select *On*, the time and date are updated automatically.

If you select *Confirm first*, the phone asks for a confirmation before the update.

If you select *Off*, the time and date are not updated.

16. Profiles (Menu 12)

You can set the phone tones and screen saver to function in the desired manner by selecting the desired setting group or 'profile'.



This makes it easy to adjust the phone for different events and environments.

To access this menu: In standby mode, press (Menu), scroll to *Profiles*, and press (Select).

Note that you can easily adjust the settings of the selected profile in the Tones menu (see page 71).

■ Selecting a profile for use

To change the profile that your phone is using, do either of the following:





- In standby mode or during a call: Press the key quickly. Scroll to the desired profile and press (OK).
- In the *Profiles* menu, scroll to the desired profile, press (Select), scroll to *Activate*, and press (OK).



Tip: To activate a profile quickly in standby mode, press and the number key corresponding to the desired profile. For example, to activate the *Silent* profile, press and . To change back to the *General* profile, press and .

■ Changing the settings of a profile

1. In the *Profiles* menu, scroll to the profile whose settings you want to edit and press (Select).
You can select from the following profiles:

- **General:** This is the default setting.
 - **Silent:** Mutes all the phone tones. When the tones are off,  is shown in standby mode.
 - **Discreet:** Sets the phone tones to be quiet.
 - **Loud:** Sets the phone tones to be loud.
 - **(empty):** You can replace this profile with a profile that you have received e.g. from your service provider. For availability and other information, contact your service provider or other profile provider.
2. Scroll to **Personalise** and press  (**OK**).
 3. Scroll to the desired setting (see below) and press  (**Select**).
 4. Scroll to the setting option and press  (**OK**).

■ Settings available in a profile

Ringing tone

Sets the ringing tone for voice calls. Scroll to the desired tone and press  (**OK**). The tones that you have received from somebody or that you have composed yourself can be found at the end of the tone list.

Ringing volume

Sets the volume level for the ringing and message alert tones. Scroll to the desired level and press  (**OK**).

Incoming call alert

Defines how the phone notifies you of incoming voice calls. The options are: *Ring*, *Ascending*, *Ring once*, *Beep Once*, and *Off*.

When *Off* is selected, all phone tones are mute and  is displayed.

Message alert tone

Sets the call alert for text messages. Scroll to the desired tone and press  (OK).

Keypad tones

Sets the volume level for keypad tones. Scroll to the desired level and press  (OK).

Warning tones

Sets the phone to sound a warning tone, for example when the battery is running out of power. This setting has no effect on the tones that are related to network services.

Vibrating alert



Sets the phone to vibrate when you receive a voice call or a text message. You can also set the phone to first vibrate and then ring.

The vibrating alert is disabled when the phone is connected to a charger or a desktop stand.

Screen saver

Sets the picture that is displayed in standby mode after a selected period of time (called 'timeout'). You can select from the same pictures as in the *Picture messages* menu.

Scroll to *Off*, *On* (previously selected screen saver is shown), *Timeout*, or *Screen saver*, and press  (OK).

If you selected *Screen saver*, the currently selected screen saver picture is shown. To change it, scroll to the desired picture, and press  (Use). If you selected *Timeout*, scroll to the desired time and press  (OK).

The use of an animated picture as a screensaver uses power so it reduces the operation time of your phone.



Rename

You can change the name of the profile. This function is not available for the *General* profile.

Key in the new name (see [Writing text](#) on page 39) and press  (OK).

■ Receiving a profile (profile name, ringing tone, and screen saver)

When you receive a profile sent, for example, from a Web site, you hear a message tone and the related text is displayed. For availability and other information, contact your service provider or other profile provider.

1. Press  (Options) and select *Details* (to view the profile details), *Save* (to add the profile to the profile list), or *Discard* (to erase the profile).
2. If you selected *Details*, scroll to the desired setting (profile name, ringing tone or screen saver) and press  to view or hear it.

If you selected *Save*, scroll to the profile that you want to replace with the new one, and press  (OK).

17. WAP services (Services – Menu 13)

In this menu you can access various WAP (Wireless Application Protocol) services such as banking, online games, and entertainment. These services are specifically designed for mobile phones and they are maintained by WAP service providers.



To access this menu: In standby mode, press  (Menu), scroll to *Services*, and press  (Select).



Note: Your phone must be switched on to use this function. Do not switch on the phone when the use of a wireless phone is prohibited or when it may cause interference or danger.

Check the availability of WAP services, pricing and tariffs with your network operator and/or the WAP service provider whose service you want to use. Service providers will also give you instructions on how to use their services.

Note that WAP services use Wireless Mark-up Language (WML) on their WAP pages. Web pages using the Hyper-Text Mark-up Language (HTML) cannot be viewed on your phone.

■ Basic steps for accessing and using a WAP service

1. Obtain the connection settings that are needed to access a WAP service that you want to use.

See [Setting up the phone for a WAP service](#).

2. Save the connection settings.

See [Setting up the phone for a WAP service](#). See also [Adjusting the appearance settings of WAP pages](#) on page 105.

3. Make a call, i.e. connection, to the given WAP service. See [Making a connection to a WAP service](#) on page 102.
4. Start browsing the pages of the WAP service. See [Browsing the pages of a WAP service](#) on page 103.
5. Once you are done with browsing, end the connection to the WAP service. See [Ending a WAP connection](#) on page 105.







■ Setting up the phone for a WAP service

You may obtain the connection settings as a text message from the network operator or service provider that offers the WAP service that you want to use. For more information, contact your network operator or service provider, or visit Club Nokia's Web site (www.club.nokia.com).

If this is not the case, you can key in the settings manually. For appropriate settings, contact your network operator or service provider. The WAP settings may be available for example on the Web site of the network operator or service provider.



Saving the settings received as a text message

When you receive the connection settings as a text message, *Service settings received* is displayed.







- To save the received settings: Press  (**Options**), scroll to *Save*, and press  (**Select**).
- If you want to view the settings before saving them: Press  (**Options**), scroll to *View*, and press  (**Select**).
Press  (**Save**) to save the settings or  to return to the option list.

Keying in the connection settings manually





For appropriate settings, contact your network operator or service provider.











1. In the *Services* menu, scroll to *Settings* and press  (**Select**).
2. Press  (**Select**) when *Connection settings* is displayed.
3. Scroll to a set of connection settings and press  (**Options**).

A set is a collection of settings needed for making a connection to a WAP service.

4. Scroll to *Edit* and press  (**Select**).
5. Scroll to each of the settings below and press  (**Select**). Make all the required settings one by one.
 - *Homepage*: Key in the homepage address of the WAP service that you want to use (press  for a period), and press  (**OK**).
 - *Connection type*: Scroll to *Continuous* or *Temporary*, and press  (**Select**).
 - *Connection security*: Scroll to *On* or *Off*, and press  (**Select**).

When the connection security is on, the phone tries to use a secure connection with the WAP service. If a secure connection is not available, the connection will not be made. If you wish to connect anyway, with a non-secure connection, set the connection security to *Off*.

- *Bearer*: Scroll to *USSD* or *Data*, and press  (**Select**). For pricing, connection speed and other information, contact your network operator or service provider.
- *Service code* (shown if the bearer is USSD): Key in the code and press  (**OK**).
- *Service number* (shown if the bearer is USSD): Key in the service number and press  (**OK**).
- *Dial-up number* (shown if the bearer is Data): Key in the number and press  (**OK**).

- *IP address* (shown if the bearer is data): Key in the address (press  for a period) and press  (OK).
 - *Authentication type* (shown if the bearer is Data): Scroll to *Secure* or *Normal*, and press  (Select).
 - *Data call type* (shown if the bearer is Data): Scroll to *Analogue* or *ISDN*, and press  (Select).
 - *User name* (shown if the bearer is Data): Key in the user name (press  for a period) and press  (OK).
 - *Password* (shown if the bearer is Data): Key in the password and press  (OK).
6. After you have made all the required settings, you can change the name of the setting set. Press  and then  (Options), scroll to *Rename*, and press  (Select). Key in the name and press  (OK).



The settings are now saved and you can make a connection to the WAP service. See [Making a connection to a WAP service](#).

■ Making a connection to a WAP service

First, activate the settings of the WAP service that you want to use.





If you want to use the same WAP service (that you accessed using the *Home* option in the *Services* menu) as the last time, you do not need to activate its settings again.

To activate the settings:



1. In the *Services* menu, scroll to *Settings* and press  (Select).
2. Scroll to *Connection settings* and press  (Select).
3. Scroll to the appropriate setting set and press  (Options).

4. Scroll to *Activate* and press  (**Select**).

Next, make a connection to the WAP service. Do one of the following:

- Open the homepage of the WAP service: In the *Services* menu, scroll to *Home* and press  (**Select**). OR
- Select a bookmark of the WAP service: In the *Services* menu, scroll to *Bookmarks* and press  (**Select**). Scroll to the desired bookmark and press  (**Options**). Scroll to *Go to* and press  (**Select**).

Make sure that the currently active set of connection settings can be used with the WAP page to which the bookmark refers. If the bookmark does not work (in this case *Check service settings* may be displayed), change the set of connection settings and try again. OR

- Enter the address of the WAP service: In the *Services* menu, scroll to *Go to address* and press  (**Select**). Key in the address (press  for special characters) of the WAP service and press  (**OK**).











Note that it is not necessary to add the prefix `http://` in front of the address since it will be added automatically. If you are using a protocol other than `http`, add the appropriate prefix.

■ Browsing the pages of a WAP service

Once you have made a connection to the WAP service, you can start browsing its WAP pages.

The function of the phone keys may vary in different WAP services. Follow the guiding texts on the display. For more information, contact your WAP service provider.

General guidelines for using the keys

- Use  or  to browse the WAP page and highlight the desired item. The item can be, for example, underlined text, i.e. a 'link'.
- Press  or  to select a highlighted item.
- Press  to go back to the WAP page that you viewed previously.
- Press and hold  to disconnect from the WAP service and to end the call.
- Press  to enter letters and numbers and  to enter special characters.
- Press  (**Options**) for the following options, for example. Scroll to the desired option and press  (**Select**).

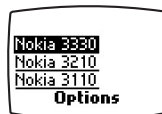

Home: Takes you back to the homepage of the WAP service.



Reload: Refreshes the WAP page.

Select: Selects a link or any other highlighted item on the WAP page.

Appear. sett.: You can wrap the text lines and hide the images on the WAP page. For details, see [Adjusting the appearance settings of WAP pages](#) on page 105.

Bookmarks: You can manage bookmarks, e.g. save the current WAP page as a bookmark. For details, see [Saving and managing bookmarks](#) on page 106.







Use number: Copies a number from the current WAP page for saving or calling, and ends the call. If the WAP page contains several numbers, you can select the desired one.

Go to address: You can make a connection to the desired WAP page. Key in the WAP address (press  for a period) and press  (**OK**).

Clear cache: Empties the cache memory of the phone (see [Emptying the cache memory](#) on page 107).

Security info: Shows whether the connection is secure.

Exit: Quits browsing and ends the call.



View picture: You can scroll a picture or animated picture which cannot be entirely shown on the display.  and  (or  and ) scroll the picture up or down.  and  scroll the picture left or right.

Press  (**Options**) for the following: *Next picture*, *Prev. picture* or *Save picture*.

With the *Save picture* option you can save pictures for using them in picture messages or as screensavers, and animated pictures for using them as screensavers. If the picture to be saved is too large for picture messages and screensavers, move the box shown over the picture to select the area that you want to save, and press  (**Select**).



Note that an animated picture saved from a WAP page cannot be used in picture messages.

■ Ending a WAP connection

When you are using a WAP service: Press  (**Options**), scroll to *Exit*, and press  (**Select**). When the text *Quit browsing?* is shown, press  (**Yes**).

The phone terminates the connection to the WAP service and ends the call.

■ Adjusting the appearance settings of WAP pages

1. In the *Services* menu, scroll to *Settings* and press  (**Select**).
2. Scroll to *Appearance settings* and press  (**Select**).
3. Scroll to *Text wrapping* or *Show images*, and press  (**Select**).

4. Select *On* or *Off* for *Text wrapping* and *Yes* or *No* for *Show images*.

When *Text wrapping* is set to *On*, the text continues on the next line if it cannot be shown on one line.

When *Show images* is set to *No*, any pictures appearing on the WAP page are not shown. This may speed up the browsing of WAP pages that contain a lot of pictures.

■ Saving and managing bookmarks



When no WAP connection is in progress

1. In the *Services* menu, scroll to *Bookmarks* and press  (**Select**).





2. Scroll to the desired bookmark and press  (**Options**).

If you want to save a new bookmark, select any bookmark.

3. Scroll to one of the following options and press  (**Select**).

- **Add bookmark:** You can create a new bookmark without connection to a WAP service. Key in the address of the WAP page and press  (**OK**). Write a name for the WAP page and press  (**OK**).
- **Go to:** Makes a connection to the WAP page associated with the bookmark.
- **Edit:** You can modify the selected bookmark.
- **Erase:** You can delete the selected bookmark.
- **Send bookmark.:** You can send the selected bookmark as a text message to another phone.

When a WAP connection is in progress

1. Press  (**Options**), scroll to *Bookmarks*, and press  (**Select**).
2. Scroll to the desired bookmark and press  (**Options**).
If you want to save a new bookmark, select any bookmark.
3. Scroll to one of the options described above and press  (**Select**).

With the *Save bookmark* function you can save the current WAP page as a bookmark.

■ Emptying the cache memory

The information or services that you have accessed are temporarily saved in the cache memory of the phone.

If you have tried to access or have accessed confidential information requiring passwords (for example, your bank account), empty the cache memory of your phone after each use.

To empty the cache memory:

- In the *Services* menu, scroll to *Clear cache* and press  (**Select**).

■ Security certificates



For using some WAP services such as banking services, you need a security certificate. Using the certificate can help you to improve the security of connections between your phone and a WAP gateway or WAP server, if the *Connection security* option is set to *On*.

You can download the certificate from a WAP page if the WAP service supports the use of security certificates. After the download, you can view the certificate and then save or delete it. If you save the certificate, it is added to the list of certificates in the phone.

You can only be sure that a WAP gateway or WAP server is the one it claims to be after its identity has been checked against the corresponding certificate in the phone.

You will see a note on the phone display if the identity of the WAP server or WAP gateway cannot be verified, the WAP server or WAP gateway certificate is not authentic or if you do not have the right certificate in your phone.

To view the list of security certificates:

1. In the *Services* menu, scroll to *Settings* and press  (**Select**).
2. Scroll to *Security certificates* and press  (**Select**).

Security icon



If the security icon () is displayed during a WAP connection, the data transmission between the phone and the WAP gateway or WAP server (identified by the *IP address* setting in the *Connection settings*) is encrypted and secure.

However, the security icon does not indicate that the data transmission between the gateway and the content server (place where the requested resource is stored) is secure. It is up to the service provider to secure the data transmission between the gateway and the content server.

18. SIM services (Menu 14)

In addition to the functions available in the phone, your SIM card may provide additional services that you can access in this menu.



To access this menu: In standby mode, press  (Menu), scroll to Menu 14, and press  (Select).

This menu is shown only if it is supported by your SIM card. The name and contents of this menu depend on the services available.

You can set the phone to display confirmation messages when you are using the SIM card services. See [Confirm SIM service actions](#) on page 79.

For availability, rates and information on using the SIM services, contact your SIM card vendor, e.g. network operator, service provider, or other third-party vendor.

Accessing these services may involve sending a text message (SMS) or making a phone call for which you may be charged.



Note: Your phone must be switched on to use this function. Do not switch on the phone when wireless phone use is prohibited or when it may cause interference or danger.

19. Reference information

■ Sending DTMF tones

The phone can send DTMF tones to communicate with answering machines, computerised telephony services etc.

Make a call in the normal way. Press  and  (**Options**), and select *Send DTMF*. Key in the DTMF string or recall it from the phone book, and press  (**OK**).

■ Access codes

You can use the access codes described in this section to avoid unauthorised use of your phone and SIM card.

The access codes (except the PUK and PUK2 code) can be changed within the [Change access codes](#) function (see page 62).

Security code

The security code can be used to avoid unauthorised use of your phone (see [Security level](#) on page 82).



The default setting for this code is 12345. Change the code (see [Change access codes](#) on page 82) and set the phone to request it (see [Security level](#) on page 82).

Keep the code secret and in a safe place, separate from the phone.

PIN code

The PIN (Personal Identification Number) code protects your SIM card against unauthorised use. The PIN code is usually supplied with the SIM card.

When the PIN code request is enabled, the code is requested each time the phone is switched on (see [PIN code request](#) on page 80).

If you enter an incorrect PIN code three times in succession, the SIM card is blocked. Key in the PUK code and press  (OK). Key in a new PIN code and press  (OK). Key in the new code again and press  (OK).

PIN2 code

The PIN2 code, supplied with some SIM cards, is required to access some functions, such as charging unit counters. These functions are only available if supported by your SIM card.

If you enter an incorrect PIN2 code three times in succession, follow the same instructions as for the PIN code but use the PUK2 code instead.

PUK code

The PUK (Personal Unblocking Key) code is required to change a blocked PIN code. The PUK code may be supplied with the SIM card. If not, contact your local service provider for the code. If you lose the code, contact your service provider.

PUK2 code

The PUK2 code, supplied with some SIM cards, is required to change a blocked PIN2 code. If you lose the code, contact your service provider.

Barring password

The barring password is needed when using the *Call barring service* function (see page 80). You obtain this password from your service provider.

Battery information

Your phone is powered by a rechargeable battery.

The operation and lifetime of the battery are greatly affected by how you handle it. Take good care of the battery and follow the guidelines presented below.

Charging and discharging the battery

- A new battery's full performance is achieved only after two or three complete charge and discharge cycles!
- The battery can be charged and discharged hundreds of times but it will eventually wear out. When the operating time (talk-time and standby time) is noticeably shorter than normal, it is time to buy a new battery.
- Use only batteries approved by the phone manufacturer and recharge your battery only with the chargers approved by the manufacturer.
- When a charger is not in use, disconnect it from the power source. Do not leave the battery connected to a charger for longer than a week, since overcharging may shorten its life. If left unused a fully charged battery will discharge itself over time.
- For good operation times, discharge the NiMH battery from time to time by leaving your phone switched on until it turns itself off. Do not attempt to discharge the battery by any other means.

- Temperature extremes will affect the ability of your battery to charge: allow it to cool down or warm up first.
- When the battery is running out of power and only few minutes of talk time remain, a warning tone is heard and *Battery low* is briefly displayed. When no more talk time is left, *Battery empty* is displayed and a warning tone is sounded and the phone switches itself off.

Using the batteries

- Use the battery only for its intended purpose.
- Never use any charger or battery that is damaged or worn out.
- Do not short-circuit the battery. Accidental short-circuiting can occur when a metallic object (coin, clip or pen) causes direct connection of the + and - terminals of the battery (metal strips on the back of the battery) for example when you carry a spare battery in your pocket or purse. Short-circuiting the terminals may damage the battery or the connecting object.
- Leaving the battery in hot or cold places, such as in a closed car in summer or winter conditions, will reduce the capacity and lifetime of the battery. Always try to keep the battery between 15°C and 25°C (59°F and 77°F). A phone with a hot or cold battery may temporarily not work, even when the battery is fully charged. Battery performance is particularly limited in temperatures below freezing point.

NiMH batteries performance is particularly limited in temperatures below -10°C (14°F). Li-Ion batteries performance is particularly limited in temperatures below -0°C. (32°F).

- Do not dispose of batteries in a fire!



Batteries must be recycled or disposed of properly. They must not be disposed of in municipal waste!

Care and maintenance

Your phone is a product of superior design and craftsmanship and should be treated with care. The suggestions below will help you to fulfill any warranty obligations and to enjoy this product for many years. When using your phone, battery, charger OR any accessory:

- Keep it and all its parts and accessories out of small children's reach.
- Keep it dry. Precipitation, humidity and liquids contain minerals that will corrode electronic circuits.
- Do not use or store it in dusty, dirty areas. Its moving parts can be damaged.
- Do not store it in hot areas. High temperatures can shorten the life of electronic devices, damage batteries, and warp or melt certain plastics.
- Do not store it in cold areas. When the phone warms up (to its normal temperature), moisture can form inside the phone, which may damage electronic circuit boards.
- Do not attempt to open it. Non-expert handling of the device may damage it.
- Do not drop, knock or shake it. Rough handling can break internal circuit boards.
- Do not use harsh chemicals, cleaning solvents, or strong detergents to clean it. Wipe it with a soft cloth slightly dampened in a mild soap-and-water solution.
- Do not paint it. Paint can clog the device's moving parts and prevent proper operation.
- If the phone, battery, charger or any accessory are not working properly, take it to your nearest qualified service facility. The personnel there will assist you, and if necessary, arrange for service.

Important safety information

■ Traffic safety

Do not use a hand-held telephone while driving a vehicle. If using a hand-held phone park the vehicle before conversing. Always secure the phone in its holder; do not place the phone on the passenger seat or where it can break loose in a collision or sudden stop.

The use of an alert device to operate a vehicle's lights or horn on public roads is not permitted.

Remember road safety always comes first!

■ Operating environment

Remember to follow any special regulations in force in any area and always switch off your phone whenever it is forbidden to use it, or when it may cause interference or danger.

When connecting the phone or any accessory to another device, read its user guide for detailed safety instructions. Do not connect incompatible products.

As with other mobile radio transmitting equipment, users are advised that for the satisfactory operation of the equipment and for the safety of personnel, it is recommended that the equipment should only be used in the normal operating position (held to your ear).

■ Electronic devices

Most modern electronic equipment is shielded from radio frequency (RF) signals. However, certain electronic equipment may not be shielded against the RF signals from your wireless phone.

Pacemakers

Pacemaker manufacturers recommend that a minimum separation of 20 cm (6 inches) be maintained between a hand-held wireless phone and a pacemaker to avoid potential interference with the pacemaker. These recom-

recommendations are consistent with the independent research by and recommendations of Wireless Technology Research.

Persons with pacemakers:

- Should always keep the phone more than 20 cm (6 inches) from their pacemaker when the phone is switched on;
- Should not carry the phone in a breast pocket;
- Should use the ear opposite the pacemaker to minimize the potential for interference.
- If you have any reason to suspect that interference is taking place, switch off your phone immediately.

Hearing aids

Some digital wireless phones may interfere with some hearing aids. In the event of such interference, you may want to consult your service provider.

Other medical devices

Operation of any radio transmitting equipment, including cellular phones, may interfere with the functionality of inadequately protected medical devices. Consult a physician or the manufacturer of the medical device to determine if they are adequately shielded from external RF energy or if you have any questions.

Switch off your phone in health care facilities when any regulations posted in these areas instruct you to do so. Hospitals or health care facilities may be using equipment that could be sensitive to external RF energy.

Vehicles

RF signals may affect improperly installed or inadequately shielded electronic systems in motor vehicles (e.g. electronic fuel injection systems, electronic anti-skid (anti-lock) braking systems, electronic speed control systems, air bag systems).

Check with the manufacturer or its representative regarding your vehicle. You should also consult the manufacturer of any equipment that has been added to your vehicle.

Posted facilities

Switch your phone off in any facility where posted notices so require.

■ Potentially explosive atmospheres

Switch off your phone when in any area with a potentially explosive atmosphere and obey all signs and instructions. Sparks in such areas could cause an explosion or fire resulting in bodily injury or even death.

Users are advised to switch off the phone when at a refuelling point (service station). Users are reminded of the need to observe restrictions on the use of radio equipment in fuel depots (fuel storage and distribution areas), chemical plants or where blasting operations are in progress.

Areas with a potentially explosive atmosphere are often but not always clearly marked. They include below deck on boats; chemical transfer or storage facilities; vehicles using liquified petroleum gas (such as propane or butane); areas where the air contains chemicals or particles, such as grain, dust or metal powders; and any other area where you would normally be advised to turn off your vehicle engine.

■ Vehicles

Only qualified personnel should service the phone, or install the phone in a vehicle. Faulty installation or service may be dangerous and may invalidate any warranty which may apply to the unit.

Check regularly that all wireless phone equipment in your vehicle is mounted and operating properly.

Do not store or carry flammable liquids, gases or explosive materials in the same compartment as the phone, its parts or accessories.

For vehicles equipped with an air bag, remember that an air bag inflates with great force. Do not place objects, including both installed or portable wireless equipment in the area over the air bag or in the air bag deployment area. If in-vehicle wireless equipment is improperly installed and the air bag inflates, serious injury could result.

Switch off your phone before boarding an aircraft. The use of wireless telephones in an aircraft may be dangerous to the operation of the aircraft, disrupt the wireless telephone network and may be illegal.

Failure to observe these instructions may lead to suspension or denial of telephone services to the offender, or legal action or both.



■ Emergency calls



Important! This phone, like any wireless phone, operates using radio signals, wireless and landline networks as well as user-programmed functions which cannot guarantee connection in all conditions. Therefore, you should never rely solely upon any wireless phone for essential communications (e.g. medical emergencies).

Remember, to make or receive any calls the phone must be switched on and in a service area with adequate cellular signal strength. Emergency calls may not be possible on all wireless phone networks or when certain network services and/or phone features are in use. Check with local cellular service providers.

To make an emergency call:

1. If the phone is not on, switch it on.
Some networks may require that a valid SIM card is properly inserted in the phone.
2. Press and hold the  key twice for several seconds to ready the phone for calls.
3. Key in the emergency number for your present location (e.g. 112 or other official emergency number).
Emergency numbers vary by location.
4. Press the  (Call) key.

If certain features are in use (Keypad lock, Fixed Dialling, etc.), you may first need to turn those features off before you can make an emergency call. Consult this document and your local cellular service provider.

When making an emergency call, remember to give all the necessary information as accurately as possible.

Remember that your wireless phone may be the only means of communication at the scene of an accident - do not cut off the call until given permission to do so.

A

access codes

- changing 82

- See also PIN code, PIN2 code, PUK code, PUK2 code, security code

accessories

- handsfree car kit (PPH-1) 31, 78

- headset (HDC-5) 54, 78

alarm clock 92

- display indicator 22

answering a call 35

- automatic answer 78

- during a call 36

automatic answer 78

automatic redial 76

automatic update of date and time 94

automatically saved phone numbers. See call register, dialled calls, received calls, missed calls.

B

barring a call 80

batteries

- charge indicator 21

- charging 27, 112

- discharging 112

- removing 25, 29

- replacing 26

- using 112, 113

browsing through menus and settings 20

business card. See sending a name and phone number to another phone

C

calculator 88

call alert types 71, 97

call barring 80

- password 112

call cost settings 69

call costs 69

- limiting 69

- selecting units 70

- call divert 35, 84
 - display indicator 22, 85
- call duration 68
- call register 67
- call restriction. See call barring
- call waiting 77
- calls
 - answering 35
 - answering a call during a call 36
 - barring 80
 - cancelling 31
 - diverting 35, 84
 - emergency calls 118
 - ending 31
 - international calls 31
 - making 31
 - making a call using Phone book 32, 49
 - making a new call during a call 34
 - receiving 35
 - rejecting 35
 - service numbers 49
 - speed dialling 33, 76
 - switching between two calls 34, 36
 - voice dialling 53
- cancelling a call 31
- care and maintenance 114
- cell info display 78
- changing the covers 29
- charge indicator 21
- charging a battery 27, 112
- chat 58, 65
- clear/exit key 20
 - clearing the display 43
 - deleting a letter 43
 - exiting a menu function 45
 - rejecting a call 35
 - removing a number from the screen 39
- clearing the display 20, 43
- clock
 - selecting time format 93
 - setting on or off 93
 - update in accordance with time zone 94
- closed user groups 81
 - display indicator 22
- composing a ringing tone 72
- converting currencies 89
 - in standby mode 89
- copying a name and phone number 50
- countdown timer 94
 - display indicator 23

covers, changing 29
currencies, converting 89
cursor, moving 20

D

date setting 93
default settings, restoring 83
deleting
 automatically saved phone numbers 68
 character 20
 number from the screen 39
 text messages 58
dialled phone numbers 20
discharging a battery 112
display indicators 21
 alarm clock 22
 call divert 22
 closed user groups 22
 countdown timer 23
 keypad lock 22
 letter case 40, 43
 number mode 43
 phone line 2 in use 22
 predictive text input 40
 read text messages 58

 received text messages 22
 silent mode 22
 stopwatch 22
 traditional text input 42
display, clearing 20
diverting a call 35
diverting calls 35, 84
DTMF tones
 sending 110

E

earpiece volume 20, 32
editing a name and phone number saved in
 Phone book 50
emergency calls 16, 118
ending a call 31
exiting from menu functions 20

F

factory settings 83
fixed dialling 81

G

game tones 71, 86
games 86

H

- handsfree car kit (PPH-1) 78
- handsfree use 31
- headset (HDC-5) 37, 78
 - using for voice dialling 54

I

- idle mode. *See* standby mode
- inbox 58
- information service 63
- international calls 31
 - saving international prefix 39

K

- keying in letters 19, 38
 - using predictive text input 39, 40
 - using traditional text input 39, 42
- keying in numbers 19
- keypad
 - lock 22, 37
 - overview 19
 - tones 71, 74, 97

L

- language of display texts 78
- last dialled numbers 32, 68
 - See also* call register
- letter cases
 - switching between 40, 43
- letters
 - keying in 39
 - switching between cases 40, 43
- lights 79
 - turning on temporarily 19
- listening to voice messages 36
- locking the keypad 22, 37

M

- making a call 31
 - during a call 34
- MCN. *See* cell info display.
- memory functions. *See* Phone book
- memory, selecting 51
- menu functions
 - entering 44
 - exiting 45
 - list of 46

message alert tones 74, 97
message centre number 62
message formats 62
microphone, muting 32
missed calls 68

See also call register
moving a name and phone number 50
moving the cursor 20
muting the microphone 32

N

names and phone numbers
 saving 50
names and phone numbers saved in Phone book
 checking the storage space 52
 copying 50
 defining the type of view 52
 deleting 50
 editing 50
 making a call using 32
 moving 50
 saving 38
 selecting the memory 51
 sending to another phone 51
 viewing 20

network
 selecting 79
network services
 command editor 64
Nokia Navi key 20, 21
number keys 19
number mode, display indicator 43
numbers, deleting a number from the screen 39

O

operating environment 115
outbox 59

P

Phone book
 checking the amount of free space 52
 copying a name and phone number 50
 defining the type of view for Phone book
 contents 52
 deleting a name and phone number from
 Phone book 50
 editing a name and phone number 50
 entering 49
 during a call 49
 making a call using 32, 49

- moving a name and phone number 50
 - recalling names and phone numbers 49
 - saving a name and phone number 38, 50
 - selecting the memory for names and phone numbers 51
 - sending a name and number to another phone 51
 - using 49
 - phone line
 - display indicator 22
 - selecting 77
 - phone settings 78
 - picture messages 59
 - PIN code 111
 - prompt 28
 - request 80
 - PIN2 code 111
 - power key 19
 - predictive text input 39, 40
 - display indicator 40
 - selecting a dictionary 42
 - turning off 42
 - prepaid SIM card 70
 - prepaid talk-time. *See* prepaid SIM card
 - profile graphics 71
 - profiles 95
 - activating 95
 - editing 95
 - renaming 98
 - selecting in standby mode or in menu 19
 - settings 71, 96
 - turning on 95
 - PUK code 111
 - PUK2 code 111
 - punctuation marks 43
- ## Q
- quick find 33, 36, 39
 - quick guide 3
- ## R
- reading text messages 58
 - recalling names and phone numbers from Phone book 20, 49
 - quick find 33, 36, 39
 - received calls 68
 - See also* call register
 - received text messages 58
 - receiving a call 35
 - during a call 36

- receiving a name and phone number 51
- receiving a ringing tone 74
- redialling a number 32
- rejecting a call 20, 35
- reminders 90
- renaming a profile 98
- resetting default settings. *See* restoring factory settings
- restoring factory settings 83
- ringing tones 71, 96
 - creating 72
 - defining for a specific phone number 50
 - silent 22
- ringing volume 71, 96

S

- safety instructions 15, 115
- saving a name and phone number in Phone book 38, 50
- screen saver 75, 97
- scroll keys 20
- security code 17, 110
 - prompt 28
 - request 82

- security level 82
- security settings
 - call barring 80
 - call barring password 112
 - closed user groups 81
 - fixed dialling 81
 - PIN code 111
 - PIN code request 80
 - PIN2 code 111
 - PUK code 111
 - PUK2 code 111
 - security code request 82, 110
 - security level 82
- sending
 - a name and phone number to another phone 51
 - command requests 64
 - text messages 56
- sending DTMF tones 110
- service command editor 64
- service numbers, calling 49
- services
 - SIM services 109
 - WAP 99

- settings 76
 - call settings 76
 - phone settings 78
 - restoring 83
 - security settings 79
- showing own phone number to called party 77
- signal strength 21
- silent mode 22
- SIM card
 - inserting 24
 - using 24
- SIM services 109
- smileys 61
- SMS messages. See text messages
- spaces, inserting 43
- special characters 43
- speed dialling 33, 52
- standby mode 21
 - converting currencies 89
 - display indicators in 21
- stopwatch 93
 - display indicator 22
- switching on or off 19, 28

T

- templates 60
- text messages
 - deleting 58
 - delivery reports 62
 - display indicator 22
 - message centre number 62
 - message formats 62
 - reading 58
 - replying 58
 - saving 56
 - sending 56
 - sets 61
 - settings 61
 - smileys 61
 - templates 60
 - validity period 62
 - viewing 59
 - writing 56
- time management
 - alarm clock 92
 - countdown timer 94
 - reminders 90
 - stopwatch 93

time zone. See automatic update of date and time

tones 71

game tones 86

keypad tones 74, 97

message alert tones 74, 97

ringing tones 71, 96

See also profiles

warning tones 74, 97

traditional text input 39, 42

display indicator 42

traffic safety 115

V

vibrating alert 71, 74, 97

voice dialling 53

attaching a voice tag to a name and phone number 54

making a call using 54

using HDC-5 headset 54

voice mailbox

diverting calls 84

saving phone number 64

voice messages

listening to 36

See also voice mailbox

W

WAP services 99

warning tones 71, 74, 97

welcome note 79

writing

names in Phone book 38

reminders 90

text messages 56

using predictive text input 39, 40

using traditional text input 39, 42

welcome note 79