

KORG

GUITAR SYNTHESIZER

Z3

OWNER'S MANUAL

INTRODUCTION

The Z3 Guitar Synthesizer is an remarkably sophisticated device designed to bring the guitar player into the advanced world of digital music. With the aid of the ZD3 Guitar Synthesizer Driver, any 6-string electric guitar can be used to play, with accurate expression and instant response, the synthesized sounds of the Z3.

The Z3 Guitar Synthesizer features:

- Extremely responsive, instant operation with accurate pitch-to-digital data conversion — even when bending strings.
- Multi-timbral operation (allowing each string to play a different Program).
- Comprehensive editing functions, including control over MIDI channels for playing additional synthesizers and recording to sequencers.
- Built-in tuner.
- Built-in reverb.
- Footswitch control of various functions.
- Chromatic/continuous pitch bend selection.
- Patch Play function for increased ease in calling up Programs in live performance.

PRECAUTIONS

- ★ The voltage requirement for your Z3 has been set specifically for the main supply voltage used in your area. If you have any doubts about voltage suitability, please consult your local KORG dealer. If you intend to use your Z3 in an area with a different voltage, be sure to use the appropriate voltage convertor.
- ★ Avoid placing your Z3 in direct sunlight or close to a source of heat. Also, avoid locations where the instrument is likely to be subjected to vibration, excessive dust, cold or moisture. All of these conditions could have a detrimental effect on both the mechanisms and the circuitry incorporated into the Z3.
- ★ Do not use abrasive cleaners, waxes, solvents, or chemical dust cloths to clean the exterior or keys of your Z3 as these may dull the keys or damage the finish. Use a slightly damp cloth and a neutral cleanser. Also, never use aerosol sprays near the Z3 as they can get into the circuitry and prevent accurate transmission of data.
- ★ Your Z3 contains no user serviceable parts. Opening it or tampering with it can lead to electrical shock as well as damage, and will void the product warranty. Refer all servicing to qualified KORG personnel.
- ★ Avoid applying excessive force to all controls. Also avoid dropping the instrument or otherwise subjecting it to impact. While the internal circuitry is of reliable integrated circuit design, the Z3 should be treated with care.
- ★ When unplugging cords or cables (MIDI, audio, power, etc.) from the Z3, never unplug by pulling on the cords; this can result in damage to the Z3 or the cords. Always unplug by firmly grabbing the connector and pulling.
- ★ After studying this manual thoroughly, keep it in a safe place for future reference.

HOW TO USE THIS MANUAL

We recommend that you read all of this manual carefully in order to get the most out of your Z3. Its chapters have been designed to serve the needs of both the beginning electronic musician and the experienced MIDI expert; regardless of your level of experience with digital music instruments, read through the chapters, skipping sections that seem familiar to you. The worst that can happen is that you'll have to come back and read the sections you skipped.

The sections have been carefully arranged so as to guide you as you operate your Z3, with minimum effort and maximum creativity. If you read nothing else in this manual, however, read this section. It will tell you where to look to find what you need to know.

- Read the PRECAUTIONS first, to familiarize yourself with ways in which the Z3 can be damaged or misused. A thorough knowledge of this section will enable you to get the optimum performance out of your Z3 for many years to come.
- The GUIDE TO THE CONTROLS AND ACCESSORIES section gives a clear, easy-to-follow introduction to the controls built in to the Z3. Although sophisticated, the Z3's controls are laid out in a neat, orderly manner allowing you to make full use of its features with a minimum of effort.
- A separate insert, SETTING UP THE ZD3 GUITAR SYNTHESIZER DRIVER, has been included with this manual and is designed to guide you through the preliminary steps of installing the optional ZD3 Guitar Synthesizer Driver on your guitar. If you have the ZD3, read this insert and install the ZD3 before going on to the following section.
- SETTING UP AND PLAYING, as the title indicates, describes the simple connection procedure of the Z3 and has basic information about its performance features. Once you work through this chapter, you'll be able to set up your Z3 and be ready to play in minutes.
- The MODE A chapter introduces you to the basic play operations of the Z3. More advanced features, including the editing functions of the Z3, are described in the MODE B chapter. The MODE B chapter provides, in complete detail, all the information you need to know to take full advantage of this instrument. It may not be necessary for you to read all of this chapter. In fact we recommend you go through it at your own pace, trying out whatever features interest you. This section will also come in handy as a reference whenever you need to check something or jog your memory.
- A special section on MIDI and Applications is provided as a simplified crash course in MIDI technology. This will give you a brief introduction to MIDI, an overview of the MIDI features included on the Z3, plus some system examples, to suggest just a few of the virtually unlimited number of ways to use the Z3 with a MIDI digital music system. For further reference on MIDI, consult the manual of your MIDI device, as well as the variety of publications and magazines now available on the subject of this fast-growing technology.
- A GLOSSARY has been included, which clearly explains the terminology used in this manual, particularly for the benefit of the Z3 owner with a limited knowledge of digital music and MIDI.
- Following the technical SPECIFICATIONS, the MIDI IMPLEMENTATION section gives full details of the MIDI technology used in the Z3, for users seriously interested in the MIDI and computer applications of this advanced instrument.

TABLE OF CONTENTS

INTRODUCTION	i
PRECAUTIONS	i
HOW TO USE THIS MANUAL	1
GUIDE TO THE CONTROLS	3
ZD3 GUITAR SYNTHESIZER DRIVER	3
Z3 GUITAR SYNTHESIZER (Front Panel)	4
Z3 GUITAR SYNTHESIZER (Rear Panel)	4
SETTING UP AND PLAYING	6
TUNER	7
MODE A	7
SETTING OPERATION OF THE Z3 TO MODE A	7
USING THE FRONT PANEL SWITCHES IN MODE A	8
POLY MODE (RESETTING OF THE MIDI CHANNEL)	9
SWITCHES THAT DO NOT FUNCTION IN MODE A	9
FOOTSWITCH OPERATION	10
MODE B	10
SWITCHES THAT DO NOT FUNCTION IN MODE A	10
EDIT MODE	10
ENTERING THE EDIT MODE	10
PARAMETERS OF THE EDIT MODE	11
HOW TO EDIT THE PARAMETERS FOR EACH STRING	12
COPYING PARAMETERS FROM ONE STRING TO ANOTHER ...	12
SAVING PARAMETER EDITS TO A PROGRAM	13
CANCELING OR ABORTING EDITS BEFORE SAVING	13
EDITING THE PARAMETERS — AN EXAMPLE	13
POLY MODE (RESETTING OF THE MIDI CHANNEL)	14
PATCH PLAY MODE	14
ENTERING THE PATCH PLAY MODE	14
SELECTING PATCHES IN THE PATCH PLAY MODE	15
EXITING THE PATCH PLAY MODE	15
PATCH EDIT MODE	15
ENTERING THE PATCH EDIT MODE	15
ASSIGNING PROGRAMS TO PATCH NUMBERS	16
CANCELING OR ABORTING PROGRAM ASSIGNMENTS	
BEFORE SAVING	16
ASSIGNING PROGRAMS TO PATCH NUMBERS	
— AN EXAMPLE	16
SETTING THE BASIC MIDI CHANNEL	17
SOUND GENERATOR MODE	17
USING THE FC6 FOOT CONTROLLER	18
CONNECTION WITH THE FC6	18
PROGRAM SELECTION	18
MODE 1	18
MODE 2	19
MIDI AND APPLICATIONS	20
WHAT MIDI IS AND WHAT IT CAN DO	20
THE BASIC MIDI SETUP	20
MIDI TERMINALS	21
MIDI CHANNELS	21
MIDI FEATURES OF THE Z3	21
MIDI APPLICATION EXAMPLE	22
APPLICATION : ADDITIONAL SYNTHESIZER	
AND EFFECTS UNIT	22
MIDI IMPLEMENTATION	23
GLOSSARY	33
SPECIFICATIONS	35
MIDI IMPLEMENTATION CHART	26

GUIDE TO THE CONTROLS

The controls of the Z3 follow a few basic conventions:

- 1) Quickly pressing and releasing any key that increases or decreases numeric data will cause the value displayed to change in single steps.
- 2) Holding down any key that increases or decreases numeric data will cause the values to change continuously, slowly at first, then very rapidly.
- 3) Value changes “wrap around” at the minimum and maximum values. For example, in a range of values from 1 to 128, the next step up from 128 is 1, and stepping down from 1 changes to 128.

ZD3 GUITAR SYNTHESIZER DRIVER

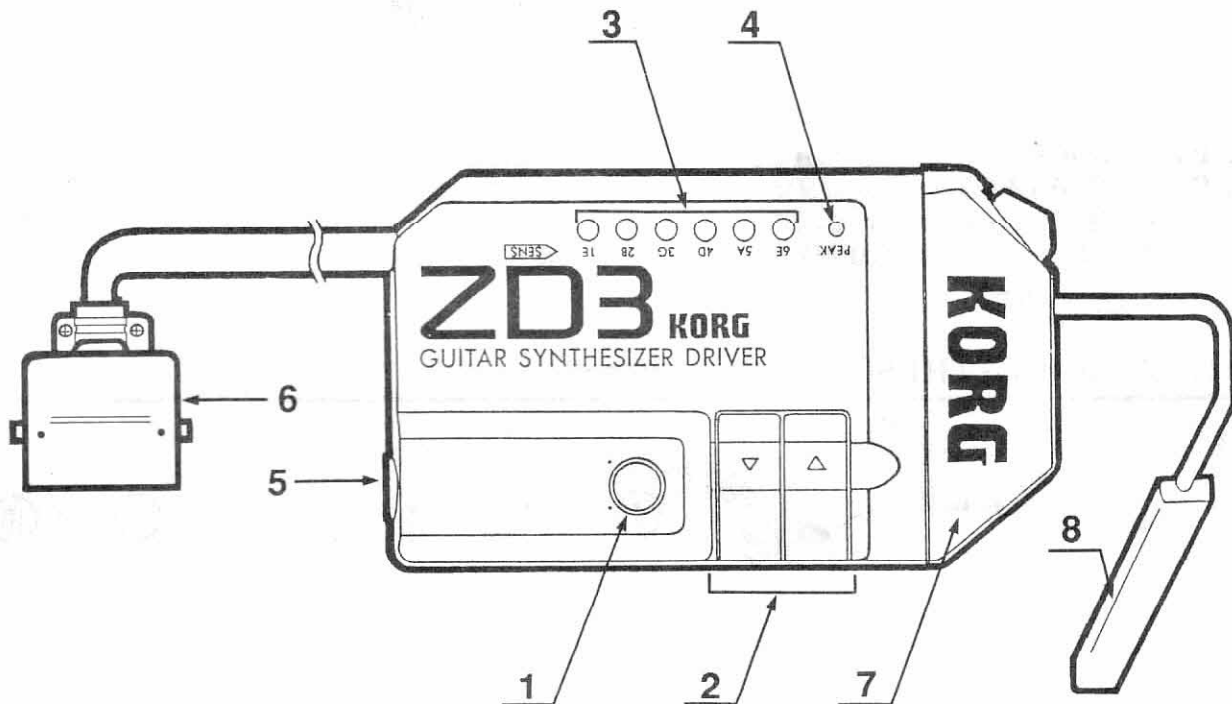

1. Synthesizer master volume control

2. Program DOWN/UP keys

The Program DOWN/UP keys of the ZD3 allow you to select Programs from the Z3 in single steps only. Holding down either key does not cause the values to change continuously.

3. Gain adjust dials for strings 1 though 6

4. Peak indicator LED

5. Guitar input jack

6. 24-pin connector

7. Face plate and mounting bracket

8. Divided pickup

Z3 GUITAR SYNTHESIZER (Front Panel)

::2

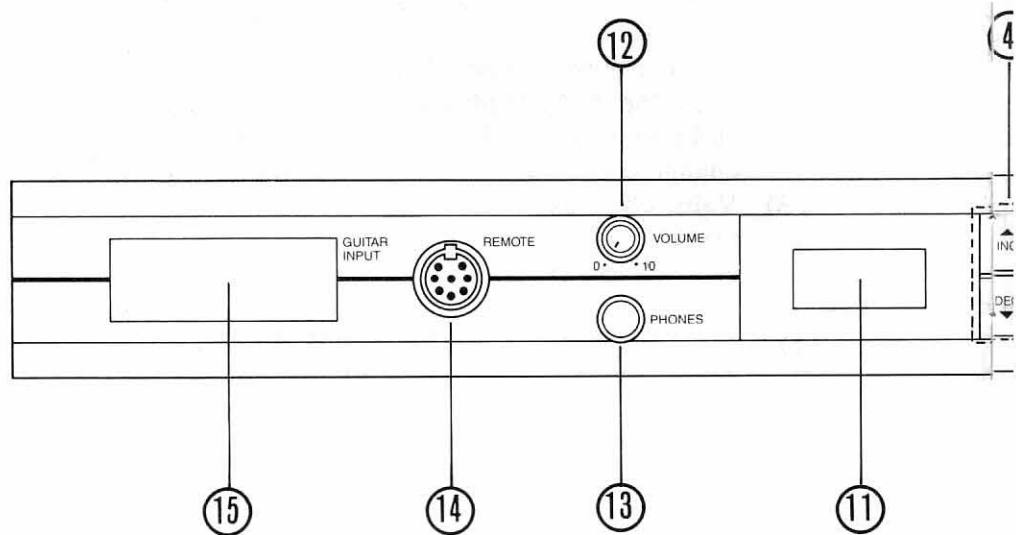

- | | |
|-----------------------------|--------------------------|
| 1. Power switch | 5. TUNER key |
| 2. STRING SELECT keys | 6. REVERB ON/OFF key |
| 3. FUNCTION key | 7. SENSITIVITY Hi/Lo key |
| 4. INCREMENT/DECREMENT keys | 8. BEND ON/OFF key |

Z3 GUITAR SYNTHESIZER (Rear Panel)

::3

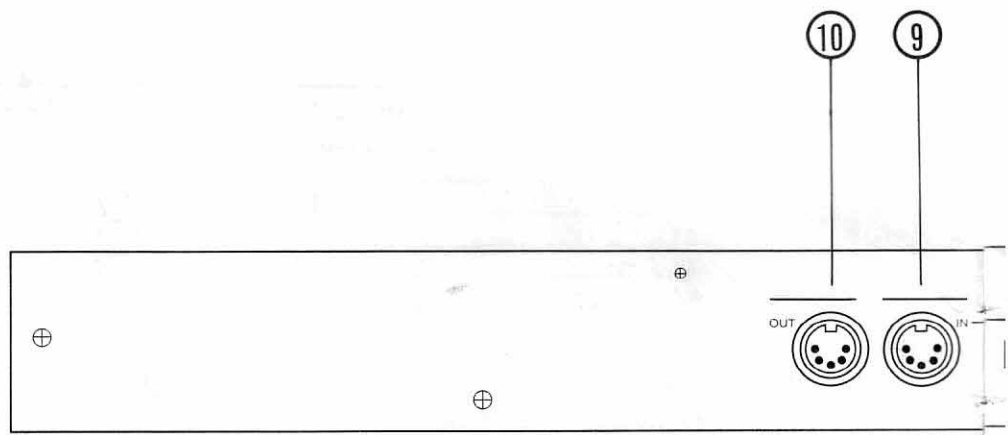

- | | |
|---|-------------------------|
| 1. Synthesizer audio output jacks
(Left/Mono, Right) | FOOTSWITCH JACKS |
| 2. Guitar output jack | 3. SYNTHESIZER OFF |
| | 4. HOLD |
| | 5. PROGRAM UP |
| | 6. PROGRAM DOWN |

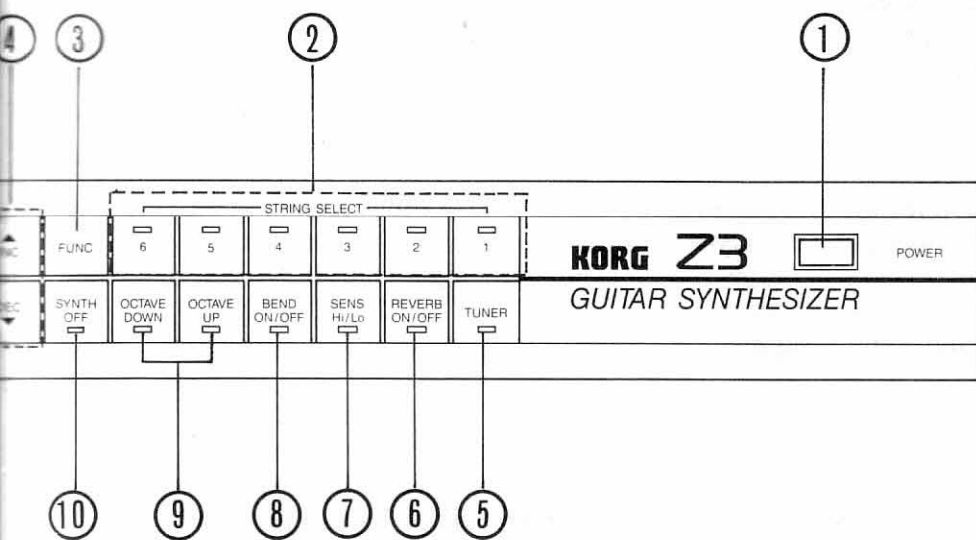

- 9. OCTAVE DOWN/UP keys
- 10. SYNTHESIZER OFF key
- 11. Display
- 12. VOLUME control

- 13. PHONES jack
- 14. REMOTE terminal (for connection of FC-6 Foot Controller)
- 15. GUITAR INPUT terminal

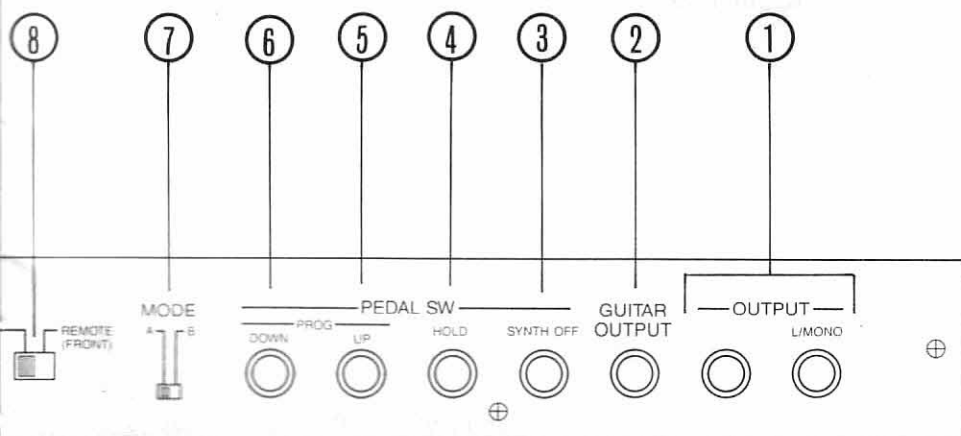

- 7. MODE switch
- 8. Rear MIDI IN / Front remote in switch
- 9. MIDI IN terminal
- 10. MIDI OUT terminal

SETTING UP AND PLAYING

If you've properly followed the steps of installing the ZD3 Guitar Synthesizer Driver, making the necessary connections and adjusting the gain levels of the strings, you're only a few steps away from playing your Z3 Guitar Synthesizer.

1. Make sure the volume controls on your Z3 and connected equipment are turned all the way down.
2. Connect the guitar output jack and the synthesizer audio output jacks to a high-quality instrument amplifier or mixer. If your amplifier can only accommodate one input, connect the L/MIX output jack to the amplifier. (This will output the Z3 synthesizer signal only.)
3. Turn on the power of the Z3.
4. Turn on the power of all connected audio equipment.
5. Play the strings of the guitar.
6. Set all volume controls (including those on the Z3 Drive Unit and the Z3) to comfortable levels.

The Z3 is also equipped with a PHONES jack on the front panel for headphone listening.

NOTE: You may find that even after performing the above steps, no sound is output from the Z3. This can happen when a selected program has separate MIDI channel assignments for each string. In such a case, press and hold down the FUNCTION key, then press STRING SELECT key 2. This resets all MIDI channel assignments of the strings to the same value.

When you are in Mode A, pressing FUNCTION + STRING SELECT key 2 assigns all strings to MIDI channel 1. Your Z3 should be already set to operate in Mode A, but if for some reason it is not, refer to the section, "Setting Operation of the Z3 to Mode A" in the Mode B chapter for instructions on how to switch between modes. When you are in Mode B, all strings are given the same MIDI channel assignment as string #1. (Refer also to the section, "Parameters of the Edit Mode" in the Mode B chapter for information on how to set MIDI channels for each string.)

TUNER

The Z3 is equipped with a built-in tuner for matching the tuning of the guitar to the internal sound source of the Z3. Whether the Z3's operation is in Mode A or Mode B, the tuner function can be used by pressing the TUNER key. The LED of the key will light up and the following display will appear.

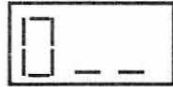

↑ Indicates pitch setting (standard pitch)

Pitch	Display Indication
438Hz	8 (final digit of frequency)
439Hz	9 (" " " ")
440Hz	0 (" " " ")
441Hz	1 (" " " ")
442Hz	2 (" " " ")
443Hz	3 (" " " ")
444Hz	4 (" " " ")
445Hz	5 (" " " ")

Set the standard pitch by using the INCREMENT/DECREMENT keys.

The STRING SELECT LED corresponding to the string which was last played will be lit up.

MODE A

All operations and functions of the Z3 Guitar Synthesizer can be grouped into one of two conditions: PLAY or EDIT. In PLAY, of course, the sounds, functions and settings of the Z3 can be used "as is"; in EDIT, they can be changed.

Mode A is the basic playing mode of the Z3 Guitar Synthesizer, and in it only the PLAY condition is possible. It is the simpler of the two modes included on this instrument, and initially, until you become more familiar with the capabilities of the Z3, you probably won't need to stray from Mode A.

NOTE: When you turn the power on, the currently selected mode, A or B, will be shown on the display for a couple of seconds.

SETTING OPERATION OF THE Z3 TO MODE A

As delivered from the factory, your Z3 Guitar Synthesizer has been set to operate in Mode A. If or when the Z3 is not set to Mode A, here's what to do:

1. Turn off the power of the Z3.
2. Using a sharp, pointed object (such as a ball-point pen or a small screwdriver), move the MODE switch on the rear panel to A.
3. Turn the power back on.

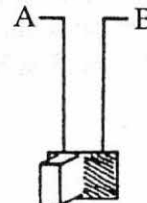

Changing the setting of the MODE switch when the power is on has no effect on the operation

USING THE FRONT PANEL SWITCHES IN MODE A

The front panel controls listed provide the following functions when playing the Z3 in Mode A:

The **INCREMENT/DECREMENT** keys — Selection of Program numbers.

Holding down either of these keys causes values to change continuously. Change of values speeds up the longer the key is held.

The **SYNTHESIZER OFF** key — Turning off and on the synthesizer sound.

The LED of this key lights to indicate that the synthesizer sound is off. Only the sound from the guitar's conventional pickups is output in this condition.

The **OCTAVE DOWN** key — Lowering the pitch of the synthesizer by one octave.

The LED of this key lights to indicate that the range has been lowered one octave. Both the internal program and the MIDI output are affected. (The range of connected synthesizers will also be lowered one octave.) To return to the original octave setting (and turn the LED off), press this key again.

The **OCTAVE UP** key — Raising the pitch of the synthesizer by one octave.

The LED of this key lights to indicate that the range has been raised one octave. Both internal programs and the MIDI output are affected. (The range of connected synthesizers will also be raised one octave.) To return to the original octave setting (and turn the LED off), press this key again.

NOTE: The OCTAVE DOWN/UP keys are interactive; both cannot be lit at the same time. Pressing one overrides the effect of the other. When neither key is lit, pitch of the Z3 is normal. To return to the original octave setting, press the OCTAVE DOWN or UP key beneath the lit LED.

The **BEND ON/OFF** key — Turning on and off the continuous pitch bend function.

The Z3 is capable of duplicating pitch bends executed on the guitar, both by whammy bar and manual bending of the strings. This key selects in what fashion the pitch will be bent: continuously (smoothly) or chromatically (in half-tone steps). Both internal programs and the MIDI output are affected. The LED of this key lights to indicate that pitch bend is continuous.

The **SENSITIVITY Hi/Lo** key — Selection of the degree to which the synthesizer responds to guitar playing.

The LED of this key lights to indicate that the sensitivity is set to HIGH. When off, the synthesizer does not respond to a soft playing technique. (Note on messages are not generated unless you play strongly.) Both internal programs and the MIDI output are affected.

The **REVERB ON/OFF** key — Turning on and off the reverb effect.

The LED of this key lights to indicate that the reverb effect is on.

The **TUNER** key — Selection of the built-in tuner function.

The LED of this key lights to indicate that the tuner function is active.

The display will change as shown when this function has been selected:

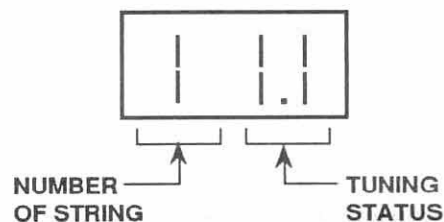

The leftmost character in the display indicates the number of the string. It will change automatically according to the string played.

The remainder of the display indicates the tuning status: flat, sharp or in tune. The display is dynamic and changes instantly as the guitar's tuning is adjusted.



POLY MODE (RESETTING OF THE MIDI CHANNEL)

Selecting the Poly Mode of Mode A resets the MIDI channels of all strings to channel number 1. To select the Poly Mode, hold down the FUNCTION key and press STRING SELECT key 2.

NOTE: The pitch bend function of the Z3 cannot be used in Poly Mode and all notes will be played chromatically. This affects both the internal sound source of the Z3 and the output MIDI data (the sound sources of connected instruments).

SWITCHES THAT DO NOT FUNCTION IN MODE A

No editing functions are available in Mode A. As a result, the following switches are inactive:

- The FUNCTION key
- The STRING SELECT keys

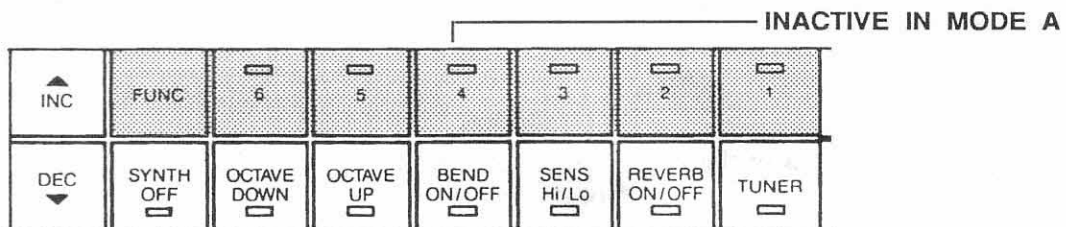

All other switches and functions are active.

NOTE: The one exception to the above is the combined use of the FUNCTION key and STRING SELECT key 2 to select the Poly Mode (see the section POLY MODE above). Pressing STRING SELECT key 2 while holding down the FUNCTION key resets the MIDI channels of all strings to 1.

FOOTSWITCH OPERATION

Four footswitch jacks on the rear panel provide convenient foot control over certain Z3 functions: Program selection, Note Hold and Synthesizer Off. (Use the optional PS-1 or PS-2 Pedal Switches.)

Program Selection — This duplicates the function of the INCREMENT/DECREMENT keys on the front panel. Connecting footswitches to the two jacks, PROGRAM UP and PROGRAM DOWN, allows you to change Program numbers without taking your hands from the guitar.

Note Hold — When connected to this jack, the footswitch functions like a sostenuto pedal: playing a string, then pressing the Hold switch causes that string to sustain. Other strings played after the Hold switch is pressed are articulated normally. This function allows you create special effects, such as the playing of rapid staccato notes over a drone, for instance.

Synthesizer Off — This function is the same as that of the front panel key of the same name. Connecting a footswitch to this jack allows you to turn the synthesizer sound off and on without having to use the front panel SYNTHESIZER OFF key.

NOTE: The programs of the Z3 can also be switched by using a special remote foot controller, the KORG FC6 Foot Controller. (Refer to the section “Using the FC6 Foot Controller.”)

MODE B

Mode B lets you access the various editing and patch creation features of the Z3.

SWITCHES THAT DO NOT FUNCTION IN MODE B

Performance functions of the Z3 are set for each string in Mode B as part of the programs; as a result, no real time on/off switching of these individual functions can be done and the following switches are inactive:

- The OCTAVE DOWN key
- The OCTAVE UP key
- The BEND ON/OFF key
- The SENSITIVITY Hi/Lo key

▲ INC	FUNC	6	5	4	3	2	1
▼ DEC	SYNTH OFF	OCTAVE DOWN	OCTAVE UP	BEND ON/OFF	SENS Hi/Lo	REVERB ON/OFF	TUNER

INACTIVE IN MODE B

The OCTAVE DOWN and UP keys are used in this mode for parameter selection. All other switches and functions are active as normal.

EDIT MODE

ENTERING THE EDIT MODE

The Edit Mode is a sub-mode of Mode B. In other words, to use the Edit Mode, the Z3's operation must be switched (after turning the power off) to Mode B.

To enter the Edit Mode:

1. Select a Program number. All edits that you make and save will be stored to this Program number. (If a Program number is not selected, the one last chosen in PLAY is automatically selected.)
2. Hold down the FUNCTION key and press STRING SELECT key 6.

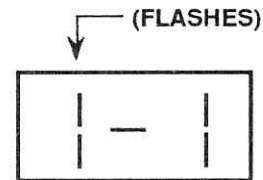

The resulting display will be the same or similar to that shown above.

The leftmost character in the display (flashing) indicates the number or type of the parameter. When first selected, "1" will appear as the leftmost character, indicating that the first parameter has been automatically selected.

The other two characters in the display represent the current parameter value.

The parameter and parameter values of only one string can be displayed at one time. The LED of the STRING SELECT key corresponding to the currently selected string will be lit up.

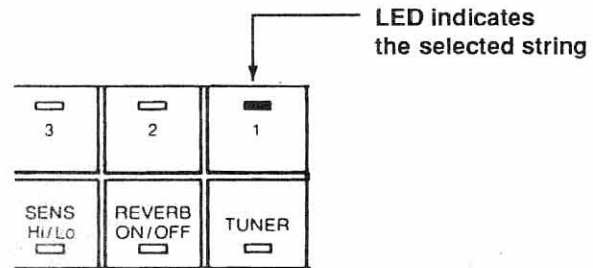

PARAMETERS OF THE EDIT MODE

These are the parameters available for editing in the Edit Mode. One Program is made up of six separate groups of parameter settings, one for each string of the guitar. All strings can easily be assigned the same parameter values or be given different settings for unconventional or specific applications.

Parameter Number	Parameter Name	Range
1	Program Change Request	1 — 128
2	Bend Range	0 — 12
3	Note On Sensitivity	1 — 8
4	Velocity Curve	1 — 8
5	Transpose	0 — +/-12
6	Hold (Sostenuto)	ON/OFF
7	MIDI Channel	0 — 16
8	Sound Number	1 — 128
9	Timbre Output Level	0 — 15
0	Reverb (Global)	ON/OFF

PROGRAM CHANGE REQUEST — Sets the program number (1 - 128) for connected MIDI instruments that are played by each string in the Program.

BEND RANGE — Sets the range over which pitch bend can be executed for each string in the Program. A setting of 0 makes the pitch bend chromatic, a setting of 1 makes the pitch bend coincide exactly with the string bend, and higher values extend the pitch bend range proportionally.

NOTE ON SENSITIVITY — Adjusts the degree to which the synthesizer responds to playing of each string in the Program. A low value allows even softly picked notes to sound.

VELOCITY CURVE — Determines the relationship between playing strength and output level.

TRANSPOSE — Adjusts the pitch of the sound for each string in the Program in half-tone steps up to +/- one octave.

HOLD (SOSTENUTO) — Turns on and off the Note Hold function. A connected footswitch can thus function like a sostenuto pedal: pressing the footswitch after playing a string causes that string to sustain, while all subsequently played strings are articulated normally.

MIDI CHANNEL — Sets the MIDI transmit channel for each string in the Program. A setting of 0 disables MIDI transmission.

SOUND NUMBER — Sets the internal program number (1 - 128) for each string in the Program.

TIMBRE OUTPUT LEVEL — Sets the volume of the internal program for each string in the Program.

REVERB — Sets the reverb effect for all strings. This parameter cannot be set individually for each string. It is a global parameter and affects all strings simultaneously.

HOW TO EDIT THE PARAMETERS FOR EACH STRING

1. Select the string for which you want to change parameter values. Press the appropriate STRING SELECT key.
2. Use the OCTAVE DOWN and OCTAVE UP keys to change the parameter number.
3. Use the INCREMENT/DECREMENT keys to change the parameter value.

COPYING PARAMETERS FROM ONE STRING TO ANOTHER

For convenience in editing, the Z3 allows you to quickly and easily copy the parameter values of one string to another.

To copy the value of one parameter of a string to that of another string:

1. Select the parameter you wish to copy. Use the OCTAVE DOWN and OCTAVE UP keys.
2. Press and hold down the STRING SELECT key of the source string (the one FROM which you wish to copy).
3. While holding down the source STRING SELECT key, press the STRING SELECT key of the destination string (the one TO which you wish to copy). You can save the selected parameter to other strings by continuing to hold down the source STRING SELECT key and pressing other STRING SELECT keys.

The LEDs above each selected destination STRING SELECT key will light to indicate that the parameter has been copied. When the source switch is released, those destination LEDs will go out.

4. Repeat steps 1 through 3 above for other parameters you want to copy.

SAVING PARAMETER EDITS TO A PROGRAM

Once you have edited parameters of one or more strings to your liking, you can save the new parameter values to a Program. In this way, your settings can be recalled instantly for use at any time simply by selecting the appropriate Program number.

To save newly edited parameters to a Program:

1. Press and hold down the FUNCTION key.
2. Press STRING SELECT key 3.

The number of the Program selected before you began editing will appear in the display, and all edits you made will be saved to this Program.

CANCELING OR ABORTING EDITS BEFORE SAVING

You can abort the editing process at any time (before you save edits) and restore all parameters to their original values.

To cancel any edits you've made without saving them to a Program number:

1. Press and hold down the FUNCTION key.
2. Press STRING SELECT key 6.

The number of the Program selected before you began editing will appear in the display, and all edits made before saving will be cancelled. Parameters will be restored to their original values.

Note that the FUNCTION key and STRING SELECT key 6, when used together, are a toggle for entering and exiting the Edit Mode.

EDITING THE PARAMETERS — AN EXAMPLE

Let's try changing the parameter values in a specific example.

In our example, we'll make a new Program and set the first parameter so that string number 1 plays internal program number 120. Then we'll copy the new parameter value to the other strings and save the newly created Program to Program number 1.

1. While in the normal PLAY condition (in other words, before entering the Edit Mode), select Program number 1. Use the Program DOWN/UP keys on the Z3 Drive Unit attached to your guitar, or use the INCREMENT/DECREMENT keys on the Z3.

2. Hold down the FUNCTION key and press STRING SELECT key 6 (to enter the Edit Mode).

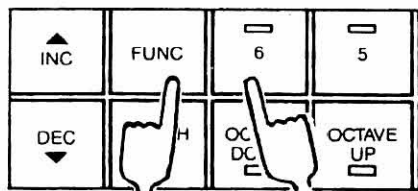

3. Press STRING SELECT key 1 (to select the 1st string).

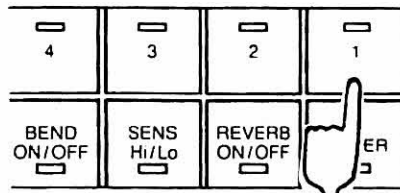

- Use the OCTAVE DOWN and OCTAVE UP keys to select parameter number 1. Make certain that the leftmost number in the display is "1."

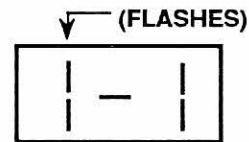

- Use the INCREMENT/DECREMENT keys to select internal program number 120. Holding down either key causes the value to increase or decrease rapidly.

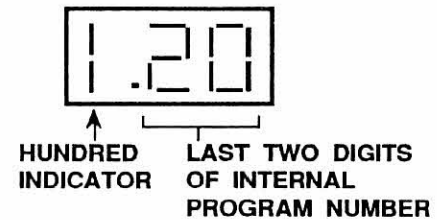

The dot in the display indicates selection of a hundreds-value internal program number. The display above shows selection of internal program number 120.

- Copy this parameter value to the other strings. While holding down STRING SELECT key 1, press and release STRING SELECT keys 2 through 6.

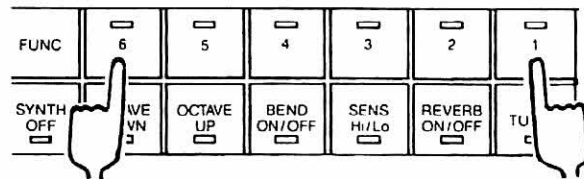

- Now that you're finished editing, save the parameter and return to PLAY. Hold down the FUNCTION key and press STRING SELECT key 3. Program number 1 will be indicated in the display and all edits made in the above steps will be saved to Program number 1.

POLY MODE (RESETTING OF THE MIDI CHANNEL)

Selecting the Poly Mode of Mode A resets the MIDI channels of all strings to the same MIDI channel as is assigned to string 1. To select the Poly Mode, hold down the FUNCTION key and press STRING SELECT key 2.

NOTE: The pitch bend function of the Z3 cannot be used in Poly Mode and all notes will be played chromatically. This affects both the internal sound source of the Z3 and the output MIDI data (the sound sources of connected instruments).

PATCH PLAY MODE

Since the Z3 allows you to select from 128 Programs, getting from one Program to another by using the Program DOWN/UP keys may not be quick enough for live performance situations. Moreover, re-editing all Programs so that they would be in the proper order for live performance is also impractical.

The Patch Play Mode, along with the Patch Edit Mode, remedies this by allowing you to select Programs from eight individual Banks. Each Bank can hold up to eight Programs or Patches. The distribution and order of the Patches in the Banks can be set in the Patch Edit Mode.

ENTERING THE PATCH PLAY MODE

The Patch Play Mode is a sub-mode of Mode B. In other words, to use the Patch Play Mode, the Z3's operation must be switched (after turning the power off) to Mode B.

To enter the Patch Play Mode:

1. Make certain that the Z3 is in the PLAY condition (not in the Edit Mode).
2. Press and hold down the FUNCTION key.
3. Press STRING SELECT key 1. The resulting display will have the following information:

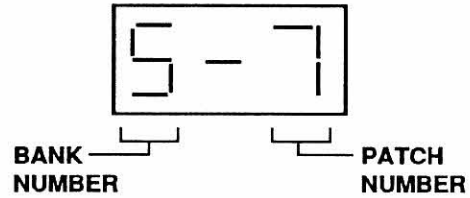

The leftmost number indicates the Bank number and the rightmost indicates the Patch number.

SELECTING PATCHES IN THE PATCH PLAY MODE

To select Patches in the Patch Play Mode:

1. Use the INCREMENT/DECREMENT keys to switch among the eight Banks.
2. Use the OCTAVE DOWN and OCTAVE UP keys to call up one of the eight available Patches in the selected Bank.

EXITING THE PATCH PLAY MODE

Exiting the Patch Play Mode and returning to the PLAY condition is done in the same way as entering the Patch Play Mode:

1. Press and hold down the FUNCTION key.
2. Press STRING SELECT key 1.

PATCH EDIT MODE

In the Patch Edit Mode you can change the order of the Z3's Programs. By assigning them to Patch numbers, eight to a Bank, selection of Programs is much easier and quicker — a convenience particularly when performing live.

ENTERING THE PATCH EDIT MODE

The Patch Edit Mode can only be selected from within the Patch Play Mode. (See the PATCH PLAY MODE section above for more information.)

To enter the Patch Edit Mode:

1. While in the Patch Play Mode, select the Bank to which you want to assign the Program number or numbers. Use the INCREMENT/DECREMENT keys to select the Bank. (If a Bank number is not selected, the one last chosen in the Patch Play Mode is automatically selected.)
2. Press and hold down the FUNCTION key.
3. Press STRING SELECT key 6. The resulting display will have the following information:

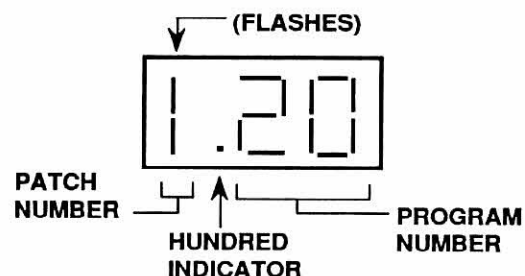

The leftmost number indicates the Patch number, while the dot (hundred indicator) and the next two numbers indicate the Program number.

ASSIGNING PROGRAMS TO PATCH NUMBERS

In the Patch Edit Mode you can assign any one of the 128 Programs to a Patch number. Newly assigned Patch numbers and Program numbers exist in memory simultaneously; you can still call up a Program with its original number in the PLAY condition even after assigning it to a Patch number.

Edits can be made only to the Bank that was selected before entering the Patch Edit Mode. To assign Programs to Patch numbers of other Banks, you must save the most recent edits (or cancel editing without saving) and return to the Patch Play Mode

To assign Programs to Patch numbers:

1. Make certain that the current Bank number is the one you want to assign Programs to.

NOTE: Since the Bank number is not shown on the display you must return to the Patch Play Mode to check it and change it if necessary. To do so:

- a. Press and hold down the FUNCTION key.
 - b. Press STRING SELECT key 3 or 6. (Pressing 3 saves all previous edits before returning to the Patch Play Mode; pressing 6 cancels all edits before returning.)
 - c. Change the Bank if necessary by using the INCREMENT/DECREMENT keys.
 - d. Enter the Patch Edit Mode again by holding down the FUNCTION key and pressing STRING SELECT key 6.
2. Use the OCTAVE DOWN and OCTAVE UP keys to select the desired Patch number.
 3. Use the INCREMENT/DECREMENT keys to select the desired Program number.
 4. Repeat steps 2 and 3 above for other Patch numbers in the same Bank.
 5. Save the edited assignments by holding down the FUNCTION key and pressing STRING SELECT key 3.

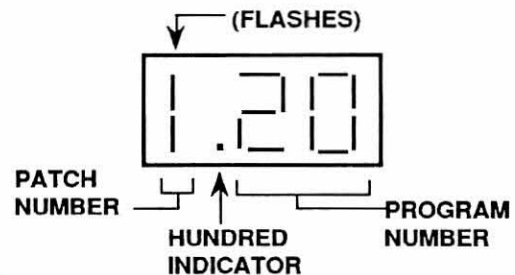

CANCELING OR ABORTING PROGRAM ASSIGNMENTS BEFORE SAVING

You can abort the Program assignment process at any time (before you save any assignments) and restore all previously made Patch number assignments.

To cancel any assignments you've made without saving them to a Patch number:

1. Press and hold down the FUNCTION key.
2. Press STRING SELECT key 6.

All Program-to-Patch-number assignments made before saving will be cancelled. Previously made Program assignments will be restored.

ASSIGNING PROGRAMS TO PATCH NUMBERS — AN EXAMPLE

Let's go step-by-step through a specific example of assigning a Program to a Patch number. In our example, we'll assign Program number 120 to Patch number 1 of Bank 2.

1. Make certain that the Z3 is in the PLAY condition (not in the Edit Mode).
2. Hold down the FUNCTION key and press STRING SELECT key 1 (to enter the Patch Play Mode).

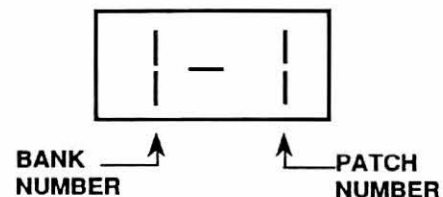

3. Switch to Bank 2 (indicated by the leftmost character in the display) to by using the INCREMENT/DECREMENT keys.

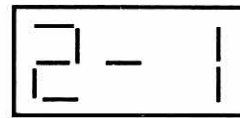

4. Hold down the FUNCTION key and press STRING SELECT key 1 (to enter the Patch Edit Mode).

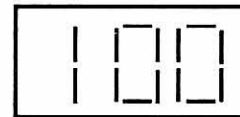

PATCH NUMBER → ↑ PROGRAM NUMBER

5. Select Patch number 2 with the OCTAVE DOWN and OCTAVE UP keys.

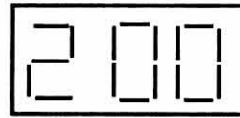

6. Select Program number 120 with the INCREMENT/DECREMENT keys.

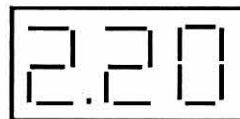

7. Finally, save your new setting by holding down the FUNCTION key and pressing STRING SELECT key 3.

The last step returns you to the Patch Play Mode, where you can select your newly assigned Program for play.

SETTING THE MIDI BASIC CHANNEL

In order to set the MIDI basic receive channel of the Z3, first press the SYNTHESIZER OFF key. Then, while holding down the the FUNCTION key, press STRING SELECT key 6. The display shown below will appear.



The last two figures indicate the MIDI basic channel. Use the INCREMENT/DECREMENT keys to change it. The newly selected channel will be stored to memory and will return as the default setting even after the power has been turned off and on.

OMNI ON/OFF settings can also be made in this condition. Use the OCTAVE UP key to switch to OMNI ON, and the OCTAVE DOWN key to switch to OMNI OFF. OMNI ON is indicated by a dot on the right side of the display; no dot indicates OMNI OFF. This is also stored as a default setting, like the basic MIDI channel above.

SOUND GENERATOR MODE

The Z3 can also be used as a separate sound generator module controlled by other MIDI devices, such as keyboards, rhythm machines and sequencers.

To enter the Sound Generator Mode, hold down the FUNCTION key and press the SYNTHESIZER OFF key.

USING THE FC6 FOOT CONTROLLER

CONNECTION WITH THE FC6

The following notes and instructions apply to connection of the Z3 to the optional FC6 Foot Controller.

1. The special connecting cable has a lock on one of its plugs and no lock on the other. Connect the plug with the lock to the FC6 and the other side to the Z3.
2. Set the power switch of the rear panel of FC6 to OFF/EXT. Electricity is supplied from Z3.
3. The FC6's operation differs depending on the instrument to which it is connected. The operation mode for control by the Z3 is automatically set when the FC6 is connected to the Z3.

PROGRAM SELECTION

The method of switching programs from the the FC6 differs depending on the mode selected, as described below. Select the mode you find most convenient or appropriate for your own purposes. The mode switch is located on the rear panel of the FC6. (Set the FC6 to its Manual 1 mode before operating; refer to the owner's manual of the FC6 for details.)

NOTE: Patch Play program numbers (selected from the FC6) displayed on the Z3 are not the same as the numbers shown on the display of the FC6. The numbers selectable on the FC6 range from 1 to 128, whereas the Z3's 64 Patch Play programs are arranged in banks, ranging from 1 - 1 to 8 - 8.

MODE 1

In this mode, programs are grouped for selection into banks, with five consecutive programs making up one bank. Keep in mind that the banks of the FC6 are different than the banks of the Z3; the FC6 has five programs per bank while the Z3 has eight programs per bank. Refer to the chart below for matching up the two different bank assignments.

Corresponding FC6 program numbers are given in the chart.

Z3 Bank Number	Patch Number							
	1	2	3	4	5	6	7	8
Bank 1	1	2	3	4	5	6	7	8
Bank 2	9	10	11	12	13	14	15	16
Bank 3	17	18	19	20	21	22	23	24
Bank 4	25	26	27	28	29	30	31	32
Bank 5	33	34	35	36	37	38	39	40
Bank 6	41	42	43	44	45	46	47	48
Bank 7	49	50	51	52	53	54	55	56
Bank 8	57	58	59	60	61	62	63	64

The program-to-bank assignments (for the FC6) are: programs No. 1 - 5, 6 - 10, 11 - 15, 16 - 20, 21 - 25, and so on.

- Switch [A] : Selection of first program in the bank.
- Switch [B] : Selection of second program in the bank.
- Switch [C] : Selection of third program in the bank.
- Switch [D] : Selection of fourth program in the bank.
- Switch [E] : Selection of fifth program in the bank.
- Switch [F] : Selection of bank. (Bank advances upon each press of the switch: [1], [6], [11], [16], [21]...)

For example, when the last selected program number is 18:
pressing switch [A] calls up program number 16;
pressing [B] calls up #17;
pressing [C] calls up #18;
pressing [D] calls up #19;
pressing [E] calls up #20;
and pressing [F] calls up the next bank, starting with program #21.

Each press of switch [F] changes the program number display and advances the bank selection as follows: #21, #26, #31, #36, and so on.

To decrease the bank number, press switch [F] while holding down switch [E].

NOTE: When decreasing the bank number in the above way, pressing switch [E] calls up the corresponding program number before the bank is changed.

MODE 2

In this mode, program number selection can be increased or decreased in steps of ten or in individual steps.

- SWA : Program number decreases by 10
- SWB : Program number increases by 10
- SWC : Program number decreases by 1
- SWD : Program number increases by 1
- SWE : Hold
- SWF : Synth Off

For example, when the first program number is 23:
pressing switch [A] calls up program number 13;
pressing [B] calls up #23;
pressing [C] calls up #22;
pressing [D] calls up #24;
and pressing [E] or [F] have no change in the program selection.

Refer to the chart above (in Mode 1) for matching up the two different bank assignments of the FC6 and the Z3.

MIDI AND APPLICATIONS

WHAT MIDI IS AND WHAT IT CAN DO

The Musical Instrument Digital Interface (MIDI), first brought out in 1982, has proved to be one of the most important developments in electronic music. By applying the power of MIDI to your Z3, you can carry out an unlimited number of previously impossible performance operations, including the following:

- Play one or several synthesizers at the same time from your Z3.
- Control the pitch bend performance functions on other synthesizers simply by bending the strings of your guitar.
- Change voices on other synthesizers and modules from your ZD3 Driver, a connected footswitch, or from the front panel of the Z3, for impressive and effortless sound changes in real time.
- Control digital drum machines or rhythm modules for the playing of percussion sounds from your Z3.
- Using your Z3 to record to a sequencer, for accurately capturing your guitar performances even string bends and program changes — as MIDI data, that can later be edited, played back and layered with overdubs.
- Use a sequencer to play back sounds on the Z3 Guitar Synthesizer while you play guitar parts over the recorded sequence.
- Control different synthesizers or modules from separate strings.
- Set effects devices such as digital delay and digital reverberation units to change their effects programs along with voice program changes, to complement and add to the overall sound of the Z3.
- Use a tape sync signal recorded onto one channel of a multitrack tape deck, to perfectly synchronize rhythm machines and sequencer-driven sounds from your Z3 with a vocal or acoustic performance recorded on tape. In this way, the seemingly opposed worlds of traditional acoustic music and state-of-the-art digital music can be blended and merged, providing enormous creative potential.

As you can see, MIDI is a very powerful and sophisticated musical tool. However, you won't need a course in computer science to use your Z3 effectively with other MIDI instruments. All you need to know is what MIDI devices can do, and how you can control them with your Z3. After that, MIDI does all the work for you.

THE BASIC MIDI SETUP

In essence, MIDI is extremely simple: it simply reduces all musical data to numbers, which can easily be sent from one instrument to another (hence the term "Digital Interface"). In every MIDI setup there is a master and a slave. The master can be a keyboard or sequencer — or now, with the Z3, a guitar — and the slave (a sound-generating instrument) is played by it.

MIDI TERMINALS

The master and slave must be connected in a certain way; otherwise “communication” between the two is impossible. For a master (such as the Z3) to control a slave (such as the M1R Music Work Station Module), a MIDI cable must be connected to the MIDI OUT terminal of the master (Z3) at one end and the MIDI IN terminal of the slave (M1R) at the other.

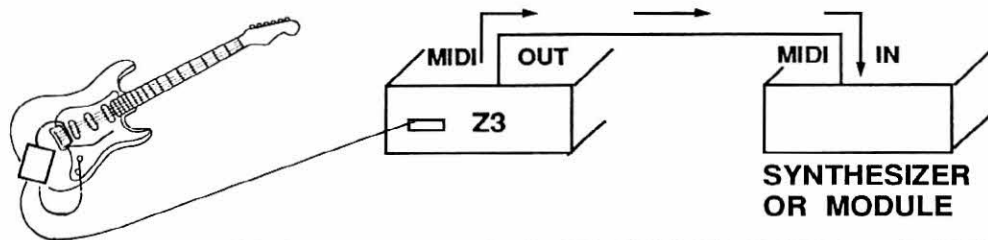

Most MIDI devices are equipped with three MIDI terminals: MIDI IN, MIDI OUT, and MIDI THRU. The names of these terminals appropriately indicate their function. Data is sent from one device’s MIDI OUT over the cable to the other device’s MIDI IN. MIDI THRU is used for setting up a second slave, connected to the first. Data is received at the MIDI IN terminal of the first module and is simultaneously sent to the second module via the MIDI THRU terminal.

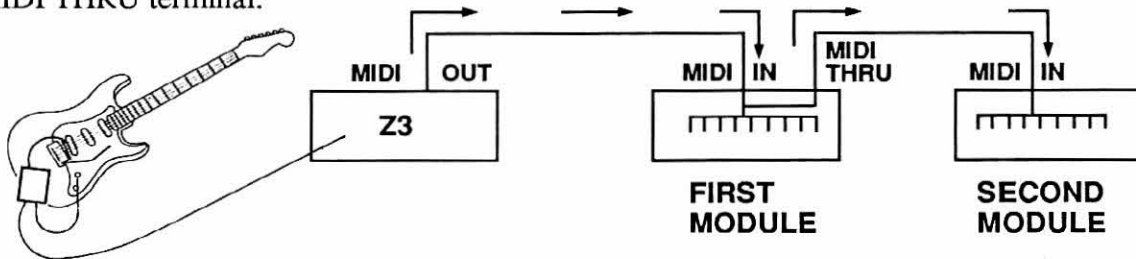

MIDI CHANNELS

Data is sent from master to slave over a MIDI channel. If the slave is not set to the same channel as the master, the master will not be able to control the slave. To be specific, the transmit channel of the master must be the same as the receive channel of the slave. The exception to this rule is when the slave is set to OMNI; in that case, it can receive data over all MIDI channels.

MIDI FEATURES OF THE Z3

The Z3 is equipped with two MIDI terminals: MIDI IN and MIDI OUT. When using a sequencer or another MIDI device for control of the Z3, the rear panel MIDI IN / Front remote in switch should be switched to IN. When playing the guitar controller normally, make sure the switch is set to REMOTE.

When using a sequencer to control the Z3, the guitar input from the Z3 Drive Unit can be shut off by holding down the FUNCTION key and pressing the SYNTHESIZER OFF key. This allows you to play your guitar normally, with just the audio output, while the sequencer plays the sounds of the Z3.

Playing the guitar and sequencer simultaneously with this function off may cause the guitar to “steal” notes from the sequencer input, leaving the sequence-recorded tracks incomplete.

The Z3 allows you to assign a different MIDI channel setting to each string of the guitar. With this exceptionally versatile function, not only can each string play a different internal program on the Z3, it can also control a different MIDI instrument.

When such a multi-channel setup is not necessary, you can instantly reset or initialize the MIDI channels of all strings. While holding down the FUNCTION key, press STRING SELECT key 2. This resets all MIDI channel assignments of the strings to the same value. (Doing this, however, temporarily disables the pitch bend function, both for internal programs and MIDI OUT data. Pitch bending is chromatic as a result.)

When you are in Mode A, pressing FUNCTION + STRING SELECT key 2 assigns all strings to MIDI channel 1. Your Z3 should be already set to operate in Mode A, but if for some reason it is not, refer to the section, "Setting Operation of the Z3 to Mode A" in the Mode B chapter for instructions on how to switch between modes.

When you are in Mode B, the above operation gives all strings the same MIDI channel assignment as string #1. (Refer also to the section, "Parameters of the Edit Mode" in the Mode B chapter for information on how to set MIDI channels for each string.)

MIDI APPLICATION EXAMPLE

To illustrate some of the possibilities of MIDI and perhaps to trigger some ideas of your own, here is a MIDI application of the Z3.

As we pointed out above, the basic procedure is to match the MIDI channel Transmit and Receive channels on the respective master and slave instruments. For more information and further application ideas, please refer to the owner's manuals of the particular MIDI instruments you are using.

APPLICATION: ADDITIONAL SYNTHESIZER AND EFFECTS UNIT

In this easy-to-use setup the Z3 can select and play the sound programs of the Symphony Orchestra Module. By connecting the MIDI THRU terminal of the Symphony to the MIDI IN terminal of the DRV-2000 Digital Reverb, the Z3 can simultaneously change effects programs along with its own Programs and the programs of the Symphony for perfect matching of sounds with effects. The audio signals of the Z3 and the Symphony are input to the KMX-122 Line Mixer, and fed through the effects send and return to the DRV-2000 for processing.

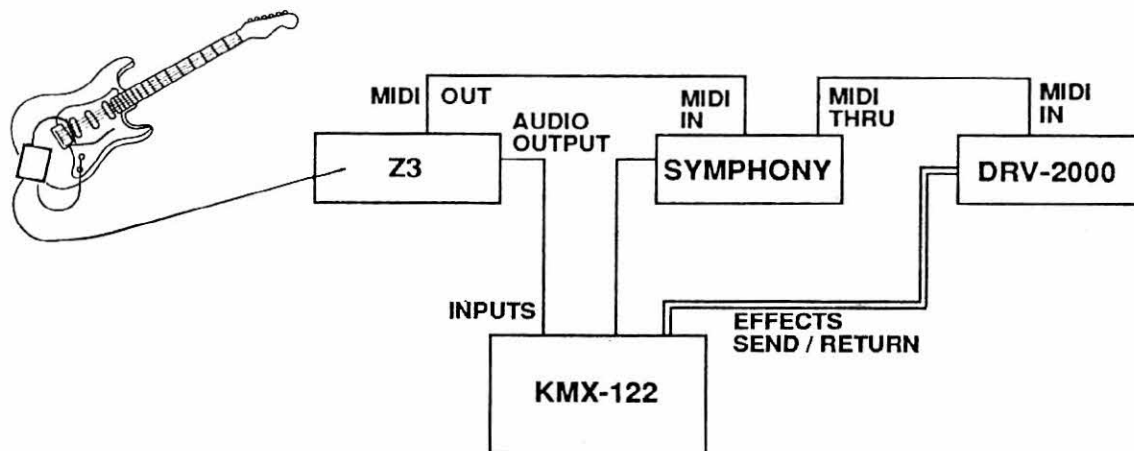

1. TRANSMITTED DATA

1-1 CHANNEL MESSAGES

Status	Second	Third	Description
1000 nnnn	0kkk kkkk	0100 0000	Note off kkk kkkk = 0~127 (+Transpose)
1001 nnnn	0kkk kkkk	0vzv vvvv	Note on kkk kkkk = 0~127 (+Transpose) vzv vvvv = 1~127
1011 nnnn	0000 0001	0vvv vvvv	Control Change 1 (*1) vzv vvvv = 0~127
	0000 0010	0vvv vvvv	Control Change 2 (*1) vzv vvvv = 0~127
	0000 0111	0vvv vvvv	Volume vzv vvvv = 0~127
	0100 0000	0000 0000 0111 1111	Damper off (*1) on (*1)
1100 nnnn	0ppp pppp	-----	Program Change (*2) ppp pppp = 0~127
1101 nnnn	0vvv vvvv	-----	After Touch (*1) vzv vvvv = 0~127
1110 nnnn	0uuu uuuu	0vvv vvvv	Pitch Bend 0vvv vvvv 0uuu uuuu = 0000h : - max = 4000h : center = 7F7Fh : + max

Note: nnnn = MIDI Channel Number (0~15)

(*1) Received data is output through each channel, as set by the transmitting device's MIDI OUT CHANNEL.

(*2) When several strings are set to the same MIDI OUT CHANNEL, the data of the smallest numbered string is output.

1-2 SYSTEM REAL TIME MESSAGES

Status	Description
1111 1110	Active Sensing

1-3 SYSTEM EXCLUSIVE MESSAGES I

Byte	Description
1111 0000	Exclusive Status
0111 1110	Channel
0CCC CCCC	
0000 0110	
0000 0010	
0100 0010	KORG ID
0001 1101	Z3 ID
0000 0000	
0000 0000	
ORRR RRRR	ROM No.
0000 0000	
0VVV VVVV	Program Version
0vvv vvvv	Hi
1111 0111	Low
	EOX

Note: Channel = Channel 0~15, 7Fh=all

ROM No. = 0~127

Program Version = 0VVV VVVV . 0vvv vvvv

* System Exclusive messages are sent over the set basic channel.

1-4 SYSTEM EXCLUSIVE MESSAGES II

Z3 SYSTEM EXCLUSIVE HEADER

- 1111 0000 (F0) : Exclusive Status
 - 0100 0010 (42) : KORG ID
 - 0011 nnnn (3n) : Format ID n = MIDI Channel Number (0~15)
 - 0001 1101 (1D) : Z3 ID
- * System Exclusive messages are sent over the set basic channel.

<<FUNCTION CODE LIST>>

ID	Description
40	Sound Parameter Dump (from Sound Edit Buffer)
4C	Sound Parameter All Dump (from Sound Memory)
49	Program Parameter Dump (from Program Edit Buffer)
4D	Program Parameter All Dump (from Program Memory)
5C	Patch Parameter Dump (from Patch Edit Buffer)
5D	Patch Parameter All Dump (from Patch Memory)
21	Write Completed
22	Write ERROR
23	Data Load Completed
24	Data Load ERROR
2B	Exclusive Format ERROR

(1) Sound Parameter Dump

Byte	Description
F0.42.3n.1D	EXCLUSIVE HEADER
0100 0000	Sound Parameter Dump
0odd dddd	data
:	(refer to
:	Sound Parameter Dump Data Format)
1111 0111	EOX

(2) Sound Parameter All Dump

Byte	Description
F0.42.3n.ID	EXCLUSIVE HEADER
0100 1100	Sound Parameter All Dump
0ddd dddd	data
:	(Refer to
:	Sound Parameter All Dump Data Format)
1111 0111	EOX

(3) Program Parameter Dump

Byte	Description
F0.42.3n.ID	EXCLUSIVE HEADER
0100 1001	Program Parameter Dump
0ddd dddd	data
:	(Refer to Program Parameter Dump Format)
1111 0111	EOX

(4) Program Parameter All Dump

Byte	Description
F0.42.3n.ID	EXCLUSIVE HEADER
0100 1101	Program Parameter All Dump
0ddd dddd	data
:	(Refer to
:	Program Parameter All Dump Format)
1111 0111	EOX

(5) Patch Parameter Dump

Byte	Description
F0.42.3n.ID	EXCLUSIVE HEADER
0101 1100	Patch Parameter Dump
0ddd dddd	data
:	(Refer to Patch Parameter Dump Format)
1111 0111	EOX

(6) Patch Parameter All Dump

Byte	Description
F0.42.3n.ID	EXCLUSIVE HEADER
0101 1101	Patch Parameter All Dump
0ddd dddd	data
:	(Refer to Patch Parameter All Dump Format)
1111 0111	EOX

(7) Write Completed

Byte	Description
F0.42.3n.ID	EXCLUSIVE HEADER
0010 0001	Write Completed
1111 0111	EOX

(8) Write Error

Byte	Description
F0.42.3n.ID	EXCLUSIVE HEADER
0010 0010	Write Error
1111 0111	EOX

(9) Data Load Completed

Byte	Description
F0.42.3n.ID	EXCLUSIVE HEADER
0010 0011	Data Load Completed
1111 0111	EOX

(10) Data Load Error

Byte	Description
F0.42.3n.ID	EXCLUSIVE HEADER
0010 0100	Data Load Error
1111 0111	EOX

(11) Exclusive Format Error

Byte	Description
F0.42.3n.ID	EXCLUSIVE HEADER
0010 0101	Exclusive Format Error
1111 0111	EOX

1-5 Exclusive Answer Message Table

ID	Received Message		Answer Message (Transmit Message)					
	Description		ID	21	22	23	24	26
10	Sound Parameter	Dump req	40					
1C	Program Parameter	All dump req	4C					
19	Program Parameter	Dump req	49					
1D	Patch Parameter	All dump req	4D					
0C	Sound Parameter	Dump req	5C					
0D	Program Parameter	All dump req	5D					
40	Sound Parameter	Dump	--					
41	Program Parameter	Change	--					
4C	Sound Parameter	All Dump	--					
49	Program Parameter	Dump	--					
59	Program Parameter	Change	--					
4D	Sound Parameter	All Dump	--					
5C	Program Parameter	Dump	--					
5D	Sound Parameter	All Dump	--					
11	Sound	Write Req	--					
0A	Program	Write Req	--					
0F	Patch	Write Req	--					

ID : 21 = Write Completed 22 = Write Error
 23 = Data Load Completed 24 = Data Load Error
 28 = Exclusive Format Error

2. REORGANIZED DATA
2.1 CHANNEL MESSAGES

Status	Second	Third	Description	g	s
1000 nnnn	0kkk kkkk	0*** ****	Note off	kkk kkkk = 0~127	①
1001 nnnn	0kkk kkkk	0000 0000	Note off	kkk kkkk = 0~127	①
1001 nnnn	0kkk kkkk	0vvv vvvv	Note on	vvv vvvv = 1~127	①
1011 nnnn	0000 0001	0ddd dddd	Control Change 1	ddd dddd = 0~127	③
	0000 0001	0ddd dddd	Control Change 2	ddd dddd = 0~127	③
	0000 0111	0ddd dddd	Volume	ddd dddd = 0~127	④
	0100 0000	0s** ****	Damper	s = off/on	③
	0100 0010	0s** ****	Sostenuto	s = off/on	⑤
	0111 1011	0000 0000	All Notes off	s = off/on	①
	0111 1100	0000 0000	Omni off (MIDI Reset)		②
	0111 1101	0000 0000	Omni on (MIDI Reset)		②
	0111 1110	0*** ****	(MIDI Reset)		②
	0111 1111	0000 0000	(MIDI Reset)		②
1100 nnnn	0ppp pppp	-----	Program Change (See Note 1)		③
1101 nnnn	0ddd dddd	-----	After Touch	ddd dddd = 0~127	③
1110 nnnn	0uuu uuuu	0vvv vvvv	Pitch Bend		⑦
			0vvv vvvv 0uuu uuuu = 0000h ; - max = 4000h ; center = 7FFFh ; + max		

Note : g :Guitar Synth mode s :Sound Generator mode

- nnnn = MIDI Channel Number (0~15) * * = Not specified
 Note 1:When Normal Play mode.
 When Patch Play mode.
 When Sound Generator mode.
 When MIDI OUT CHANNEL determines the MIDI channel over which data is received.
 (The channel set for string 1 is receives data in Poly Mode.) Therefore, it functions only in the OMNI OFF condition.
 (The MIDI OUT CHANNEL determines the MIDI channel over which data is received. (It does not affect internal operations or functions.)
- ① The MIDI OUT CHANNEL determines the MIDI channel over which data is received. (The channel set for string 1 is receives data in Poly Mode.) Therefore, it functions only in the OMNI OFF condition. (It serves as MIDI Reset function.)
 - ② Basic Channel(ch. no., OMNI on/off) determines the MIDI channel over which data is received. (The received data is handled the same as the Volume of ZDS.)
 - ③ Basic Channel(ch. no., OMNI on/off) determines the MIDI channel over which data is received. (The received data is handled the same as the Hold SW.)
 - ④ Basic Channel(ch. no., OMNI on/off) determines the MIDI channel over which data is received. (It does not affect internal operations or functions.)
 - ⑤ Basic Channel(ch. no., OMNI on/off) determines the MIDI channel over which data is received. (The received data is added to the data of each channel of the instrument, and includes all the strings.)
 - ⑥ Basic Channel(ch. no., OMNI on/off) determines the MIDI channel over which data is received. (It serves as MIDI Reset function.)

2.2 SYSTEM REAL TIME MESSAGES

Status	Description
1111 1110	Active Sensing

2-3 SYSTEM EXCLUSIVE MESSAGES I

(1)DEVICE ID Req

Byte	Description
1111 0000	Exclusive Status
0111 1110	Channel
0000 0000	Channel
0000 0001	Channel
1111 0111	EOX

Note: Channel = Channel 0~15, 7Fh=all

* System Exclusivemessages are sent over the set basic channel.

2-4 SYSTEM EXCLUSIVE MESSAGES II

FCB SYSTEM EXCLUSIVE HEADER

1111 0000 (F0) : Exclusive Status
 0100 0010 (42) : KORG ID
 0011 nnnn (3n) : Format ID n = MIDI Channel Number (0~15)
 0010 0001 (21) : FCB ID
 0100 1101 (4D) : SW Message

(1)Hold sw control

Byte	Description
F0.42.3n.21.4D	EXCLUSIVE HEADER
0010 0100	hold sw ID
0s** ****	data
1111 0111	EOX

Note: * * = Not specified s = off/on

(2)Synth off sw control

Byte	Description
F0.42.3n.21.4D	EXCLUSIVE HEADER
0010 0101	Synth off sw ID
0s** ****	data
1111 0111	EOX

Note: * * = Not specified s = off/on

2-5 SYSTEM EXCLUSIVE MESSAGES III

23 SYSTEM EXCLUSIVE HEADER

1111 0000 (F0) : Exclusive Status
 0100 0010 (42) : KORG ID
 0011 nnnn (3n) : Format ID n = MIDI Channel Number (0~15)
 0001 1101 (1D) : Z3 ID

* System Exclusive messages are sent over the set basic channel.

《FUNCTION CODE LIST》

ID	Description
40	Sound Parameter Dump (to Sound Edit Buffer)
10	Sound Parameter Dump Req.
41	Sound Parameter Change (to Sound Edit Buffer)
4C	Sound Parameter All Dump (to Sound Memory)
1C	Sound Parameter All Dump Req.
11	Sound Write Req
49	Program Parameter Dump (to Program Edit Buffer)
19	Program Parameter Dump Req.
59	Program Parameter Change (to Program Edit Buffer)
4D	Program Parameter All Dump (to Program Memory)
1D	Program Parameter All Dump Req.
0A	Program Write Req
5C	Patch Parameter Dump (to Patch Edit Buffer)
0C	Patch Parameter Dump Req.
5D	Patch Parameter All Dump (to Patch Memory)
0D	Patch Parameter All Dump Req.
0F	Patch Write Req

(4) Sound Parameter All Dump

Byte	Description
F0.42.3n.1D	EXCLUSIVE HEADER
0100 1100	Sound Parameter All Dump 4Ch
0ddd dddd	data
:	(Refer to
:	Sound Parameter All Dump Format)
1111 0111	EOX

(5) Sound Parameter All Dump Req.

Byte	Description
F0.42.3n.1D	EXCLUSIVE HEADER
0001 1100	Sound Parameter All Dump Req. 1Ch
1111 0111	EOX

(6) Sound Write Req

Byte	Description
F0.42.3n.1D	EXCLUSIVE HEADER
0001 0001	Sound Write 11h
Usss ssss	Write Sound no.
1111 0111	EOX

(7) Program Parameter Dump

Byte	Description
F0.42.3n.1D	EXCLUSIVE HEADER
0100 1001	Program Parameter Dump 49h
0ddd dddd	data
:	(Refer to Program Parameter Dump Format)
:	
1111 0111	EOX

(8) Program Parameter Dump Req.

Byte	Description
F0.42.3n.1D	EXCLUSIVE HEADER
0001 1001	Program Parameter Dump Req. 19h
1111 0111	EOX

(9) Program Parameter Change

Byte	Description
F0.42.3n.1D	EXCLUSIVE HEADER
0101 1001	Program Parameter Change 59h
0nnn nnnn	Parameter no. (Refer to
0ddd dddd	data
1111 0111	EOX

(10) Program Parameter All Dump

Byte	Description
F0.42.3n.1D	EXCLUSIVE HEADER
0100 1101	Program Parameter All Dump 4Dh
0ddd dddd	data
:	(Refer to
:	Program Parameter All Dump Format)
1111 0111	EOX

(1) Sound Parameter Dump

Byte	Description
F0.42.3n.1D	EXCLUSIVE HEADER
0100 0000	Sound Parameter Dump 40h
0ddd dddd	data
:	(Refer to Sound Parameter Dump Format)
:	
1111 0111	EOX

(2) Sound Parameter Dump Req.

Byte	Description
F0.42.3n.1D	EXCLUSIVE HEADER
0001 0000	Sound Parameter Dump Req. 10h
1111 0111	EOX

(3) Sound Parameter Change

Byte	Description
F0.42.3n.1D	EXCLUSIVE HEADER
0100 0001	Sound Parameter Change 41h
0nnn nnnn	Parameter no. (Refer to
0hhh hhhh	data hi byte
0111 1111	data low byte(
1111 0111	EOX

(11) Program Parameter All Dump Req.

Byte	Description
F0.42.3n.1D	EXCLUSIVE HEADER
0001 1101	Program Parameter All Dump Req. 1Dh
1111 0111	EOX

(12) Program Write Req

Byte	Description
F0.42.3n.1D	EXCLUSIVE HEADER
0000 1010	Program Write
0sss ssss	Write Program no.
1111 0111	EOX

(13) Patch Parameter Dump

Byte	Description
F0.42.3n.1D	EXCLUSIVE HEADER
0101 1100	Patch Parameter Dump
0ddd dddd	data
:	(Refer to Patch Parameter Dump Format)
1111 0111	EOX

(14) Patch Parameter Dump Req.

Byte	Description
F0.42.3n.1D	EXCLUSIVE HEADER
0000 1100	Patch Parameter Dump Req.
1111 0111	EOX

(15) Patch Parameter All Dump

Byte	Description
F0.42.3n.1D	EXCLUSIVE HEADER
0101 1101	Patch Parameter All Dump
0ddd dddd	data
:	(Refer to Patch Parameter All Dump Format)
1111 0111	EOX

(16) Patch Parameter All Dump Req.

Byte	Description
F0.42.3n.1D	EXCLUSIVE HEADER
0000 1101	Patch Parameter All Dump Req.
1111 0111	EOX

(17) Patch Write Req

Byte	Description
F0.42.3n.1D	EXCLUSIVE HEADER
0000 1111	Patch Write Req.
0000 0bbb	Write Bank no.
1111 0111	EOX

【Program Parameter Change Data Format】

1st data	00nn nnaa : Parameter no. (0~54)
2nd data	0ddd dddd : Data

See 《Program Parameter List》

《Program Parameter List》

no.	name	data
0	Reverb	0000 000R
no. +0: str 1	+1: str 2	+2: str 3
+3: str 4	+4: str 5	+5: str 6
no.	name	data
1 ~ 6	Hold	0000 000H
	0 : off	
	1 : on	
7 ~ 12	MIDI Channel	000C CCCC
	0 : MIDI out off	
	1 ~ 16 : MIDI ch. 1 ~ 16	
13 ~ 18	Program Change req.	0PPP PPPP
	0 ~ 127 : no. 1 ~ 128	
19 ~ 24	Sound No.	0SSS SSSS
	0 ~ 127 : no. 1 ~ 128	
25 ~ 30	Velocity Curve	0000 0VVV
	0 ~ 7 : mode 1 ~ 8	
31 ~ 36	Bend Range	0000 BBBB
	0 : Chromatic	
	1 ~ 12 : Bend Range	
37 ~ 42	Transpose	000T TTTT
	0 : -12 note (-oct)	
	12 : non Transpose	
	24 : +12 note (+oct)	
43 ~ 48	Sensitivity	0000 0LLL
	0 ~ 7 : 1 ~ 8	
49 ~ 54	Out Level	0000 0ooo

【Program Parameter Dump Data Format】

1st data	Parameter no. 0	data	(Reverb
2nd data	1	data	str 1)
3rd data	2	data	(Hold
4th data	3	data	(str 2)
5th data	4	data	(str 3)
6th data	5	data	(str 4)
7th data	6	data	(str 5)
8th data	7	data	(str 6)
9th data	8	data	(MIDI Ch.
10th data	9	data	(str 1)
11th data	10	data	(str 2)
12th data	11	data	(str 3)
13th data	12	data	(str 4)
14th data	13	data	(str 5)
15th data	14	data	(str 6)
16th data	15	data	(Prog. C. R
:	:	:	(str 1)
:	:	:	(str 2)
:	:	:	(str 3)
55th data	Parameter no. 54	data	(S. Level
:	:	:	str 6)

【Program Parameter All Dump Data Format】

1st data	Memory no.	0	(dddd ****)	→ (0000 dddd)
2nd data	0	0	(**** dddd)	→ (0000 dddd)
3rd data	1	1	(dddd ****)	→ (0000 dddd)
4th data	1	1	(**** dddd)	→ (0000 dddd)
:	:	:	:	:
:	:	:	:	:
11007th data	Memory no.	5503	(dddd ****)	→ (0000 dddd)
11008th data	5503	5503	(**** dddd)	→ (0000 dddd)

See 【Program Memory Data Format】

【Program Edit Buffer Data Format】

no.	Bit	String	Bit	String	Program
0	ORHH UHHH	all			1
1	CCCC CCCC	1			
2	CCCC CCCC	2			
3	CCCC CCCC	3			
4	CCCC CCCC	4			
5	CCCC CCCC	5			
6	CCCC CCCC	6			
7	OPPP PPPP	1			
8	OPPP PPPP	2			
9	OPPP PPPP	3			
10	OPPP PPPP	4			
11	OPPP PPPP	5			
12	OPPP PPPP	6			
13	SSSS SSSS	1			
14	SSSS SSSS	2			
15	SSSS SSSS	3			
16	SSSS SSSS	4			
17	SSSS SSSS	5			
18	SSSS SSSS	6			
19	OVVV BBBB	1			
20	OVVV BBBB	2			
21	OVVV BBBB	3			
22	OVVV BBBB	4			
23	OVVV BBBB	5			
24	OVVV BBBB	6			
25	TTTT TTTT	1			
26	TTTT TTTT	2			
27	TTTT TTTT	3			
28	TTTT TTTT	4			
29	TTTT TTTT	5			
30	TTTT TTTT	6			
31	0000 0LLL	1			
32	0000 0LLL	2			
33	0000 0LLL	3			
34	0000 0LLL	4			
35	0000 0LLL	5			
36	0000 0LLL	6			
37	0000 0000	1			
38	0000 0000	2			
39	0000 0000	3			
40	0000 0000	4			
41	0000 0000	5			
42	0000 0000	6			

R :Reverb off:0 on:1
H :Hold off:0 on:1
 bit 0~5 : string 1~6
C :MIDI channel
 1111111B = disable
 0~15 = ch. 1~16
P :Program change req.
 0 ~ 127 = 0 ~ 127
S :Sound No.
 0 ~ 127 = 0 ~ 127
V :Velocity curve
 0 = curve 1 4 = curve 5
 1 = curve 2 5 = curve 6
 2 = curve 3 6 = curve 7
 3 = curve 4 7 = curve 8
B :Bend Range
 0 =Chromatic mode
 1 = +/-120cent:bend max/min
 2 = 1100
 3 = 1000
 4 = 900
 5 = 800
 6 = 700
 7 = 600
 8 = 500
 9 = 400
 10 = 300
 11 = 200
 12 = 100
T :Transpose -12 ~ +12
L :Sensitivity
 0~7 = 1~8
o :Out level 0~15

【Program Memory Data Format】

no.	Bit	String	Program
0	ORHH UHHH	all	1
1	CCCC CCCC	1	
2	CCCC CCCC	2	
3	CCCC CCCC	3	
4	CCCC CCCC	4	
5	CCCC CCCC	5	
6	CCCC CCCC	6	
7	OPPP PPPP	1	
8	OPPP PPPP	2	
9	OPPP PPPP	3	
10	OPPP PPPP	4	
11	OPPP PPPP	5	
12	OPPP PPPP	6	
13	SSSS SSSS	1	
14	SSSS SSSS	2	
15	SSSS SSSS	3	
16	SSSS SSSS	4	
17	SSSS SSSS	5	
18	SSSS SSSS	6	
19	OVVV BBBB	1	
20	OVVV BBBB	2	
21	OVVV BBBB	3	
22	OVVV BBBB	4	
23	OVVV BBBB	5	
24	OVVV BBBB	6	
25	TTTT TTTT	1	
26	TTTT TTTT	2	
27	TTTT TTTT	3	
28	TTTT TTTT	4	
29	TTTT TTTT	5	
30	TTTT TTTT	6	
31	0000 0LLL	1	
32	0000 0LLL	2	
33	0000 0LLL	3	
34	0000 0LLL	4	
35	0000 0LLL	5	
36	0000 0LLL	6	
37	0000 0000	1	
38	0000 0000	2	
39	0000 0000	3	
40	0000 0000	4	
41	0000 0000	5	
42	0000 0000	6	
43	:		2
:	:		:
:	:		127
5460			
5461			128
5503			

【Patch Parameter Dump Data Format】

Data Number	Data	Patch
1st data	Oddd dddd	1
2nd data	Oddd dddd	2
3rd data	Oddd dddd	3
4th data	Oddd dddd	4
5th data	Oddd dddd	5
6th data	Oddd dddd	6
7th data	Oddd dddd	7
8th data	Oddd dddd	8

See 【Patch Edit Buffer Data Format】

【Patch Parameter All Dump Data Format】

Data Number	Data	Bank	Patch
1st data	Oddd dddd	1	1
2nd data	Oddd dddd	1	2
3rd data	Oddd dddd	1	3
4th data	Oddd dddd	1	4
5th data	:	1	5
6th data	:	1	6
7th data	:	1	7
8th data	:	1	8
9th data	:	2	1
10th data	:	2	2
:	:	2	3
:	:	2	4
:	:	:	:
:	:	:	:
:	:	:	:
:	:	:	:
63rd data	Oddd dddd	8	7
64th data	Oddd dddd	8	8

See 【Patch Memory Data Format】

【Patch Edit Buffer Data Format】

no.	Bit	Patch
0	0*** ****	1
1	0*** ****	2
2	0*** ****	3
3	0*** ****	4
4	0*** ****	5
5	0*** ****	6
6	0*** ****	7
7	0*** ****	8

Note: 0*** **** : 0~127 = Program no. 1~128

【Patch Memory Data Format】

no.	Bit	Patch	Bank
0	0*** ****	1	1
1	0*** ****	2	
2	0*** ****	3	
3	0*** ****	4	
4	0*** ****	5	
5	0*** ****	6	
6	0*** ****	7	
7	0*** ****	8	
8	:	:	2
15	:	:	
16	:	:	3
23	:	:	
24	:	:	4
31	:	:	
32	:	:	5
39	:	:	
40	:	:	6
47	:	:	
48	:	:	7
55	:	:	
56	0*** ****	1	8
57	0*** ****	2	
58	0*** ****	3	
59	0*** ****	4	
60	0*** ****	5	
61	0*** ****	6	
62	0*** ****	7	
63	0*** ****	8	

Note: 0*** **** : 0~127 = Program no. 1~128

【Sound Parameter Change Data Format】

1st data	0ddd dddd	Parameter no	(0~87)
2nd data	0ddd dddd	Data hi byte	
3rd data	0ddd dddd	low byte	(Only LFO Rate)

See 《Sound Parameter List》

《Sound Parameter List》

no.	name	1st	data	range	hi - byte	low - byte
0	Voice Name	1st	0nnn nnnn	ASCII	0nnn nnnn	-----
1		2nd	0nnn nnnn		0nnn nnnn	-----
2		3rd	0nnn nnnn		0nnn nnnn	-----
3		4th	0nnn nnnn		0nnn nnnn	-----
4		5th	0nnn nnnn		0nnn nnnn	-----
5		6th	0nnn nnnn		0nnn nnnn	-----
6		7th	0nnn nnnn		0nnn nnnn	-----
7		8th	0nnn nnnn		0nnn nnnn	-----
8	Algorithm		0000 0ccc	0~7	0000 0ccc	-----
9	Feed Back		0000 0fff	0~7	0000 0fff	-----
10	LFO Wave Form		0000 00ww	0~3	0000 00ww	-----
11	Rate		0LLL LLLL	0~255	0000 000H	01,LL LLLL
12	PHD		0ppp pppp	0~127	0ppp pppp	-----
13	PMS		0000 0PPP	0~7	0000 0PPP	-----
14	AMD		0aaa aaaa	0~127	0aaa aaaa	-----
15	AMS		0000 00AA	0~3	0000 00AA	-----
no.	+0 : (M-1)	11 : (C-1)	12 : (M-2)	13 : (C-2)		
no.	name		data	range	hi - byte	low - byte
15~19	OSC Wave Form		0000 0SSS	0~7	0000 0SSS	-----
20~23	Mu11		0000 mmmm	0~15	0000 mmmm	-----
24~27	Mu12		0000 MMMM	0~15	0000 MMMM	-----
28~31	Detune1		0000 0ddd	0~7	0000 0ddd	-----
32~35	Detune2		0000 00DD	0~3	0000 00DD	-----
36~39	Total Level		0ttt tttt	0~127	0ttt tttt	-----
40~43	Attack Rate		000a aaaa	0~31	000a aaaa	-----
44~47	Decay1 Rate		000d dddd	0~31	000d dddd	-----
48~51	Sustain Level		0000 ssss	0~15	0000 ssss	-----
52~55	Decay2 Rate		000D DDDD	0~31	000D DDDD	-----
56~59	Release Rate		0000 RRRR	0~15	0000 RRRR	-----
60~63	Key Scale		0000 00kk	0~3	0000 00kk	-----
64~67	AMS Enable		0000 000E	0, 1	0000 000E	-----
68~71	EG, Shift		0000 00ss	0~3	0000 00ss	-----
72~75	Reverb Level		0000 00UL	0, 1	0000 00UL	-----
76~79	Reverb Level Rate		0000 0RRR	0~7	0000 0RRR	-----
80~83	Velocity Int		0000 VVVV	0~15	0000 VVVV	-----
84~87	Keyboard Track		0000 KKKK	0~15	0000 KKKK	-----

【Sound Parameter Dump Data Format】

1st data	Parameter no	0	data	(voice Name 1st)
2nd data	1	data	(2nd)	
3rd data	2	data	(3rd)	
4th data	3	data	(4th)	
5th data	4	data	(5th)	
6th data	5	data	(6th)	
7th data	6	data	(7th)	
8th data	7	data	(8th)	
9th data	8	data	(Algorithm)	
10th data	9	data	(Feed Back)	
11th data	10	data	(LFO Waveform)	
12th data	11	hi -data	(LFO Rate hi)	
13th data	11	low-data	(low)	
:	:	:	:	:
:	:	:	:	:
89th data	Parameter no. 87	data	(Keyboard Track C-2)	

See 【Sound Edit Buffer Data Format】

【Sound Parameter All Dump Data Format】

1st data	Memory no.	0	(dddd ****) → (0000 dddd)
2nd data	0	(**** dddd) → (0000 dddd)	
3rd data	1	(dddd ****) → (0000 dddd)	
4th data	1	(**** dddd) → (0000 dddd)	
:	:	:	:
:	:	:	:
12799th data	Memory no.	5399	(dddd ****) → (0000 dddd)
12800th data	5399	(**** dddd) → (0000 dddd)	

See 【Sound Memory Data Format】

【Sound Edit Buffer Data Format】

no.	Bit	Oper	Notes
0~7	0nnn nnnn	n :Voice Name	ASCII
8	FFFF FFFF	F :LFO Rate	0~255
9	IPPP PPPP	P :PMD	0~127
10	0AAA AAAA	A :AMD	0~127
11	0000 0000	W :LFO Wave Form	0~3
12	00ff FCCC	f :Feed Back	0~7 C :Algorithm 0~7
13	0ppp 00aa	p :PMS	0~7 a :AMS 0~3
14	0DDD DDDD	M-1	D :Detune1 0~7
15	0DDD DDDD	M-2	M :MUL1 0~15
16	0DDD DDDD	C-1	
17	0DDD DDDD	C-2	
18	ISSS mmm	M-1	S :OSC Wave Form 0~7
19	ISSS mmm	M-2	m :MUL2 0~15
20	ISSS mmm	C-1	
21	ISSS mmm	C-2	
22	0TTT TTTT	M-1	T :Total Level 0~127
23	0TTT TTTT	M-2	
24	0TTT TTTT	C-1	
25	0TTT TTTT	C-2	
26	KKOA AAAA	M-1	K :Key Scale 0~3
27	KKOA AAAA	M-2	A :Attack Rate 0~31
28	KKOA AAAA	C-1	
29	KKOA AAAA	C-2	
30	E00D DDDD	M-1	E :AMS Enable 0.1
31	E00D DDDD	M-2	D :Decay 1 Rate 0~31
32	E00D DDDD	C-1	
33	E00D DDDD	C-2	
34	DD0d dddd	M-1	D :Detune2 0~3
35	DD0d dddd	M-2	d :Decay 2 Rate 0~31
36	DD0d dddd	C-1	
37	DD0d dddd	C-2	
38	EE10 Lrrr	M-1	E :EG. Shift 0~3
39	EE10 Lrrr	M-2	L :Reverb Level 0.1
40	EE10 Lrrr	C-1	r :Reverb Rate 0~7
41	EE10 Lrrr	C-2	
42	LLLL RRRR	M-1	L :Sustain Level 0~15
43	LLLL RRRR	M-2	R :Release Rate 0~15
44	LLLL RRRR	C-1	
45	LLLL RRRR	C-2	
46	VVVV KKKK	M-1	V :Velocity Intensity 0~15
47	VVVV KKKK	M-2	K :Keyboard Track 0~15
48	VVVV KKKK	C-1	
49	VVVV KKKK	C-2	

【Sound Memory Data Format】

no.	Bit	Oper	Notes	Sound
0~7	0nnn nnnn	n :Voice Name	ASCII	1
8	FFFF FFFF	F :LFO Rate	0~255	
9	IPPP PPPP	P :PMD	0~127	
10	0AAA AAAA	A :AMD	0~127	
11	0000 0000	W :LFO Wave Form	0~3	
12	00ff FCCC	f :Feed Back	0~7 C :Algorithm 0~7	
13	0ppp 00aa	p :PMS	0~7 a :AMS 0~3	
14	0DDD DDDD	M-1	D :Detune1 0~7	
15	0DDD DDDD	M-2	M :MUL1 0~15	
16	0DDD DDDD	C-1		
17	0DDD DDDD	C-2		
18	ISSS mmm	M-1	S :OSC Wave Form 0~7	
19	ISSS mmm	M-2	m :MUL2 0~15	
20	ISSS mmm	C-1		
21	ISSS mmm	C-2		
22	0TTT TTTT	M-1	T :Total Level 0~127	
23	0TTT TTTT	M-2		
24	0TTT TTTT	C-1		
25	0TTT TTTT	C-2		
26	KKOA AAAA	M-1	K :Key Scale 0~3	
27	KKOA AAAA	M-2	A :Attack Rate 0~31	
28	KKOA AAAA	C-1		
29	KKOA AAAA	C-2		
30	E00D DDDD	M-1	E :AMS Enable 0.1	
31	E00D DDDD	M-2	D :Decay 1 Rate 0~31	
32	E00D DDDD	C-1		
33	E00D DDDD	C-2		
34	DD0d dddd	M-1	D :Detune2 0~3	
35	DD0d dddd	M-2	d :Decay 2 Rate 0~31	
36	DD0d dddd	C-1		
37	DD0d dddd	C-2		
38	EE10 Lrrr	M-1	E :EG. Shift 0~3	
39	EE10 Lrrr	M-2	L :Reverb Level 0.1	
40	EE10 Lrrr	C-1	r :Reverb Rate 0~7	
41	EE10 Lrrr	C-2		
42	LLLL RRRR	M-1	L :Sustain Level 0~15	
43	LLLL RRRR	M-2	R :Release Rate 0~15	
44	LLLL RRRR	C-1		
45	LLLL RRRR	C-2		
46	VVVV KKKK	M-1	V :Velocity Intensity 0~15	
47	VVVV KKKK	M-2	K :Keyboard Track 0~15	
48	VVVV KKKK	C-1		
49	VVVV KKKK	C-2		
50	:	:	:	2
99	:	:	:	3
100	:	:	:	3
149	:	:	:	4
150	:	:	:	4
199	:	:	:	4
200	:	:	:	5
6349	:	:	:	5
6350	:	:	:	128
6399	:	:	:	128

GLOSSARY

channel: In MIDI, 16 channels are available for data transmission/reception. As on a TV set, a MIDI device can be set to receive (or send) only messages of the selected channel. In this way, one MIDI controller such as a Q1 MIDI Workstation (on which stored MIDI data can be assigned to a number of different MIDI channels) can be used to independently control up to sixteen MIDI devices.

global: Affecting all operations. A global parameter on the Z3, such as reverb in the Edit Mode, has one setting that controls or affects all of the strings.

initialize: To reset the parameters of a device to zero or to a predetermined basic setting.

master: Any device (such as a keyboard, sequencer, or the Z3) that controls another device (the slave). The Z3, therefore, always functions as a master, by sending MIDI signals to a connected MIDI synthesizer or module (except when in the SOUND GENERATOR MODE, in which case the Z3 becomes the slave).

message: Any group of MIDI data that is sent or received within a MIDI system to initiate a selected function or to achieve a particular effect (e.g., pitch bend, program change, etc.).

MIDI: Musical Instrument Digital Interface. A worldwide standard digital "language" permitting digital information to be transmitted from one synthesizer to another, or between synthesizers, sequencers, drum machines, computers, etc.

MIDI IN: A MIDI terminal on a MIDI device, that receives MIDI data transmitted from an external MIDI device. For example, the MIR Music Work Station Module has a MIDI IN terminal to which you can connect the Z3, allowing you to use the Z3 to play the programs of the MIR.

MIDI OUT: A MIDI terminal on a MIDI device that transmits MIDI data. The Z3 is capable of sending MIDI data over its MIDI OUT terminal for control of additional MIDI sound sources and other devices.

MIDI THRU: A MIDI terminal on a MIDI device that relays, unchanged, the data received at its MIDI IN terminal. This enables you to connect several MIDI devices together in a "daisy chain" configuration, permitting a number of MIDI devices to be controlled by one master MIDI device such as the Z3.

mode: The manner in which a device is currently operating. In MIDI operation there are four modes, which describe how devices respond to data, are *omni on/poly*, *omni on/mono*, *omni off/poly*, and *omni off/mono*. When *omni* is on, the device responds to MIDI data arriving on any channel. When *omni* is off, it only responds to data arriving on the set channel. When *poly* is on, the device will play the maximum number of simultaneous notes (usually 16). When *mono* is on, it will play only one note at a time. Mode can also be used to describe a general category of synthesizer operation, such as the Patch Play Mode of the Z3.

module: A sound-generating device, usually a synthesizer or a sampler, without a keyboard. The sounds of a module cannot be played except through control from a connected MIDI device.

monophonic: Also called *mono*. Capable of producing only one note at a time.

note off: A MIDI message indicating the end of a note. This message is sent whenever a key is released on a MIDI keyboard. On the Z3, a Note Off message is sent when a played note or string is released. If the MIDI sound source has been programmed with a long "release" time, the note will continue and fade out, after the note off message is received.

note on: A MIDI message indicating the start of a note. This message is sent whenever a key is pressed on a MIDI keyboard. On the Z3, a Note On message is sent when the Pickup detects sound from a string.

note on sensitivity: The degree to which the synthesizer responds to playing of the strings.

parameter: An aspect of a synthesizer's sound that can be changed. Some parameters (called function parameters) can be changed while playing, whereas others can only be programmed to be a permanent part of the sound. Some examples of the parameters of the Z3 include "Bend Range," "Transpose," and "MIDI Channel."

patch: Regarding the Z3, Patch refers to a preset memory location (one of eight in a Bank) to which one of the 128 Programs can be stored for easy recall. In conventional synthesizer terminology, patch is synonymous with the noun "program" (as in a "violin patch," for example).

polyphonic: Also called poly. Capable of producing more than one note at a time. The Z3 is a typical MIDI polyphonic instrument in that it can produce up to 16 notes simultaneously. Although, for obvious reasons, only 6 notes can be played at any one time on the Z3, other notes may be required to sustain at the same time (for example, when playing strings again while holding a strummed chord), hence the need for more than 6 simultaneous notes. Also, when using a sequencer such as the Q1 MIDI Workstation to play the Z3, up to 16 independent melody lines could be transmitted, enabling performance of 16-part orchestral arrangements.

program: (verb) A general term meaning to set parameter values in a MIDI instrument, in order to create a voice, select MIDI receive/transmit settings, etc.

program: (noun) A synthesizer sound or preset. Used often in referring to general instrument categories: a "strings" program, an "organ" program, etc.

setting: The number or value to which a parameter has been programmed.

sequencer: A device that records MIDI events, much the way a tape recorder records sounds. Unlike tape recording, however, sequencers record MIDI data, not sound.

slave: Any device (synthesizer, drum machine, etc.) that is being controlled by another device called a master. The MIR Music Work Station Module is a typical example of a slave — it has no keyboard or other controller, and is basically a sound-generating device which can be played by an external master controller such as the Z3.

timbre: Regarding the Z3, timbre is synonymous with internal program.

velocity: The speed with which a key, drum pad, or string is hit. Velocity data is sent with all MIDI Note On messages.

velocity curve: Determines the relationship between playing strength and output level. If playing strength and output level have a 1:1 relationship, the velocity curve is a straight line; the output level rises in direct proportion to how strongly the strings are played. Other curves are possible, however. For example, a velocity curve could be set in which the output level would be high for most playing strengths and would decrease only when playing at the absolute minimum strength.

SPECIFICATIONS

ZD3 GUITAR SYNTHESIZER DRIVER

Controls	Synthesizer master volume control Program DOWN/UP keys Gain adjust dials for strings 1 through 6
Indicator	Peak LED
Connectors	Guitar input jack 24-pin connector

Z3 GUITAR SYNTHESIZER

Method:	Divided Pickup
Sound Source:	6 voice Digital
Number of Program:	128
Number of Set Program:	128 (Mode B)
Effector:	Digital Reverb 16-bit
Tuner:	Digital Chromatic Tuner Calibration 438~445 Hz
Front Panel:	GUITAR INPUT REMOTE INPUT PHONES VOLUME
Rear Panel:	OUTPUT L/MONO OUTPUT R GUITAR OUTPUT PEDAL SW JACK MIDI IN MIDI OUT
Power Requirements:	24W
Weight:	4.5 Kg 9 lbs 14 oz
Dimensions:	482(W) x 332.5(D) x 44(H) mm 19(W) x 13.3(D) x 1.7(H) inch
Options:	ZD3 (divided pickup) FC-6, PS-1, PS-2

FUNCTION		Transmitted	Recognized	Remarks
Basic Channel	Default Changed	1 ~ 16 1 ~ 16	1 ~ 16 1 ~ 16	Memorized
Mode	Default Messages Altered	3 × *****	1 ○ OMNI ON/OFF ×	Only MODE 1.3
Note Number:	True Voice	0 ~ 127 *****	0 ~ 127 13 ~ 108	※ 1, 2
Velocity	Note on Note off	○ 9n. V=1 ~ 127 ×	○ 9n. V=1 ~ 127 ×	※ 1, 2
After Touch	Key's Ch's	× ○	× ○	※ 3
Pitch Bender		○	○	
Control Change	1 2 7 64 66	○ ○ ○ ○ ×	○ ○ ○ ○ ○	Modulation 1 ※ 3 Modulation 2 ※ 3 Main Volume ※ 2 Damper ※ 3 Sostenuto ※ 4
Program Change:	True#	○ 0 ~ 127 *****	○ 0 ~ 127 1 ~ 128	
System Exclusive		○	○	
System Common	:Song Pos :Song Sel :Tune	× × ×	× × ×	
System Real Time	:Clock :Commands	× ×	× ×	
Aux Messages	:Local ON/OFF :All Notes Off :Active Sense :Reset	× × ○ ×	× ○ ○ ×	※ 1
Notes: ※ 1 When in the Sound Generator Mode, receive is possible. ※ 2 When in the Synth Mode, transmit is possible. ※ 3 When in the Synth Mode, data is transmitted according to the individual setting of each string. ※ 4 When in the Synth Mode, receive is possible.				

Mode 1: OMNI ON, POLY Mode 2: OMNI ON, MONO
 Mode 3: OMNI OFF, POLY Mode 4: OMNI OFF, MONO

○ : Yes
 × : No

NOTICE

Korg products are manufactured under strict specifications and voltages required by each country. These products are warranted by the Korg distributor only in each country. Any Korg product not sold with a warranty card or carrying a serial number disqualifies the product sold from the manufacturer's/distributor's warranty and liability. This requirement is for your own protection and safety.

KORG[®] KORG INC.

15-12, Shimotakaido 1-chome, Suginami-ku, Tokyo, Japan.

1989 © KORG INC.

0101 CBH *Printed in Japan*

Ⓔ