

KORG

Music Workstation

MIR

OWNER'S MANUAL

OPERATION

PROGRAM

EDIT
PROGRAM

EFFECT
PARAMETER

COMBINATION

EDIT
COMBINATION

SEQUENCER

GLOBAL

MIDI EXCLUSIVE

ERROR
MESSAGE

ai AI Synthesis System

Congratulations and thank you for purchasing the Korg Music Work Station M1R. Please read this manual carefully to obtain optimum performance and help assure long term reliability.

PRECAUTIONS

ENVIRONMENT

Avoid using this unit in environments where it will be exposed to the following conditions:

- * Direct sunlight
- * High temperature or humidity
- * Dust or sand
- * Excessive vibration

POWER SUPPLY

Use this unit only with the rated AC voltage. If you intend to use this unit in areas where the voltage is different from the rated AC voltage, consult your KORG dealer about a suitable voltage transformer unit.

INTERFERENCE WITH OTHER APPLIANCES

This unit uses microprocessor circuitry that may cause interference with nearby radio or TV receivers. If problems occur, use at a greater distance from the radio or TV.

HANDLE GENTLY

Although this unit is designed and constructed to KORG's high standards, the use of excessive force may cause damage to its keys and knobs.

CLEANING

Use only a soft, dry cloth to clean the exterior of this unit. Never use benzene, volatile cleaners or solvents, polish or cleaning compounds.

WARRANTY PROCEDURE

The product warranty ensures that all repairs conducted within one year from the day of purchase are free of charge, but if the necessary steps were not taken in filling out the warranty card at the time of purchase, portions or all of the warranty may be invalid. Make certain to fill out the warranty card completely at the store where the instrument was purchased and keep the card in a safe place.

OWNER'S MANUAL

The M1R is a sophisticated digital music device with many functions. Therefore, we suggest that you keep this manual handy at all times, for reference.

CONTENTS

Precautions.....	1
Front/Rear Panels.....	4
BASIC OPERATION.....	6
Structure of the M1R	6
AI Synthesis.....	6
Keys & controls.....	9
Setting Up.....	11
How to Play Combinations.....	11
How to Play Programs.....	12
How to Operate the Sequencer	14
How to Record with the Sequencer	14
Sound Making Process	15
Internal Memory Allocation.....	16
Memory Card Format	16
MODES & FUNCTIONS.....	17
How to Read the Display Page Chart.....	17
1 - PROGRAM MODE.....	18
Editing in the Program Mode	18
2 - EDIT PROGRAM MODE	20
Structure of the M1R's Program Parameters.....	20
Functions in the Edit Program Mode.....	21
Editing in the Edit Program Mode	22
3 - EFFECT PARAMETERS	36
Effect Placement.....	36
Names of the Effect Types and an Outline of their Parameters	40
Reverb.....	40
Early Reflection.....	41
Delay.....	42
Chorus.....	43
Flanger.....	44
Phase Shift.....	45
Tremolo	46
Equalizer	47
Overdrive.....	48
Exciter	49
Ensemble.....	49
Rotary Speaker.....	50
Combination Type Effects.....	50
Effect Parameters Default Values Chart	56
4 - COMBINATION MODE.....	58
Editing in the Combination Mode.....	58
5 - EDIT COMBINATION MODE	61
Combination Types	61
Common Functions of Each Combination Type	62
Single Type Functions	65
Layer Type Functions	66

Split Type Functions	68
Velocity Switch Type Functions.....	70
Multi Type Functions.....	72
6 - SEQUENCER MODE.....	79
Structure of Songs	79
Structure of Patterns	80
Editing Sequencer Data	80
Functions of Sequencer Mode.....	81
Play	82
Starting Play from Midway Point of Song	82
Real Time Recording	83
Punch In Recording.....	83
Multi Channel Recording.....	85
Step Recording.....	88
Song Initialize.....	91
Track Copy.....	93
Track Bounce	93
Track Erase.....	94
Put/Copy Pattern.....	94
Measure Copy	95
Measure Insert.....	96
Measure Delete	96
Measure Erase.....	97
Quantize	98
Pattern Real Time Recording	99
Pattern Step Recording.....	100
Get Pattern.....	101
Pattern Copy.....	102
Pattern Bounce.....	102
Editing Event	103
7 - GLOBAL MODE	110
Functions in the Global Mode.....	110
MIDI SYSTEM EXCLUSIVE.....	122
ERROR MESSAGES	132
SPECIFICATIONS AND MISCELLANEOUS INFORMATION	134
Specifications.....	134
MIDI Implementation	135

FRONT/REAR PANELS

FRONT PANEL

(See the KEYS AND CONTROLS section, p.9 for explanations on each key and control.)

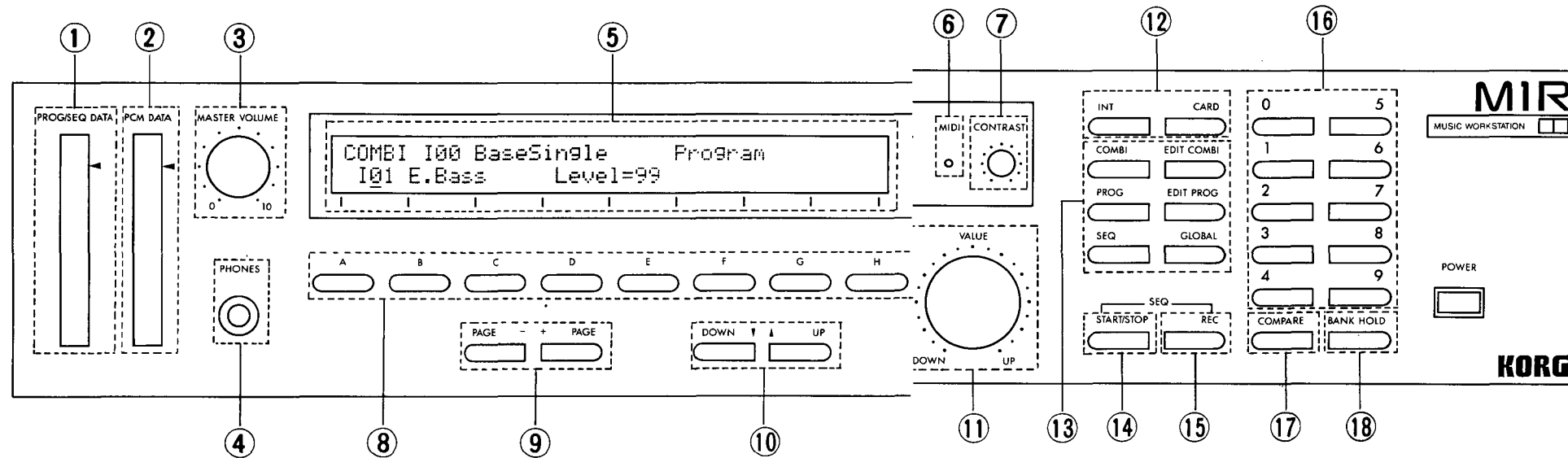

(1) PROG/SEQ DATA slot

Only cards that are stored or will be stored with Program (sound color) and sequencer data should be inserted here. Remember that the PCM (Multisound) data card should be inserted in the PCM data slot on the front panel.

(2) PCM DATA slot

Only cards that are stored with PCM (Multisound) data should be inserted here. Do not insert the Program/sequence data cards here.

(3) MASTER VOLUME

(4) PHONES jack

For connection of a stereo headphone set. The outputs of OUTPUT 1/L and 2/R can be monitored.

(5) Display

(6) MIDI indicator

This lights up when MIDI signals are being received.

(7) CONTRAST dial

This controls the brightness of the display on the front panel. Turning the dial clockwise darkens the characters on the display and turning it counterclockwise lightens them.

(8) Cursor keys (A-H)

(9) PAGE + / - keys

(10) UP (▲)/DOWN (▼) keys

(11) VALUE Dial

(12) INT key/CARD key

(13) Mode Select keys

COMBI = COMBINATION Mode

EDIT COMBI = EDIT COMBINATION Mode

PROG = PROGRAM Mode

EDIT PROG = EDIT PROGRAM Mode

SEQ = SEQUENCER Mode

GLOBAL = GLOBAL Mode

(14) START/STOP keys

(15) REC key

(16) Numeric keypad (0-9)

(17) COMPARE key

(18) BANK HOLD key

REAR PANEL

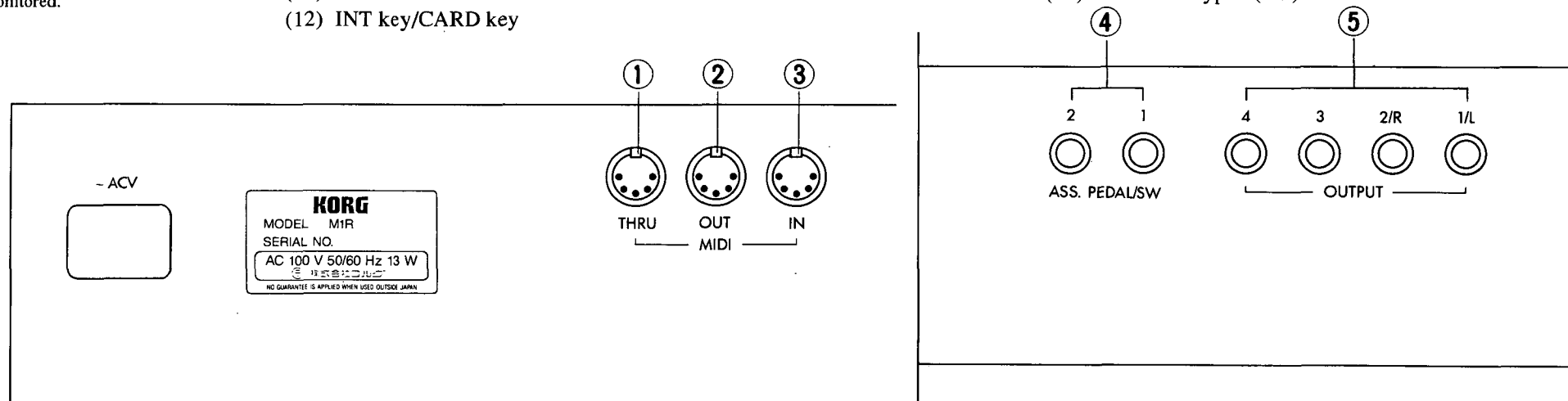

(1) MIDI THRU jack

(2) MIDI OUT jack

(3) MIDI IN jack

(4) ASS. PEDAL/SW jacks (1,2)

For connection of pedal and footswitches. Assigning parameters to be controlled by the switches is done in the GLOBAL Mode, Function F 2-1.

(5) OUTPUT jacks (1/L, 2/R, 3, 4)

These are the MIR's voice output jacks. The assignment of voices to the desired jacks is done in each of the Effect Parameters sections of the EDIT PROGRAM, EDIT COMBINATION and SEQUENCER Modes.

BASIC OPERATION

STRUCTURE OF THE MIR

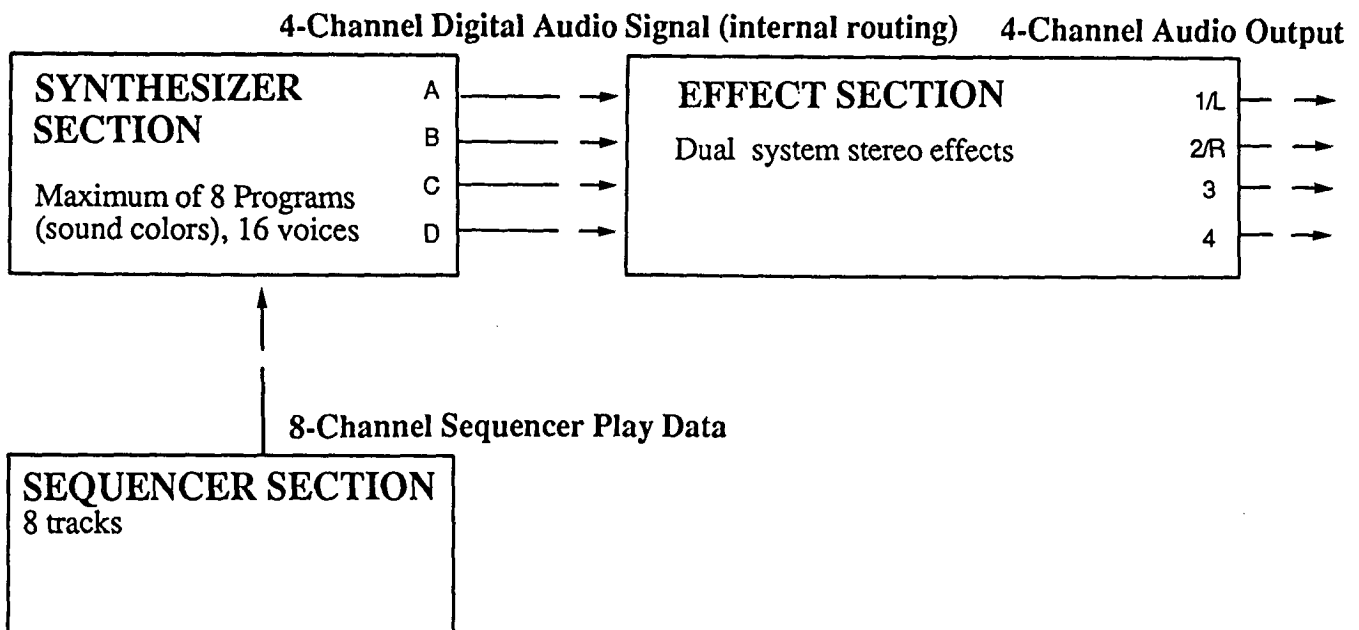

AI SYNTHESIS SYSTEM

The AI (Advanced Integrated) synthesis system of the MIR makes it possible to combine all various sound types -- from conventional synthesizer sounds to sampled sounds and drum sounds.

For sampled sounds, the large-capacity PCM data memory of 16 bit x 2 mega-words, far greater than that of conventional samplers, has been utilized, and a carefully selected group of Multisounds (a sound whose original wave shape has been multi-sampled¹) has been installed.

For its synthesizer sounds, not only the D.W.G.S. waveforms², which are produced by a process much the same as that of an analog synthesizer, but also aperiodic or irregular waveforms created by extraction of harmonically unrelated frequency components³ are part of the MIR's structure. As a result, creation of new and unique sounds beyond the existing limitations of the conventional synthesizer is possible.

Processing any of the programs or individual sounds with the use of VDFs (Variable Digital Filter) and VDAs (Variable Digital Amplifier) is, of course, possible. Moreover, different effects can be assigned to specific programs in a configuration of 2 systems and 2 channels through the MIR's MDE (Multi Digital Effect) feature when playing Multisounds. With the use of these functions, total control over all aspects of sound creation, including effects, is possible.

¹ Multi Sampling

The harmonic structure and overtones present in high pitched sounds usually differs from that of low pitched sounds, even in the same musical instrument. Multi Sampling is a method to recreate those characteristics by sampling an instrument repeatedly over a range of many octaves.

² D.W.G.S. (Digital Waveform Generator System) Waveform Data

The instrument sound is reproduced by the following process: Computer analysis determines the frequency components of the sampled instrument sound and reproduces them by creating a harmonic table for them as is done in additive synthesis.

³ Extraction of Harmonically Unrelated Frequency Components

Separates the aperiodic and harmonically unrelated components characteristic of such sounds as objects being hit or scraped from the sampled wave shapes.

MULTISOUND

(Original Sound Waveforms)

The oscillator (OSC) is selected from the Multisound (00 to 99).

- Multisounds can be selected from the PCM card.
- See EDIT PROGRAM mode, F0-2 for more details.

An original program can be created by performing various processes to the Multisound.

- The VDF (Variable Digital Filter) controls the sound color.
- The VDA (Variable Digital Amplifier) controls the sound volume.
- These processes are done in the EDIT PROGRAM Mode.

INSTRUMENT SETTINGS DRUM KIT

Assigns drum sounds to the keys.

Example:

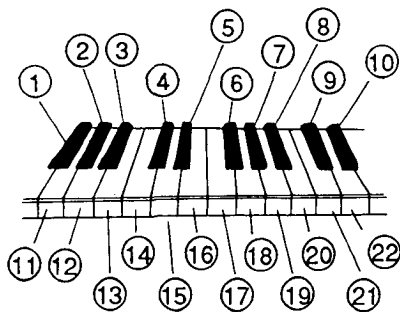

- 1 BASS DRUM 1
- 2 SNARE 1
- 3 HI TOM
- 4 CLOSED HI HAT
- 5 OPEN HI HAT
- 6 CRASH CYMBAL 1
- 7 RIDE CYMBAL 1
- 8 HAND CLAPS
- 9 HI CONGA (MUTED)
- 10 LO BONGO
- 11 BASS DRUM 2
- 12 SNARE 2
- 13 MID TOM
- 14 LO TOM
- 15 CLOSED HI HAT
- 16 PICCOLO SNARE 1
- 17 PICCOLO SNARE 2
- 18 CRASH CYMBAL 2
- 19 RIDE CYMBAL 2
- 20 HI CONGA (OPEN)
- 21 LO CONGA (MUTED)
- 22 HI BONGO

Instrument settings, including pan, are edited in the GLOBAL Mode.

PROGRAM MODE

- The work "Program" as referred to in this manual is synonymous with "sound color" or "preset voice" in other synthesizers.
- Program numbers available for selection are from 00 to 99. (Selection from only 00 to 49 is possible when large sequence allocation is selected.)

Single

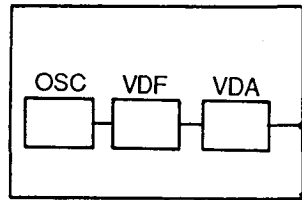

Double

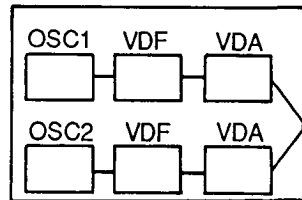

Drum Kit

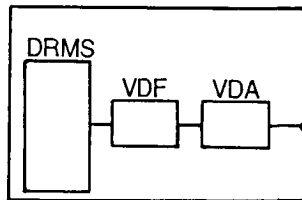

The EDIT PROGRAM Mode can be used for making settings up to this point.

OUTPUT

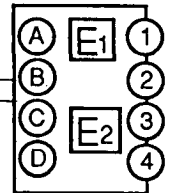

- Choose from 4 different instrument settings.
- The pan setting of the Drum Kit, which is set in the GLOBAL Mode, has priority.

COMBINATION MODE

• The word "Combination" as referred to in this manual means two or more programs that have been grouped together for simultaneous play.

- Combination numbers available for selection are from 00 to 99. (Selection from only 00 to 49 is possible when large sequence allocation is selected.)
- Program changes received via MIDI in the COMBINATION Mode change the Combination.

Layer

Split

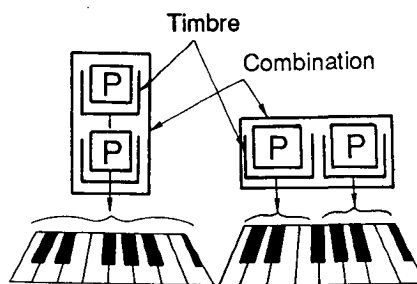

Settings for Layer or Split can be made in the EDIT COMBINATION Mode.

Separate MIDI channels can be assigned to each Program (or timbre) when Multi is chosen. In this way, one M1R Music Work station can, with the aid of an external sequencer, output eight different sound colors at the same time.

When using the M1R's built-in sequencer, Programs can be assigned to each track of the sequencer without having to create a Combination.

When Layer or Split are used:

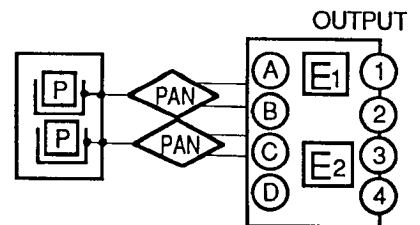

When Multi is used:

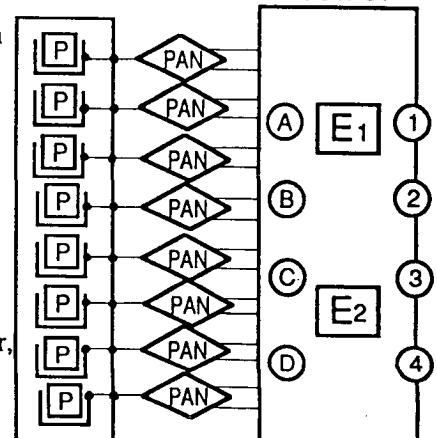

SEQUENCER MODE (Song 0 to 9)

When using external sound sources:

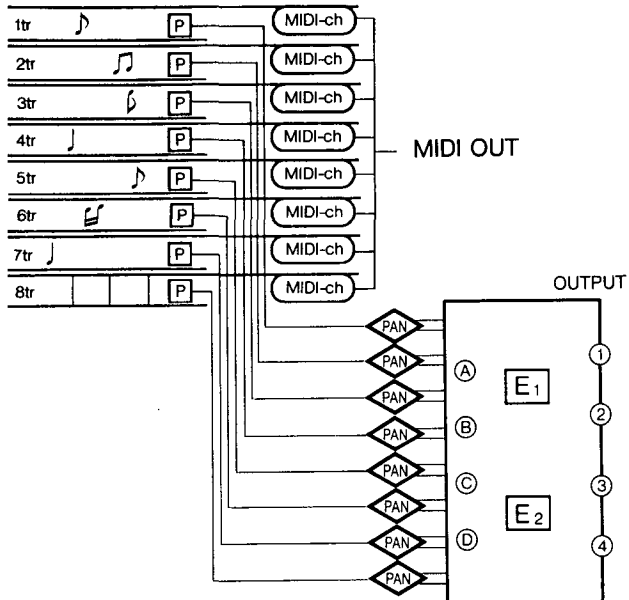

- Programs are assigned to each song.
- The pan setting can be made for each track.
- The effect setting can be made for each song.
- 1 song can be made up of 8 tracks
- Tracks can be created by combining patterns(00 to 99).

EFFECT E1, E2

When set to parallel operation:

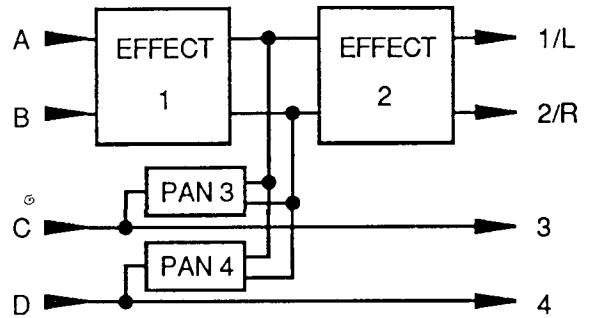

When set to serial operation:

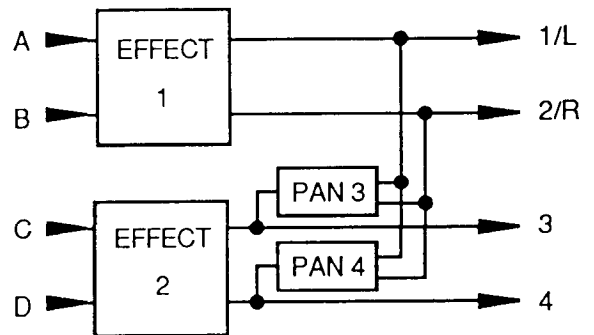

Effect1 and Effect2 are set in the effects pages of each mode.

PAN

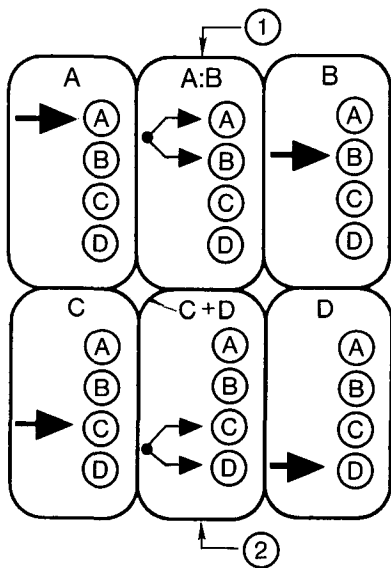

- ① The volume difference between the two outputs can be changed over a range of ratios from 1:9 ~ 9:1.
- ② Sends signals to C and D at the same volume.

KEYS AND CONTROLS

Numeric Keypad

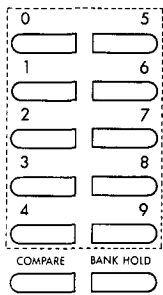

These are used to:

- * Select the Combination in the COMBINATION Mode.
- * Select functions in other modes.

BANK HOLD Key

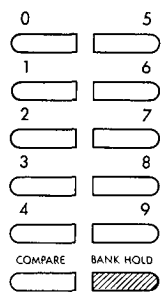

The tens digit of the program or combination number can be "held" while changing program or combination numbers by using the BANK HOLD key. For example, pressing the BANK HOLD key once after number 21 has been selected will allow you to select other numbers in the 20-29 range simply by pressing the number that corresponds to the ones digit of the desired number; in our example, pressing 3 will change the number to 23, pressing to 7 will change it to 27, and so on. The BANK HOLD key will be lit when the Bank Hold function is on. To turn the function off, press the BANK HOLD key once more.

COMPARE Key

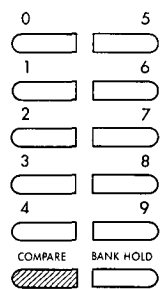

This key temporarily returns the Program or Combination which is being edited in the EDIT COMBINATION or EDIT PROGRAM Mode to the setting that existed before editing. Pressing the COMPARE key again restores the edited parameter values. However, data edited before pressing the COMPARE key will be lost if editing of other parameters or switching to other modes is done. The COMPARE key also functions as a MIDI panic button; in other words, when a stuck note occurs in sequencer play or control through MIDI IN, one press of the COMPARE key will turn the note off. (This can be used in any of the modes.) When the COMPARE key is lit, the original sound can be heard and its parameters are displayed; unlit, the COMPARE key indicates that the edited sound is displayed.

MODE SELECT Keys

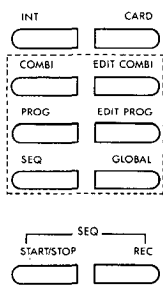

The selected mode will be lit.

INT Key and CARD Key

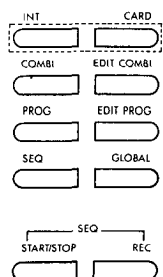

Press the INT key when using the Combination/Program/Song data of the internal memory of the MIR. Press the CARD key to access the external (card) data.

NOTE: The waveforms of the PCM (Multisound) card are selected in the Oscillator Assign function of the EDIT PROGRAM Mode and the Drum Kit functions of the GLOBAL Mode. In these exceptions, the INT Key and CARD Key are not used.

NOTE: Make certain to insert the card straight and firmly into the correct slot.

Cursor Keys and VALUE Dial

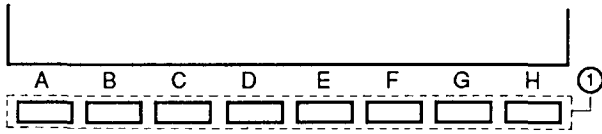

Parameter values can be changed by pressing the cursor key below the parameter to be edited on the display, then by adjusting the VALUE dial. Cursor keys used to access different function and parameters will be indicated in squares () throughout the rest of this manual.

UP/DOWN Keys

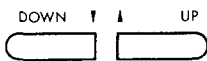

These are used when finely adjusting the values of parameters that are difficult to set only by using the VALUE dial or when making fine and detailed alterations in the sound. Pressing UP increases the value by 1 and pressing DOWN decreases the value by 1.

* Concerning the UP/DOWN keys:

The cursor will appear under the Combination/Program number at the bottom left of the screen when pressing the COMBI key or PROG key of the MODE SELECT keys (immediately after selecting the COMBI or PROG Mode). Pressing the UP key in this condition will advance the Combination or Program number by one and pressing the DOWN key will decrease it by one.

- * The VALUE dial cannot be used here to change the Combination or Program.
- * Pressing any of the cursor keys (A through H) will move the cursor to the performance edit parameters, and editing can be done by using the UP/DOWN keys and the VALUE dial.

To return the UP/DOWN keys to function as Program up and down after selecting the performance edit mode: in PROGRAM Mode, press the PROG button; in COMBINATION Mode, press the COMBI button. In each case, the cursor will return to its position under the Combination or Program number and the UP/DOWN keys can be used again to increment and decrement the Combination or Program number.

PAGE +/- Keys

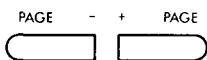

Each function of the M1R is organized in display pages. These keys allow you to access succeeding and preceding display pages by using the PAGE + and PAGE - keys, respectively.

START/STOP Key

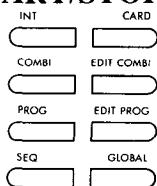

This key is used to start or to stop the sequencer. If you press this key in any mode other than the SEQUENCER Mode, the M1R will automatically move to the SEQUENCER Mode and play will start. When the sequencer is playing, the first beat of the measure is indicated on the key by a flashing red light; other beats are indicated by a flashing green light.

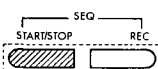

REC Key

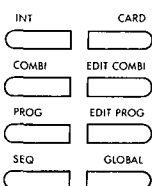

This key is used to begin recording when in the SEQ mode. The lamp remains lit while the sequencer is running.

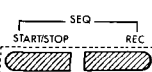

SETTING UP

1. First, check that the power switch on the front panel of the MIR is OFF. Check that the power switches of all connected equipment (amplifiers, mixers, etc.) are also OFF. For protection of all audio equipment (and your ears!) turn the volume of all equipment completely down.
2. Insert the power cord (which is included as standard equipment) into the power plug on the rear panel, then insert the other end of the cord into the proper power outlet.
3. Turn the MIR's power switch ON.
4. Turn the power switches of all connected equipment ON.

Then turn the MIR's volume and that of the other equipment up gradually to the desired volume. The MIR will not sound, however, if the MIDI channels of the MIR and the connected external MIDI devices are not matched. Please see the section "How to Match MIDI Channels" below.

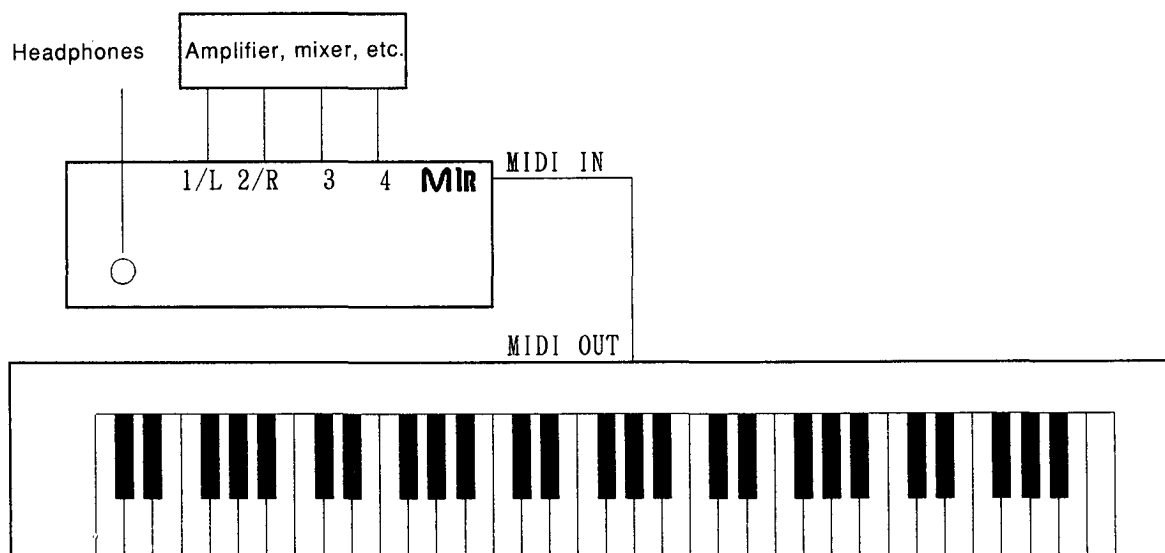

- * All note data from C-1 to G9 (note numbers 0-127) are received through MIDI IN. (Some of the Programs may not sound when played in higher ranges.)

How to Match MIDI Channels

- (1) Press GLOBAL of the Mode Select keys.
 - (2) Press "5" on the numeric keypad.
 - (3) Make sure that the cursor is at the "CH = " display. If it is not, press cursor key **B**.
 - (4) Adjust the VALUE dial until the desired MIDI channel is displayed.
- * For situations in which MIDI data is being received over different channels, settings are made using Multi functions the COMBINATION Mode or SEQUENCER Mode.

HOW TO PLAY COMBINATIONS (SOUND COLOR GROUPS)

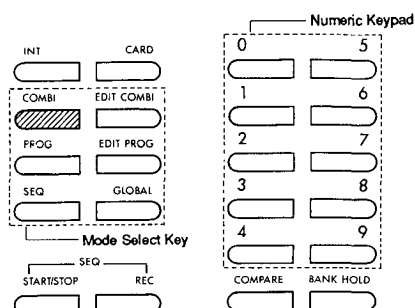

- (1) Press the COMBI key of the mode select keys; this puts the MIR in the COMBINATION Mode.
- (2) Select the number of the Combination (00 to 99) which you want to play by using the numeric keypad.
- (3) Play the keyboard to hear the sound of the combination selected in step #2.

These are typical displays from the COMBINATION mode:

Example #1

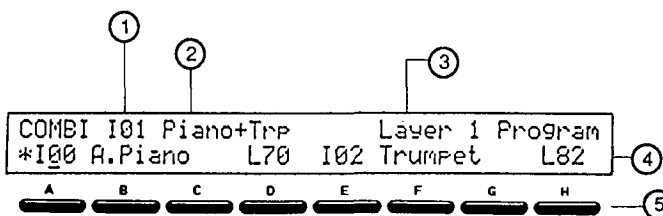

- 1 Combination number
- 2 Combination name
- 3 Parameter of currently selected cursor position
- 4 Number, name and volume level of the program being used
- 5 Cursor keys

Example #2

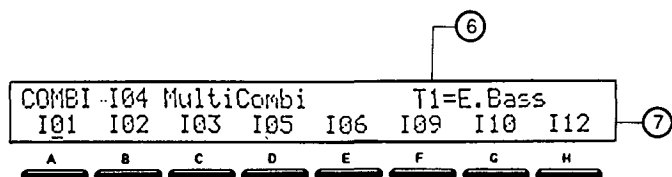

- 6 Program name of cursor position
- 7 Number of the Program being used

Example 1 shows a display when a Layer Combination is selected. The Program number, Program name and volume level are indicated when the Combination is a Layer or Split.

When replacing the Program of Layer 1 (Program number I00, directly above cursor key **A**) with another Program, press cursor key **A** then adjust the VALUE dial.

The display pages are often laid out such that one parameter description will occupy the space over several cursor keys. The cursor keys just under that parameter (and up to the cursor key of the next parameter) can be used to access the parameter.

The sound volume of Layer 1 can be changed by pressing cursor key **D** then adjusting the VALUE dial (maximum = 99, minimum = 00).

Press cursor key **E** when you want to replace the Program of layer 2. Press cursor key **H** when changing the volume of layer 2.

Example 2 shows a display when a multi Combination is selected. As in the first example, the Program number shown directly above cursor key **E** (Program number I06) can be changed by pressing cursor key **E** then by adjusting the VALUE dial.

HOW TO PLAY PROGRAMS (ONE SOUND COLOR)

- (1) Press the PROG key of the mode select keys; this puts the M1 in the PROGRAM Mode.
- (2) Select the number of the Program (00 to 99) which you want to play by using the numeric keypad or UP/DOWN keys.
- (3) Play the keyboard to hear the sound of the Program selected in step #2.

Here is a typical display from the PROGRAM mode:

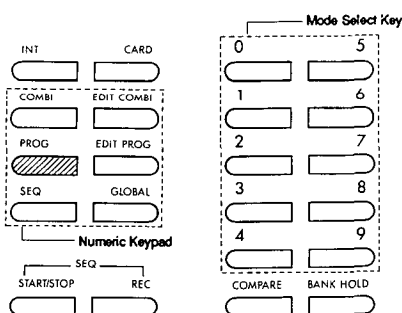

EXAMPLE

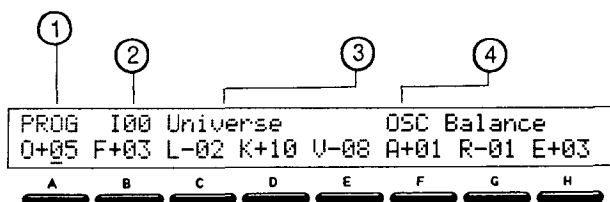

- 1 Program
- 2 Internal program number
- 3 Program name
- 4 Parameter

The display shown when selecting the PROGRAM Mode is like the one above. While this display is shown, the pressing of any single cursor key and adjusting of the VALUE dial will change the value of the parameter, which is indicated above the selected cursor key. In this way Programs may be easily edited without having to enter the EDIT PROGRAM Mode. This is particularly convenient for making on-the-spot sound changes during live performance.

* The functions of the parameters are as follows (see pp. 18- 19 in the PROGRAM Mode for more details):

O = OSC Balance (Oscillator balance)

This parameter controls the relative sound volume of the two oscillators of programs having two oscillators. The larger the value, the greater the volume of OSC 1 becomes.

(Range: -10 to +10.)

F = VDF Cutoff (VDF cutoff frequency)

This parameter controls the frequency point from which all lower frequencies are passed and all higher ones are cut off by the VDF. The higher this number is the clearer or brighter the timbre of the sound becomes, and the smaller the number the more muted or soft the timbre becomes.

(Range: -10 to +10.)

L = VDA Level

This parameter adjusts the level of the entire Program by VDA.

(Range: -10 to +10.)

K = KBD Track (Keyboard tracking)

Used in conjunction with VDF Cutoff, this parameter sets the degree to which keyboard pitch affects the amplitude and the cutoff frequency. The larger the number set with this parameter, the wider the variation in timbre becomes, corresponding to the note played.

(Range: -10 to +10.)

V = Vel. Sens. (Velocity Sensitivity)

This parameter sets the degree to which key velocity affects the amplitude and the cutoff frequency. The larger the value is, the greater the change in timbre becomes, corresponding to how hard the keys are struck.

(Range: -10 to +10.)

A = VDF/A EG Attack Time (VDF and VDA EG attack time)

This parameter controls the attack time of the program. The larger the value is, the longer the attack time becomes.

(Range: -10 to +10.)

R = VDF/A EG Release Time (VDF and VDA EG release time)

This parameter controls the release time of the program. The larger the number is, the longer the release time becomes.

(Range: -10 to +10.)

E = Effect Balance

This parameter controls the volume balance of the effect and direct sounds. The larger the number is, the greater the ratio of effect sound to direct sound becomes.

(Range: -10 to +10.)

NOTE: The values of the parameters here will return to their original settings when you select other programs. When moving to other modes, the parameter value (and, hence, the sound) remains at its stored or edited setting. When moving back to the PROGRAM Mode, the display value will be reset to zero, but the actual value remains unchanged.

HOW TO OPERATE THE SEQUENCER

Specially prepared sequencer demonstration data has been loaded into the internal memory of the MIR at the factory. Before recording your own data, let's listen to the demonstration data.

1. Press the SEQ key of the mode select keys; this puts the M1 in the SEQUENCER Mode.
2. Press cursor key **B**.

SONG0	M1 DEMO	31%Free
R/P	Song0 Tr1 M001	♩=120 *100 V99

A B C D E F G H

3. The value above the cursor can be changed by adjusting the VALUE dial. Select song number 0 by turning the VALUE dial counterclockwise as far as it will go.

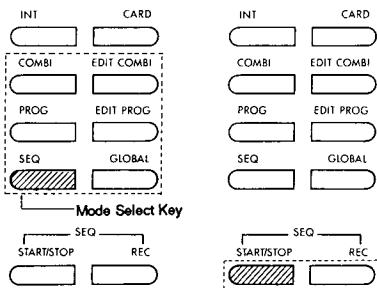

4. The sequence can be played by pressing the START/STOP key.
5. Play can be stopped by pressing the START/STOP key again.

HOW TO RECORD WITH THE SEQUENCER

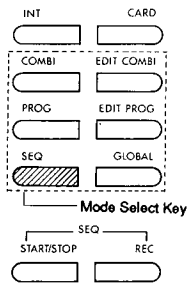

Now that you've heard the demo sequence, follow these steps to record some sequenced music of your own.

1. Press the SEQ key of the mode select keys; this puts the MIR in the SEQUENCER Mode.

2. Press cursor key **B**.

3. Select the song to be recorded by adjusting the VALUE dial. Select number 9 here.

4. Select the track to be recorded by pressing the cursor key **C**, then adjusting the VALUE dial. Select [1] for now.

5. Make certain that the MIDI transmit channel of the external keyboard matches the MIDI channel of the track.

6. Press the cursor key **F**, then select the program to be used by adjusting the VALUE dial. Select any Program you wish.

7. Press the REC key.

8. Press the START/STOP key. Begin playing after a lead-in of 2 measures. Recording starts at this point.

9. After finishing recording, press the START/STOP key once more to stop recording.

10. Playback can be executed by pressing the START/STOP key.

SONG9	New Song	31%Free
R/P	Song9 Tr1 M001	♩=120 *100 V99

A B C D E F G H

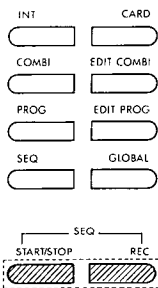

SOUND MAKING PROCESS

Here is a summary of the M1R's sound making process.

1. Select the sound to be edited in the PROGRAM Mode.

See the MODES AND FUNCTIONS chapter, section #1 PROGRAM MODE (p. 18)

2. Create the sound color in the EDIT PROGRAM mode and write it to memory.

See the MODES AND FUNCTIONS chapter, section #2 EDIT PROGRAM MODE (p.20)

3. Create the Combination by combining the Programs created in step #2 in the EDIT COMBINATION Mode.

See the MODES AND FUNCTIONS chapter, section #5 EDIT COMBINATION MODE (p.61)

3. Record a song using the Programs created in step #2 in the SEQUENCER Mode.

See the MODES AND FUNCTIONS chapter, section #6 SEQUENCER MODE (p.79)

INTERNAL MEMORY ALLOCATION

Large Sequence Allocation	Combination Memory = 50 Program Memory = 50 (memory numbers 150 - 199 cannot be selected)	10 Banks 100 Patterns (a total of less than 7700 steps)
Large Program Allocation (set at the factory prior to to shipment)	Combination Memory = 100 Program Memory = 100	10 Banks 100 Patterns (a total of less than 4400 steps)

There are two different kinds of internal memory allocation (the way available memory is used) in the M1R .

* Changing the memory allocation setting is done in the GLOBAL Mode, F6 - 4 (p.117)

NOTE: Be careful when switching the memory allocation setting, since much of your precious data could be irretrievably lost.

MEMORY CARD FORMAT

Program Card	100 Combinations 100 Programs 1 Global Parameter	
Sequencer Card		10 Banks 100 Patterns (a total of less than 7700 steps)
Program/Sequence Card	50 Combinations	10 Banks 100 Patterns (a total of less than 4200 steps)

The M1 has three kinds of memory formats.

- * PCM cards are not included in this classification.
- * Use KORG MCR-03 RAM cards.
- * Two RAM cards are necessary in order to save all the internal memory data.
- * Cards for the M1R and the M1 can be used interchangeably.

Writing in and reading out of data from cards can be done by using the following functions:

	Read Out	Write In
All Programs, Combinations, sequence data		
All Programs, Combinations	Global Mode F8 - 1	Global Mode F9 - 1
All sequence data		
1 Combination	COMBI Mode	EDIT COMBI Mode F9 - 1
1 Program	PROG Mode	EDIT PROG Mode F9 - 1
1 song	SEQ Mode F9 - 2	-----
1 pattern	SEQ Mode F9 - 3	-----

MODES AND FUNCTIONS

HOW TO READ THE DISPLAY PAGE CHART

F0-2 OSC1 (Oscillator 1) ----- ①

<p>②</p> <p>③</p> <p>④</p> <p>⑤</p>	<p>②</p> <p>③</p> <p>④</p>	<p>④</p> <p>⑤</p>	<p>⑥</p>
	<p>②</p> <p>③</p> <p>④</p>	<p>④</p> <p>⑤</p>	<p>⑥</p>
	<p>②</p> <p>③</p> <p>④</p>	<p>④</p> <p>⑤</p>	<p>⑥</p>

- ① F 0-2 OSC1 (Oscillator 1): Indicates that this is the second page of function 0 and that the function is called Oscillator 1.
- ② The cursor key to be used to access the parameter.
- ③ The abbreviation of the parameter that is shown on the display.
- ④ Name of the parameter.
- ⑤ The range of values and settings of the parameter.
- ⑥ Brief explanation of the parameter's function.

1 -- PROGRAM MODE

In this mode Programs (sound colors or preset voices) can be selected and played. Programs are selected by the numeric keypad (0-9), UP/DOWN keys, footswitch (PROG/COMBI, UP/DOWN) or MIDI program change.

- * A Program within the internal memory is selected when INT is selected and a Program within the card is selected when CARD is selected.
- * Before selecting a Program by footswitch or MIDI, the appropriate function has to be set for operation in the GLOBAL Mode.

NOTE: Panpot settings are given a default value of A:B = 5:5 in all Programs except the Drum Kit. (Signals are not output to Outputs 3 and 4.)

EDITING IN THE PROGRAM MODE

```

PROG  100 Universe      OSC Balance
0+05 F+03 L-02 K+10 V-08 A+01 R-01 E+03
  
```

A
B
C
D
E
F
G
H

A O	OSC Balance	-10 ~ +10	Controls the volume balance of OSC 1 and OSC 2 of the Programs when set to DOUBLE.
B F	VDF Cutoff	-10 ~ +10	Controls the cutoff frequency of VDF 1 and VDF 2 (changes the tonal quality of the sound).
C L	VDA Level	-10 ~ +10	Controls the level (volume) of OSC 1 and OSC 2.
D K	Keyboard Track	-10 ~ +10	Controls the sensitivity at which changes in sound color and volume are affected by the part of the keyboard played.
E V	Velocity Sensitivity	-10 ~ +10	Controls the sensitivity at which changes in sound color and volume are affected by how hard the keyboard is played.
F A	Attack Time	-10 ~ +10	Controls the attack time of VDFs 1, 2 and VDAs 1, 2.
G R	Release Time	-10 ~ +10	Controls the release time of VDFs 1, 2 and VDAs 1, 2.
H E	Effect Balance	-10 ~ +10	Controls the balance of the direct sound and the sound of Effects 1 and 2.

When editing parameters in the PROGRAM Mode, corresponding Program parameters in the same Programs of the EDIT PROGRAM Mode are assigned the same values.

- * Edited Programs should be written to memory in the EDIT PROGRAM Mode.

Program parameters change as shown in the chart below when selecting positive parameter values ("+" settings). The reverse changes occur when negative values ("-") settings) are used.

PROGRAM Mode Parameters **Effect of a positive value setting on each parameter**

OSC Balance	OSC 1 Level OSC 2 Level	The level of OSC 1 increases, while that of OSC 2 decreases.*1
VDF Cutoff	VDF 1, 2 Cutoff	Increases (or assumes a positive value).*1
VDA Level	OSC 1, 2 Level	
Keyboard Track	VDF 1, 2 KBD TRK Cutoff EG Time VDA 1, 2 KBD TRK Amplitude EG Time	Increases in proportion to note number of key played.*2
Velocity Sensitivity	OSC 1, 2 EG Level Vel Sens EG Time Vel Sens VDF 1, 2 VEL SENS EG Int EG Time VDA 1,2 VEL SENS Amplitude EG Time	Even when set to a negative value, only the absolute value becomes smaller, but the sign ("+" or "-") does not change Parameters with values set to "0" remain as "0" and do not change.
Attack Time	VDF 1, 2 Attack Time VDA 1, 2 Attack Time	Increases (or assumes a positive value). *3
Release Time	VDF 1, 2 Release Time	Increases.*1
Effect Balance	EFFECT 1, 2 Balance	

*1 Assuming that the original value = V, then the changed value is increased or decreased by 5V.

*2 Assuming that the original value = V, then the changed value increases by a power of $1 + (V/10)$.

*3 Assuming that the original value = V, then the increase or decrease of the VDF value is by 3V, while that of the VDA value is by 5V.

2 -- EDIT PROGRAM MODE

In this mode the Program parameters (such as original waveform settings and filter EG values, etc.) are set.

- * Only the Programs which have been already selected in the PROGRAM Mode can be edited.
- * Editing in real time (for changing parameters in live performance) can be done in the PROGRAM Mode.
- * Use the F 9 - 1 Write Program function after finishing any edits and the Program will be completed. (Programs which are not written to memory are irretrievably lost when selecting other programs in the PROGRAM Mode.)
- * Pressing the COMPARE key during editing can recall the original un-edited program for comparison. Pressing the COMPARE key again and leaving the Program without editing it returns you to the Program which was being edited before the COMPARE key was pressed.

STRUCTURE OF THE M1'S PROGRAM PARAMETERS

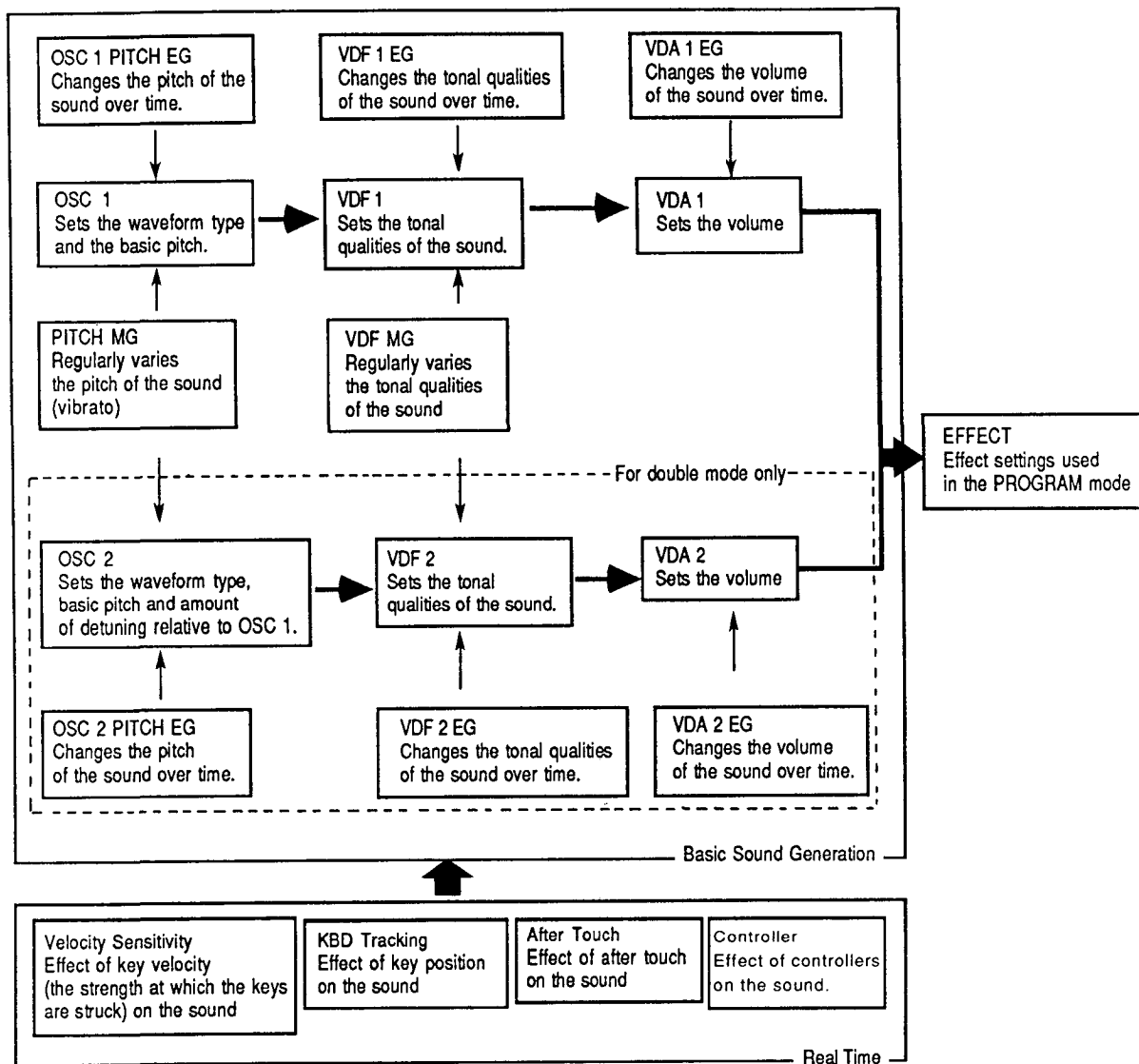

FUNCTIONS IN THE EDIT PROGRAM MODE

- * The first page of each function is selected by pressing the numeric keypad (0 to 9). Select the page at which the parameter you want to edit shows using the PAGE + key and PAGE - key.
- * The maximum pitch change of the various pitch controls, such as pitch bend, pitch EG, pitch modulation and after touch, is limited to one octave. (Some Multisounds have an even smaller range, depending on the actual pitch range of the sound.)
- * VDF and VDF EG parameters as well as the change in timbre by VDF MG are limited to the total controllable range of the VDF.
- * Oscillator level and VDA parameters, as well as volume change by VDA EG are limited to the total controllable range of the VDA.

Page		Parameter to be edited
0-1 2 3	OSC-BASIC OSC1 OSC2	Oscillator mode Waveform, level of Oscillator 1 Waveform, level, pitch of Oscillator 2 (Double mode)
1-1 2	OSC1 PITCH EG OSC PITCH EG	Pitch variation over time of Oscillator 1 Pitch variation over time of Oscillator 2 (Double mode)
2-1 2 3 4	VDF1 VDF1 EG VDF1 VEL SENS VDF1 KBD TRK	Cutoff frequency, EG intensity of VDF 1 Variation of the VDF 1's cutoff frequency over time Degree to which VDF 1 responds to key velocity Degree to which VDF 1 tracks the keyboard
3-1 2 3 4	VDF2 VDF2 EG VDF2 VEL SENS VDF2 KBD TRK	Cutoff frequency, EG intensity of VDF 2 (Double mode) Variation of the VDF 2's cutoff frequency over time (Double mode) Degree to which VDF 2 responds to key velocity (Double mode) Degree to which VDF 2 tracks the keyboard (Double mode)
4-1 2 3	VDA1 EG VDA1 VEL SENS VDA1 KBD TRK	Volume variation of VDA 1 over time Degree to which VDA 1 responds to key velocity Degree to which VDA 1 tracks the keyboard
5-1 2 3	VDA2 EG VDA2 VEL SENS VDA2 KBD TRK	Volume variation of VDA 2 over time (Double mode) Degree to which VDA2 responds to key velocity (Double mode) Degree to which VDA2 tracks the keyboard (Double mode)
6-1 2	PITCH MG VDF MG	Pitch modulation (vibrato effect) VDF modulation (wah-wah effect)
7-1 2	AFTER TOUCH CONTROLLER	Degree to which after touch affects tonal quality Degree to which controller affects tonal quality
8-1 2 3 4 5 6	EFFECT 1 EFFECT 1 PARAMETER EFFECT 2 EFFECT 2 PARAMETER EFFECT PLACEMENT EFFECT COPY	Selection of Effect 1 Parameters of Effect 1 Selection of Effect 2 Parameters of Effect 2 Assignment of Effects 1 and 2 Copying of Effect parameter values
9-1	WRITE/RENAME	Writing and renaming of Programs

EDITING IN THE EDIT PROGRAM MODE

F 0 - 1 OSC BASIC (Oscillator)

```

PROG I00 OSC BASIC OSC Mode
(DOUBLE) POLY Hold:OFF
    
```

A
B
C
D
E
F
G
H

A	OSC MODE	SINGLE DOUBLE DRUMS	Sound origin mode One-oscillator mode Two-oscillator mode Drum Kit mode
C	Assign	POLY MONO	Number of voices sounded Maximum polyphonic play Monophonic play
F	Hold	ON/OFF	Sound continues even after key release

In the OSC MODE (oscillator mode), the structure of the Program to be made is selected. The oscillator number and the type of sound origin will change according to the setting made here.

- * When switching the OSC MODE, reset the multisound (Drum Kit) of OSC 1 in the following page.
- * In SINGLE, a one-system OSC/VDF/VDA is used. The maximum simultaneous voices available is 16.
- * In DOUBLE, two OSC/VDF/VDA systems are used. Sounds of greater complexity can be created here, but the maximum simultaneous voices available is decreased to 8.
- * DRUM KIT is a mode that uses drum sounds as the sound origin to make up a keyboard-controllable drum kit.

Assign determines whether the program is to be played polyphonically or monophonically.

When the Hold parameter is set to ON, notes played will continue to sound even after releasing the key. This is used mainly for playing the Drum Kit.

- * The sound will not stop but will continue for the full duration of the sustain parameter when Hold is set to ON.

F 0 - 2 OSC1 (Oscillator 1)

```

PROG I00 OSC1 Multisound
00:A.Piano L99 8'
    
```

A
B
C
D
E
F
G
H

A	Multisound Drum Kit	Drum Kit 1 } Drum Kit 4	Selection of Oscillator 1 Multisound waveform (when oscillator mode is set to Single or Double) Selection of Drum Kit (when oscillator mode is set to Drums)
D	L OSC Level	0 - 99	Volume of Oscillator 1
E	Octave	16' 8' 4'	Octave setting of Oscillator 1 One octave below standard pitch Standard pitch One octave above standard pitch

When SINGLE or DOUBLE is selected in function F 0 - 1, OSC MODE, the waveform of Oscillator 1 is selected by Multisound (Multisound Select). (A list of the Multisounds is on the back cover.)

- * Since each Multisound (sound origin waveform) has a limited pitch range, it may not sound when playing in a high octave.
- * Multisounds can be chosen from CARD if the PCM card (optional) is inserted in the rear panel. Multisounds within the CARD are indicated by a "C" in front of the number on the display and can be seen in succession by moving the VALUE slider up and down.

NOTE: Make sure to insert or take out the PCM card only when the power is OFF or when no sound comes from the M1R.

Selects one of the Drum Kits (1 to 4), when DRUM KIT is selected in the OSC MODE.

- * Assignment of drum sounds to the Drum Kit is done in GLOBAL Mode.

OSC Level (oscillator level) sets the sound volume of Oscillator 1. The maximum is 99 and minimum is 0.

Octave sets the basic pitch of Oscillator 1 in octave units.

F 0 - 3 OSC 2 (Oscillator 2) --- Only DOUBLE MODE

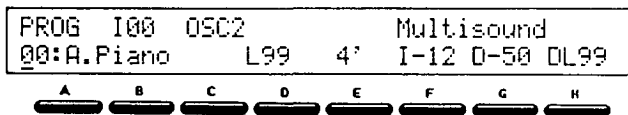

A	Multisound	Multisound name	Selection of Multisound for Oscillator 2
D L	OSC Level	0 ~ 99	Volume of Oscillator 2
E	Octave	16', 8', 4'	Octave of Oscillator 2
F I	Interval	-12 ~ +12	Pitch of Oscillator 2 relative to Oscillator 1 (adjustable in semitones)
G D	Detune	-50 ~ +50	Detuning of Oscillator 2 relative to Oscillator 1 (adjustable in cents)
H DL	Delay Start	0 ~ 99	Delay time before Oscillator 2's sound begins

Multisound (Multisound select) selects the Multisound of Oscillator 2. The types of Multisound that can be selected are the same as in F 0 - 2, OSC1 Multisound.

OSC Level (oscillator level) sets the sound volume of Oscillator 2.

Octave sets the octave of Oscillator 2.

Interval sets the pitch difference between Oscillator 1 and the Oscillator 2 in semitones (over a range of -12 to +12). Creating chords with Oscillators 1 and 2 is possible by adjusting the pitch here.

Detune allows finer adjustment in cents of the pitch difference between Oscillators 1 and 2 (over a range of -50 to +50). A thick sound can be obtained by detuning Oscillator 2 slightly.

Delay Start determines the time it takes between the onset of the sound of Oscillator 1 and the start of Oscillator 2's sound. (Set to "0" when not using this effect.)

F 1 - 1 OSC 1 PITCH EG (Oscillator 1 Pitch EG)

```

PROG I00 OSC1 PITCH EG Start Level
S-99 AT99 A+99 DT99 RT99 R-99 L+99 T-99

```

A
B
C
D
E
F
G
H

A S	Start Level	-99 ~ +99	<p>Determines how the pitch of Oscillator 1 varies over time.</p>
B AT	Attack Time	0 ~ 99	
C A	Attack Level	-99 ~ +99	
D DT	Decay Time	0 ~ 99	
E RT	Release Time	0 ~ 99	
F R	Release Level	-99 ~ +99	
G L	EG Level Vel. Sens.	-99 ~ +99	Determines to what degree pitch will vary in response to key velocity.
H T	EG Time Vel. Sens.	-99 ~ +99	Determines to what degree the total time of the pitch variation will change in response to key velocity.

Sets the rate at which the pitch of Oscillator 1 changes.

These parameters set the rate at which the pitch of Oscillator 1 changes.

Setting opposite positive and negative values for each EG level will result in an EG shape reverse of the above.

The stronger the key is struck the greater the change of pitch when setting EG Level Vel. Sens. (EG level velocity sensitivity) to "+". (The opposite occurs when set to "-".) The change of pitch by EG is limited to within +/- 1 octave.

* When set to "+":

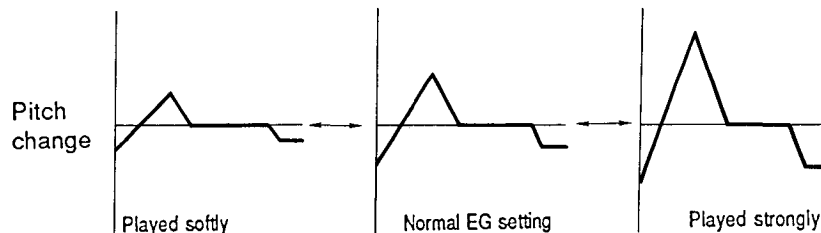

The stronger the key is struck the shorter the time becomes when setting the EG Time Vel. Sens. (EG time velocity sensitivity) to "+". (The opposite occurs when set to "-".)

* When set to "+":

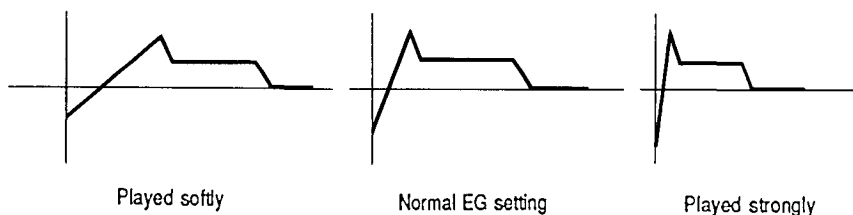

F 1 - 2 OSC 2 Pitch EG (Oscillator 2 Pitch EG)---only DOUBLE Mode

Determines how the pitch of Oscillator 2 varies over time.

* The functions and parameters are the same as F 1 - 1 OSC 1 Pitch EG, as applied to Oscillator 2. Please refer to the section on OSC 1 Pitch EG.

F 2 - 1 VDF 1

```

PROG I00 VDF1
      Cutoff= 99      EG Intensity= 99
  
```

A
B
C
D
E
F
G
H

D	Cutoff	0 ~ 99	Determines the initial cutoff frequency of VDF 1. (Controls how bright the sound will be.)
H	EG Intensity	0 ~ 99	Determines the degree to which the EG will affect the cutoff frequency.

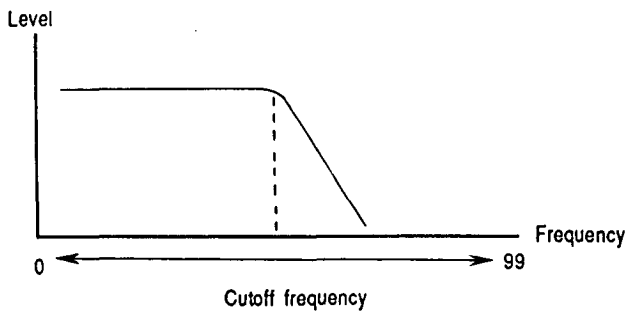

* The VDF (Variable Digital Filter) controls the tonal quality of the sound by damping (cutting off) the high frequency components of the Multisound.

Cutoff sets the cutoff frequency of VDF. The smaller the value is set, the more mellow the tone becomes.

EG Intensity sets the sensitivity of the cutoff frequency to the VDF EG in the succeeding page. The depth of the cutoff change is greatest when set to 99.

F 2 - 2 VDF 1 EG

```

PROG I00 VDF1 EG      Attack Time
AT70 A-87 DT53 B-52 ST12 S-99 RT99 R-08
  
```

A
B
C
D
E
F
G
H

A	AT	Attack Time	0 ~ 99	Determines how the VDF 1's cutoff frequency will vary over time. The time parameters (Attack Time, Decay Time, Slope Time, Release Time) are used to set the time it takes to reach the next level. The level parameters (Attack Level, Break Point, Sustain level, Release Level) are used to set the cutoff frequency of the VDF for that segment of the EG.
B	A	Attack Level	-99 ~ +99	
C	DT	Decay Time	0 ~ 99	
D	B	Break Point	-99 ~ +99	
E	ST	Slope Time	0 ~ 99	
F	S	Sustain Level	-99 ~ +99	
G	RT	Release Time	0 ~ 99	
H	R	Release Level	-99 ~ +99	

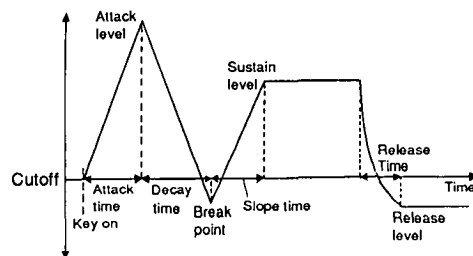

* Each level can be individually set to a positive or negative value in relation to initial cutoff.

* The amount by which each level affects the cutoff frequency is globally controlled by VDF 1 EG Intensity.

F 2 - 3 VDF 1 VEL SENS (VDF 1 Velocity Sensitivity)

```

PROG 100 VDF1 VEL SENS Release Time
EGInt=-99 EGTime=99 AT:0 DT:+ ST:+ RT:0
    
```

A
B
C
D
E
F
G
H

B	EG Int (EG Intensity Velocity Sensitivity)	-99 ~ +99	The degree to which the VDF 1 EG's level is affected by key velocity
D	EG Time (EG Time Velocity Sensitivity)	0 ~ 99	The degree to which the VDF 1 EG's time is affected by key velocity
E AT	Attack Time	-, 0, +	These are the parameters that EG time velocity sensitivity can be programmed to affect; negative and positive values can be individually selected with 0 having no effect.
F DT	Decay Time	-, 0, +	
G ST	Slope Time	-, 0, +	
H RT	Release Time	-, 0, +	

EG Int (EG Intensity Velocity Sensitivity) is an effect that changes the tone color by how hard you strike the keys.

- * When a negative setting is chosen, the more softly the keys are played the greater the cutoff frequency change becomes. (The set value by EG intensity is the norm.)
- * When set to "+":

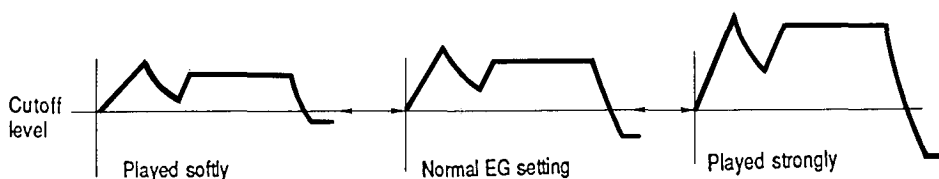

- * It is true of most acoustic musical instruments that the softer the sound made, the fewer high frequency components that are present in the sound. When imitating this effect, set the cutoff frequency to low in the VDF, set all levels like the sustain level of VDF EG to "+", and set the parameter values of VDF EG intensity and VDF EG intensity velocity Sensitivity to "+".

EG Time (EG Time Velocity Sensitivity) is an effect that changes the speed of VDF EG by how hard you strike the keys. When set to positive ("+"), the stronger the key is hit the shorter the time of the EG (Attack / Decay / Slope / Release) becomes. (The time becomes longer when set to "-".) Thus, by setting Attack to positive ("+") and release to negative ("-"), the harder the key is struck the shorter the attack but the longer the release.

F 2 - 4 VDF 1 KBD TRK (VDF 1 Keyboard Tracking)

```

PROG  I00  VDF1 KBD TRK  Center Key
C4  F-99 EGTime=99 AT:0 DT:+ ST:+ RT:-
  
```

A
B
C
D
E
F
G
H

A	Center Key	C-1 ~ G9	The central key for effect of VDF 1 keyboard tracking (key of ± 0)
B F	Cutoff (Cutoff Frequency Keyboard Tracking)	-99 ~ +99	Change of VDF 1 cutoff frequency (the brightness of tone color) by key position
D	EG Time (EG Time Keyboard Tracking)	0 ~ 99	Change of VDF 1 EG speed by key position
E AT	Attack Time	-, 0, +	These are the parameters that EG time keyboard tracking can be programmed to affect; negative and positive values are available, with 0 having no effect.
F DT	Decay Time	-, 0, +	
G ST	Slope Time	-, 0, +	
H RT	Release Time	-, 0, +	

* VDF Keyboard Tracking is an effect that changes, in proportion to the note number played, the values of the VDF cutoff frequency and of time it takes the EG to cycle.

Center Key sets the central key (the key for which cutoff/EG time does not change) of VDF keyboard tracking. When Cutoff is set to "+," the higher the pitch played the brighter the tone color becomes. (The opposite occurs when setting to "-.") The greater the change is, the closer the value gets to + 99 or - 99. The change of Cutoff and the change of pitch are equal when set to 0.

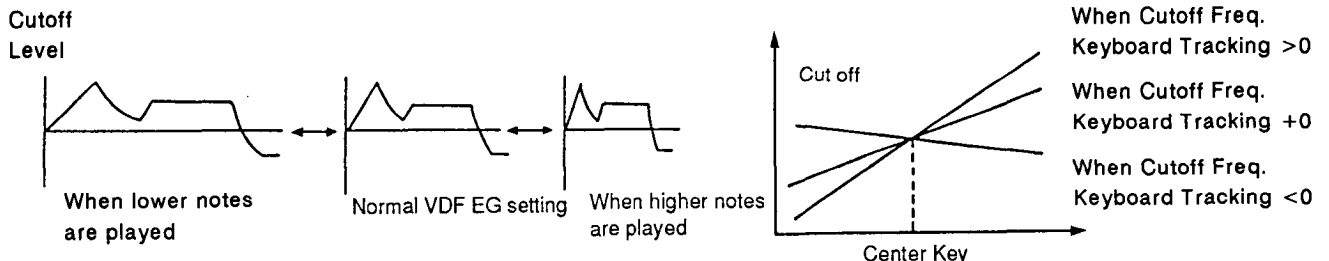

F 3 - 1 VDF 2 --- Only DOUBLE Mode

```

PROG  I00  VDF2
      Cutoff= 99 EG Intensity= 99
  
```

A
B
C
D
E
F
G
H

This is a VDF for Ocillator 2.
 * The functions and parameters are the same as F 2 - 1 VDF 1, as applied to Oscillator 2.

F 3 - 2 VDF 2 EG --- Only DOUBLE MODE

```

PROG  I00  VDF2 EG      Attack Time
AT35 A-99 DT88 B-62 ST46 S-99 RT15 R-11
  
```

A
B
C
D
E
F
G
H

Sets the rate at which the cutoff frequency of VDF 2 changes.
 * The functions and parameters are the same as F 2 - 2 VDF 1 EG, as applied to Oscillator 2.

F 3 - 3 VDF 2 VEL SENS (VDF 2 Velocity Sensitivity) --- Only DOUBLE MODE

```

PROG  I00  VDF2 Vel Sens Decay Time
EGInt=-99 EGTime=99 AT=0 DT:+ ST:+ RT=0
  
```

A
B
C
D
E
F
G
H

Determines the degree to which key velocity affects the change of VDF 2.
 * The functions and parameters are the same as F 2 - 3 VDF 1 VEL. SENS., as applied to Oscillator 2.

F 3 - 4 VDF 2 KBD TRK (VDF 2 Keyboard Tracking) --- Only DOUBLE MODE

```

PROG I00 VDF2 KBD Trk Center Key
C4 F-99 EGTime=99 AT=0 DT=+ ST=+ RT=-
    
```

A B C D E F G H

Determines the degree to which the keyboard tracks VDF 2.

* The functions and parameters are the same as F 2 - 4 VDF 1 KBD TRK, as applied to Oscillator 2.

F 4 - 1 VDA 1 EG

```

PROG I00 VDA1 EG Attack Time
AT33 A+44 DT25 B+99 ST14 S+99 RT68
    
```

A B C D E F G H

A	AT	Attack Time	0 ~ 99	Determines how the volume of VDA 1 will vary over time
B	A	Attack Level	0 ~ 99	
C	DT	Decay Time	0 ~ 99	
D	B	Break Point	0 ~ 99	
E	ST	Slope Time	0 ~ 99	
F	S	Sustain Level	0 ~ 99	
G	RT	Release Time	0 ~ 99	

* VDA (Variable Digital Amplifier) changes the volume of the sound origin waveform. The VDA EG determines how the volume will vary over time.

F 4 - 2 VDA 1 VEL SENS (VDA 1 Velocity Sensitivity)

```

PROG I00 VDA1 VEL SENS Amplitude
A-99 EGTime=99 AT:0 DT:+ ST:+ RT:-
    
```

A B C D E F G H

B	A	Amplitude (Amplitude Velocity Sensitivity)	-99 ~ +99	Change of VDA 1's volume by key velocity
D		EG Time (EG time Velocity Sensitivity)	0 ~ 99	Change of the VDA's EG time (variation of volume over time) by key velocity
E	AT	Attack Time	-, 0, +	These are the parameters that EG time velocity sensitivity can be programmed to affect; negative and positive values are available, with 0 having no effect.
F	DT	Decay Time	-, 0, +	
G	ST	Slope Time	-, 0, +	
H	RT	Release Time	-, 0, +	

Amplitude (amplitude velocity sensitivity) is an effect that changes the volume by how hard you strike the keys. When set to positive ("+"), the stronger the key is hit the louder the sound becomes. The volume becomes softer when set to "-". The closer the value is set to + 99 or - 99, the greater the difference in volume becomes.

* Tone color can be changed by velocity when setting the VDA velocity sensitivity of Oscillator 1 and 2 to opposite settings in the DOUBLE Mode (velocity cross fade).

- * When the keys are hit hard, the Program of OSC 1 sounds.
- * When the keys are hit with normal strength, the Programs of OSC 1 and OSC 2 both sound.
- * When the keys are hit softly, the Program of OSC 2 sounds.

EG Time (EG Time Velocity Sensitivity) is an effect that changes the speed of VDA EG by how hard you strike the keys. When set to positive ("+"), the stronger the key is hit the shorter the time of the EG (Attack / Decay / Slope / Release) becomes. (The time becomes longer when set to "-".)

- * When setting all to "+":

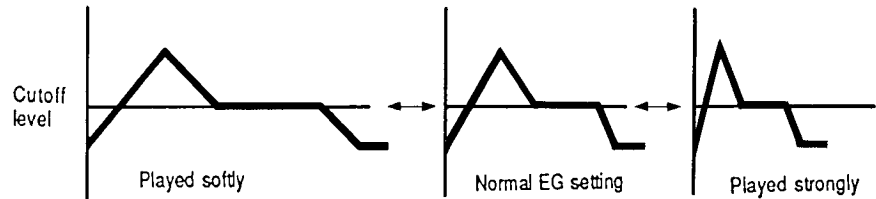

- * When playing Programs such as strings, it is possible to set a sharp attack/long release to result when hitting the keys hard and a slow attack/short release when playing softly by setting the Attack time to "+" and the Release time to "-".

F 4 - 3 VDA 1 KBD TRK (VDA 1 Keyboard Tracking)

```

PROG I00 VDA1 KBD TRK Center Key
C#-1 A-99 EGTime=99 AT:0 DT:+ ST:+ RT:-
  
```

A
B
C
D
E
F
G
H

A	Center Key	C-1 ~ G9	The central key for the effect of VDA 1 keyboard tracking (key of ±0)
B A	Amplitude (Amplitude Keyboard Tracking)	-99 ~ +99	Change of the volume of VDA 1 by key position
D	EG Time (EG time Keyboard Tracking)	0 ~ 99	Change of VDA 1 EG speed by key position
E AT	Attack Time	-, 0, +	These are the parameters that EG time keyboard tracking can be programmed to affect; negative and positive values can be individually selected, with 0 having no effect.
F DT	Decay Time	-, 0, +	
G ST	Slope Time	-, 0, +	
H RT	Release Time	-, 0, +	

- * VDA Keyboard Tracking is an effect that varies the volume of the VDA and all EG times by the key position played.

Center Key sets the central key (the key that is not changed by cutoff/EG time) of VDA keyboard tracking. When Amplitude is set to "+," the higher the pitch played, the louder the volume becomes. (The opposite occurs when setting to "-".) It is possible to switch between Programs depending on the key played by setting the center key of Oscillators 1 and 2 to the same value and by setting a positive value for one and a negative value for the other (positional cross fade).

- * The total volume, whatever the keyboard track setting, cannot extend beyond the minimum and maximum values of 0 and 99. When keys above the center key are played, the VDA EG time (Attack / Decay / Slope / Release) becomes progressively shorter, if set to "+" in the EG Time (EG Time Keyboard Tracking) function. The opposite occurs when setting to "-".

F 5 - 1 VDA 2 EG ---Only DOUBLE MODE

```

PROG I00 VDA2 EG Attack Time
AT66 A+22 DT49 B+99 ST77 S+23 RT40
  
```

A B C D E F G H

The VDA 2 EG determines how the volume of Oscillator 2 will vary over time.

- * The functions and parameters are the same as F4-1 VDA 1 EG, as applied to Oscillator 2.

F 5 - 2 VDA 2 VEL SENS (VDA 2 Velocity Sensitivity)--- Only DOUBLE Mode

```

PROG I00 VDA2 VEL SENS Amplitude
A-99 EGTime=99 AT:0 DT:+ ST:+ RT:-
  
```

A B C D E F G H

Determines the degree to which the volume change of VDA 2 is affected by key velocity.

- * The functions and parameters are the same as F4-2 VDA 2 VEL. SENS., as applied to Oscillator 2.

F 5 - 3 VDA 2 KBD TRK (VDA 2 Keyboard Tracking) --- Only DOUBLE MODE

```

PROG I00 VDA2 KBD TRK Center Key
C#-1 A-99 EGTime=99 AT:0 DT:+ ST:+ RT:-
  
```

A B C D E F G H

Degree to which VDA 2 (volume of Oscillator 2) tracks the keyboard.





- * The functions and parameters are the same as F4-3 VDA 1 KBD. TRK., as applied to Oscillator 2.

F 6 - 1 Pitch MG (Pitch Modulation)

```





PROG I00 PITCH MG Waveform
TRIANGLE F31 041 I59 OFF Sync:OFF
  
```

A B C D E F G H

A	Wave form	TRIANGLE  SAW UP  SAW DOWN  SQUARE 	Selects the modulation waveform Triangle wave Saw Down (reverse polarity) Square
C F	Frequency	0 ~ 99	Speed of modulation
D D	Delay	0 ~ 99	Time between the striking of the key and the onset of the modulation effect
E I	Intensity	0 ~ 99	Depth of modulation
F	OSC Select	OFF OSC 1 OSC2 BOTH	No modulation effect Affects only OSC 1 Affects only OSC 2 Affects both OSC 1 and OSC 2
H	Key Sync	OFF ON	

- * Pitch MG (pitch modulation) is an effect that varies the pitch periodically.

Waveform selects the modulation waveform, which determines how the pitch will be varied.

- * Triangle  (most commonly used)
- * Saw Up 
- * Saw Down  (reverse polarity)
- * Square 

Frequency sets the modulation frequency (the speed of the pitch variation)

- * When Triangle wave is selected:

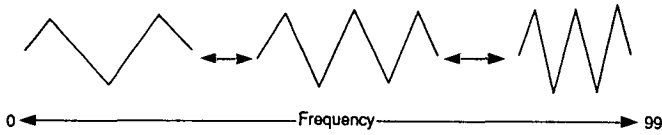

Delay determines the time between the striking of the key and the onset of the modulation effect.

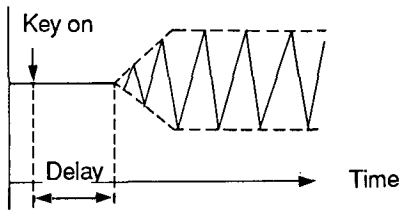

Intensity sets the depth of the modulation.

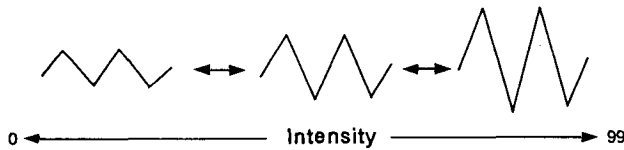

- * This effect does not work when Oscillator Select is OFF.

OSC Select selects the Oscillator to be modulated. BOTH affects both Oscillator 1 and Oscillator 2.

- * In all modes with the exception of DOUBLE Mode, the net effect of setting this parameter to OSC 2 is equal to that of OFF and the net effect of a BOTH setting is equal to that of OSC 1.

The modulation waveform starts upon the pressing of each key when the Key Sync is set to ON.

- * When Key Sync is ON:

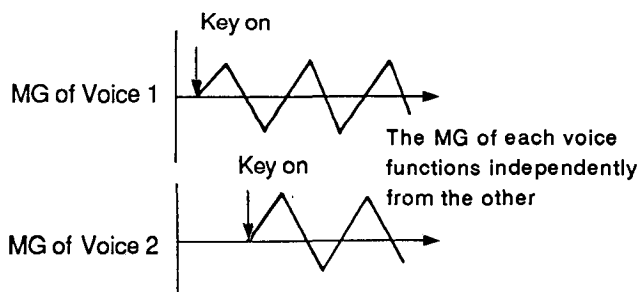

- * When Key Sync is OFF:

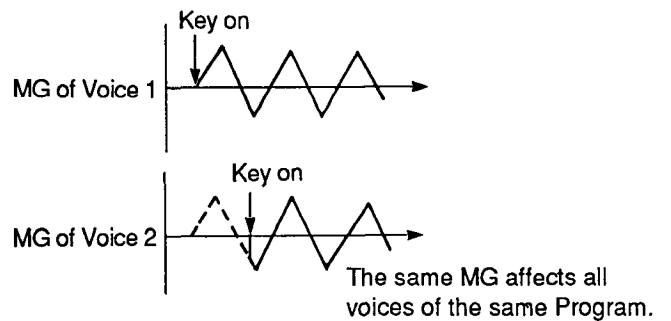

F 6 - 2 VDF MG (VDF Modulation)

PROG	I00	VDF MG	Waveform
SAW UP	F26	D53	I58 OFF Sync:OFF
<u>A</u>	<u>B</u>	<u>C</u>	<u>D</u> <u>E</u> <u>F</u> <u>G</u> <u>H</u>

VDF MG (VDF Modulation) varies the cutoff frequency periodically for filter sweep and wah-wah effects.

* The functions and parameters are the same as F6 -1 Pitch MG, as applied to modulation of the filter.

F 7 - 1 AFTER TOUCH

PROG	I00	AFTER TOUCH	Pitch
P+12	PM99	F+99	FM99 A+99
<u>A</u>	<u>B</u>	<u>C</u>	<u>D</u> <u>E</u> <u>F</u> <u>G</u> <u>H</u>

A	P	PITCH	-12 ~ +12	Variation of pitch by after touch (within ± 1 octave)
B	PM	Pitch MG	0 ~ 99	Effect of after touch on Pitch MG (F6-1)
D	F	VDF Cutoff	-99 ~ +99	Cutoff frequency (tone color) variation by after touch
E	FM	VDF MG	0 ~ 99	Effect of after touch on VDF MG (F6-2)
G	A	VDA Amplitude	-99 ~ +99	Effect of after touch on volume

* After Touch is an effect that can be used to change various parameters (such as pitch, volume, or tone color) when pressing down hard on the keys.

Pitch sets the width and direction of pitch change by after touch within the range of - 12 to + 12 (+/- 1 octave).

The larger the value to which Pitch MG (pitch modulation) is set, the greater the effect of Pitch MG becomes when pressing down hard on the keys. No change is made at 0.

* The modulation waveform, oscillator select and key sync of the VDF MG in F 6-2 are operative here.

When Cutoff is set to "+," the harder the keys are pressed, the greater the cutoff frequency (and the brighter the tone color) becomes. (The opposite occurs when setting to "-".)

The effect of the VDF MG becomes greater when pressing the keys down hard, when the VDF MG (VDF modulation) is set to higher values. No change is made at 0.

* The modulation waveform, oscillator select and key sync of the Pitch MG in F 6-1 are operative here.

When the VDA Amplitude is set to positive ("+"), the volume becomes louder upon pressing the keys down hard. The opposite occurs when setting it to "-".

F 7 - 2 CONTROLLER

PROG	I00	CONTROLLER	Pitch Bend
P+00	F+00	FM00 MF0	FM00 MF0
A	B	C	D
E	F	G	H

A P	Pitch Bend	-12 ~ +12	The maximum amount of pitch change by controller
B F	VDF Sweep Int.	-99 ~ +99	VDF cutoff frequency change by controller
D PM	Pitch MG	0 ~ 99	Pitch MG effect by controller
E MF	Pitch MG Frequency	0 ~ 3	Pitch MG speed change by controller
G FM	VDF MG Int.	0 ~ 99	VDF MG effect by controller
H MF	VDF MG Int.	0 ~ 3	VDF MG speed change by controller

This function determines the degree to which various aspects of the sound can be changed in real time by controllers such as joy sticks and modulation wheels from external MIDI keyboards.

On the M1R, pitch bend and VDF sweep effects can be controlled by a pitch bender, the pitch modulation effect can be controlled via control change (assign pedal/switch) 1, and the VDF modulation effect can be controlled via control change 2.

- * When the M1R is connected to the KORG M1, DS-8, or DSS-1, pitch bend can be controlled by moving the joy stick from left to right; pitch modulation can be controlled by moving the joy stick up, while VDF modulation effect can be controlled by moving the joy stick down.

Pitch Bend sets, in semitone units, the range over which pitch can be changed by pitch bend wheels and other controllers. 12 is the maximum value and is equal to 1 octave above the normal pitch.

VDF Sweep Int. (VDF Sweep Intensity) sets the depth of the VDF cutoff frequency change that occurs when joy sticks or other controllers are used.

The larger the value of Pitch MG Int. (Pitch MG Intensity), the greater the effect of Pitch MG is when using joy sticks or other controllers.

Pitch MG Frequency sets the degree to which joy sticks and other controllers affect the modulation applied to the pitch.

- * The modulation waveform, oscillator select and key sync of the Pitch MG in F 6-1 are operative here.

The larger the value of VDF MG Int. (VDF MG Intensity), the deeper the effect of the VDF MG when using joy sticks or other controllers.

VDF MG Frequency sets the degree to which joy sticks and other controllers affect the modulation applied to the VDF.

- * The modulation waveform, oscillator select and key sync of the VDF MG in F 6-2 are operative here.

EFFECT PARAMETERS

Descriptions of functions F 8 - 2 and F 8 - 4 are given in the Effect Parameter section following the EDIT PROGRAM Mode chapter.

F 8 - 1 EFFECT 1

EFFECT 1							
(01:	Hall)	:ON				
A	B	C	D	E	F	G	H

Selects the effect type for Effect 1.

A	EFFECT TYPE	01 ~ 33 No Effect
F	SWITCH	OFF/ON [SELECT]

F 8 - 3 EFFECT 2

Selects the effect type for Effect 2.
Same as F 8 - 1 EFFECT 1.

F 8 - 5 EFFECT PLACEMENT

EFFECT PLACEMENT							
SERIAL	P3 =50:50			P4 = 50:50			
A	B	C	D	E	F	G	H

B	Effect placement	PARALLEL SERIAL
F	P3 Out 3 Panpot	OFF 100:0 ~ 0:100
H	P4 Out 4 Panpot	OFF 100:0 ~ 0:100

This function sets the Effect Placement and Pan setting of Outputs 3 and 4. (See pp. 36-37 for more on Effect Placement.)

F 8 - 6 EFFECT COPY

EFFECT COPY							
from (COMBINATION)	-	100	[COPY]				
A	B	C	D	E	F	G	H

B	PROGRAM COMBINATION SONG
E	100 ~ 199 0~9
G	[COPY]

See the Effect Parameter section (p.38) for descriptions of F 8 - 2 and F 8 - 4, as well as more about all of the Effect functions.

- * Assigning effects to Programs can be done by Effect Copy (F 8 - 6).
- * The effects set here are used only when in PROGRAM Mode.
- * The output of Programs, with the exception of Drum Kit, are the same volume as input A and B of the effects in PROGRAM Mode. (No sound is output to C/D.)

F 9 - 1 WRITE/RENAME

PROG	I00	A.PIANO	Write/Rename
		[◀] [▶]	[WRITE]-->I00
A	B	C	D
E	F	G	H

[C]	[◀] Cursor Left		Moves the rename cursor to the left
[D]	[▶] Cursor Right		Moves the rename cursor to the right
[F]	[WRITE]		Executing the WRITE
[H]		I00 ~ I99 C00 ~ C99	Program number to be written

Writes the edited Program to internal memory or to the RAM card.

1. The Program can be named by using [◀] (cursor key [C]), [▶] (cursor key [D]), the VALUE slider and UP (▲)/DOWN (▼) keys.

* Letters, numbers and symbols, up to a maximum of 10 characters can be stored.

```
!"#$%&'()*+,-./0123456789:;<=>?
@ABCDEFGHIJKLMNPOQRSTUVWXYZ[#]^_
`abcdef9hijklmnopqrstuvwxyz{|}~*
```

* The write function cannot be executed when the Program memory protect is set to ON. (Releasing the memory protect can be done in the GLOBAL Mode, Function F 6-1.)

2. Program number to which the Program will be stored (cursor key [H]).

* 150 to I99 cannot be selected when large sequence allocation is selected.

* Card memory programs (C00 to C99) can be selected when the formatted COMBI/PROG or COMBI/PROG/SEQ RAM card is inserted in the PROG/SEQ slot.

3. Press WRITE (cursor key [F]).

4. "Are You Sure ?" will show on the display. When you want to write, press [YES] (cursor key [G]).

* Note that the Program which previously occupied that number will be lost.

* The WRITE operation can be cancelled by pressing [NO] or cursor key [H].

The display "Write Completed" is shown when the write operation is finished.

* The original display is returned to when pressing any cursor key ([A] -- [H]).

* Select this page once more when writing another Program.

* When copying a Program within internal memory to another Program number, select the Program to be copied in the PROGRAM Mode, then write to memory using this page.

3 -- EFFECT PARAMETERS

A two-system, two-channel Multi Digital Effect unit is built into the MIR. Each effect has a wide range of effect types that can be selected, such as reverb, delay, chorus, flanger, phase shifter, distortion and exciter, and fine adjustment of all effect parameters is possible.

Since all effects can be assigned separately to each Program, Combination and song track, you can use the most appropriate effect for each and every playing situation.

- * The Effect functions can be considered together as an additional element in the sound making process since effect settings can be changed for each Program.
- * Assigning different effects to specific Programs is possible when using Drum Kit Programs, Combinations and the sequencer.

Editing of the effect parameters is executed in the Edit Program Mode, Edit Combination Mode or Sequencer Mode. (Details of editing and parameters are identical.)

The Effect section is comprised of 2 effects and 2 panpots with a 4-input (A, B, C and D) and 4-output (1/L, 2/R, 3 and 4) configuration.

For the placement of the 2 effects, there are 2 operation modes: serial and parallel. (All signal routing is digital; the signal is changed from digital to audio with the D/A converter only after passing through the Effect section.)

EFFECT PLACEMENT

Serial Routing

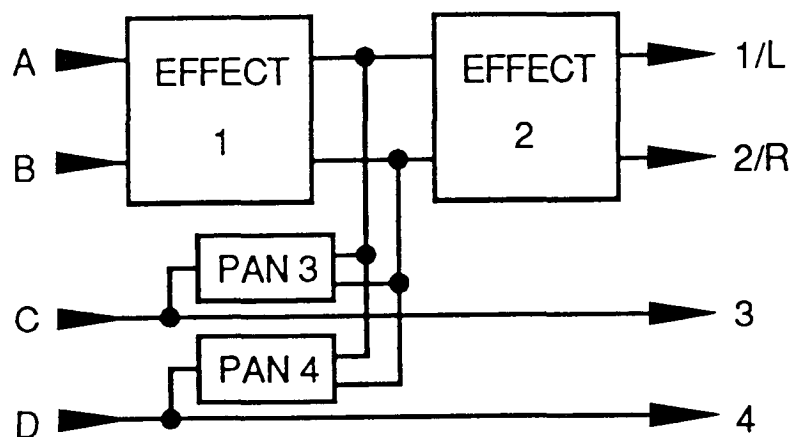

Inputs A and B send signals to both Effect 1 and Effect 2 and are output from 1/L and 2/R.

Signals from C and D are output through 3 and 4 unprocessed. The output signals from 3 and 4 can also be mixed with the A and B inputs to be routed together through Effect 2.

- * Selected Programs can be processed through Effect 1 and other Programs not, while all Programs -- processed or not -- can be routed through Effect 2; this kind of setting is possible by using the C and D inputs.

Parallel Routing

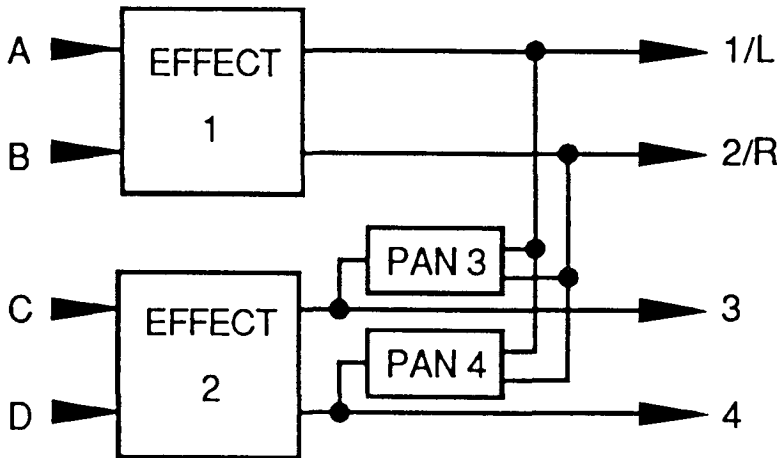

Different effects are used for each input pair, inputs A and B, and inputs C and D, and each of them are sent directly to outputs 1/L, 2/R, 3 and 4. The outputs from 3 and 4 can be mixed with the Effect 1 outputs and sent through the outputs 1/L and 2/R.

- * There are two types of effects: effects 1 - 25 are stereo effects and 26 - 33 are dual effects in which each channel has a different effect.
- * Signal routing for inputs A through D is set by using the panpot functions in the Combination parameter in the COMBINATION Mode and the Track parameter in the SEQUENCER Mode. Instrument Pan (Global F 4) is available for Programs of the drum kit. Programs with the exception of drum kit are input to A and B in a ratio of 5:5 and not input to C and D.
- * The following various settings are possible by setting the pans of each Program by using Output 3 Pan and Output 4 Pan.
- * Different sounds that are output to C and D can be mixed with the stereo output by adjusting the pan setting of each Program with Output 3 Pan and Output 4 Pan.
- * When stereo effects have been selected for Effect 1 and 2, and the operation mode has been set to Parallel, stereo out mixed outputs of Effect 1 and Effect 2 can be used by setting Output 3 Pan to 100 : 0, and Output 4 Pan to 0: 100.
- * When using an external effect or mixer, outputs 3 and 4 can be used as separate outputs by setting the Output 3 Pan and Output 4 Pan to OFF.

F 8 - 1 EFFECT 1

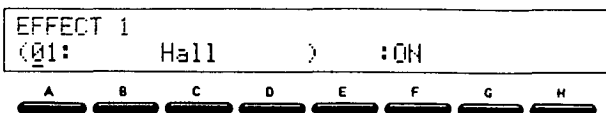

Selects the effect type for Effect 1.

[A]	EFFECT TYPE	01~33 No Effect	Selecting effect type Effect not used
[F]	SWITCH	OFF/ON	Effect operation switch
		[SELECT]	Executing the selection of effect type

- * [SELECT] is indicated on the display when the EFFECT TYPE is changed.
- * Select the EFFECT TYPE ([A]) and press [SELECT] ([F]); the effect type selected will now be in operation. (The selection is cancelled when selecting other effect types instead of pressing [SELECT].)

- * When selecting the effect type again, effect parameters will be set to the default value (see pp.56-57).
- * Note that among the 2-system effects, when #24 Symphonic Ensemble and #25 Rotary Speaker are both selected for one system, the Effect types which are marked with an asterisk on the following chart cannot be selected for the second effect. (Likewise, when an asterisk-indicated Effect type is selected for one system, #24 and #25 cannot be selected for the other. Refer to the Effect Parameter Default Values Chart, pp.56-57, for more information.)
- * See explanations about each effect type for details.
- * When assigning the footswitch to Effect in GLOBAL Mode F 2 - 2, Pedal Assign, the effect is toggled ON and OFF each time the footswitch is pressed.

Switch (**[F]**) indicates and sets the condition of the switch.

- * When selecting another Program, Combination or song, the ON/OFF setting returns to the condition set in the effect parameter of each mode.
- * For all effects except Reverb (01 to 06), Overdrive (21), Distortion (22) and Ensemble (24), the equalizer settings (Low EQ and High EQ) are effective even when the effect switch is OFF.

Set the effect type to No Effect when you want all effects, including the equalizer, to be off while editing Programs.

F 8 - 2 EFFECT 1 PARAMETER

Sets the parameter of Effect 1.

- * See explanations about each parameter type (starting on p. 40) since the details of the parameters differ depending on the parameter type.
- * The value set here is lost when selecting another effect type for Effect 1.

F 8 - 3 EFFECT 2 Selects the effect type for Effect 2.

Same as F 8 - 1 EFFECT 1.

F 8 - 4 EFFECT 2 PARAMETER

Sets the parameters of Effect 2.

- * See explanations about each parameter (starting on p. 40) type since the details of the parameters differ depending on the parameter type.
- * The value set here is lost when selecting another effect type for Effect 2.

F 8 - 5 EFFECT PLACEMENT

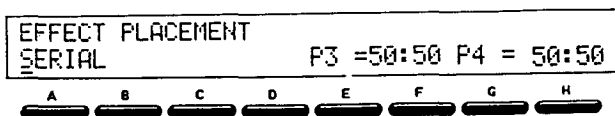

[A]	Effect Placement	PARALLEL SERIAL	Selection of effect operation mode Parallel Serial
[F] P3	OUT 3 Panpot	OFF 100:0~0:100	Output 3 pan not used Setting of output 3 pan (L:R)
[H] P4	OUT 4 Panpot	OFF 100:0~0:100	Output 4 pan not used Setting of output 4 pan (L:R)

This function sets the Effect Placement and Pan setting of Outputs 3 and 4. (See pp.36-37 for more on Effect Placement.)

F 8 - 6 EFFECT COPY

EFFECT COPY							
from (COMBINATION) - I00 [COPY]							
A	B	C	D	E	F	G	H

B	PROGRAM COMBINATION SONG	Copying from Program Copying from Combination Copying from song
E	I00-I99 0~9	Number of Program/Combination to be copied Number of song to be copied
G	[COPY]	Executing the copy

Copies only effect parameters from the Combination, Program and song in the memory.

* The parameters are copied to Combinations, Programs and songs when editing here.

1. Select the mode which has parameter to be copied (**B**).
2. Select the number to which the parameter will be copied. (Program number for the Program, Combination number for the Combination and song number for the song stored in the sequencer.)
3. The parameter is copied from the specified effect parameter by pressing [COPY] (**G**).

NAMES OF THE EFFECT TYPES AND AN OUTLINE OF EFFECT PARAMETERS

REVERB Group

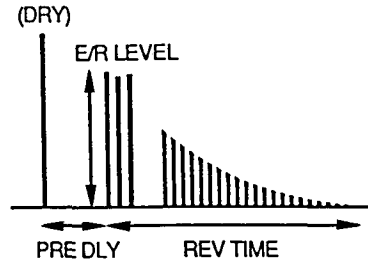
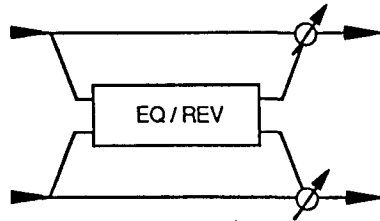

1. HALL

EFFECT 1	Hall	Reverb Time [S]
3.5	D055 E46 HD40	L-05 H+00 60:40
<u>A</u>	<u>B</u>	<u>C</u>
<u>D</u>	<u>E</u>	<u>F</u>
<u>G</u>	<u>H</u>	

The natural, spacious ambience characteristic of a hall.

2. ENSEMBLE HALL

EFFECT 1	Ensemble Hall	Pre Delay [mS]
2.8	D030 E46 HD40	L-03 H+00 60:40
<u>A</u>	<u>B</u>	<u>C</u>
<u>D</u>	<u>E</u>	<u>F</u>
<u>G</u>	<u>H</u>	

Similar to #1 Hall above, but especially suited for string and brass ensemble sounds.

3. CONCERT HALL

EFFECT 1	Concert Hall	E/R Level
3.8	D120 E46 HD40	L+00 H-02 60:40
<u>A</u>	<u>B</u>	<u>C</u>
<u>D</u>	<u>E</u>	<u>F</u>
<u>G</u>	<u>H</u>	

Similar again to #1 Hall above, but with particular emphasis on the early reflections characteristic of a large hall.

4. ROOM

EFFECT 1	Room	High Damp [%]
0.5	D022 E76 HD10	L+01 H-00 40:60
<u>A</u>	<u>B</u>	<u>C</u>
<u>D</u>	<u>E</u>	<u>F</u>
<u>G</u>	<u>H</u>	

The tight, well-defined reverberation patterns of a relatively small room.

5. LARGE ROOM

EFFECT 1	Large Room	EQ Low [dB]
1.5	D030 E76 HD30	L+02 H+04 60:40
<u>A</u>	<u>B</u>	<u>C</u>
<u>D</u>	<u>E</u>	<u>F</u>
<u>G</u>	<u>H</u>	

Emphasis here is on the relative density of the sound. An effect similar to gating can be achieved when the reverb time is set to 0.5 seconds.

6. LIVE STAGE

EFFECT 1	Live Stage	EQ High [dB]
2.0	D020 E60 HD20	L+03 H+00 60:40
<u>A</u>	<u>B</u>	<u>C</u>
<u>D</u>	<u>E</u>	<u>F</u>
<u>G</u>	<u>H</u>	

Reverberation characteristics of a relatively large room.

A	Reverb Time	0.2~9.9 [Sec.] (HALL group) 0.2~5.0 [Sec.] (ROOM group)	Time before reverberation decays.
B D	Pre Delay	0~200 [mSec]	Time between the direct sound and the first early reflections.
C E	E/R Level	0~90	Level of early reflections.
D HD	High Damp	0~99 [%]	The larger the value set, the faster the high frequencies are damped.
F L	EQ Low	-12 ~ +12 [dB]	Control for cutting or boosting the low frequency components.
G H	EQ High	-12 ~ +12 [dB]	Control for cutting or boosting the high frequency components.
H	Dry: EFF Balance	DRY. 99:1 ~ 1:99. EFF	Output balance of direct sound and effect sound

* The equalizer parameters in the reverb group (Low EQ and High EQ) control the effect sound but not the direct sound.

EARLY REFLECTION Group

Early Reflection is an effect that allows you to adjust only the early reflections, which are crucial in determining the realism of the reverb sound as it would be heard in an actual room, separate from the reverberant "wash." Adjustment of the E/R TIME permits a wide range of effects, such as adding density to the sound or achieving a "live" room sound with more discrete echoes and reflections.

7. EARLY REFLECTION I

EFFECT 1	Early Ref 1	E/R Time
170mS	0030	L+00 H+00 60:40
A	B	C D E F G H

8. EARLY REFLECTION II

EFFECT 1	Early Ref 2	Pre Delay [mS]
200mS	0020	L+00 H+00 60:40
A	B	C D E F G H

This is an effective program for reinforcing the low frequency range, as well as a general-purpose gating effect for use on drum sounds.

9. EARLY REFLECTION III

EFFECT 1	Early Ref 3	DRY:EFF Balance
190mS	0010	L+00 H+00 60:40
A	B	C D E F G H

Unlike EARLY REFLECTION I and EARLY REFLECTION II, this effect uses a reverse envelope on the early reflections. A reverse effect (similar to a tape recorder being played backwards) can be applied to sounds which have strong attack characteristics, such as cymbals.

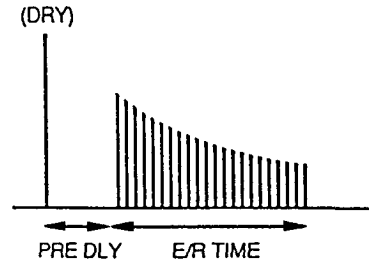
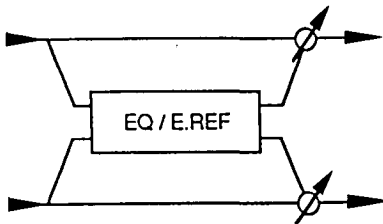

A	E/R Time	100~800 [mSec]	E/R time
C D	Pre Delay	0~200 [mSec]	Time between direct sound and E/R sound
F L	EQ Low	-12 ~ +12 [dB]	Identical to corresponding parameters in the REVERB group
G H	EQ High	-12 ~ +12 [dB]	Gain to cut or boost the high range components
H	DRY:EFF Balance	DRY. 99:1 ~ 1:99. EFF	Output balance of direct sound and effect sound

* The equalizer parameters in the E/R group (Low EQ and High EQ) are applied to the effect sound but not the direct sound.

DELAY Group

Delay patterns here make the use of a stereo configuration; the delay time can be set independently for the left and right channels. The natural damping of high frequencies for more accurate reproduction of the decay of high frequencies in an actual room can be achieved by using the high damp parameter.

10. STEREO DELAY

A stereo delay effect having two delay systems, each of which has a feedback circuit that sends part of the sound back to the delay again. All parameters except delay time are set to the same value for the two delays.

EFFECT 1 Stereo Delay		Time L [mS]
L250 R260 F+50 HD10	L+00 H+00	70:30
A	B	C
D	E	F
G	H	

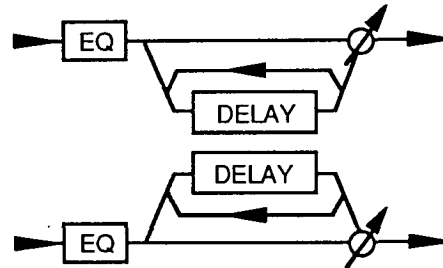

11. CROSS DELAY

A stereo delay in which the feedback signal of each delay crosses over and is routed to the other delay.

EFFECT 1 Cross Delay		Feedback [%]
L180 R360 F+80 HD10	L+00 H+00	70:30
A	B	C
D	E	F
G	H	

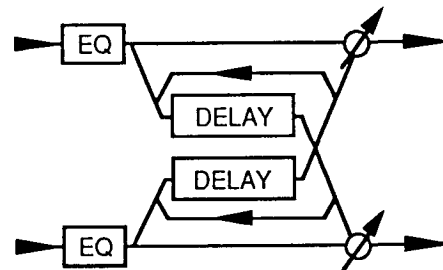

A L	Delay Time Left	0-500 [mSec]	Time between the direct sound and effect sound of the left channel (Input A or C)
B R	Delay Time Right	0-500 [mSec]	Time between the direct sound and effect sound of the right channel (Input B or D)
C F	Feedback	-99 ~ +99 [%]	Amount of feedback (negative values produce inverted phase)
D HD	High Damp	0-99 [%]	The larger the value set, the faster the frequencies are damped.
F L	EQ Low	-12 ~ +12 [dB]	Control for cutting or boosting the low frequency components.
G H	EQ High	-12 ~ +12 [dB]	Control for cutting or boosting the high frequency components.
H	DRY:EFF Balance	DRY. 99:1 ~ 1:99, EFF	Output balance of direct sound and effect sound

CHORUS Group

This is a stereo effect that combines two chorus circuits and imparts a natural, warm and "fat" sound to any instrument sound and is particularly effective with piano, strings and brass.

12. STEREO CHORUS I

A stereo effect that combines two chorus circuits. A swirling, constantly changing sound that moves between the stereo outputs is created through phase inversion of the two circuits.

EFFECT 1 Chorus 1		Mod Depth	
M60	S0.30	D010	TRI
		L+00	H+00 60:40
A	B	C	D
E	F	G	H

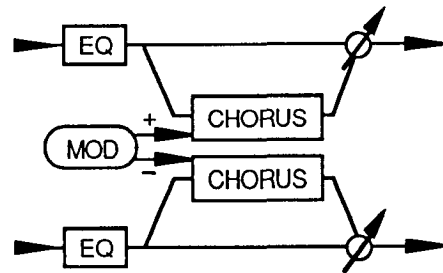

13. STEREO CHORUS II

Similar to STEREO CHORUS I except that there is no phase inversion.

EFFECT 1 Chorus 2		Mod Waveform	
M20	S2.40	D005	SIN
		L+00	H+00 60:40
A	B	C	D
E	F	G	H

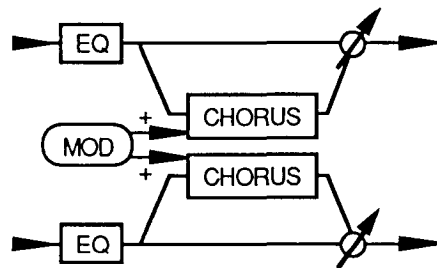

[A] M	Mod Depth	0~99	Intensity of modulation
[B] S	Mod Speed	0.03~30 [Hz]	Speed of modulation (frequency)
[C] D	Delay Time	0~200 [mSec]	Time between direct sound and effect sound
[D]	Mod Waveform	SIN TRI	Selection of waveform Sine wave ~ Triangle wave ^
[F] L	EQ Low	-12 ~ +12 [dB]	Gain to cut or boost the low range components
[G] H	EQ High	-12 ~ +12 [dB]	Gain to cut or boost the high range components
[H]	DRY:EFF Balance	DRY, 99:1 ~ 1:99, EFF	Output balance between direct sound and effect sound

FLANGER Group

This effect is achieved by the addition of feedback to the chorus effect. Since its pronounced swirling adds color and motion, it is most effective with sounds that have many harmonics, such as cymbals.

14. STEREO FLANGER

A stereo effect that combines two flanger circuits. The swirling and swishing effect that moves expansively between the stereo outputs is enhanced by phase inversion of the two flanger circuits.

EFFECT 1 Flanger		Mod Depth	
M70	S0.18	D00	F-75
SIN		L+00	H+00
40:60			
A	B	C	D
E	F	G	H

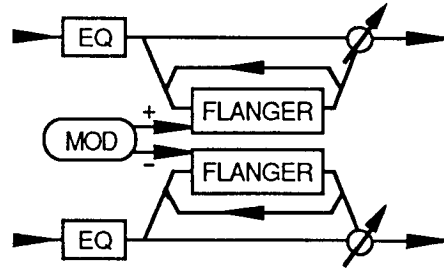

15. CROSS FLANGER

A flanger effect in which the feedback signal of each flanger circuit crosses over and is routed to the other flanger. See #11 CROSS DELAY for more on feedback.

EFFECT 1 Cross Flanger		Mod Speed [Hz]	
M37	S0.21	D25	F+80
SIN		L+00	H+00
25:75			
A	B	C	D
E	F	G	H

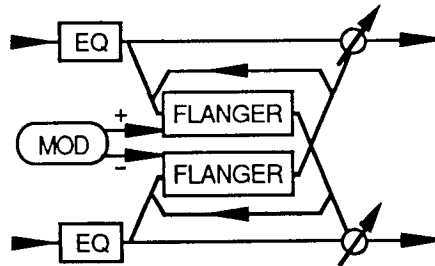

[A] M	Mod Depth	0 ~ 99	Depth of flanging effect
[B] S	Mod Speed	0.03-30 [Hz]	Speed of modulation
[C] D	Delay Time	0~50[mSec]	Time between direct sound and effect sound
[D] F	Feedback	-99 ~ +99 [%]	Amount of feedback (negative values produce inverted phase)
[E]	Mod Waveform	SIN TRI	Selecting waveform Sine wave \sim Triangle wave \sim
[F] L	EQ Low	-12 ~ +12 [dB]	Gain to cut and boost the low range components
[G] H	EQ High	-12 ~ +12 [dB]	Gain to cut or boost the high range components
[H]	DRY:EFF Balance	DRY, 99:1 ~ 1:99, EFF	Output balance between direct sound and effect sound

PHASE SHIFTER (Phaser) Group

Compared to the chorus and flanger programs, which use time delay to achieve their distinctive effects, the phase shifter programs use both time delay and phase shifting to create a more pronounced swirling and swishing sound than either chorus or flanger. It is most effective on electronic piano and guitar sounds.

16. PHASER I

This is a stereo effect that combines two phaser circuits. The swirling and swishing effect that moves expansively between the stereo outputs is enhanced by phase inversion of the two phaser circuits.

EFFECT 1 Phaser 1		Manual
MN99	50.69 M60 F-75	SIN 25:75
A	B	C
D	E	F
G	H	

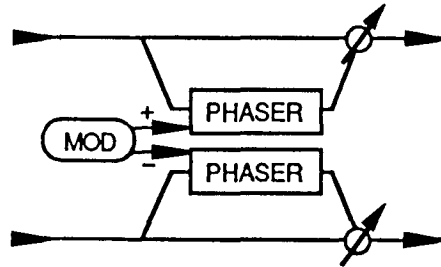

17. PHASER II

Similar to PHASE SHIFTER I except that there is no phase inversion.

EFFECT 1 Phaser 2		Feedback [%]
MN99	50.57 M69 F+87	TRI 60:40
A	B	C
D	E	F
G	H	

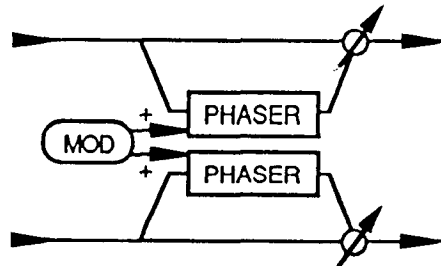

[A] MN	Manual	0~99	Center frequency which phase shift affects
[B] S	Mod Speed	0.03~30 [Hz]	Speed of modulation
[C] M	Mod Depth	0~99	Depth of phase shift
[D] F	Feedback	-99 ~ +99 [%]	Amount of feedback (negative values produce inverted phase)
[E]	Mod Waveform	SIN TRI	Selection of modulation waveform Sine wave \sim Triangle wave ∇
[H]	DRY:EFF Balance	DRY, 99:1 ~ 1:99, EFF	Output balance of direct sound and effect sound

TREMOLO Group

This effect periodically varies (or modulates) the volume.

18. STEREO TREMOLO I

This is a stereo effect that combines two tremolo circuits. The stereo effect is enhanced by phase inversion of the two tremolo circuits and automatic panning between the left and right outputs.

EFFECT 1 Tremolo 1		Mod Depth		
M80	S1.59	SIN	S+99	L+00 H+00 EFF
A	B	C	D	E F G H

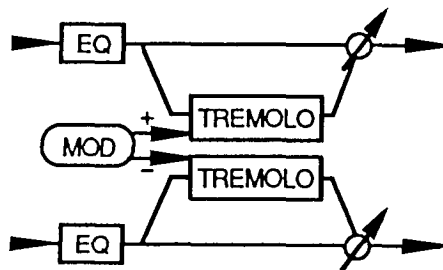

19. STEREO TREMOLO II

Similar to STEREO TREMOLO I except that there is no phase inversion between the LFOs of the two tremolo circuits.

EFFECT 1 Tremolo 2		Shape		
M63	S4.00	TRI	S+00	L+00 H+00 EFF
A	B	C	D	E F G H

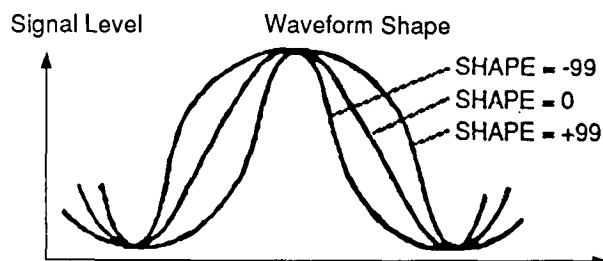
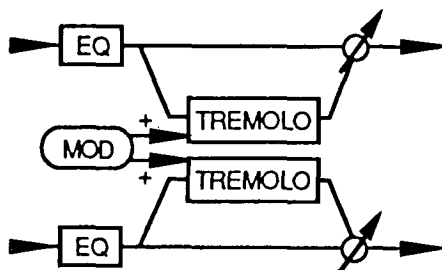

A	M	Mod Depth	0 ~ 99	Depth of tremolo effect
B	S	Mod Speed	0.03 ~ 30 [Hz]	Speed of modulation (tremolo effect)
C		Mod Waveform	SIN TRI	Selection of modulation waveform Sine wave \sim Triangle wave ∇
D	S	Shape	-99 ~ +99	Changing the modulation waveform (refer to the diagram above)
F	L	EQ Low	-12 ~ +12 [dB]	Gain that cuts or boosts low range components
G	H	EQ High	-12 ~ +12 [dB]	Gain that cuts or boosts high range components
H		DRY:EFF Balance	DRY, 99:1 ~ 1:99, EFF	Output balance between direct sound and effect sound

EQUALIZER Group

20. EQUALIZER

This is a 2-band (low range and high range) equalizer. It decreases (cuts) or increases (boosts) the components of each frequency range.

EFFECT 1	Equalizer	Low Gain [dB]
L+00	500	H+00 2K
		EFF

A B C D E F G H

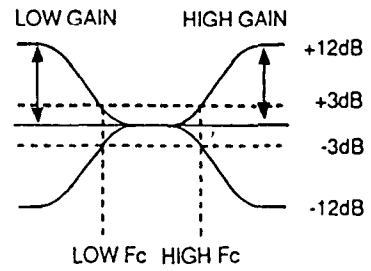
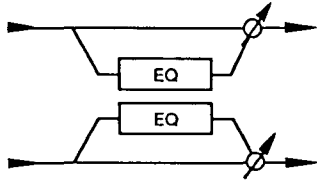

A L	Low Gain	-12 ~ +12 [dB]	Gain which cuts or boosts low range components
B	Low Fc (Low Cutoff)	250/500/1K [Hz]	Low frequency point at which boost or cut will be made
E H	High Gain	-12 ~ +12 [dB]	Gain that cuts or boosts the high range components
F	High Fc	1K/2K/4K [Hz]	High frequency at which boost or cut will be made
H	DRY:EFF Balance	DRY, 99:1 ~ 1:99, EFF	Output balance of direct sound and effect sound

OVERDRIVE Group

21. OVERDRIVE

This is an effect that simulates the overdrive used generally for guitars, and is particularly effective when applied to guitar-like lines and solos.

EFFECT 1	Over	Drive	Drive					
000	L32	M+00	1K	L+00	H+00	EFF		
A	B	C	D	E	F	G	H	

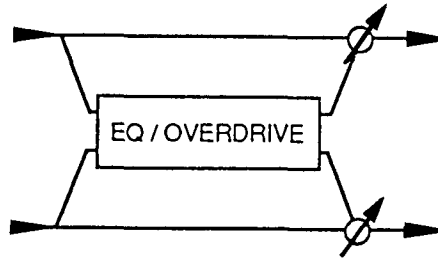

A D	Drive	0 ~ 99	Overdrive of input signal
B L	Level	0 ~ 99	Output level of processed sound
F L	EQ Low	-12 ~ +12 [dB]	Gain that cuts or boosts low range components
G H	EQ High	-12 ~ +12 [dB]	Gain that cuts or boosts high range components
H	DRY:EFF Balance	DRY, 99:1 ~ 1:99, EFF	Output balance between direct sound and effect sound

22. DISTORTION

Compared with OVERDRIVE, this effect has a "dirtier" sound with more of a hard edge and is excellent for simulating a fuzz distortion sound. As with OVERDRIVE, it is effective when used in solos.

EFFECT 1	Over	Drive	Drive					
000	L15	M+00	1K	L+00	H+00	EFF		
A	B	C	D	E	F	G	H	

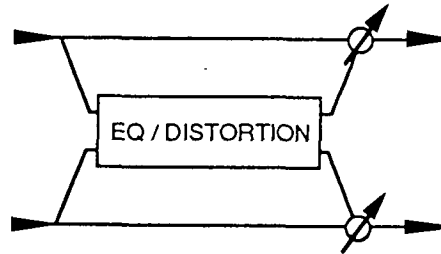

A D	Distortion	0 ~ 99	Amount of distortion applied to the input signal
B L	Level	0 ~ 99	Output level of distorted sound
F L	EQ Low	-12 ~ +12 [dB]	Gain that cuts or boosts low range components
H	DRY:EFF Balance	DRY, 99:1 ~ 1:99, EFF	Output balance of direct sound and effect sound

EXCITER Group

23. EXCITER

This is an effect that increases the clarity of the sound, gives it greater definition and presence, and helps in bringing the sound to the forefront.

EFFECT 1	Exciter	Blend						
B+99	EP05	L+00	H+00	EFF				
A	B	C	D	E	F	G	H	

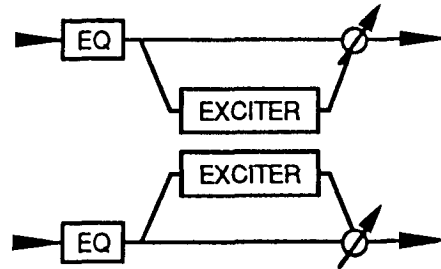

A B	Blend	-99 ~ +99	Setting the balance of the unprocessed and the exciter signals following the circuit.
C EP	Emphatic Point	1~10	Central frequency emphasized by exciter
F L	EQ Low	-12 ~ +12 [dB]	Gain that cuts or boosts low range components
G H	EQ High	-12 ~ +12 [dB]	Gain that cuts or boosts high range components
H	DRY:EFF Balance	DRY, 99:1 ~ 1:99, EFF	Output balance of direct sound and effect sound

ENSEMBLE Group

24. SYMPHONIC ENSEMBLE

This effect is designed to be most effective for ensemble sounds like strings by applying greater modulation in a chorus-type program.

EFFECT 1	Symphonic Ens	Mod Depth						
M00		L+00	H+00	50:50				
A	B	C	D	E	F	G	H	

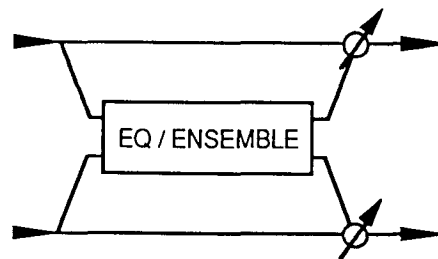

A M	Mod Depth	0 ~ 99	Depth of ensemble effect
F L	EQ Low	-12 ~ +12 [dB]	Gain that cuts or boosts low range components
G H	EQ High	-12 ~ +12 [dB]	Gain that cuts or boosts high range components
H	DRY:EFF Balance	DRY, 99:1 ~ 1:99, EFF	Output balance between direct sound and effect sound

ROTARY EFFECT

25. ROTARY SPEAKER

This effect is designed to duplicate the rotational (Leslie) speaker effect popular for organ sounds.

The speed changes characteristic of the Leslie speaker can also be made in real time with the use of a foot controller .

- * The foot controller normally assigned to control the dry sound/effect sound balance does not control that parameter here, but is instead used to control the speed selection of the rotary effect. The pedal works as a switch and the speed of the rotary effect gradually changes regardless of the speed with which the pedal is moved.

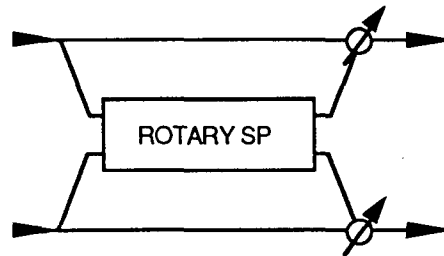
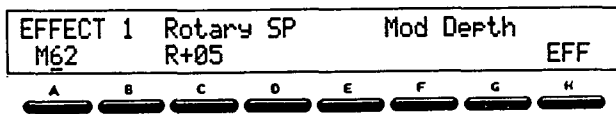

[A] M	Mod Depth	0 ~ 99	Depth of effect
[C] R	Speed Ratio	-10 ~ +10	Ratio of rotation speed of the high range speaker to the rotation speed of the low range speaker
[H]	DRY:EFF Balance	DRY, 99:1 ~ 1:99, EFF	Output balance of direct sound and effect sound

COMBINATION Effects Group

Effect programs 26 to 33 are combination effects in which different effects are assigned to the two channels. Each effect can even be used in the two-system (Effect 1 and 2) configuration common to the other programs.

The diagram shows a parallel arrangement in which #26 DELAY/HALL is selected for Effect 1 and #31 DELAY/FLANGER for Effect 2.

- * See the explanation of effect programs #1 to #26 for details about each effect.

- * Parameters A to D correspond to one effect and E to H to the other one.

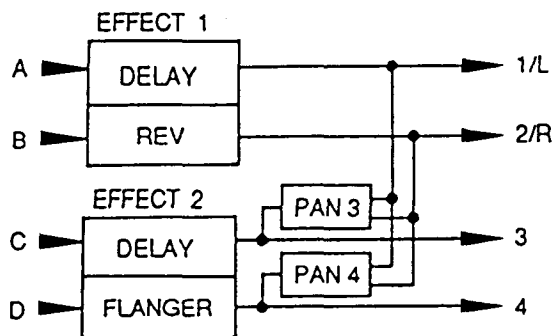

26. DELAY/HALL

```
EFFECT 1 Delay/Hall   Reverb Time [S]
0250 F+50 HD10 70:30 3.5 D055 HD40 60:40
```

DELAY

A D	Delay time	0~500 [mSec]	Time from direct sound to effect sound
B F	Feedback	-99 ~ +99 [%]	Amount of feedback (negative values produce inverted phase)
C HD	High Damp	0~99 [%]	The larger the value set, the faster the high frequencies are damped.
D	DRY:EFF Balance	DRY, 99:1 ~ 1:99, EFF	Output balance of direct sound and effect sound

HALL

E	Reverb Time	0.2~ 9.9 [Sec]	Time before reverberation decays.
F D	Pre Delay	0 ~ 150 [mSec]	Time between the direct sound and the first early reflection.
G HD	High Damp	0 ~ 99 [%]	The larger the value set, the faster the high frequencies are damped.
H	DRY:EFF Balance	DRY, 99:1 ~ 1:99, EFF	Output balance between direct sound and effect sound.

27. DELAY/ROOM

```
EFFECT 1 Delay/Room   Pre Delay [mS]
0250 F+50 HD10 70:30 1.5 D030 HD30 60:40
```

DELAY

A D	Delay time	0 ~ 500 [mSec]	Time from direct sound to effect sound
B F	Feedback	-99 ~ +99 [%]	Amount of feedback (negative values produce inverted phase)
C HD	High Damp	0 ~ 99 [%]	The larger the value set, the faster the high frequencies are damped.
D	DRY:EFF Balance	DRY, 99:1 ~ 1:99, EFF	Output balance of direct sound and effect sound

ROOM

E	Reverb Time	0.2~50 [Sec] (ROOM)	Output level of processed sound
F D	Pre Delay	0~150 [mSec]	Time between the direct sound and first early reflections
G HD	High Damp	0~99 [%]	The larger the value set, the faster the high frequencies are damped.
H	DRY:EFF Balance	DRY, 99:1 ~ 1:99, EFF	Output balance between direct sound and effect sound.

28. DELAY/EARLY REFLECTION

EFFECT 1	Delay/E.Ref	E/R Time [mS]
0250	F+50 HD10 70:30 200	0030 60:40

A B C D E F G H

DELAY

A D	Delay time	0~500 [mSec]	Time from direct sound to effect sound
B F	Feedback	-99 ~ +99 [%]	Amount of feedback (negative values produce inverted phase)
C HD	High Damp	0~99 [%]	The larger the value set, the faster the high frequencies are damped.
D	DRY:EFF Balance	DRY, 99:1 ~ 1:99, EFF	Output balance of direct sound and effect sound

EARLY REFLECTION

E	E/R Time	100~400 [mSec]	E/R time
F D	Pre Delay	0~150 [mSec]	Time between the direct sound and E/R sound
H	DRY:EFF Balance	DRY, 99:1 ~ 1:99, EFF	Output balance of direct sound and effect sound

29. DELAY/DELAY

EFFECT 1	Delay/Delay	Time L [mS]
250	F+50 HD10 70:30 260	F+50 HD10 70:30

A B C D E F G H

DELAY

A	Delay Time	0 ~ 500 [mSec]	Same as DELAY of #26 DELAY/HALL
B F	Feedback	-99 ~ +99 [%]	
C HD	High Damp	0 ~ 99 [%]	
D	DRY:EFF Balance	DRY, 99:1 ~ 1:99, EFF	

DELAY

E	Delay Time	0 ~ 500 [mSec]	Same as above
F F	Feedback	-99 ~ +99 [%]	
G HD	High Damp	0 ~ 99 [%]	
H	DRY:EFF Balance	DRY, 99:1 ~ 1:99, EFF	

30. DELAY/CHORUS

EFFECT 1	Delay/Chorus	Mod Depth
250	F+50 HD10 70:30 M60	0.30 TRI 60:40

A
B
C
D
E
F
G
H

DELAY

A	Delay time	0 ~ 500 [mSec]	Same as DELAY of #26 DELAY/HALL
B F	Feedback	-99 ~ +99 [%]	
C HD	High Damp	0 ~ 99 [%]	
D	DRY:EFF Balance	DRY, 99:1 ~ 1:99, EFF	

CHORUS

E M	Mod Depth	0 ~ 99 [%]	Intensity of modulation effect
F	Mod Speed	0.03 ~ 30 [Hz]	Speed of modulation (frequency)
G	Mod Waveform	SIN \sim TRI \sim	Selection of waveform Sine wave Triangle wave
H	DRY:EFF Balance	DRY, 99:1 ~ 1:99, EFF	Sound volume balance of direct sound and effect sound

31. DELAY/FLANGER

EFFECT 1	Delay/Flanger	Mod Depth
250	F+50 HD10 70:30 M70	0.18 F-75 40:60

A
B
C
D
E
F
G
H

DELAY

A D	Delay time	0~500 [mSec]	Same as DELAY of #26 DELAY/HALL
B F	Feedback	-99 ~ +99 [%]	
C HD	High Damp	0~99 [%]	
H	DRY:EFF Balance	DRY, 99:1 ~ 1:99, EFF	

FLANGER

E M	Mod Depth	0 ~ 99 [%]	Depth of flanging effect
F	Mod Speed	0.03 ~ 30 [Hz]	Speed of modulation
G F	Feedback	-99 ~ +99 [%]	Amount of feedback (negative values produce inverted phase)
H	DRY:EFF Balance	DRY, 99:1 ~ 1:99, EFF	Output balance of direct sound and effect sound

32. DELAY/PHASER

EFFECT 1	Delay/Phaser	Mod Speed [Hz]
250	F+50 HD10 70:30 M60 0.69	F-75 25:75
A	B	C
D	E	F
G	H	

DELAY

A	Delay time	0 ~ 500 [mSec]	Same as DELAY of #26 DELAY/HALL
B F	Feedback	-99 ~ +99 [%]	
C HD	High Damp	0 ~ 99 [%]	
D	DRY:EFF Balance	DRY, 99:1 ~ 1:99, EFF	

PHASER

E M	Mod Depth	0 ~ 100 [%]	Depth of phase shift
F	Mod Speed	0.03 ~ 30 [Hz]	Speed of modulation
G F	Feedback	-99 ~ +99 [%]	Amount of feedback (negative values produce inverted phase)
H	DRY:EFF Balance	DRY, 99:1 ~ 1:99, EFF	Output balance of direct sound and effect sound

33. DELAY/TREMOLO

EFFECT 1	Delay/Tremolo	Shape
250	F+50	HD10 70:30 M80 1.59 S+00 EFF

A B C D E F G H

DELAY

A D	Delay Time	0 ~ 500 [mSec]	Same as Delay of #26 DELAY/HALL
B F	Feedback	-99 ~ +99	
C HD	High Damp	0 ~ 99	
D	DRY:EFF Balance	DRY, 99:1 ~ 1:99, EFF	

TREMOLO

E M	Mod Depth	0 ~ 99	Depth of tremolo effect
F	Mod Speed	0.03 ~ 30 [Hz]	Speed of modulation
G S	Shape	-99 ~ +99	Changing the modulation waveform
H	DRY:EFF Balance	DRY, 99:1 ~ 1:99, EFF	Output balance between direct sound and effect sound

EFFECT PARAMETERS DEFAULT VALUES CHART

NO.	EFFECT	A	B	C	D
		REVERB TIME	PRE DELAY	E/R LEVEL	HIGH DAMP
0 1	HALL	3.5S	55mS	46	40%
0 2	ENSEMBLE HALL	2.8S	30mS	46	40%
0 3	CONCERT HALL	3.8S	120mS	46	40%
0 4	ROOM	0.5S	22mS	76	10%
0 5	LARGE ROOM	1.5S	30mS	76	30%
0 6	LIVE STAGE	2.0S	20mS	60	20%
		E/R TIME		PRE DELAY	
0 7	EARLY REF 1	170mS		30mS	
0 8	EARLY REF 2	200mS		20mS	
0 9	EARLY REF 3	190mS		10mS	
		DELAY TIME L	DELAY TIME R	FEEDBACK	HIGH DAMP
1 0	STEREO DELAY	250mS	260mS	+50%	10%
1 1	CROSS DELAY	180mS	360mS	+80%	10%
		MOD DEPTH	SPEED	DELAY TIME	WAVEFORM
1 2	STEREO CHORUS 1 *	60	0.30Hz	10mS	TRI
1 3	STEREO CHORUS 2 *	20	2.40Hz	5mS	SIN
		MOD DEPTH	SPEED	DELAY TIME	FEEDBACK
1 4	STEREO FLANGER *	70	0.18Hz	0mS	-75%
1 5	CROSS FLANGER *	37	0.21Hz	25mS	+80%
		MANUAL	SPEED	MOD DEPTH	FEEDBACK
1 6	PHASER 1 *	99	0.69Hz	60	-75%
1 7	PHASER 2 *	99	0.57Hz	69	+87%
		MOD DEPTH	SPEED	WAVEFORM	SHAPE
1 8	STEREO TREMOLO 1 *	80	1.59Hz	SIN	+99
1 9	STEREO TREMOLO 2 *	63	4.00Hz	TRI	0
		LOW GAIN	LOW FC		
2 0	EQUALIZER	0dB	500Hz		
		DRIVE	LEVEL		
2 1	OVER DRIVE	80	15		
		DISTORTION	LEVEL		
2 2	DISTORTION	80	20		
		BLEND		EMPHATIC	
2 3	EXCITER	+99		5	
		MOD DEPTH			
2 4	SYMPHONIC ENS *	80			
		MOD DEPTH		SPEED RATIO	
2 5	ROTARY SPEAKER *	62		+5	
		DELAY TIME	FEEDBACK	HIGH DAMP	DRY: EFF
2 6	DELAY/HALL	250mS	+50%	10%	70:30
2 7	DELAY/ROOM	250mS	+50%	10%	70:30
		DELAY TIME	FEEDBACK	HIGH DAMP	DRY: EFF
2 8	DELAY/E. REF	250mS	+50%	10%	70:30
		DELAY TIME	FEEDBACK	HIGH DAMP	DRY: EFF
2 9	DELAY/DELAY	250mS	+50%	10%	70:30
		DELAY TIME	FEEDBACK	HIGH DAMP	DRY: EFF
3 0	DELAY/CHORUS *	250mS	+50%	10%	70:30
		DELAY TIME	FEEDBACK	HIGH DAMP	DRY: EFF
3 1	DELAY/FLANGER *	250mS	+50%	10%	70:30
		DELAY TIME	FEEDBACK	HIGH DAMP	DRY: EFF
3 2	DELAY/PHASER *	250mS	+50%	10%	70:30
		DELAY TIME	FEEDBACK	HIGH DAMP	DRY: EFF
3 3	DELAY/TREMOLO *	250mS	+50%	10%	70:30

When using an effect marked with an asterisk (*) for one of the effects, neither #24 SYMPHONIC ENS nor #25 ROTARY SPEAKER can be selected for the other one.

E	F	G	H	NO.	NOTES
	EQ LOW	EQ HIGH	DRY:EFF		
	-5dB	0dB	60:40	0 1	
	-3dB	0dB	60:40	0 2	
	0dB	-2dB	60:40	0 3	
	+1dB	0dB	40:60	0 4	
	+2dB	+4dB	60:40	0 5	
	+3dB	0dB	60:40	0 6	
	EQ LOW	EQ HIGH	DRY:EFF		
	0dB	0dB	60:40	0 7	
	0dB	0dB	60:40	0 8	
	0dB	0dB	60:40	0 9	
	EQ LOW	EQ HIGH	DRY:EFF		
	0dB	0dB	70:30	1 0	
	0dB	0dB	70:30	1 1	
	EQ LOW	EQ HIGH	DRY:EFF		
	0dB	0dB	60:40	1 2	*
	0dB	0dB	60:40	1 3	*
WAVEFORM	EQ LOW	EQ HIGH	DRY:EFF		
SIN	0dB	0dB	40:60	1 4	*
SIN	0dB	0dB	25:75	1 5	*
WAVEFORM			DRY:EFF		
SIN			25:75	1 6	*
TRI			60:40	1 7	*
	EQ LOW	EQ HIGH	DRY:EFF		
	0dB	0dB	EFF	1 8	*
	0dB	0dB	EFF	1 9	*
HIGH GAIN	HIGH FC		DRY:EFF		
0dB	2KHz		EFF	2 0	
	EQ LOW	EQ HIGH	DRY:EFF		
	0dB	0dB	EFF	2 1	
	EQ LOW		DRY:EFF		
	0dB		EFF	2 2	
	EQ LOW	EQ HIGH	DRY:EFF		
	0dB	0dB	EFF	2 3	
	EQ LOW	EQ HIGH	DRY:EFF		
	0dB	0dB	50:50	2 4	*
			DRY:EFF		
			EFF	2 5	*
REVERB TIME	PRE DELAY	HIGH DAMP	DRY:EFF		
3.5S	55mS	40%	60:40	2 6	
1.5S	30mS	30%	60:40	2 7	
E/R TIME	PRE DELAY		DRY:EFF		
200mS	30mS		60:40	2 8	
DELAY TIME	FEEDBACK	HIGH DAMP	DRY:EFF		
260mS	+50%	10%	70:30	2 9	
MOD DEPTH	SPEED	WAVEFORM	DRY:EFF		
60	0.30Hz	TRI	60:40	3 0	*
MOD DEPTH	SPEED	FEEDBACK	DRY:EFF		
70	0.18Hz	-75%	40:60	3 1	*
MOD DEPTH	SPEED	FEEDBACK	DRY:EFF		
60	0.69Hz	-75%	25:75	3 2	*
MOD DEPTH	SPEED	SHAPE	DRY:EFF		
80	1.59Hz	0	EFF	3 3	*

4 -- COMBINATION MODE

This mode allows you to select a Combination (combination of two or more Programs) and play it.

Combinations can be selected by the numeric keypad, UP/DOWN keys, footswitch (Prog/Combi Up/Down) or MIDI program change.

- * Combinations within the internal memory are selected when the INT key is pressed, and Combinations stored on card are selected when the CARD key is pressed.
- * To select Combinations by footswitch or MIDI, each function has to be set appropriately in the GLOBAL Mode.
- * There is no limit on the number of simultaneous voices that can be sounded by each selected Program; however, the total number of voices available cannot exceed 16.
- * In the COMBINATION Mode, the effect setting of each Program is ignored and the effect setting in the combination parameter is active.
- * When selecting and editing Programs in the PROGRAM and EDIT PROGRAM Mode and then moving to the COMBINATION Mode, the selected Program will be indicated in COMBINATION Mode displays by an asterisk in front of the Program number. (Edited programs can be monitored as part of combinations in the COMBINATION Mode.)

In order to edit more than two programs, writing one program to memory is necessary before the program can be called up again.

EDITING IN THE COMBINATION MODE

In the COMBINATION Mode, the program which is assigned to the Combination can be changed and the volume of each Program can be adjusted.

- * All Combination parameters here can be edited in the EDIT COMBINATION Mode as well.
- * Writing the Combination to memory can only be done in the EDIT COMBINATION Mode.

The display indicating the COMBINATION Mode changes according to the setting of the Combination type. (See p. 61 for more about Combination types.)

- * Changing the Combination type is done in the EDIT COMBINATION Mode.

SINGLE

COMBI I00 BaseSingle	Program
I01 E.Bass	Level=99

A
B
C
D
E
F
G
H

A	Program	I00~I99 C00~C99	Selection of Program
D	Level	0 ~ 99	Control of volume

LAYER

COMBI I01 Piano+Trp	Layer 1 Program
*I00 A.Piano L70	I02 Trumpet L82

A
B
C
D
E
F
G
H

A	Layer 1 Program	I00~I99 C00~C99	Program of layer 1
D L	Layer 1 Level	0 ~ 99	Volume of the Program assigned to layer 1
E	Layer 2 Program	I00~I99 C00~C99	Program of layer 2
H L	Layer 2 Level	0 ~ 99	Volume of the Program assigned to layer 2

SPLIT

COMBI I02 Uln/T.Sax				Upper Program			
*I00 Violin L99				I05 Tenor Sax L99			
A	B	C	D	E	F	G	H

A	Lower Program	I00~I99 C00~C99	Program assigned to the lower part of the keyboard (lower than the split point)
D L	Lower Level	0 ~ 99	Volume of the Program assigned to the lower part of the keyboard
E	Upper Program	I00~I99 C00~C99	Program assigned to the upper part of the keyboard (higher than the split point)
H L	Upper Level	0 ~ 99	Volume of the Program assigned to the upper part of the keyboard

VELOCITY SWITCH

COMBI I03 Flute/Str				Loud Program			
*I00 Flute L99				I10 Strings L99			
A	B	C	D	E	F	G	H

A	Soft Program	I00~I99 C00~C99	Program that will sound when the keys are struck softly
D L	Soft Level	0 ~ 99	Volume of the Program that will sound when the keys are struck softly
E	Loud Program	I00~I99 C00~C99	Program that will sound when the keys are struck hard
H L	Loud Level	0 ~ 99	Volume of the Program that will sound when the keys are struck hard

MULTI

COMBI I04 MultiCombi								T1=E.Bass							
I01		I02		I03		I05		I06		I09		I10		I12	
A	B	C	D	E	F	G	H								

- Toggling between the two sets of displays is done by the PAGE + key and the PAGE - key.

A	Timbre 1 Program	OFF/I00~I99, C00~C99	Program assigned to Timbre 1
B	Timbre 2 Program	OFF/I00~I99, C00~C99	Program assigned to Timbre 2
C	Timbre 3 Program	OFF/I00~I99, C00~C99	Program assigned to Timbre 3
D	Timbre 4 Program	OFF/I00~I99, C00~C99	Program assigned to Timbre 4
E	Timbre 5 Program	OFF/I00~I99, C00~C99	Program assigned to Timbre 5
F	Timbre 6 Program	OFF/I00~I99, C00~C99	Program assigned to Timbre 6
G	Timbre 7 Program	OFF/I00~I99, C00~C99	Program assigned to Timbre 7
H	Timbre 8 Program	OFF/I00~I99, C00~C99	Program assigned to Timbre 8

COMBI 104 MultiCombi	Timbre 1 Level
99 95 74 58 77 33 11 96	

A
B
C
D
E
F
G
H

A	Timbre 1 Level	0~99	Level of the Program assigned to Timbre 1
B	Timbre 2 Level	0~99	Level of the Program assigned to Timbre 2
C	Timbre 3 Level	0~99	Level of the Program assigned to Timbre 3
D	Timbre 4 Level	0~99	Level of the Program assigned to Timbre 4
E	Timbre 5 Level	0~99	Level of the Program assigned to Timbre 5
F	Timbre 6 Level	0~99	Level of the Program assigned to Timbre 6
G	Timbre 7 Level	0~99	Level of the Program assigned to Timbre 7
H	Timbre 8 Level	0~99	Level of the Program assigned to Timbre 8

5 -- EDIT COMBINATION MODE

The COMBINATION Mode determines which and in what fashion Programs will be grouped together for play. There are five Combination types: Single, Layer, Split, Velocity Switch and Multi. Each Combination has 1 to 8 Programs, parameters related to play and output (pan, level, MIDI channel, etc.) applicable to each Program, and a pair of effect parameters.

- * Only Programs that are selected in the COMBINATION Mode can be edited in this mode.
- * After completion of any editing, write the Combination to memory using the Write Combination function (F 9-1) and the Combination will be completed. (Combinations, which are not written to memory, will be lost when selecting other Combinations in the COMBINATION Mode.)
- * When selecting Programs to make up a Combination, Programs in data cards can be selected if the data card inserted has Program data stored on it. (Make certain that data cards used when playing have the Programs needed by the Combinations you call up.)

COMBINATION TYPES

Single

A Combination type which is made up of only one Program.

- * When it is necessary (as in live performance) to switch quickly back and forth between a Program and a Combination, store the Program beforehand as a Single Combination so that any switching is done strictly as a Combination change.

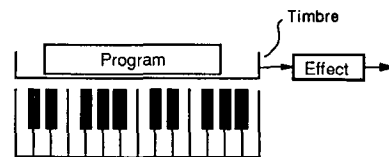

Layer

The playing of two Programs mixed or layered together.

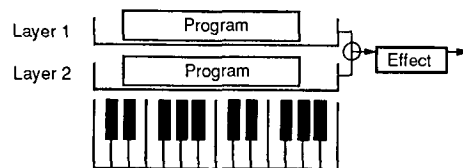

Split

The playing of two Programs separately depending on which section of the keyboard is played.

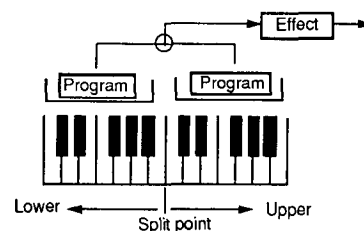

Velocity Switch

The playing of two Programs separately depending on how hard the keyboard is played.

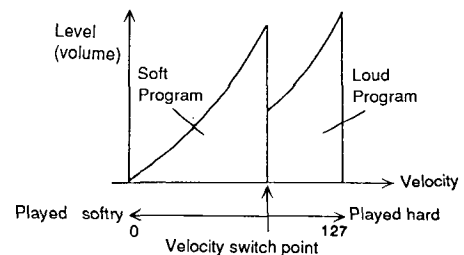

Multi

In Multi, up to 8 Programs can be assigned to any MIDI channel, key range, or velocity range. Playing the M1R as a multi-timbral synthesizer through external MIDI control and other complex possibilities not available in the other Combination types can be realized here.

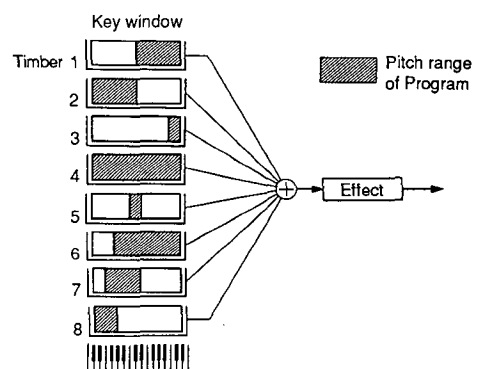

COMMON FUNCTION OF EACH COMBINATION TYPE

- * The first page of each function is selected when pressing the appropriate function number on the numeric keypad (0 to 9). Select the page with the parameter to be edited by using the PAGE - key or PAGE + key.
- * Refer to the explanation for each Combination type since Functions 1 through 7 differ depending on which Combination type has been selected.

Page		Parameter to be Edited
0~1	COMBINATION TYPE	Selection of Combination type
8~1	EFFECT 1	Selection of effect type for Effect 1
8~2	EFFECT 1 PARAMETER	Selection of Effect 1's parameter
8~3	EFFECT 2	Selection of effect type for Effect 2
8~4	EFFECT 2 PARAMETER	Selection of Effect 2's parameter
8~5	EFFECT PLACEMENT	Assignment of Effects 1 and 2
8~6	EFFECT COPY	Copying of effect parameters
9~1	WRITE COMBINATION	Renaming and writing of Combinations

F 0-1 COMBINATION TYPE

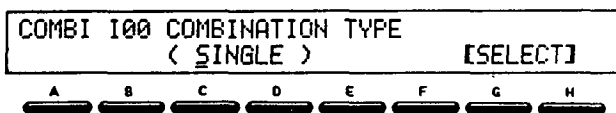

C	COMBINATION TYPE	Selection of Combination type SINGLE LAYER SPLIT VELOCITY SW MULTI
G		[SELECT] Executing the selection

Select the Combination type. (See p. 61 for more on Combination types.)

Choose the type which differs from the present one, and press SELECT (**G**); the type will then be changed. (Any change is cancelled when moving to another page without pressing SELECT.)

EFFECT PARAMETERS

F 8 - 1 Effect 1

F 8 - 2 Effect 1 Parameter

F 8 - 3 Effect 2

F 8 - 4 Effect 2 Parameter

F 8 - 5 Effect Placement

F 8 - 6 Effect Copy

Descriptions of functions F 8 - 2 and F 8 - 4 are given in the Effect Parameter section following the EDIT PROGRAM Mode chapter.

F 8 - 1 EFFECT 1

EFFECT 1							
(&01: Hall)				:ON			
A	B	C	D	E	F	G	H

Selects the effect type for Effect 1.

A	EFFECT TYPE	01~33, No Effect
F	SWITCH	OFF/ON [SELECT]

F 8 - 3 EFFECT 2

Selects the effect type for Effect 2.

Same as F 8 - 1 EFFECT 1.

F 8 - 5 EFFECT PLACEMENT

EFFECT PLACEMENT							
SERIAL				P3 =50:50		P4 = 50:50	
A	B	C	D	E	F	G	H

C	Effect placement	PARALLEL SERIAL
F	P3 Out 3 Panpot	OFF 100:0~0:100
H	P4 Out 4 Panpot	OFF 100:0~0:100

This function sets the Effect Placement and Pan setting of Outputs 3 and 4. (See pp. 36-37 for more on Effect Placement.)

F 8 - 6 EFFECT COPY

EFFECT COPY							
from (COMBINATION)		- I00		[COPY]			
A	B	C	D	E	F	G	H

B		PROGRAM COMBINATION SONG
E		I00~I99 0~9
G		[COPY]

See the Effect Parameter section (p.36) for descriptions of F 8 - 2 and F 8 - 4, as well as more about all of the Effect functions.

* Assigning effects to Programs can be done by Effect Copy (F 8 - 6).

F9-1 WRITE/RENAME (Write/Rename Combination)

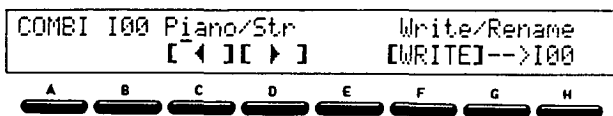

C	[◀] (Cursor left)		Moving the cursor to the left for renaming
D	[▶] (Cursor right)		Moving the cursor to the right for renaming
F	[Write]		Executing the writing to memory
H		I00~I99, C00~C99	Writing to the Combination number

The write procedure stores the edited Combination in internal memory or RAM card.

1. The Combination name is written by using the [◀] key (**C**), [▶] key (**D**), VALUE slider and the UP and DOWN keys.

* Can be named with any numbers or characters up to a maximum of 10.

```
!"#$%&'()*+,-./0123456789:;<=>?
@ABCDEFGHIJKLMNPOQRSTUVWXYZ[*]^_
`abcdefghijklmnopqrstuvwxyz{|}~`
```

2. Select the Combination number (**H**) to be written to.

* I50 to I99 cannot be chosen when memory allocation is in the large sequence configuration.

* Card memory (C00 to C99 or C00 to C49) can be selected when a formatted RAM card is inserted in the front panel PROG/SEQ DATA slot.

3. Press Write (**F**).

4. Press [YES] (**G**) when the display shows "Are you sure?"

* The data which was written previously to the currently selected number is lost.

* The Write procedure can be cancelled by pressing [NO] (**H**).

5. The message "Write Completed" appears when the Write procedure is finished.

* Select this page again when writing another Combination.

NOTE: In order to copy the Combination within the memory, select the Combination to be copied in the COMBINATION Mode and write it to memory by using this page.

SINGLE TYPE FUNCTIONS

Page		Parameter to be Edited
1 - 1	PROG PANPOT	Program number; output destination

F 1 - 1 PROGRAM/PANPOT

COMBI I01 LAYER	Layer 1 Program
I00 A.Piano L70	I02 Trumpet L82
A B C D E F G H	

A	Program	I00~I99, C00~C99	Selection of Program number
D	Level	0~99	Volume setting
F	Panpot	A, 9:1 to 1:9, B, C, C + D, D	Output destination

NOTES:

Program selects the Program or preset voice.

Level sets the volume of the Program's sound. The volume, when set to 99 is the full volume as set in the Program parameter, and 0 mutes the Program completely.

Panpot determines the output to outputs A through D. Selection is as follows: A, A:B (in ratios from 9:1 - 1:9), B, C, C + D and D.

LAYER TYPE FUNCTIONS

Page		Parameter to be Edited
1 - 1	PROG/LEVEL	Each Program's number and output level
1 - 2	PANPOT/DAMPER	Output destination (panpot); damper

F 1 - 1 PROGRAM/LEVEL

COMBI I01 LAYER	Layer 1 Program
I00 A.Piano L70	I02 Trumpet L82
A B C D E F G H	

A	Layer 1 Program	I00~I99, C00~C99	Selection of Layer 1's Program
D L	Layer 1 Level	0~99	Layer 1's volume control
E	Layer 2 Program	I00~I99, C00~C99	Selection of Layer 2's Program
H L	Layer 2 Level	0~99	Layer 2's volume control

F 1 - 2 PANPOT/DAMPER

COMBI I01 LAYER	Layer 1 Panpot
5:5 ENA	A ENA I-12 D-50
A B C D E F G H	

A	Layer 1 Panpot	A, 9:1 to 1:9, B, C, C+D, D	Layer 1's output destination
B	Layer 1 Damper	DIS/ENA	Damper effect OFF/ON switch for Layer 1
C	Layer 2 Panpot	A, 9:1 to 1:9, B, C, C+D, D	Layer 2's output destination
D	Layer 2 Damper	DIS/ENA	Damper effect OFF/ON switch for Layer 2
E I	Interval	-12 ~ +12	Adjustment of Layer 2's pitch in semitones over a range of ± 1 octave
H D	Detune	-50 ~ +50	Fine adjustment of Layer 2's pitch in 1-cent steps

NOTES:

Program 1 selects the Program (preset voice) of Layer 1.

Layer 1 Level sets the level (volume) of Layer 1. The volume, when set to 99 is the full volume as set in the Program parameter, and 0 mutes the Program completely.

Layer 2 Program selects the Program (preset voice) of Layer 2. (Same as Program 1.)

Layer 2 Level sets the level (volume) of the Layer 2. (Same as Level 1.)

Layer 1 Panpot assigns the output of Layer 1 to outputs A through D. The selection is as follows: A, A:B (9:1 to 1:9), B, C, C + D and D.

* When the Drum Kit Program is selected, the display shows "SND" and the Panpot setting in the GLOBAL Mode is operative.

Damper has no effect on the Program of Layer 1 when Layer 1 Damper is set to DIS.

Panpot 2 assigns the output of the Layer 2 to outputs A through D. The selection is as follows: A, A:B (9:1 to 1:9), B, C, C + D and D.

Damper has no effect on the Program of Layer 2 when Layer 2 Damper is set to DIS.

Interval permits changing of the pitch of Layer 2's Program by semitone steps within the range of -12 to +12. By changing the pitch of Layer 2 in this way, automatic harmonies can be played.

Detune allows for even finer adjustment of the pitch of Layer 2 in 1-cent steps within a range of -50 to +50. A thick sound can be obtained by slightly detuning Layer 2 relative to Layer 1.

SPLIT TYPE FUNCTIONS

Page	Parameter to be Edited	
1 - 1	PROG/SPLIT	Selection of Program number, split point
1 - 2	LEVEL/ PANPOT/ DAMPER	Each Program's output level, destination and danper setting

F 1 - 1 PROGRAM/SPLIT

COMBI	I02	KEY	SPLIT	Lower Program			
I09	Violin	SP=C4	I05	Tenor_Sax			
A	B	C	D	E	F	G	H

A	Lower Program	I00~I99, C00~C99	Selection of the Program lower than the split point
D	SP	C-1 to G9	Setting the split point
F	Upper Program	I00~I99, C00~C99	Selection of the Program higher than the split point

F 1 - 2 LEVEL/PAN/DAMPER

COMBI	I02	KEY	SPLIT	Lower Level			
L99	1:9	ENA	L77	D	ENA		
A	B	C	D	E	F	G	H

A	L	Lower Level	0-99	The lower Program's volume control
B		Lower Panpot	A, 9:1 to 1:9, B, C, C+D,D	Lower Program's output destination
C		Lower Damper	DIS/ENA	Damper effect OFF/ON switch for lower Program
E	L	Upper Level	0-99	The upper Program's volume control
F		Upper Panpot	A, 9:1 to 1:9, B, C, C+D,D	Upper Program's output destination
G		Upper Damper	DIS/ENA	Damper effect OFF/ON switch for lower Program

NOTES:

Lower Program selects the Program which sounds when playing keys lower than the split point.

Split point sets the keyboard position at which the sounds are separated.

Upper Program selects the Program which sounds when playing keys higher than the split point.

* Split point is the lowest key in the upper Program.

Lower Level sets the level (volume) of the lower Program. The volume, when set to 99 is the full volume as set in the Program parameter, and 0 mutes the Program completely.

Lower Panpot assigns the output of the lower Program to outputs A through D. The selection is as follows: A, A:B (9:1 to 1:9), B, C, C + D, and D.

Damper has no effect on the lower Program when Lower Damper is set to DIS.

Upper Level sets the level (volume) of the upper Program. The volume, when set to 99 is the full volume as set in the Program parameter, and 0 mutes the Program completely.

Upper Panpot assigns the output of the upper Program to outputs A through D. The selection is as follows: A, A:B (9:1 to 1:9), B, C, C + D, and D.

Damper has no effect on the upper Program when Upper Damper is set to DIS.

VELOCITY SWITCH TYPE FUNCTIONS

Page		Parameter to be Edited
1 - 1	PROGRAM/ VELOCITY	Each Program's number, velocity switch point
1 - 2	LEVEL/ PANPOT/ DAMPER	Each Program's output level, destination (panpot), damper setting

F 1 - 1 PROGRAM/VELOCITY

COMBI I03 VELOCITY SW Soft Program
I03 Flute VP=085 I10 Strings
A B C D E F G H

A	Soft Program	I00~I99, C00~C99	Selection of the Program that sounds when playing softer than the velocity switch point	
D	VP	Vel. Sw. Point	1~127	Setting the velocity value of the velocity switch
F	Loud Program	I00~I99, C00~C99	Selection of the Program that sounds when playing harder than the velocity switch point	

F 1 - 2 LEVEL/PAN/DAMPER

COMBI I03 VELOCITY SW Soft Level
L65 B ENA L48 C DIS
A B C D E F G H

A	L	Soft Level	0~99	The soft Program's volume control
B		Soft Panpot	A, 9:1 to 1:9, B, C, C+D, D	Soft Program's output destination
C		Soft Damper	DIS/ENA	Damper effect OFF/ON switch for soft Program
E	L	Loud Level	0~99	The loud Program's volume control
F		Loud Panpot	A, 9:1 to 1:9, B, C, C+D, D	Loud Program's output destination
G		Loud Damper	DIS/ENA	Damper effect OFF/ON switch for loud Program

NOTES:

Soft Program selects the Program which sounds when playing at a velocity lower than that of the velocity switch point.

Velocity SW (Switch) Point sets the velocity value at which the two Programs are separated.

Loud Program selects the Program which sounds when playing at a velocity higher than that of the velocity switch point.

* If the Velocity SW point is set to 1, the soft Program will not sound.

Soft Level sets the level (volume) of the soft Program. The volume, when set to 99 is the full volume as set in the Program parameter, and 0 mutes the Program completely.

Soft Panpot assigns the output of the soft Program to outputs A through D. The selection is as follows: A, A:B (9:1 to 1:9), B, C, C + D, and D.

* When the Drum Kit Program is selected, the display shows "SND" and the Panpot setting in the GLOBAL Mode is operative.

Damper has no effect on the soft Program when Soft Damper is set to DIS.

Loud Level sets the level (volume) of the loud Program. The volume, when set to 99 is the full volume as set in the Program parameter, and 0 mutes the Program completely.

Loud Panpot assigns the output of the loud Program to outputs A through D. The selection is as follows: A, A:B (9:1 to 1:9), B, C, C + D, and D.

Damper has no effect on the loud Program when Loud Damper is set to DIS.

MULTI TYPE FUNCTIONS

Page		Parameter to be Edited
1-1	PROGRAM SELECT	Program which is assigned to each Timbre
2-1	MIDI CH	MIDI receiving channel of each Timbre
3-1	KEY WINDOW TOP	Top key setting of each Timbre's range
2	K. WINDOW BOTTOM	Bottom key of each Timbre's range
3	VEL WINDOW TOP	Top velocity value of the velocity switch of each Timbre
4	V. WINDOW BOTTOM	Bottom velocity value of the velocity switch of each Timbre
4-1	OUTPUT LEVEL	Level of each Timbre
5-1	KEY TRANSPOSE	Transpose setting of each Timbre
2	DETUNE	Detune setting of each Timbre
6-1	PANPOT	Output destination of each Timbre
7-1	MIDI PROGRAM CHG	MIDI program change receiving switch of each Timbre
2	DAMPER	Damper effect receiving switch of each Timbre
3	AFTER TOUCH	After touch effect receiving switch of each Timbre
4	CONTROL CHANGE	Control effect receiving switch of each Timbre

F 1 - 1 PROGRAM SELECT

COMBI I04 PROGRAM SELECT T1=E.Bass							
*I01 I02 I03 I05 I06 I09 I10 I12							
A	B	C	D	E	F	G	H

A	Timbre 1	OFF/I00 ~ I99 C00 ~ C99	Selection of the Program for each Timbre
B	Timbre 2	OFF/I00 ~ I99 C00 ~ C99	
C	Timbre 3	OFF/I00 ~ I99 C00 ~ C99	
D	Timbre 4	OFF/I00 ~ I99 C00 ~ C99	
E	Timbre 5	OFF/I00 ~ I99 C00 ~ C99	
F	Timbre 6	OFF/I00 ~ I99 C00 ~ C99	
G	Timbre 7	OFF/I00 ~ I99 C00 ~ C99	
H	Timbre 8	OFF/I00 ~ I99 C00 ~ C99	

Selects the Program (sound color) of each Timbre. Timbres set to "OFF" do not sound.

F 2 - 1 MIDI CH (MIDI Channel)

COMBI	I04	MIDI	CH	T1=E.Bass			
_1G	7	8	9	11	14	15	16
A	B	C	D	E	F	G	H

A	Timbre 1	1 ~ 16	Selection of the MIDI receive channel of each Timbre
B	Timbre 2	1 ~ 16	
C	Timbre 3	1 ~ 16	
D	Timbre 4	1 ~ 16	
E	Timbre 5	1 ~ 16	
F	Timbre 6	1 ~ 16	
G	Timbre 7	1 ~ 16	
H	Timbre 8	1 ~ 16	

This function sets the MIDI receiving channel for each Timbre. Playing eight separate Programs simultaneously is possible with multi-channel MIDI data received through MIDI IN, when a different MIDI channel is set for each Timbre.

Program change, pitch bend, after touch and control change parameters receive data over the MIDI channel set for each Timbre. (Reception of this data can be turned off in functions 7-1 through 7-4.)

* Real time performance controls such as foot controllers connected to the M1R affects only the timbres which are set to the same channel as the MIDI Global channel.

When the receiving channel is the same as the Global channel, "G" is displayed after the number.

F 3 - 1 KEY WINDOW TOP

COMBI	I04	KEY	WINDOW	TOP	T1=E.Bass		
Q#0	G1	B2	D#4	G#5	B6	D#8	G9
A	B	C	D	E	F	G	H

A	Timbre 1	C -1 ~ G9	Selection of the top key of each Timbre's range
B	Timbre 2	C -1 ~ G9	
C	Timbre 3	C -1 ~ G9	
D	Timbre 4	C -1 ~ G9	
E	Timbre 5	C -1 ~ G9	
F	Timbre 6	C -1 ~ G9	
G	Timbre 7	C -1 ~ G9	
H	Timbre 8	C -1 ~ G9	

F 3 - 2 KEY WINDOW BOTTOM

COMBI I04 K.WINDOW BOTTOM T1=E.Bass							
C-1	E0	G#1	C3	E4	G#5	C7	E8
A	B	C	D	E	F	G	H

A	Timbre 1	C-1 ~ G9	Set the bottom key of each Timbre's range
B	Timbre 2	C-1 ~ G9	
C	Timbre 3	C-1 ~ G9	
D	Timbre 4	C-1 ~ G9	
E	Timbre 5	C-1 ~ G9	
F	Timbre 6	C-1 ~ G9	
G	Timbre 7	C-1 ~ G9	
H	Timbre 8	C-1 ~ G9	

Key Window sets the range over the keyboard at which a Program will sound (key window) and shuts off the sound outside of that range. Through the use of this function, several Programs can be played at different key positions.

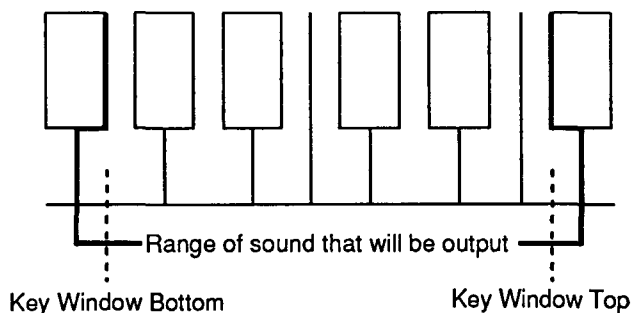

(Only the range defined by the key window top and the key window bottom will sound.)

* The key window top point cannot be set to a lower value than the key window bottom point. (When the key window top value is set lower than the key window bottom, the key window bottom value is automatically adjusted to a semitone below key window top.)

F 3 - 3 VEL. WINDOW TOP (Velocity Window Top)

COMBI I04 VEL.WINDOW TOP T1=E.Bass							
016	021	033	057	072	092	110	127
A	B	C	D	E	F	G	H

A	Timbre 1	1 ~ 127	Sets the maximum velocity value at which each Timbre will sound
B	Timbre 2	1 ~ 127	
C	Timbre 3	1 ~ 127	
D	Timbre 4	1 ~ 127	
E	Timbre 5	1 ~ 127	
F	Timbre 6	1 ~ 127	
G	Timbre 7	1 ~ 127	
H	Timbre 8	1 ~ 127	

F 3 - 4 V. WINDOW BOTTOM (Velocity Window Bottom)

COMBI I04 U.WINDOW BOTTOM T1=E.Bass							
001	010	017	020	031	051	069	070
A	B	C	D	E	F	G	H

A	Timbre 1	1 ~ 127	Sets the minimum velocity value at which each Timbre will sound
B	Timbre 2	1 ~ 127	
C	Timbre 3	1 ~ 127	
D	Timbre 4	1 ~ 127	
E	Timbre 5	1 ~ 127	
F	Timbre 6	1 ~ 127	
G	Timbre 7	1 ~ 127	
H	Timbre 8	1 ~ 127	

VELOCITY WINDOW

Velocity Window sets the range at which Timbres will sound according to the strength at which the keyboard is played. In other words, different Timbres can be sounded with different playing strengths to give the keyboardist maximum expressive control.

• **EXAMPLE**

Bottom = 25 Top = 100

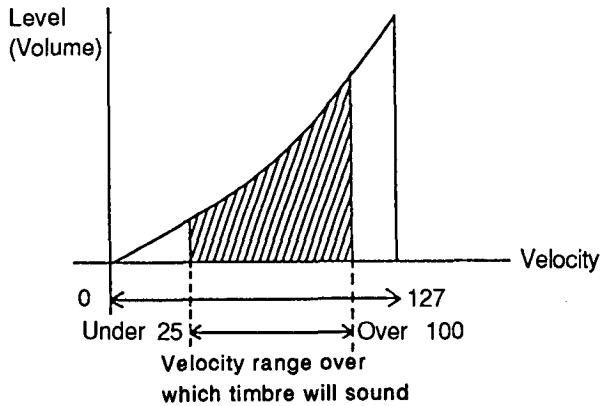

(The Timbre will sound only when playing with at a velocity value between the velocity window top and the velocity window bottom.)

* The velocity window top point cannot be set to a lower value than the velocity window bottom point.

F 4 - 1 OUTPUT LEVEL

COMBI I04 OUTPUT LEVEL T1=E.Bass							
99	95	74	58	77	33	11	96
A	B	C	D	E	F	G	H

A	Timbre 1	0 ~ 99	Control of the output level of each Timbre
B	Timbre 2	0 ~ 99	
C	Timbre 3	0 ~ 99	
D	Timbre 4	0 ~ 99	
E	Timbre 5	0 ~ 99	
F	Timbre 6	0 ~ 99	
G	Timbre 7	0 ~ 99	
H	Timbre 8	0 ~ 99	

* This sets the level (volume) of each Timbre. The volume, when set to 99 is the full volume as set in the Program parameter, and the Timbre does not sound at a setting of 0.

F 5 - 1 KEY TRANSPOSE

COMBI I04 TRANSPOSE							T1=E.Bass	
+12	+01	-09	-12	+00	-01	+00	+00	
A	B	C	D	E	F	G	H	

A	Timbre 1	-24 ~ +24	Adjusts the pitch of each Timbre in semitone steps over a range of ± 2 octaves
B	Timbre 2	-24 ~ +24	
C	Timbre 3	-24 ~ +24	
D	Timbre 4	-24 ~ +24	
E	Timbre 5	-24 ~ +24	
F	Timbre 6	-24 ~ +24	
G	Timbre 7	-24 ~ +24	
H	Timbre 8	-24 ~ +24	

* Allows for transposition of each Timbre in semitone steps either up or down two octaves.

F 5 - 2 DETUNE

COMBI I04 DETUNE							T1=E.Bass	
+00	-02	+14	-50	+00	+50	+19	-04	
A	B	C	D	E	F	G	H	

A	Timbre 1	-50 ~ +50	Adjusts the pitch of each Timbre in 1-cent steps over a range of ± 50 cents
B	Timbre 2	-50 ~ +50	
C	Timbre 3	-50 ~ +50	
D	Timbre 4	-50 ~ +50	
E	Timbre 5	-50 ~ +50	
F	Timbre 6	-50 ~ +50	
G	Timbre 7	-50 ~ +50	
H	Timbre 8	-50 ~ +50	

* Allows for fine setting of the pitch of each Timbre in units of 1 cent within a range of -50 and +50 (one semitone).

F 6 - 1 PANPOT

COMBI I04 PANPOT				T1=E.Bass			
A	8:2	C	3:7	B	C	C+D	D
<u>A</u>	<u>B</u>	<u>C</u>	<u>D</u>	<u>E</u>	<u>F</u>	<u>G</u>	<u>H</u>

A	Timbre 1	A, (9:1 to 1:9), B, C, C+D, and D.	Sets the output destination of each Timbre
B	Timbre 2	A, (9:1 to 1:9), B, C, C+D, and D.	
C	Timbre 3	A, (9:1 to 1:9), B, C, C+D, and D.	
D	Timbre 4	A, (9:1 to 1:9), B, C, C+D, and D.	
E	Timbre 5	A, (9:1 to 1:9), B, C, C+D, and D.	
F	Timbre 6	A, (9:1 to 1:9), B, C, C+D, and D.	
G	Timbre 7	A, (9:1 to 1:9), B, C, C+D, and D.	
H	Timbre 8	A, (9:1 to 1:9), B, C, C+D, and D.	

- * Timbre Pan assigns the output of each Timbre to outputs A through D. The selection is as follows: A, A:B (9:1 to 1:9), B, C, C + D, and D.
- * When the Drum Kit Program is selected, the display shows "SND" and the Panpot setting in the GLOBAL Mode is operative.

F 7 - 1 MIDI PROG CHG (MIDI Program Change)

COMBI I04 MIDI PROG CHG				T1=E.Bass			
ENA	DIS	ENA	ENA	DIS	DIS	DIS	ENA
<u>A</u>	<u>B</u>	<u>C</u>	<u>D</u>	<u>E</u>	<u>F</u>	<u>G</u>	<u>H</u>

A	Timbre 1	DIS/ENA	Determines whether or not each Timbre receives MIDI program change messages. (Timbres set to "DIS" do not receive program change messages.)
B	Timbre 2	DIS/ENA	
C	Timbre 3	DIS/ENA	
D	Timbre 4	DIS/ENA	
E	Timbre 5	DIS/ENA	
F	Timbre 6	DIS/ENA	
G	Timbre 7	DIS/ENA	
H	Timbre 8	DIS/ENA	

- * A Timbre for which MIDI PROG CHG (MIDI Program Change) is set to DIS does not change its Program when MIDI program change messages are received.

NOTE: When receiving program change messages over the Global Channel, Combination changes are executed regardless of the setting made here.

F 7 - 2 DAMPER

COMBI I04 DAMPER					T1=E.Bass			
DIS	DIS	DIS	DIS	DIS	ENA	ENA	DIS	
<u>A</u>	<u>B</u>	<u>C</u>	<u>D</u>	<u>E</u>	<u>F</u>	<u>G</u>	<u>H</u>	

A	Timbre 1	DIS/ENA	Determines whether or not the damper effect is active for each Timbre. (Damper will not affect Timbres that are set to DIS in this function.)
B	Timbre 2	DIS/ENA	
C	Timbre 3	DIS/ENA	
D	Timbre 4	DIS/ENA	
E	Timbre 5	DIS/ENA	
F	Timbre 6	DIS/ENA	
G	Timbre 7	DIS/ENA	
H	Timbre 8	DIS/ENA	

F 7 - 3 AFTER TOUCH

COMBI I04 AFTER TOUCH					T1=E.Bass			
ENA	ENA	ENA	ENA	ENA	ENA	DIS	ENA	
<u>A</u>	<u>B</u>	<u>C</u>	<u>D</u>	<u>E</u>	<u>F</u>	<u>G</u>	<u>H</u>	

A	Timbre 1	DIS/ENA	Determines whether or not after touch control will be active for each timbre. (After touch will not affect Timbres set to DIS in this function.)
B	Timbre 2	DIS/ENA	
C	Timbre 3	DIS/ENA	
D	Timbre 4	DIS/ENA	
E	Timbre 5	DIS/ENA	
F	Timbre 6	DIS/ENA	
G	Timbre 7	DIS/ENA	
H	Timbre 8	DIS/ENA	

Sets whether the after touch effect is available or not. (After touch will not affect Timbres set to DIS in this function.)

F 7 - 4 CONTROL CHANGE

COMBI I04 CONTROL CHANGE					T1=E.Bass			
ENA	ENA	DIS	ENA	DIS	ENA	DIS	ENA	
<u>A</u>	<u>B</u>	<u>C</u>	<u>D</u>	<u>E</u>	<u>F</u>	<u>G</u>	<u>H</u>	

A	Timbre 1	DIS/ENA	Determines whether or not pitch bend and control change messages will affect each timbre. (Pitch bend and control change have no effect on timbres set to DIS in this function.)
B	Timbre 2	DIS/ENA	
C	Timbre 3	DIS/ENA	
D	Timbre 4	DIS/ENA	
E	Timbre 5	DIS/ENA	
F	Timbre 6	DIS/ENA	
G	Timbre 7	DIS/ENA	
H	Timbre 8	DIS/ENA	

6 -- SEQUENCER MODE

Since an 8-track sequencer is installed in the M1R, you can easily create your own songs complete with multi-timbral instrumentation by specifying the Program that will be used on each track and by recording play data from an external MIDI keyboard.

- * In this mode songs (play data) can be recorded, played back and edited; moreover, other song parameters (such as effect settings to be used for playback) can be edited.
- * In this mode the memory is edited directly.
- * The Program used when playing the keyboard for recording is the Program that will be assigned to the current track of the selected song.
- * The amount of data that can be memorized is limited as to the total number of songs, patterns and steps (music notes).

STRUCTURE OF SONGS

Sequencer play data together with related parameters recorded in 8 or less tracks is referred to as a "song."

SONG		
Song Parameter [Tempo, beat, etc.]	TRACK 1 Parameter (Program no., Program, MIDI channel, etc.)	Play data of Track 1
	TRACK 2	Play data of Track 2
	TRACK 3	Play data of Track 3
	TRACK 4	Play data of Track 4
	TRACK 5	Play data of Track 5
	TRACK 6	Play data of Track 6
	TRACK 7	Play data of Track 7
	TRACK 8	Play data of Track 8

EFFECT
Setting the effect to be used in the song

- * 1 Program (1 sound color) can be assigned to 1 track. It is possible to change each track's Program in the middle of the song.
- * Each track can store play data of up to 250 measures.
- * 1 song can consist of up to 8 tracks.
- * 10 songs, numbered from 0 to 9, can be created.
- * The M1's internal sound source can provide a maximum of 16 oscillators for use in all the tracks combined.
- * In the Sequencer Mode the effect setting of each program is ignored and the effect setting within the song parameter is active.

Each track of a song can be made in the 3 following ways:

(1) Real time recording

This is the most basic method in that the data played by keys is directly memorized. The real time recording page is selected by default when the SEQUENCER Mode is called up.

(2) Step recording

This is a recording method that specifies, step by step, the length and velocity (volume) of each note by numeric value, and the pitch by key.

(3) Pattern method

Rhythmic patterns, loops, verse/chorus sections and so on can be made by combining patterns (made up of play data of 1- to 8-measure lengths).

STRUCTURE OF PATTERNS

The MIR can store 100 kinds of patterns (made up of play data of 1- to 8-measure lengths) in addition to the play data capacity of 10 songs. When the same phrase appears more than twice in a song, memory can be economized by replacing the phrase to a pattern.

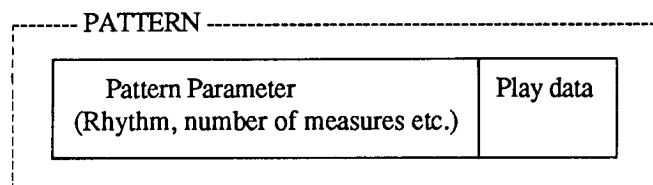

- * As long as the rhythm is the same, the created pattern can be used for any track of the song.
- * It is possible to make a track which includes both play data and patterns but both cannot occupy the same measure.

Patterns can be made in the following three different ways:

(1) Real time recording

Notes played on the keyboard are directly memorized as data. As opposed to the normal recording of tracks, patterns can be recorded by repeated overdubbing. (Patterns of the Drum Kit can be recorded by using drum sounds.)

(2) Step Recording

This method is used to input each note by specifying its pitch and length.

(3) Copying from track

Patterns can be made by copying the play data in the track.

EDITING SEQUENCER DATA

There are two kinds of editing methods used in the SEQUENCER Mode: 1) changing of parameters and 2) direct editing of the play data itself.

TO BE EDITED	EDITING PARAMETER	EDITING PLAY DATA
Song	Song Parameter	Initialize
Track	Track Parameter	Copy, Bounce, Erase
Measure	_____	Assignment of pattern or Copying, etc.
Pattern	_____	Copy, etc.
Event	_____	Event Edit

When it is necessary to erase the existing play data in order to edit the play data, the following display appears on the screen, upon pressing of [EXEC] (**G** key)

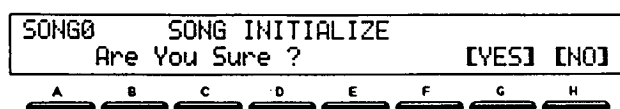

Existing data will be deleted when pressing [YES] (**G** key) and editing will be executed. It can be cancelled by pressing [NO] (**H** key).

FUNCTIONS OF SEQUENCER MODE

- * The first page of each function is selected when pressing the numeric keypad (0 to 9). Select the page to be edited by using these keys along with the PAGE + and PAGE - keys.

F0-1	REC/PLAY (REAL TIME)	Play/real time recording/punch-in recording
F0-2	REC SET UP (PUNCH)	Setting resolution, metronome, punch in/out
F0-3	REC MULTI CHANNEL	Setting multi-channel recording (Rec/Play)
F1-1	TRACK PROGRAM	Program number of each track
F1-2	TRACK VOLUME	Volume of each track
F1-3	TRACK STATUS	MIDI output, ON/OFF of internal voices on each track
F1-4	MIDI CH	MIDI channel of each track
F2-1	STEP RECORDING	Step recording
F3-1	SONG PARAMETER	Setting song name, tempo and following song
F3-2	SONG INITIALIZE	Returning to default settings of the song (erases existing data) and sets the time signature
F4-1	TRACK PARAMETER	Setting Program, volume, etc. of each track
F4-2	TRACK COPY/BOUNCE	Copying and bouncing from track to track
F4-3	TRACK ERASE	Erasing track data
F5-1	PUT/COPY PATTERN	Assignment and copying of patterns to measures
F5-2	MEASURE COPY	Copying of the specified measure
F5-3	MEASURE INS/DEL/ERA	Inserting/deleting/erasing the specified measure
F5-4	MEASURE QUANTIZE	Adjusting automatically the timing of all notes in a specified measure
F6-1	PATTERN REAL TIME	Real time recording of patterns
F6-2	PATTERN STEP REC	Step recording of patterns
F6-3	PATTERN INITIALIZE	Erasing patterns and setting time signature and length of patterns
F6-4	PATTERN GET	Copying data in track to patterns
F6-5	PATTERN COPY/BOUNCE	Copying and bouncing from pattern to pattern
F7-1	EVENT	Editing events
F8-1	EFFECT 1 (TYPE)	Selecting effect
F8-2	EFFECT 1 PARAMETER	Parameter of Effect 1
F8-3	EFFECT 2 (TYPE)	Selecting Effect
F8-4	EFFECT 2 PARAMETER	Parameter of Effect 2
F8-5	EFFECT PLACEMENT	Assigning Effects 1 and 2
F8-6	EFFECT COPY	Copying the effect parameter
F9-1	EXCHANGE ALL SEQ	Exchanging sequencer data between internal memory and card
F9-2	LOAD 1 SONG	Loading 1 song from card
F9-3	LOAD 1 PATTERN	Loading 1 pattern from card

F 0 - 1 PLAY/REAL TIME RECORDING

SONG00	New Song9	100%Free
R/P	Son90 Tr1 M001	J=120 *I00 U99 [▶◀]
A	B	C
D	E	F
G	H	

[A]	Mode	R/P P.IN	Regular recording / play Punch-in recording
[B]	Song (Song Number)	0~9	Song number to be played recorded
[C] Tr	Track (Track Number)	1~8 MLT	Track number to be used Specifying multi-channel recording
[D] M	Measure	1~250	Measure number
[E] ♪	Tempo (tempo)	40~208	Tempo (beats per minute)
[F]	Prog = ... (Program)	OFF, I00 to I99 C00 to C99	Program number of current track
[G] V	Volume (volume)	0~99	Volume of current track
[H]		▶◀	Returning to the beginning of the song (first measure) (Measure Reset)

Play

Select the song number to be played ([B]) and press the START/STOP key. Play is stopped by pressing the START/STOP key while playing and is restarted by pressing the START/STOP key again. When the song is finished playing, another song is played (if song change is set), or the sequencer stops and resets the measure back to zero (if another song is not set).

- * Pressing the START/STOP key in any mode automatically accesses this page and starts playing a song.
- * Other modes or functions cannot be selected during play.
- * Tempo ([E]), Program ([F]) and volume ([G]) can be changed during play. However, when these data are included as part of the play data, the values are fixed.
- * Songs inside the card can be selected for play by pressing the card key when the memory card which has sequence data is inserted in the PROG/SEQ DATA slot.

Starting Play from Midway Point of Song

Change the measure number ([D]) when the sequencer is stopped and press the START/STOP key; play will start from that measure. However, the Program selected or controller value might be different from the original recording when program changes or control changes are included in the play data.

The sequencer of the M1R can be played simultaneously along with rhythm machines or external sequencers connected by MIDI. (This is referred to as synchronization or "syncing.") Set the clock source of the M1R to "internal" and the other to "external" (in the GLOBAL Mode), then connect the MIDI OUT terminal of the M1 with the MIDI IN terminal of the external device.

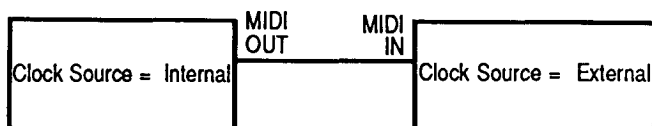

- * Set the clock source of the M1R in the GLOBAL Mode (F 5-1). (Refer also to the owner's manual of the MIDI device to be connected.)
- * Operations such as START/STOP should be executed from the device on which clock source is set to internal.

- * If the MIDI device to be used supports song select or song position pointer functions, the sequencer can be started from the same point in the same song even when changing measures.

Real Time Recording

When recording a new song, first erase the data of the previous song by using F 3 - 2, INITIALIZE SONG and set the time signature.

1. Set the mode (**A**) to R/P and select the song (**B**) and the track (**C**) to be recorded. Make certain that the MIDI channels of the external keyboard and the track are the same.
 2. Set the tempo (**E**) of the song and set the Program (**F**) and the volume (**G**) of the track.
 3. Press the START/STOP key after pressing the REC key; it will light up.
 4. Recording starts after a lead-in of two measures. In addition to external data from MIDI, foot controller, tempo (**E**) (over a range of -50% to +50%), Program change (**F**), and volume (**G**), are recorded. If other tracks have been already recorded, they also are played at the same time.
 5. The measure is reset when stopping the recording by pressing the START/STOP key. A recorded song can be played back immediately by pressing the START/STOP key again. When re-recording, press the START/STOP key after pressing the REC key.
- * When recording on tracks which already have recorded song data, the previous data is erased.
 - * Setting resolution or metronome to ON/OFF in the next page affects the recorded tracks.
 - * Recording in the R/P mode is always executed from the first measure. (Recording from the middle can be done by punch-in recording.)
 - * Other modes or functions cannot be selected while recording.
 - * Tempo change affects all 8 tracks, no matter on what track it is recorded. (Therefore, unnatural and unexpected effects may result when several tracks include tempo change.)

NOTE: Memory space equal to 1 step is taken up by a single bar line. Memory of 2 steps is taken up by notes which bridge over the bar line.

NOTE: After touch and other controller data consume a great deal of memory. It is recommended to set the after touch in the GLOBAL Mode function F 5-2, MIDI Filtering, to DISABLE, especially when recording with a Program that does not use after touch or other controllers.

Punch-In Recording

Punch-in recording is used to re-record parts on which mistakes were made or to continue recording on the track which has already been recorded. Recording is done only between the punch-in point and the punch-out point and the song is played back between these points.

1. Set the mode (**A**) to P.IN and select the song (**B**) and the track (**C**) to be recorded. Make certain that the MIDI channels of the external keyboard and the track are the same.
 2. Move to the next page by pressing the PAGE + key and set the punch-in measure (**F**) and the punch-out measure (**G**), and move back to the previous page by pressing the PAGE - key.
 3. Set the measure number (**D**) to a point a few measures before the punch-in measure.
 4. Press the START/STOP key after pressing the REC key.
 5. Punch-in recording starts after a lead-in of two measures.
- * There is a lead-in only when the punch-in measure is set to "1."
6. Stop recording by pressing the START/STOP key after passing the punch-out point.

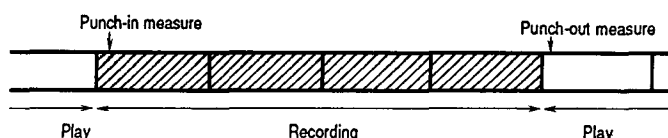

NOTE: The data in the fixed punch in/punch out range is lost upon recording. Notes begun and held from one measure before the punch-in measure remain without being erased, but only for the duration of the punch-in measure. Notes held continuously past the punch-out measure point will be recorded only for one measure following the punch-out point.

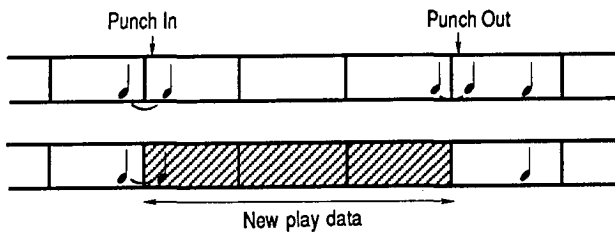

- * Only the measure immediately following the punch-out point (in other words, the punch-out measure itself) can be recorded and added to the previous play data, and only when the notes are held over the punch-out point.
- * It is impossible to punch in from a measure in the middle of a pattern.

NOTE: Damper or pitch bend effects might occur when playing if settings of damper = off or pitch bend = 0 are included in the specified range. In such cases correct the data by measure edit or event edit.

F 0 - 2 REC SET UP

SONG#	RECORDING	Metronome
Res= $\text{♩}/48$	MM:OFF	PUNCH:001→010
A	B	C
D	E	F
G	H	

A Res	Resolution	$\text{♩}/48 \sim \text{♩}/1$	Quantization of rhythm at recording
C MM	Metronome	OFF/ON	Metronome switch
F	P - In Measure (Punch In Measure)	1~250	Measure at which punch in is set
G	P - Out Measure (Punch Out Measure)	1~250, End	Measure at which punch out is set

- * Resolution determines whether the rhythm is quantized during recording. When set to $\text{♩}/1$, it is quantized to the nearest quarter note. When set to $\text{♩}/48$, it is recorded more or less as it is played.
- * Unexpected results might occur when setting to a coarse resolution (such as $\text{♩}/1$) for recording tracks that include control data. In such cases, record at a finer resolution setting and quantize only notes using F 5 - 6, QUANTIZE.
- * The metronome sound is reproduced during playback/recording when setting the Metronome to ON.
- * The metronome sound can also be routed through effects.
- * The available simultaneous voice amount decreases by 1 when using the metronome.
- * P-In Measure (Punch-in Measure) and P-Out Measure (Punch-out Measure) specify the measures to be punched in and punched out when selecting P. IN in function F 0-1 REC/PLAY.

F 0 - 3 MULTI CHANNEL RECORDING



A	Track 1	PLAY/REC	Setting the track to be recorded to "REC."
B	Track 2	PLAY/REC	
C	Track 3	PLAY/REC	
D	Track 4	PLAY/REC	
E	Track 5	PLAY/REC	
F	Track 6	PLAY/REC	
G	Track 7	PLAY/REC	
H	Track 8	PLAY/REC	

The M1R's sequencer can also record MIDI data from other external sequencers. The data which matches the MIDI channel of the current track is normally recorded, but also it is possible to record MIDI data on several corresponding tracks at the same time by using the multi-channel recording function. (See F 0 - 1, PLAY/REAL TIME RECORDING for controlling recording parameters when using external MIDI devices.)

1. Set the track to MULTI in F 0-1 PLAY/REC.
2. Select this page by pressing the PAGE + key twice and set the track (1 through 8) to be recorded to REC.
3. Select the MIDI Channel page by pressing the PAGE + key and set the MIDI channel of each track to be recorded to different channel numbers.
4. Record by using F 0-1 PLAY/REC.

Before recording in multi-channel recording, remaining memory is divided equally among the tracks to be recorded. As a result, there may be a concentration of MIDI data in each track, and the memory space may be filled up before using up all the available total memory. It is best to record tracks in the order of the amount of data they will contain. In other words, first record tracks that will have little data, and record tracks with much data later.

- * Punch-in recording is also possible in the multi-channel recording function.
- * All the tracks are played during playback.
- * MIDI messages that can be recorded are: note on/off, pitch bend, program change, channel pressure and control change (0 to 101).

F 1 - 1 TRACK PROGRAM

SONG0	TRACK PROGRAM							T1:A.Piano
*I00	I01	I02	I03	I04	I05	I06	I07	
A	B	C	D	E	F	G	H	

A	T1 = ... (Track 1)	OFF, I00 ~ I99 C00 ~ C99	Setting the Program of each track
B	T2 = ... (Track 2)	OFF, I00 ~ I99 C00 ~ C99	
C	T3 = ... (Track 3)	OFF, I00 ~ I99 C00 ~ C99	
D	T4 = ... (Track 4)	OFF, I00 ~ I99 C00 ~ C99	
E	T5 = ... (Track 5)	OFF, I00 ~ I99 C00 ~ C99	
F	T6 = ... (Track 6)	OFF, I00 ~ I99 C00 ~ C99	
G	T7 = ... (Track 7)	OFF, I00 ~ I99 C00 ~ C99	
H	T8 = ... (Track 8)	OFF, I00 ~ I99 C00 ~ C99	

This indicates the Program setting for each track. The Program of each track can be changed temporarily while playing.

- * This value changes when changing the Program using F0-1 REC/PLAY, if program change is included in the data which is being played.
- * When changing the song by F0-1 REC/PLAY, the Program number in the song parameter is reset.

F 1 - 2 TRACK VOLUME

SONG0	TRACK VOLUME							Track 1
99	99	99	99	99	99	99	99	
A	B	C	D	E	F	G	H	

A	Track 1	0~99	Setting the volume of each track.
B	Track 2	0~99	
C	Track 3	0~99	
D	Track 4	0~99	
E	Track 5	0~99	
F	Track 6	0~99	
G	Track 7	0~99	
H	Track 8	0~99	

This determines the volume control setting for the Program of each track. The volume of each track can be changed temporarily while playing.

- * This value changes when adjusting the volume using F 0-1 REC/PLAY, if volume control is included in the data which is being played.
- * When the song is changed by F 0-1 REC/PLAY, the volume value in the song parameter is reset.

F 1 - 3 TRACK STATUS

SONG00	TRACK STATUS				Track 1			
ON	ON	ON	ON	ON	ON	ON	ON	ON



A	Track 1	OFF/EXT/INT/ON	OFF: play disabled EXT: only MIDI OUT INT: play using only internal sound origin ON: play using both internal sound origin and MIDI OUT
B	Track 2	OFF/EXT/INT/ON	
C	Track 3	OFF/EXT/INT/ON	
D	Track 4	OFF/EXT/INT/ON	
E	Track 5	OFF/EXT/INT/ON	
F	Track 6	OFF/EXT/INT/ON	
G	Track 7	OFF/EXT/INT/ON	
H	Track 8	OFF/EXT/INT/ON	

There are four selections: play disabled (OFF), play only MIDI OUT (EXT), play using only internal sound origin (INT) and play using both (ON) for the play data of each track.

- * This setting is memorized as part of each song as a song parameter.
- * If another MIDI device is being used -- for example, another 16-voice multi-timbral synthesizer -- additional voices in each track can be allotted to the device, allowing a total of 32 voices that can be played simultaneously.

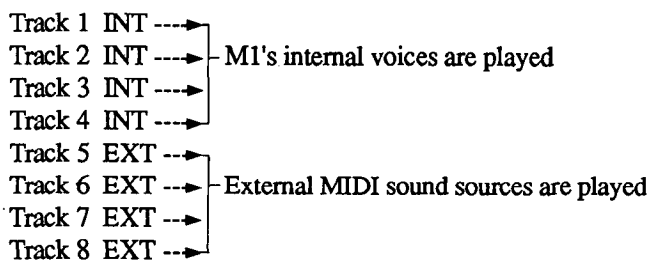

- * When the MIDI Overflow parameter of GLOBAL Mode function F 5-1 (MIDI Global) is ON, note data is sent through MIDI OUT only when it beyond the maximum simultaneous polyphonic output of the internal sound source. (The track status must also be set to ON.)

F 1 - 4 MIDI CH (MIDI channel)

SONG00	MIDI CH				Track 1			
1G	2	3	4	5	6	7	8	



A	Track 1	1~16	Setting MIDI channel of each track
B	Track 2	1~16	
C	Track 3	1~16	
D	Track 4	1~16	
E	Track 5	1~16	
F	Track 6	1~16	
G	Track 7	1~16	
H	Track 8	1~16	

Sets the MIDI channel for playback of each track. (Sequence data and the set MIDI channel corresponding to the sound origin change at the same time.)

- * This setting is memorized as part of each song as a song parameter.
- * Usually different channels are assigned to each of the eight tracks. However, layering of sounds is possible by assigning two tracks to the same channel.

Example

Track 1	ch. 1	Program 00	Play data of track 1
Track 2	ch. 1	Program 01	(no data is entered)

Plays Program 00 and Program 01 together in layered fashion from the play data of track 1.

- * It is possible to input play data separately by setting more than two tracks to the same channel. (The Program of the other track should be set to "OFF.")

Example

TR 1	ch. 1	PROG 00	Note data
TR 2	ch. 1	OFF	Control data

Program 00 can be played with the combined note and control data.

F 2 - 1 STEP RECORDING

SONG00 STEP RECORDING	
Track=1	Measure=001
A	B C D E F G H

[A]	Track	1 ~ 8	Track number to be recorded
[H]	Measure	1 ~ 250	Measure number

SONG00 Tr-1 M001 1:00 Step Time	
Step=1/4	---- mf Ten [RST][TIE][◀]
A	B C D E F G H

[B]	Step Time	1/32-1/1	The basic length of a note (a thirty-second to a whole note)
[C]	Triplet/Dot	---- TRIP DOT	Changing the length of a note Note specified by step Triplet of the specified note by step Dotted note of the specified note by step
[D]	Key Dynamics	<i>ppp - fff</i>	Strength (volume) of sound (very weak to very strong)
[E]	Staccato/Tenuto	Stac ---- Ten	Style of play Staccato (cut short) Regular playing style Tenuto (holding to full note-value)
[F]		[RST]	Setting rest marks
[G]		[TIE]	Setting ties (only if a note has been input)
[H]		[◀]	Goes back one step (step back)

In step recording, the length and the strength of each note is input by specifying the value and the pitch is input by specifying the key.

* The data included in the measure which was recorded is erased.

1. Sets the track (**A**) to be recorded and the measure number (**H**) at which recording will start. Make certain that the MIDI channels of the external keyboard and the track are the same.

2. Press the START/STOP key after pressing the REC key; it will light up.

* Shown at the top of the display are: the measure number of the step to be recorded, the time signature, and the clock position in the beat. (The value of 1 clock is 1/48 of a quarter note.)

M001 1:24
 Measure Beat Clock

3. Sets the type (length) of the note to be input by step time (**B**) and triplet/dot (**C**). (The value of a triplet is 2/3 of the step time, and the value of a dot is 3/2 of the step time.)

B	32	16	8	4	2	1
C						
TRIP						
DOT						

4. Sets the length each note sounds (staccato/tenuto) (**E**).

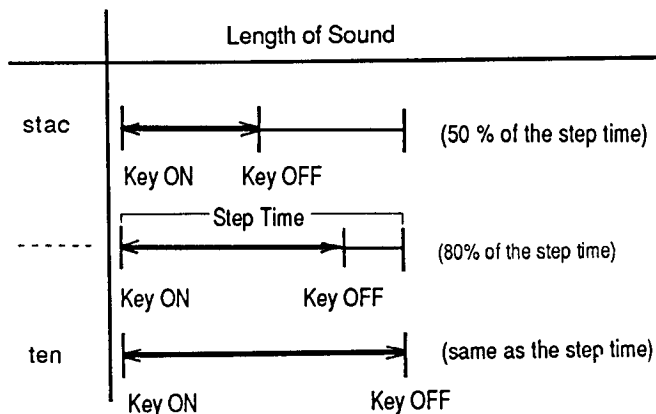

5. Sets the sound strength (volume) by key velocity (**F**).

	Strength	Velocity value
<i>ppp</i>	Pianississimo (very weak)	24
<i>pp</i>	Pianissimo	44
<i>p</i>	Piano	54
<i>mp</i>	Mezzo piano (slightly weak)	64
<i>mf</i>	Mezzo forte (slightly strong)	74
<i>f</i>	Forte	84
<i>ff</i>	Fortissimo	94
<i>fff</i>	Fortississimo (very strong)	114

- * In step recording the strength at which the keyboard is played is ignored.
- 6. Use the keyboard to input the notes while step recording. (Likewise, play a chord when inputting chords.) All the keys that are played until their release are recorded together in the same step regardless of the actual timing of playing the keys.
- 7. Recording proceeds to the next step when all the keys are released. Repeat operations 3 through 6 as many times as you want.
- * When entering rests, recording proceeds to the next step by pressing rest (**[F]**).
- 8. After finishing all step inputs, press the START/STOP key to complete the recording.
- * Step is forwarded as many times as set by the step time when pressing Rest (**[F]**).
- * The note input in the previous step lengthens by the amount of the step time when pressing tie (**[G]**).
- * There are two ways of inputting longer notes than the note value set by step time. One method is to reset the note by step time and the other is to lengthen by using tie. The length of the note as determined by each method is shown below:

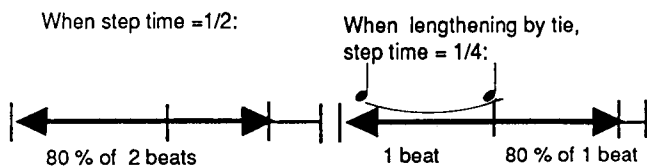

- * Tie can also be set while playing the keys, and the note becomes longer according to the amount of step time. In this case, the tie affects only the played key's sound, making it possible to change chords around the held key.



- * The step can be moved back as far as set by the step time when pressing step back (**[H]**). Any notes or steps starting from and occupying the space moved back to are deleted.

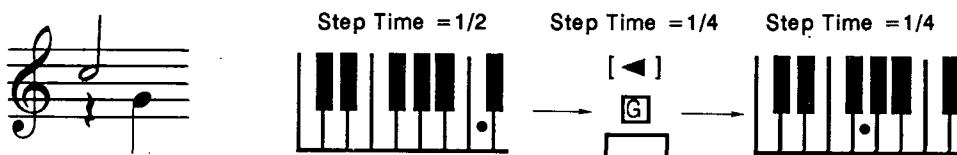

- * This is used not only for deleting mistakenly entered notes, but also used for inputting succeeding notes; in such applications step back is used to shorten the step time.

- * In step recording, control data cannot be input. Record the control data on another track in real time and bounce or insert the control data by using event edit.

F 3 - 1 SONG PARAMETER

SONG0	New Song	[◀] [▶]	Next=OFF	♩=120			
A	B	C	D	E	F	G	H

[C]		[◀]	Moving cursor to the left
[D]		[▶]	Moving cursor to the right
[F]	Next Song	OFF, 0-9 C0 ~ C9	Following song to be played
[H]	♩ = Tempo	40 ~ 208	Initial tempo of the song (beats per minute)

- * Input the song name (up to ten characters) by using [◀] ([C]) and [▶] ([D]). (Identical to PROGRAM Mode F 9 - 1, RENAME.)
- * In Tempo set the initial tempo of the song.
- * Tempo can be changed by the tempo change function as part of the play data.
- * When recording in real time, set the tempo in this function before recording.
- * Setting tempo has no effect when clock (in GLOBAL Mode F5-1) is set to MIDI.
- * Next Song sets the song that will follow the present song's completion.
- * When playing song 0, 5 and 2 continuously:

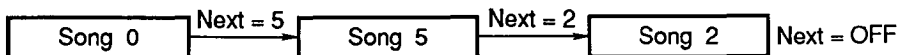

- * If the first song is set as the next song, it will continue to play repeatedly.
- * When the memory card which has sequence data in it is inserted in the PROG/SEQ DATA slot, songs in the card can be selected. (It is necessary to create sequence data inside the MIR.)
- * When Next Song is set, a short break may occur between the playing of successive songs.

F 3 - 2 SONG INITIALIZE

SONG0	SONG INITIALIZE						
Song=0	Beat=4	[EXEC]					
A	B	C	D	E	F	G	H

[A]	Song	0 ~ 9	Selection of song
[D]	Beat	2/4 ~ 6/4	Setting time signature (2/4 ~ 6/4)
[G]		[EXEC]	Executing the initialization

This function erases all song data (including data on all of the tracks) and sets the time signature (number of beats per measure) at the same time.

1. Select the song to be initialized (**B**).
2. Set the number of beats per measure of four (**D**) of the song in the range of 2/4 and 6/4.
3. Execute INITIALIZE by [EXEC] (**G**).

- * The display prompts for confirmation if the song to be initialized has data in it.
- * The time signature set here cannot be changed unless it is initialized again.
- * The protect function (F 4-1) for each track is ignored here.

F 4 - 1 TRACK PARAMETER

SONG00	TRACK PARAMETER	Track
Tr1	I00 V99 T+00 D+00 A	Prot:OFF
A	B	C
D	E	F
G	H	

A Tr	Track	1 ~ 8	Selecting the track to be edited
B	Program	OFF,I00 ~ I99 C00 ~ C99	Program (sound color) of current track
C G	Volume	0 ~ 99	Volume of current track
D T	Transpose	- 24 ~ +24	Transposition (in semitones) current track
E D	Detune	-50 ~ +50	Minute adjustment of pitch of current track
F	Panpot	A/9:1~1:9/B/C/C+D/D	Output destination of current track
G Prot	Track Protect	OFF/ON	Prevents recording on current track

This function edits the parameter of each track.

- * Select the track whose parameter is to be edited by using Track. The parameter of each track is indicated by the number of the track.
- * Program sets the Program (sound color) of the track. The Program set here is played until any program changes appear in the play data.
- * If real time recording is executed, the Program used at that time is set here.
- * When the memory card having Program data stored in it is used, Programs in the card can be selected. (Make sure the correct card is inserted when playing Programs from the card.)
- * Volume controls the volume of the track.
- * When recording in real time, the volume used in recording is set to the same level here.
- * Transpose and Detune adjust the pitch of the track. (Transpose adjusts in semitone steps, and Detune in cent steps.)
- * Panpot (pan) sets the output destination of the track. Settings are: A, A:B (1:9 - 9:1), B, C, C + D, and D.
- * Recording and editing are prevented when Protect is ON.
- * It is recommended to set Protect to ON for tracks which have been recorded to avoid erasing or rewriting data by mistake.

F 4 - 2 TRACK COPY/BOUNCE

SONGB	COPY/BOUNCE	Source Track
(COPY)	Tr2 ---> Tr1	[EXEC]
A	B	C
D	E	F
G	H	

A	Copy/Bounce	COPY/BOUNCE	Switching between copy and bounce
C Tr	Source Track	1 ~ 8	Track number to be bounced
E Tr	Dest Track	1 ~ 8	Track number of bounce destination
G		[EXEC]	Executing the bounce

This function lets you copy or bounce the play data from track to track.

Track Copy

This copies the play data from one track to another.

1. Select the COPY function (**A**) and set the source track (the track that will be copied) (**C**), and the destination track (the track to which the copy will be made) (**E**).
2. COPY is executed by pressing [EXEC] (**G**).

Track Bounce

This combines the play data of two tracks into one.

1. Select the BOUNCE function (**A**) and set the source track (the track that will be bounced) (**C**), and the destination track (the track to which the selected track will be bounced) (**E**).
2. BOUNCE is executed by pressing [EXEC] (**G**).

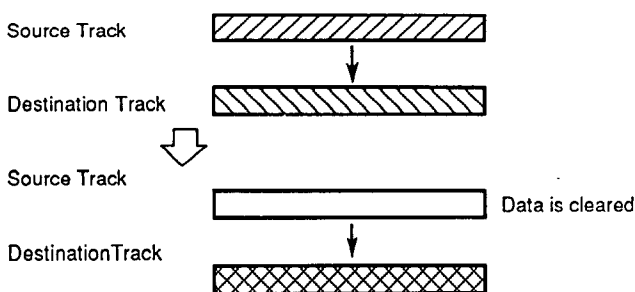

- * The data on the source track is cleared after the bounce operation.
- * Setting of destination track is effective for track parameters like track Program (sound color) and MIDI channel. (Note that after bouncing tracks which have different Programs or MIDI channels, the track bounced to is assigned only one Program or MIDI channel and the original assignments cannot be recovered.)
- * Bouncing may cause an unnatural effect when control change data is included in both of the tracks. (Control change data can be deleted by Measure Erase, F 5 - 3.)
- * When patterns are included in the source track, that track cannot be bounced unless the corresponding measures of the destination track are empty. (An error message results.)

F 4 - 3 TRACK ERASE

SONG00		TRACK ERASE		Track = 1		[EXEC]	
A	B	C	D	E	F	G	H

[D]	Track	1 ~ 8	Track number whose play data is to be erased
[G]		[EXEC]	Executing the erase

This function erases one track in the current song.

1. Select the track to be erased ([D]).
2. Execute ERASE by [EXEC] ([G]).

* A prompt for confirmation appears when the track to be erased has data.

F 5 - 1 PUT/COPY PATTERN

SONG00		PUT/COPY PAT		(PUT)		P00 --> Tr1 M001 [EXEC]	
A	B	C	D	E	F	G	H

[A]	PUT/COPY	PUT COPY	Selection of pattern function (put or copy) Assigning pattern Copying pattern
[C] P	Pattern	0 ~ 99	Pattern number
[E] Tr	Track	1 ~ 8	Track number
[F] M	Measure	1 ~ 250	Measure number
[G]		[EXEC]	Executing PUT or COPY

Patterns can be connected or strung together in the measure of the specified track. There are two ways of connecting patterns: PUT and COPY. PUT writes the pattern number to the track, and COPY copies the play data of the pattern to the track.

* In the case of PUT:

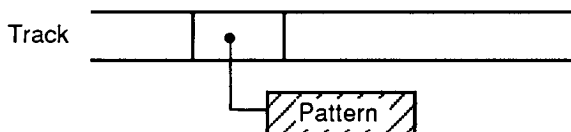

* Consumes little memory.

* Play changes when pattern is revised.

* In the case of COPY:

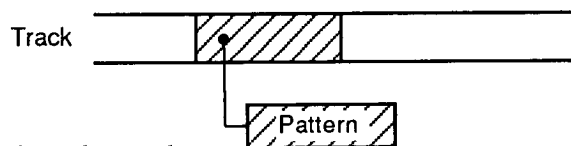

* Play data can be revised on the track.

* Play does not change even if the pattern is revised.

1. Specify whether PUT (writing in the pattern number) or COPY (writing in the play data of the pattern) will be used ([A]).
2. Specify the pattern ([C]), track ([E]) and measure ([F]) to be written in.
3. Execute by [EXEC] ([G]).

* The play data included in the measure, which is in the specified measure, will be lost. (A prompt for confirmation will appear when the play data is included.)

- * Measures move to fill the space left by the pattern measure after executing.
- * If the time signature of the song and the pattern differ, PUT/COPY cannot be executed.
- * Patterns which do not have data cannot be used with PUT. (Create a pattern before using PUT.)
- * When using PUT to assign a pattern of longer than two measures, specific measures within the pattern cannot be erased or edited while they are part of the track; they must be edited separately.

F 5 - 2 MEASURE COPY

```

SONG0 MEASURE COPY Source Song
Song0 Tr1 M001 L004→Tr1 M005 [EXEC]
  A     B     C     D     E     F     G     H

```

[A] SONG	Source Song	0 ~ 99	Song number which has the measure to be copied
[B] Tr	Source Track	1 ~ 8	Track number which has the measure to be copied
[C] M	Source Measure	1 ~ 250	First measure number to be copied
[D] L	Length	1 ~ 250	Length of measures to be copied (in measures)
[E] Tr	Dest Track	1 ~ 8	Track number to which measure is to be copied
[F] M	Dest Measure	1 ~ 250	First measure of destination
[G]		[EXEC]	Executing the copy

Copies the specified range of the play data.

1. Specify the song ([A]), track ([B]) and the first measure ([C]) of the copy source, and specify the track ([E]), the first measure of the destination ([F]) and number of measures to be copied ([D]) to the destination.
2. Execute COPY by [EXEC] ([G]).

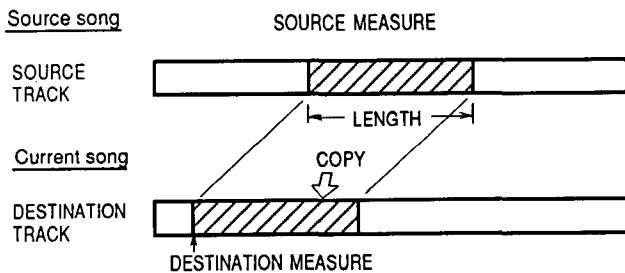

- * The data included in the destination copy will be lost. (A prompt for confirmation will appear when play data is included.)
- * When there is a tied note which lays between the inside and outside of the specified range, the tie is deleted when copying.
- * Copy cannot be executed when the pattern lies between the inside and outside of the specified range.
- * Copy cannot be executed when the time signatures of the source and destination differ.
- * When copying within the same track, the copy function cannot be executed if the range of the destination measure and the range of source measure overlap.

F 5 - 3 MEASURE INS/DEL/ERASE (Measure Insert/Delete/Eraser)

SONG00	INS/DEL/ERASE							
(INSERT)	Tr1	M001	L000			[EXEC]		
A	B	C	D	E	F	G	H	

A	INS/DEL/ERASE	INSERT DELETE ERASE	Selection of function (insert/delete/erase) Inserting measure Deleting measure Erasing data
C Tr	Track	1 ~ 8 ALL	Track number
D M	Measure	1 ~ 250	Measure number
E L	Length	1 ~ 250	Length (in measures)
F	Erase Data	ALL NOTE CTRL	Types of data to be erased (Erase only) All data (effectively puts a rest at the specified point) Note data (key information) Control data (joy stick, after touch, etc.)
G		[EXEC]	Executing insert/delete/erase

This function inserts and deletes measures and erases play data. First select the desired function, -- insert, delete, or erase -- by using INS/DEL/ERASE (**A**).

MEASURE INSERT

This function inserts an empty measure of a specified length.

1. Set the track (**C**), measure (**D**) and number of measures (**E**).
2. Executes insert by [EXEC] (**G**).

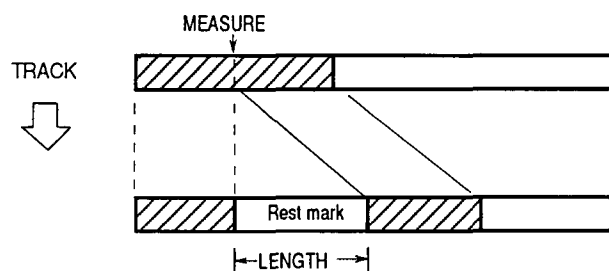

- * The measures following the specified measure move over to accommodate the inserted measures.
- * When setting TRACK to ALL, insert is executed to all the tracks.
- * Insert cannot be executed to a measure in the middle of a pattern.
- * When there is a tied note which lies between the inside and outside of the specified measure, the tie is deleted and the note is divided into two.

MEASURE DELETE

This function deletes play data in the specified range.

1. Specify the track (**C**), the first measure (**D**) and the number of measures (**E**) to be deleted.
 2. Execute delete by [EXEC] (**G**).
- * A prompt for confirmation appears when there is data in the measure to be deleted.

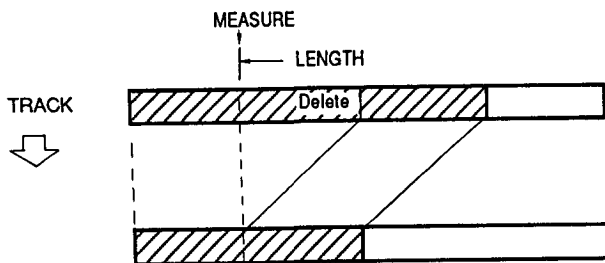

- * The data following the deleted measure is moved to fill the space left by the deleted measure.
- * When setting the TRACK to ALL, Delete is executed for all the tracks.
- * Delete cannot be executed on a measure in the middle of a pattern.
- * When patterns are included in the deleting range, the measures occupied by the patterns are erased.
- * When there is a note lying between the inside and outside of the specified range, the part of the note in the range is deleted.

MEASURE ERASE

This function deletes the specified measures from the play data in the specified range.

1. Specify the track (**[C]**), the first measure (**[D]**) and the number of measures (**[E]**) to be erased.
2. Specify the data to be deleted (**[F]**).
 ALL: all data
 NOTE: note data (from keyboard)
 CTRL: control data (pitch bend, after touch, modulation wheel, etc.)
3. Execute ERASE by [EXEC] (**[G]**).

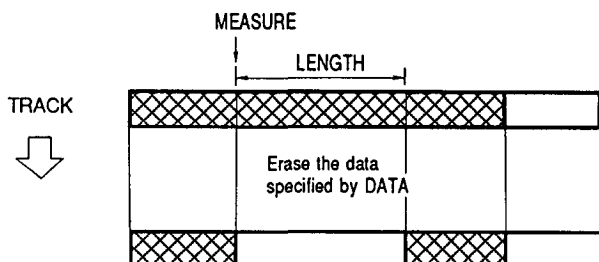

- * Erase is executed for all the tracks when TRACK is set to ALL.
- * This function cannot erase the measure in the middle of the pattern.
- * When setting DATA to ALL, and when there are patterns included in the range to be erased, the measure that the patterns occupy is erased. (When selecting NOTE or CTRL, patterns are not erased.)
- * When there is a note lying between the inside and outside of the specified measure, the part of the note inside the range is erased.
- * As a result of editing measures with these functions, messages such as damper = off and pitch bend = 0 may be lost, thus continuing those effects indefinitely. When this happens, erase the appropriate data, or revise by event edit.

F 5 - 4 QUANTIZE

SONG#	QUANTIZE	Quantize Data
Tr1 M001 L001	Res= $\text{♩}/48$	ALL [EXEC]

A
B
C
D
E
F
G
H

[A] Tr	Track	1 ~ 8 ALL	Track number which has the measure to be quantized All the tracks of current song
[B] M	Measure	1~250	First measure number to be quantized
[C] L	Length	1~250	Length of the measures to be quantized (in measures)
[D] Res	Resolution	$\text{♩}/48 \sim \text{♩}/1$	Quantization of rhythm
[F]	Quantize Data	ALL NOTE CTRL	Types of data to be QUANTIZED All the data Note data (keyboard information) Control data (joy stick, after touch etc.)
[G]		[EXEC]	Executing the quantization

This function automatically corrects the timing of measures in the specified range to a pre-selected beat length.

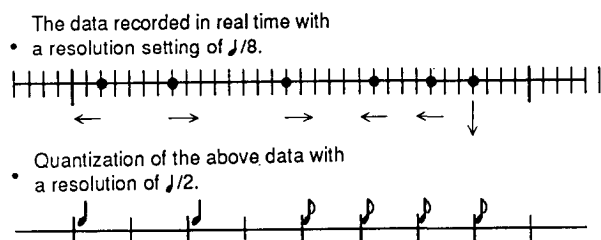

1. Specify the track ([A]), first measure ([B]) and number of measures ([C]) to be quantized.
2. Set the preciseness of quantization by using Resolution ([D]). (When $\text{♩}/1$ is set, notes are quantized to the nearest quarter note.)
3. Specify the data to be quantized ([F]).

ALL: all data

NOTE: note data (from keyboard)

CTRL: control data (pitch bend, after touch, modulation, etc.)

4. Execute QUANTIZE by [EXEC].

* When two events of the same kind of control data are moved to the same note-value as a result of quantizing the control data, they are put together into one. Because of this it is possible to thin down the amount of control data and thus economize memory by use of quantization. (The quantization resolution of $\text{♩}/48$ is provided for this purpose.)

F 6 - 1 PATTERN REAL TIME REC (Pattern Real Time Recording)

PATTERN	REAL TIME REC	Resolution
P02	♩/48 MM:OFF	♩=120 M1 (ADD) [ERA]
A	B	C
D	E	F
G	H	

A P	Pattern Number	00~99	Pattern number to be assigned
B	Resolution	♩/48~♩/1	Quantization of rhythm
C MM	Metronome	OFF/ON	Metronome sound
E ♩=	TEMPO	40 ~ 208	Tempo (in beats per minute)
F M	Measure Number	1 ~ 8	Measure number
G	Add/Remove	ADD RMV	Adding to pattern data Deleting pattern data
H		[ERA]	Erasing pattern data

This function allows real time recording, deletion and changing of pattern data. In creating a new pattern, set the time signature and the length (number of measures) in F 6-3 PATTERN INITIALIZE and erase the play data beforehand.

1. Select the pattern to be made (**A**). Patterns made by step write and copy are also selectable.
2. Make certain that the MIDI channels of the external keyboard and the track (as set in F 0 - 1, PLAY/REC) are the same.
3. Set the resolution (**B**), metronome ON/OFF (**C**) and tempo (**E**). These are changeable in real time.
4. Start recording by first pressing the REC key, then the START/STOP key; the START/STOP key will light up. In Pattern Real Time Recording, when the last measure is finished, the first measure is returned to and you can continue recording. In this case, all data recorded on the second pass is overdubbed onto the initially recorded data. When mistakes are made in recording, revise by erasing the data.

F 6 - 2 PATTERN STEP RECORDING

PATTERN	STEP RECORDING
	Pattern = 02

A B C D E F G H

[E]	Pattern Pattern Number	0~99	Pattern number to be step recorded
------------	---------------------------	------	------------------------------------

PATTERN	M1	1:00	Step
Step=1/4	----	mf	Ten [RST][TIE][◀]

A B C D E F G H

[B]	Step	1/32 ~ 1/1	Length of the basic note (thirty-second note – whole note)
[C]	Triplet/Dot	---- Trip Dot	Changing the length of the note Note specified by step Triplet of specified note by step Dotted note of the specified note by step
[D]	Key Dynamics	<i>ppp</i> ~ <i>fff</i>	Strength (volume) of sound (very weak – very strong)
[E]	Staccato/Tenuto	Stac ---- Ten	Style of playing Staccato (cut short) Regular way of playing Tenuto (held to full note-value)
[F]		[RST]	Inputting Rest
[G]		[TIE]	Setting tie
[H]		[◀]	Going back 1 step (Step back)

Patterns are made by Step Write here. When making new patterns, first set the time signature and length (number of measures) by F 6 - 3, INITIALIZE and erase the existing play data before recording.

1. Select the pattern to be created (**[A]**). Patterns made by real time recording or by the GET function can be also selected.
 2. Make certain that the MIDI channels of the external keyboard and the track (as set in F 0 - 1, PLAY/REC) are the same.
 3. Press the REC key (so that it lights up) and then press the START/STOP key.
 4. Operation steps from this point are identical to steps 3 through 8 of F 2-1 STEP RECORDING. However, when recording of the set length (number of measures) is finished, the first measure is returned to and overdubbing begins.
- * The operations of rest (**[F]**) and tie (**[G]**) are the same as that in F 2-1 STEP RECORDING.
 - * The step can be moved back as far as set by the step time when pressing step back (**[H]**). Any notes or steps starting from and occupying the space moved back to are deleted.
 - * The Program used at the time the pattern is created is the one used for the current track. (When inserting a pattern in the track, the Program becomes the same as that used in the track.)

F 6 - 3 PATTERN INITIALIZE

```
PATTERN INITIALIZE
Pattern=02 Beat=4 Length=1 [EXEC]
A B C D E F G H
```

[B]	Pattern	0~99	Pattern number to be initialized
[D]	Beat	2~6	Selection of time signature (2/4 – 6/4)
[F]	Length	1~8	Length of pattern (in measures)
[G]		[EXEC]	Executing the initialize function

This function sets defaults for the pattern (and erases any existing data). It also sets the time signature and the pattern length (up to eight measures) of each pattern here.

1. Select the pattern number to be initialized ([B]).
 2. Set the time signature ([D]) and the number of measures ([F]) of the pattern.
 3. Initialize by [EXEC].
- * The time signature and the length set here cannot be changed unless re-initialized.
 - * When the specified pattern is used in the song, the display will show, "Pattern used in song." All the patterns in the song are erased by pressing YES ([G]). Pattern initialize is cancelled by pressing NO ([H]).

F 6 - 4 GET PATTERN

```
PATTERN GET FROM TRACK Pattern
Song0 Tr1 M001 --> P00 [EXEC]
A B C D E F G H
```

[A]	Source Song	0 ~ 9	Song number which has the measure to "GET"
[B] Tr	Source Track	1 ~ 8	Track number which has the measure to "GET"
[C] M	Source Measure	1 ~ 250	Number of the first measure to "GET"
[E] P	Pattern	0 ~ 99	Pattern number from which data is taken
[G]		[EXEC]	Executing the GET PATTERN function

This function transfers play data to the pattern by copying from a track. Patterns can easily be created from data on the track.

1. Set the time signature and the length of the pattern by using Pattern Initialize (F 6-3) beforehand. Also set the time signature to be the same as the song that will be copied from and set the length to the number of measures desired.
2. Specify the song ([A]), track ([B]) and the first measure ([C]) of the source song and specify the pattern ([E]) of the destination.
3. Copy by pressing the [EXEC] ([G]) key.

- * A prompt for confirmation appears when data already exists in the destination pattern.
- * The copy function cannot be executed when the time signature of the song and the pattern differ.
- * The copy function cannot be executed when there are patterns in the specified source range.
- * When there is a tied note lying between the inside and outside of the specified range, it is copied after deletion of the tie.
- * Edits which cannot be executed on the pattern (quantization, for example) can be accomplished by copying the pattern to an empty track, editing it there, then copying it back to the original track.

F 6 - 5 PATTERN COPY/BOUNCE

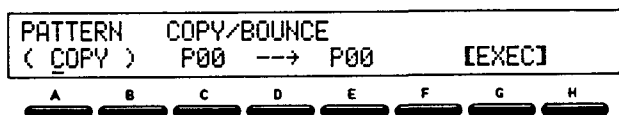

A	COPY/BOUNCE	COPY BOUNCE	Selection of the function (copy or bounce) Copying from pattern to pattern Bouncing from pattern to pattern
C P	Source Pattern	0 ~ 99	Pattern to be copied (bounced)
E P	Dest. Pattern	0 ~ 99	Destination pattern to be copied (bounced)
G		[EXEC]	Executing the copy or bounce

This function copies and bounces the play data from pattern to pattern.

- * Copying or bouncing cannot be executed when the time signatures or the lengths of the source and destination patterns are different.

Pattern Copy

Copies from pattern to pattern.

1. Specify the source pattern (**C**) and destination pattern (**E**).
2. Copy by pressing the [EXEC](**G**) key.

Pattern Bounce

This function combines the play data of two patterns into one pattern.

1. Set the source pattern (for bouncing) (**C**) and the destination pattern (for bouncing) (**E**).
 2. Bounce by pressing the [EXEC] (**G**) key.
- * As opposed to the track bounce function, the pattern which was specified as a source is not erased.

F 7 - 1 EVENT EDIT

```

EVENT EDIT
( TRACK ) = 1
  A   B   C   D   E   F   G   H

```

C	TRACK/PATTERN	TRACK PATTERN	Selection of material to be edited Track of current song Pattern
E	Track No./ Pattern No.	1~8 00~99	Setting track number (when track is selected) Setting pattern number (when pattern is selected)

```

EVENT EDIT Measure
M001 #001 1:00 F#4 U064 0:24 [INS][DEL]
  A   B   C   D   E   F   G   H

```

A M	Measure	1~250	Measure to be edited
B #	Index	1~	Selection of event to be edited
C	Location	TIE, 1:00 ~ 6:47	Position of event in measure
D	Event	C-1 ~ G9 BEND AFTT PROG CTRL	Type of event Note Pitch bend After touch Program change Control change
E V C	Velocity Bend After touch Program Control	2~126 -8192 ~ 8191 0~127 100~199/C00~C99 0~108	(for note) (for pitch bend) (for after touch) (for program change) (for control change)
F	Length Data	0:00 ~ 6:00 TIE 0~127	Length of note (for note) Control data (for control change)
G		[INS]	Inserting event
H		[DEL]	Deleting event

Sequence data having a length of 1 step is called an event. For instance, a note assumes a value of 1 even though it has a combination of data types, such as pitch (note number), volume (velocity) and the length of the sound. Control data also assumes a step value of 1 even though it is a combination of type and value.

* For control data, 1 MIDI message corresponds to 1 event.

Event edit is a function that changes, inserts and deletes any event in the play data of tracks or patterns.

* In event edit, any and all events can be edited; moreover, sequence data is re-written directly. This editing, as a result, is both convenient and dangerous -- dangerous in that play data prior to editing cannot be recovered. Double checking of to-be-edited material is advised.

Event Operation

1. Select either editing of track data or pattern data (**C**) and specify the track number or pattern number (**E**).
2. Press the REC key, and, when it lights up, press the START/STOP key. You have now called up the EVENT EDIT Mode.
- * Other modes or functions cannot be selected until event editing is finished by pressing the START/STOP key again.
3. Specify the measure to be edited (**A**). The first event of that measure is indicated.
4. By increasing the Index (**B**) from #001, the events in the measure can be seen in the order of their location (their position in the measure).
- * The location is indicated by the beat number within the measure and by the clock number in the beat. One clock pulse is the same as 1/48 beat. (One MIDI clock pulse is equal to two M1 clock pulses.)

EVENT EDIT				Event			
M001	#004	1:04	BEND	+4095		[INS]	[DEL]
A	B	C	D	E	F	G	H

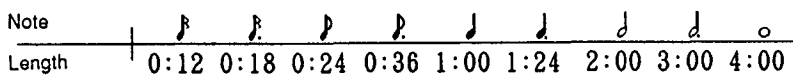

- * Note events include: note name (the pitch of the note) (**D**), velocity (the strength at which the keys are hit) (**E**), and duration (length of sound) (**F**).
- * Odd numbers are not available for velocity value settings.
- * When pitch bend, after touch or program change are selected by **D** , their values are indicated above **E** .

EVENT EDIT				Event			
M001	#004	1:04	BEND	+4095		[INS]	[DEL]
A	B	C	D	E	F	G	H

- * When control change is selected by **D** , the type of control change (control change number) is shown above **E** and its value above **F** :

```

EVENT EDIT      Event
M001 #005 1:08 CNTL C064 64  [INS][DEL]

```

A B C D E F G H

Control Number	Type of Control	Value
1	Pitch Modulation	0 (OFF) ~ 127 (Max.)
2	VDF Modulation	0 (OFF) ~ 127 (Max.)
7	Volume	0 (Min.) ~ 127 (Max.)
64	Damper Switch	0 (OFF), 127 (ON)
102	VDF Cutoff	0 (LOW) ~ 64 ~ 127 (HIGH)
103	Effect 1 Switch	0
104	Effect 2 Switch	0
105	Effect 1 Control	0 (Min.) ~ 64 ~ 127 (Max.)
106	Effect 2 Control	0 (Min.) ~ 64 ~ 127 (Max.)
107	Tempo Change	0 (-50%) ~ 64 ~ 127 (+50%)

- * The control numbers not listed in this chart are the data of control change recorded from MIDI IN.
- * MIDI does not input or output 102 to 107.
- * The measures without events are indicated as below. (Edit functions, with the exception of insert cannot be executed.)

```

EVENT EDIT      Measure
M003      --- No Events ---  [INS]

```

A B C D E F G H

- * The measures occupied by patterns are indicated as below. (No editing is possible. Changing patterns should be done in F 5 - 1.)

```

EVENT EDIT      Measure
M004      --- Pattern 00 ---

```

A B C D E F G H

Editing Events

When Event is selected, the pitch of the sound and type of event can be changed by **[D]** and the data of the event can be changed by **[E]** and **[F]**. (See the Event Operation section for more information.)

Moving Events

The indicated event can be moved within the measure by using Location (**[C]**).

- * When the order of events changes by moving of an event from one location in the measure to another, the index numbers of the events shift accordingly. (Though the index numbers change, this is completely different than changing the index numbers directly by Index (**[B]**).)
- * Moving events between measures can be accomplished by using the Delete and Insert functions.

Deleting Events

When an event is selected, the event can be deleted by pressing [DEL] (**H**).

- * The index value of events that follow the deleted event in the measure will decrease by 1. (Location does not change.)
- * If you mistakenly make a deletion, pressing **G** immediately after the deletion will restore it.

Inserting Events

When an event is selected, the same event can be inserted to another location (or the same one, if desired) by pressing [INS] (**G**). Any events can be inserted by moving the location or editing the event.

- * When using the insertion function right after deleting, the deleted event will be inserted.
- * The index value of events following the inserted event in the measure will be increased by 1. (Location does not change.)
- * New tracks can be made by Event Insert. In this case it is necessary to create an empty measure beforehand by using Insert Measure (F 5-3).
- * A note lying over two measures is treated as 2 notes connected with a tie. When editing such notes, follow the procedure below:

A

	EVENT EDIT				Index			
M001	#002	1:00	C4	U064	TIE	[INS]	[DEL]	
A	B	C	D	E	F	G	H	

B

	EVENT EDIT				Length			
M002	#001	TIE	C4		0:24	[INS]		
A	B	C	D	E	F	G	H	

1. Edit the note number and velocity of the note in A. The note in B is automatically revised.
2. When changing the note length, edit note in B.
3. When deleting both in A and B, do it in the order of A and B. When deleting only in B, set the note length in A to a value 1 unit smaller than "TIE," then delete in B.
4. When inserting both in A and B, set the note length in A to "TIE" after inserting in A and B separately.

EFFECT PARAMETERS

F 8 - 1 Effect 1

F 8 - 2 Effect 1 Parameter

F 8 - 3 Effect 2

F 8 - 4 Effect 2 Parameter

F 8 - 5 Effect Placement

F 8 - 6 Effect Copy

Descriptions of functions F 8 - 2 and F 8 - 4 are given in the Effect Parameter section following the EDIT PROGRAM Mode chapter.

F 8 - 1 EFFECT 1

EFFECT 1							
(01:	Hall)	:	ON			
<u>A</u>	<u>B</u>	<u>C</u>	<u>D</u>	<u>E</u>	<u>F</u>	<u>G</u>	<u>H</u>

Selects the effect type for Effect 1.

A	EFFECT TYPE	01~03 No Effect
F	SWITCH	OFF/ON [SELECT]

F 8 - 3 EFFECT 2

Selects the effect type for Effect 2.

Same as F 8 - 1 EFFECT 1.

F 8 - 5 EFFECT PLACEMENT

EFFECT PLACEMENT							
<u>S</u>	ERIAL	P3 =50:50		P4 = 50:50			
<u>A</u>	<u>B</u>	<u>C</u>	<u>D</u>	<u>E</u>	<u>F</u>	<u>G</u>	<u>H</u>

A	Effect Placement	PARALLEL SERIAL
F P3	Out 3 Panpot	OFF 100:0 ~ 0:100
H P4	Out 4 Panpot	OFF 100:0 ~ 0:100

This function sets the Effect Placement and Pan setting of Outputs 3 and 4. (See pp. 36-37 for more on Effect Placement.)

F 8 - 6 EFFECT COPY

EFFECT COPY							
from (COMBINATION) - I00 [COPY]							
A	B	C	D	E	F	G	H

B		PROGRAM COMBINATION SONG
E		I00-I99 0-9
G		[COPY]

See the Effect Parameter section (p.38) for descriptions of F 8 - 2 and F 8 - 4, as well as more about all of the Effect functions.

- * Assigning effects to Programs can be done by Effect Copy (F 8 - 6).

F 9 - 1 EXCHANGE ALL SEQ (Exchange All Sequences)

EXCHANGE ALL SEQ							
[EXEC]							
A	B	C	D	E	F	G	H

G	[EXEC]	Executing the exchange
---	--------	------------------------

Exchanges the sequence data of RAM card and that of internal memory.

- * Save and Load functions for sequence data and formatting of the RAM card are done in the Global Mode (F 8-1 to F 9-2).
- * This function cannot be done when the sequence data of internal memory is greater than the capacity of the RAM card or when the sequence data of the RAM card is greater than the capacity of the internal memory.
- * The data of Next Song in the song parameter is replaced: that of internal to card, and card to internal.
- * Make sure to store the songs you want to edit in the internal memory since creating or editing the sequence data directly to the RAM card is impossible.

F 9 - 2 LOAD 1 SONG

Load 1 Song							
Card Song 4 --->				Int Song 1		[EXEC]	
A	B	C	D	E	F	G	H

C	Card Song	0~9	Specifying the song in the card to be loaded
F	Int Song	0~9	Specifying destination song number in the internal memory
G		EXEC	Executing the load

This function loads 1 song from the card.

* When loading a song that has patterns, load those patterns beforehand (F 9-3).

* The data of the specified internal song before loading is lost.

1. Specify the song in the card to be loaded (**C**) and the internal song number to which the song will be loaded (**F**).

2. Load by pressing [EXEC] (**G**) key.

When there are different time signatures or pattern lengths used in the song to be loaded from the patterns in the internal memory, the display prompts for confirmation of the load.

Some Patterns Will Not Be Assigned Are You Sure ?							
				[YES]		[NO]	
A	B	C	D	E	F	G	H

Selecting YES (**G**) erases these patterns and loads. Load can be cancelled by pressing NO (**H**).

F 9 - 3 LOAD 1 PATTERN

Load 1 Pattern							
Card Pat 04 --->				Int Pat 01		[EXEC]	
A	B	C	D	E	F	G	H

C	Card Pattern	0 ~ 99	Specifying the pattern in the card to be loaded
F	Int. Pattern	0 ~ 99	Specifying the destination pattern number in the internal memory
G		[EXEC]	Executing the load

Loads 1 pattern in the card.

* The data of the specified internal pattern before loading is lost.

1. Specify the pattern in the card to be loaded (**C**) and the internal pattern number to which the pattern will be loaded (**F**).

2. Load by pressing [EXEC] (**G**) key.

Loading cannot be executed when the internal pattern before loading is presently used in the song.

7 -- GLOBAL MODE

In this mode, parameters relating to the M1 as a whole (master tuning, MIDI settings, etc.) and assignment of drum sounds to the Drum Kit are handled.

- * Since all parameters in this mode with the exception of a few of the MIDI parameters are stored in memory even when the power is turned off, there is no need to reset them.

FUNCTIONS IN THE GLOBAL MODE

- * The first page of each function is selected by using the numeric keypad (0-9). Select the page where parameters to be edited are by using the PAGE + and PAGE - keys.

Page		Parameter to be set
0-1	Master Tune	Adjustment of the entire instrument's pitch
1-1	Key Transpose	Transpose setting of the instrument
2-1	Pedal Assign	Assignment of each function for the two pedals
3-1	Scale Type	Selection of scale (Equal temperament, pure major, etc.)
2	User Scale	Setting the user scale
4-1	Drum Kit 1	Assignment of drum sounds
2	Drum Kit 2	Assignment of drum sounds
3	Drum Kit 3	Assignment of drum sounds
4	Drum Kit 4	Assignment of drum sounds
5-1	MIDI Global	Setting MIDI global channel, MIDI clock and overflow mode
2	MIDI Filtering	Receiving switch for each type of MIDI message
6-1	Program Memory Protect	Prevents saving of Program parameters (ON/OFF)
2	Combination Memory Protect	Prevents saving of Combination parameters (ON/OFF)
3	SEQ Data Memory Protect	Prevents saving of sequence data (ON/OFF)
4	Memory Allocation	Changing the memory allocation
7-1	MIDI Data Dump	Transmission of all parameters or sequence data by MIDI system exclusive
8-1	Load from CARD	Loading from ROM/RAM card to memory
9-1	Save to CARD	Saving from memory to card
2	Format CARD	Formatting RAM card

F 0 - 1 MASTER TUNE

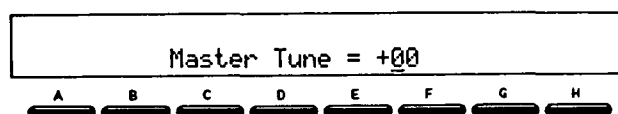

Master Tune	-50 ~ +50	Tuning the overall pitch of the M1 (in cents)
-------------	-----------	---

- * Master Tune is used to adjust the overall tuning of the M1 in the range of +/- 50 cents. This is used when tuning to match the pitch of other instruments.

F 1 - 1 KEY TRANSPOSE



Key Transpose	- 12 , +12	Transposition of the overall pitch of the M1 (in semitones)
---------------	------------	---

- * Key Transpose sets the overall pitch of the M1 over a range of +/- 1 octave (-12 to + 12) in semitone steps. This function can be used to change keys to make the playing of music in difficult keys easier.
- * This affects the data recorded to the sequencer. However, it does not affect the data played by the sequencer.

F 2 - 1 PEDAL ASSIGN

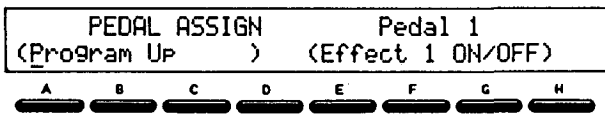

A	Pedal 1		Function assigned to Pedal 1
		Program Up	Footswitch -- Program (Combination) up
		Program Down	Footswitch -- Program (Combination) down
		SEQ Start/Stop	Footswitch -- Start/Stop of sequencer
		Effect 1 ON/OFF	Footswitch -- ON/OFF of Effect 1
		Effect 2 ON/OFF	Footswitch -- ON/OFF of Effect 2
		Volume	Foot Controller -- volume control
		VDF Cutoff	Foot Controller -- VDF cutoff frequency control
		Effect 1 Control	Foot Controller -- Effect 1 balance control
		Effect 2 Control	Foot Controller -- Effect 2 balance control
	Data Entry	Foot Controller -- adjusting parameter values	
F	Pedal 2		Functions assigned to Pedal 2
		(Same as Pedal 1)	(Same as Pedal 1)

- * Selects the function to be assigned to Pedal 1 and Pedal 2.
- * Connect footswitch or foot controller to the jack of Pedal 1 or 2 depending on the function to be selected.
- * The range controllable by the foot controller may sometimes be limited by the corresponding parameter settings.
- * Program Up: Switches to the next Program (or, in PROG/COMBI Mode, Combination) by footswitch. When this is selected, MIDI program change data is sent from MIDI OUT.
- * Program Down: Selects the previous Program (or, in PROG/COMBI Mode, Combination) by footswitch.
- * SEQ Start/Stop: Starts and stops the sequencer by footswitch.
- * Effect 1 ON/OFF: Toggles Effect 1 on and off by footswitch.
- * Effect 2 ON/OFF: Toggles Effect 2 on and off by footswitch.
- * Volume: Controls the volume of M1R by foot controller.
- * VDF Cutoff: Changes the cutoff frequency by foot controller. Cutoff frequency is raised by pressing down the pedal. (The sound color becomes brighter.)
- * Effect 1 Balance: Determines the overall balance between the direct sound and the effect sound of Effect 1 by foot controller. The ratio of the effect sound to direct sound becomes greater when pressing down the pedal.
- * Effect 2 Balance: Determines the overall balance between the direct sound and the effect sound of Effect 2 by foot controller. The ratio of the effect sound to direct sound becomes greater when pressing down the pedal.
- * Data Entry: Allows changing and adjustment of parameter values (usually controlled by the VALUE dial on the panel) by using the foot controller. The value of each parameter can be controlled by foot controller while playing if the parameters to be changed are selected beforehand.
- * Make sure to match the footswitch/foot controller connection to the assigned functions.
- * We recommend using the KORG EXP-2 for the foot controller.

NOTE: When no pedals or footswitches are connected to the rear panel jacks, set this function's parameters to correspond to footswitch operation functions (Program Up, Program Down, SEQ Start/Stop, Effect ON/OFF).

F 3 - 1 SCALE TYPE

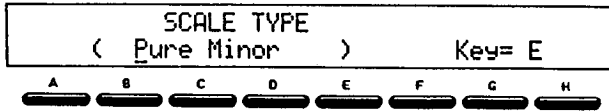

B	Equal Temp. (Equal Temperament)		Equal Temperament
	Equal Temp. 2 (Equal Temperament, Random Pitch)		Random detuning applied to each tone of Equal Temperament scale
	Pure Major		Pure Major
	Pure Minor		Pure Minor
	User Programmable		Scale in which pitch can be set for every key
H	Key	C~B	

- * Equal Temp. (Equal Temperament): A widely used tuning for keyboard instruments in which chords can be played in any key to the same effect.
- * Equal Temp. 2 (Equal Temperament, Random pitch): This equal temperament scale has random detuning applied to each note of the scale; in other words, every note that is played is detuned from the equal temperament scale by a randomly assigned amount. This is especially useful in reproducing the errors of intonation that occur in the playing of many acoustic instruments or in reproducing instruments whose pitch is slightly unstable.
- * Pure Major: Pure Major is a tuning for which chords played in the selected key are most closely in tune. Select the key from C to B.
- * Pure Minor: Select the key from C to B.
- * User Programmable: Original scales can be created by setting the pitch of each of the 12 tones from C to B in the range of +/- 50 cents (based on equal temperament). With this function, the playing of specific or unique scales besides the preset scales is possible.
- * Scale type is operative in the same way for all Programs.

F 3 - 2 USER SCALE

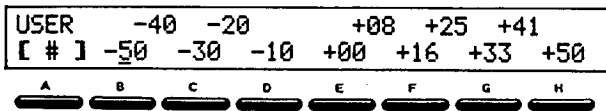

A [#]			Moves cursor to the key a semitone above present key
B	C/C#	-50 ~ +50	Pitch (in cents) of each sound compared to equal temperament
C	D/D#	-50 ~ +50	
D	E	-50 ~ +50	
E	F/F#	-50 ~ +50	
F	G/G#	-50 ~ +50	
G	A/A#	-50 ~ +50	
H	B	-50 ~ +50	

- * Sets the pitch of each scale when selecting User Scale in the Scale Type function (F 3-1).

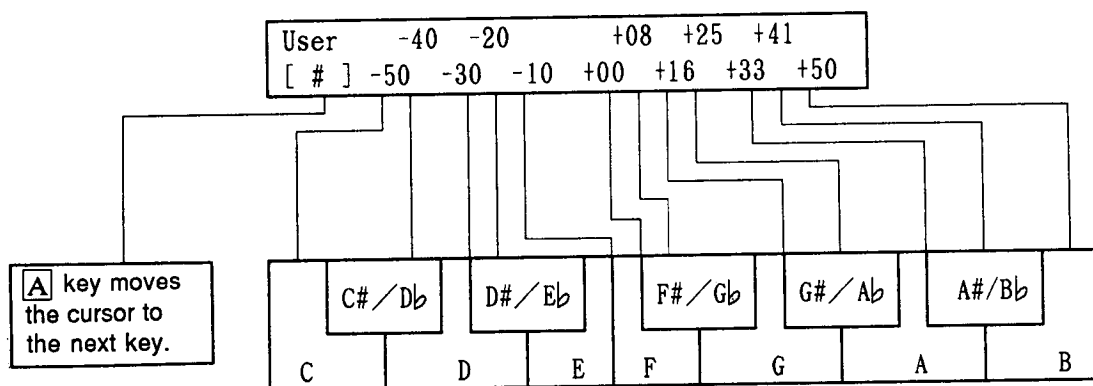

- * The 12 tones set here are assigned with the same relative settings to all octaves over the entire range of the instrument.

F 4 - 1 DRUM KIT 1

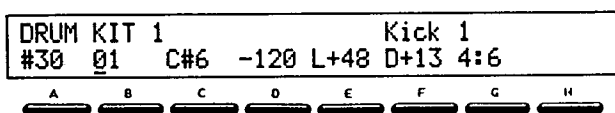

[A] #	Index	0 ~ 29	Drum sound to be edited
[B]	Inst	---, 01 ~ 44	Selection of drum sound
[C]	Key	C0 ~ G8	Key to which drum sound is assigned
[D]	Tune	-120 ~ +120	Adjustment of pitch within ± 1 octave
[E]	Level	-99 ~ +99	Level adjustment of each sound
[G]	Decay	-99 ~ +99	Adjustment of decay time of each sound
[H]	Pan	A,A:B,B,C,D+D,D	Selection of output

This function is used to edit the Drum Kit sounds and assign them to Programs of the Drum Kit mode. Up to 30 kinds of drum sounds can be assigned to each of the 4 Drum Kits (1 to 4).

- * Index selects the drum sound to edit.
- * Select the drum sound by using Inst (instrument). (See the back cover for the list of drum sounds.)
- * When using the PCM card (optional) which has drum sounds stored in it, sounds in the card can be selected by adjusting the VALUE dial. (When playing the sound color which uses a drum sound from the card, make sure to put the correct card in the slot.)
- * Set all the instruments of the index which do not need to be assigned to "No Assign".
- * Key sets the key (C0 to G8) to which the sound is assigned. The name of the key is indicated when the octave is set to 8'.
- * Two or more sounds cannot be assigned to the same key.
- * Any sound assigned to a key will also occupy all unassigned keys beneath it, or up to the next assigned key.
- * It is possible to assign the same sound with the same pitch to several different keys.

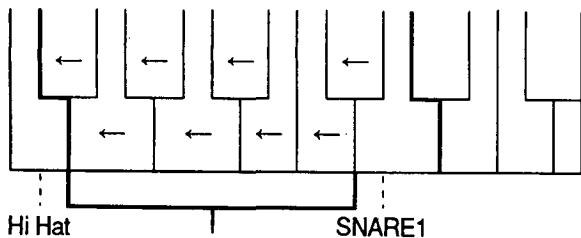

Snare 1 is assigned to all of these keys (the pitch changes accordingly).

- * Tune, Level and Decay are the parameters which set the volume, pitch and VDA decay time of each drum sound.
- * When changing the corresponding Program parameters, the parameters (volume, for instance) of the whole Drum Kit change.
- * Other Program parameters control the entire Drum Kit as well.
- * Tune sets the pitch of assigned key in the range of -120 to +120 (in 10-cent units, +/- 1 octave).
- * Level sets the relative value to the oscillator level in the PROGRAM Mode over a range of -50 to +50.
- * Decay sets the relative value to the VDA EG Decay setting in the PROGRAM Mode over a range of -50 to +50.
- * Pan determines the output destination from the selection of A, A:B (9:1 to 1:9), B, C, C + D and D.

F 4 - 2--4 DRUM KIT 2--4

- * Identical to F 4-1 DRUM KIT 1.

F 5 - 1 MIDI GLOBAL



B	Channel	1-16	Input/Output channel of internal play data
D	Clock Source	INT/EXT	Selection of transmission or reception of MIDI clock for sequencer
G	Overflow	OFF/ON	MIDI local mode switch

- * Channel sets the sending and receiving channel of MIDI.
- * When the type is set to Multi in the COMBINATION PLAY Mode or when in the SEQUENCER Mode, MIDI data other than that of channel set here may be handled.
- * When MIDI Overflow is set to ON, any incoming on/off note data (either through MIDI IN or the M1R's sequencer) which is beyond the 16-note simultaneous polyphonic capability of the M1R is output through MIDI'OUT for play on external synthesizers.
- * The simultaneous polyphonic output can be increased by connecting another M1R to the MIDI OUT terminal.
- * Make certain that the same Program/Combination is set on both M1Rs.
- * The default setting, or the setting when power is turned on, is overflow OFF.
- * Clock Source should be set to EXT when receiving the play tempo from external sequencers as MIDI clock data. (With this setting the internal tempo of M1R is not operative.) This is used to synchronize with external sequencers and rhythm machines.
- * Make sure to set this function to INT when other MIDI devices are not connected to MIDI IN.
- * The M1R will receive start, stop, continue, song select, and song position data from external MIDI devices only when this function is set to EXT.
- * The default setting, or the setting when power is turned on, is INT.

F 5 - 2 MIDI FILTERING

MIDI FILTERING				CMB/PROG Change'			
PROG:ENA	AFTT:DIS	CNTL:ENA	EXCL:DIS				
A	B	C	D	E	F	G	H

B	Combination/Program Change	DIS/ENA	When set to DIS, the selected MIDI data is not received or sent.
D	After Touch	DIS/ENA	
F	Control Change	DIS/ENA	
H	Exclusive	DIS/ENA	

- * This function prevents the particular MIDI data from being sent or received. (This is called filtering.)
- * Data is filtered when recording to the sequencer, but is not filtered during playback.
- * Combination (or Program) change messages are not sent or received when setting Combination/Program Change to DIS.
- * Control change messages are not sent or received when Control Change is set to DIS.
- * After touch messages are not sent or received when setting After Touch to DIS.
- * Parameter change messages by system exclusive are not sent or received when setting Exclusive to DIS.

NOTE: Parameter change by system exclusive is used to edit Programs with the use of a computer. When connecting 2 M1Rs or the M1R with an M1 and setting Exclusive to ENA, Program editing is done on both devices at the same time. Set it to DIS when connecting MIDI instruments other than the M1 or M1R.

F 6 - 1 PROGRAM MEMORY PROTECT

PROGRAM MEMORY PROTECT			
Internal:OFF	Card:ON		
A	B	C	D

B	Internal	OFF/ON	Internal memory protect (prevents writing to memory)
F	Card	OFF/ON	Memory protect of memory card (prevents writing to card)

- * This function prevents Programs and Program parameters from being written to internal memory or RAM card.
- * When Internal is set to ON, writing to internal memory cannot be executed.
- * When Card is set to ON, writing to RAM card cannot be executed.
- * Writing to RAM card is also prevented by the protect switch in the top part of the card.

F 6 - 2 COMBINATION MEMORY PROTECT

- * This function prevents Combinations and Combination parameters from being written to internal memory or RAM card.
- * Identical to F 6 - 1 Program Memory Protect.

F6-3 SEQ DATA MEMORY PROTECT

- * This function prevents sequencer data from being written to internal memory or RAM.
- * Identical to F6-1 Program memory Protect.

F.6 - 4 MEMORY ALLOCATION

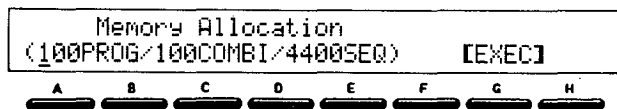

A	100 PROG/100 COMBI/4400 SEQ	Selection of large program allocation
	50 PROG/50 COMBI/7700 SEQ	Selection of large sequence allocation
G	[EXEC]	Executing Change

Changes the structure of the internal memory of the MIR. (See p.16 for more details.) Select the memory structure desired, then press [EXEC] (**G**).

Save all data to a blank, formatted card before switching the memory allocation setting, since much of your precious data could be irretrievably lost.

- * All sequence data will be lost if total sequence data is more than 4400 steps when switching to the 100 PROG/100COMBI/4400 SEQ (large program allocation) setting. (When there are songs you wish to keep, you can erase or initialize only the unnecessary songs before switching settings.)
- * [YES] (**G**) executes, [NO] (**H**) cancels.
- * Data written to numbers 0 - 49 are copied to Program numbers 50 - 99 and Combination numbers 50 - 99 after executing.

The data written to Program numbers 50-- 99 and Combination numbers 50 - 99 are lost when selecting the 50 PROG/50 COMBI/7700 SEQ (large sequence allocation) setting.

- * [YES] (**G**) executes, [NO] (**H**) cancels.

F 7 - 1 MIDI DATA DUMP



B	Program	Transmission of all Program parameters
	Combination	Transmission of all Combination parameters
	Global Data	Transmission of Global Mode data (F0-1 – F5-2)
	SEQ Data	Transmission of all the sequence data
	All Data	Transmission of all the Program/Combination/Sequence data/Global parameters
G	[DUMP]	Executing the Dump

- * Transmits (or dumps) all parameter/sequence data to another M1R or M1 connected through MIDI.
- * MIDI data dump can be sent and received when this page is selected regardless of the Exclusive parameter setting of F 5 -2, MIDI Filtering.
- * For receiving, no particular operations are necessary except for setting the memory protect to OFF.
- * Program sends all the Program parameters.
- * Combination sends all the Combination parameters.
- * SEQ data sends all the sequence data.
- * All Data sends all Program parameter, Combination parameter and sequence data at the same time.
- * Dump is executed by pressing the [DUMP] (**G**)
- * Program data and sequence data can be saved on external devices, providing that MIDI devices which can save system exclusive data (such as the KORG SQD - 8) are used.

Type of Data	Length of Exclusive Message
--------------	-----------------------------

(Large Program Allocation)	
Program (100)	Approximately 16 K
Combination (100)	Approximately 14 K
Global Data	Approximately 1 K
Sequence Data	2 K ~ 22 K
All Data	33 K ~ 53 K

(Large Sequence Allocation)	
Program (50)	Approximately 8 K
Combination (50)	Approximately 7 K
Global Data	Approximately 1 K
Sequence Data	2 K ~ 37 K
All Data	18 K ~ 53 K

- * Transmission and reception through the Dump function will not occur if the memory allocation of the M1R in reception differs from that of the device that is sending.
- * See the end of the manual for details on system exclusive data.

F 8 - 1 LOAD FROM CARD



B	PROG/COMBI	Loading of all Programs and Combinations (When PROG/COMBI Card, PROG/COMBI/SEQ Card are used)
	SEQUENCE	Loading all sequence data (songs, patterns) (When SEQ Card, PROG/COMBI/SEQ Card are used)
	PROG/COMBI/SEQ	Loading all Programs, Combinations and sequence data (When PROG/COMBI/SEQ Card are used)
G	[LOAD]	Executing the load

* This function loads (or writes in) the data in the ROM card or RAM card to internal memory.

NOTE: This function erases any and all data existing in internal memory. It is recommended that you save all internal memory data to a RAM card before loading.

- * The display prompts for confirmation after pressing [LOAD] (**G**). Press [YES] (**G**) to save and [NO] (**H**) to cancel.
- * When the format of the card differs from the structure of the internal memory, loading is executed as follows:
- * Programs and Combinations are loaded and assigned according to the memory capacity available.
- * No sequence data is loaded at all if the memory space of the receiving device is smaller than that of the sending device.
- * Programs C00 - C99 used in the Combination parameters are loaded and replace I00 - I99.

(See F 9 - 2 FORMAT CARD for information on formatting.)

(See p. 16 for more about cards and the structure of the internal memory.)

F 9 - 1 SAVE TO CARD



[B]	PROG/COMBI	Saving all Programs and Combinations (When PROG/COMBI Card, PROG/COMBI/SEQ Card are used)
	SEQUENCE	Saving all sequence data (songs, patterns) (When SEQ Card, PROG/COMBI/SEQ Card are used)
	PROG/COMBI/SEQ	Saving all Programs, Combinations and sequence data (When PROG/COMBI/SEQ Card are used)
[G]	[SAVE]	Executing the save

- * Saves (or writes) the data stored in the internal memory to RAM card.
- * When saving to a new, blank card, format the card first following the instructions of F 9-2, then save.
- * Save cannot be executed when the card memory protect is set to ON. (Cancelling the card memory protect is done in functions F 6 - 1 through F 6 - 3.)
- * Set the Protect Switch at the top of the card to OFF beforehand.

NOTE: This function erases any and all data existing in the card. It is recommended that you retain all important data and save new data to a blank RAM card.

- * The display prompts for confirmation after pressing [SAVE] ([G]). Press [YES] ([G]) to save and [NO] ([H]) to cancel.
- * Global parameters (F 0 - 1 through F 5 - 2) are saved together at the same time when selecting PROG/COMBI or PROG/COMBI/SEQ.
- * When the the format of the card differs from the structure of the internal memory, saving is executed as follows:
- * Programs and Combinations are saved and assigned according to the memory capacity available.
- * No sequence data is saved at all if the memory space of the receiving device is smaller than that of the sending device.

(See F 9-2 FORMAT CARD for information on formatting.)

(See p.16 for more about cards and the structure of the internal memory.)

9 - 2 FORMAT CARD

FORMAT CARD							
<50PROG/50COMBI/4200SEQ>						[FORMAT]	
A	B	C	D	E	F	G	H

[B]	100PROG/100COMBI	Selection of PROG/COMBI Card format
	7700STEP SEQUENCE	Selection of SEQ Card format
	50PROG/50COMBI/4200SEQ	Selection of PROG/COMBI/SEQ Card format
[G]	[FORMAT]	Executing the format

* Sets the format of the RAM card and formats the card.

(See p. 16 in the BASIC OPERATION chapter for more information on formatting RAM cards.)

* Use the KORG MEMORY CARD RAM (256 KBytes) MCR-03 for the RAM card.

* Newly purchased blank RAM cards must be formatted before they can be used for saving or writing.

NOTE: This function erases any and all data existing in the card. It is recommended that you retain all important data and format blank RAM cards only.

* The display prompts for confirmation after pressing [FORMAT] ([G]). Press [YES] ([G]) to format and [NO] ([H]) to cancel.

MIDI IMPLEMENTATION

1. TRANSMITTED DATA

1-1 CHANNEL MESSAGES

Status	Second	Third	Description	ENA
1000 nnnn	0kkk kkkk	0100 0000	Note Off	Q
1001 nnnn	0kkk kkkk	0vvv vvvv	Note On vvv vvvv=2~126	Q
1011 nnnn	0000 0110	0vvv vvvv	Data Entry (MSB) (E.Slider.A.Pedal) *1	E
1011 nnnn	0000 0111	0vvv vvvv	Volume (Assignable Pedal)	C
1011 nnnn	0010 0110	0vvv vvvv	Data Entry (LSB) (E.Slider.A.Pedal) *1	E
1011 nnnn	0110 0000	0000 0000	Data Increment (UP Switch) *1	E
1011 nnnn	0110 0001	0000 0000	Data Decrement (DOWN Switch) *1	E
1011 nnnn	0ccc cccc	0vvv vvvv	Control Data ccc cccc=00~101	Q
1100 nnnn	0ppp pppp	---- ----	Program Change (Program or Combi) *2	P
1101 nnnn	0vvv vvvv	---- ----	Channel Pressure	Q
1110 nnnn	0bbb bbbb	0bbb bbbb	Bender Change	Q

nnnn : MIDI Channel No. (0~15) Usually Global Channel. When using Sequencer, each track's channel.

ENA = C : Enable when Control is On

P : Enable when Program is On

E : Enable when Exclusive is On

Q : Enable when Overflow is On or Sequencer is Playing(T), Recording(R)

*1 : Prog. E. Prog. Combi. E. Combi Mode Only

*2 : When Memory Allocation = L. Prog ppp pppp=0~99

= L. Seq. ppp pppp=0~49

1-2 SYSTEM COMMON MESSAGES

Status	Second	Third	Description
1111 0010	0111 1111	0hhh hhhh	Song Position Pointer 111 1111 : Least significant hhh hhhh : Most significant
1111 0011	000s ssss	---- ----	Song Select s ssss : Song No. = 0~19 (10~19:Card)

Transmits when in Sequencer Mode (Internal Clock)

1-3 SYSTEM REALTIME MESSAGES

Status	Description	
1111 1000	Timing Clock	*3
1111 1010	Start	*3
1111 1011	Continue	*3
1111 1100	Stop	*3
1111 1110	Active Sensing	

*3 : Transmits when in Sequencer Mode (Internal Clock)

1-4 UNIVERSAL SYSTEM EXCLUSIVE MESSAGE (DEVICE INQUIRY)

Byte (Hex)	Description
1111 0000 (F0)	EXCLUSIVE STATUS
0111 1110 (7E)	NON REALTIME MESSAGE
0000 **** (0*)	MIDI GLOBAL CHANNEL (DEVICE ID)
0000 0110 (06)	INQUIRY MESSAGE
0000 0010 (02)	IDENTITY REPLY
0100 0010 (42)	KORG ID (MANUFACTURERS ID)
0001 1001 (19)	M1R ID (FAMILY CODE(LSB))
0000 0000 (00)	(- - (MSB))
0000 0001 (01)	(MEMBER CODE(LSB))
0000 0000 (00)	(- - (MSB))
0*** **** (**)	ROM No. 1~ (Minor Ver. (LSB))
0000 0000 (00)	(- - (MSB))
0*** **** (**)	SOFT VER. 1~ (Major Ver. (LSB))
0000 0000 (00)	(- - (MSB))
1111 0111 (F7)	END OF EXCLUSIVE

Transmits when INQUIRY MESSAGE REQUEST Received

1-5 SYSTEM EXCLUSIVE MESSAGES

M1/M1R SYSTEM EXCLUSIVE

1st Byte = 1111 0000 (F0) : Exclusive Status
 2nd Byte = 0100 0010 (42) : KORG ID
 3rd Byte = 0011 nnnn (3n) : Format ID n:Global ch.
 4th Byte = 0001 1001 (19) : M1/M1R ID
 5th Byte = 0fff ffff (ff) : Function Code
 6th Byte = 0ddd dddd (dd) : Data
 : : : :
 LastByte = 1111 0111 (F7) : End of Exclusive EOX

EX. Header

Function Code List

Func	Description	R	C	D	E
42	MODE DATA	○			
47	ALL DRUM SOUND(PCM CARD) NAME	○			
45	ALL MULTISOUND(PCM CARD) NAME	○			
4E	MODE CHANGE		○		
41	PARAMETER CHANGE		○		
40	PROGRAM PARAMETER DUMP	○	○		
4C	ALL PROGRAM PARAMETER DUMP	○		○	
49	COMBINATION PARAMETER DUMP	○	○		
4D	ALL COMBINATION PARAMETER DUMP	○		○	
48	ALL SEQUENCE DATA DUMP	○		○	
51	GLOBAL DATA DUMP	○		○	
50	ALL DATA(GLB. CMB. PRG. SEQ) DUMP	○		○	
26	RECEIVED MESSAGE FORMAT ERROR	○			
23	DATA LOAD COMPLETED				○
24	DATA LOAD ERROR				○
21	WRITE COMPLETED				○
22	WRITE ERROR				○

Transmit when

R : Request Message is received

C : Mode or No. is changed by SW

D : Data dump by SW

(Doesn't respond to

Exclusive On. Off)

E : EX. Message is received

2. RECOGNIZED RECEIVE DATA

2-1 CHANNEL MESSAGES

Status	Second	Third	Description	ENA
1000 nnnn	0kkk kkkk	0xxx xxxx	Note Off	A
1001 nnnn	0kkk kkkk	0000 0000	Note Off	A
1001 nnnn	0kkk kkkk	0vvv vvvv	Note On	A
		vvv vvvv=1-127		
1011 nnnn	0000 0001	0vvv vvvv	Pitch Modulation	C
1011 nnnn	0000 0010	0vvv vvvv	VDF Modulation	C
1011 nnnn	0000 0110	0vvv vvvv	Data Entry (MSB)	*1.3 E
1011 nnnn	0000 0111	0vvv vvvv	Volume	C
1011 nnnn	0010 0110	0vvv vvvv	Data Entry (LSB)	*1.3 E
1011 nnnn	0100 0000	00xx xxxx	Damper Off	C
1011 nnnn	0100 0000	01xx xxxx	Damper On	C
1011 nnnn	0110 0000	0000 0000	DATA Increment	*1.3 E
1011 nnnn	0110 0001	0000 0000	DATA Decrement	*1.3 E
1011 nnnn	0110 0100	0000 0001	RPC Parameter No. (LSB) (M. Tune)	*3 E
1011 nnnn	0110 0101	0000 0000	RPC Parameter No. (MSB) (M. Tune)	*3 E
1011 nnnn	0ccc cccc	0vvv vvvv	Control Data (For Seq. Recording)	Q
		ccc cccc=00~101		
1011 nnnn	0111 1011	0000 0000	All Notes Off	A
1011 nnnn	0111 110x	0000 0000	(All Notes Off)	A
1011 nnnn	0111 1110	000m mmmm	(All Notes Off)	A
		m mmmm=0~16		
1011 nnnn	0111 1111	0000 0000	(All Notes Off)	A
1100 nnnn	0ppp pppp	---- ----	Program Combination Change	*2.3 P
1101 nnnn	0vvv vvvv	---- ----	Channel Pressure (After Touch)	C
1110 nnnn	0bbb bbbb	0bbb bbbb	Bender Change	C

x : Random

ENA Same as TRANSMITTED DATA

*1 : Prog. E. Prog. Combi. E. Combi Mode Only

*2 : Memory Alloc. =L. ProgData beyond value of 99 are assigned a new value by subtracting 100.
ex. 100→00, 127→27

Memory Alloc. =L. Seg.Data beyond value of 49 are assigned a new value by subtracting 50,
until the value is less than 50. ex. 50→00, 127→27

*3 : After Processing (While Exclusive On),

Transmits Exclusive Message[DATA LOAD COMPLETED]or[DATA LOAD ERROR]

2-2 SYSTEM COMMON MESSAGES

Status	Second	Third	Description
1111 0010	0111 1111	0hhh hhhh	Song Position Pointer
			111 1111 : Least significant
			hhh hhhh : Most significant
1111 0011	000s ssss	---- ----	Song Select
			s ssss : Song No. = 0~19 (10~19:Card)

Receive when in Sequencer Mode (External Clock)

2-3 SYSTEM REALTIME MESSAGES

Status	Description	
1111 1000	Timing Clock	*4
1111 1010	Start	*4
1111 1011	Continue	*4
1111 1100	Stop	*4
1111 1110	Active Sensing	

*4 : Receive when in Sequencer Mode (External Clock)

2-4 UNIVERSAL SYSTEM EXCLUSIVE MESSAGE (DEVICE INQUIRY)

Byte	Description	
1111 0000 (F0)	EXCLUSIVE STATUS	
0111 1110 (7E)	NON REALTIME MESSAGE	
0*** **** (**)	MIDI CHANNEL (DEVICE ID)*5	
0000 0110 (06)	INQUIRY MESSAGE	
0000 0001 (01)	INQUIRY REQUEST	
1111 0111 (F7)	END OF EXCLUSIVE	

*5 = 0~F : Receive if Global Channel

= 7F : Receive any Channel

2-5 SYSTEM EXCLUSIVE MESSAGES

* Not received when Sequencer is playing, recording

Function Code List

Func	Description	G	C	P	S
12	MODE REQUEST	○	○	○	○
1F	ALL DRUM SOUND(PCM CARD) NAME DUMP REQUEST	○	○	○	○
16	ALL MULTISOUND(PCM CARD) NAME DUMP REQUEST	○	○	○	○
10	PROGRAM PARAMETER DUMP REQUEST			○	
1C	ALL PROGRAM PARAMETER DUMP REQUEST	◎	○	○	○
19	COMBINATION PARAMETER DUMP REQUEST		○		
1D	ALL COMBINATION PARAMETER DUMP REQUEST	◎	○	○	○
18	ALL SEQUENCE DATA DUMP REQUEST	◎	○	○	○
0E	GLOBAL DATA DUMP REQUEST	◎	○	○	○
0F	ALL DATA(GLOBAL, COMBI, PROG, SEQ.)DUMP REQUEST	◎	○	○	○
11	PROGRAM WRITE REQUEST			○	
1A	COMBINATION WRITE REQUEST			○	
40	PROGRAM PARAMETER DUMP			○	
4C	ALL PROGRAM PARAMETER DUMP	◎	○	○	○
49	COMBINATION PARAMETER DUMP		○		
4D	ALL COMBINATION PARAMETER DUMP	◎	○	○	○
48	ALL SEQUENCE DATA DUMP	◎	○	○	○
51	GLOBAL DATA DUMP	◎	○	○	○
50	ALL DATA(GLOBAL, COMBI, PROG, SEQ.) DUMP	◎	○	○	○
4E	MODE CHANGE	○	○	○	○
41	PARAMETER CHANGE		○	○	

Received when in

G : GLOBAL MODE

(◎:Does not respond to
Exclusive On, Off in
DATA DUMP Page)

C : COMBI. E. COMBI MODE

P : PROG. E. PROG MODE

S : SEQUENCER MODE

3. MIDI EXCLUSIVE FORMAT

R : Receive. T : Transmit

(1) MODE REQUEST R

Byte	Description
FO. 42. 3n. 19	EXCLUSIVE HEADER
0001 0010	MODE REQUEST 12H
1111 0111	EOX

Receives this message. and transmits Func=42 message.

(2) PROGRAM PARAMETER DUMP REQUEST R

Byte	Description
FO. 42. 3n. 19	EXCLUSIVE HEADER
0001 0000	PROGRAM PARAMETER DUMP REQUEST 10H
1111 0111	EOX

Receives this message. and transmits Func=40 message. or transmits Func=24 message.

(3) ALL DRUM SOUND(PCM Card) NAME DUMP REQUEST R

Byte	Description
FO. 42. 3n. 19	EXCLUSIVE HEADER
0001 1111	ALL DRUM SOUND(Card) NAME DUMP REQ. 1FH
1111 0111	EOX

Receives this message. and transmits Func=47 message. or transmits Func=24 message.

(4) ALL MULTISOUND(PCM Card) NAME DUMP REQUEST R

Byte	Description
FO. 42. 3n. 19	EXCLUSIVE HEADER
0001 0110	ALL MULTISOUND(Card) NAME DUMP REQ. 16H
1111 0111	EOX

Receives this message. and transmits Func=45 message. or transmits Func=24 message.

(5) ALL PROGRAM PARAMETER DUMP REQUEST R

Byte	Description
FO. 42. 3n. 19	EXCLUSIVE HEADER
0001 1100	ALL PROGRAM PARAMETER DUMP REQUEST 1CH
0000 000c	Bank (See NOTE 3-1)
1111 0111	EOX

Receives this message. and transmits Func=4C message. or transmits Func=24 message.

(6) COMBINATION PARAMETER DUMP REQUEST R

Byte	Description
FO. 42. 3n. 19	EXCLUSIVE HEADER
0001 1001	COMBINATION PARAMETER DUMP REQUEST 19H
1111 0111	EOX

Receives this message. and transmits Func=49 message. or transmits Func=24 message.

(7) ALL COMBINATION PARAMETER DUMP REQUEST R

Byte	Description
FO. 42. 3n. 19	EXCLUSIVE HEADER
0001 1101	ALL COMBI. PARAMETER DUMP REQUEST 1DH
0000 000c	Bank (See NOTE 3-1)
1111 0111	EOX

Receives this message. and transmits Func=4D message. or transmits Func=24 message.

(8) ALL SEQUENCE DATA DUMP REQUEST R

Byte	Description
FO. 42. 3n. 19	EXCLUSIVE HEADER
0001 1000	ALL SEQUENCE DATA DUMP REQUEST 18H
0000 000c	Bank (See NOTE 3-1)
1111 0111	EOX

Receives this message. and transmits Func=48 message. or transmits Func=24 message.

(9) GLOBAL DATA DUMP REQUEST R

Byte	Description
FO. 42. 3n. 19	EXCLUSIVE HEADER
0000 1110	GLOBAL DATA DUMP REQUEST 0EH
0000 000c	Bank (See NOTE 3-1)
1111 0111	EOX

Receives this message. and transmits Func=51 message. or transmits Func=24 message.

(10) ALL DATA(GLOBAL, COMBI, PROG, SEQ.) DUMP REQUEST R

Byte	Description
FO. 42. 3n. 19	EXCLUSIVE HEADER
0000 1111	ALL DATA(GLB, CMB, PRG, SEQ.) DUMP REQ. 0FH
0000 000c	Bank (See NOTE 3-1)
1111 0111	EOX

Receives this message. and transmits Func=50 message. or transmits Func=24 message.

(11) PROGRAM WRITE REQUEST R

Byte	Description
FO. 42. 3n. 19	EXCLUSIVE HEADER
0001 0001	PROGRAM WRITE REQUEST 11H
0000 000c	Bank (See NOTE 3-1)
0ppp pppp	Write Program No. (0-99 or 0-49)
1111 0111	EOX

Receives this message. and writes the data and transmits Func=21 message. or transmits Func=22 message.

(12) COMBINATION WRITE REQUEST R

Byte	Description
FO. 42. 3n. 19	EXCLUSIVE HEADER
0001 1010	COMBINATION WRITE REQUEST 1AH
0000 000c	Bank (See NOTE 3-1)
0ppp pppp	Write Combination No. (0-99 or 0-49)
1111 0111	EOX

Receives this message. and writes the data and transmits Func=21 message. or transmits Func=22 message.

(13) PROGRAM PARAMETER DUMP R, T

Byte	Description
FO. 42. 3n. 19	EXCLUSIVE HEADER
0100 0000	PROGRAM PARAMETER DUMP 40H
0ddd dddd	Data (See NOTE 6)
⋮	⋮
1111 0111	EOX

Receives this message & data. and transmits Func=23 message. or transmits Func=24 message.

Receives Func=10 message. and transmits this message & data.

When changing the program no. by SW, transmits this message & data.

(14) ALL PROGRAM PARAMETER DUMP R, T

Byte	Description
F0.42.3n.19	EXCLUSIVE HEADER
0100 1100	ALL PROGRAM PARAMETER DUMP 4CH
0000 00mc	Mem. Allocation, Bank (See NOTE3-1.3-2)
0ddd dddd	Data (See NOTE 7)
⋮	⋮
1111 0111	EOX

Receives this message & data, and transmits Func=23 message. or transmits Func=24 message.
Receives Func=1C message, and transmits this message & data.
Transmits this message & data by DATA DUMP.

(15) COMBINATION PARAMETER DUMP R, T

Byte	Description
F0.42.3n.19	EXCLUSIVE HEADER
0100 1001	COMBINATION PARAMETER DUMP 49H
0ddd dddd	Data (See NOTE 8)
⋮	⋮
1111 0111	EOX

Receives this message & data, and transmits Func=23 message. or transmits Func=24 message.
Receives Func=19 message, and transmits this message & data.
When changing the Combi no. by SW, transmits this message & data.

(16) ALL COMBINATION PARAMETER DUMP R, T

Byte	Description
F0.42.3n.19	EXCLUSIVE HEADER
0100 1101	ALL COMBINATION PARAMETER DUMP 4DH
0000 00mc	Mem. Allocation, Bank (See NOTE3-1.3-2)
0ddd dddd	Data (See NOTE 9)
⋮	⋮
1111 0111	EOX

Receives this message & data, and transmits Func=23 message. or transmits Func=24 message.
Receives Func=1D message, and transmits this message & data.
Transmits this message & data by DATA DUMP.

(17) ALL SEQUENCE DATA DUMP R, T

Byte	Description
F0.42.3n.19	EXCLUSIVE HEADER
0100 1000	ALL SEQUENCE DATA DUMP 48H
0000 000c	Bank (See NOTE 3-1)
0sss ssss	Seq. Data Size (See NOTE 10-1)
⋮	⋮
0ddd dddd	Control Data (See NOTE 10-2)
⋮	⋮
0ddd dddd	Sequence Data (See NOTE 10-3)
⋮	⋮
1111 0111	EOX

Receives this message & data, and transmits Func=23 message. or transmits Func=24 message.
Receives Func=18 message, and transmits this message & data.
Transmits this message & data by DATA DUMP.

(18) GLOBAL DATA DUMP R, T

Byte	Description
F0.42.3n.19	EXCLUSIVE HEADER
0101 0001	GLOBAL DATA DUMP 51H
0000 000c	Bank (See NOTE 3-1)
0ddd dddd	Data (See NOTE 11)
⋮	⋮
1111 0111	EOX

Receives this message & data, and transmits Func=23 message. or transmits Func=24 message.
Receives Func=0E message, and transmits this message & data. Transmits this message & data by DATA DUMP.

(19) ALL DATA(GLOBAL, COMBI, PROG, SEQ.) DUMP R, T

Byte	Description
F0.42.3n.19	EXCLUSIVE HEADER
0101 0000	ALL DATA(GLBL, COMBI, PROG, SEQ.) DUMP 50H
0000 00mc	Mem. Allocation, Bank (See NOTE3-1.3-2)
0sss ssss	Seq. Data Size (See NOTE 10-1)
⋮	⋮
0ddd dddd	Data (See NOTE 12)
⋮	⋮
1111 0111	EOX

Receives this message & data, and transmits Func=23 message. or transmits Func=24 message.
Receives Func=0F message, and transmits this message & data. Transmits this message & data by DATA DUMP.

(20) MODE CHANGE R, T

Byte	Description
F0.42.3n.19	EXCLUSIVE HEADER
0100 1110	MODE CHANGE 4EH
000b 0mmm	Mode Data (See NOTE 1,2)
000b 00mc	Mem. Alloc. Bank (See NOTE 2.3-2.3-1)
1111 0111	EOX

Receives this message & data, and changes the Mode, Bank and transmits Func=23 message. or transmits Func=24 message.

When changing the Mode by SW, transmits this message & data(b of Mode=0, b of Bank=1).
When changing the Mem. Alloc by SW, transmits this message & data (b of Bank & Mode=1).
When changing the Bank by SW, transmits this message & data(b of Mode=1, b of Bank=0).

(21) PARAMETER CHANGE R, T

Byte	Description
F0.42.3n.19	EXCLUSIVE HEADER
0100 0001	PARAMETER CHANGE 41H
0ppp pppp	Parameter Page (See TABLE 5.6)
0000 pppp	Parameter Position (See TABLE 5.6)
0vvv vvvv	Value (LSB bit6-0) (See NOTE 13)
0vvv vvvv	Value (MSB bit15-7) (See NOTE 13)
1111 0111	EOX

Receives this message & data, and transmits Func=23 message. or transmits Func=24 message.
When changing the parameter no. by SW, and transmits this message & data.

(22) ALL DRUM SOUND(PCM Card) NAME T

Byte	Description
F0.42.3n.19	EXCLUSIVE HEADER
0100 0111	ALL DRUM SOUND(PCM Card) NAME 47H
0sss ssss	Sound Number (See NOTE 14)
0ddd dddd	Data (See NOTE 14)
⋮	⋮
1111 0111	EOX

Receives Func=1F message, and transmits this message & data. or transmits Func=24 message.

(23) ALL MULTISOUND(PCM Card) NAME T

Byte	Description
F0.42.3n.19	EXCLUSIVE HEADER
0100 0101	ALL MULTISOUND(PCM Card) NAME 45H
Osss ssss	Multi Sound Number (See NOTE 15)
Oddd dddd	Data (See NOTE 15)
⋮	⋮
1111 0111	EOX

Receives Func=16 message, and transmits this message & data. or transmits Func=24 message.

(24) MODE DATA T

Byte	Description
F0.42.3n.19	EXCLUSIVE HEADER
0100 0010	MODE DATA 42H
0000 0mmm	Mode Data (See NOTE 1)
0000 000m	Memory Allocation (See NOTE 3-2)
0011 00mm	Card Variation (See NOTE 4)
0000 00cc	PCM Card Variation (See NOTE 5)
1111 0111	EOX

Receives Func=12 message, and transmits this message & data.

(25) MIDI IN DATA FORMAT ERROR T

Byte	Description
F0.42.3n.19	EXCLUSIVE HEADER
0010 0110	MIDI IN DATA FORMAT ERROR 26H
1111 0111	EOX

Transmits this message when there is an error in the MIDI IN message (ex.data length).

(26) DATA LOAD COMPLETED T

Byte	Description
F0.42.3n.19	EXCLUSIVE HEADER
0010 0011	DATA LOAD COMPLETED 23H
1111 0111	EOX

Transmits this message when DATA LOAD.PROCESSING have been completed.

(27) DATA LOAD ERROR T

Byte	Description
F0.42.3n.19	EXCLUSIVE HEADER
0010 0100	DATA LOAD ERROR 24H
1111 0111	EOX

Transmits this message when DATA LOAD.PROCESSING have not been completed(ex.protected).

(28) WRITE COMPLETED T

Byte	Description
F0.42.3n.19	EXCLUSIVE HEADER
0010 0001	WRITE COMPLETED 21H
1111 0111	EOX

Transmits this message when DATA WRITE BY MIDI has been completed.

(29) WRITE ERROR T

Byte	Description
F0.42.3n.19	EXCLUSIVE HEADER
0010 0010	WRITE ERROR 22H
1111 0111	EOX

Transmits this message when DATA WRITE BY MIDI Incompleted.

NOTE 1 : mmm = 0 : COMBINATION 3 : EDIT PROG.
 1 : EDIT COMBI. 4 : GLOBAL
 2 : PROGRAM 6 : SEQUENCER

NOTE 2 : b = 0 : Change the Mode.Bank
 = 1 : Don't change the Mode.Bank

NOTE 3-1 : c = 0 Internal
 = 1 Card

NOTE 3-2 : m = 0 100Combination & 100Program
 = 1 50 - & 50 -

NOTE 4 : 11.mm= 0.0 : Card Off

= 0.1 : NG Card (ROM)
 = 0.2 : - - (RAM)

11 = 1 : ROM Card mm = 0 : G1b.+100:100
 = 2 : RAM Card (Protect Off) = 1 : G1b.+ 50: 50+Seq.
 = 3 : - - (- On) = 2 : Sequencer

NOTE 5 : cc = 0 : Card Off

= 1 : NG Card
 = 2 : PCM Card In

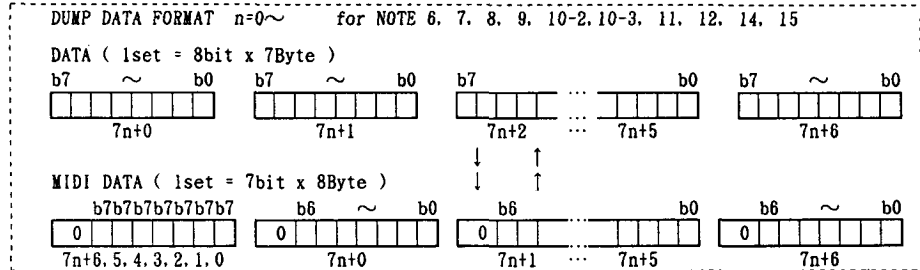

NOTE 6 : PROGRAM PARAMETER DUMP FORMAT

(See TABLE 1)

[Parameter No.00],.....,[Parameter No.142]

143Byte = 7x20+3 → 8x20+(1+3) = 164Byte

NOTE 7 : ALL PROGRAM PARAMETER DUMP FORMAT

[Prog. No.00 (143Byte)],.....,[Prog. No.99 or 49 (143Byte)]

Mem. Alloc = L. Prog : 14300Byte = 7x2042+6 → 8x2042+(1+6) = 16343Byte (5.2Sec)

= L. Seq. : 7150Byte = 7x1021+3 → 8x1021+(1+3) = 8172Byte (2.6Sec)

NOTE 8 : COMBINATION PARAMETER DUMP FORMAT

(See TABLE 2)

[Parameter No.00],.....,[Parameter No.123]

124Byte = 7x17+5 → 8x17+(1+5) = 142Byte

NOTE 9 : ALL COMBINATION PARAMETER DUMP FORMAT

[Combi. No.00 (124Byte)],.....,[Combi. No.99 or 49 (124Byte)]

Mem. Alloc = L. Prog : 12400Byte = 7x1771+3 → 8x1771+(1+3) = 14172Byte (4.5Sec)

= L. Seq. : 6200Byte = 7x 885+5 → 8x 885+(1+5) = 7086Byte (2.3Sec)

NOTE 10 : ALL SEQUENCE DATA DUMP FORMAT

(See TABLE 4)

10-1 : Sequence Data Size 2Byte

[Data Size (bit6-0)],
[Data Size (bit12-7)]

10-2 : Control Data Dump Format (1522Byte)

[Control Data (Song Size(96) x 10 = 960Byte)],
[Pattern Data (200Byte)],
[Song0-Track1 Address(2Byte)],.....,[Song0-Track8 Addr],
[Song1-Track1 Addr],.....,[Song9-Track8 Addr](160Byte),
[Pattern0 Addr(2Byte)],.....,[Pattern99 Addr](200Byte),
[Pattern End Addr (2Byte)]

10-3 : Sequence Data Dump Format

[Sequence 1st Data(4Byte)],.....,[Seq. nth Data],
n : Seq. Data Size = 0 ~ 4400 (Mem. Alloc = L. Prog)
= 0 ~ 7700 (Mem. Alloc = L. Seq. Seq. Card)
= 0 ~ 4200 (Prog. Combi. Seq. Card)

1522Byte+4x[Seq. Data Size]Byte = 7xA+B → 8xA+(1+B)Byte
∴ 10-1, 10-2, 10-3 = 2+8xA+(1+B)Byte

NOTE 11 : GLOBAL DATA DUMP FORMAT

(See TABLE 3)

[Global Data (19*2Byte)],
[Drum Kit Data (7x120Byte)]

21+840Byte = 7x123+0 → 8x123 = 984Byte

NOTE 12 : ALL DATA (GLOBAL, COMBI, PROG, SEQ) DUMP FORMAT

[Global Data] (See NOTE 11),
[All Combination Parameter Data] (See NOTE 9),
[All Program Parameter Data] (See NOTE 7),
[All Sequence Data] (See NOTE 10-2, 10-3)

Mem. Alloc = L. Prog : 861+12400+14300+1522+4x[Seq. Data Size]Byte = 7xC+D
→ 8xC+(1+D)Byte (10.7~17.1Sec)
= L. Seq. : 861+ 6200+ 7150+1522+4x[Seq. Data Size]Byte = 7xE+F
→ 8xE+(1+F)Byte (5.8~17.0Sec)
Prog. Comb. Seq. Card : 861+ 6200+ 7150+1522+4x[Seq. Data Size]Byte = 7xG+H
→ 8xG+(1+H)Byte (5.8~11.9Sec)

NOTE 13 : VALUE DATA FORMAT

Bit15-13 of Value Data is Sign Flag, and they have same value

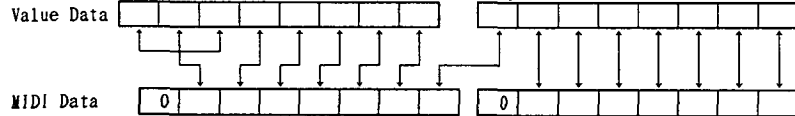

NOTE 14 : ALL DRUM SOUND(PCM Card) NAME DATA FORMAT

[Drum Sound 1 Name (10Byte)],.....,[Drum Sound n Name (10Byte)]
n : Drum Sound Number

NOTE 15 : ALL MULTISOUND(PCM Card) NAME DATA FORMAT

[Multisound 1 Name (10Byte)],.....,[Multisound n Name (10Byte)]
n : Multisound Number

PROGRAM PARAMETER (TABLE 1)

No.	PARAMETER	DATA(Hex) : VALUE
00	PROGRAM NAME (Head)	20~7F : ' ' ~ ' '
09	PROGRAM NAME (Tail)	
OSCILATOR		
10	OSCILATOR MODE	0, 1, 2 *2
11	ASSIGN	bit0=0:POL. =1:MON
	HOLD	bit1=0:OFF. =1:ON
12	OSC-1 MULTISOUND	00~63: Int. 64~:Card
13	OSC-1 OCTAVE	FF~01 : 16'~4'
14	OSC-2 MULTISOUND	00~63: Int. 64~:Card
15	OSC-2 OCTAVE	FF~01 : 16'~4'
16	INTERVAL	F4~0C : -12~12
17	DETUNE	CE~32 : -50~50
18	DELAY START	00~63
PITCH MG		
19	WAVE FORM	bit1,0=0,1,2,3 *3
	OSC-1 MG ENABLE	bit5=0:OFF. =1:ON
	OSC-2 MG ENABLE	bit6=0:OFF. =1:ON
	KEY SYNC	bit7=0:OFF. =1:ON
20	FREQUENCY	00~63
21	DELAY	00~63
22	INTENSITY	00~63
CUTOFF MG		
23	WAVE FORM	bit1,0=0,1,2,3 *3
	OSC-1 MG ENABLE	bit5=0:OFF. =1:ON
	OSC-2 MG ENABLE	bit6=0:OFF. =1:ON
	KEY SYNC	bit7=0:OFF. =1:ON
24	FREQUENCY	00~63
25	DELAY	00~63
26	INTENSITY	00~63
AFTER TOUCH		
27	PITCH	F4~0C : -12~12
28	PITCH MG	00~63
29	VDF CUTOFF	9D~63 : -99~99
30	VDF MG	00~63
31	VDA AMPLITUDE	9D~63 : -99~99
CONTROLLER		
32	PITCH BEND	F4~0C : -12~12
33	VDF SWEEP INT.	9D~63 : -99~99
34	PITCH MG INT.	00~63
35	PITCH MG FREQUENCY	00~03
36	VDF MG INT.	00~63
37	VDF MG FREQUENCY	00~03
EFFECT PARAMETER		
38		
...		
62		*11

*1 : bit0 : ATTACK TIME SW =0:OFF. =1:ON
bit1 : DECAY TIME
bit2 : SLOPE TIME
bit3 : RELEASE TIME
bit4 : ATTACK TIME POLARITY =0:+, =1:-
bit5 : DECAY TIME
bit6 : SLOPE TIME
bit7 : RELEASE TIME

OSC-1 PITCH EG		
63	START LEVEL	9D~63 : -99~99
64	ATTACK TIME	00~63
65	ATTACK LEVEL	9D~63 : -99~99
66	DECAY TIME	00~63
67	RELEASE TIME	00~63
68	RELEASE LEVEL	9D~63 : -99~99
69	TIME VELOCITY SENSE	9D~63 : -99~99
70	LEVEL VELOCITY SENSE	9D~63 : -99~99
VDF-1		
71	CUTOFF VALUE	00~63
72	KBD TRACK CENTER	00~7F : C-1~G9
73	CUTOFF KBD TRACK	9D~63 : -99~99
74	EG INTENSITY	00~63
75	EG TIME KBD TRACK	00~63
76	EG TIME VEL. SENSE	00~63
77	EG INT. VEL. SENSE	9D~63 : -99~99
VDF-1 EG		
78	ATTACK TIME	00~63
79	ATTACK LEVEL	9D~63 : -99~99
80	DECAY TIME	00~63
81	BREAK POINT	9D~63 : -99~99
82	SLOPE TIME	00~63
83	SUSTAIN LEVEL	9D~63 : -99~99
84	RELEASE TIME	00~63
85	RELEASE LEVEL	9D~63 : -99~99
VDA-1		
86	OSCILATOR LEVEL	00~63
87	KBD TRACK CENTER	00~7F : C-1~G9
88	AMP. KBD TRACK INT.	9D~63 : -99~99
89	AMP. VELOCITY SENSE	9D~63 : -99~99
90	EG TIME KBD TRACK	00~63
91	EG TIME VEL. SENSE	00~63
VDA-1 EG		
92	ATTACK TIME	00~63
93	ATTACK LEVEL	00~63
94	DECAY TIME	00~63
95	BREAK POINT	00~63
96	SLOPE TIME	00~63
97	SUSTAIN LEVEL	00~63
98	RELEASE TIME	00~63
OSC-1 EG TIME KBD TRACK, VEL. SW & POLARITY		
99	F. EG TIME K.T SW&POL	bit7~0 *1
100	F. EG TIME VEL. SW&POL	bit7~0 *1
101	A. EG TIME K.T SW&POL	bit7~0 *1
102	A. EG TIME VEL. SW&POL	bit7~0 *1
OSC-2 PARAMETER		
103	SAME AS OSC-1(63~102)	
...		
142		

*2 : 0 : SINGLE
1 : DOUBLE
2 : DRUM

*3 : 0 : TRIANGLE (▲)
1 : UP SAW (▲)
2 : DOWN SAW (▼)
3 : RECTANGLE (▭)

COMBINATION PARAMETER
(TABLE 2)

No.	PARAMETER	DATA(Hex) : VALUE
COMBINATION CONTROLLER		
00	COMBI. NAME (Head)	20~7F : ' ~ ' ~ ' ~ ' ~
09	COMBI. NAME (Tail)	
10	COMBINATION TYPE	00~04 *4
EFFECT PARAMETER		
11		*11
35		
TIMBRE 1 PARAMETER		
36	PROGRAM NO.	00~C7 : *12
37	OUTPUT LEVEL	00~63
38	KEY TRANSPOSE	F4~0C : -12~12
39	DETUNE	CE~32 : -50~50
40	TIMBRE. INST PAN	bit7=0:TIM, =1:INS bit3~0 : 0~0D *5
41	KEY WINDOW TOP	00~7F : C-1~G9
42	KEY WINDOW BOTTOM	00~7F : C-1~G9
43	VEL. WINDOW TOP	01~7F
44	VEL. WINDOW BOTTOM	01~7F
45	CONTROL FILTER	bit3~0 *6
46	TIMBRE ON/OFF MIDI CHANNEL	bit4=0:ON, =1:OFF bit3~0 : 1~16
TIMBRE 2~8 PARAMETER		
47	SAME AS TIMBRE 1(36~46) x 7	
123		

A B
*4 : 0 : SINGLE *5 : 00 : 10:00
1 : LAYER
2 : SPLIT 0A : 00:10
3 : VEL. SW 0B : C
4 : MULTI 0C : C+D
0D : D

*6 : bit0 : PROGRAM CHANGE =0:DIS, =1:ENA
bit1 : DAMPER
bit2 : AFTER TOUCH
bit3 : CONTROL CHANGE

*7 : 0 : PROGRAM(COMBINATION) UP
1 : - DOWN
2 : SEQUENCER START/STOP
3 : EFFECT 1 ON/OFF
4 : - 2 -
5 : VOLUME
6 : VDF CUTOFF
7 : EFFECT 1 CONTROL
8 : - 2 -
9 : DATA ENTRY

GLOBAL PARAMETER
(TABLE 3)

No.	PARAMETER	DATA(Hex) : VALUE
GLOBAL PARAMETER		
00	MASTER TUNE	CE~32 : -50~50
01	KEY TRANSPOSE	F4~0C : -12~12
02	(NUL)	00
03	ASSIGNABLE PEDAL 1	00~09 *7
04	ASSIGNABLE PEDAL 2	00~09 *7
05	SCALE TYPE	00~04 *8
06	PURE TYPE KEY	00~0B : C~B
07	USER SCALE	CE~32 : -50~50
18		
19	(NUL)	00
20	(NUL)	00
DRUM KIT1-INDEX#0		
21	INST. NO.	00:OFF, 01~2C:INT, 2D~:CARD
22	KEY	0C~73 : C0~G8
23	PAN	00~0D *5
24	TUNE	88~78:-120~120
25	LEVEL	CE~32 : -50~50
26	DECAY	CE~32 : -50~50
27	(NUL)	00
DRUM KIT1-INDEX#2 ~ DRUM KIT4-INDEX#29		
28	SAME AS DRUM KIT1-1(21~27) x(30x4-1)	
860		

*8 : 0 : EQUAL TEMP 1
1 : EQUAL TEMP 2
2 : PURE MAJOR
3 : PURE MINOR
4 : USER PROGRAM

*12 : If COMBINATION TYPE is MULTI,
Parameter Change Format is as follows:
00H = TIMBER OFF
01H = 100

64H = I99
65H = C00
C8H = C99
In any other case:
00H = 100
63H = I99
64H = C00
C7H = C99

SEQUENCER CONTROL DATA

No.	PARAMETER	DATA(Hex) : VALUE
SONG 0 CONTROL DATA		
00	MIDI Channel (Tr. 1)	00~0F : 1~16
07	MIDI Channel (Tr. 8)	
08	STATUS (Tr. 1)	00~03 *9
15	STATUS (Tr. 8)	
16	BEAT	02~06 : 2 ~ 6
17	TEMPO	28~D0 : 40~208
18	PROTECT (Tr. 1)	bit0=0:ENA, =1:DIS
	PROTECT (Tr. 8)	bit7
19	NEXT SONG NO.	00~14:11~C10, OFF
20	SONG NAME (Head)	20~7F : ' ~ ' ~ ' ~ ' ~
29	SONG NAME (Tail)	
30	(NUL)	
31	EFFECT PARAMETER	*11
55		
TRACK 1 CONTROL DATA		
56	PROGRAM NO.	00~C7 : 100~C99
57	OUTPUT LEVEL	00~63
58	KEY TRANSPOSE	F4~0C : -12~12
59	DETUNE	CE~32 : -50~50
60	PAN	00~0D *5
TRACK 2~8 CONTROL DATA		
61	SAME AS TRACK 1(56~60) x 7	
95		
SONG 1~9 CONTROL DATA		
96	SAME AS SONG 0(00~95) x 9	
959		
PATTERN 0 CONTROL DATA		
960	BEAT	02~06 : 2 ~ 6
961	LENGTH	01~08 : 1 ~ 8
PATTERN 1~99 CONTROL DATA		
962	SAME AS PATTERN 0(960, 961) x 99	
1159		
SONGO-TRACK1 DATA ADDRESS		
1160	DATA ADDRESS(LSB)	
1161	(MSB)	0000 (Start Addr)
SONGO-TRACK2 ~ SONG9-TRACK8 DATA ADDRESS		
1162	SAME AS SONGO-TRACK1 ADDRESS(1160, 1161)	
1319	x (8x10-1)	
PATTERN 0 DATA ADDRESS		
1320	DATA ADDRESS (LSB)	
1321	(MSB)	
PATTERN 1 ~ PATTERN 99 DATA ADDRESS		
1322	SAME AS PATTERN 0(1320, 1321)	
1519		

(TABLE 4)

1520	End Pattern Addr(L)	
1521	(H)	

SEQUENCE DATA

No.	PARAMETER	DATA(Hex) : VALUE
SEQUENCE DATA 1		
1522	DATA (1-L)	*10
1523	DATA (1-H)	*10
1524	DATA (2-L)	*10
1525	DATA (2-H)	*10
SEQUENCE DATA 2 ~		
1526	SAME AS SEQUENCE DATA 1(1522~1525)	

*9 : 0 : Off
1 : Internal
2 : Extern
3 : Both

*10 : SEQUENCE DATA FORMAT
DATA(1-H) DATA(1-L) DATA(2-H) DATA(2-L)
↓ ↓ ↓ ↓

*10-1 NOTE ON/OFF
lvvv vvv t tttt tttt kkkk kkk l 1111 1111

Velocity Event Time Key No. Length
t =30 : J. t =IFE : Tie from Last Bar
l =30 : J. l =IFE : Tie to Next Bar

*10-2 PITCH BEND
0001 000 t tttt tttt 0 vvv vvvv 0 vvv vvvv
Event Time Value(H) Value(L)

*10-3 AFTER TOUCH
0010 000 t tttt tttt 0000 0000 0 vvv vvvv
Event Time Value

*10-4 PROGRAM CHANGE
0011 000 t tttt tttt 0000 0000 pppp pppp
Event Time Program No.

Mem. Alloc=0 : p=00~199(100~C99)
=1 : p=00~49, 100~149 (100~C49)

*10-5 CONTROL CHANGE
0100 000 t tttt tttt 0 vvv vvvv 0 ccc cccc
Event Time Value Control No.

c=00~ 65 : Same as MIDI Control Change
= 66 : Assignable Pedal
= 67 : Effect 1 ON/OFF
= 68 : - 2 -
= 69 : Effect 1 Balance
= 6A : Effect 2 Balance
= 6B : Tempo

*10-6 BAR
0110 0000 bbbb bbbb xx 00 0000 0 ppp pppp
Bar No. Bar Type Pattern No.

xx=00 : Don't use Pattern
=10 : Pattern continual
=11 : Pattern Start

*10-7 TRACK END
0111 000 t tttt tttt 0000 0000 0000 0000
Event Time

*11 EFFECT PARAMETER

No.	PARAMETER	DATA(Hex) : VALUE
(00)	Effect 1 Pattern No.	0~20, 21:1~33, Tru
(01)	- 2 -	0~20, 21:1~33, Tru
(02)	- 1 L-Ch E. Balnc	00~64 : 00~100
(03)	- 1 R-Ch -	00~64 : 00~100
(04)	- 2 L-Ch -	00~64 : 00~100
(05)	- 2 R-Ch -	00~64 : 00~100
(06)	Output 3 Pan	00.01~65 *11-1
(07)	- 4 -	00.01~65 *11-1
(08)	Effect I/O	bit4~0 *11-2
(09)	Effect 1 Parameter	*11-3
(16)		
(17)	Effect 2 Parameter	*11-3
(24)		

*11-1 : 00 : Off *11-2 :

01 : R bit0=0:Efct1 L-Ch Off.=1:On
 02 : 01:99 bit1=0: - 1 R-Ch Off.=1:On
 ... bit2=0: - 2 L-Ch Off.=1:On
 64 : 99:01 bit3=0: - 2 R-Ch Off.=1:On
 65 : L bit4=0:Efct2 Para.=1:Serial

*11-3 : Effect Parameter (8Byte) 33 Type

offset	PARAMETER	DATA(Hex) : VALUE
1~3 :	Hall, (4.5 : Room, 6 : Live Stage)	
(00)	Reverb Time	00~61(2F):0.2~9.9(4.9)
(01)	(NUL)	00
(02)	High Damp	00~63 : 00~99
(03)	Pre Delay	00~C8 : 00~200
(04)	E/R Level	00~63 : 00~99
(05)	(NUL)	00
(06)	EQ High	F4~0C : -12~12
(07)	EQ Low	F4~0C : -12~12

Don't display NUL from here, and that must be 00
7~9 : Early Reflection 1.2.3

(00)	E/R Time	00~46 : 100~800
(01)	Pre Delay	00~C8 : 00~200
(06)	EQ High	F4~0C : -12~12
(07)	EQ Low	F4~0C : -12~12

10 : Stereo Delay, 11 : Cross Delay

(00)	Delay Time L (L)	00~1F4 : 00~500
(01)	- - - (H)	
(02)	Feed Back	9D~63 : -99~99
(03)	High Damp	00~63 : 00~99
(04)	Delay Time R (L)	00~1F4 : 00~500
(05)	- - - (H)	
(06)	EQ High	F4~0C : -12~12
(07)	EQ Low	F4~0C : -12~12

12, 13 : Stereo Chorus 1.2. (14, 15 : Flanger)

(00)	Depth	00~63 : 00~99
(01)	Speed	00~D8 *11-3-2
(02)	MG Status *11-3-3	bit0=0:Sin. =1:Tri bit1 ← 1 bit2 ← 0 (1)
(03)	(Feed Back)	(9D~63 : -99~99)
(04)	Delay Time	0~C8(32):0~200(50)
(06)	EQ High	F4~0C : -12~12
(07)	EQ Low	F4~0C : -12~12
16 :	Phase Shifter 1. (17 : Phase Shifter 2)	
(00)	Depth	00~63 : 00~99
(01)	Speed	00~D8 *11-3-2
(02)	MG Status *11-3-3	bit0=0:Sin. =1:Tri bit1 ← 0. (1) bit2 ← 0
(03)	Feedback	9D~63 : -99~99
(04)	Manual	00~63 : 00~99

18 : Stereo Tremolo 1. (19 : Stereo Tremolo 2)

(00)	Depth	00~63 : 00~99
(01)	Speed	00~D8 : *11-3-2
(02)	MG Status *11-3-3	bit0=0:Sin. =1:Tri bit1 ← 0. (1) bit2 ← 0
(03)	Shape	9D~63 : -99~99
(06)	EQ High	F4~0C : -12~12
(07)	EQ Low	F4~0C : -12~12

20 : 3 Band EQ

(00)	Mid fc	0. 1. 2 : 0.5k.1k.2k
(01)	Mid Gain	F4~0C : -12~12
(04)	Low fc	0. 1. 2:0.25k.0.5k.1k
(05)	High fc	0. 1. 2 : 1k.2k.4k
(06)	High Gain	F4~0C : -12~12
(07)	Low Gain	F4~0C : -12~12

21 : Over Drive

(00)	EQ Mid fc	0. 1. 2 : 0.5k.1k.2k
(01)	EQ Mid Gain	F4~0C : -12~12
(02)	Drive	00~63 : 00~99
(03)	Level	00~63 : 00~99
(06)	EQ High	F4~0C : -12~12
(07)	EQ Low	F4~0C : -12~12

22 : Distortion

(02)	Distortion	00~63 : 00~99
(03)	Level	00~63 : 00~99
(07)	EQ Low Gain	F4~0C : -12~12

23 : Exciter

(00)	Blend	9D~63 : -99~99
(01)	Emphatic Point	00~09 : 01~10
(06)	EQ High	F4~0C : -12~12
(07)	EQ Low	F4~0C : -12~12

24 : Symphonic Ensemble

(00)	Depth	00~63 : 00~99
(06)	EQ High	F4~0C : -12~12
(07)	EQ Low	F4~0C : -12~12
25 :	Rotary Speaker	
(00)	Depth	00~63 : 00~99
(02)	Speed Rate	F6~0A : -10~10

26 : Delay / Hall

(00)	Delay Time (L)	00~1F4 : 00~500
(01)	Delay Time (H)	
(02)	Feed Back	9D~63 : -99~99
(03)	High Damp	00~63 : 00~99
(04)	Reverb Time	00~61 : 0.2~9.9
(06)	High Damp	00~63 : 00~99
(07)	Pre Delay	00~96 : 00~150

27 : Delay / Room

(00)	Delay Parameter	*11-3-1
(03)		
(04)	Reverb Time	00~2F : 0.2~4.9
(06)	High Damp	00~63 : 00~99
(07)	Pre Delay	00~96 : 00~150

28 : Delay / Early Reflection

(00)	Delay Parameter	*11-3-1
(03)		
(04)	E/R Time	00~1E : 100~400
(05)	Pre Delay	00~96 : 00~150

29 : Delay / Delay

(00)	Delay Time L (L)	00~1F4 : 00~500
(01)	- - - (H)	
(02)	Feed Back L	9D~63 : -99~99
(03)	High Damp L	00~63 : 00~99
(04)	Delay Time R (L)	00~1F4 : 00~500
(05)	- - - (H)	
(06)	Feed Back R	9D~63 : -99~99
(07)	High Damp R	00~63 : 00~99

30 : Delay / Chorus. (31 : Delay / Flanger)

(00)	Delay Parameter	*11-3-1
(03)		
(04)	Depth	00~63 : 00~99
(05)	Speed	00~D8 *11-3-2
(06)	MG Status *11-3-3	bit0=0:S. =1:T (←0) bit1 ← 0 bit2 ← 0. (←1)
(07)	Feed Back	0. (9D~63: -99~99)

32 : Delay / Phaser

(00)	Delay Parameter	*11-3-1
(03)		
(04)	Depth	00~63 : 00~99
(05)	Speed	00~D8 *11-3-2
(06)	Feedback	9D~63 : -99~99

33 : Delay / Tremolo

(00)	Delay Parameter	*11-3-1
(03)		
(04)	Depth	00~63 : 00~99
(05)	Speed	00~D8 *11-3-2
(07)	Shape	9D~63 : -99~99

*11-3-1 : Delay Parameter

Same as 26-(00)~(03)

*11-3-2 : Data(Hex) Value[Hz]

00~63 0.03~3.00 (0.03step)
 64~C7 3.1~13.0 (0.1 step)
 C8~D8 14~30.0 (1 step)

*11-3-3 : MG Status

bit0 : Wave Form =0:Sin. =1:Tri
 bit1 : Phase =0:0° , =1:180°
 bit2 : Wave Shape =0: Normal
 =1: for Flanger

PROGRAM PARAMETER PAGE, POSITION → OFFSET TABLE
(TABLE 5)

PAGE		PARAMETER	POSITION							
SGL	DBL		A	B	C	D	E	F	G	H
PROGRAM MODE										
(0)	(0)	(PERFORMANCE EDIT)	*12	*12	*12	*12	*12	*12	*12	*12
EDIT PROGRAM MODE										
(0)	(0)	0-1 OSC BASIC	10		11		11			
(1)	(1)	2 OSC 1 (MULTISOUND)	12			86	13			
	(2)	3 OSC 2 (MULTISOUND)	14			126	15	16	17	18
(2)	(3)	1-1 OSC 1 PITCH EG	63	64	65	66	67	68	70	69
	(4)	2 OSC 2 PITCH EG	103	104	105	106	107	108	110	109
(3)	(5)	2-1 VDF 1 (CUTOFF/EG INT)		71			74			
(4)	(6)	2 VDF 1 EG	78	79	80	81	82	83	84	85
(5)	(7)	3 VDF 1 VELOCITY SENSE	77		76		100	100	100	100
(6)	(8)	4 VDF 1 KBD TRACK	72	73	75		99	99	99	99
	(9)	3-1 VDF 2 (CUTOFF/EG INT)		111			114			
	(10)	2 VDF 2 EG	118	119	120	121	122	123	124	125
	(11)	3 VDF 2 VELOCITY SENSE	117		116		140	140	140	140
	(12)	4 VDF 2 KBD TRACK	112	113	115		139	139	139	139
(7)	(13)	4-1 VDA 1 EG	92	93	94	95	96	97	98	
(8)	(14)	2 VDA 1 VELOCITY SENSE		89	91		102	102	102	102
(9)	(15)	3 VDA 1 KBD TRACK	87	88	90		101	101	101	101
	(16)	5-1 VDA 2 EG	132	133	134	135	136	137	138	
	(17)	2 VDA 2 VELOCITY SENSE		129	131		142	142	142	142
	(18)	3 VDA 2 KBD TRACK	127	128	130		141	141	141	141
(10)	(19)	6-1 PITCH MG	19		20	21	22	19	19	
(11)	(20)	2 VDF MG	23		24	25	26	23	23	
(12)	(21)	7-1 AFTER TOUCH	27	28		29	30		31	
(13)	(22)	2 CONTROLLER	32	33		34	35		36	37
(14)	(23)	8-1 EFFECT 1 (TYPE)	38					46		
(15)	(24)	2 EFFECT 1 PARAMETER	*13	*13	*13	*13	*13	*13	*13	*13
(16)	(25)	3 EFFECT 2 (TYPE)	39					46		
(17)	(26)	4 EFFECT 2 PARAMETER	*13	*13	*13	*13	*13	*13	*13	*13
(18)	(27)	5 EFFECT PLACEMENT	46				44		45	

*12 See P. 18

*13 See P. 40

COMBINATION PARAMETER PAGE, POSITION → OFFSET TABLE
(TABLE 6)

PAGE						PARAMETER	POSITION							
SGL	LYR	SP	VS	MULT			A	B	C	D	E	F	G	H
COMBINATION MODE														
							(8)	(9)	(10)	(11)	(12)	(13)	(14)	(15)
(1)						PROG. /LEVEL	36			37				
	(1)	(1)	(1)		1	PROG. /LEVEL	36			37	47			48
				(1)	1	PROGRAM	36	47	58	69	80	91	102	113
				(2)	2	LEVEL	37	48	59	70	81	92	103	114
EDIT COMBINATION MODE														
							(8)	(9)	(10)	(11)	(12)	(13)	(14)	(15)
(0)	(0)	(0)	(0)	(0)	0-1	COMBI. TYPE			10					
(1)					1-1	PROG. /PAN	36			37		40		
	(1)				1-1	PROG. /LEVEL	36			37	47			48
	(2)				2	PAN/DAMPER	40	45			51	56	49	50
		(1)			1-1	PRG. /SPLIT	36			*14		47		
		(2)			2	LVL/PAN/DAMP	37	40	45		48	51	56	
			(1)		1-1	PRG. /VELOCITY	36			*15		47		
			(2)		2	LVL/PAN/DAMP	37	40	45		48	51	56	
				(1)	1-1	PROG. SELECT	36	47	58	69	80	91	102	113
				(2)	2-1	MIDI CHANNEL	46	57	68	79	90	101	112	123
				(3)	3-1	K. WINDOW TOP	41	52	63	74	85	96	107	118
				(4)	2	K. WINDOW BTM	42	53	64	75	86	97	108	119
				(5)	3	V. WINDOW TOP	43	54	65	76	87	98	109	120
				(6)	4	V. WINDOW BTM	44	55	66	77	88	99	110	121
				(7)	4-1	OUTPUT LEVEL	37	48	59	70	81	92	103	114
				(8)	5-1	TRANSPOSE	38	49	60	71	82	93	104	115
				(9)	2	DETUNE	39	50	61	72	83	94	105	116
				(10)	6-1	PANPOT	40	51	62	73	84	95	106	117
				(11)	7-1	MIDI PRG CHG	45	56	67	78	89	100	111	122
				(12)	2	DAMPER	45	56	67	78	89	100	111	122
				(13)	3	AFTER TOUCH	45	56	67	78	89	100	111	122
				(14)	4	CONTROL CHNG	45	56	67	78	89	100	111	122
(2)	(3)	(3)	(3)	(15)	8-1	EFFECT1 TYPE	11					19		
(3)	(4)	(4)	(4)	(16)	2	EFFECT1 PARA	*13	*13	*13	*13	*13	*13	*13	*13
(4)	(5)	(5)	(5)	(17)	3	EFFECT2 TYPE	12					19		
(5)	(6)	(6)	(6)	(18)	4	EFFECT2 PARA	*13	*13	*13	*13	*13	*13	*13	*13
(6)	(7)	(7)	(7)	(19)	5	EFFECT PLACE	19				17		18	

*14 68

*15 70

ERROR MESSAGES

(Common to all modes)

Error Message	Contents of Error
Battery Low (Internal)	The battery for internal memory backup needs to be replaced. Call the KORG distributor nearest you or your local KORG dealer or service center and have a qualified technician replace it.
Battery Low (RAM card)	The battery for RAM card memory backup needs to be replaced. In order to save your valuable data, load all data from the card to the M1's internal memory, then change the battery in the card, and finally reload the data back to the card. Removal of the battery results in loss of all data in the card.
Card Format Mismatch	Because the format of the card differs, writing in and reading out of data cannot be executed. (When writing to this card, use Global Mode function F9-2, Format Card.)
Card Memory Full	The number of steps of the sequence data to be saved is beyond the capacity of the card. (Re-format the Sequence Card in order to save the data.)
Invalid (Unformatted) Card	Card which does not have any Card remaining memory space, or a card not yet readied for use with the M1R has been inserted. (When using this kind of card, execute Global Mode F 9 - 2, Format Card.)
Memory Protected	Memory protect has been set in the Global Mode to prevent the accidental erasure of data (when writing to internal or card memory).
No Card Inserted	Reading from or writing to the card has been attempted without the card being fully inserted.
ROM Card or Protected Card	Data cannot be written to a RAM card unless the write protect switch is ON, and cannot be written to a ROM card at all.

Error Message	Contents
Beat or Length Mismatch	The time signature of the play data (of track or pattern) does not match that of the track or pattern being transferred to, or the length of a pattern being bounced or copied does not match that of the destination.
Blank Pattern	An initialized pattern was used for the PUT operation.
Measure Occupied by Pattern	Part of a pattern stretches over a specified punch-in measure or a specified destination measure in measure editing.

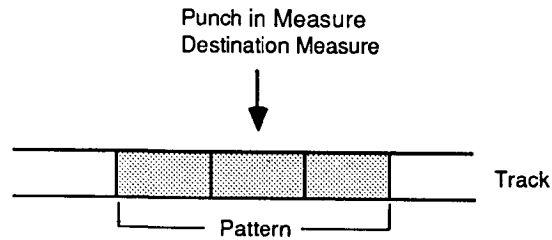

Measure Overflow	When executing an edit, the length of the tracks extends beyond 250 measures.
Memory Full	The total of all the songs and steps has used up the available memory capacity.
Track Has No Events	In Event Editing, the specified track does not have any play data.
Pattern Across Source	In copying from a track, part of a pattern has been included in the specified range of the source.

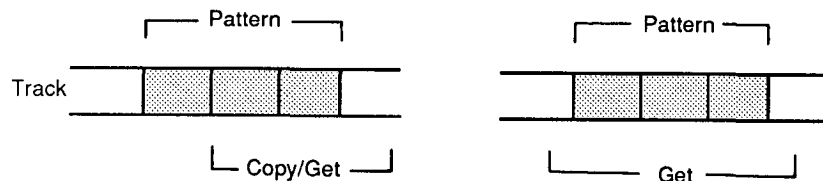

Pattern Conflicts	While executing the bounce function, a pattern with Events inserted by PUT occupies a portion of the source track or destination track range.
Pattern Used in Song	The pattern cannot be loaded because another previously loaded pattern is being used in the song.
Source Across Destination	In the Measure Copy function (F5-2) of copying to the same track, the range of source side and the destination side overlap.

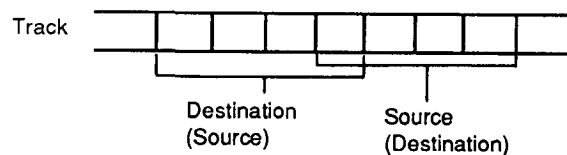

Track Protected	The protect for the specified track is set to ON.
-----------------	---

SPECIFICATIONS AND MISCELLANEOUS INFORMATION

SPECIFICATIONS

Sound generation method:	AI Synthesis system (full digital sound processing)
Sound source:	16 voice, 16 oscillator (Single mode) 8 voice, 16 oscillator (Double mode)
Waveform memory:	PCM; 2 Mword (4 Mbyte)
Quantization:	16 bit
Effect section :	2-system digital multi-effects
Program memory capacity:	100 Programs ^{*1}
Combination memory capacity:	100 Combinations ^{*1}
Sequencer section:	10 songs, 100 patterns, max. 7700 notes ^{*2} 8 tracks, 8-timbre multi-timbral operation (Dynamic Voice Allocation)
Controller inputs:	Damper pedal, assignable footswitches (pedals) 1 / 2
Outputs:	1/L, 2/R, 3, 4, stereo headphones
MIDI terminals:	IN, OUT, THRU
Display:	Backlit LCD (40 characters x 2 lines)
Optional accessories:	RAM card (MCR-03), ROM card, PCM card
Power requirements:	11 W
Dimensions:	430 (W) x 405 (D) x 88 (H) (16 - 15/16" x 15 - 15/16" x 3 - 7/16")
Weight:	5.9kg (13 lbs. 208 oz.)

*1 Memory allocation can be changed to 50 Programs and 50 Combinations.

*2 A capacity of 4400 notes when 100 Program/100 Combination memory allocation is selected.

* Specifications are subject to changes and improvements without notice.

M1 MIDI IMPLEMENTATION CHART

FUNCTION	Transmitted	Recognized	Remarks
Basic Channel Default Change	1 ~ 16 1 ~ 16	1 ~ 16 1 ~ 16	Memorized
Mode Default Messages Altered	x *****	3 x	
Note number: Sound range	0 ~ 127 *****	0 ~ 127 0 ~ 127	
Velocity Note on Note off	o 9n, V=10 ~ 127 x	o 9n, V=1 ~ 127 x	
After Touch Keys Ch's	x o	x o	[A]
Pitch bend	o	o	*1
Control Change	1 x 2 x 6 o 7 o 38 o 64 x 96 o 97 o 100 x 101 x 0-101 o	o o o o o o o o o o o	Pitch MG *1 VDF modulation *1 Data entry (MSB) *2 Volume *1 Data entry (LSB) *2 Sustain *1 Data increment *2 Data decrement *2 LSB of RPC for master tune *2 MSB of RPC for master tune *2 *5
Program Change Actual No.	o 0 ~ 99 *****	o 0 ~ 127 0 ~ 99	[B]
System Exclusive	o	o	*2,*4
System Common : Song pos. : Song sel. : Tune	o o 0 ~ 19 x	o o 0 ~ 19 x	*3 *3
System Real time : Clock : Commands	o o	o o	*3 *3
Aux Message : Local ON/OFF : All note off : Active sensing : Reset	x x o x	x o 123 ~ 127 o x	
<p>NOTES: *1 Transmit/receive if CONTROL is set to ENA in GLOBAL Mode. *2 Transmit/receive if EXCLUSIVE is set to ENA in GLOBAL Mode. *3 When Clock is Internal, it transmits but does not receive. When External, the opposite is true. *4 Dumps and edits the Program data. Compatible with universal exclusive (Device ID). *5 Transmit in SEQUENCER Mode if OVERFLOW is set to ON in GLOBAL Mode.</p>			

Mode 1: OMNI ON, POLY Mode 2: OMNI ON, MONO o : Yes
 Mode 3: OMNI OFF, POLY Mode 4: OMNI OFF, MONO x : No

[A]: Transmit/receive when AFTER TOUCH is set to ENA in GLOBAL Mode.

[B]: Transmit/receive when PROG/COMBI CHANGE is set to ENA in GLOBAL Mode.

MULTISOUND LIST

00 Piano	25 SynMallet	50 FingerSnap	75 VoiceWvNT 1
01 E. Piano 1	26 Flute	51 Pop	76 VoiceWvNT 2
02 E. Piano 2	27 Pan Flute	52 Drop	77 DWGS E. P. 1
03 Clav	28 Bottles	53 Drop NT	78 DWGS E. P. 2
04 Harpsicord	29 Voices	54 Breath	79 DWGS E. P. 3
05 Organ 1	30 Choir	55 Breath NT	80 DWGS Piano
06 Organ 2	31 Strings	56 Pluck	81 DWGS Clav
07 MagicOrgan	32 Brass 1	57 Pluck NT	82 DWGS Vibe 1
08 Guitar 1	33 Brass 2	58 Vibe Hit	83 DWGS Bass 1
09 Guitar 2	34 Tenor Sax	59 VibeHit NT	84 DWGS Bass 2
10 E. Guitar	35 Mute TP	60 Hammer	85 DWGS Bell 1
11 Sitar 1	36 Trumpet	61 Metal Hit	86 DWGS Orgn 1
12 Sitar 2	37 TubaFlugel	62 MetalHitNT	87 DWGS Orgn 2
13 A. Bass	38 DoubleReed	63 Pick	88 DWGS Voice
14 Pick Bass	39 Koto Trem	64 Distortion	89 SquareWave
15 E. Bass	40 BambooTrem	65 Dist NT	90 Digital 1
16 Fretless	41 Rhythm	66 Bass Thumb	91 Saw Wave
17 SynthBass 1	42 Lore	67 BasThumNT1	92 Digital 2
18 SynthBass 2	43 Lore NT	68 BasThumNT2	93 25% Pulse
19 Vibes	44 Flexatone	69 Wire	94 10% Pulse
20 Bell	45 WindBells	70 Pan Wave	95 Digital 3
21 Tubular	46 Pole	71 Ping Wave	96 Digital 4
22 Bell Ring	47 Pole NT	72 Fv Wave	97 Digital 5
23 Karimba	48 Block	73 Mv Wave	98 DWGS TRI
24 KarimbaNT	49 Block NT	74 Voice Wave	99 DWGS Sine

- The "NT" designation on certain Multisounds indicates that the pitch of the sound is the same regardless of the key played.

DRUM SOUND LIST

01 Kick 1	12 Open HH 1	23 E. Tom	34 Metal Hit
02 Kick 2	13 Closed HH 2	24 Ride	35 Pluck
03 Kick 3	14 Open HH 2	25 Rap	36 FlexaTone
04 Snare 1	15 Crash	26 Whip	37 Wind Bell
05 Snare 2	16 Conga 1	27 Shaker	38 Tubular 1
06 Snare 3	17 Conga 2	28 Pole	39 Tubular 2
07 Snare 4	18 Timbales 1	29 Block	40 Tubular 3
08 Side Stick	19 Timbales 2	30 FingerSnap	41 Tubular 4
09 Tom 1	20 Cowbell	31 Drop	42 Bell Ring
10 Tom 2	21 Claps	32 Vibe Hit	43 Metronome 1
11 Closed HH 1	22 Tambourine	33 Hammer	44 Metronome 2

NOTICE

Korg products are manufactured under strict specifications and voltages required by each country. These products are warranted by the Korg distributor only in each country. Any Korg product not sold with a warranty card or carrying a serial number disqualifies the product sold from the manufacturers's/distributor's warranty and liability. This requirement is for your own protection and safety.

KORG[®] KORG INC.

15-12, Shimotakaido 1-chome, Suginami-ku, Tokyo, Japan.

1988 © KORG INC.

0108ETH Printed in Japan

Ⓔ