



KEROPPI™

KERO KERO KEROPPI'S LET'S PLAY TOGETHER

OPERATING MANUAL



American Sammy Corporation

901 Cambridge Drive
Elk Grove Village, IL 60007
Phone: (708) 364-9787
Fax: (708) 364-9831

TABLE OF CONTENTS

1. SPECIFICATIONS	Page 1
2. JAMMA CONNECTOR TABLE	Page 2
3. DIP SW SETTING and more * Mounting the Main P.C.Board * Extra connector tables	Page 3 Page 4
4. GAME PLAY * How to play * How to control	Page 5
5. LOCATION OF SWITCHES	Page 6
6. TEST MENU	Page 7, 8
7. TROUBLE SHOOTING	Page 9
◆ ELECTRICAL WIRING DIAGRAM	Page 10

1. SPECIFICATIONS

POWER Domestic 120AVC 3Amps @ 60Hz

DIMENSIONS Width: 22" (Approx.)
Height: 67 1/2" (Approx.)
Depth: 33 1/2" (Approx.)

* Outside carton measurement: W: 24 1/2" x H: 50 1/2" x D: 36"

WEIGHT 250 lbs.

SPARE PARTS INCLUDED T-25 Torex Wrench

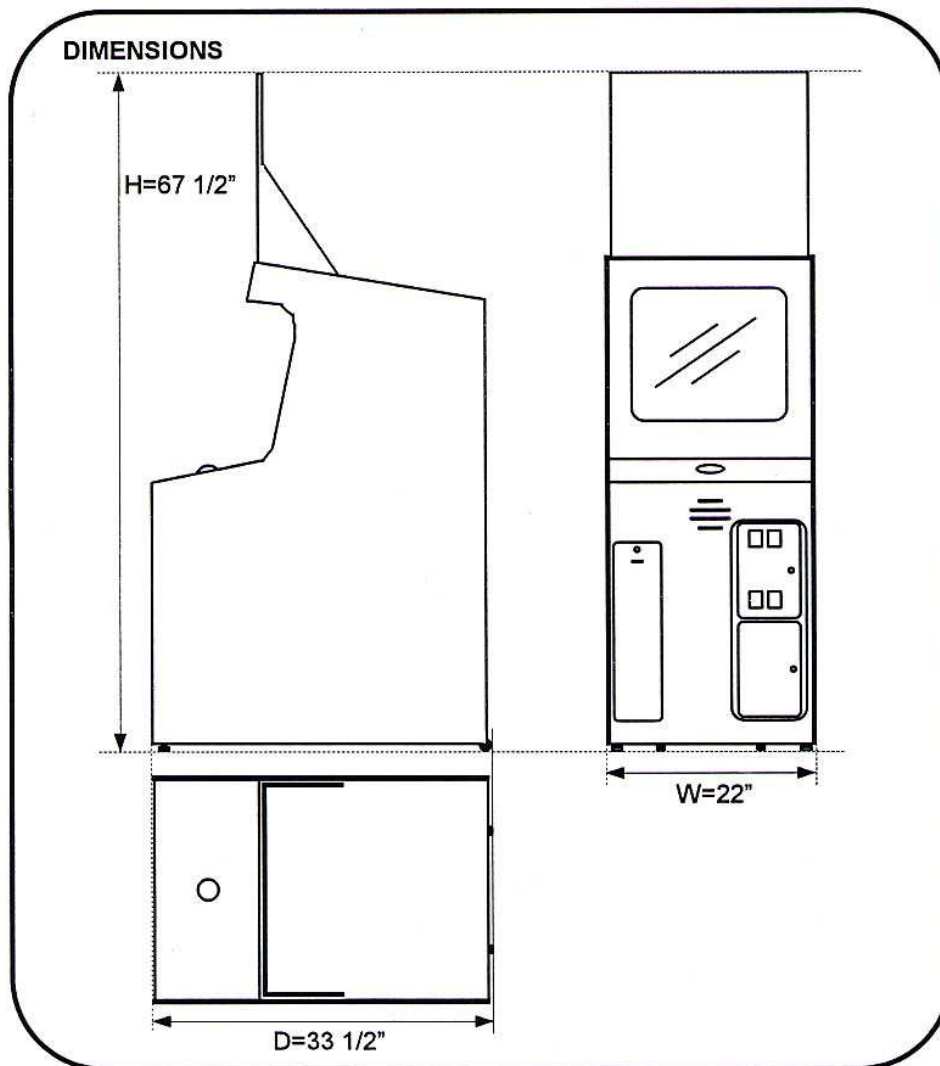

2. JAMMA CONNECTOR TABLE

Keroppi™

SOLDER SIDE			COMPONENT SIDE		
FUNCTION	COLOR	EDGE	EDGE	COLOR	FUNCTION
		CONNECTOR	CONNECTOR		
GROUND	BLK	A	1	BLK	GROUND
GROUND	BLK	B	2	BLK	GROUND
(+)5VDC	RED	C	3	RED	(+)5VDC
(+)5VDC	RED	D	4	RED	(+)5VDC
		E	5		
(+)12VDC	BLU	F	6	BLU	(+)12VDC
KEY		H	7		KEY
PAYOUT COUNTER METER		J	8	BLU/BRN	COIN METER A
		K	9		COIN LOCKOUT A
SPEAKER(-)	BLK	L	10	WHT/BLK	SPEAKER(+)
		M	11		
VIDEO GREEN	GRN	N	12	RED	VIDEO RED
VIDEO SYNC	WHT	P	13	BLU	VIDEO BLUE
SERVICE CREDIT SWITCH	BRN/WHT	R	14	BLK	VIDEO GROUND
		S	15	WHT/GRY	TEST SWITCH
COIN SWITCH B		T	16	WHT/YEL	COIN SWITCH A
		U	17		
		V	18		HOPPER PAYOUT NOTCH
TICKET RESUME SWITCH		W	19		
TICKET CLEAR SWITCH		X	20		
		Y	21		
		Z	22	RED/WHT	PUSH BUTTON
		a	23		
TICKET PAYOUT NOTCH	BRN/GRN	b	24		PAYOUT SWITCH
		c	25		
		d	26		
GROUND	BLK	e	27	BLK	GROUND
GROUND	BLK	f	28	BLK	GROUND

3. DIP SWITCH TABLE

Keroppi™

DIP SWITCH 1									
FUNCTIONS	SETTING	1	2	3	4	5	6	7	8
COIN CHUTE	1 COIN 1 CREDIT	OFF	OFF						
	2 COINS 1 CREDIT	ON	OFF						
	3 COINS 1 CREDIT	OFF	ON						
	4 COINS 1 CREDIT	ON	ON						
ATTRACT SOUND	ON			OFF					
	OFF			ON					
VENDING STYLE	TICKET				OFF				
	NO VENDING				ON				
FREE PLAY	NORMAL PLAY					OFF			
	FREE PLAY					ON			
DIFFICULTY LEVEL	NORMAL						OFF	OFF	
	EASY						ON	OFF	
	HARD						OFF	ON	
	HARDEST						ON	ON	
PAYOUT SETTING	NORMAL PAYOUT								OFF
	NO PAYOUT								ON

DIP SWITCH 2									
FUNCTIONS	SETTING	1	2	3	4	5	6	7	8
"OBSTACLE COURSE" PAYOUT SETTING	MEDIUM (0, 2, 3, 4, 8 tickets)	OFF	OFF						
	LOW (0, 1, 2, 3, 6 tickets)	ON	OFF						
	HIGH (0, 3, 4, 5, 10 tickets)	OFF	ON						
	HIGHEST (0, 3, 5, 7, 15 tickets)	ON	ON						
"TREASURE HUNT" PAYOUT SETTING	MEDIUM (3, 5, 7 tickets)			OFF	OFF				
	LOW (1, 3, 5 tickets)			ON	OFF				
	HIGH (5, 7, 10 tickets)			OFF	ON				
	HIGHEST (5, 10, 15 tickets)			ON	ON				
"NEW JERSEY" PAYOUT SETTING	OFF					OFF	OFF		
	ALWAYS PAYOUT 1 TICKET					ON	OFF		
	ALWAYS PAYOUT 3 TICKETS					OFF	ON		
	ALWAYS PAYOUT 5 TICKETS					ON	ON		
"MERCY TICKET" PAYOUT SETTING (TREASURE HUNT ONLY)	1 TICKET							OFF	OFF
	2 TICKETS							ON	OFF
	3 TICKETS							OFF	ON
	NO PAYOUT							ON	ON

"FACTORY INSTALLED" SETTING

Mounting the Main P.C.Board

P.C. BOARD

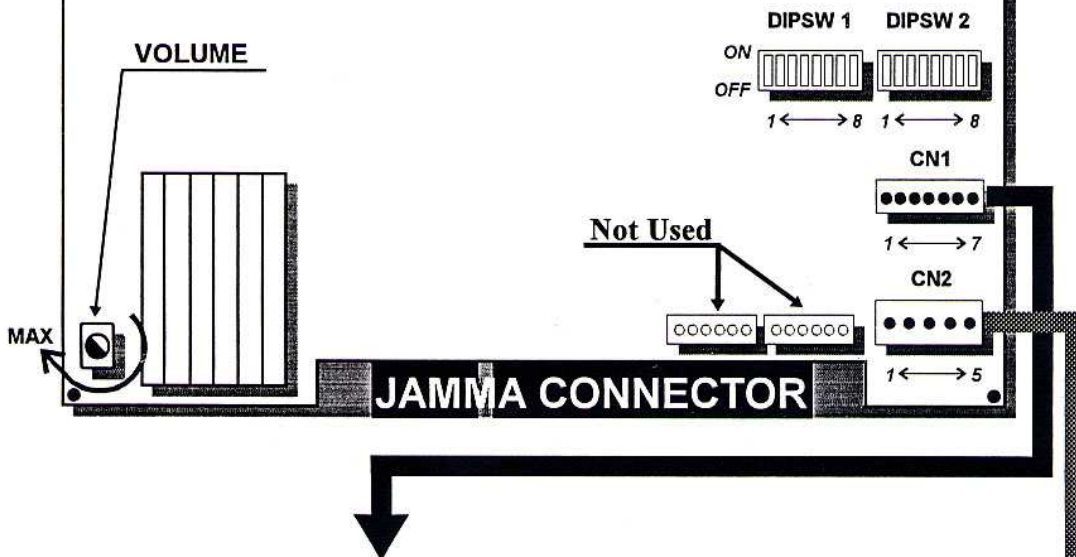

"CN1" CONNECTOR	
PIN#	FUNCTION
1	+12VDC
2	NOT USED
3	NOT USED
4	NOT USED
5	NOT USED
6	HOPPER (OR TD) DRIVE HOT
7	HOPPER DRIVE COLD

"CN2" CONNECTOR	
PIN#	FUNCTION
1	+12VDC
2	PUSH BUTTON LAMP 1
3	NOT USED
4	NOT USED
5	NOT USED

4. GAME PLAY

HOW TO PLAY

- Insert coin
- Pick **OBSTACLE COURSE** or **TREASURE HUNT** with the Button.

OBSTACLE COURSE

Jump over the obstacles and complete the course to win tickets!

TREASURE HUNT

Choose 1 box to find the treasure to win tickets.
If successful, you get 2 more tries to win more tickets!

HOW TO CONTROL

CONTROL PANEL

This game uses 1 Push Button only.

PUSH BUTTON

- * Game Start
- * Decision
- * To make character jump

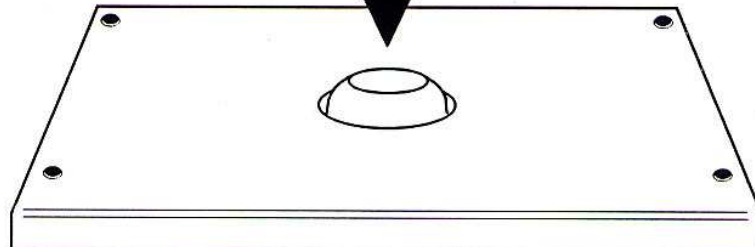

5. LOCATION OF SWITCHES

CONTROL PANEL

PUSH BUTTON

There is just 1 PUSH BUTTON only on the control panel. When you are in TEST MODE, you will have to use it for ENTER MENU and EXIT with the TEST switch.

CONTROL SWITCHES PLATE

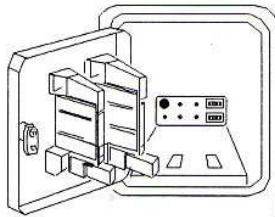

Open the coin door....

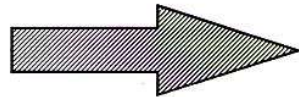

Control switches plate
Located inside of the front coin door.

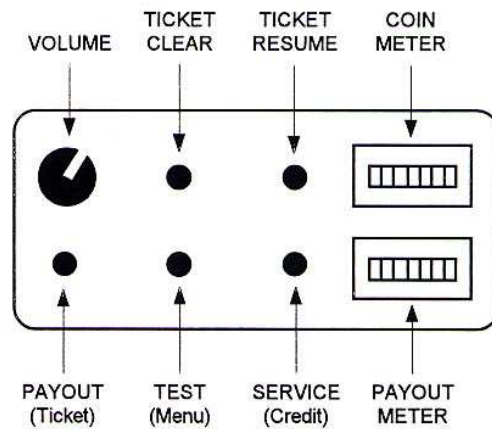

VOLUME

You can adjust the volume with this switch. Also you can adjust with the volume pot. on the P.C.Board. (See Page 4)

TICKET RESUME

This switch will restart the ticket dispenser, after it is reloaded, from where it left off when it ran out.

TICKET CLEAR

This switch will end the "Out of Tickets" condition and clear the remaining ticket count.

PAYOUT (Ticket)

If you need a ticket payout, press this switch. The ticket dispenser will payout tickets. When you need to stop the payout, press this switch again.

TEST (Menu)

When you press this switch, you will go to TEST MENU. (See Page 7)

SERVICE (Credit)

When you need a "Service Credit", press this switch. You can get 1 credit per push.

6. TEST MENU

Entering the TEST MENU

If you need to check the condition of the game circuitry and controls, you can use the TEST MENU. Press the TEST switch on the control switches plate inside of the front coin door. (See Page 6) The game will go into TEST MODE (Diagnostics) and the screen appears as follows;

Select TESTs

Use this screen to choose which of the 7 screens you want to see. Move cursor using the TEST switch. Then press the Push Button on the control panel to enter the test.

* Returning to the TEST MENU screen

Press the TEST switch at each test screen. You can go back to the TEST MENU screen.

* Returning to the Game screen

Move cursor to EXIT on this screen and press the push button.

COLOR TEST

Use this screen to check the color of monitor. The color blocks in the center should be four bands (Red, Green, Blue, and White from top to bottom), each with a color scale from bright to dark, left to right. If the screen does not match this description, adjust the Monitor as described in the Monitor's manual.

CROSS HATCH

Use this screen to check the size of picture. The CROSS HATCH test pattern has a Orange grid on a Green background. Check following:

- The grid line should be straight, and the line should not have excessive pincushion or barrel distortion.
- "Out" line of grid line is the same size as "Out" line of game screen. So, "Out" line should be able to be seen with no overflow of grid lines on screen.

If these are not as above, adjust the Monitor as described in the Monitor's manual.

DIP SWITCH

Use this screen to see how all the DIP Switches are set.

You can view and change the coinage and game options on this screen.

The coinage and game option setting are explained on the DIP SWITCH TABLE. (Page 3, 4) To change a setting, slide the appropriate toggle on the DIP Switch to ON or OFF. The screen will immediately display those changes.

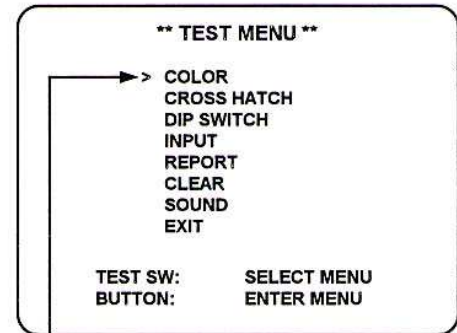

CURSOR

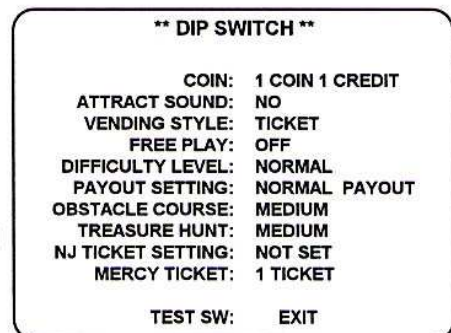
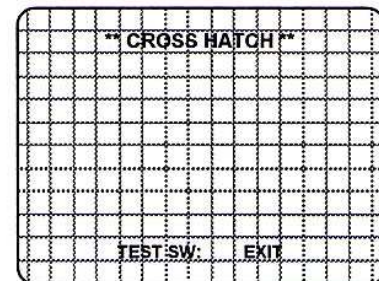
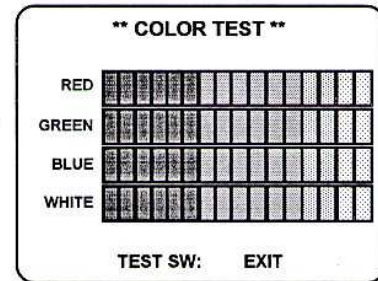

INPUT TEST

Use this screen to check the Push Button, the coin switches and any other switches in this game. To check the functioning of each switch, activate it and watch the corresponding OFF letters change to ON. If the ON and OFF letters do not appear correctly, check the Harness connections and Switches.

** INPUT TEST **

DIP SW-1 DIP SW-2
00000000 00000000

BUTTON: OFF
SERVICE: OFF
PAYOUT: OFF
TICKET CLEAR: OFF
TICKET RESUME: OFF
COIN: OFF 00000000
HOPPER: OFF 00000000
TICKET: OFF 00000000

TEST SW: EXIT

REPORT

Use this screen to see how many times each game has been played.

** REPORT **

OBSTACLE COURSE: 0000
TREASURE HUNT: 0000

TEST SW: EXIT

DATA CLEAR

Use this screen to erase the records in the REPORT screen.

When you are in this screen, press the Push Button. You can erase the records which are number of plays for OBSTACLE COURSE and TREASURE HUNT.

** DATA CLEAR **

BUTTON: ENTER MENU
TEST SW: EXIT

SOUND TEST

Use this screen to check all game sounds. Press the Push Button to start the sound.

** SOUND TEST **

SOUND CODE
00

TEST SW: EXIT

7. TROUBLE SHOOTING

Problem	Suggested Action
Push Button Problem	<p>a) Check the harness and the connectors of the control panel and the P.C.B..</p> <p>b) If you took the control panel apart, have you re-assembled it correctly ?</p> <p>c) Make sure all the parts on the control are good. Repair or replace parts.</p>
*Light Bulb is not lit	<p>a) Check the Light Bulb in the Push Button.</p> <p>b) Check the harness of the control panel and wiring around the Light Bulb.</p>
Coin Mechanism Problem	<p>a) Check the wiring to the coin switch and coin counter.</p> <p>b) Test the coin switch with the INPUT TEST screen in the TEST MENU.</p>
Game Play Problem	<p>a) Check the harness and connectors of the control panel.</p> <p>b) Perform the INPUT TEST.</p> <p>c) Check the voltage levels on the Main P.C.B.</p>
Sound Problem	<p>a) Is the speaker volume turned up ? (Volume can be adjusted on the Main P.C.B.)</p> <p>b) Check the voltage levels on the Main P.C.B. edge connector.</p> <p>c) Check the wiring from the Main P.C.B. to the speaker.</p> <p>d) Check the voltage level to the Main P.C.B.</p> <p>e) Replace the speaker.</p>
Monitor Problem	
* Screen area wavers or is too small	<p>a) Check the correct power voltage to the Monitor P.C.B..</p> <p>b) Check the correct high power voltage to the Monitor P.C.B..</p>
* Picture is wavy	<p>a) Is the monitor ground connected to the monitor ?</p> <p>b) Is the SYNC input connected properly ?</p>
* Convergence, purity or color problems.	a) Use the screen in the TEST MENU to adjust the Monitor.
* Picture is not centered	
* If the screen is dark	<p>a) Check line (Main) fuse.</p> <p>b) Check that the brightness on the Monitor is turned up.</p> <p>c) Is the JAMMA connector on the Main P.C.B. tightly connected ?</p> <p>d) Check all of the items below. If you answer no to any question, you have a problem with the Monitor, not with the game circuitry. See your Monitor service manual.</p> <ul style="list-style-type: none"> * Do you have power to the Monitor ? * Are the Monitor's filaments lit ? * Do you have high voltage to the Monitor ? <p>e) Are the voltage levels to the Monitor P.C.B. correct ? (Power voltage is 100VAC or 110 VAC, depending on the type of Monitor. Video signal voltage is 0.5 to 3.5 Volts.) If the level is not correct, check the connectors and the harness.</p>
Ticket Dispenser Problem	
*If the Ticket Dispenser doesn't work	a) Check the wiring to the P.C.B. of the Ticket Dispenser. Check the JAMMA connector and the SUB connector on the Main P.C.B..
*If the Ticket Dispenser gets jammed	a) Take off the Metal Ticket Guide from the ticket dispenser to unjam tickets.

◆ ELECTRICAL WIRING DIAGRAM

JAMMA Connector (56 pins)
on Main CPU Board

GND	1
GND	A
GND	2
GND	B
+5VDC	3
+5VDC	C
+5VDC	4
+5VDC	D
	5
	E
+12VDC	6
+12VDC	F
KEY	7
KEY	H
COIN METER A	8
PAYOUT COUNTER METER	J
	9
	K
SPEAKER (+)	10
SPEAKER (-)	L
	11
	M
VIDEO RED	12
VIDEO GREEN	N
VIDEO BLUE	13
VIDEO SYNC	P
VIDEO GND	14
SERVICE CREDIT SWITCH	R
TEST SWITCH	15
	S
COIN SWITCH A	16
	T
	17
	U
	18
	V
	19
TICKET RESUME SWITCH	W
	20
TICKET CLEAR SWITCH	X
	21
	Y
PUSH BUTTON	22
	Z
	23
	a
PAYOUT SWITCH	24
TICKET PAYOUT NOTCH	b
	25
	c
	28
	d
GND	27
GND	e
GND	28
GND	f

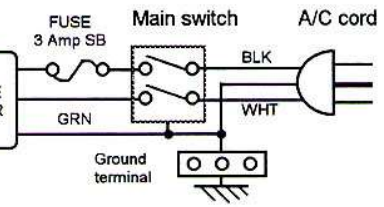
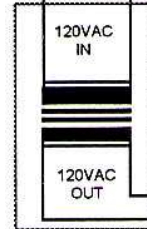
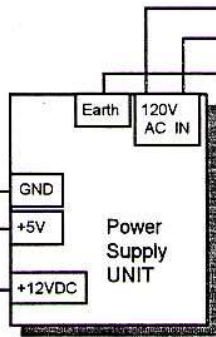

Ground Go to Coin/Ticket door, Transformer and TV Monitor.

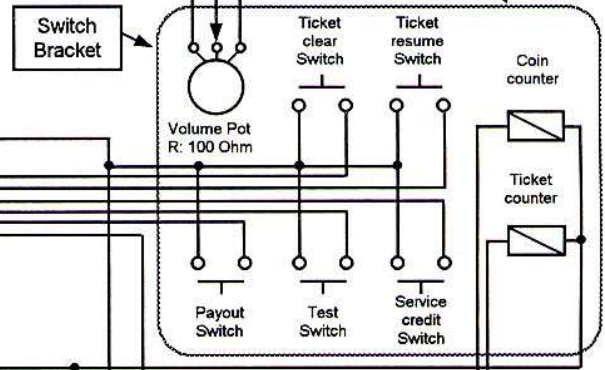
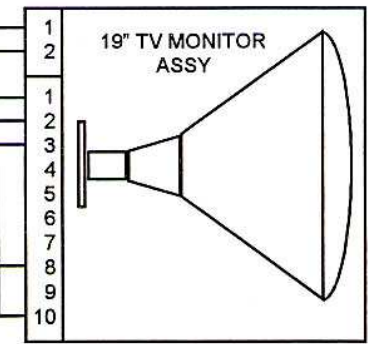

CN1 Connector (7 pins)
on Main CPU Board

+12VDC	1
	2
	3
	4
	5
Ticket D. MOTOR ENABLE	6
	7

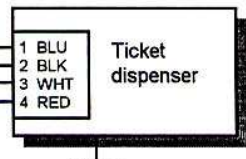
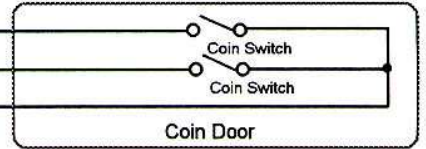

CN2 Connector (5 pins)
on Main CPU Board

+12VDC	1
PUSH BUTTON LAMP 1	2
	3
	4
	5

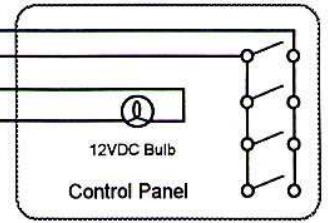

Limited warranty, Repair and Return Policy

American Sammy Corporation warrants all products to be free from defective materials and workmanship for a period of thirty (30) days from the American Sammy Corporation invoice date unless otherwise specified in writing by American Sammy Corporation. The extent of this warranty applies to all electronic assemblies only, and does not include lamps and fuses.

This limited warranty is invalid for any product that upon examination, is deemed to have been subject to misuse, improper repair or installation, neglect or violation of specification or other instructions published by American Sammy Corporation.

There are no additional warranties which extend beyond those limited warranties described above. The limited warranties described above shall be in lieu of any other warranty, express or implied, including but not limited to any implied warranty of merchantability or fitness for a particular purpose.

Return Merchandise Authorization

1. Contact your authorized ASC distributor to receive a Return Merchandise Authorization for return.
2. You must obtain RMA numbers from American Sammy Corporation through an authorized ASC distributor. Please have your serial number available when calling for an RMA number.
3. All items must have an RMA number marked clearly on the outside of the package.
4. Products must be shipped prepaid. Products returned without an RMA number will not be accepted.
5. Credits to accounts are subject to inspection of products for damage and suitability for resale.

F.C.C. Regulation Compliance

This equipment complies with the limits for a Class A digital device pursuant to Part 15 of the F.C.C. Rules.

These limits are designed to provide reasonable protection against harmful interference when the equipment is operated in a commercial environment.

This equipment can radiate radio frequency energy and, if not installed and used in accordance with the instruction manual, may cause harmful interference to radio communications. Operation of this equipment in a residential area is likely to cause harmful interference in which case the user will be required to correct the interference at their own expense.

UL & CUL Listed

This game has been tested & listed by Underwriters Laboratory. This listing is subject to no modifications done by operator of this game. Any modifications not approved by American Sammy Corporation will void such U.L. & C.U.L. listing.