

# DSS-1

## DIGITAL SAMPLING SYNTHESIZER OWNER'S MANUAL

This manual was scanned and edited by Larry Hendry  
Extensive free support for the Korg DSS-1 Sampling  
Synthesizer can be found at: [www.wiseguysynth.com](http://www.wiseguysynth.com)

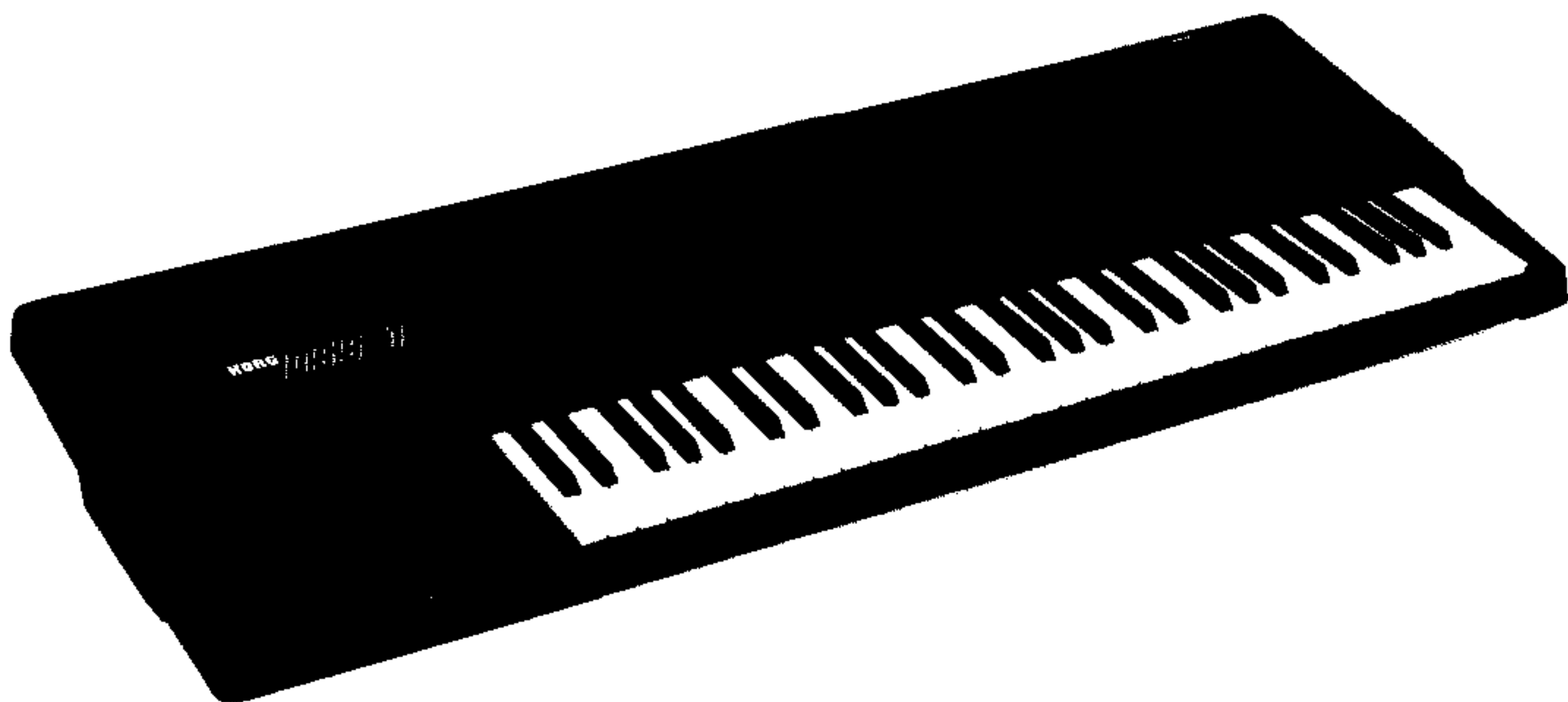

# KORG®

*Congratulations and thank you for choosing the KORG DSS-1 Digital Sampling Synthesizer. Please read this manual carefully to obtain optimum performance and help assure long term reliability.*

## **BASIC PRECAUTIONS**

### **■ Place of use:**

Avoid using this unit exposed to the following conditions.

- Direct sunlight
- High temperature and humidity
- Dust or sand
- Vibrations

Also, to assure proper floppy disk operation, use this unit on a level surface.

### **■ Power Supply**

Use only with the rated AC voltage. If you need to use this unit in areas having different power specifications, please consult your KORG dealer and use the correct converter or transformer as necessary.

### **■ Interference with Electrical Appliances**

This unit uses microprocessor circuitry that may cause interference with nearby radio and TV receivers. If problems occur, use at a greater distance from the radio or TV.

### **■ Saving Data**

Data in the DSS-1's memory includes program parameter data and sound data that disappears when the DSS-1's power is turned off. Therefore, be sure to save this data to floppy disk before turning off the power.

### **■ Handle Gently**

Switches, knobs and other controls are designed to operate with a normal touch. Excessive force will lead to damage and malfunction.

### **■ Transport**

This unit uses a 3.5 inch floppy disk drive. To protect the drive heads, remove any disc from the drive and insert the head protection sheet before moving, shipping, or otherwise transporting this unit.

### **■ Cleaning**

To avoid harming the finish, use only a soft dry cloth to wipe the exterior. Never use benzene or other volatile cleaners or solvents. Never use polishes or cleaning compounds.

### **■ Owner's Manual**

Keep this owner's manual to refer to as you use this equipment.

	<b>FEATURES &amp; FUNCTIONS</b>	<b>4</b>	
	1. Front Panel	4	
	2. Rear Panel	6	
	3. Disk Drive & Floppy Disks	8	
	<b>BEFORE PERFORMANCE</b>	<b>12</b>	
	1. Basic Setup	12	
	2. Basic Operation	14	
	3. Performance Functions	19	
<b>Basic section</b>	<b>CREATING SOUNDS</b>	<b>23</b>	
	1. Sound Synthesis Concepts	23	
	2. Making the Raw Materials (sounds) for a Multisound	27	
	3. Completing Your Multisounds	39	
	4. Using the Completed Multisounds	45	
	<b>DATA MANAGEMENT</b>	<b>48</b>	
	1. DSS-1 Memory, Data Structure, and Systems	48	
	2. Floppy Disks and Data Management	52	
		<b>GENERAL OPERATION</b>	<b>55</b>
		1. Overview of the Operation modes	55
	2. Example Applications of modes	60	
	<b>SAMPLE MODE</b>	<b>61</b>	
	1. Initial Operation	61	
	2. About Each of the Functions	63	
	<b>CREATE WAVEFORM MODE</b>	<b>88</b>	
	1. About Each of the Functions	88	
	<b>EDIT SAMPLE MODE</b>	<b>102</b>	
	1. About Each of the Functions	102	
<b>Operation section</b>	<b>MULTISOUND MODE</b>	<b>147</b>	
	1. About Each of the Functions	147	
	<b>PROGRAM PARAMETER MODE</b>	<b>196</b>	
	1. About Each of the Functions	196	
	<b>SYSTEM MODE</b>	<b>240</b>	
	1. About Each of the Functions	240	
	<b>DISK UTILITY MODE</b>	<b>270</b>	
	1. About Each of the Functions	270	
	<b>MIDI MODE</b>	<b>294</b>	
	1. About Each of the Functions	294	
	2. DSS-1 MIDI IMPLEMENTATION	302	
	3. Using the System Exclusive Messages	307	
	<b>SPECIFICATIONS &amp; OPTIONS</b>	<b>310</b>	
	<b>ERROR MESSAGES</b>	<b>311</b>	

### About this Manual

This manual is divided into two main parts. The first part covers the basics, from "BEFORE PERFORMANCE" through "DATA MANAGEMENT". The second part covers operational details, from "GENERAL OPERATION" to "MIDI MODE".

We urge you to please read through the basic section. Then use the second part as a reference manual, going to it when you need specific instructions for particular operations.

# FEATURES & FUNCTIONS

## 1. Front Panel

■ **MASTER VOLUME**  
Volume control for synthesizer's sound output.

■ **MASTER TUNE**  
Used for tuning the DSS-1 to match the pitch of other instruments. Pitch may be adjusted over a range of about  $\pm 50$  cents.

■ **DATA ENTRY A**  
■ **DATA ENTRY B**  
These sliders are used to adjust the values of parameters, to make selections from menus, and other control and entry purposes. After making rough adjustment with the slider itself, use the up/down arrow keys ( $\blacktriangle$ / $\blacktriangledown$ ) to make fine adjustments.

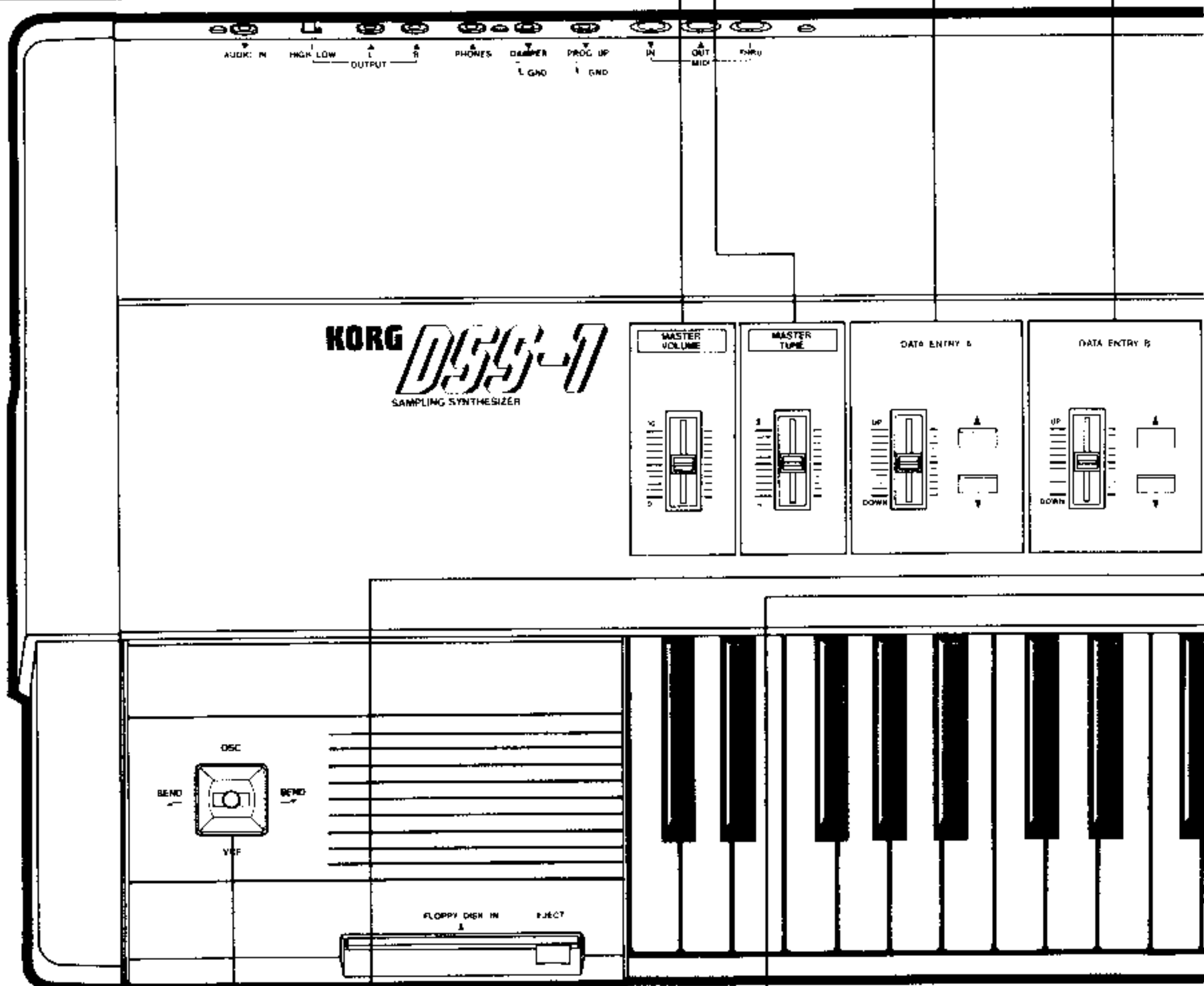

■ **JOYSTICK**  
For real-time control of pitch bends, vibrato, filter modulation, and other effects while playing.

■ **DELETE/CANCEL KEY**  
Used to cancel or delete sampling operation, sample names, program names and so on. Also used to cancel errors occurring during disk access.

■ **COMPARE KEY**  
Used only in the multi-sound mode to restore the original value after changing a value.

■ **LCD**  
 This liquid crystal display shows data and messages from the DSS-1.

■ **CONTRAST CONTROL**  
 Turn this knob to adjust the LCD for maximum legibility. If you can not see anything on the display, try turning this knob clockwise.

■ **MODE SELECT KEY/FUNCTION MAP**  
 Use the keys in this section to select the operating mode. If a key's LED is illuminated then that mode has been selected. If none of the mode key LEDs are illuminated, then the DSS-1 is operating in the PLAY mode. The functions available within each mode are shown in the function list to the right of each of the mode keys.

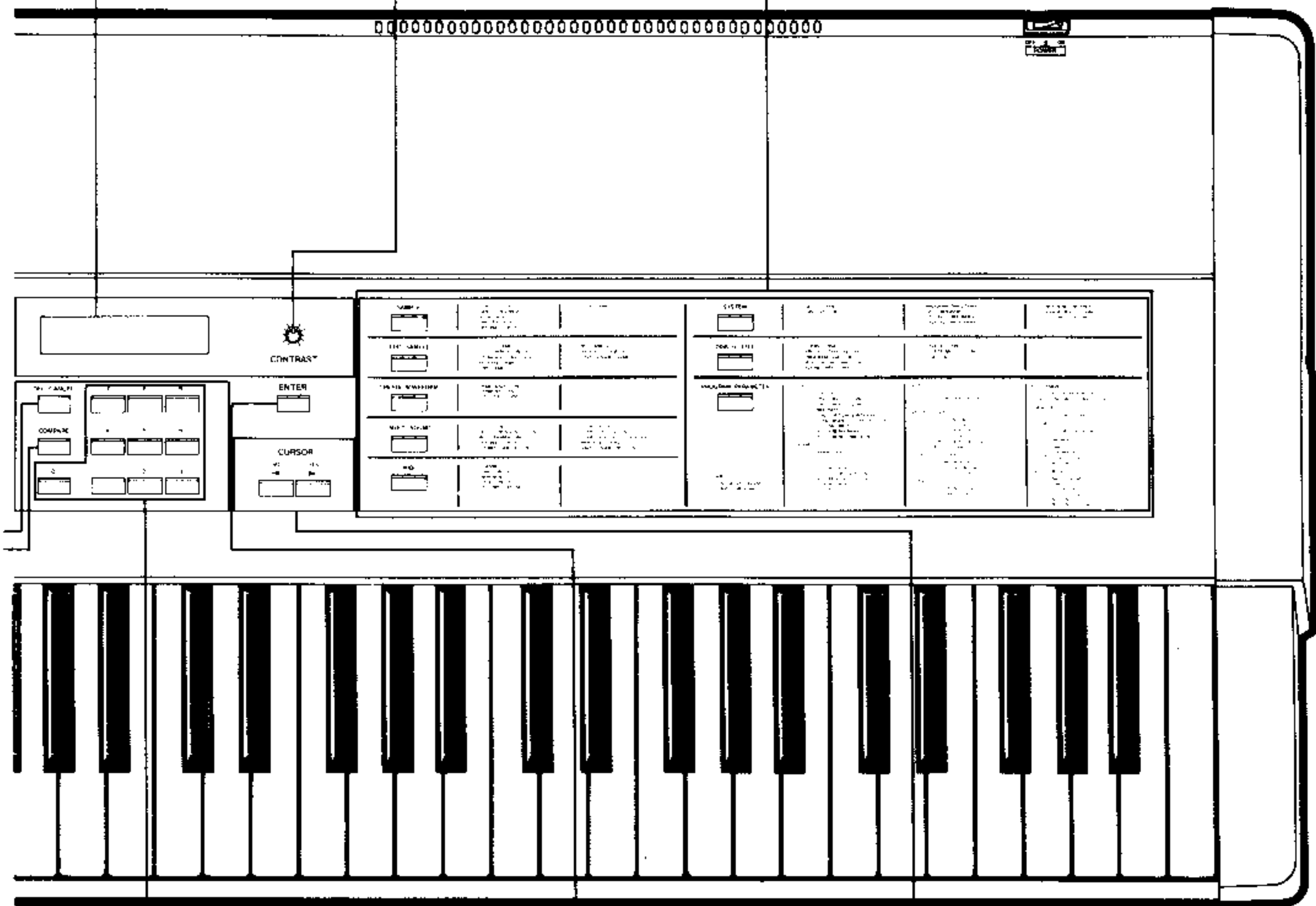

■ **10-KEY PAD**  
 These ten keys, numbered from 0 to 9, are used to select program numbers, and to select functions within particular modes.

■ **ENTER KEY**  
 Used to input data and to begin disk access. Also used for "Key transpose" in the play mode.

■ **CURSOR & YES/NO KEYS**  
 Used to move the cursor (the short underline that indicates your current position) in the LCD readout and to respond to messages from the DSS-1.

# 2. Rear Panel

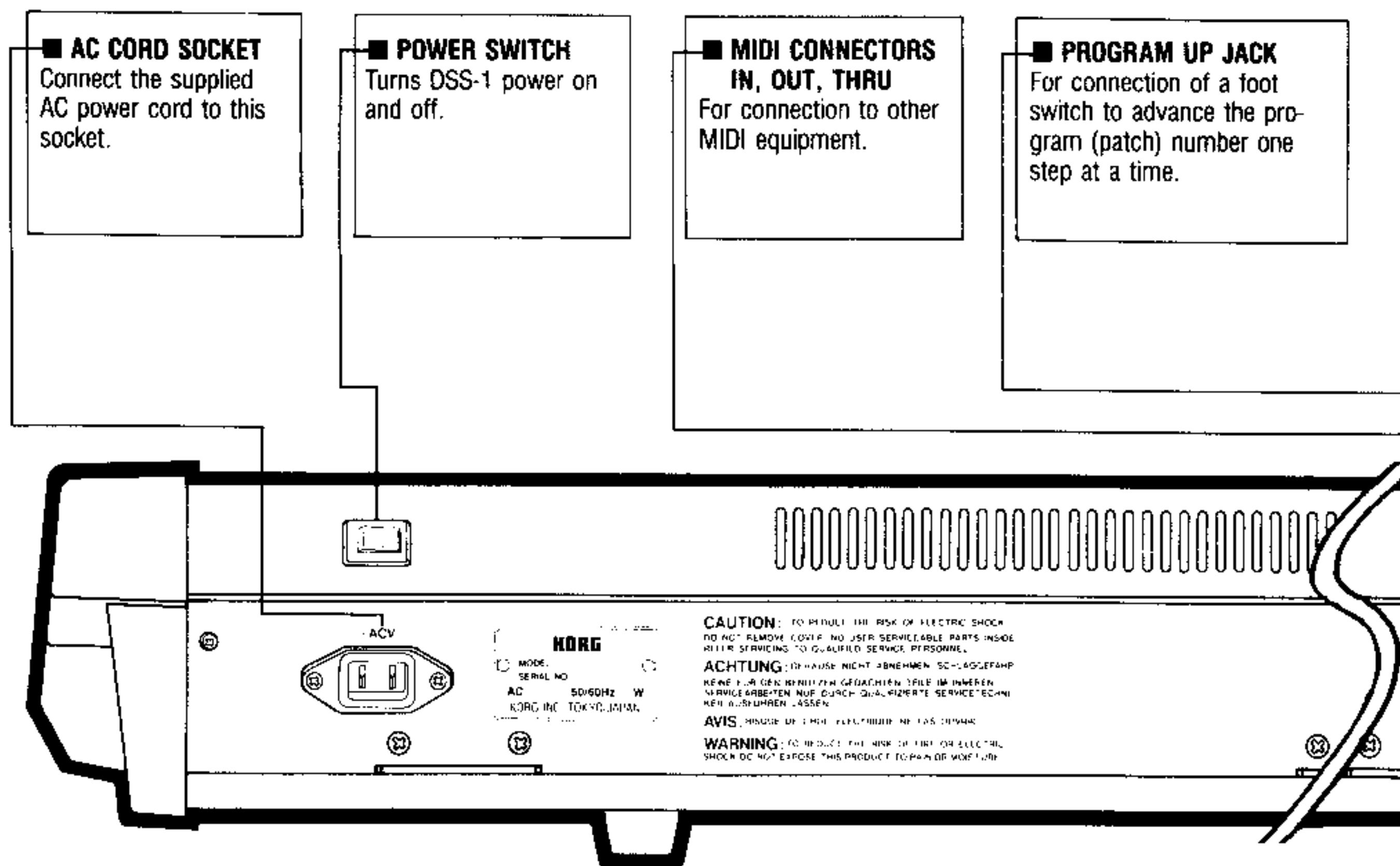

## ■ About the OUTPUT jacks.

★ The audio output stage of the DSS-1 is equipped with two digital delay lines, DDL-1 going to the LEFT output jack and DDL-2 going to the RIGHT jack. Depending on the connection and the kind of output that you want, the delays can be set for serial or parallel operation as shown in the charts here.

If you use both jacks then you get parallel delay which is recommended to provide the maximum benefits of the dual delays for stereo chorus and other stereo reproduction effects. However, if you need monaural output, then you can connect to just the RIGHT jack. This switches internally to a serial connection from DDL-1 to DDL-2, combining their effects. (If you use only the left jack, then you get the effect of DDL-1 only.)

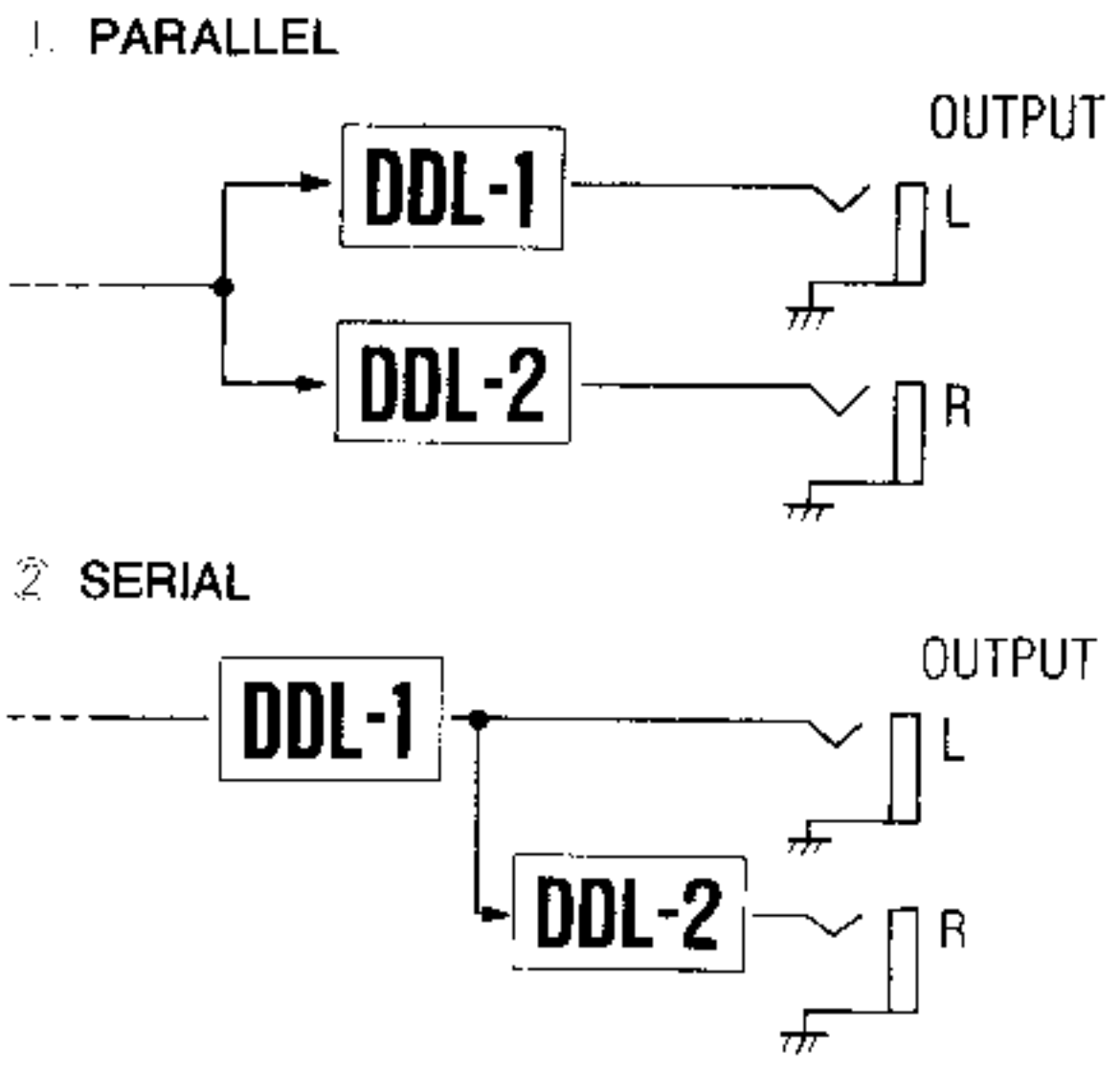

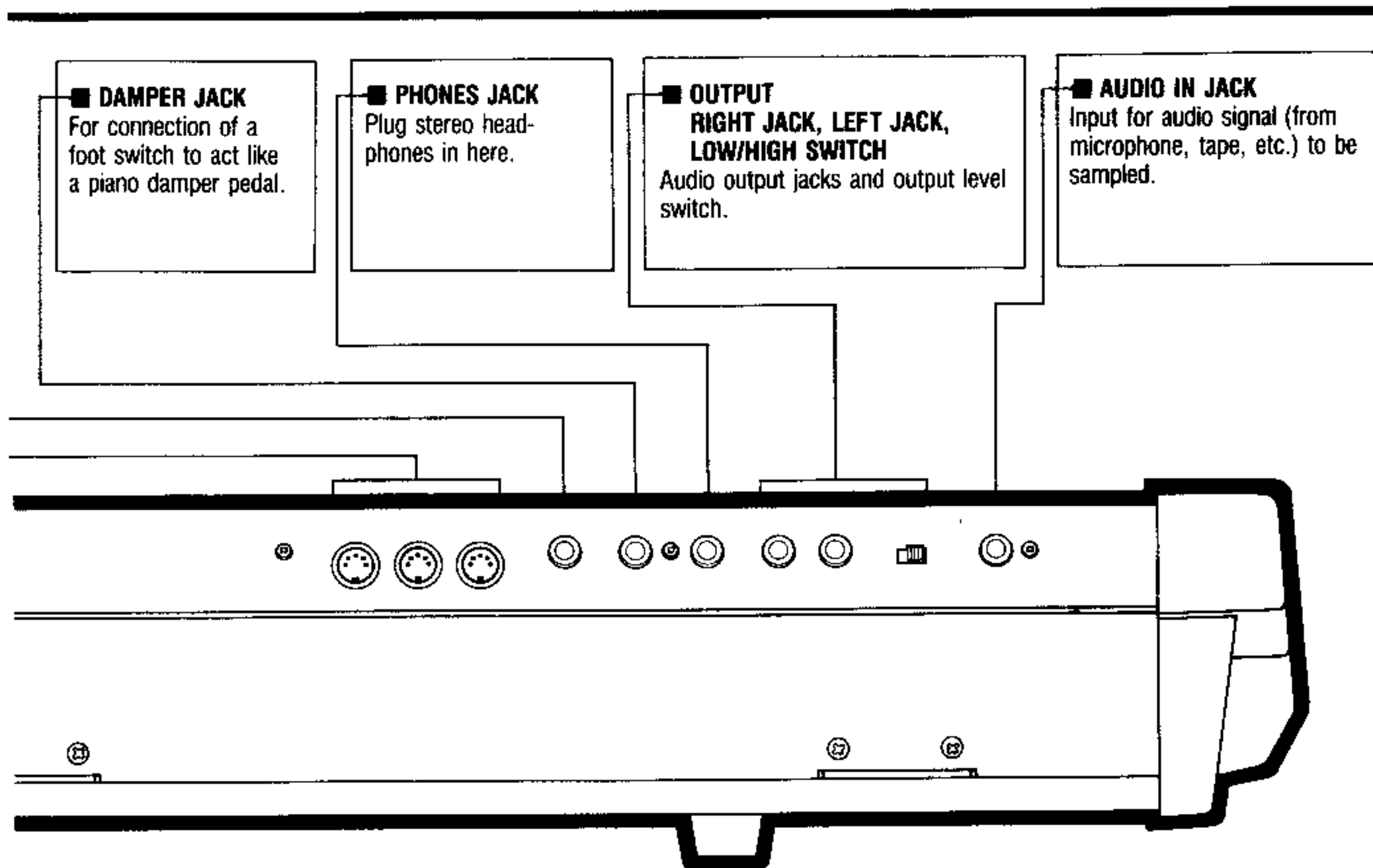

★ The LOW/HIGH switch selects the output level for both the LEFT and RIGHT output jacks. There is a 1:10 ratio between the LOW and HIGH position voltages. Output impedance does not change with switch position. It remains fixed at 10 kohms whether you select LOW or HIGH output level.

	Switch Position	
	LOW	HIGH
Maximum output voltage	About 0.8 V p-p	About 8 V p-p

# 3. Disk Drive & Floppy Disks

## 1. DISK DRIVE

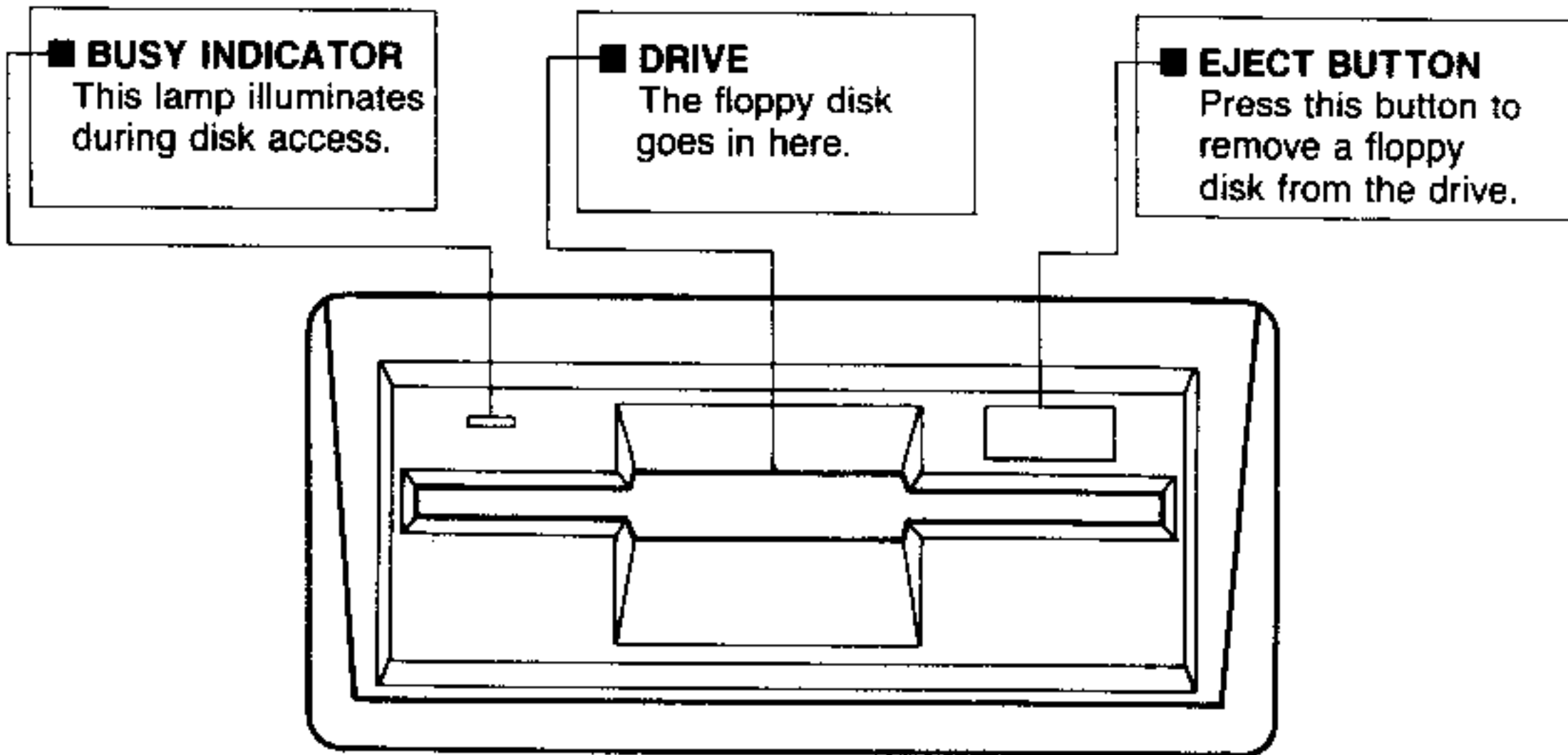

### ■ Inserting a floppy disk

- ① Press the eject button and remove the head protection sheet (inserted when transporting the DSS-1).

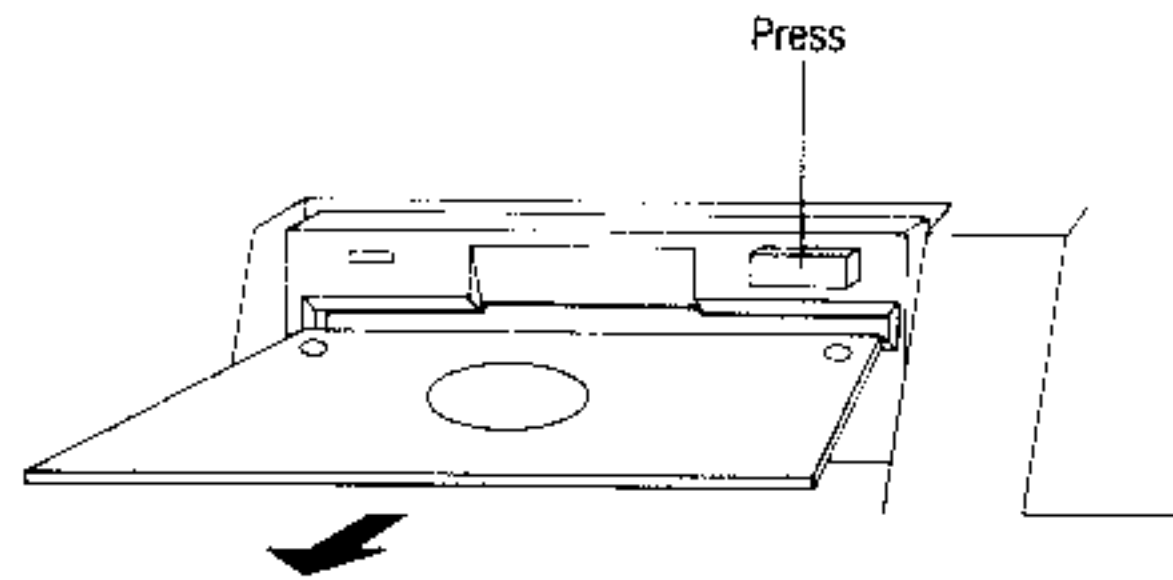

- ② Hold the disk with your thumb on top of the label and insert into the drive. Push in until you hear a click that indicates that the disk is fully inserted.

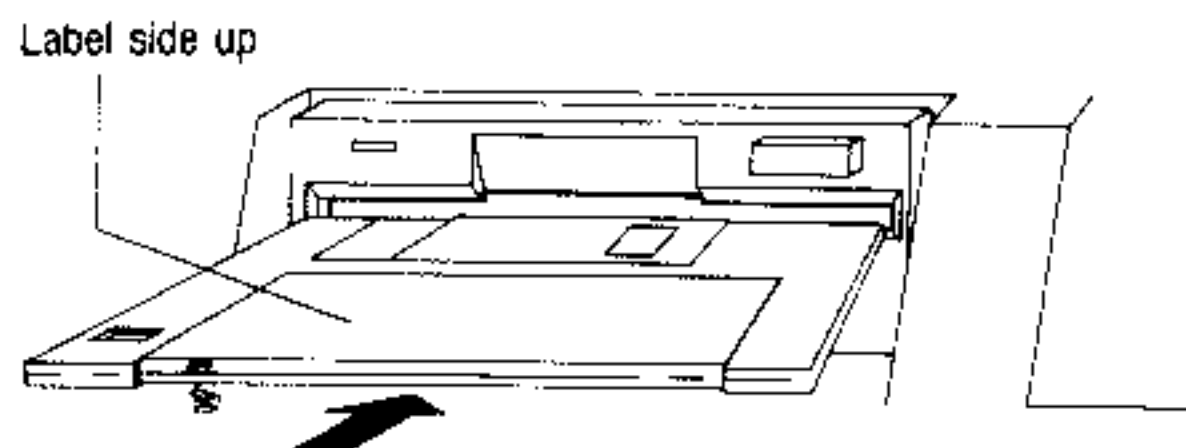

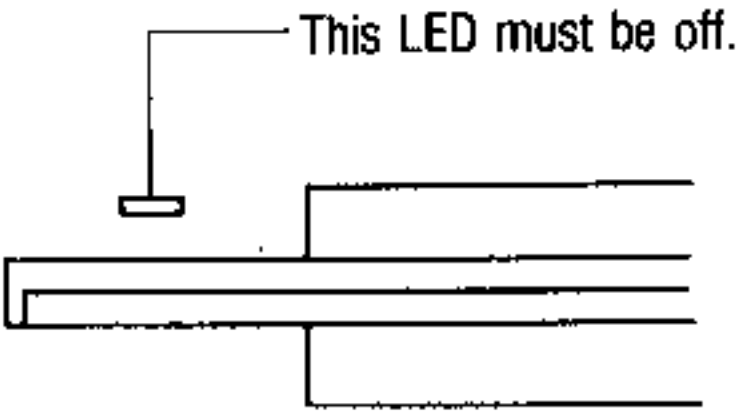
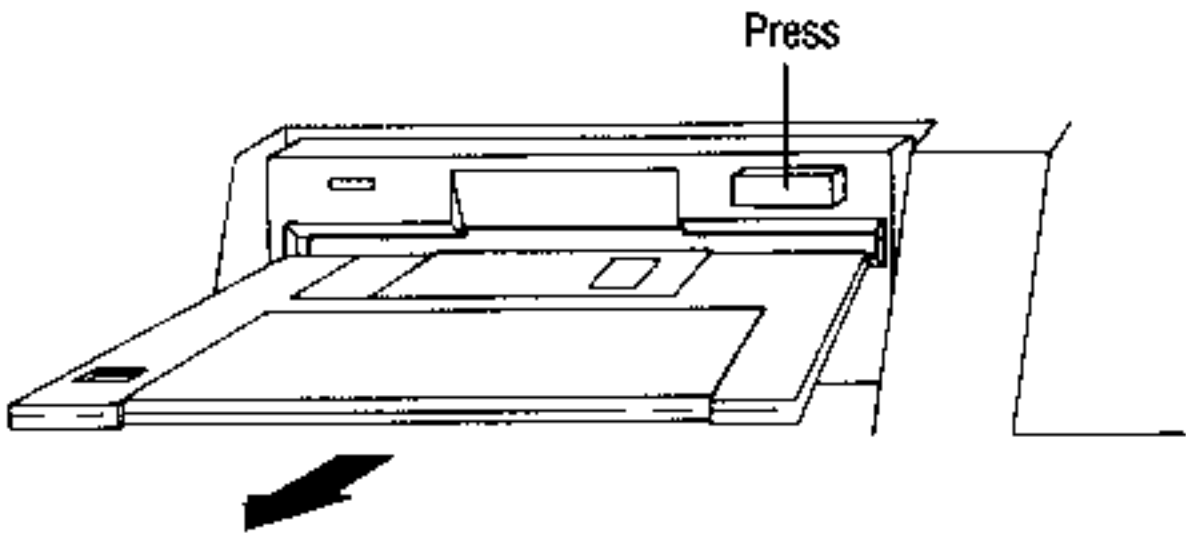

## ■ Removing a floppy disk

<p>① Make sure that the busy indicator lamp is off.</p>	 <p>This LED must be off.</p>
<p>② Press the eject button and remove the disk.</p>	 <p>Press</p>

## ■ Precautions when using the Disk Drive

- ★ Please save the head protection sheet that was in the disk drive. Always remove any disk and put this sheet in the drive before transporting the DSS-1. Store the protection sheet in a clean environment and give it the same care that you would your floppy disks. A dirty protection sheet will harm the drive and damage any floppy disks used thereafter.
- ★ The busy indicator lamp comes on when the head is moving over the disk surface to read or write data. Never remove (eject) a disk or turn off the power while the busy indicator is illuminated. To do so may damage the disk and cause loss of valuable data that is on the disk.

- ★ Always gently insert the disk straight into the slot.

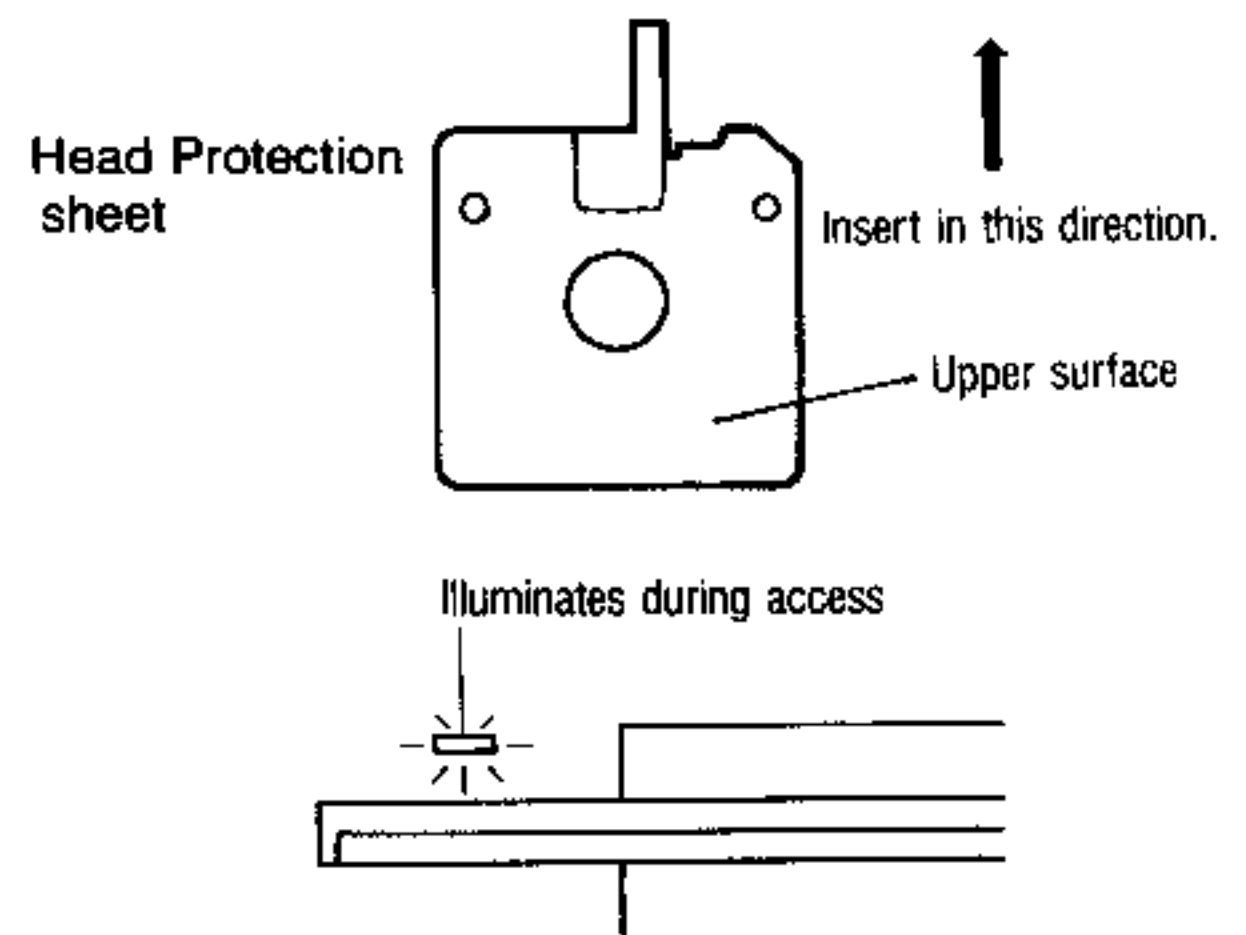

## 2 FLOPPY DISKS

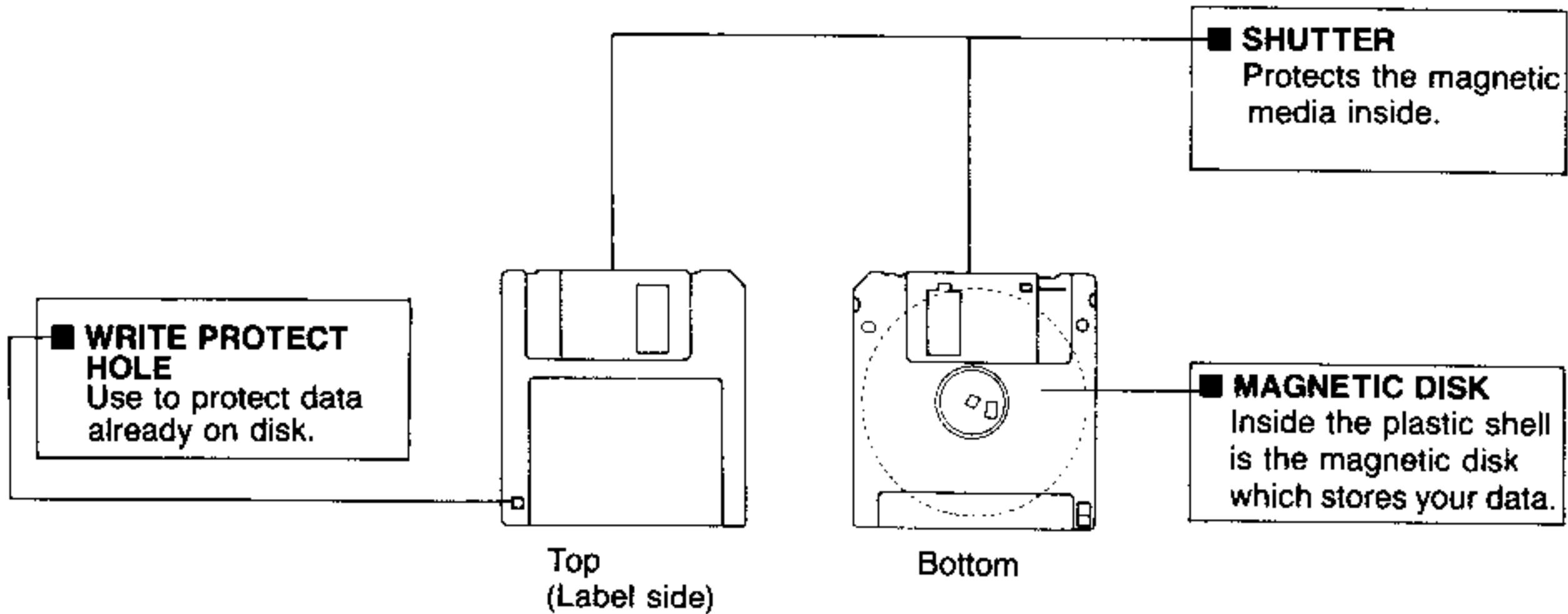

### ■ Care of Floppy Disks

- Do not use or store your disks where they will be exposed to high temperature, high humidity, direct sunlight, dust or dirt.
- Do not open the shutter. To do so exposes the magnetic disk to harmful dust, dirt, and scratches which may prevent correct reading and writing of data.
- Keep away from any source of magnetism including TV sets, speakers, transformers, telephones, and magnets. Magnetic fields will corrupt or erase your data on the disk.
- Never transport the DSS-1 while a disk is in the drive. The head will bounce against the disk, damaging the magnetic disk surface and the head itself. This will cause loss of your data and make the disk unusable.
- Never place anything on top of a floppy disk. The disk may become deformed and unusable.

5 ~ 60°C

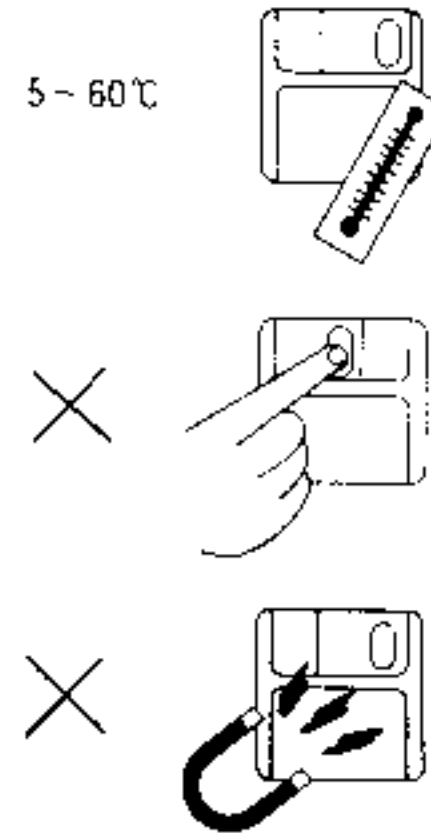

### ■ About the WRITE PROTECT HOLE

- The kind of floppy disk used in the DSS-1 has a "write protect hole" which, when open, prevents you from erasing or changing disk data. Move the tab to open or close the hole as necessary to prevent accidental data loss or to allow changes to be made. Refer to the diagrams here. Be sure that the tab is fully to one side or the other. (It gives a click as it goes into place.)

### ■ Backup Copies

Regularly make backup copies of your disks and store the copies separately. This is your only insurance against accidental erasure or corruption of your valuable data. To make a copy, you get the data from one disk, then write it to a different disk.

#### ★ Write Disable position

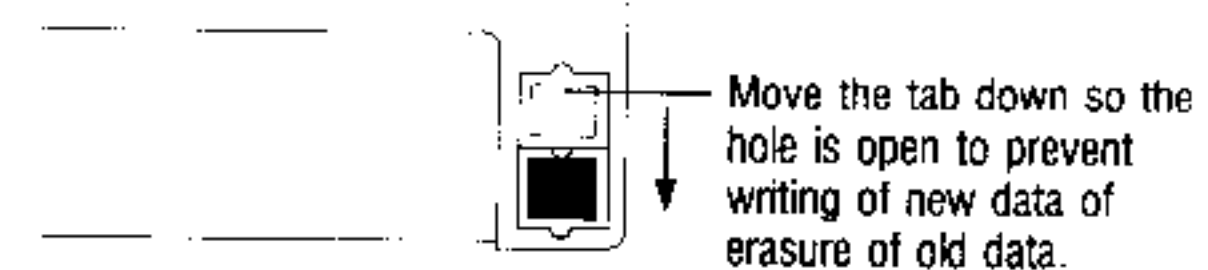

#### ★ Write Enable position

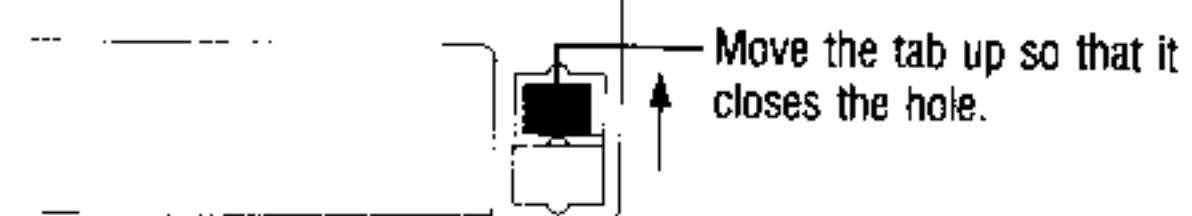

---

■ **Which disks to buy**

- The DSS-1 uses 3.5-inch double sided, double density, double track micro-floppy disks. When you buy more disks, check for a label that says: MF2DD, DOUBLE SIDED, DOUBLE DENSITY, DOUBLE TRACK 135TPI. (TPI means tracks per inch.)

- **Typical label of type of disks usable in the DSS-1**

**MF2DD**

- DOUBLE SIDED
- DOUBLE DENSITY
- DOUBLE TRACK 135TPI

- The following disks are recommended:  
KORG MF-2DD, PANASONIC EBF-MF2DD.
  
- Before using a newly purchased disk you must format it by following the procedure called F0 FORMAT DISK while is detailed in a later section of this manual.

# BEFORE PERFORMANCE

## 1. Basic Setup

- Set up the DSS-1 as described below to enable play.

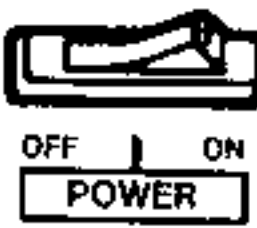
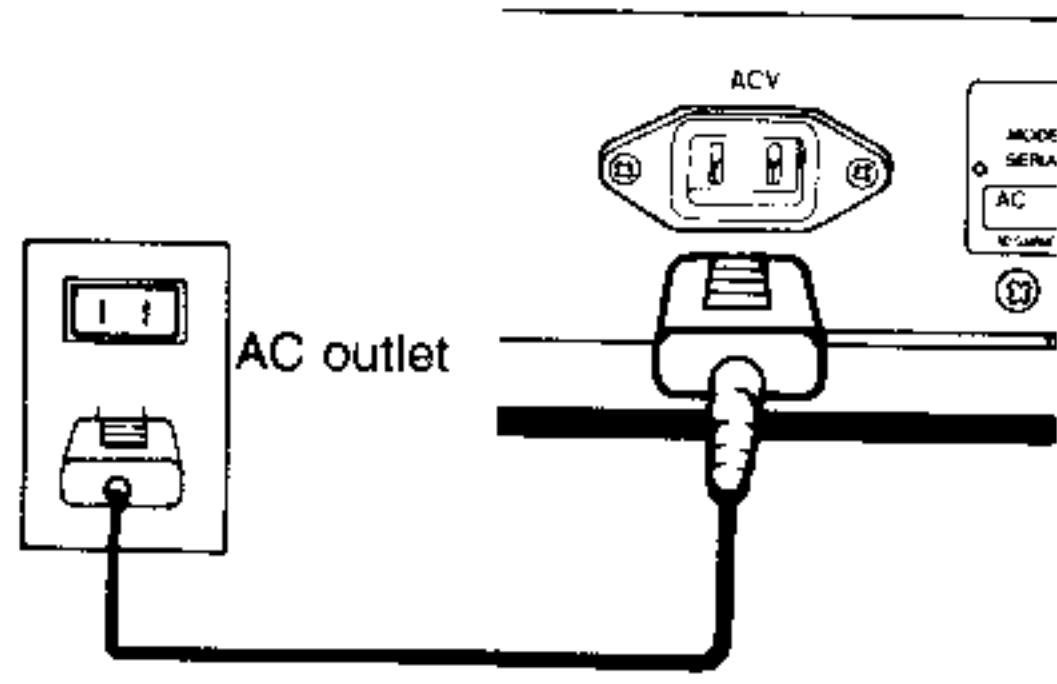
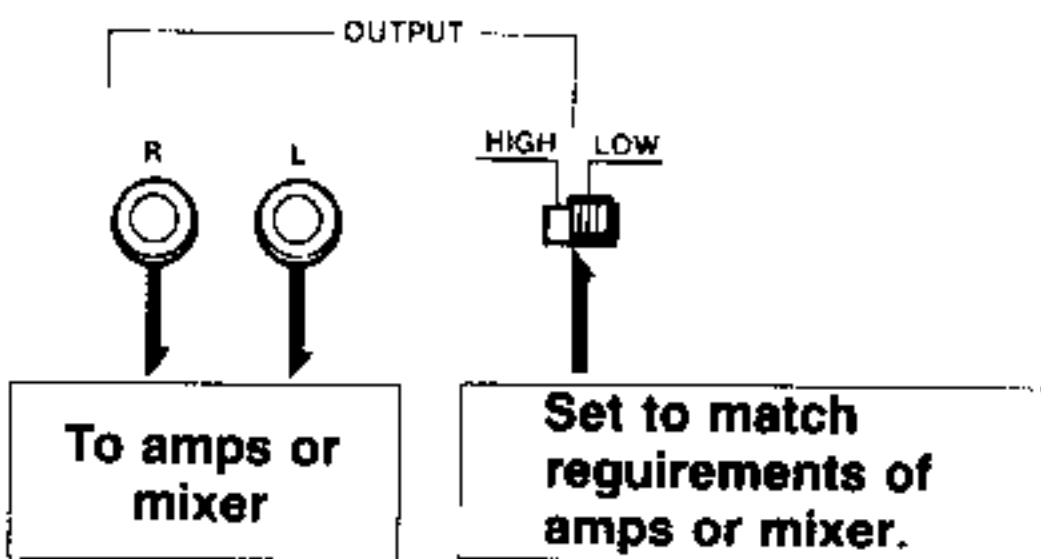
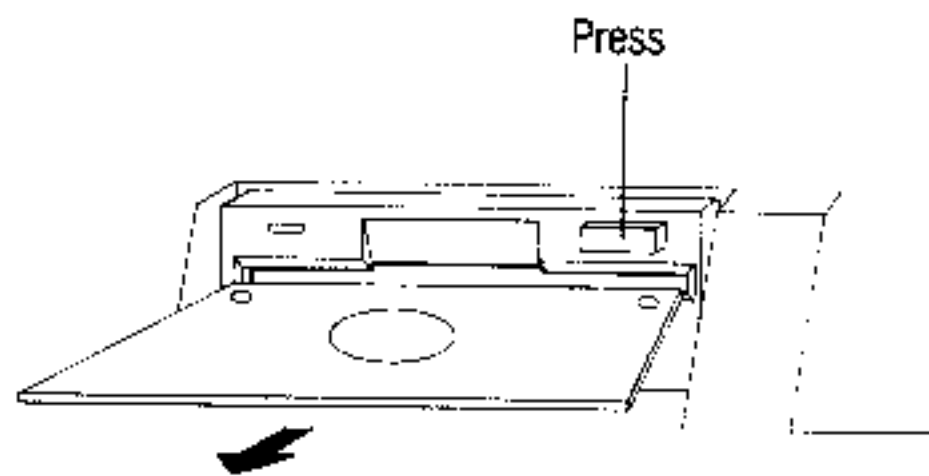
Procedure	Controls/Indicators
<p>① Make sure that the power is turned off on the DSS-1 and all other equipment including amps and mixing consoles.</p>	<p>OFF</p> 
<p>② Use the supplied AC cord to connect the DSS-1 to an AC outlet.</p>	
<p>③ Connect the DSS-1 to amps, mixing console, or other equipment, setting the LOW/HIGH switch as appropriate.</p>	
<p>④ Press the EJECT button on the DSS-1's disk drive and remove the head protection sheet which has been inserted to prevent damage during transport.</p>	

⑤ Turn down the volume all the way on the DSS-1 as well as on the connected amps, mixing consoles, and other equipment. Then turn on the power on the DSS-1 and other equipment.

★ The display will appear as shown here. After about seven seconds it will change as the DSS-1 enters the SYSTEM MODE.

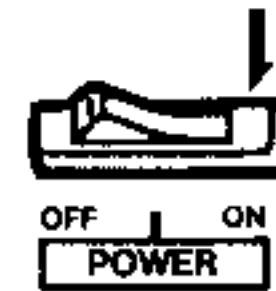

\*\*\* KORG DSS-1 \*\*\*  
SAMPLING SYNTHESIZER



\*\*\* SYSTEM MODE \*\*\*  
Select (1-9): \_

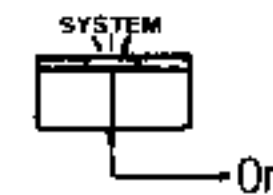

# 2. Basic Operation

1 This lets you select sound patches from the disk and play them.

■ The internal memory of the DSS-1 can hold up to 32 sound patch programs at once. During play, you select from among these 32 sounds, changing from one to another as you like.

Before play, you must load a set of 32 sound patch programs from disk into memory. Each of these sets is called a "system."

■ One floppy disk can hold four "systems" of 32 sounds each. (That means that you can have  $4 \times 32 = 128$  patches per disk.)

To load data from disk to internal memory, you must choose which one of these four systems to load.

■ "GET SYSTEM" is the name of the procedure that you use to select and load one of these four systems from a particular disk to internal memory.

"PROGRAM SELECT" is the name of the procedure used to select and use one of the 32 sound patch programs from the system that is currently in memory.

■ Therefore, to play a sound that is on disk, you first choose the disk, then you choose a system and get it (load it) from disk to internal memory. Finally you select a program from among the 32 in the loaded system.

ONE DISK

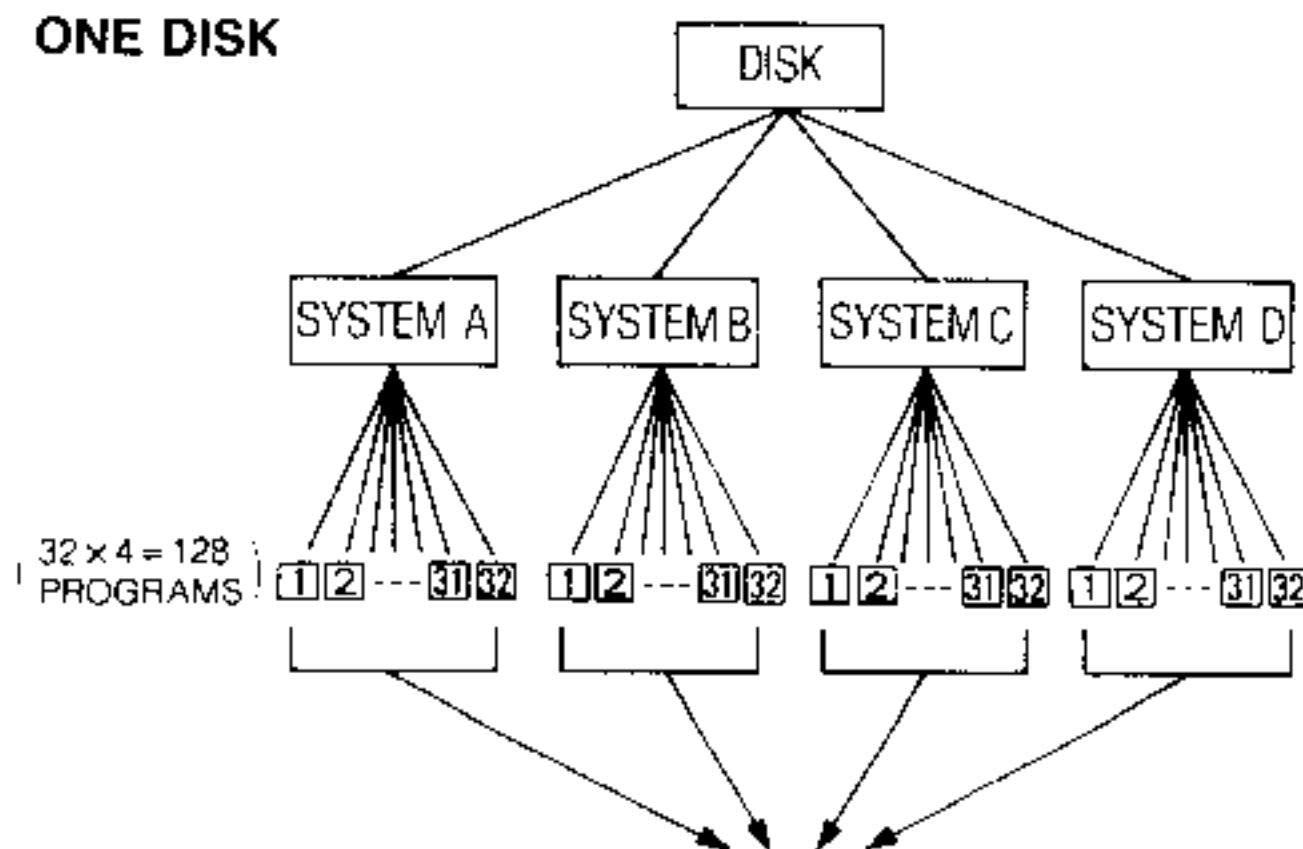

**GET SYSTEM:** Lets you choose one of the four systems on a disk and load it to memory.

**DSS-1 MEMORY:**

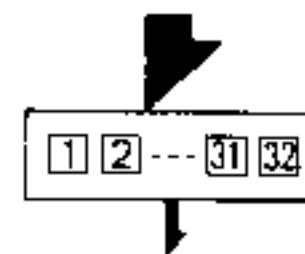

**PROGRAM SELECT:** Lets you select one of the 32 patches (tone color programs) from memory.

2 Modes used for GET SYSTEM and PROGRAM SELECT

■ The GET SYSTEM procedure can be performed when the DSS-1 is in the SYSTEM mode. When the SYSTEM mode is selected, the SYSTEM key LED illuminates.

(When the DSS-1 power is turned on, the SYSTEM mode is selected automatically as the default mode.)

■ The PROGRAM SELECT procedure is performed in the PLAY mode. The DSS-1 is in the PLAY mode when none of the mode selector key LEDs are on.

To switch to the play mode, press the mode selector key which is currently selected, so that its LED goes out. (The play mode is selected when the eight modes listed on the front panel are all cancelled.)

● When SYSTEM mode is selected.

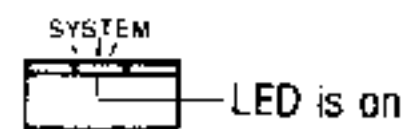

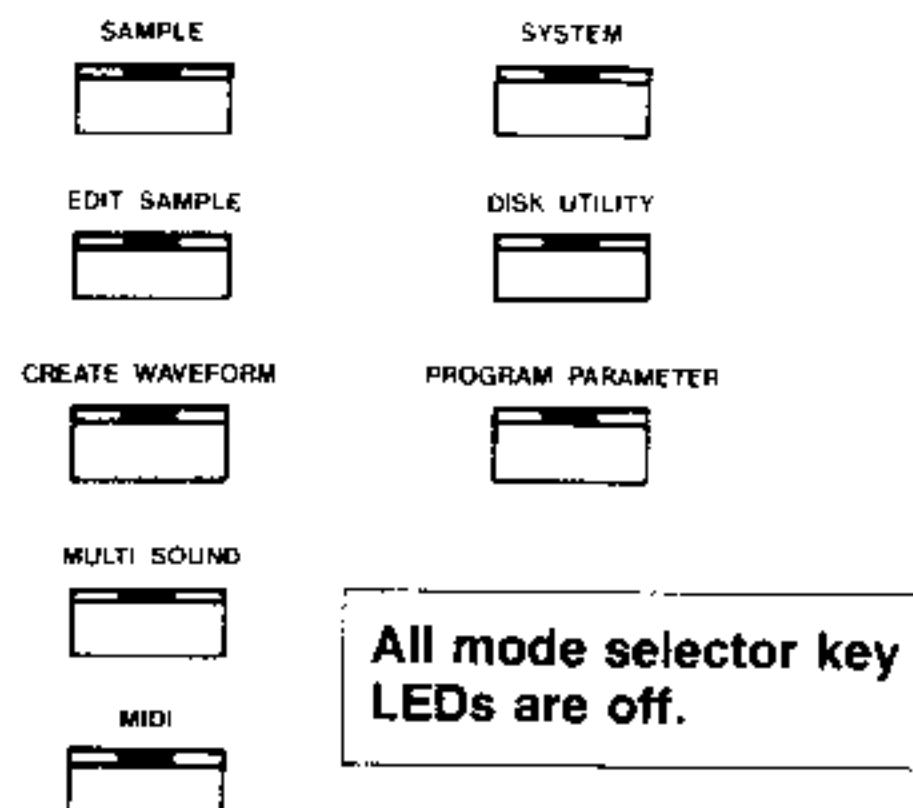

● When play mode is selected.

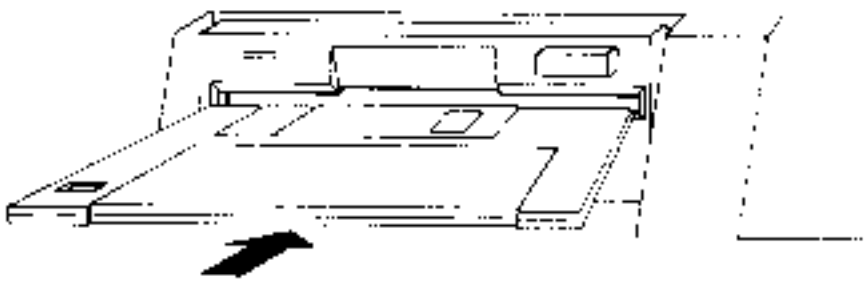
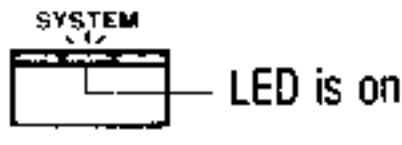

### 3. Get System & Program Select Procedures

- Let's now try getting a system of the supplied disk and then selecting a program to use for playing the keyboard. First prepare to begin as described in the Basic Setup section. Then follow the steps below.

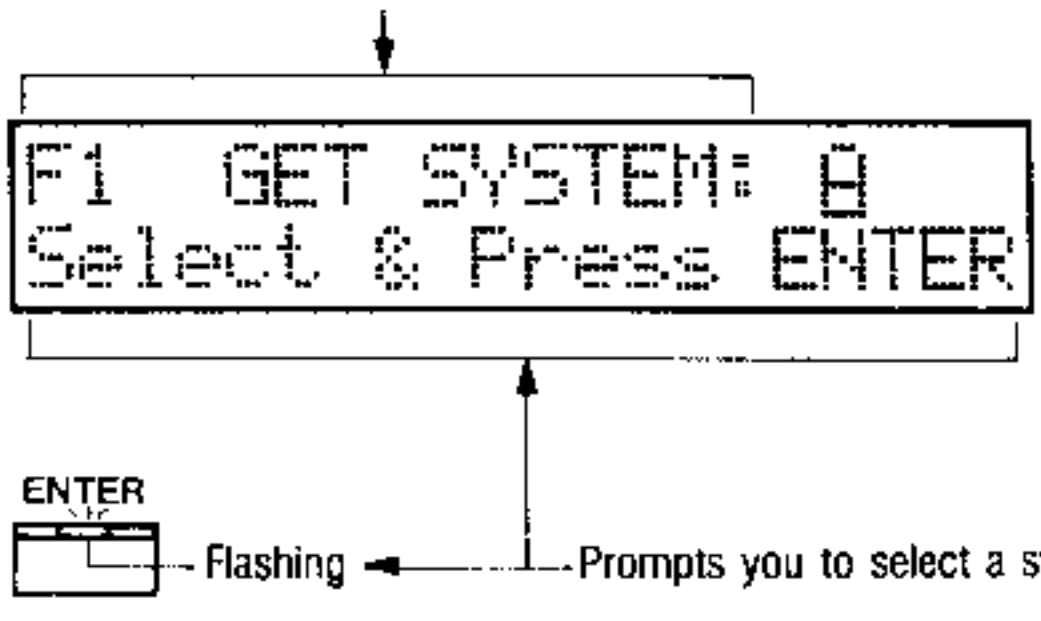
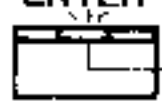
Operation	Operation of DSS-1
<p>① Insert the disk in the drive.</p> 	
<p>② Confirm that the SYSTEM mode is selected. Check to see that the SYSTEM mode key LED is illuminated.</p>	<ul style="list-style-type: none"> <li>When in the SYSTEM Mode.</li> </ul> 
<p>③ To select the GET SYSTEM function, press the number 1 key on the 10-key pad.</p> <p>Press  </p>	<ul style="list-style-type: none"> <li>The display confirms the GET SYSTEM function and asks you to select from one of the four systems on the disk.</li> </ul> <p>Indicates GET SYSTEM function.</p>  <p>ENTER  - Flashing ← Prompts you to select a system.</p>

- 4 There are four systems per disk. These are named A, B, C, and D. Use the DATA ENTRY A to select one of these systems.

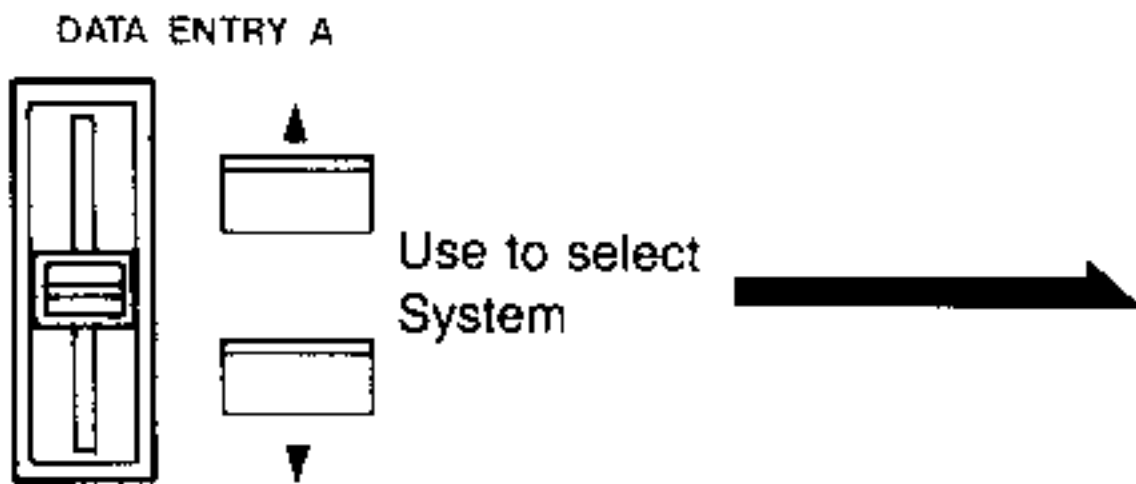

Currently selected system.

```
F1 GET  SYSTEM:A
Select & Press ENTER
```

- 5 After selecting a system press the ENTER key. Press to input selection.



- You are now asked to confirm your selection.

System that you chose.

```
F1 GET  SYSTEM:A
Are You Sure? (Y/N)
```

Prompt.

- 6 Press the YES key to confirm your choice.



- This makes the DSS-1 proceed to load your selected system from the disk to the internal memory. This takes a while to complete.

```
F1  Loading...
Please Wait a Minute
```

After loading, it confirms completion.

Shows the name of loaded system.

```
F1 SYS:A Completed
Select (1-9):
```



⑦ To allow selection of a particular patch or "program", you need to go to the PLAY mode. This requires pressing the SYSTEM key to cancel the SYSTEM mode and extinguish its LED.

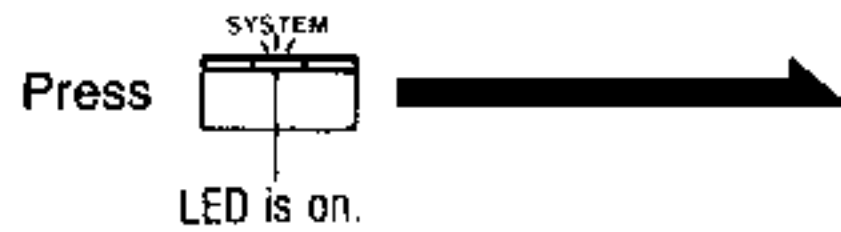

● Cancels SYSTEM mode and switches DSS-1 to PLAY mode.

When SYSTEM mode is cancelled.



Display for PLAY mode:

SYSA P01: ABCDEFGH

⑧ There are several ways to select a program. You can use the up/down arrow keys (marked with triangles) by the DATA ENTRY A or B sliders. Or you can use the 10-key pad to enter a two digit number between 01 and 32 (inclusive).

Use these up/down arrow keys.



or

Or use the ten number keys (0~9).

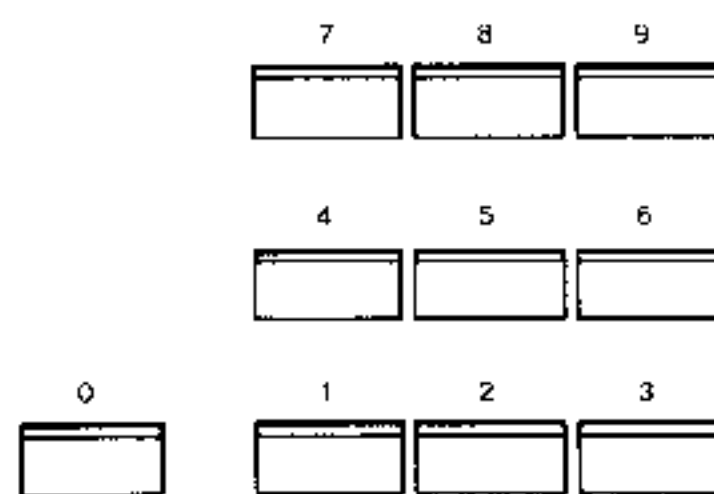

Use to select Program



The loaded system (A, B, C, or D)

The selected program number.

The selected program name.

SYSA P01: ABCDEFGH

⑨ To get a program from a different system, press the SYSTEM mode key to return to the SYSTEM mode. Then proceed from step ⑦ above.

If the sound you want is on a different disk, first go back to the SYSTEM mode, eject the current disk, and insert the desired disk.

- When using the ten number keys (10-key pad) to select a program, be sure to always enter the number as two digits. That is, program numbers one through nine must be specified as 01, 02, 03, and so on.

If you input an "illegal" number such as 00 or 34, then the DSS-1 ignores the second digit and keeps waiting until you enter a second digit that is a valid program number. In this case you can return to the previously selected program number by pressing the DELETE/CANCEL key.

- **Example:** To select program number three.

Press   Then press

- **Example:** If you try to select number 34.

The second digit is ignored and the DSS-1 keeps waiting for valid input.

The previously selected program name remains in the readout.

SYS9 P3\_ : ABCDEFGH

You can still press

To return to the previously selected program number.

SYS9 P01 : ABCDEFGH

- It takes about half a second after selecting a program until that patch can actually be played.

# 3. Performance Functions

---

## 1 Joystick

- For control of pitch bends, vibrato, filter modulation (wah-wah), and other effects while playing.

- Left-right movement (horizontal axis) can produce upward and downward pitch bends (of all notes played) and can control the VCF cutoff frequency to change the tone color. Upward movement produces vibrato, by modulating the oscillator frequency. Downward movement produces a cyclic wah-wah effect by modulation of the VCF filter cutoff frequency.

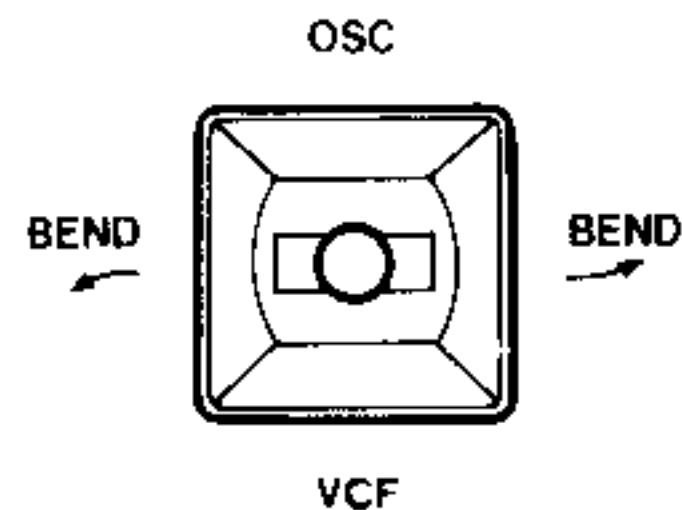

- The operation of these effects depends in part on the program being used. Some parameters in a patch will affect these functions.

## 2 Initial Touch

- The DSS-1 has programmable initial touch. This lets you control things like volume, tone color, pitch change, and attack, according to how fast or "hard" you play the keys.

- The effect produced depends on your patch parameter values.

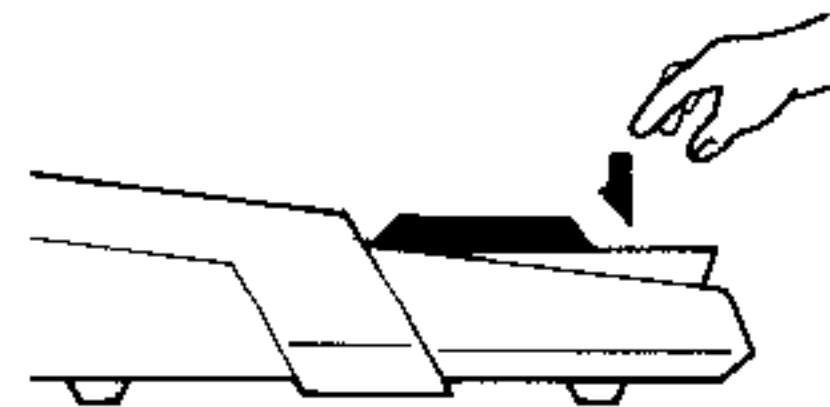

## 3 After Touch

- The DSS-1 has programmable after touch. This is accessed by pressing down on keys after playing them. After touch can be programmed to control vibrato depth, volume, brightness, and other aspects of the sound.

- The effect produced depends on your patch parameter values.

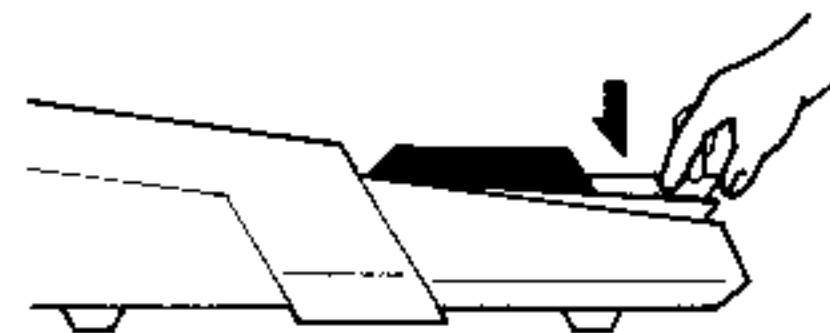

#### 4] Key Transpose

■ This lets you shift the whole keyboard pitch up or down in semitone steps, a valuable feature for playing music intended for other instruments or for avoiding difficult keys. You can transpose upward by up to 5 semitones and downward by up to 6 semitones.

■ Key transpose is set in the play mode, using the enter key and keys on the keyboard in relation to C. Press any key up to F above C or F# below C. (Any C will do.) You transpose up by pressing any key from C# to F, giving you a range of +1 to +5 semitones. You transpose down by pressing any key from B to F#, giving you a range of -1 to -6 semitones. The C key itself cancels the transpose effect (since it transposes by 0).

The current value of the transpose parameter is shown on the display as a tone name from F# to F.

#### ● Example: Transposing up 2 semitones.

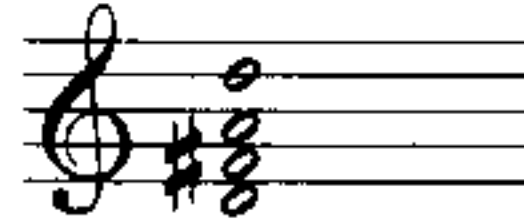

When you play a D chord...

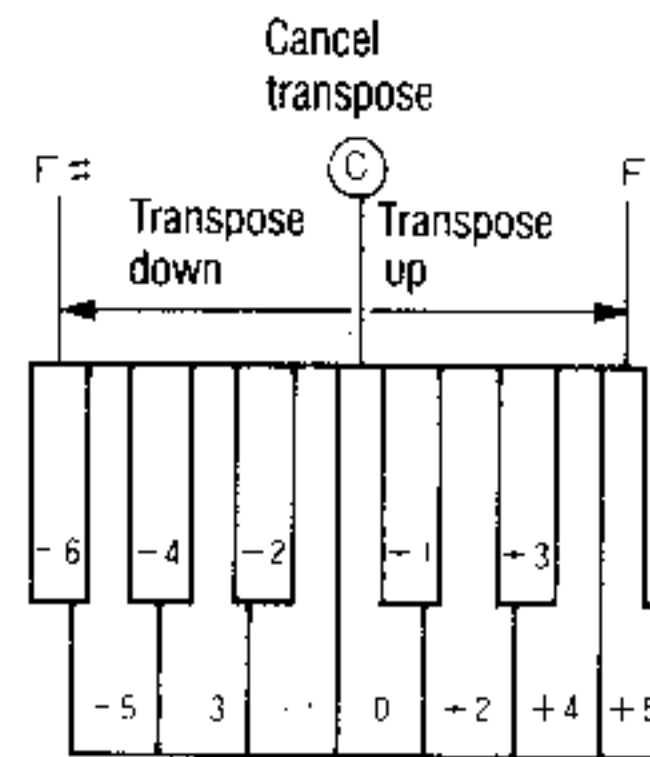
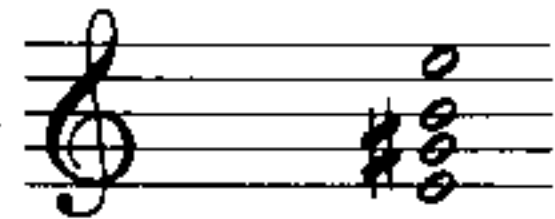

You hear an E chord.



#### ■ Procedure for using transpose:

Operation	Operation of DSS-1
<p>① Confirm that the unit is in the play mode.</p>	
<p>② Press the enter key.</p> <p>Press  </p>	<p>● Current transpose value is displayed and you are prompted to press a key together with the enter key.</p> <p>(Here the transpose value is C.)</p>

- ③ While holding down the enter key, press any key on the keyboard.

Hold down 

Press  and Release 

- The value changes according to the key that you played. The display confirms the change, if any.

(Here F# was played so there is a six semitone downward transposition.)

- ④ Release the enter key.

Release  

- This brings you back to the normal play mode. The letters TR appear on the display to confirm the use of the transpose function.



- Transpose is effective only in the play mode. Transpose is cancelled if you switch out of the play mode.
- With some patches, you may find that if you transpose upward, you may not get any sound from some of the upper keys since you have exceeded the pitch range.

5 **Damper**

■ An optional foot switch such as the PS-1 or DS-1 may be connected to the rear panel damper jack to serve as a damper pedal like that on a piano. Depending on the program, this can also be used to obtain a hold effect (so that a note is held for as long as you press on the foot switch, even if you release the key on the keyboard).

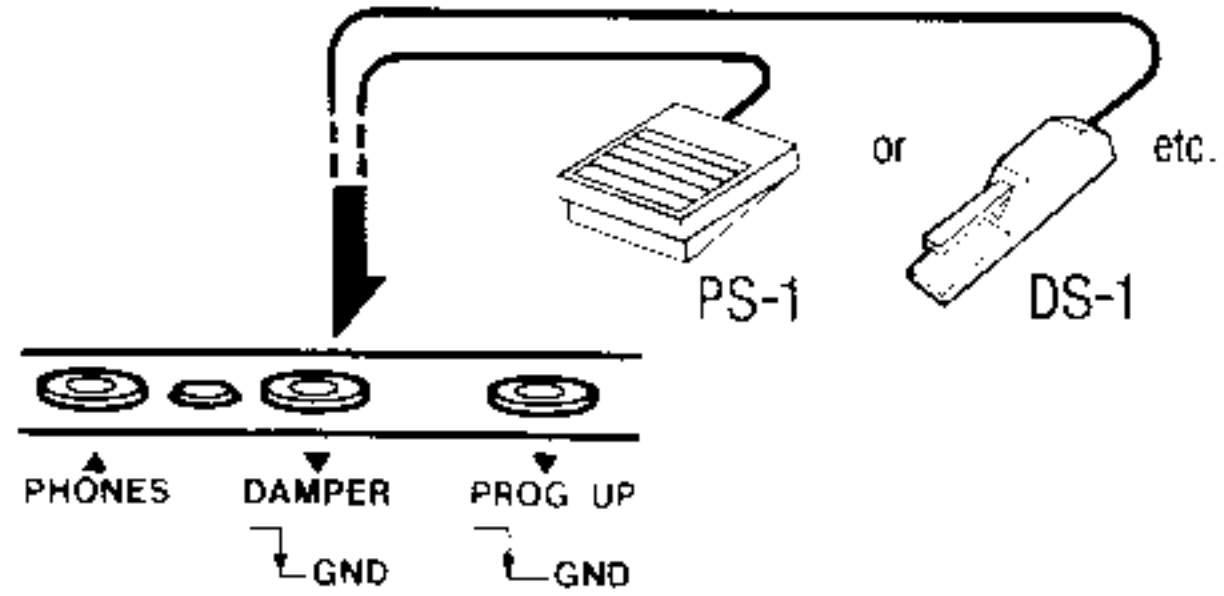

6 **Program up**

■ You may connect an optional foot switch such as the PS-1 to the rear panel program up jack. Then each time you press the foot switch, the program number (patch number) will advance by one.

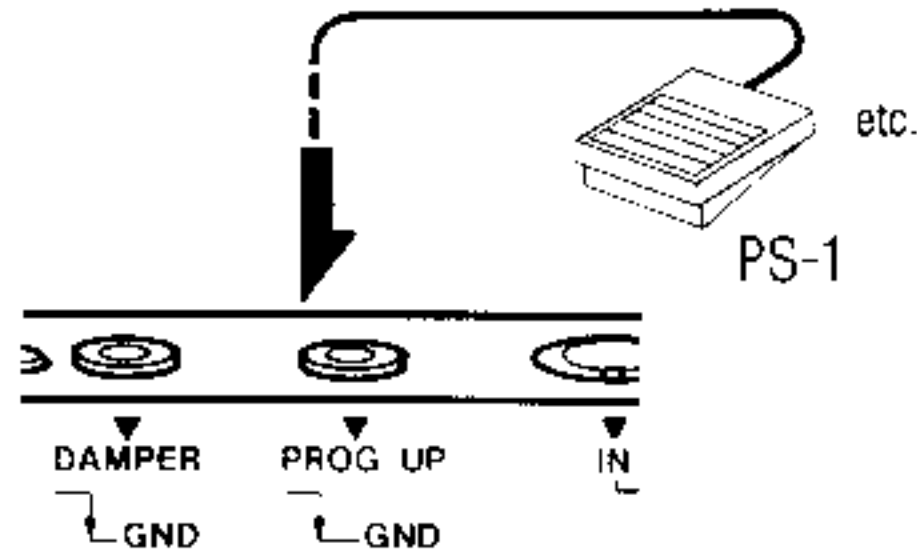

■ Note that after program 32, you loop back around to program 01 again.

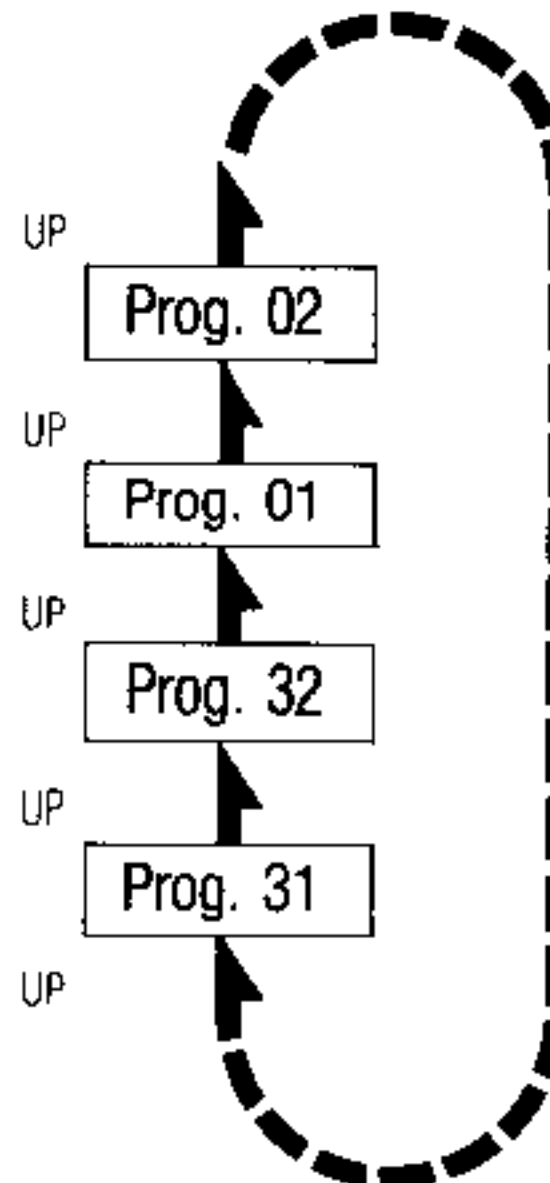

# CREATING SOUNDS

## 1. Sound Synthesis Concepts

### 1] Basic arrangement of the DSS-1 and how it affects the sound.

■ As in a traditional analog synthesizer, the DSS-1 gives you the convenience of a subtractive technique whereby the oscillators provide an audio signal which is processed by the VCF and VCA.

This lets you consider the sound in terms of three basic components which are pitch, timbre (or tone color), and volume (or dynamics).

### ● Basic configuration of DSS-1

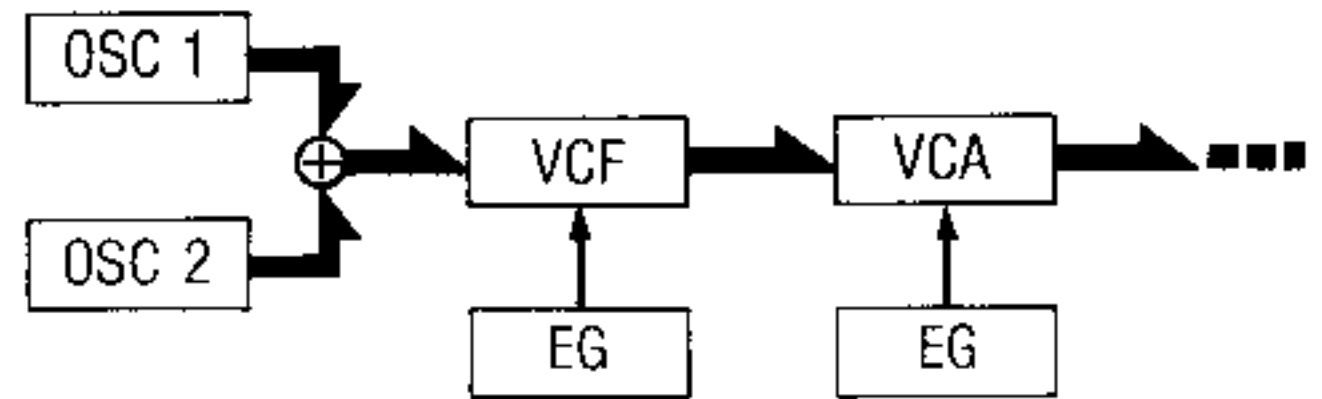

■ However, the DSS-1 is completely different from conventional subtractive synthesizers when it comes to the source of the waveforms output by the oscillators. Conventional analog synths only give you a few fixed waveforms such as square waves and sawtooth waves. With the DSS-1 you can use virtually any waveform as the oscillator waveform. This gives you incredible freedom and flexibility to create the sounds that you want.

### ● Synthesis with the DSS-1.

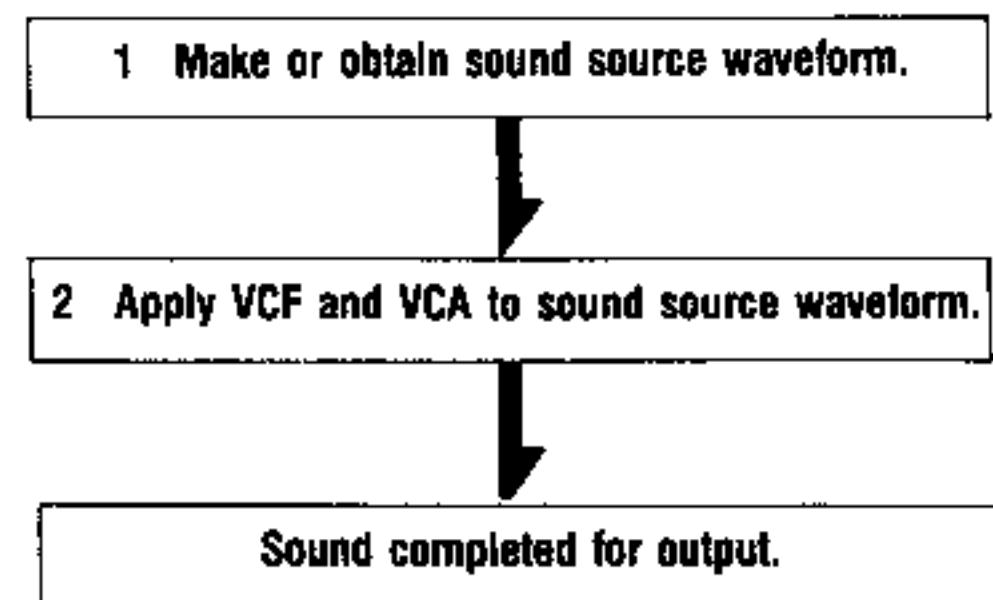

## 2. The sound source (multisounds) of the DSS-1.

- The DSS-1 stores its waveforms as digital data in memory. When a sound is to be used, the data is read from this "wave memory" and converted into an analog signal which is output by the oscillator. Actually, data for several different waveforms is used, since the waveform reproduced depends on the area of the keyboard being played. This gives us the idea of "multisound."

### ● DSS-1 sound sources (1)

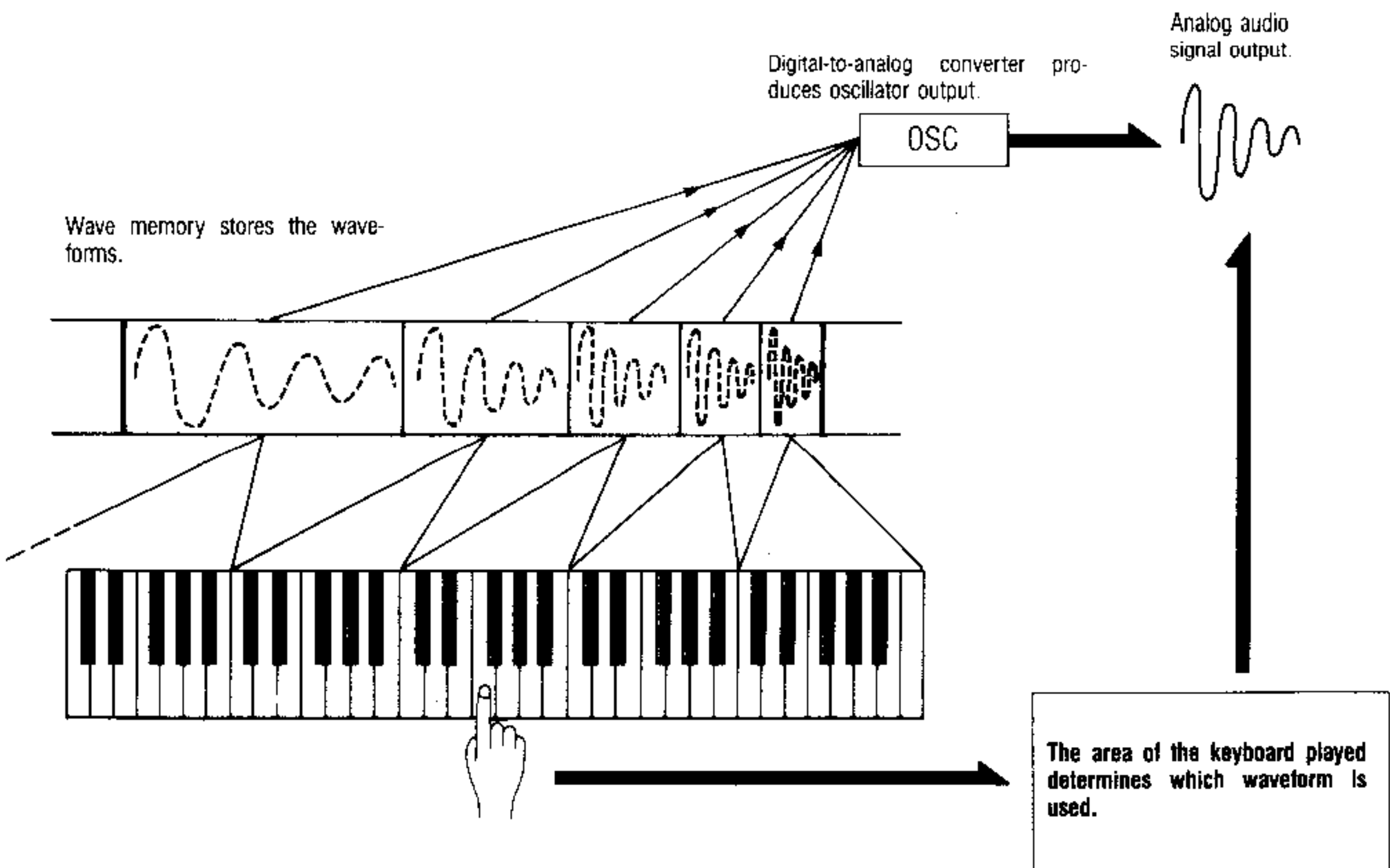

The supplied demonstration disk lets you hear how the sound changes according to waveform assignments across the keyboard.



- The way that the waveform is read out of memory and processed before conversion to analog form is affected by a number of parameters that give you fine editing control over the sound. These include: LOOP ON/OFF, LOOP START & LENGTH, SOUND START & LENGTH, ORG/TOP, TR/NT, and so on. (For details on these parameters see page 39~.) Note that the loop on/off parameter is set to "on" for almost all of the sounds on the supplied disk.

- **Example: LOOP ON/OFF, LOOP START & LENGTH parameters**

i) With loop off:

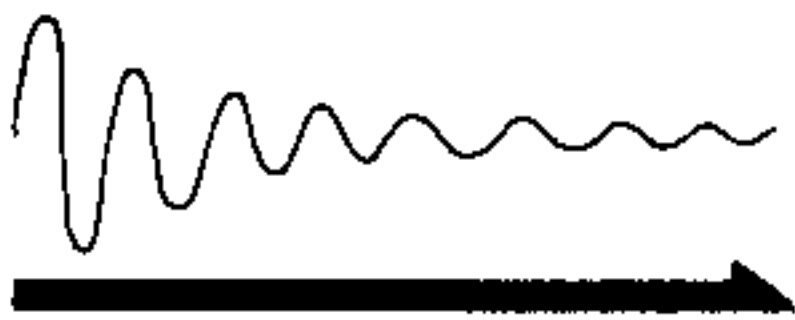

The data is read only once; it is not repeated.

- As we have described, the DSS-1 sound sources are produced by several waveforms assigned to particular portions of the keyboard and the way that these waveforms are read from memory is determined by a number of parameters. We use the term "multisound" to refer to the complete sound source produced by the DSS-1. We use the term "sound" to refer to each one of the waveforms assigned to the keyboard. The term "multisound parameters" refers to the parameters which control how the waveform data is read from memory. To repeat, the "multisound" sound sources of the DSS-1 comprise the sounds assigned to the keyboard and the multisound parameters which control the way they are retrieved.

- **DSS-1 sound sources (2)**

Parameters that control the retrieval of digital waveform data:

LOOP ON/OFF, LOOP START & LENGTH  
SOUND START & LENGTH  
ORG/TOP, TR/NT  
TUNE/LEVEL/fc

ii) With loop on:

The data is read repeatedly according to the values specified in the LOOP START & LENGTH parameter.

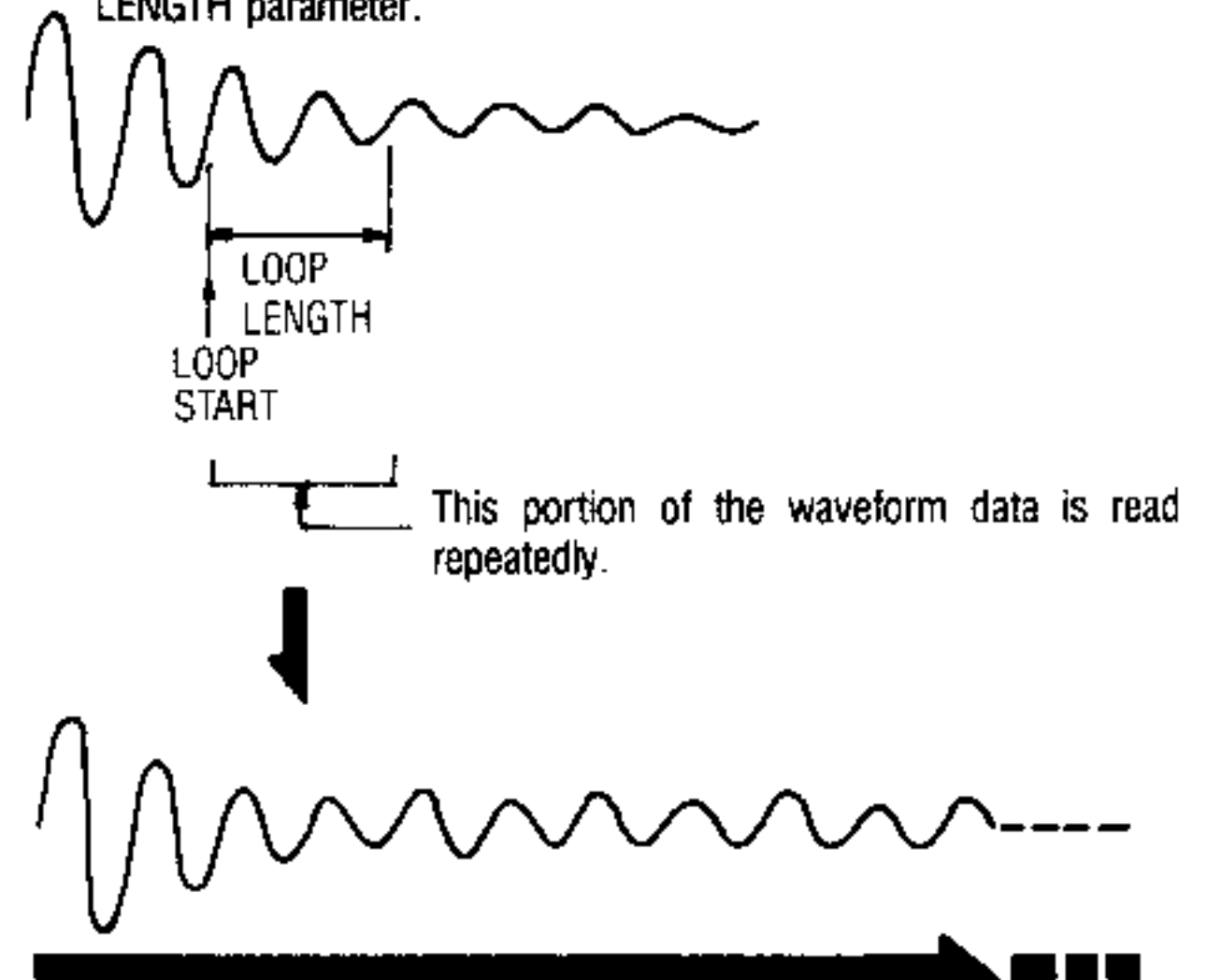

- **DSS-1 multisound concepts**

**Multisound**

- **Sounds assigned to the keyboard**

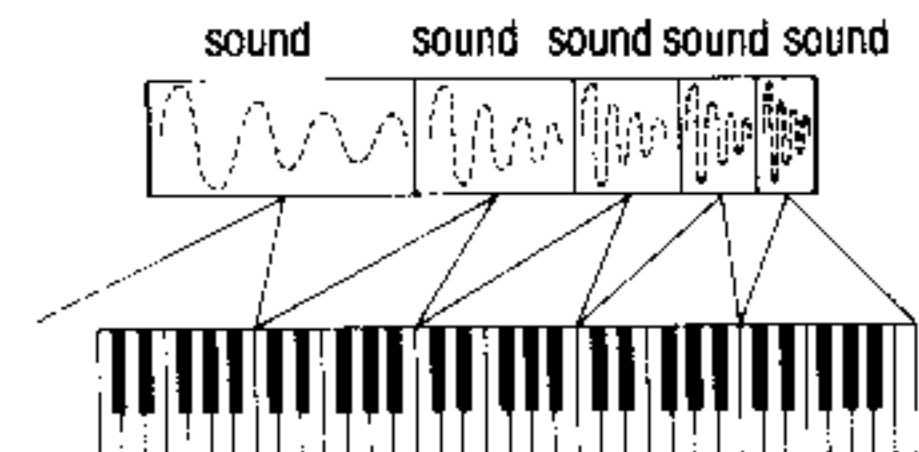

+

- **The multisound parameters that determine how the data for these sounds are retrieved from memory.**

LOOP ON/OFF, LOOP START & LENGTH  
SOUND START & LENGTH  
ORG/TOP, TR/NT  
TUNE/LEVEL/fc

### 3: Making multisounds

■ We now know that the DSS-1 multisounds are made up of a number of sounds assigned to sections of the keyboard together with the multisound parameters that control how the sound data is read from memory. To obtain an individual sound you can sample an actual sound (from a microphone or tape) or you can create a new sound. Then you can edit the sound. Therefore, the DSS-1 offers you functions for (1) sampling sounds, (2) creating sounds, and (3) editing sounds.

To make a multisound, we can see that there are two broad categories of processes involved. First, there is the matter of obtaining the sounds that form the raw materials for the multisound — that means using the sampling, creating, and editing functions that we just mentioned. Second, we must assign the sounds to the keyboard and then edit them with the multisound parameters.

- Two groups of tasks involved in making a multisound:

i) As its name implies, a multisound is made up of several individual sounds.  
( These sounds can be made by first sampling or creating new waveforms and then editing them. )

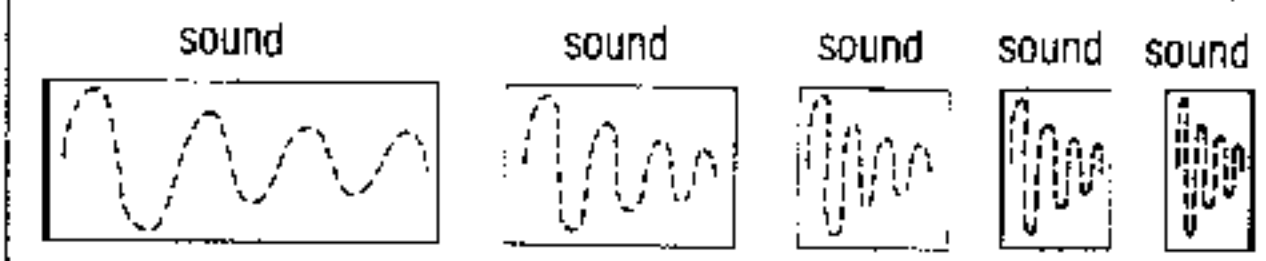

ii) Editing the sounds and finishing the multisound.  
( Assigning the sounds to the keyboard and setting the multisound parameter values. )

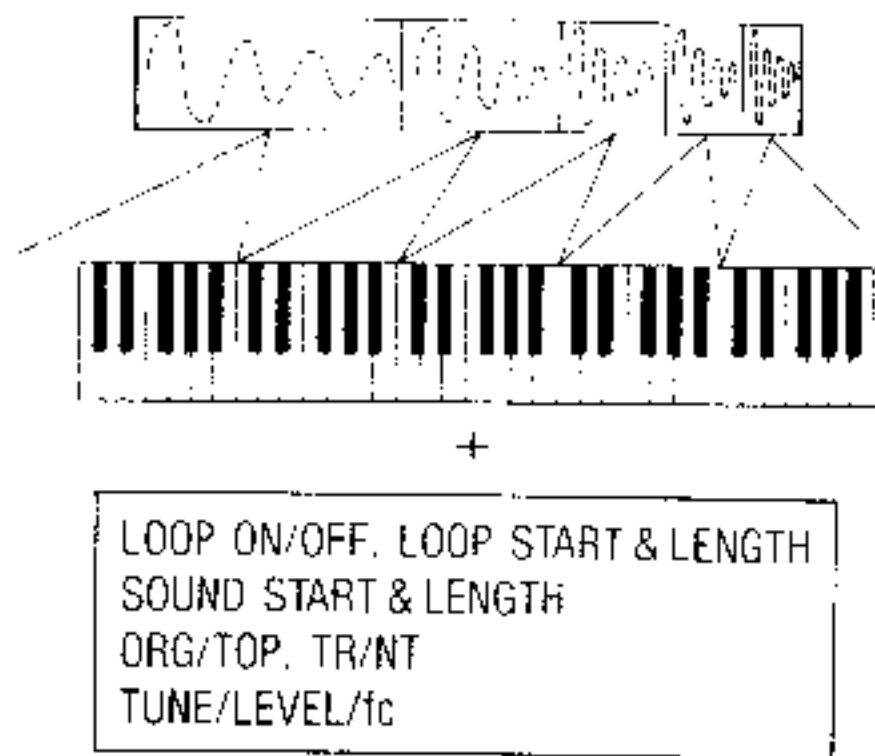

Results in one multisound.

■ In the following sections we will cover these two aspects of the sound creation process in detail. These sections are "2. MAKING THE RAW MATERIALS FOR MULTISOUND" and "3. COMPLETING YOUR MULTISOUND."

Reading these will give you more of an idea of the possibilities for sound synthesis with this instrument.

# 2. Making the Raw Materials (sounds) for a Multisound

## T Sampling

- This function lets you take a sound signal from outside the synthesizer and store its waveform data in memory. The sampled sound becomes the raw material or "sound" for synthesis, but it can also be used as is, right away. Sampling is the method to use if you want a real musical instrument sound. It lets you accurately reproduce complex harmonic changes, like those that occur in the attack of piano notes.
- This is a digital recording technique like that used in compact discs and digital delay devices. This works by taking discrete samples or "snapshots" of an actual sound signal, many thousands of times per second (as determined by the sampling frequency). The level of the signal in each sample is measured and stored as digital data in wave memory.

● The sampling function



Takes an actual sound signal and stores it as digital data in wave memory.

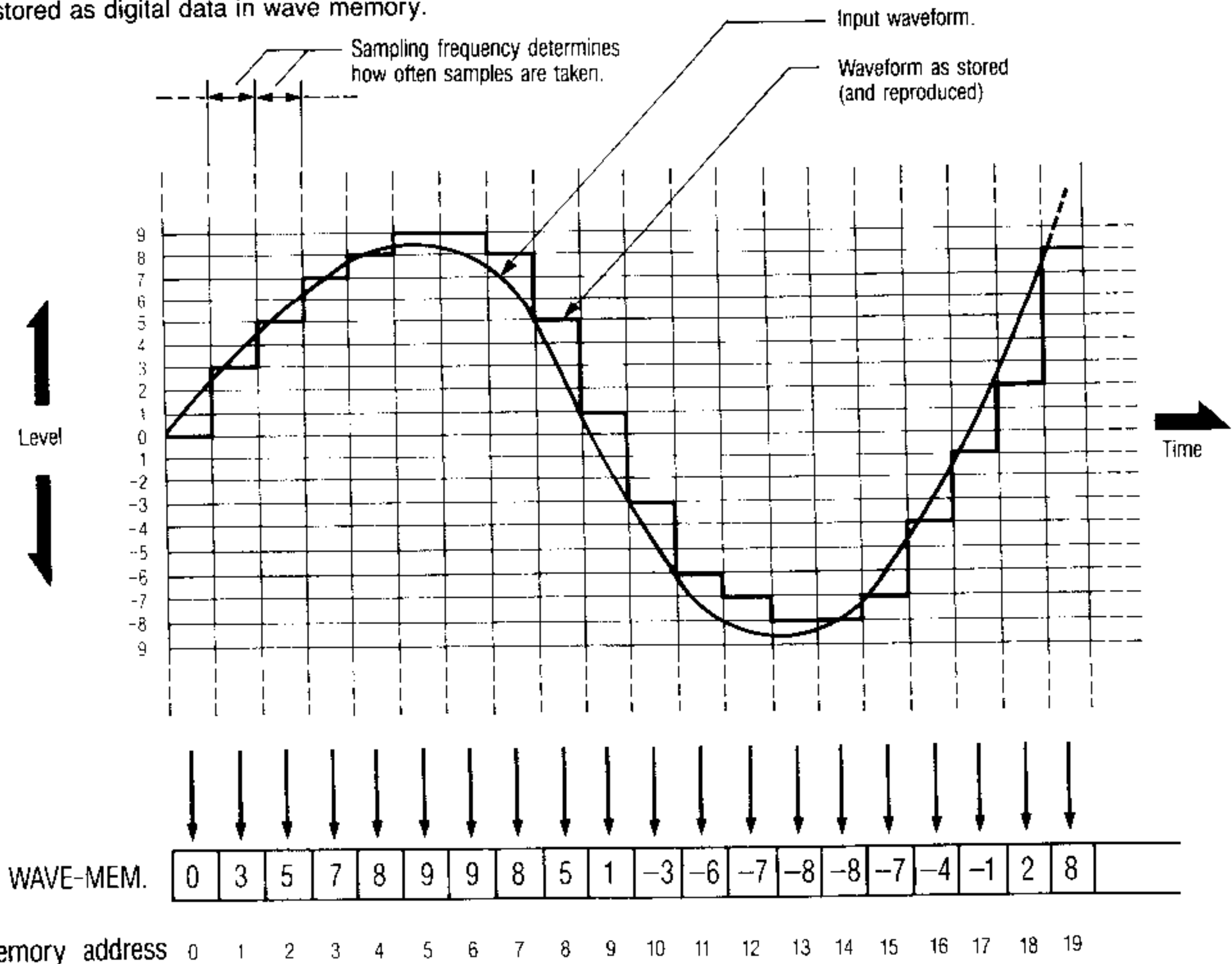
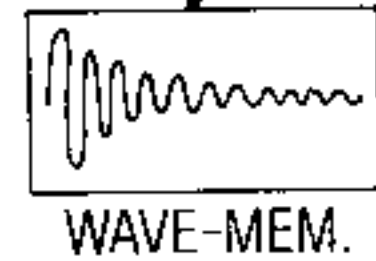

■ The sampling frequency is the number of samples taken per second. For instance, a 32kHz sampling frequency means that 32,000 samples are taken each second (that is, one sample every 0.00003125 fraction of a second). The level of the signal in each sample is measured and stored as a number (a process called "quantization") in wave memory. Intuitively, we can see that the more samples we take per second, the more of the fine nuances of the signal we will be able to capture. In other words, the higher the sampling frequency, the higher the resolution and fidelity. The more upper harmonic detail (brightness) you wish to capture, the higher the sampling frequency you will need.

(As a rule of thumb, you can record audio frequencies up to half the sampling frequency.)

Of course, the more samples you take per second, the more memory space you will need to store those values. With a sampling frequency of 32kHz, for instance, a one second recording will take up 32000 memory cells (words). At 48kHz, the same recording time would gobble up 48000 words of memory space.

(Strictly speaking, to avoid aliasing distortion, the sampling frequency must be at least double the highest frequency present in the audio signal.)

● Relationships between the sampling frequency, resolution, and memory requirement.

Lets say we have a waveform like this that contains a lot of harmonic detail.



i) What happens with a high sampling frequency.

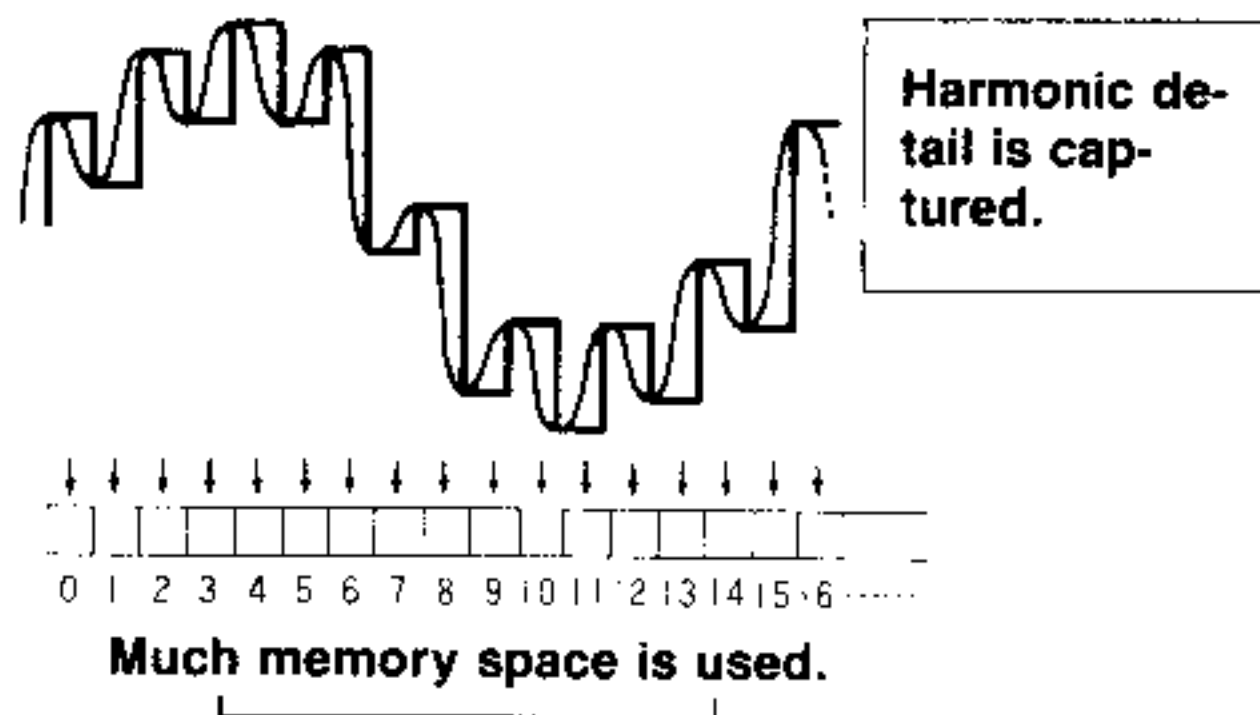

ii) What happens if we use a sampling frequency only half as high.

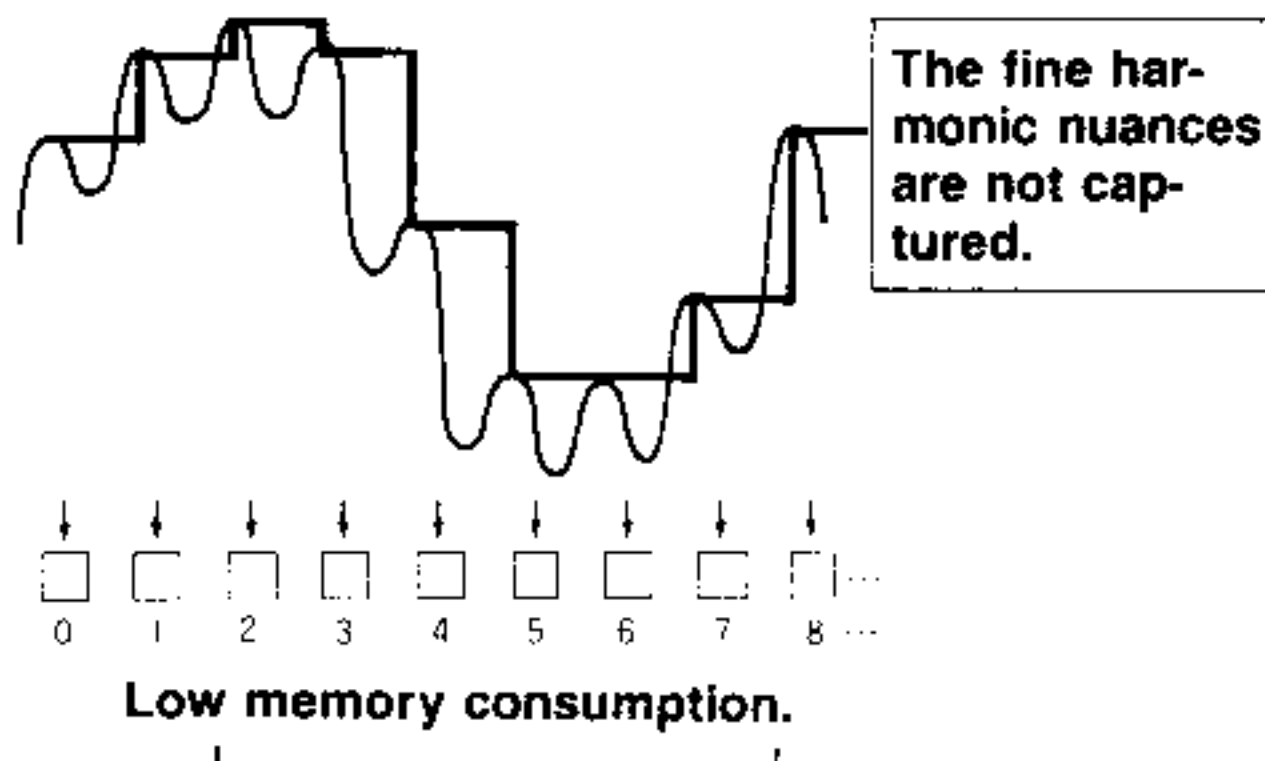

■ While the sampling frequency determines the resolution regarding changes over time, there is also the matter of the resolution of the signal level of each sample taken. We call this A/D (analog-to-digital) resolution.

The DSS-1 has very high A/D resolution to assure accurate quantization and, therefore, high fidelity.

■ The DSS-1 lets you choose any one of four sampling frequencies, at 16kHz, 24kHz, 36kHz, and 48kHz. Make your choice based on your need for high range harmonic detail. Sampling at 16kHz creates considerable distortion which you may want for some effects.

■ The DSS-1 uses 4096-step A/D resolution to assure extremely fine representation of the signal level of each sample. These steps are represented in wave memory as values from -2048 to +2047.

● How A/D resolution relates to sound quality. Here we have the same waveform recorded at 8-step resolution and 16-step resolution.

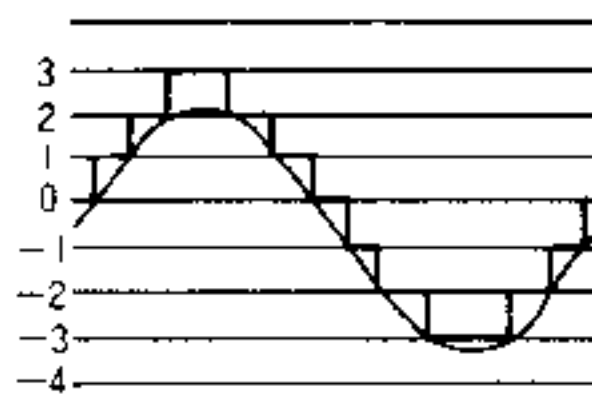

Here we have only a rough approximation of the input.

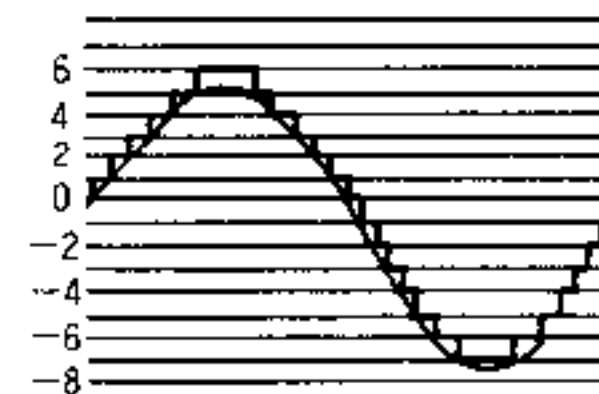

Here the result is closer to the original.

● What happens to sound quality at the 16kHz sampling frequency? Here we have the same sound recorded at two different sampling frequencies.

i) Sampling at 32kHz.

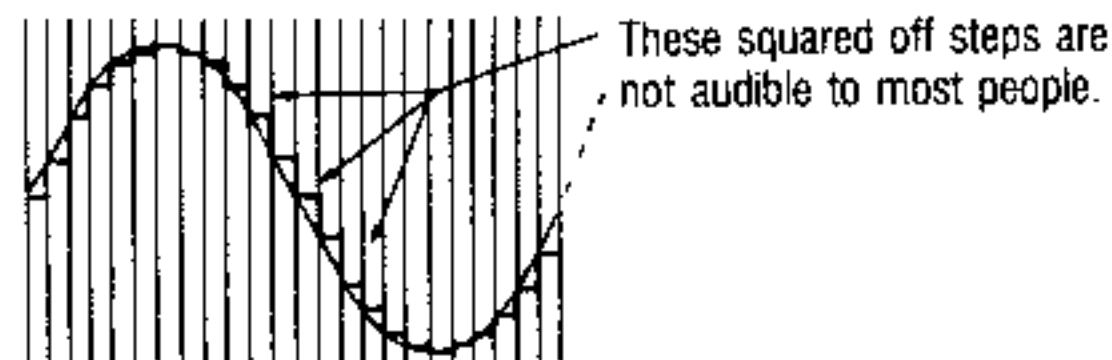

ii) Sampling at 16kHz.

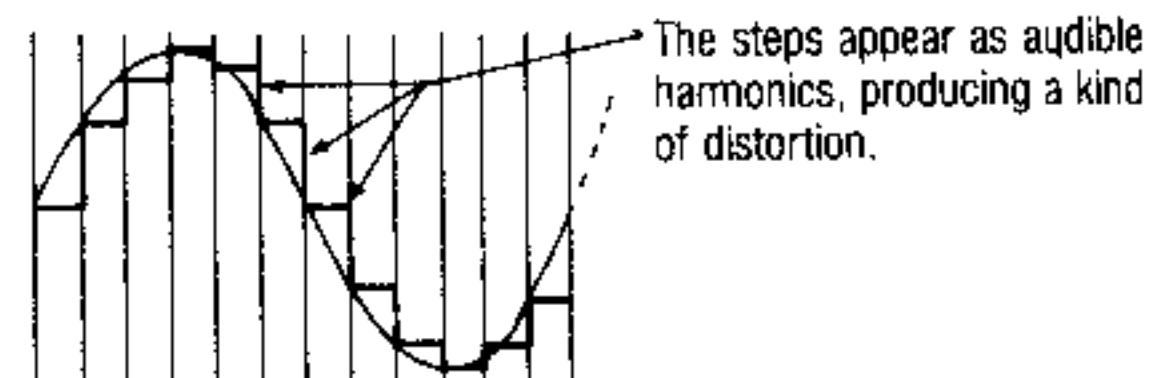

● A/D resolution for sampling in the DSS-1.

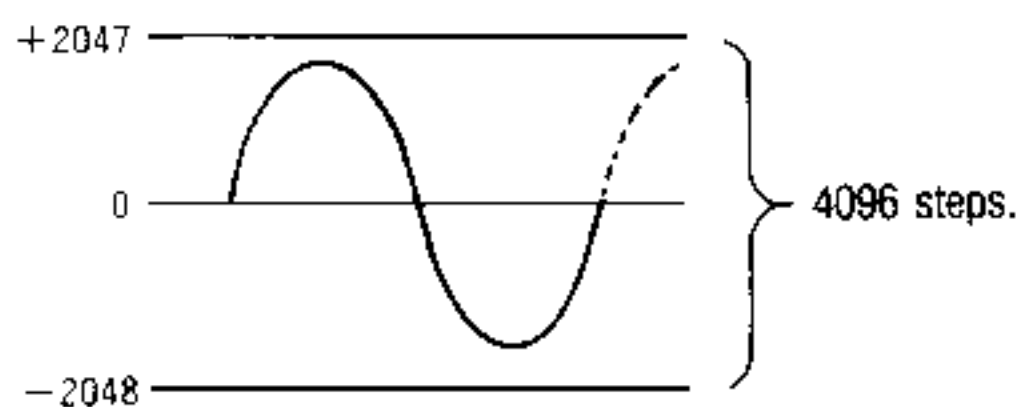

This provides very fine discrimination between different signal levels.

## 2: Waveform Creation

■ Instead of borrowing an external sound (sampling), you can create one full cycle of an original waveform. Unlike sampled sounds, these original sounds are very short, being only one full wave cycle in length. Therefore, the normal procedure is to turn on the LOOP ON/OFF multisound parameter. This provides a continuous waveform which you can then use much like a sound source in any conventional analog synthesizer.

- Difference between sampled sounds and created sounds.

Sampled sound

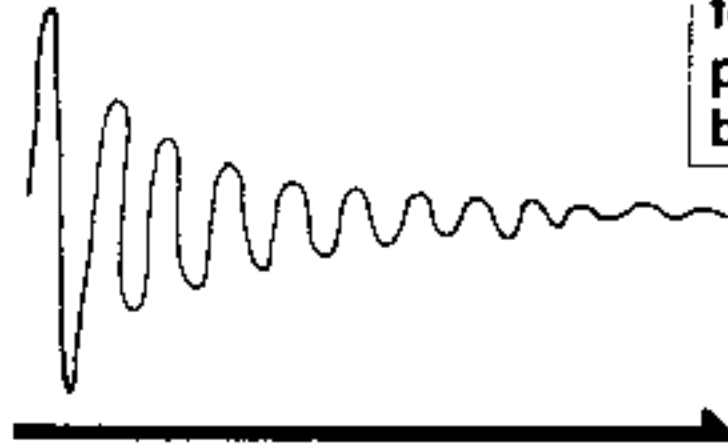

This is a digital recording of a continuous complex waveform that can be reproduced as an audible sound as is.

Created waveform



This is just one cycle so you will not be able to hear it as a continuous sound; it's too short.

Turning on the loop parameter lets you hear it as a continuous signal.

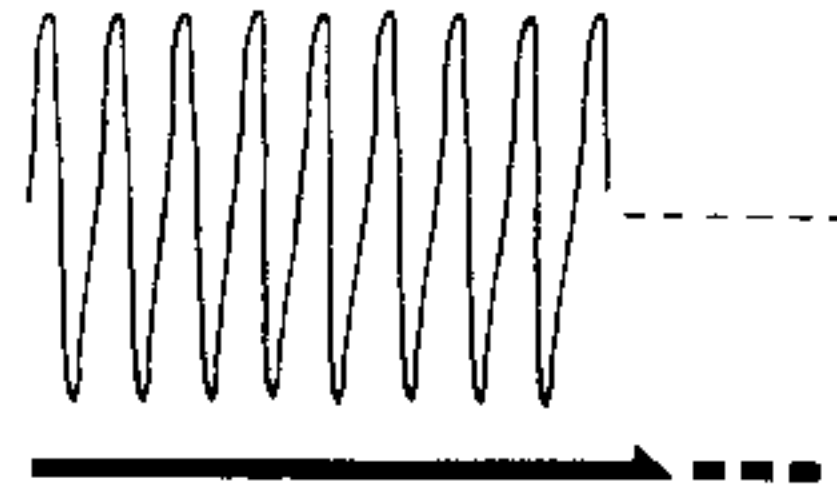

■ The DSS-1 lets you create sounds in two ways: by additive harmonic synthesis, and by "hand drawing."

- Two ways to create waveforms:

Additive  
synthesis

Hand  
drawing

■ With additive synthesis, you set the level of each of 128 harmonics (each of which is a simple sine wave that is a harmonic multiple of the first or fundamental frequency.) The result is one full cycle of a complex waveform. This method is useful for making many naturally occurring waveforms.

● Additive synthesis

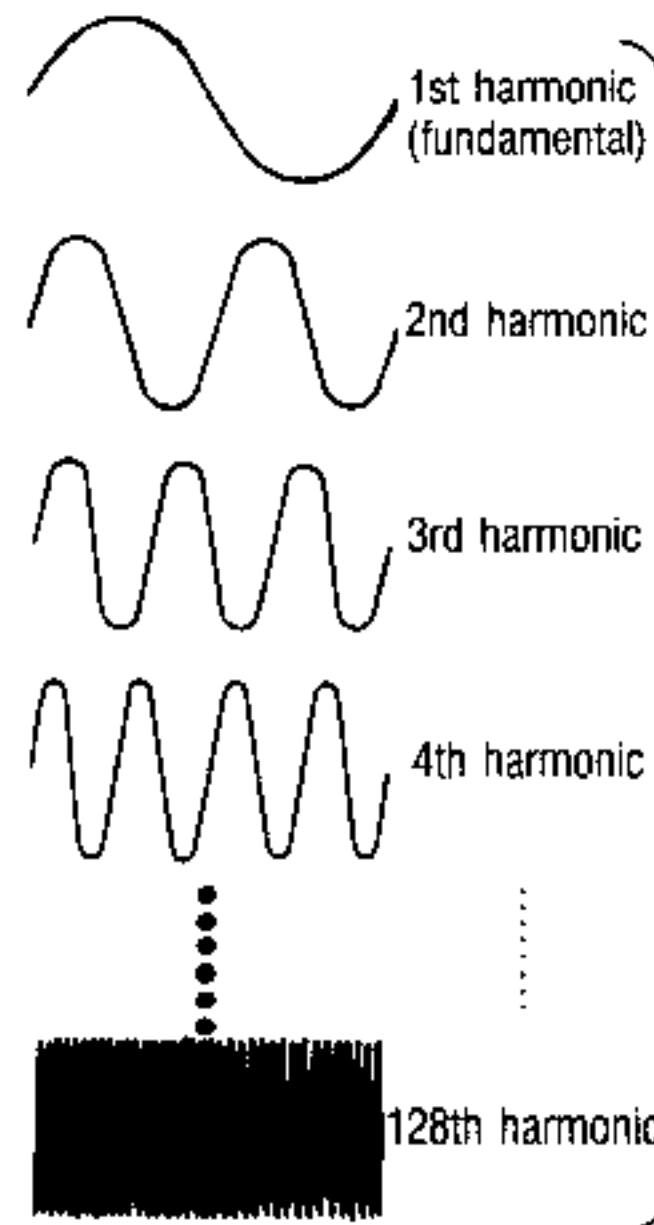

**Sound is created by setting the level of each sine wave and mixing them all together.**

Behind this method is the idea that any regular waveform can be analysed into a series of sine waves of different levels (a mathematical technique called Fourier analysis). For example, in a sawtooth wave, we have the fundamental, the 2nd harmonic at 1/2 the level of the fundamental, the 3rd harmonic at 1/3 the level of the fundamental, the 4th harmonic at 1/4 the level of the fundamental, the 5th harmonic at 1/5th the level of the fundamental, and so on.

● Principle of additive synthesis

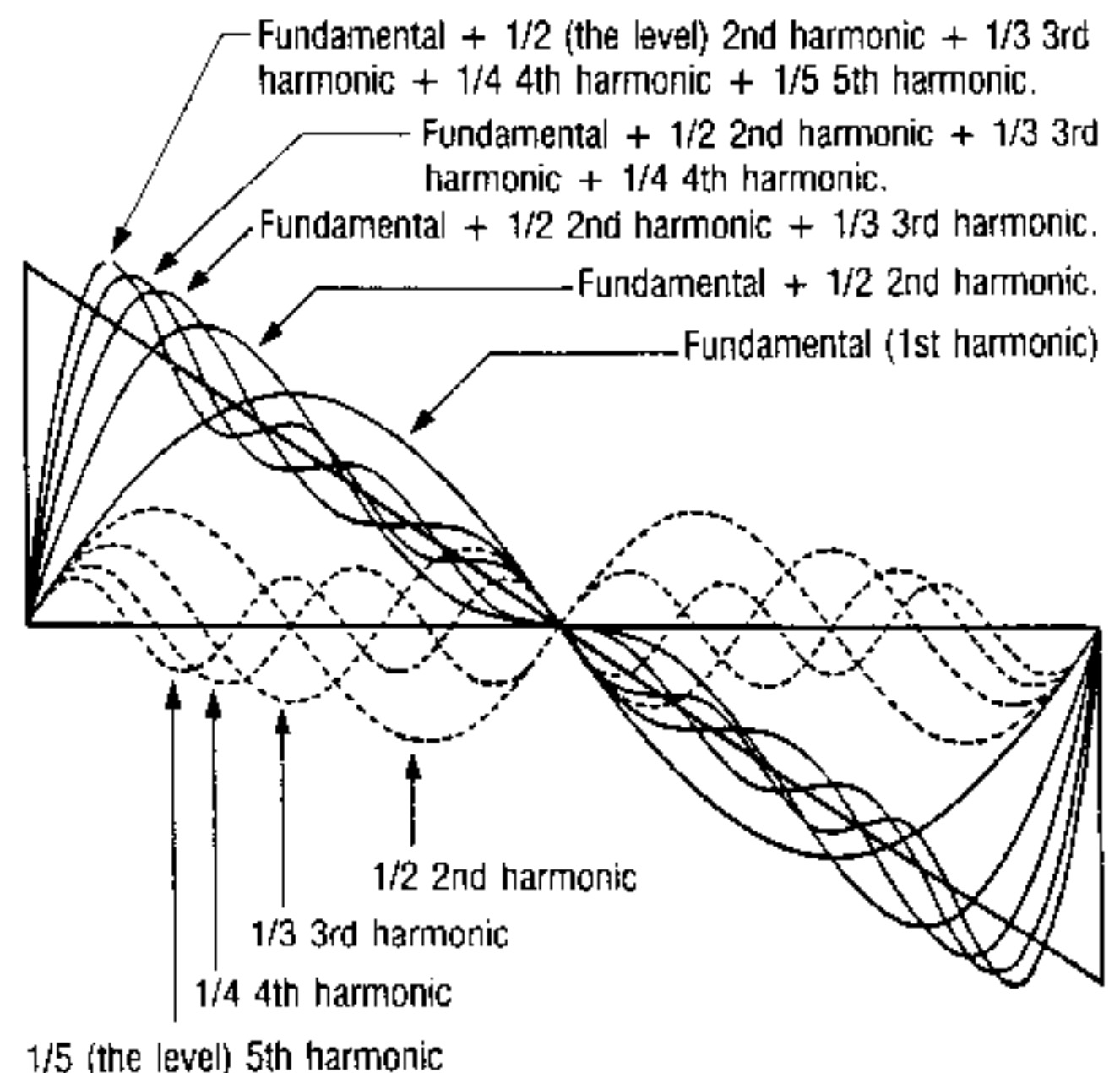

**As you can see, the more harmonics are included, the closer it becomes to a true sawtooth waveform.**

■ In the hand drawing method, you use the data entry A slider to create one full cycle of a waveform. This lets you create waveforms that have more complex harmonic content than is possible to obtain with the additive synthesis method.

● Hand drawing

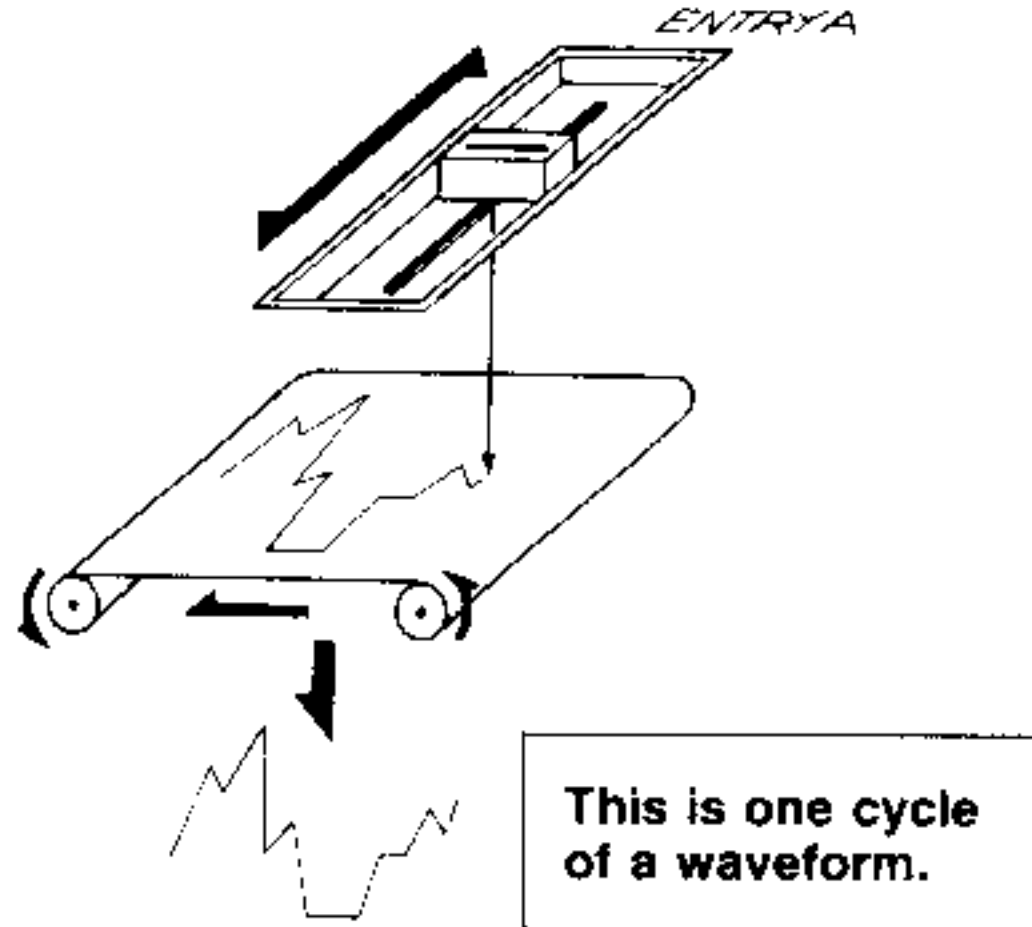

■ The single full cycle waveforms created by additive synthesis or hand drawing are stored in wave memory as data sampled at 32kHz.

● A 32kHz sampling frequency is used to obtain a digital representation of the waveforms produced by additive synthesis or hand drawing, giving the resolution shown here.

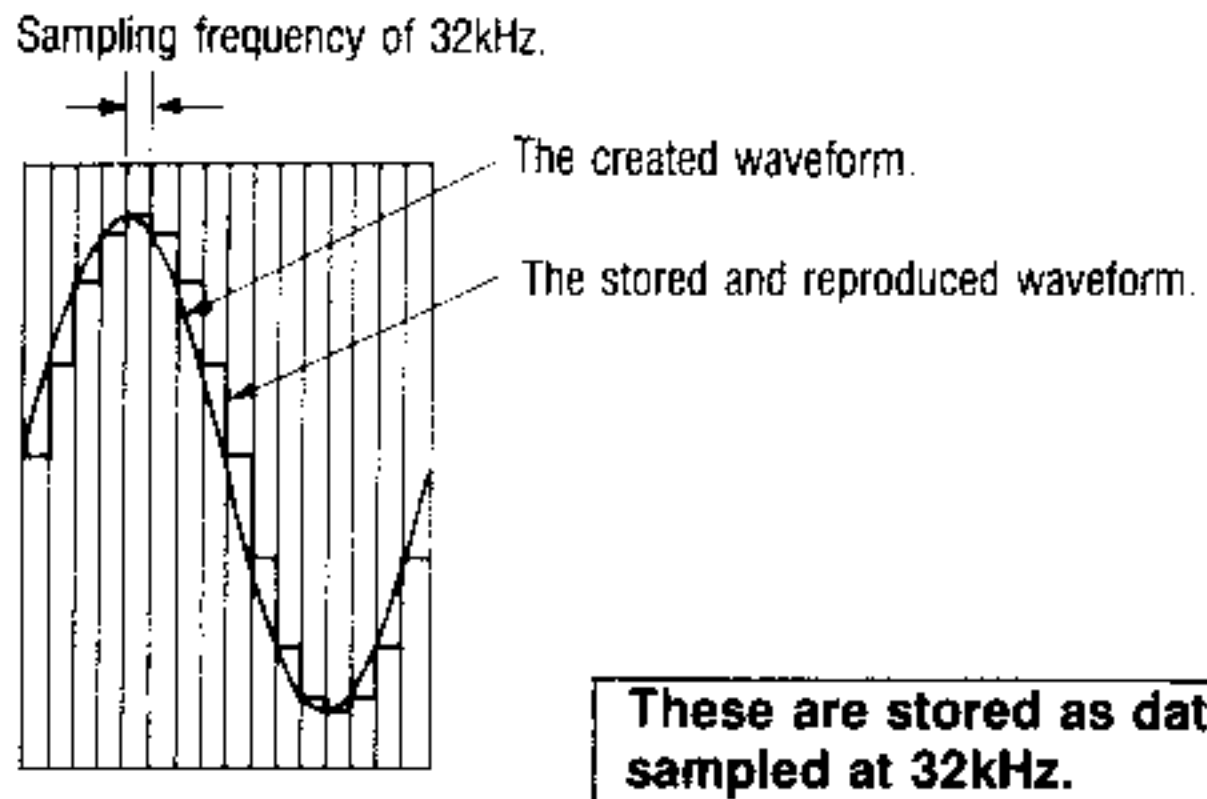
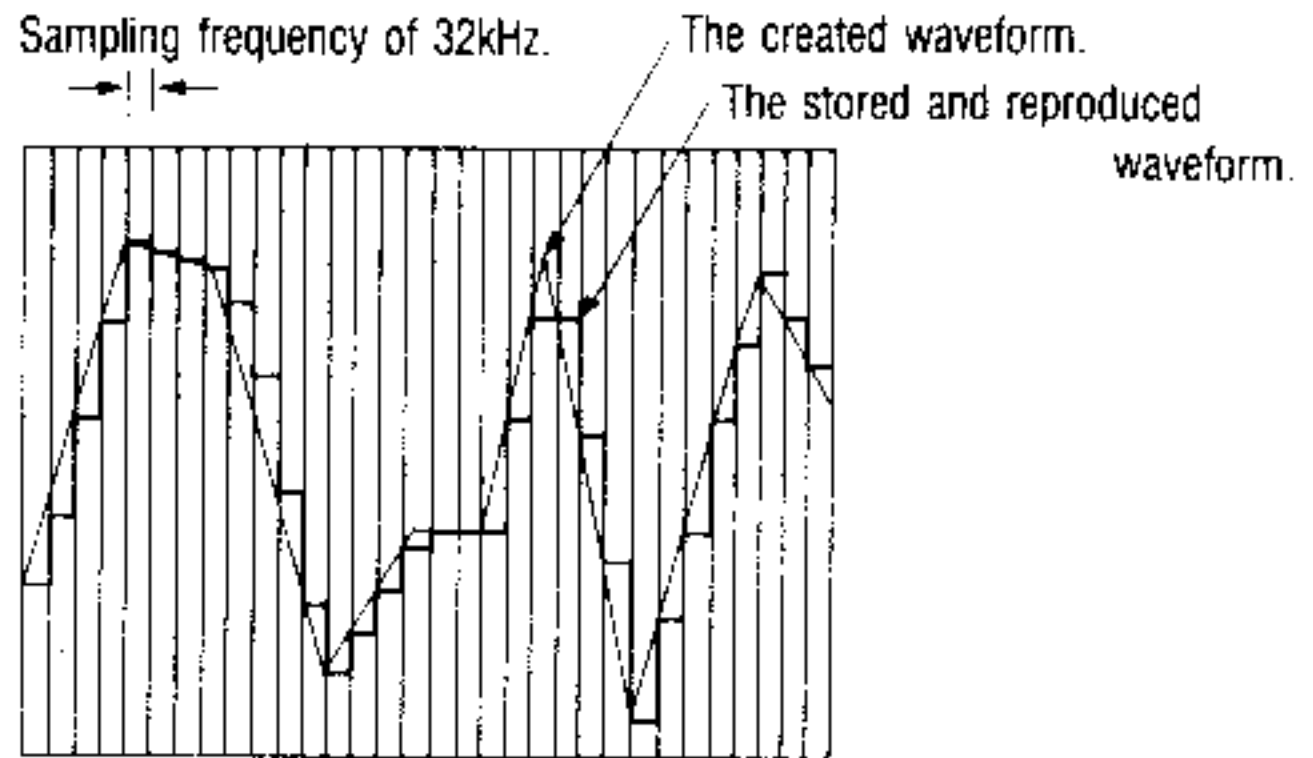



While external waveforms are quantized over a range of 4096 steps, fewer steps are used to represent the level of each sample in waveforms produced by additive synthesis or hand drawing. (However, these are stored in the same 4096 step wave memory.) Therefore, the results may not be as smooth as those obtained with high resolution sampling of external sounds.

- A/D resolution of waveforms created by additive synthesis or hand drawing.

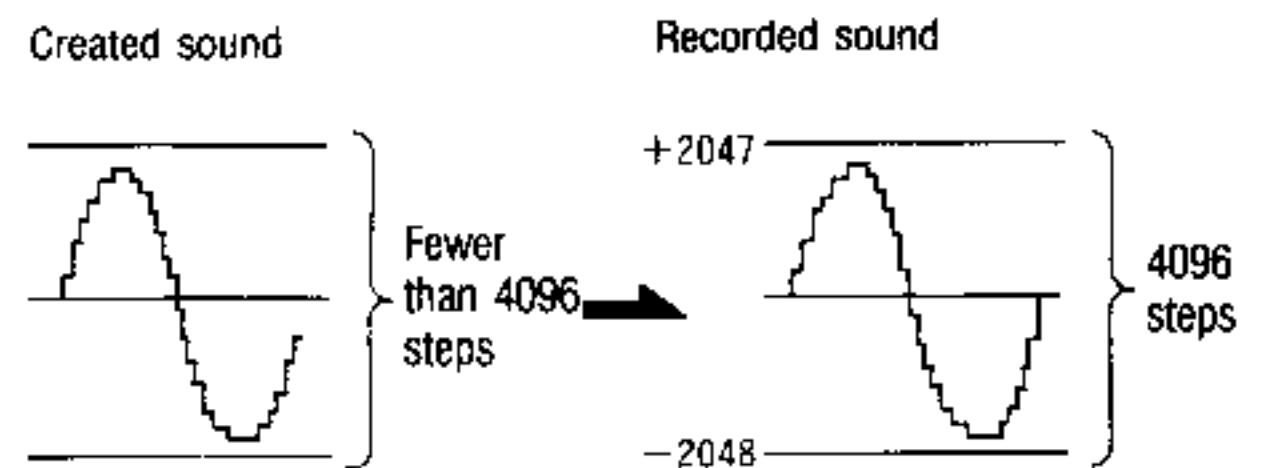

While the created sound is quantized into fewer steps, it is stored in wave memory which has resolution of 4096 steps.

### 3) Editing Functions

- These editing functions let you process your sounds (obtained by sampling external sounds or by creating original sounds) to tailor them to your needs. There are five editing "tools" at your disposal: truncate, reverse, link, mix, and view/edit sample data.

- Five editing functions

i) Truncate

ii) Reverse

iii) Link

iv) Mix

v) View/Edit Sample Data

- The truncate editing method (i) lets you cut out just a part of a waveform by specifying the starting point and the length.

- Truncate function

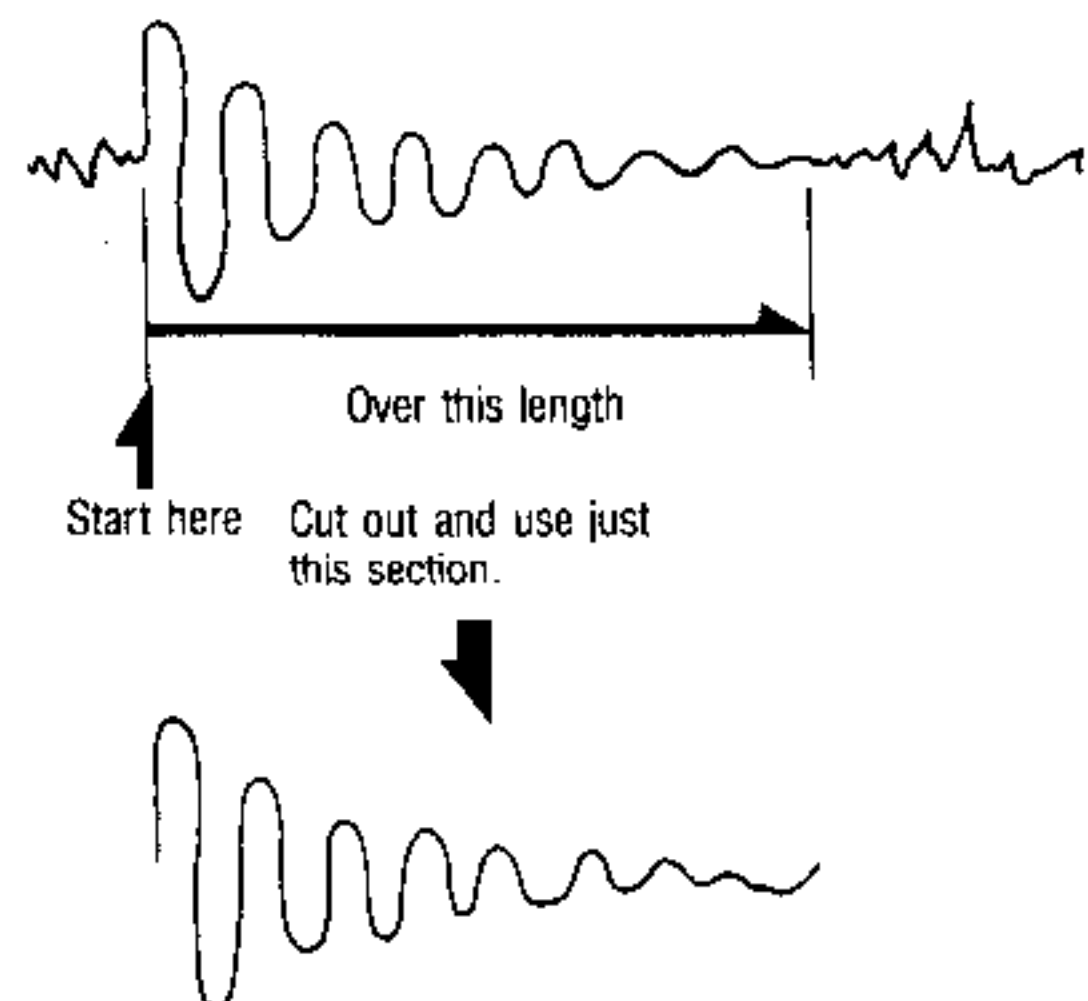

Truncation offers a way of getting a single full cycle from a sampled waveform. Both the additive synthesis and hand drawing methods give you just a single full cycle to start with.

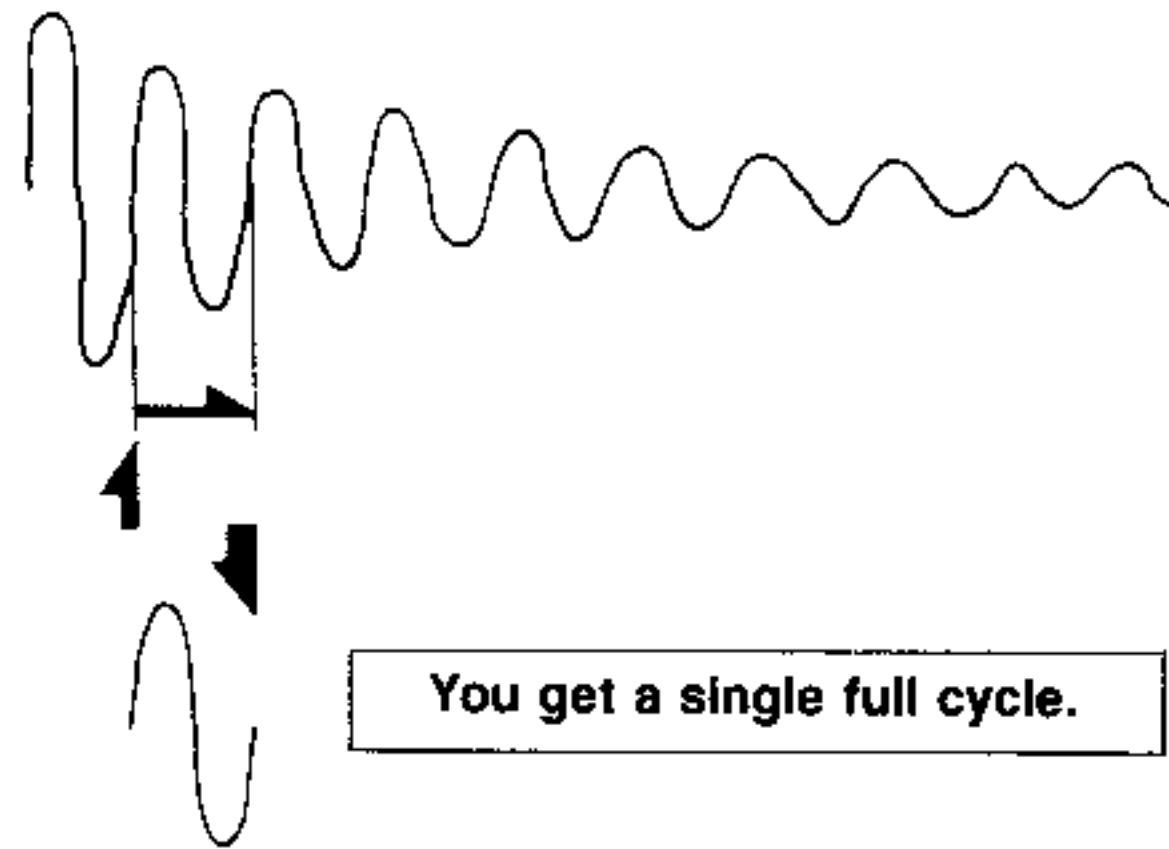

If you are going to loop or link a truncated waveform then you may want to take advantage of the truncate function's auto zero cross search function. This makes sure that the waveform is cut at the zero cross point, thereby avoiding undesirable noise in the reproduced sound. Cutting at the zero cross point assures a smooth crossover for linking.

Truncate also lets you throw away unneeded parts of sampled waveforms, so you can conserve limited memory space. (For details, see the section on data management on page 48 ~ .)

■ The reverse editing function (ii) gives an effect like a tape played in reverse. The waveform data is reversed and stored from back to front. The reverse function is most effective with sampled waveforms that contain large changes in volume and timbre.

● Using the truncate function's auto zero cross search function.

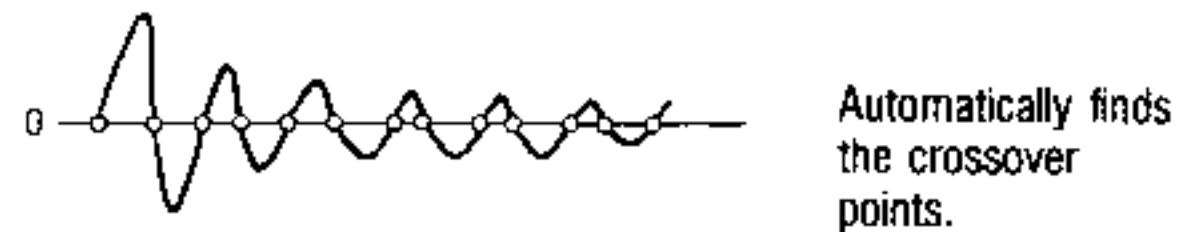

When truncating and looping.

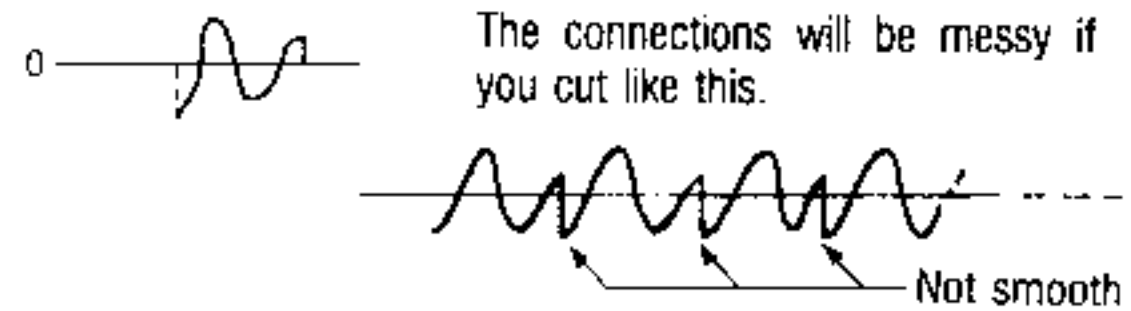

But you get smooth crossover if you cut at the zero cross points.



● The reverse function

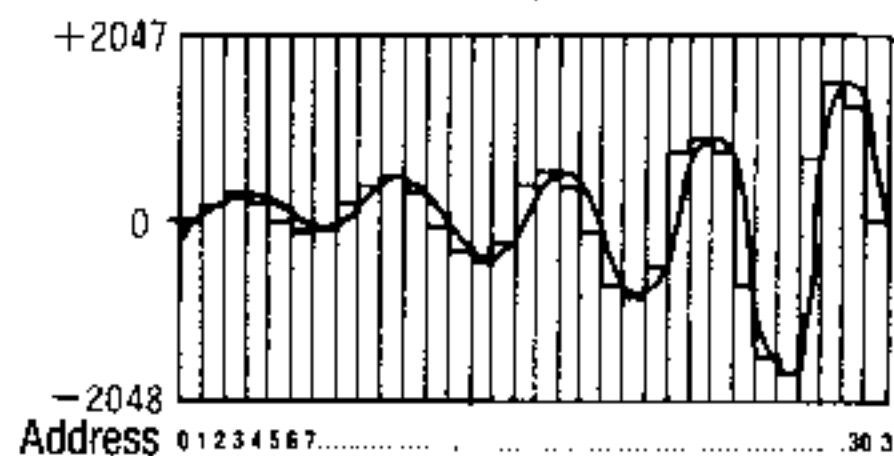
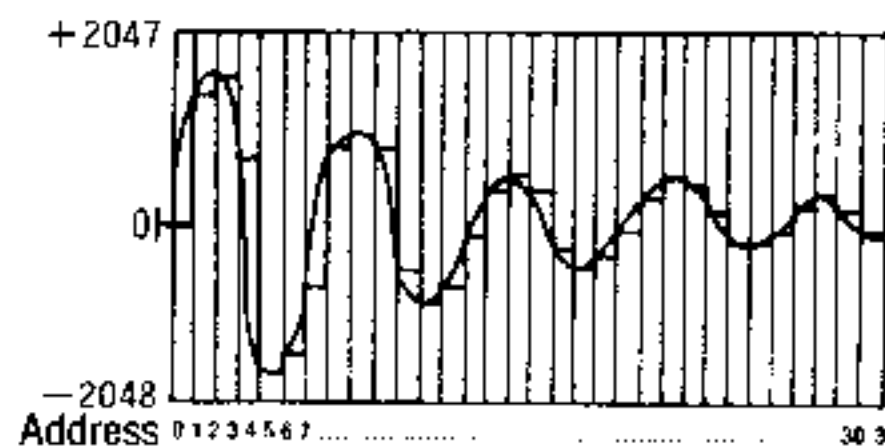

Data is stored in reverse order.

■ The link function (iii) lets you put together two sounds. It doesn't matter how you obtained the sounds in the first place (sampled, created, or edited), you can link them together to create a new sound. Shown here are some examples of the power of this function.

● The link function.

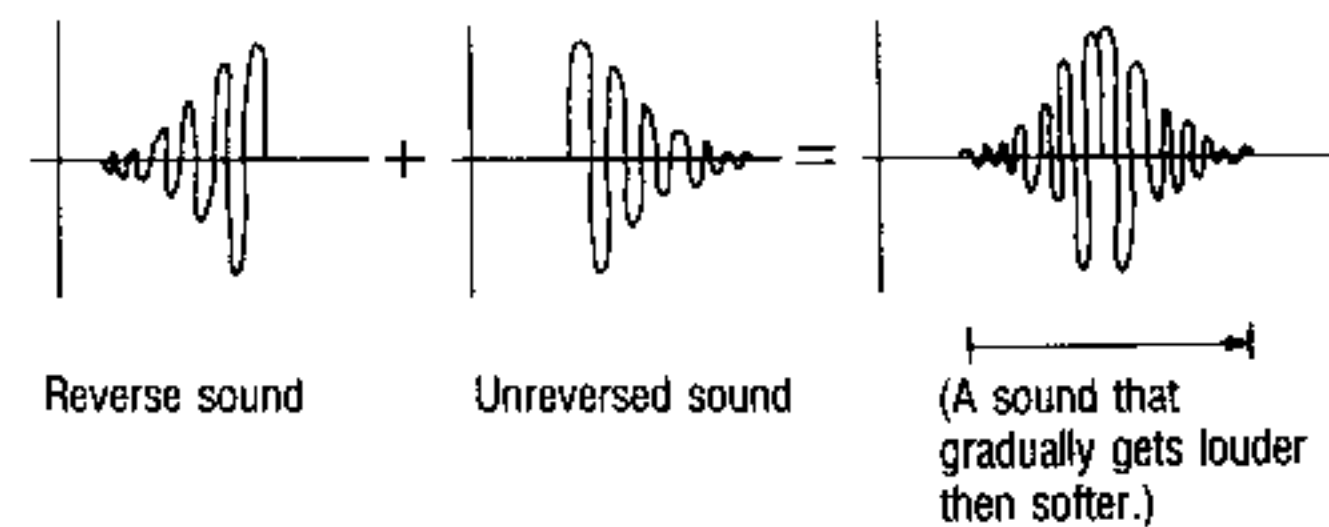
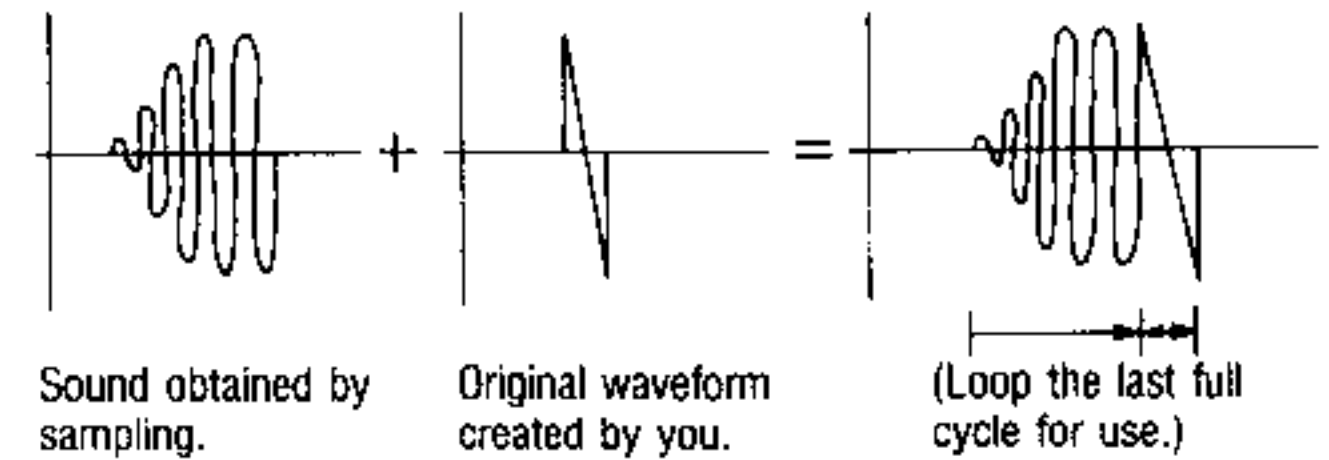
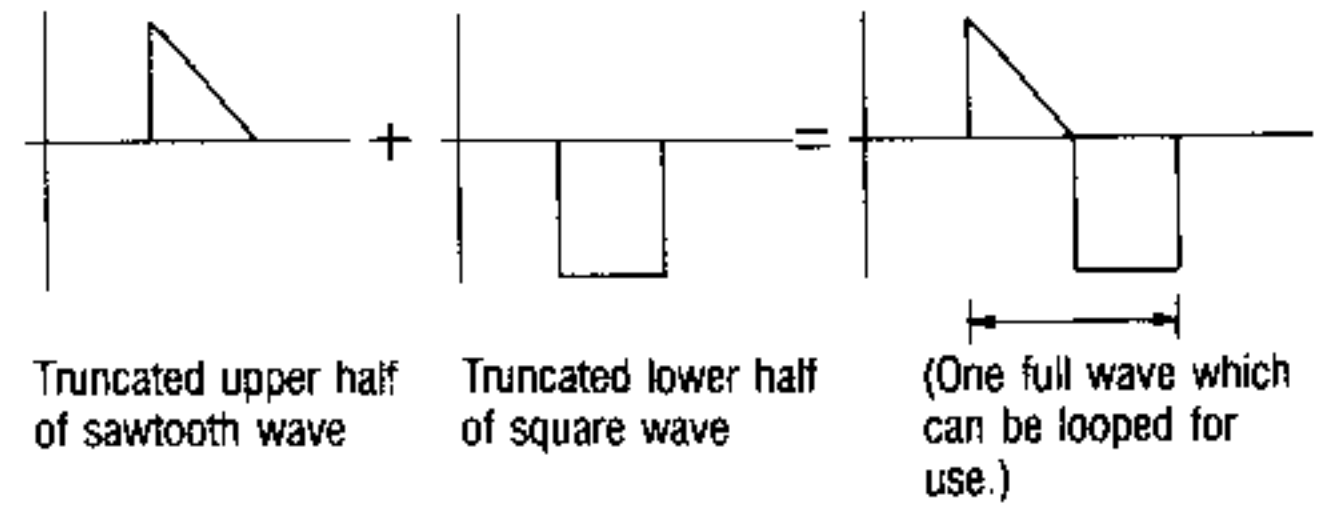
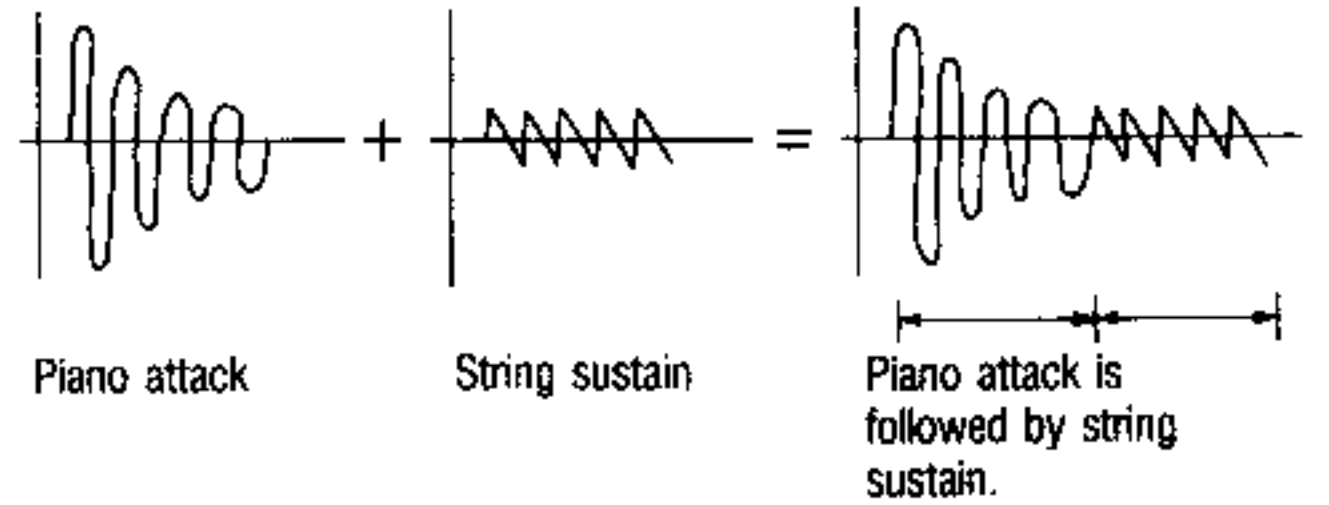

Sounds created by additive synthesis or hand drawing are only a single full wave in length. Unlike sampled external sounds, they do not contain variations in volume and tone color.

However, by linking together several different sounds you can produce these kinds of changes.

For particularly fine control, you can make many variations on a single cycle waveform created by additive synthesis. Then link together all of the waveforms to produce the kind of continuously varying wave that occurs in nature.

● A result like a sampled external sound can be produced by linking together many variations on a single cycle waveform obtained with additive synthesis.

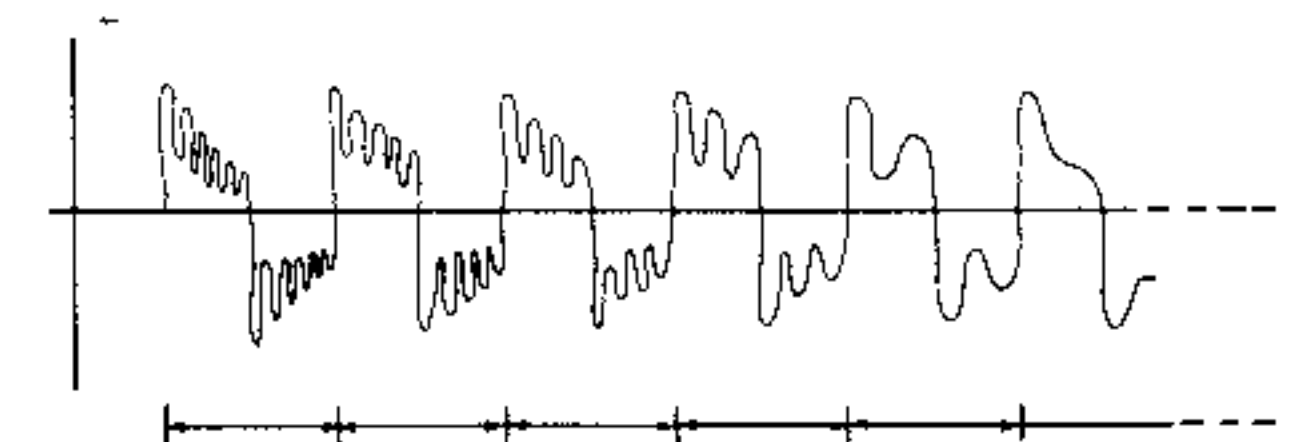

For gradual transitions between the linked sounds, you can use the link cross fade function. This is only effective when both of the waveforms to be linked are sufficiently long.

● Link cross fade

Example: Linking piano attack to string sustain.

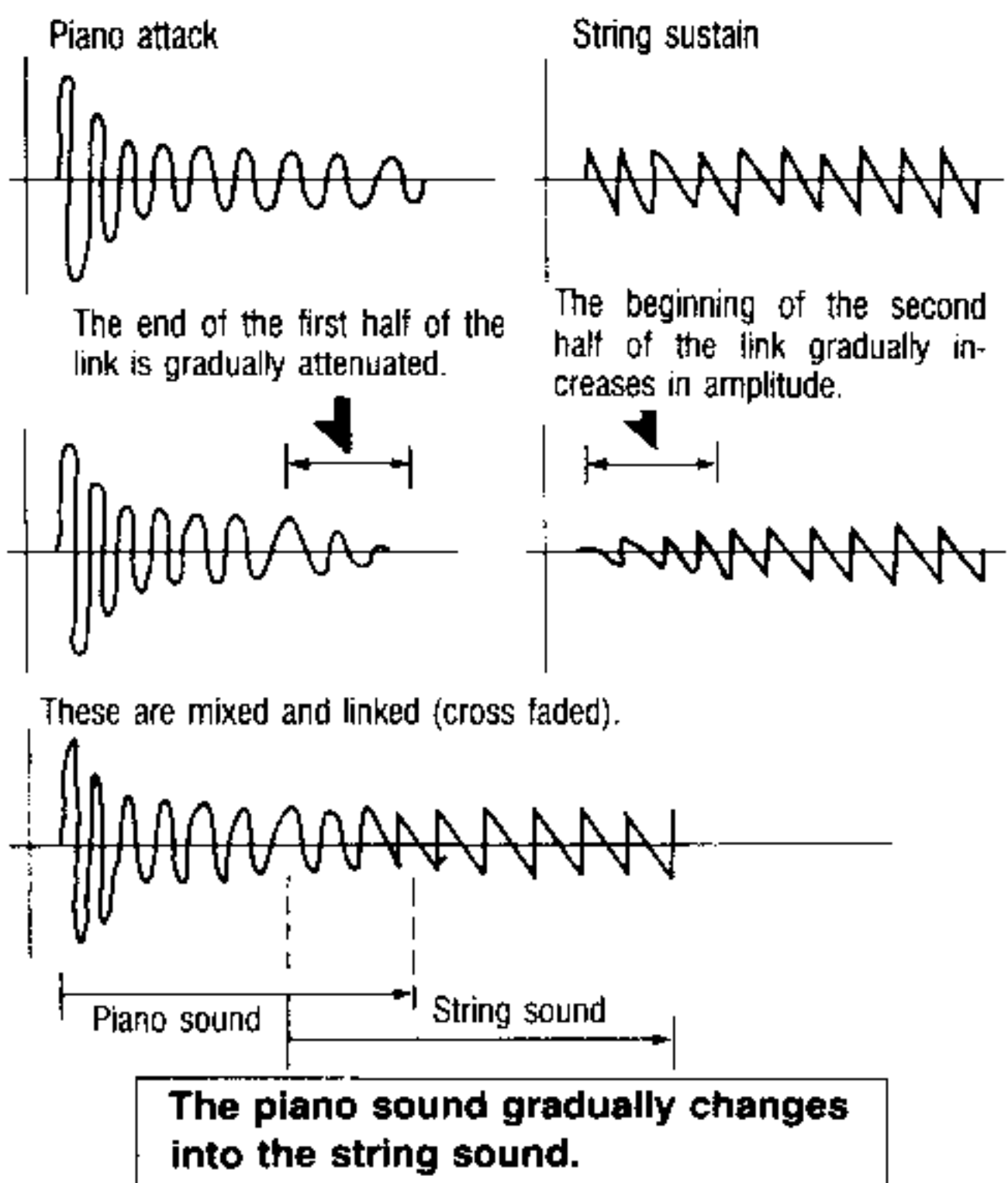

To avoid noise caused by discontinuity in linked waveforms, you can use the auto level adjust function. This finds the point in the second waveform that has a level that is the same as the end of the first waveform, then links them at that point.

● Using the auto level adjust function.

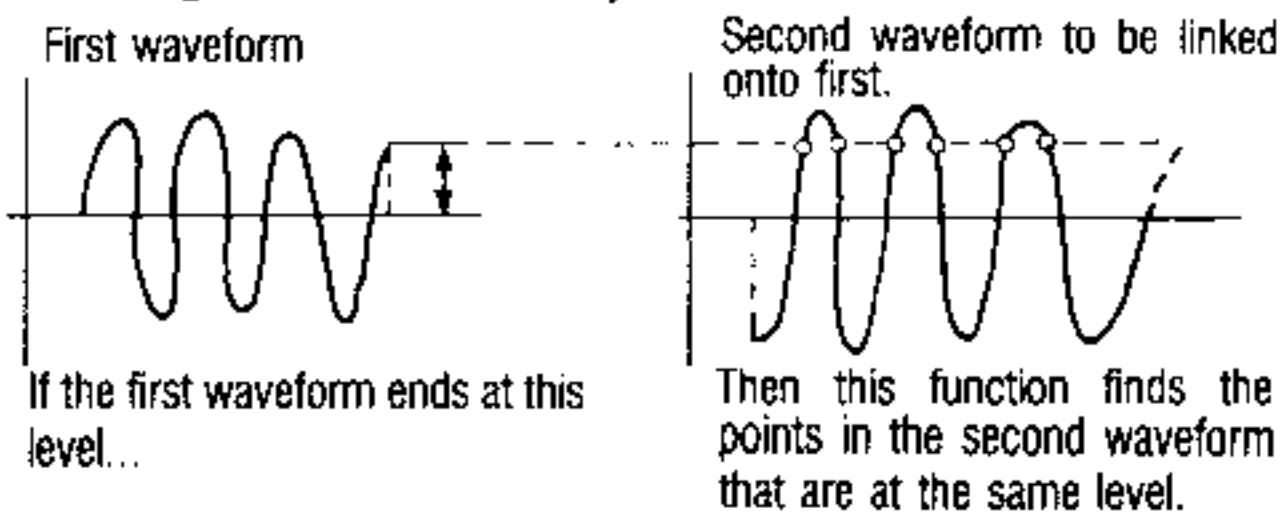

Here is what would happen if we did not use auto level adjust in this case.

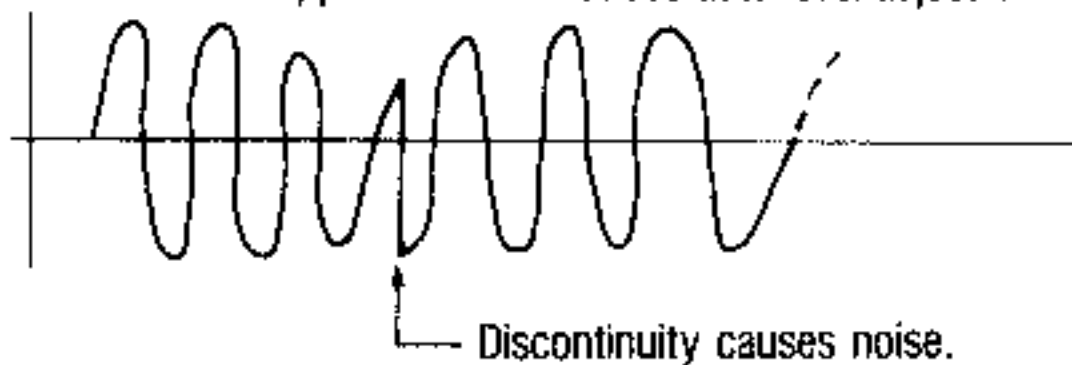

With auto level adjust.

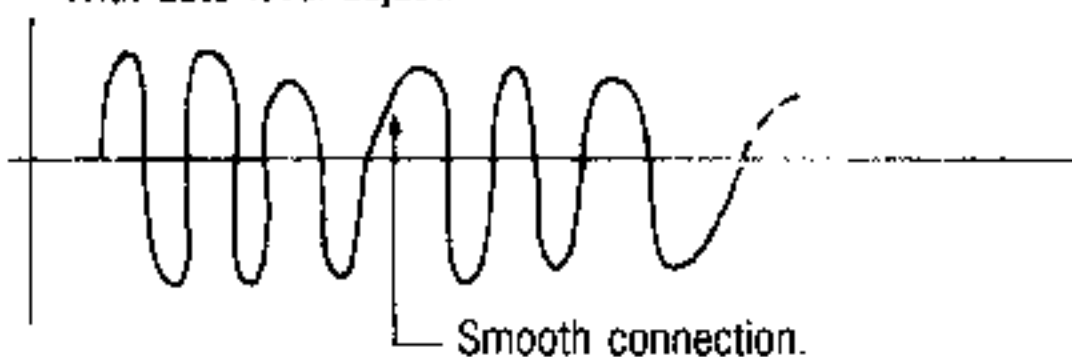

■ The mix function (iv) lets you mix together two sounds. You can determine the ratio of the mixture and detune them if you like. For example, you can make a fat, phased sound by mixing a sound with a detuned copy of itself. Both sounds should be sufficiently long to get this effect. This is useful for making strings and brass ensemble sounds.

● The mix function

Example: square wave plus sawtooth wave

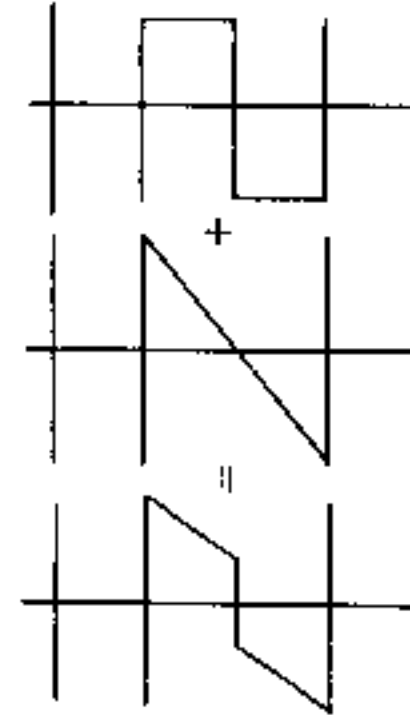

Example: Brass plus strings

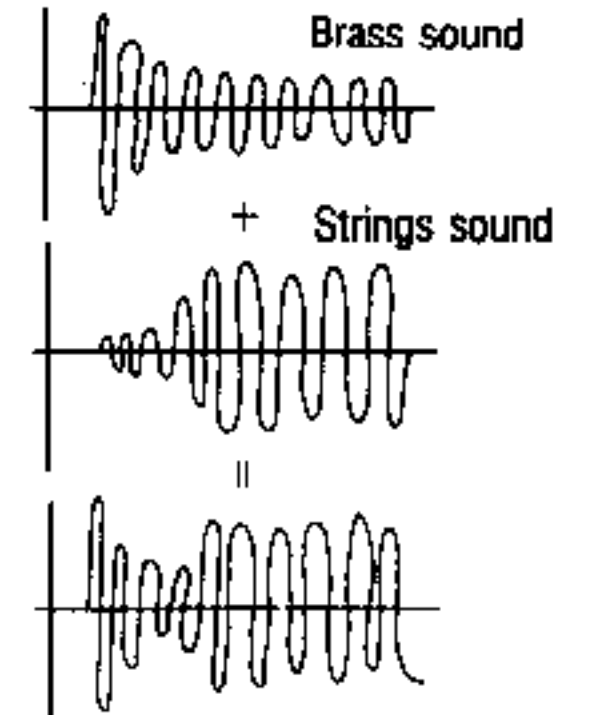

■ The view/edit sample data function (iv) gives you access to wave memory where you can adjust the level of each sample of a waveform. Note that each sample is stored at an address, in sequence from the begin-

ning of the sound to the end. You specify the address, check the current value (signal level at that sampled point), and make adjustments as you like.

● View/edit sample data function

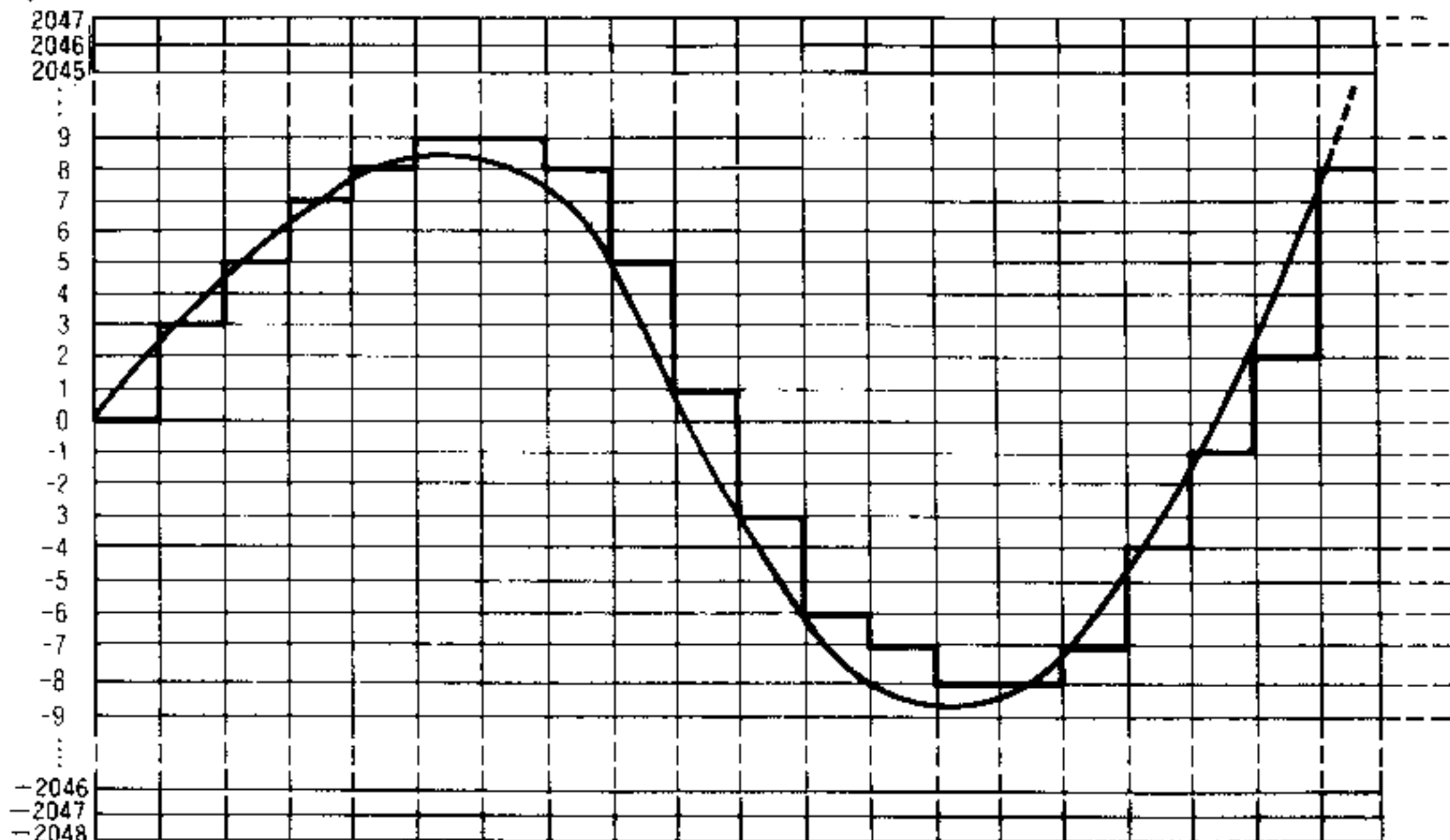

Wave memory values	0	3	5	7	8	9	9	8	5	1	-3	-6	-7	-8	-8	-7	-4	-1	2	8
Addresses	0	1	2	3	4	5	6	7	8	9	10	11	12	13	14	15	16	17	18	19

You specify the address and can then change the value to change the sound.

---

This function is usually used to make changes in stored waveforms.

However, you can also use it to create a completely different waveform, a relatively easy matter if you are dealing with a single cycle. (In theory you could use this function to create the kind of long and complex waveform obtained by sampling an external sound. However, this is a long and time consuming process.)

● Using the view/edit sample data function.

Example: Making an alteration in a waveform.

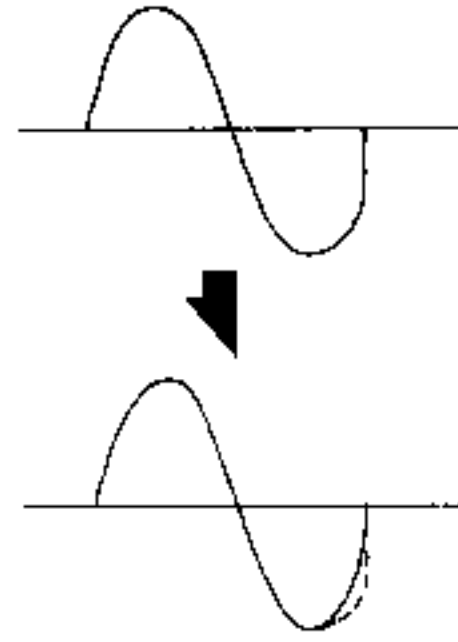

We need to fix up the tail end of this waveform before looping. Otherwise we will get noise caused by poor crossover.

We use the view/edit sample data function to repair the end of the waveform to promote a smooth connection.

Example: Creating a new waveform.



Find a waveform of a suitable length.

Use the view/edit sample data function to adjust each sample value to create a new waveform.

# 3. Completing Your Multisounds

## 1 Explanation of multisound parameters.

■ In the final stage of multisound development you must assign your sounds to the keyboard and set the multisound parameters. There are six multisound parameters.

■ I) The original key/top key parameter is used to assign sounds to the keyboard.

When using sampled sounds, you normally take several samples of the same instrument playing various different pitched notes. For example, you might take a sample in each octave. With the ORG/TOP parameter you assign these sampled sounds to the DSS-1 keyboard. Ordinarily, the ORG or "original key" value is set to the key that has the same pitch as the sampled sound. The TOP or "top key" value is set to a key that is within the upper limit for "reading out" the data from memory (more about that later). The lower limit is taken care of automatically; it is the key that is a semitone above the TOP key value of the next sound down the keyboard. In the case of the lowest assigned sound, the lower limit is the limit of the DSS-1's assignment capability (which will be the lowest key in the "virtual keyboard" in the diagram below).

The DSS-1 has a virtual (or imaginary) keyboard that covers the range from C#-1 to G9. When you assign sounds, you set their ORG and TOP values to keys within this virtual keyboard range.

(The DSS-1's 61-key physical keyboard produces the sounds in the virtual keyboard according to the settings of program parameters such as the oscillator octave and interval. Refer to the descriptions of the F11 OSC OCT and F15 OSC2 DETUNE & INTERVAL functions. You could say that the physical keyboard is a sliding "window" on the virtual keyboard.)

● Virtual keyboard: the range over which sounds can be assigned.

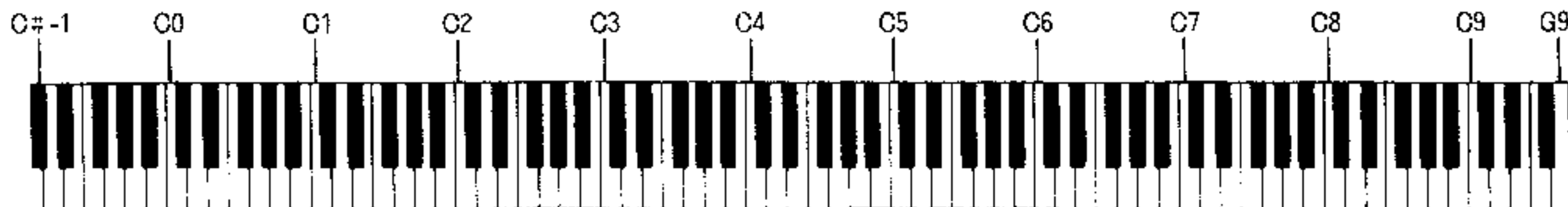

Up to 16 sounds can be assigned to the keyboard. In other words, a single multisound can contain a maximum of 16 sounds.

● The multisound parameters:

- I) ORG/TOP
- II) TR/NT
- III) LOOP ON/OFF
- IV) LOOP START & LENGTH
- V) SOUND START & LENGTH
- VI) TUNE/LEVEL/fc

● Original/Top key assignments and memory readout range.

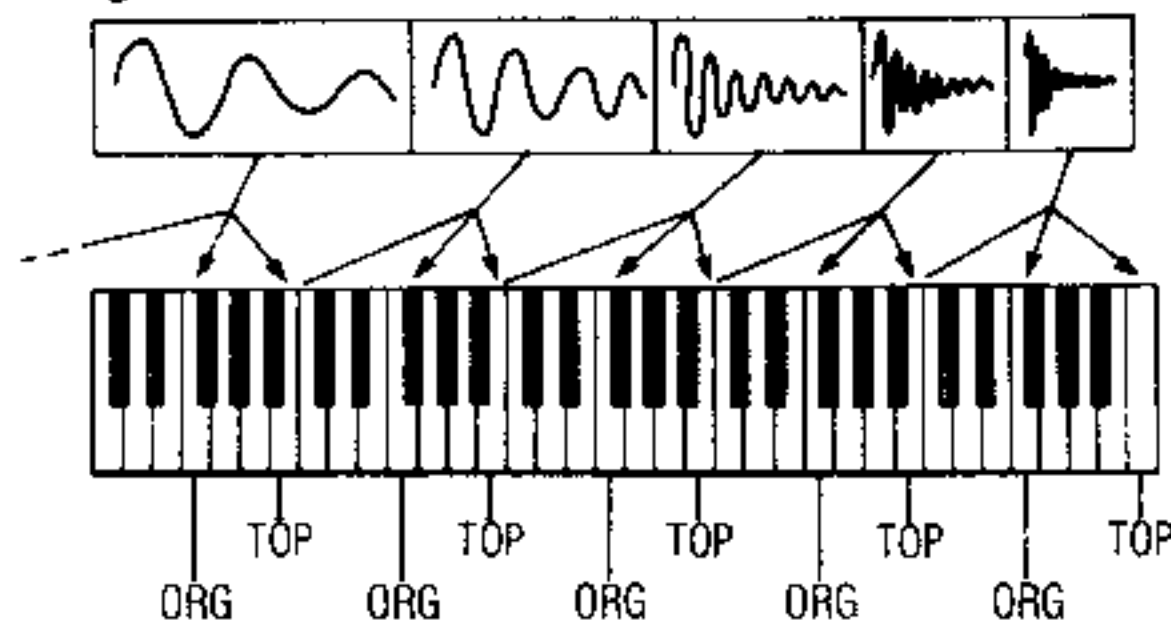

Each sound is transposed up and down from its original key value to cover the notes within its assigned range. This pitch transposition is achieved by varying the rate at which the data is read from memory.

Since the sound data was sampled at a particular rate (the sampling frequency) when we recorded it (or stored it), we can change its pitch by retrieving it at a different rate. To transpose the pitch upward, we use a higher read-out frequency than the original sampling frequency. To transpose downward, we use a lower frequency than the original sampling frequency. If we use the same frequency as the sampling frequency then there will be no change in the pitch. (The same sort of thing occurs with a tape recorder if you change the playback speed.) Note that the lower down you transpose, the rougher the waveform becomes—this may be an audible problem if you use the same sound sample over a wide range.

When you assign a sound to the keyboard, you set the original key to the same pitch (frequency) as the originally sampled sound. Then you set the top key to the highest note to which you want the sound's pitch transposed. However, there is an upper "pitch transpose limit" imposed by the highest readout frequency available to the DSS-1. This maximum readout frequency is 64kHz and its relationship with the sampling frequency is what decides how high up you can transpose the pitch of a sampled sound. (Recall that when you sample a sound, you have a choice of four sampling frequencies to use. The relationship is easy to see for the 32kHz sampling frequency. Doubling the retrieval rate raised the pitch an octave.) You can refer to the chart here when deciding where to set the top key for each of your sounds.

Particularly when reproducing acoustic instruments, a reliable method is to take a sample from the same note (F for example) in each octave. Then use each sample for one octave of the DSS-1 keyboard. In this case, you set the original key to the same note (F) as the sample, while the top key may be assigned a half octave higher (B). This gives you full, smooth keyboard coverage.

If you use fewer samples, assigning each to a wider area of the DSS-1 keyboard, then you may notice abnormal colorations and enveloping near the upper and lower limits of each sound.

For high quality results it is best to use as many samples (sounds) as possible, assigning each to a narrow portion of the keyboard, and thereby reducing the required pitch transposition range for each sound. This approach assures greater realism and naturalness in the reproduced sound.

● Pitch transposition and data readout.

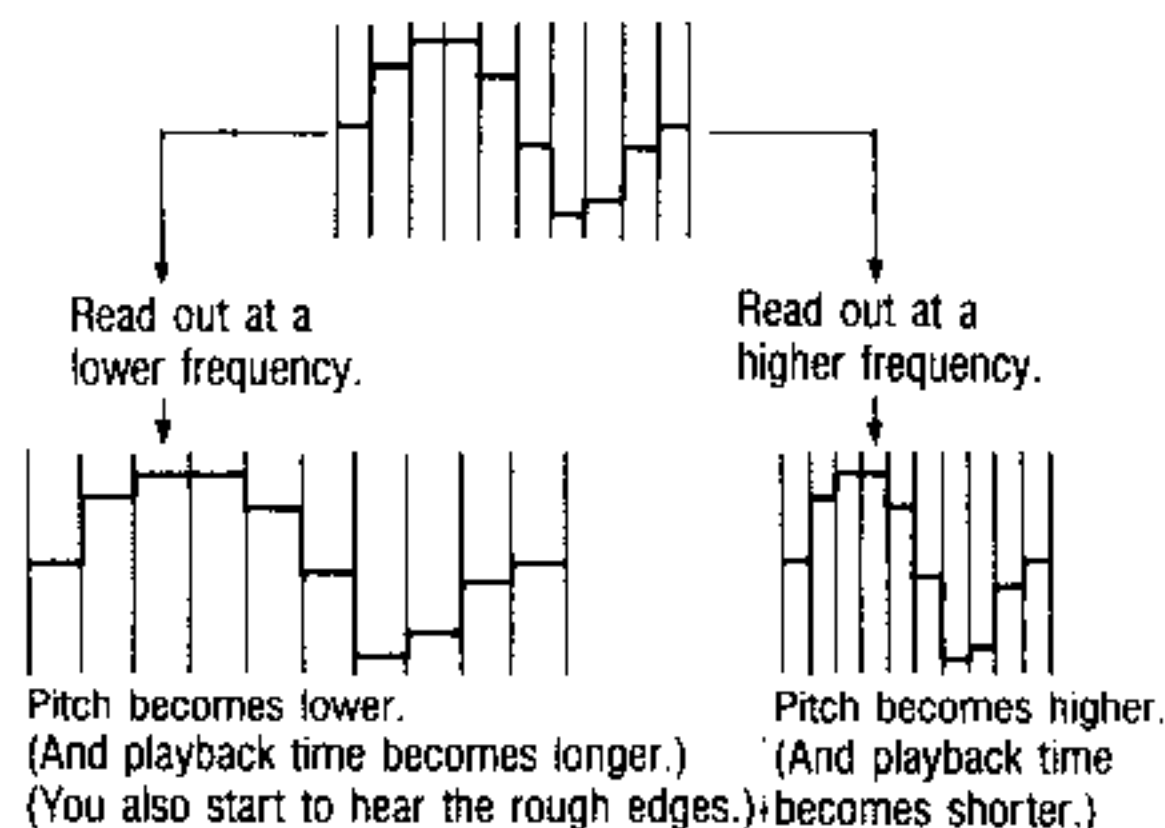

● Interval from original key to upper pitch transpose limit.

Sampling frequency of sound.	Upper pitch transpose limit.	Example using C3 as original key, showing allowable range of top key settings.
16kHz	24 semitones up (64kHz)	C 3 - C 5
24kHz	17 semitones up (64kHz)	C 3 - F 4
32kHz	12 Semitones up (64kHz)	C 3 - C 4
48kHz	5 semitones up (64kHz)	C 3 - F 3

● Example: Making a multisound reproduction of an acoustic piano.

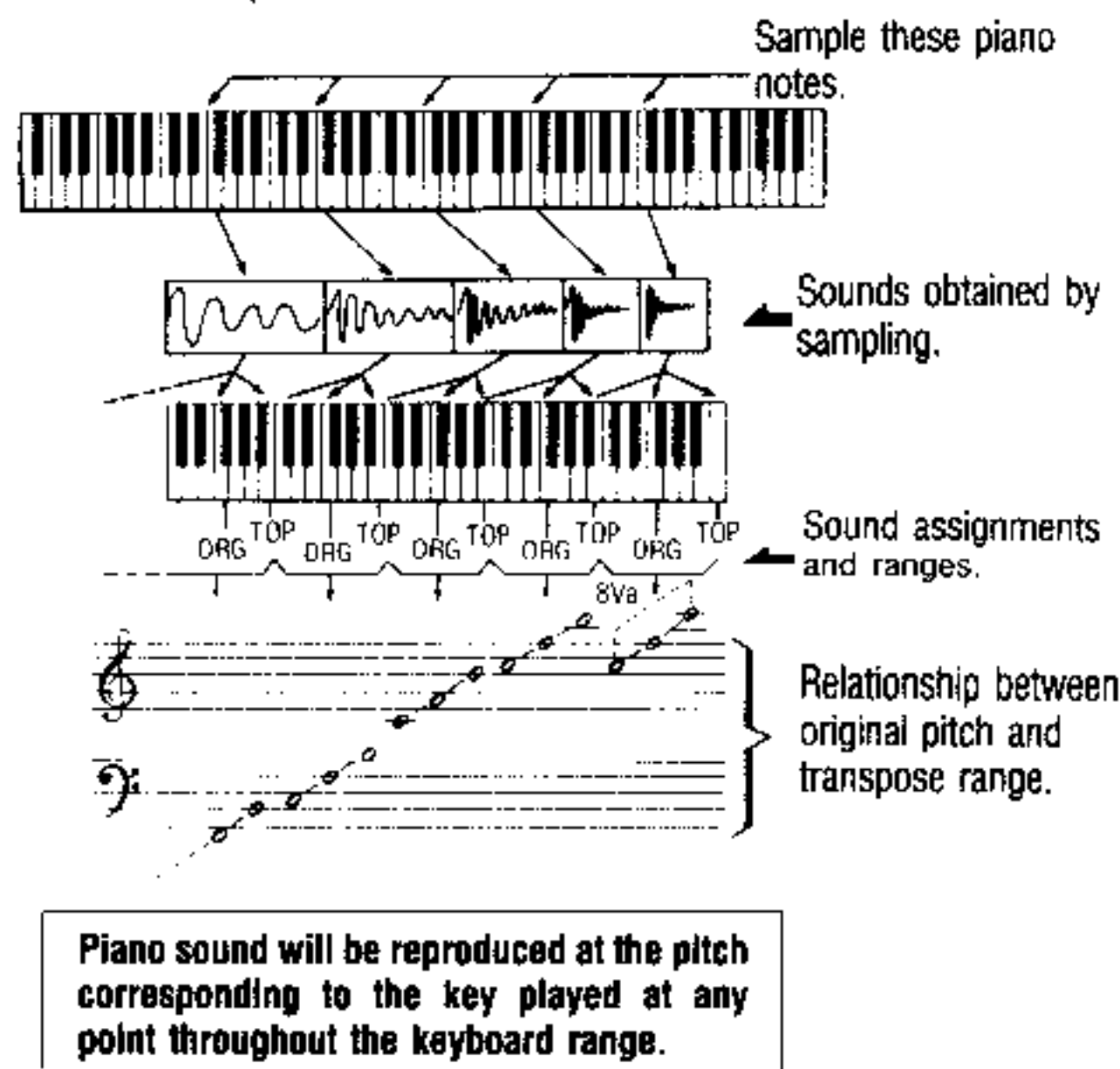



■ II) TR/NT (transpose or no transpose) is a question of whether to transpose a sound's pitch or not. Of course, you would normally set this to TR, so that the pitch will be transposed and correspond to the key being played. However, there are some cases when you may want to obtain the same sound, without any pitch change, no matter which key you play within the assigned range. An example of this would be drums. In this case, set this parameter to NT (no transpose).

■ III) The loop on/off parameter lets you decide whether you want to repeat a section of the sound or not. Contrary to the case with the other parameters, the loop on/off setting affects all the sounds within a particular multisound. If you turn the loop on, then all sounds in that multisound will be looped. (Though there is a way to get around this and keep a particular sound from appearing to loop. Read on.)

■ IV) The loop start & length parameter is only effective when the sounds are looped (that is, when the loop on/off parameter is on). This lets you decide where to start the loop and how far to continue before looping again. The loop start point is specified as an address in memory. The loop length is specified as a number of memory cells.

We can classify loops by their length into the "short loop" and "long loop" categories, each of which has particular characteristics that we must consider.

A short loop is used to produce a continuous sound from a sound that you created (by additive synthesis or hand drawing) or that you obtained by sampling a single monophonic tone. Ordinarily you would set the loop length the same as the length of a full cycle of the waveform. In the case of a short loop, the loop length will affect the reproduced pitch in the mathematical relationship shown below, assuming that you are playing the original key. A shorter length produces a higher pitch, while a longer length produces a lower pitch.

$$\text{Pitch at original key (in Hz)} = \frac{\text{Sampling frequency of sound (in Hz)}}{\text{Loop length}}$$

● Example of loop start point and loop length.

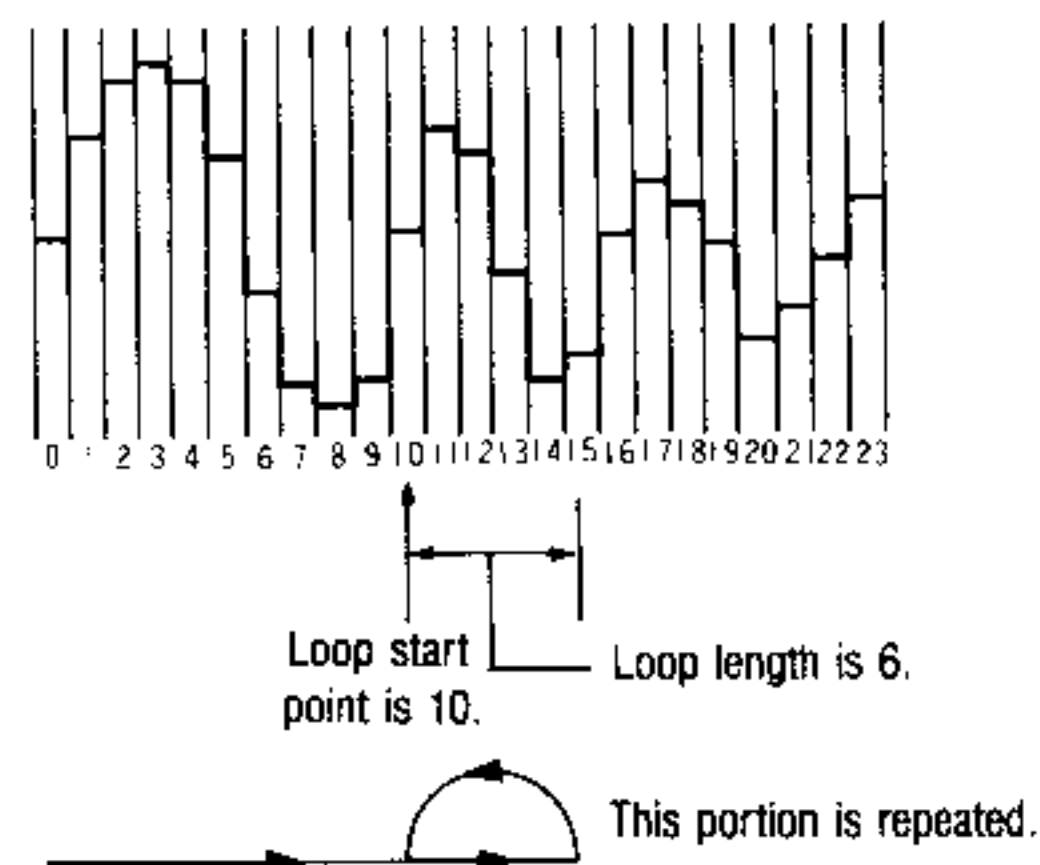

● The relationship between loop length and pitch for a short loop is demonstrated in the example shown here. With a sampling frequency of 32kHz and loop length of 20, we can find the looped sound pitch that will be produced at the original key.

$$\frac{32000}{20} = 1600(\text{Hz})$$

What happens if we change the length to 19?

$$\frac{32000}{19} \approx 1682(\text{Hz})$$

What if your sampled sound was originally 1640Hz. Whether you choose a length of 20 or 19, the looped portion of the sound will have a pitch that is slightly lower or higher than the sound before the loop. The solution is to sample again, adjusting the pitch of the source to match the pitch that can be obtained with the particular sampling frequency and loop lengths available.

Discontinuity in a short loop will result in noise. Therefore, it is usually a good idea to take advantage of the "auto zero cross search" function which assures a smooth loop by automatically finding the optimum start point and loop length.

The long loop is usually used to produce continuous sound from samples of massed instruments such as an orchestra or string or brass ensemble. Here the loop length is set on the order of from several thousand to tens of thousands of cells.

In such a long loop there may be a problem of volume, pitch and timbral transitions between the end and the beginning of the loop. Such problems are solved by using the "cross-fade" and "back-and-forth" functions offered by the DSS-1. These let you process the sound to assure high continuity when using long loops.

If the loop on/off parameter is set to "on," then all sounds within the multisound will be looped according to their particular and individual start point and loop length values.

This suggests a way of making a looped sound appear as if it is not looped. Simply set the start point at the very end of the sample and set the length to 1. After reproducing the entire sound, the DSS-1 will start to loop this single piece of data, but since there is no change in the level, there is no alternation in the waveform and so no audible sound.

- Example: Making a multisound which includes drums and bass sounds.

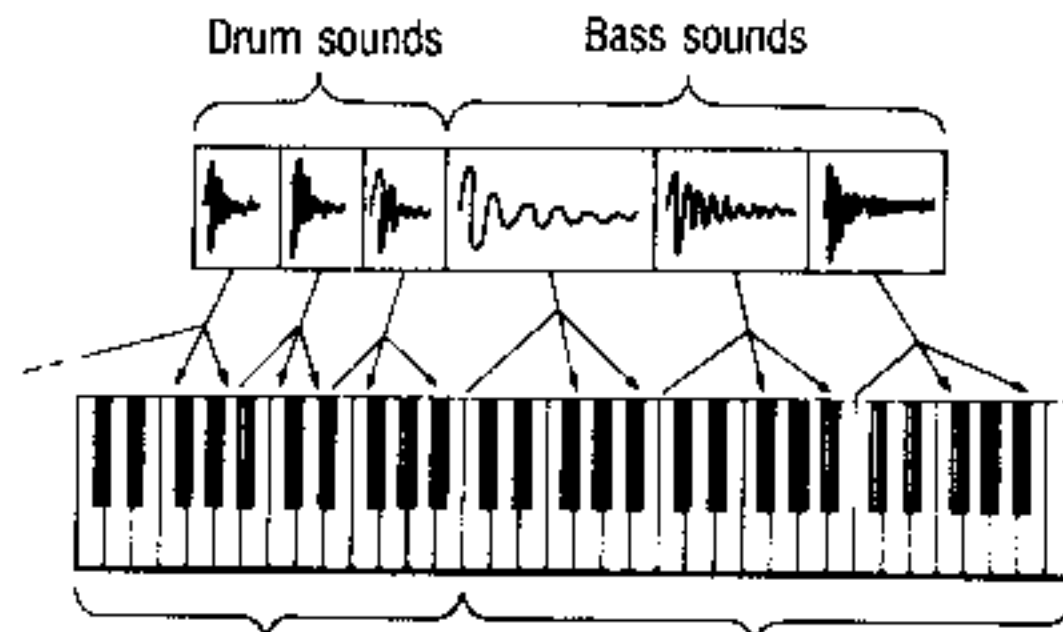

For each of these drum sounds, set the loop length to 1 and set the start point to the final address in memory.

Loop these bass sounds in the normal manner.



Loop start point is at the end of the sound. Loop length is 1.

Played with loop on.

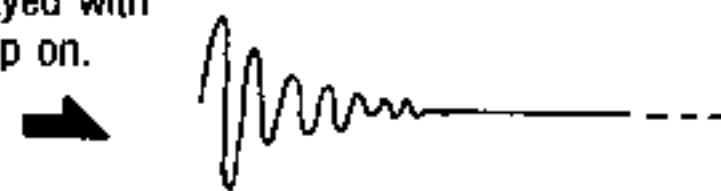

The looped portion of the waveform has no change in amplitude and is not audible as a sound. (The whole sound appears the same as if it were not looped.)

- V) The sound start & length parameters let you decide which portion of each sound to use. The sound start point is specified as a memory address. The length is specified as a number of memory cells. Note that if you have the loop on/off parameter turned on for the multisound, then the sound length setting has no effect.

● Sound start & length

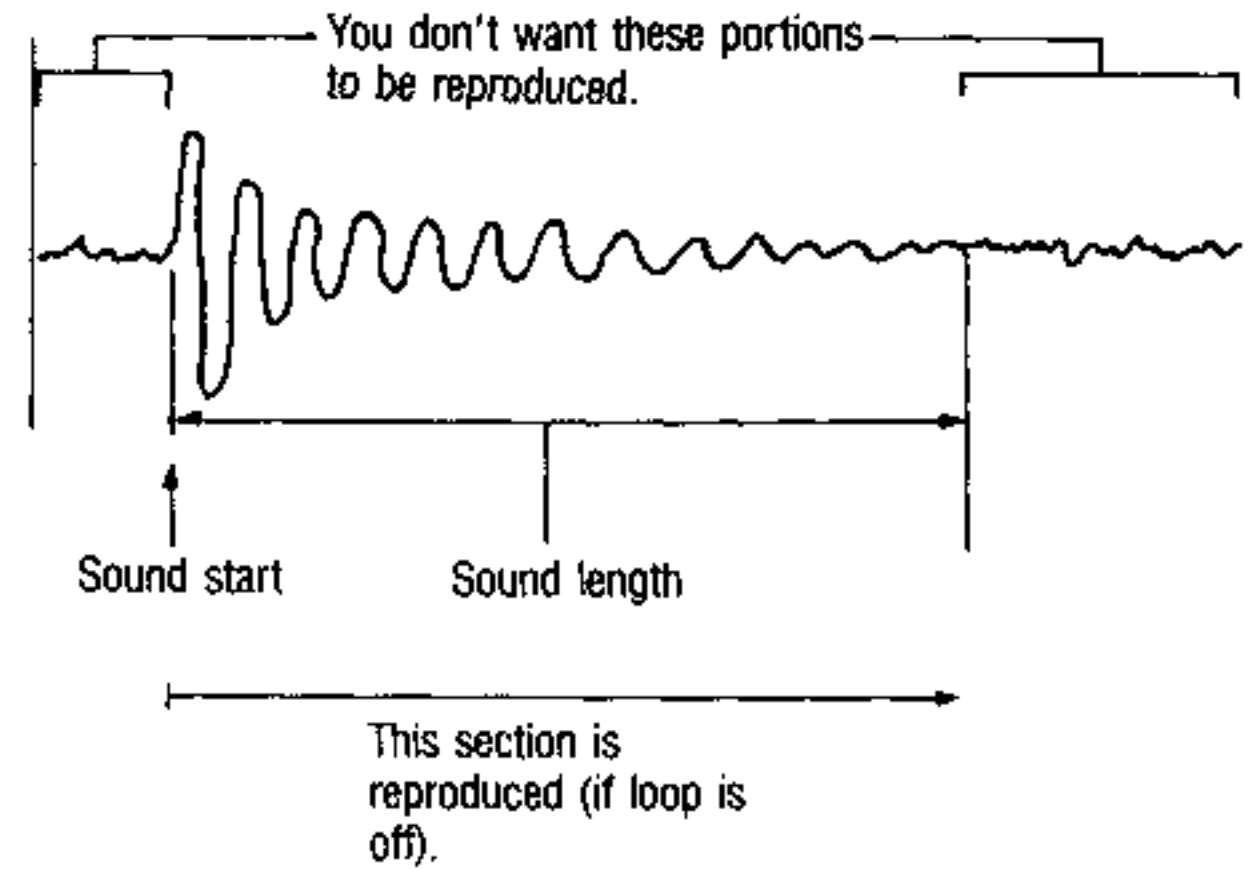

- VI) The tune/level/cutoff frequency parameters are used to compensate for variations between the sounds in a multisound. These parameters are adjusted for each sound in the multisound.

With the tune (relative tuning) parameter you can adjust pitch over a range of  $+/- 50$  cents by setting the value over a range of  $-63$  to  $+63$ .

<b>Possible values for the relative tuning parameter.</b>		
-63	~	00
		~
		+63

With the level (relative level) parameter you can attenuate the volume of a sound. The value range is 01 to 64, with 01 being the lowest volume.

<b>Possible values for the relative level parameter.</b>		
01	~	64

With the cutoff frequency (relative cutoff frequency) parameter you can reduce the sound's cutoff frequency, thereby making it duller or less bright. The range is 01 to 64, with a value of 01 being the duller.

<b>Possible values for the relative cutoff frequency parameter.</b>		
01	~	64

2 Examples of multisounds.

- Here we will present a few examples of multisounds produced by the methods that we have described in the previous sections.

■ The sounds assigned to the keyboard in this multisound were obtained by sampling and then truncating to remove the unneeded portions of the sampled sounds. This is the usual procedure when attempting to reproduce acoustic instrument sounds. The sounds should be looped if the instrument sound that you are trying to recreate has long sustain or is continuous. The loop is not needed if the goal is the recreation of a short, rapidly attenuated sound.

● Sounds with loop on. (Long loop or short loop.)

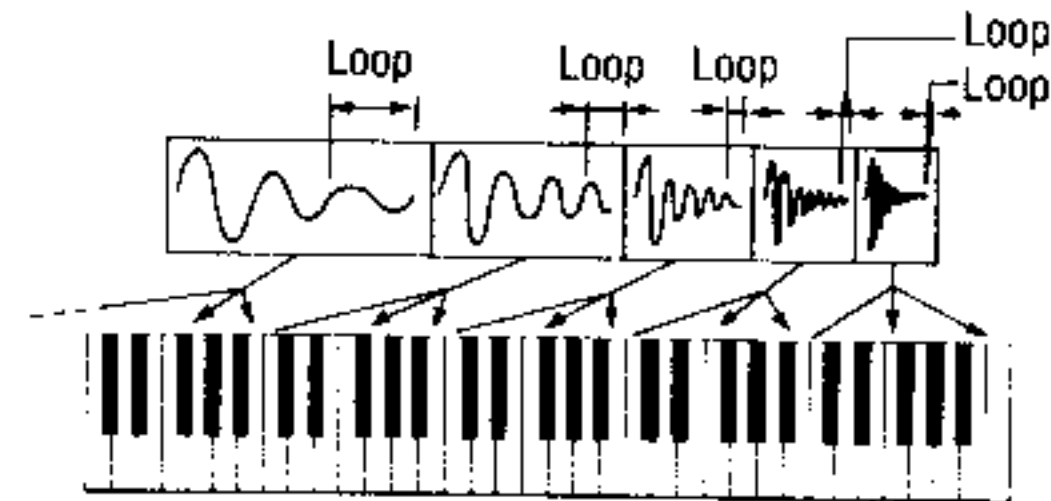

● Sounds with loop off.

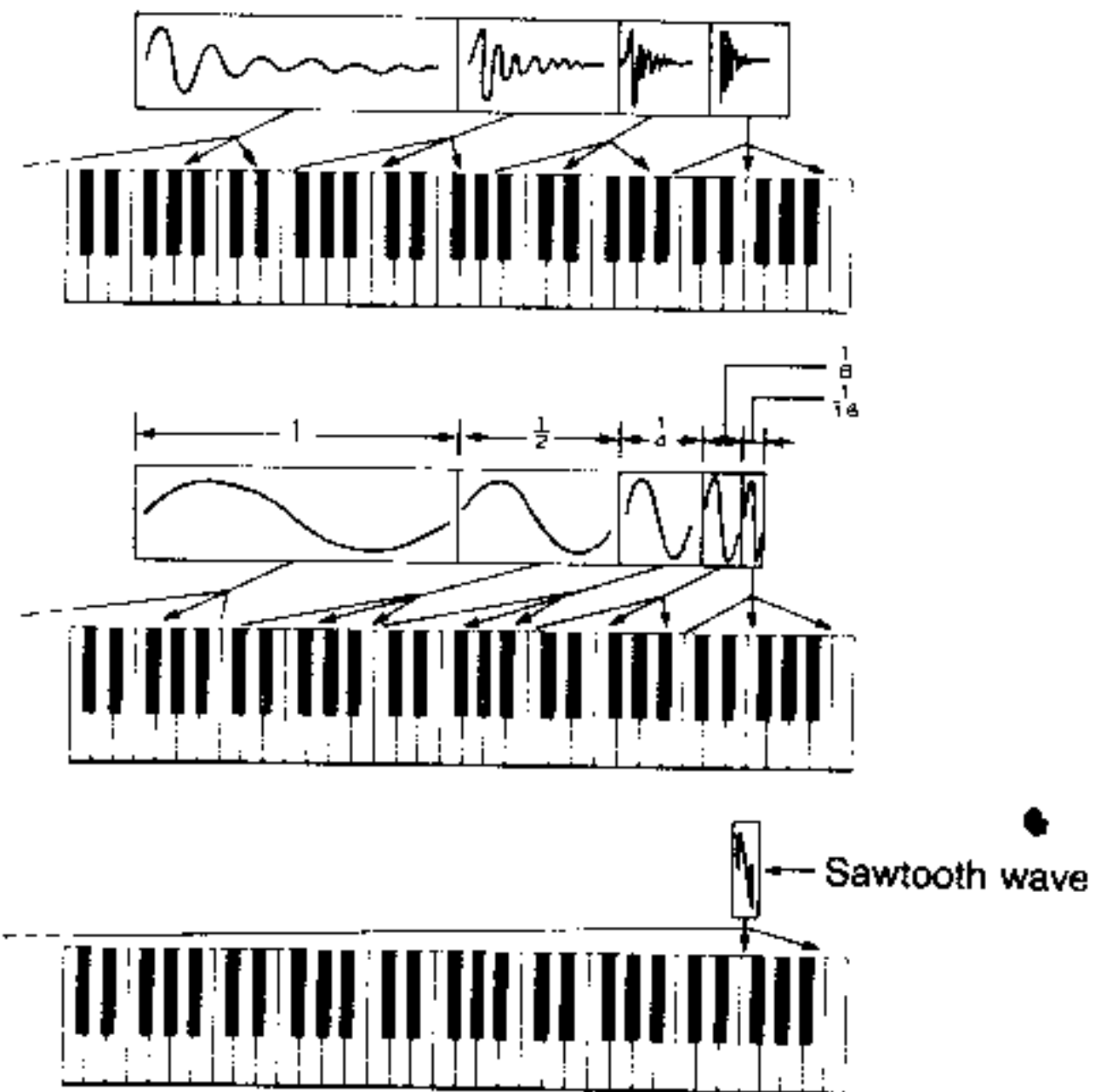

■ Here we have waveforms created by additive synthesis or hand drawing. Each wavelength is half again as long as the previous one, so each can be neatly assigned to an octave and looped. This works like the sound sources in a conventional analog synthesizer. With waveforms containing complex harmonics and with sine waves, it is a good idea to assign sounds to the lower reaches of the keyboard to avoid noise and distortion in that region when pitch is transposed downward by a large amount. However, with square and sawtooth waveforms, the same short sound can be used for the whole keyboard.

■ Here we have a multisound that contains sounds sampled at different frequencies and sounds created by additive synthesis and/or hand drawing. These have been edited and assigned to different portions of the keyboard. On the DSS-1, it doesn't matter how you obtain the sounds in a multisound. You can assign up to 16 sounds of any kind to the keyboard in any one multisound.

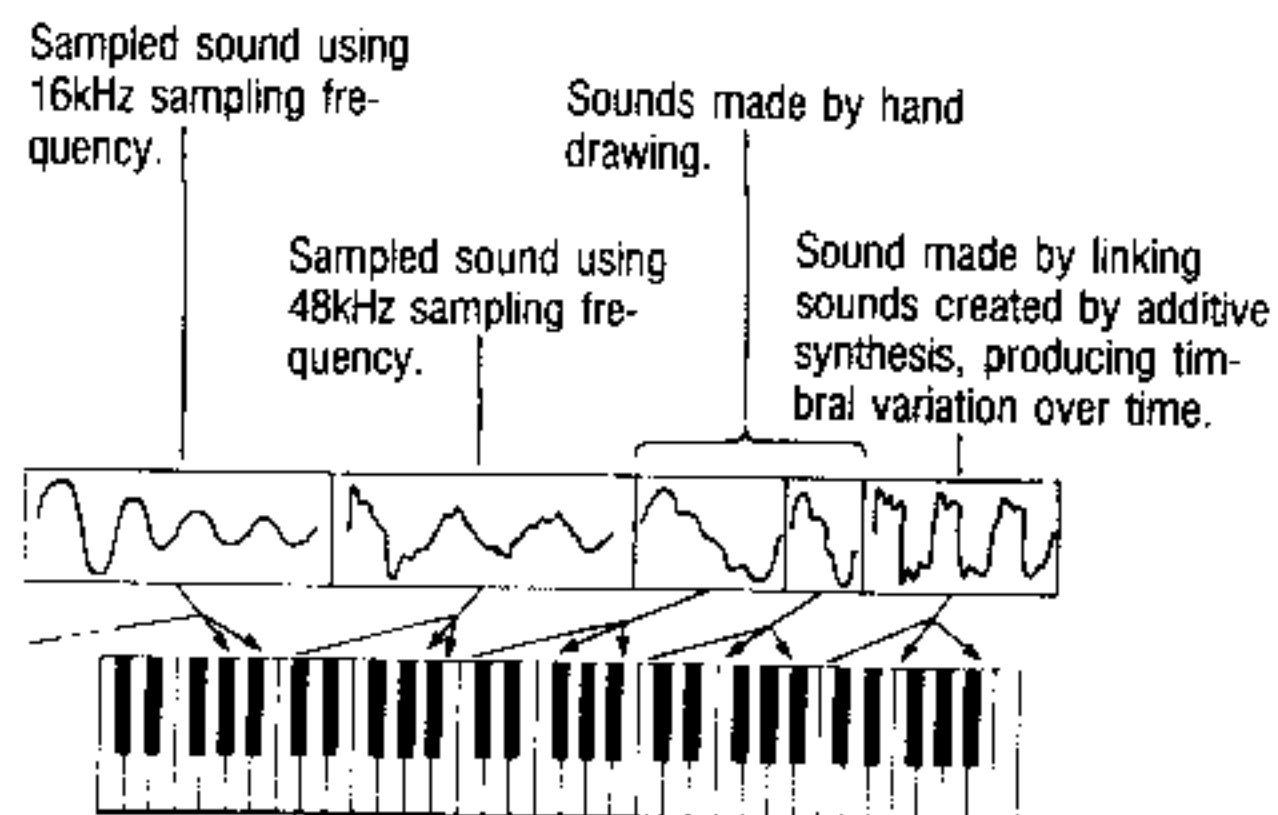

# 4. Using the Completed Multisounds

## 1 Multisounds and Synthesizer Operation

■ As we have described, up to 16 sounds may be assigned to the keyboard in each multisound. Furthermore, up to 16 MULTISOUNDS may be stored in wave memory at once. From among these 16 multisounds you can assign one multisound to oscillator-2 (OSC-2) and one multisound to oscillator-1 (OSC-1). (At this point, things become similar to the operation of a conventional synthesizer. Instead of choosing from square and sawtooth waves for each oscillator, you choose from your multisounds.)

■ From here on you can use the DSS-1 in almost exactly the same way as a conventional analog synthesizer. The multisounds simply serve as your sound sources or oscillator waveforms. You can change octaves, change the mix ratio, set intervals, detunings, automatic pitch bends, etc. You also use the VCF and VCA facilities in the usual way, and you can use the equalizer tone controls and digital delays to further process the sound.

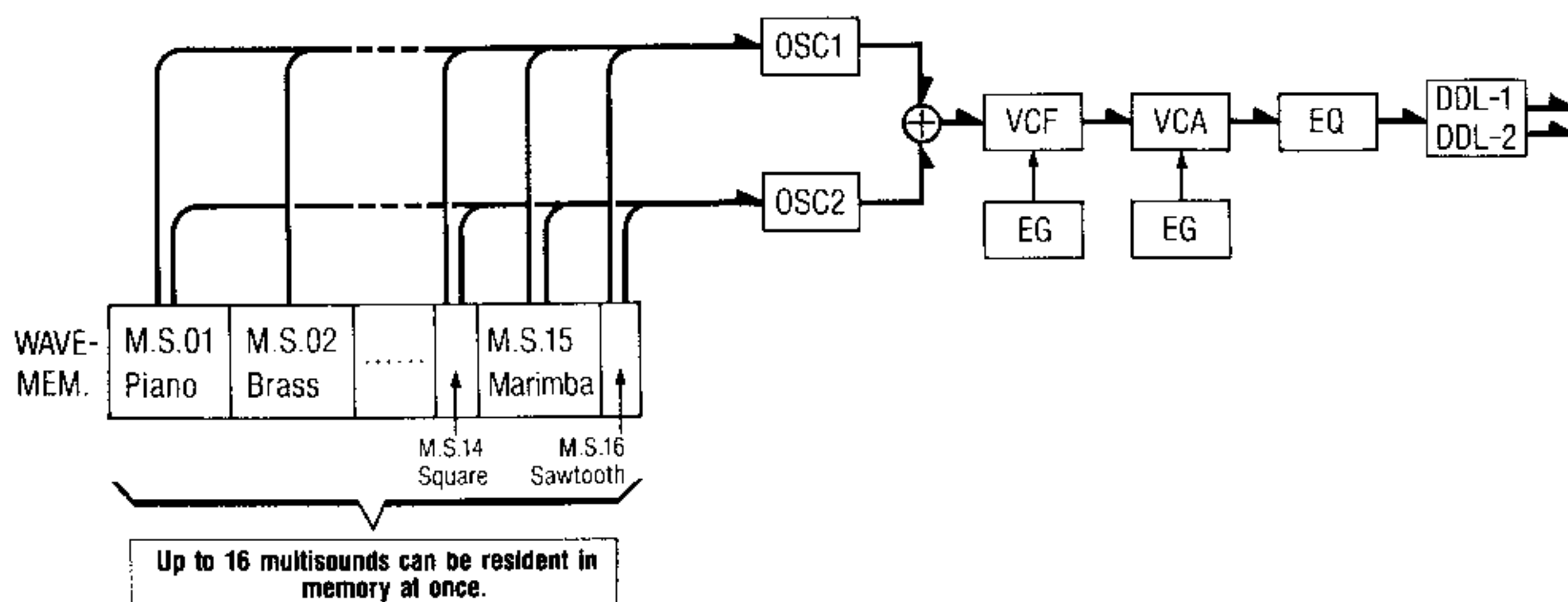

## 2 Tips for Synthesis With Multisounds

■ Though you have complete freedom to make many different sounds and assign up to 16 of them to the keyboard as one multisound, you only have one set of VCF, VCA and other controls to use to process them. In other words, you can't set the VCA EG to produce rapid attenuation for the lower half of the keyboard while producing long sustain for the top half.

For example, if you put bass in the lower part of the keyboard and put organ in the upper half, then you may want to use the VCA EG to provide an attenuating envelope for the bass. This will cause the organ to be attenuated as well, so it won't sound very organ-like.

Therefore, if you will be depending on the VCA for your envelopes, then you should not incorporate sounds having completely different envelopes in the same multisound.

- Example: Here we have a looped multisound with bass in the lower half and organ in the upper half of the keyboard.

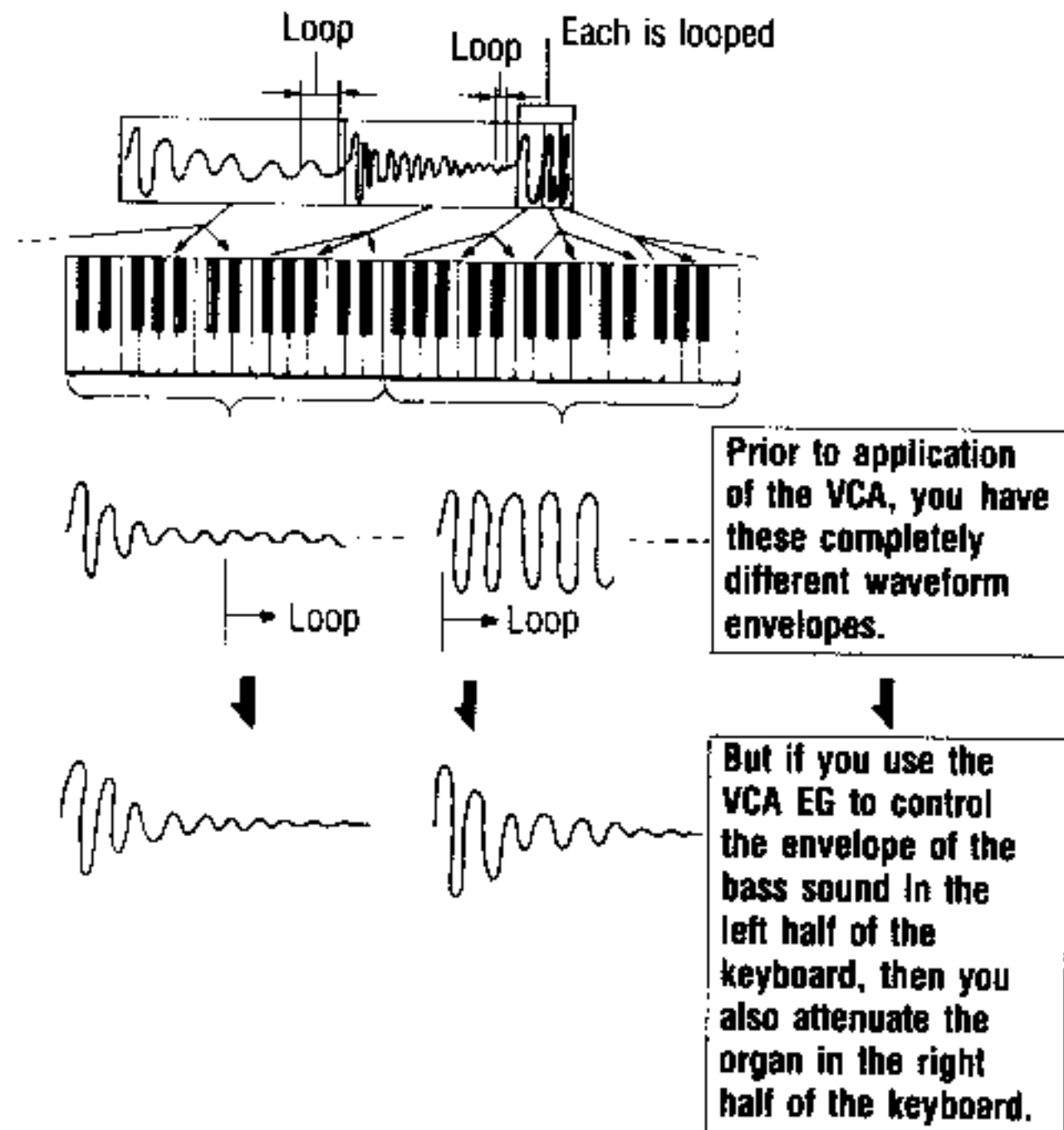

- Note that if the OSC-2 multisound goes higher on the keyboard (if its sounds are assigned to higher keys) than that of OSC-1, then no sound will be produced by the keys that exceed the upper limit of the OSC-1 multisound sound assignments.

In other words, it is the sound assignment range of oscillator-1 that determines the total range of the keyboard. (The same holds if you change the OSC-1 or OSC-2 octave or the OSC-2 interval.) (Refer to functions F11 and F15 for octave and interval details.)

- OSC-1 is using a multisound that has sound assignments up to C6. The OSC-2 multisound has sounds assigned up to C7. (The octave is 8' for both oscillators: oscillator-2 interval is 00.)

OSC-1 multisound.

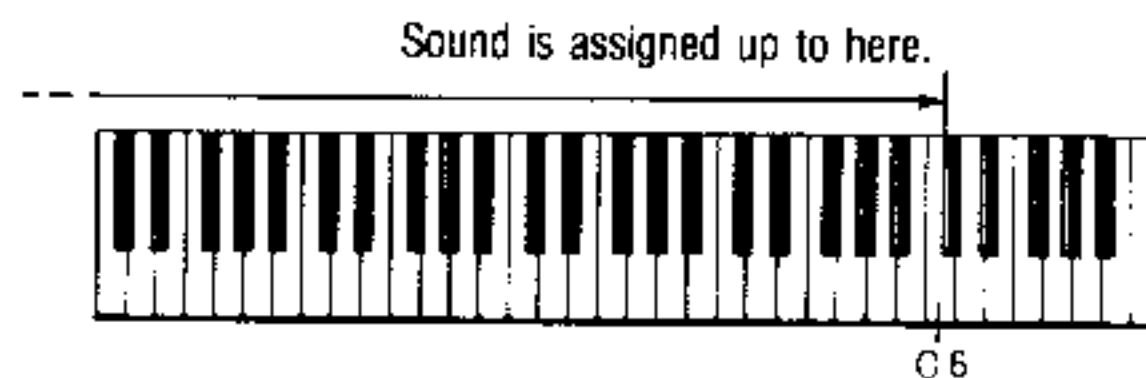

OSC-2 multisound.

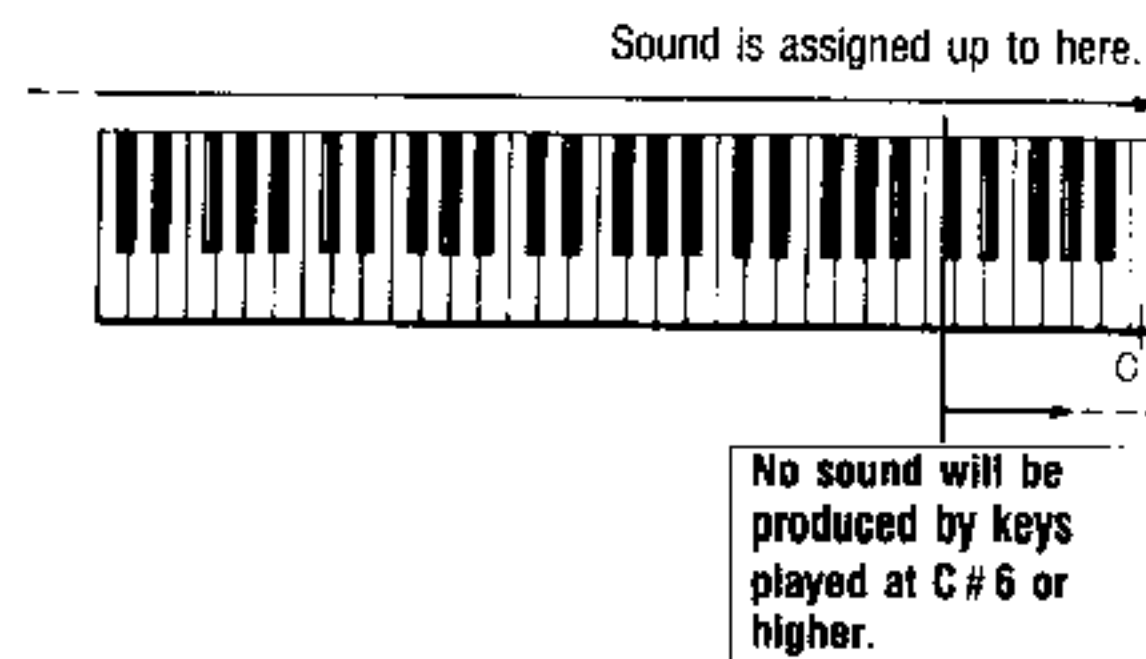

- When attempting to reproduce the sound of acoustic instruments by using sampled sounds, best results are achieved by taking many samples and assigning each to a narrow portion of the keyboard. (See page 40.)

For even greater fidelity, there is a way to extend beyond the limit of 16 sounds imposed by a single multisound. You produce two multisounds, and use a sound set to "length 1, level 0" as the highest sound in one and the lowest sound in the other (covering respectively the upper half and lower half of the keyboard).

● How to make 30 sounds available in one keyboard.

- I) Assign 15 sounds to the left half of the keyboard. Assign one "length 1, level 0" sound to the entire right half of the keyboard. Use this as one multisound.

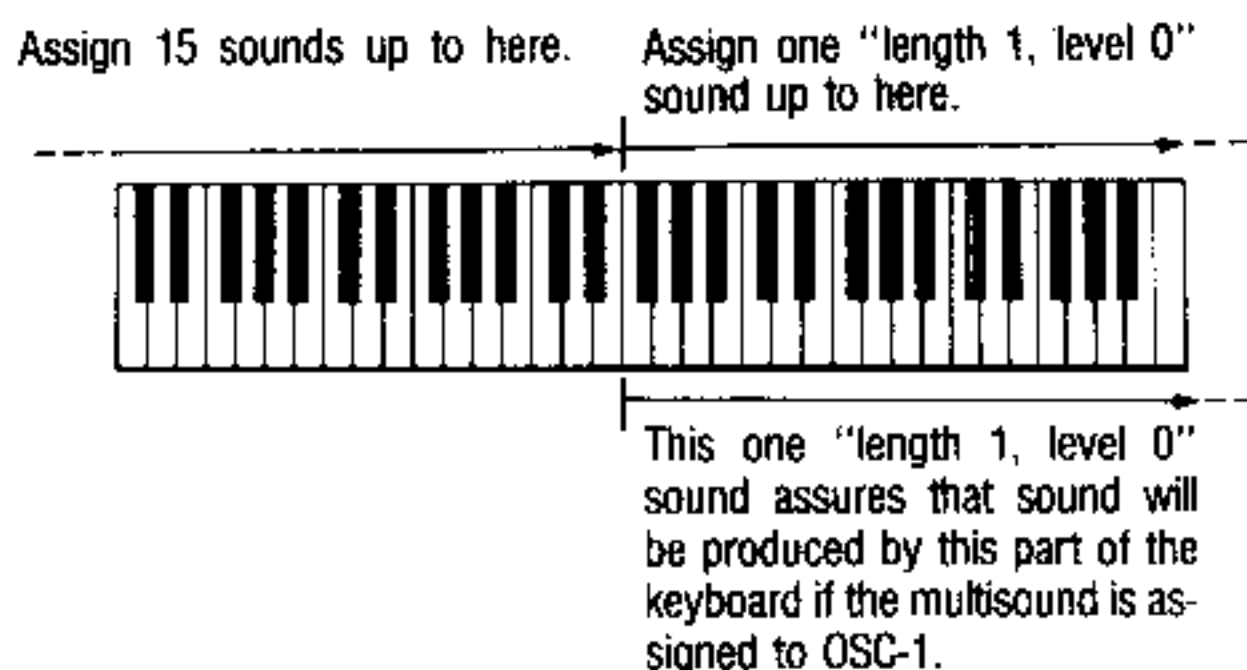

- II) Assign one "length 1, level 0" sound to the entire left half of the keyboard. Assign 15 sounds to the right half. This is your second multisound.

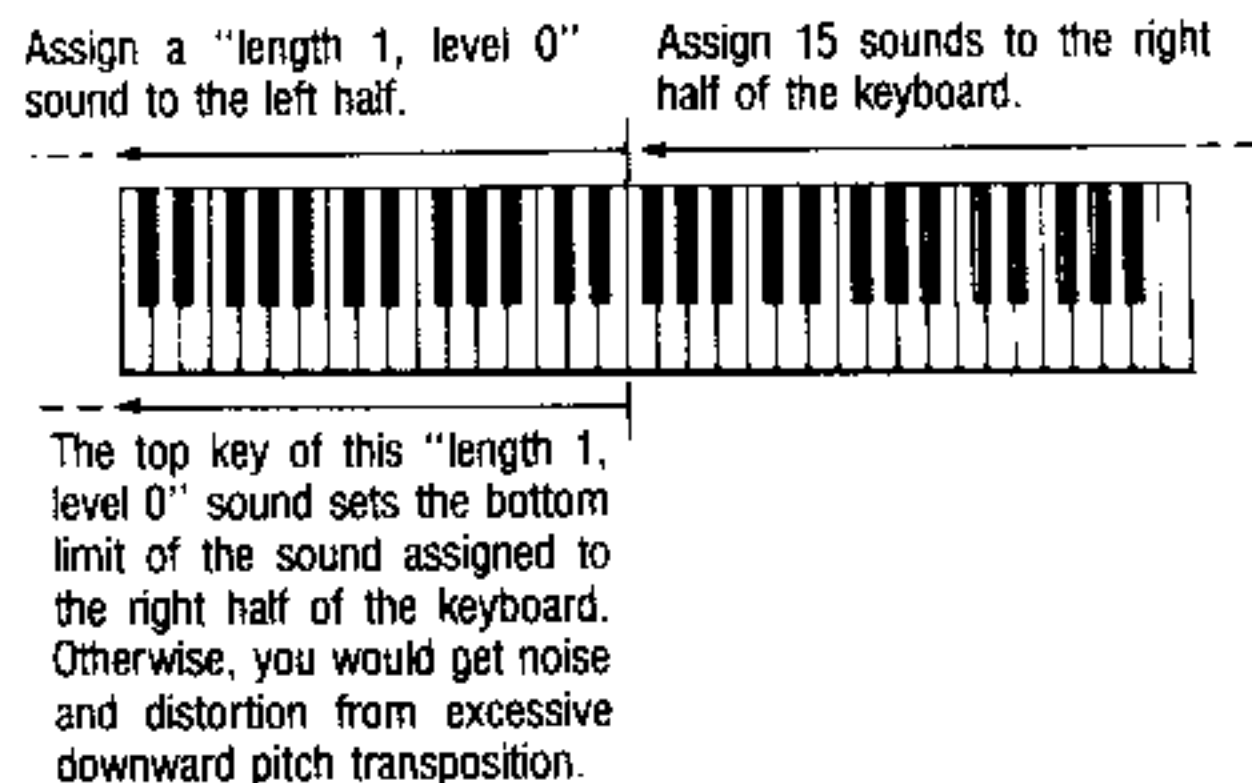

- III) Assign these multisounds to OSC1 and OSC2, respectively.

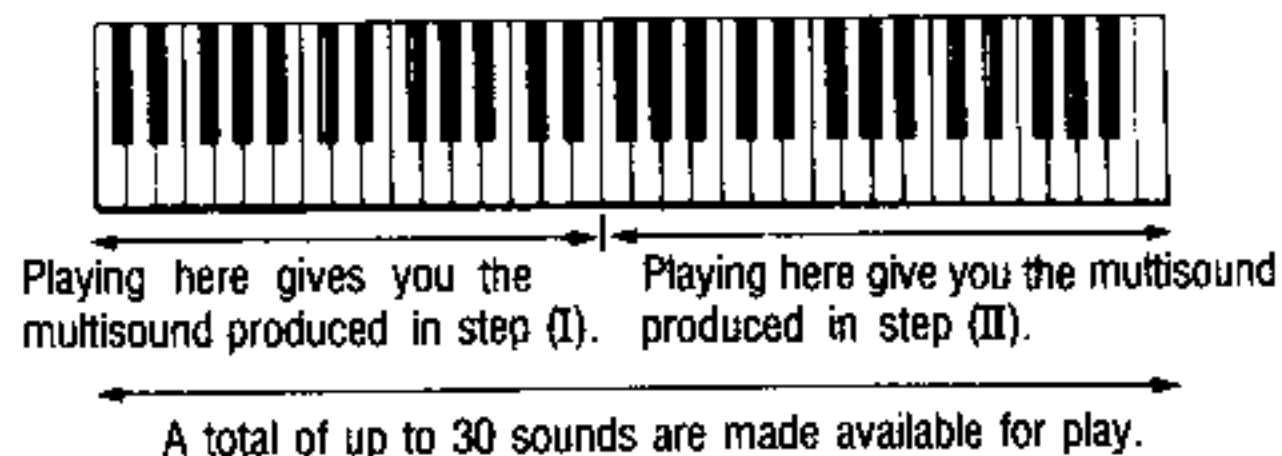

# DATA MANAGEMENT

## 1. DSS-1 Memory, Data Structure, and Systems

### 1. DSS-1 memory arrangement and data storage

■ DSS-1 internal memory is divided up into three main sections; These are wave memory, program memory, and the program output buffer. This arrangement is shown in the diagram here.

#### ● DSS-1 Memory Arrangement

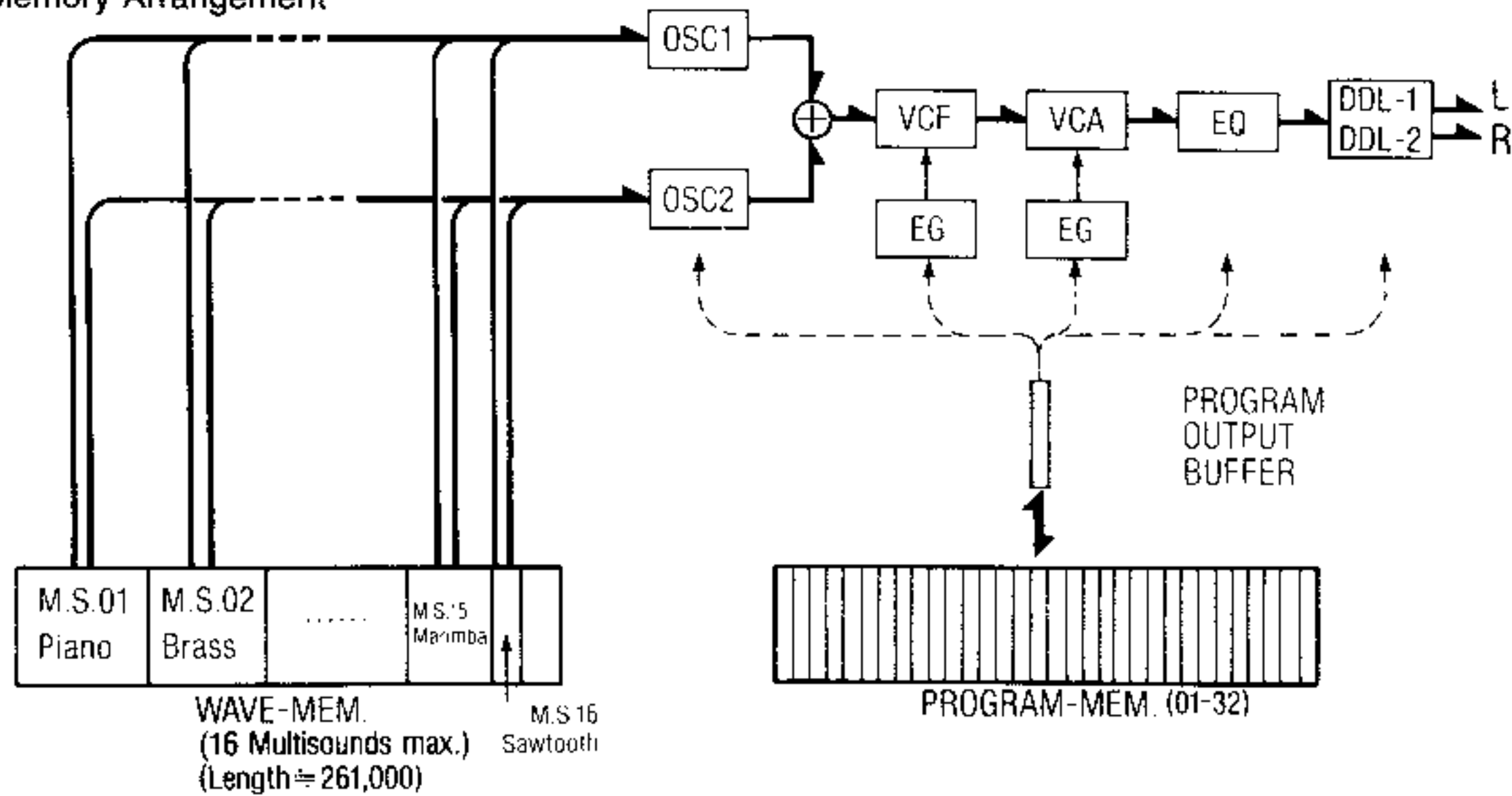

■ Wave memory is used for three purposes. First, it is used to hold and edit sounds. Second it is used to make single multisounds. Third, and finally, it is used to store a number of multisounds.

Wave memory has a capacity of 261,000 "data words" or samples. This is about enough for a 16 seconds digital recording at a 16kHz sampling frequency (since 16,000 samples per second times 16 seconds equals 256,000), or 11 seconds at 24kHz, or 8 seconds at 24kHz, or 8 seconds at 32kHz, or 5.5 seconds at 48kHz.

This same wave memory can be used to hold up to 16 multisounds as long as the total data does not exceed this capacity. (Therefore, OSC-1 and OSC-2 can each use any one of these 16 multisounds.)

■ The point is that wave memory can not be used for more than one of these purposes at a time. (Nor can it usually be used to process different data at the same time even if the purpose is the same.) For example, if you try to make a new multisound when wave memory is being used to store a number of multisounds then you will destroy all of your stored multisounds. Similarly, if you have completed a multisound in wave memory and then try to make another multisound or edit a sound, you will destroy the completed multisound. Use the disk for storage of memory contents when you want to use the memory for another purpose or to process different data.

#### ● Uses of Wave Memory

- For temporarily storing and editing a sound.
- For making a multisound.
- For storing a number of multisounds.

- Wave memory capacity is about 261,000 words.
- Wave memory maximum multisound storage capacity is 16.

- After completing one multisound, if you try to use wave memory to complete another multisound, the first multisound will be destroyed.

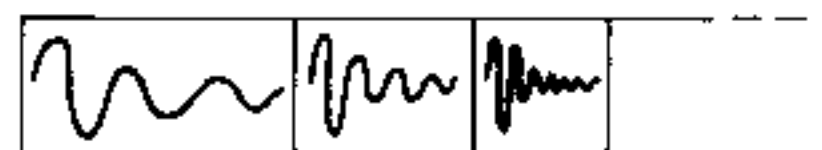

After making one multisound.



If you go through the process of making a multisound.



The first multisound is destroyed.



- Program memory holds 32 programs (sound patches). Each program contains all of the data needed to reproduce one completed tone color. This data includes your settings for the OSC-1 and OSC-2 multisounds, the VCF cutoff frequency, the EG envelopes, and so on and so forth.

You can have immediate access to any one of these 32 programs from program memory, each of which can in turn call up two multisounds from among those in wave memory.

- Uses of program memory. Holds 32 programs or patches, each of which comprises settings for the oscillator multisounds, VCF, VCA, EG, EQ, DDL, etc.

Prog.01	Prog.02	.....	Prog.31	Prog.32
OSC1 =	OSC1 =		OSC1 =	OSC1 =
OSC2 =	OSC2 =		OSC2 =	OSC2 =
VCF =	VCF =		VCF =	VCF =
VCA =	VCA =		VCA =	VCA =
EG =	EG =		EG =	EG =
EQ =	EQ =		EQ =	EQ =

- The program output buffer is used to hold a program temporarily. The OSC-1, OSC-2, VCF, VCA, and other parameter values reflect the data in this output buffer.

When you change programs, your newly selected program is copied from program memory to this output buffer, producing a different sound by affecting the settings of the various parameters. (In other words, the current sound is determined by the data currently in the program output buffer.)

When you edit a program, you are editing the data that is in this output buffer. When you want to save an edited program, you must write the data to program memory.

Since the data in the output buffer affects the sound, you will usually want to perform the F00 INITIALIZE PARAMS function to clear it before sampling and making multisounds. This prevents the VCF, EQ, DDL and other parameters from changing the sound.

- In addition, the DSS-1 also has a portion of memory reserved for the MIDI parameters. (We may call this MIDI parameter memory.) See page 294 for details on the DSS-1 and MIDI.

- Use of the program output buffer. Temporarily holds a single program.

- Program selection

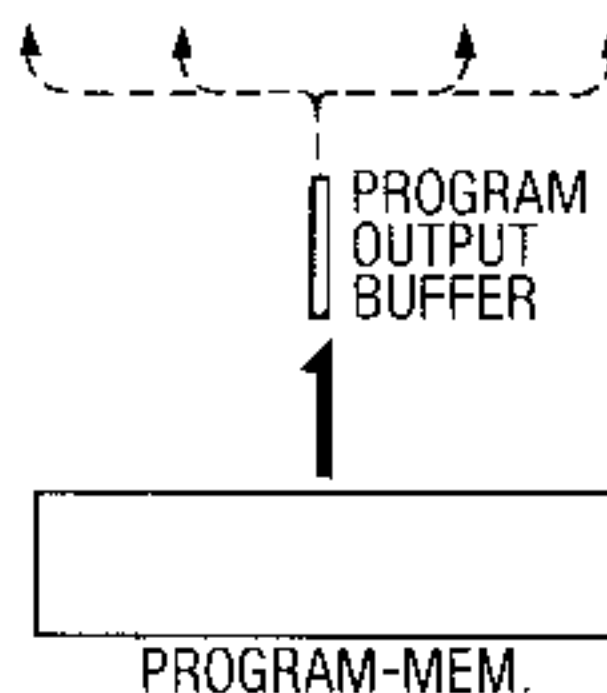

Program data is transferred from program memory to program output buffer.

- Program write.

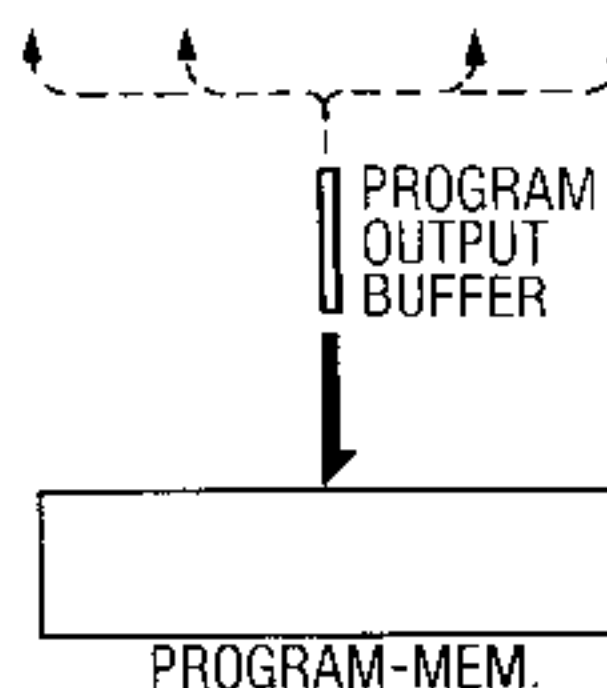

Program data is transferred from program output buffer to program memory.

## 2 System

■ The DSS-1 can hold a maximum of 16 multisounds in wave memory at one time. It also holds 32 programs in program memory. The currently selected program is transferred to the program output buffer to determine which multisounds are to be used and how the various parameters are going to affect the sound.

One set of these multisounds and programs is called a "system."

■ The system format is employed because it keeps the multisounds together with the programs that use them. You can think of each system as "one complete synthesizer system." You can save systems to disk and then load them back to internal memory (using the "get system" function) without losing the dependent relationship between the programs and the multisounds. Needless to say, this kind of internal order is essential in a synthesizer having the capacity of the DSS-1. If multisounds and programs were not organized as systems then you would have to make sure that you had loaded the correct multisounds for the programs that you were going to use. If you had them on different disks, the problem would be compounded.

### ● System structure

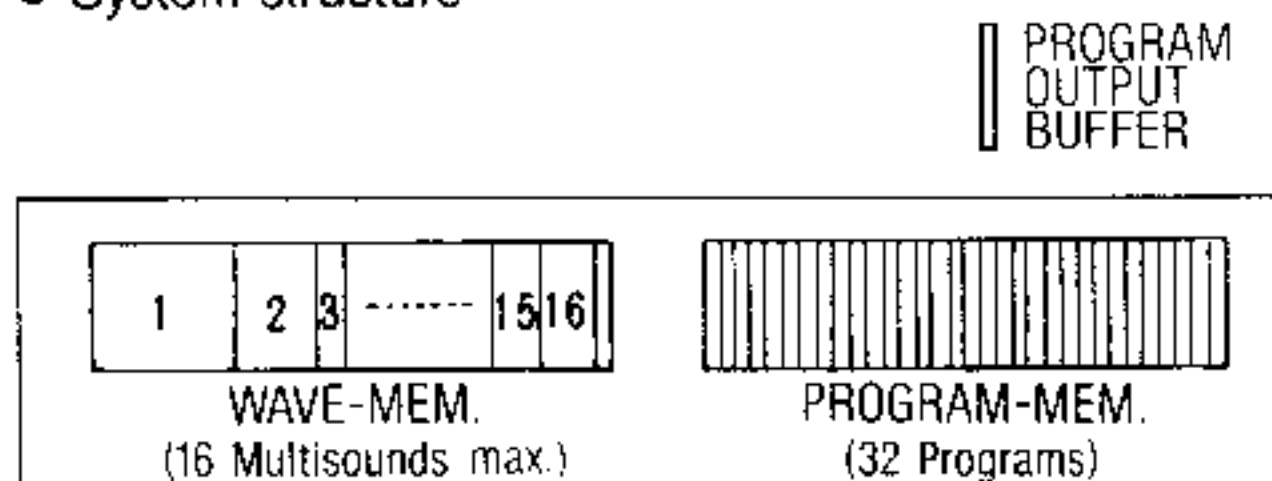

A system includes the multisounds in wave memory and the 32 programs that call those multisounds.

● When you save a system, you are putting these multisounds and programs onto a disk.

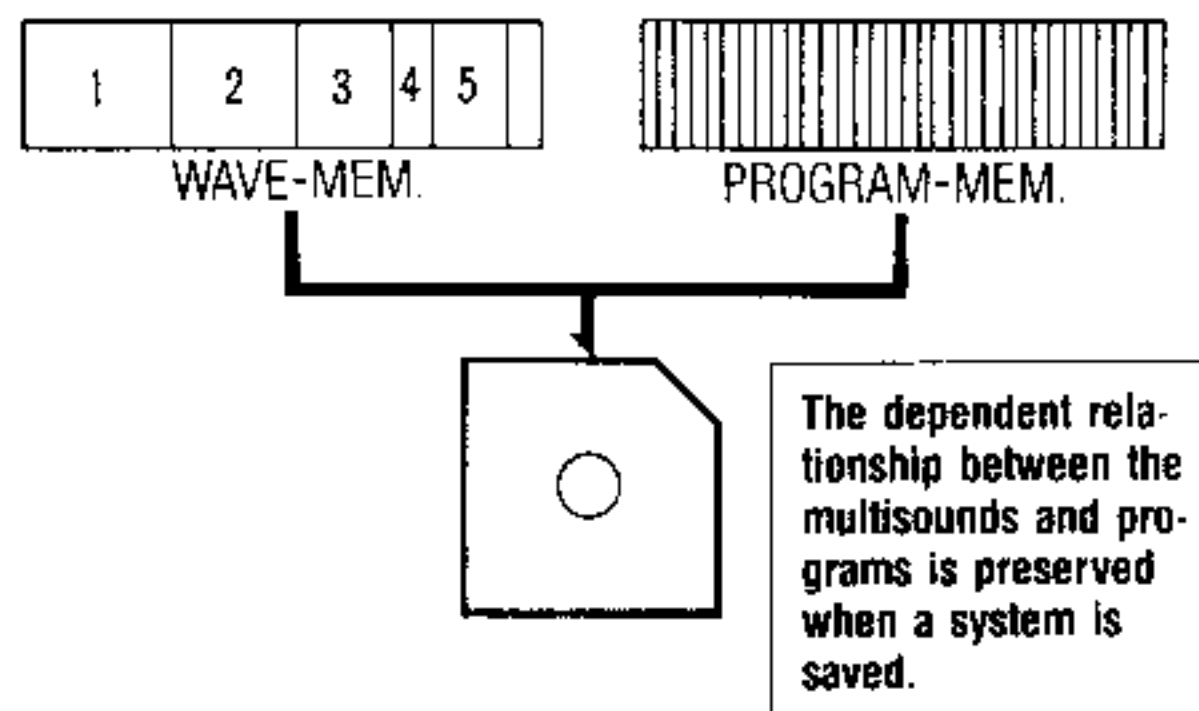

The dependent relationship between the multisounds and programs is preserved when a system is saved.

● When you get a system you are getting both multisounds and programs.

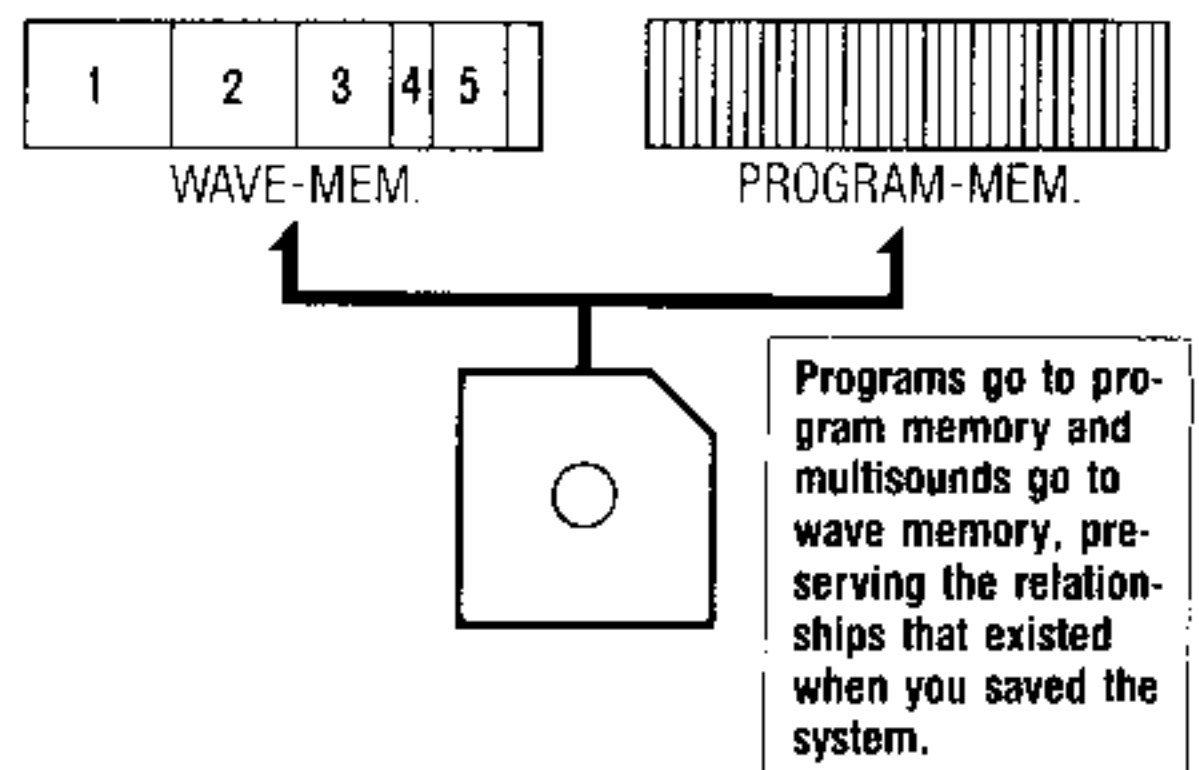

Programs go to program memory and multisounds go to wave memory, preserving the relationships that existed when you saved the system.

So there's no need to load multisounds and programs separately from disks.

To allow more multisounds to be stored in wave memory and be available to the programs in each system, it is necessary to conserve memory space. Therefore, you use the truncate function to cut off and throw away the unneeded portions of each sound or waveform used in each multisound. Unneeded portions are the portion before the sound start point and the portion after the end of the loop length.

- Use the truncate function to remove unneeded parts of the sounds that are the components of each of the multisounds. This lets you store more multisounds.

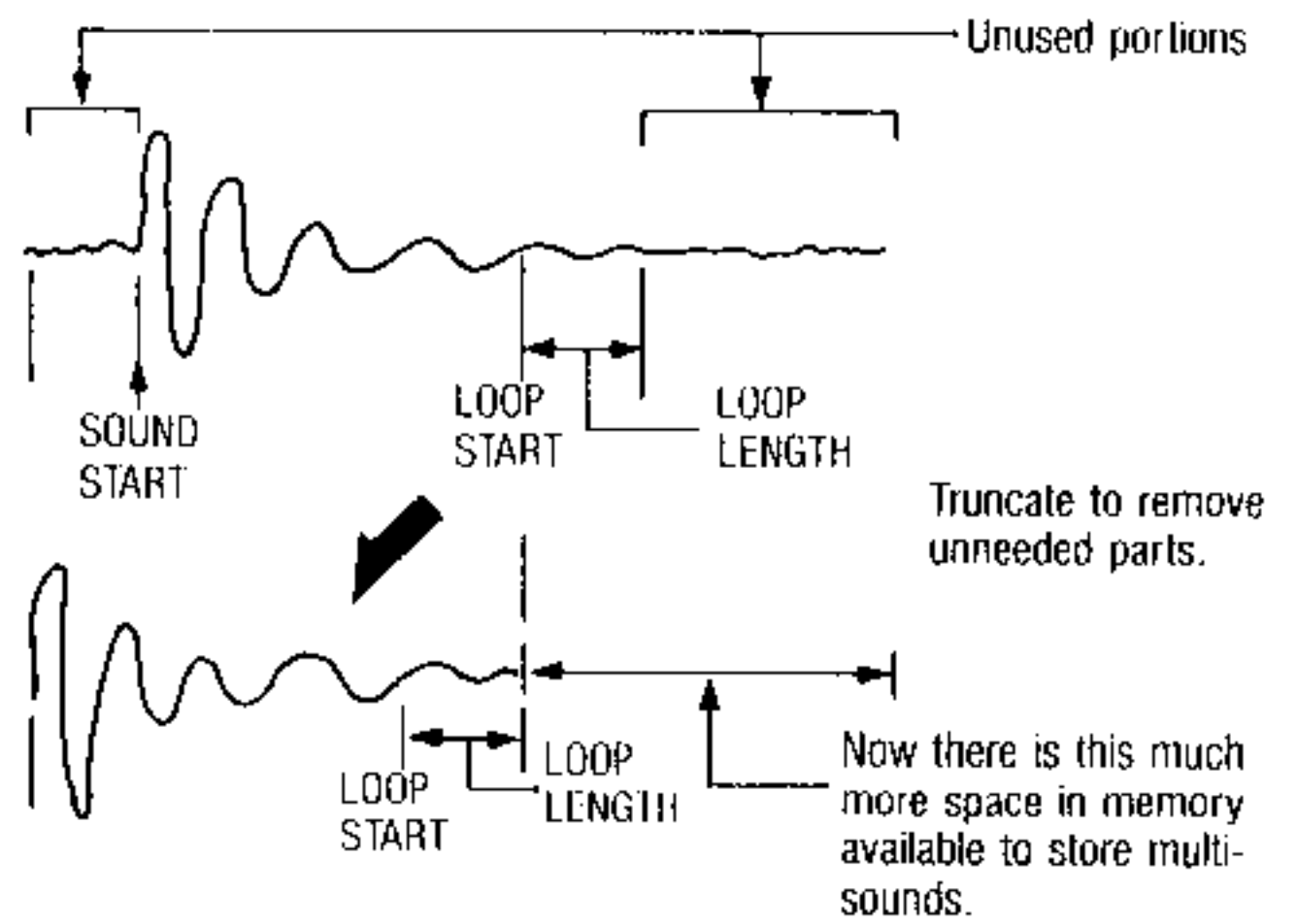

# 2. Floppy Disks and Data Management

## 1. Data structure on DSS-1 floppy disks.

■ The DSS-1 has a built-in floppy disk drive. This is used to store and retrieve your waveform and program (patch) data from floppy disks. A single floppy disk can store four "systems," which are called A, B, C, and D.

In the example in figure 2, you can see how the data is related and grouped on a single floppy. There is one set of MIDI parameters (MIDI PRMS). There are four sets of programs (P01 to P32), one set for each of the four systems (A through D). Then there are the multisounds and sounds. You can store up to about 120 multisounds and sounds, as long as the total does not exceed the 520,000 data "word" limit (each of which corresponds to one memory cell).

Programs (the patches numbered P01 to P32) are stored separately for each system. However, multisounds are shared. That is, the same multisound can be used by any or all of the systems.

In the example, the number 2 multisound (M.SND 02) is used by all four of the systems, while multisounds 4 and 6 are used by none.

The individual "sounds" (that compose the multisounds) are not directly linked to the systems. However, the sounds share storage space with the multisounds.

In the diagram, the multisounds (M.SND) that are marked with an "(a)" will be loaded into the DSS-1's memory when you "get" system A. Likewise, multisounds marked with "(b)", "(c)", or "(d)" will be loaded when you "get" one of those respective systems. Below the programs for each system (in the diagram), is a multisound list (M.SND LIST). This connects the programs (which are separate for each system) to the multisounds (which are shared by any systems that need them). The multisound list is created automatically and used when you "save" or "get" a system.

As shown in the chart (P. 54), you can save and load individual multisounds, sounds, and other data to and from the disk, independently of the systems (that is, without using the "get system" and "save system" functions). In such cases, remember that the relationships between multisounds and programs (as recorded in the multisound lists) remain unchanged. Likewise, if you delete a multisound that is used by a program (as recorded in the system's multisound list), then when you later try to use that program (patch), you will no longer have that multisound as a sound source.

It is highly recommended that you categorize your disks. Use some disks for storing your basic sounds. Use other disks for storing programs and multisounds. And use still others for storing and retrieving your completed systems. This not only makes it easier to find what you're looking for, it also uses disk storage space most efficiently and provides a degree of data backup security.

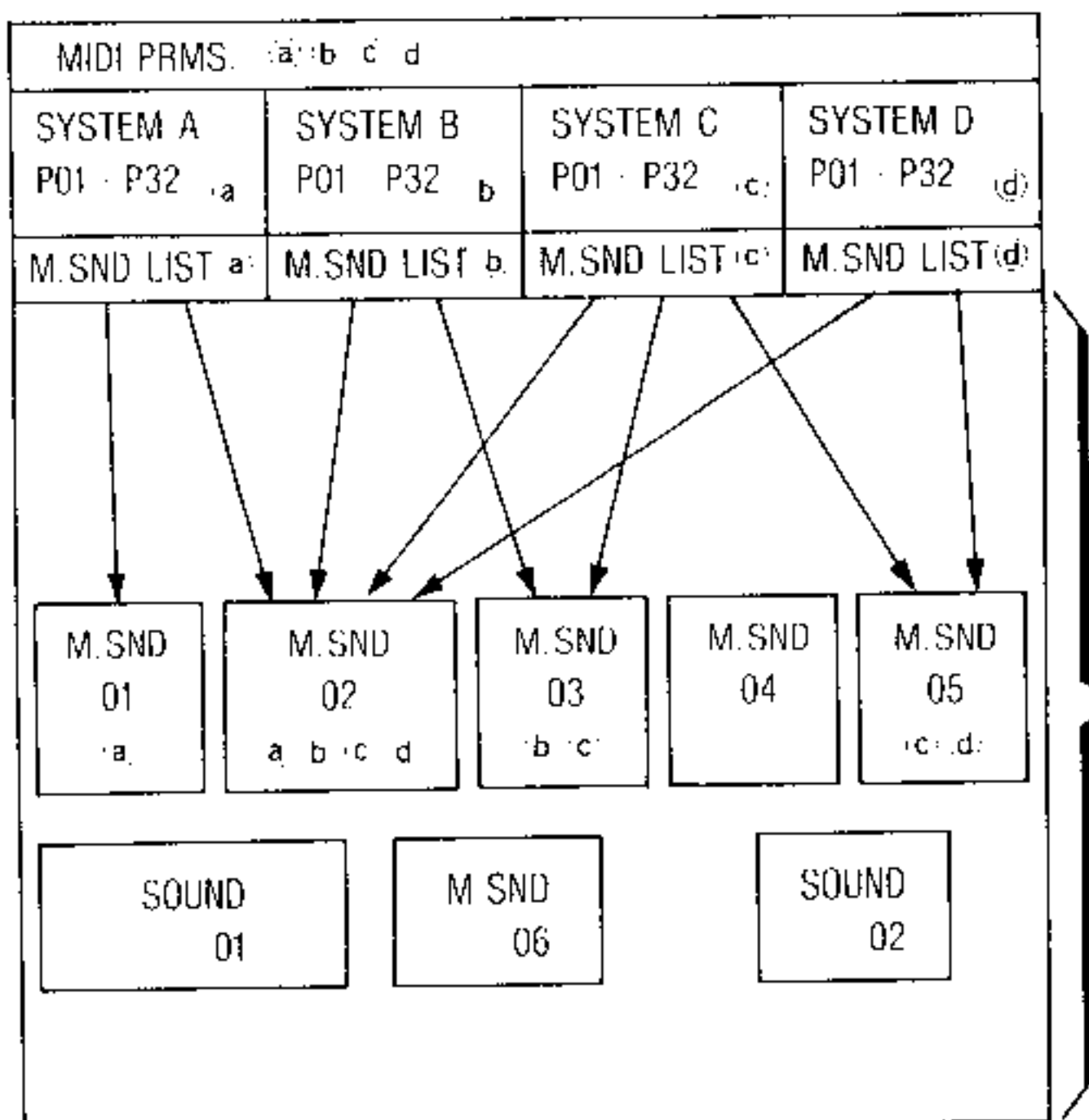

Total may not exceed about 520,000 data words (about twice the capacity of DSS-1 internal memory).

---

## 2) Sound, multisound naming

- Each sound and each multisound are given a name that is up to eight characters in length. Data is then handled under that name. The same name can not be used for different data (of the same type) on the same disk. If you save data to disk under a particular name and other data existed on the disk under that name, then the old data will be lost, being overwritten by the new data. This makes it easy to update data, but requires that you be careful when assigning names.

However, a multisound and a sound may share the same name on the same disk.

- Characters available for use in names. Up to eight per name.

	!	#	\$	%	&	'	(	)	+	,	-	.	/
0	1	2	3	4	5	6	7	8	9	:	;	<	=
>	@	A	B	C	D	E	F	G	H	I	J	K	L
M	N	O	P	Q	R	S	T	U	V	W	X	Y	Z
[	\	]	^	_	`	a	b	c	d	e	f	g	h
i	j	k	m	n	o	p	q	r	s	t	u	v	
w	x	y	z	{		}	~	+	+				

These characters are used for naming multisounds, sounds, and programs in the DSS-1.

Note that you can not assign a name that uses spaces (blanks) in all eight character positions.

③ Functions concerned with moving data to and from disk.

Direction of movement Data	Disk to Memory	Memory to Disk	Notes	
MIDI PARAMETERS	(1) GET SYSTEM (SYSTEM MODE F1)	(1) SAVE SYSTEM (SYSTEM MODE F2)  (2) SAVE MIDI PARAMETERS (MIDI MODE F5)	One set for all four systems on a single disk. The most recently stored parameters are the parameters that you will get if you load a system from disk.	Data types included in a system.
PROGRAM(ONE)	(1) GET PROGRAM (SYSTEM MODE F4)		Choose system (A-D) and program number (P01-P32).	
PROGRAMS (P01 ~ P32)	(1) GET SYSTEM (SYSTEM MODE F1)  (2) GET ALL PROGRAMS (SYSTEM MODE F5)	(1) SAVE SYSTEM (SYSTEM MODE F2)  (2) SAVE ALL PROGRAMS (SYSTEM MODE F6)	Handles all programs (P01-P32) in a chosen system (A-D).	
MULTISOUND	(1) GET SYSTEM (SYSTEM MODE F1)	(1) SAVE SYSTEM (SYSTEM MODE F2)	Handles all multisounds in a chosen system.	Data types not included in a system.
	(2) GET MULTISOUND (SYSTEM MODE F9)	(2) SAVE/RENAME MULTISOUND (MULTISOUND MODE F9)	Handles a single multisound. Use DISK UTILITY MODE F6 to delete.	
SOUND	(1) GET SOUND (MULTISOUND MODE F10)  (2) SELECT SAMPLE (EDIT SAMPLE MODE F1), also <ul style="list-style-type: none"> <li>● LINK (EDIT SAMPLE MODE F5)</li> <li>● MIX (EDIT SAMPLE MODE F6)</li> <li>● REPLACE (MULTISOUND MODE F8)</li> </ul>	(1) SAVE SAMPLE (SAMPLE MODE F5), SAVE/RENAME SAMPLE (EDIT SAMPLE MODE F8)  (2) SAVE WAVEFORM (CREATE WAVEFORM MODE F3)	Handles a single sound.  Use DISK UTILITY MODE F5 to delete.	

# GENERAL OPERATION

## 1. Overview of the operation modes

### 1) Sample Mode

#### ■ Functions of the sample mode.

Functions in this mode let you make a digital recording of an audio signal received through the AUDIO IN jack on the DSS-1. This process is called "sampling." The sampled sounds are stored in wave memory and used to produce a multisound.

- You can set the multisound length to "full" or "half"
- The multisound assembled here will have 1, 2, 4, 8, or 16 parts, each of which will be a sampled sound (or simply a "sample") of the same time length and using the same sampling frequency (but having a different wavelength).

- ★ Wave memory is used as the sampling data storage area. Any previous multisound data in memory is lost during the sampling process. Therefore, before using the sample mode, be sure to save current wave memory contents to disk as sounds or multisounds (assuming that you want to keep that data).
- ★ In this mode you can put a name on a sample and save it to disk as a sound. However, to save it as a multisound you must first change to the multisound mode.

### 2) Create Waveform Mode

#### ■ Functions of the create waveform mode

This lets you use additive synthesis or "hand drawing" to create a waveform. It also lets you choose one waveform from within a multisound and save it to disk as a sound.

- ★ Immediately after hand drawing, it is possible to edit the values of individual data words.
- In this mode, first the waveform assigned to the lowest octave is created. Then eight other waveforms are made, each having half again the wavelength of the one next lowest on the keyboard. (That is, 1/2, 1/4, ... 1/128). These form the components of the multisound.

- Initial display in the sample mode.

```

*** SAMPLE MODE ***
Select S. Freq. = 32kHz
  
```

Parameter settings for multisounds made in the sample mode.

- Multisound name: ! NO NAME
- Length
  - Full: 261886
  - Half: 130942
- Loop ON
- Relative tune: 00
- Relative level: 64
- Relative Fc: 64

- Initial display for create waveform mode.

```

*CREATE W. FORM MODE*
Select (1-2): ...
  
```

- ★ F3 can not be selected until hand drawing or additive synthesis are performed.

### ● Parameters of Multisounds Produced in the Create Waveform Mode

Multisound name: ! NO-NAME								
Multisound length: 1020                      LOOP ON								
Sound number	S01	S02	S03	S04	S05	S06	S07	S08
Relative tune	+09	+10	+11	+12	+13	+14	+15	+16
Relative level	64	64	64	64	64	64	64	64
Relative Fc	64	64	64	64	64	64	64	64
Sound start	0	0	0	0	0	0	0	0
Sound length	512	256	128	64	32	16	8	4
Loop start	0	0	0	0	0	0	0	0
Loop length	512	256	128	64	32	16	8	4
Original Key	B1	B2	B3	B4	B5	B6	B7	B8
Top key	F2	F3	F4	F5	F6	F7	F8	F9

(S01 is the waveform data created first.)

### [3] Edit Sample Mode

#### ■ The functions of the edit sample mode

This mode lets you edit a waveform obtained in the sample mode or create waveform mode.

There are two ways to select the sample to be edited.

- 1) From among the multisounds in wave memory, choose the one that contains the sound that you want. Then specify the sound number of the particular sound that you want.
- 2) Choose a sound from among those that have been saved to disk. Load your desired sound from disk to memory.

In either case, wave memory is used as the editing work area and you edit only the single selected sound. As a result, a multisound is produced that is made up of just this one sound, and this multisound appears in the system.

- ★ When you select a single sound, all other data in wave memory is destroyed. Be sure to save (to disk) needed data before entering this mode.
- ★ You will note that in the link and mix functions you need a second sound. This second sound is obtained from among the sounds that have been saved to disk.

■ Only a single multisound is produced in the create waveform mode. For this purpose wave memory is used as the work area, so all previous resident data is destroyed. Before entering this mode, be sure to save any required data to disk as a sound or multisound.

★ This means, for instance, that if you perform harmonic synthesis after hand drawing, the drawn waveform disappears.

■ In this mode you can choose one of the eight waveforms, give it a name as a sound, and save it to disk.

★ To save data as a multisound, first switch to the multisound mode, then save the data to disk.

- Initial display for edit sample mode.

```
* EDIT SAMPLE MODE *
Select (1-2):_
```

★ You can select only F1 or F2 immediately upon entering the edit sample mode. F3 through F8 are selectable after completion of F1.

■ The following kinds of editing can be performed in this mode:

- Truncate
- Reverse
- Link
- Mix
- View/edit sample data (Sound data word value adjustment)

■ An edited sound can be given a name in this mode and saved to disk.

★ To save to disk as a multisound, first switch to the multisound mode.



#### 4: Multisound Mode

##### ■ Functions in the multisound mode.

there are three categories of functions available in the multisound mode.

##### A. The production of multisounds.

This lets you get sounds from disk and use them to assemble a multisound in wave memory.

Only a single multisound can reside in wave memory during this process.

##### B. Editing multisounds.

This lets you edit one multisound selected from among those already residing in memory. The following kinds of editing are possible.

- Adjustment of relative pitch, volume, and Fc between sounds.
- Assignment of sounds to the keyboard.
- Sound start and sound length settings.
- Loop on/off, loop start, loop length.
- Loop waveform processing.
- Sound data replacement.

##### C. Saving and renaming multisounds.

You can rename and save to disk a multisound produced in the sample mode, edit sample mode, create waveform mode or multisound mode.

- Initial display for multisound mode.

1) When multisound exists in wave memory.

```

*** M. SOUND MODE ***
Select (0-9): _

```

2) When no multisound exists in wave memory.

```

*** M. SOUND MODE ***
Select 0 Only: _

```

- ★ F1 through F9 can be used only if there is at least one multisound in wave memory.

#### 5: Program Parameter Mode

##### ■ Functions of the program parameter mode

This writes the current tone color patch (parameter settings) to program memory.

- The current patch is in the program output buffer. These parameter settings determine the tone color or final sound. When we make changes in this mode, we are affecting the data in this buffer. No change is made in program memory until we write the data from the buffer to the program memory.

- Initial display for program parameter mode.

```

*PROGRAM PARAMETER*
Select (00-96): _

```

- When you use the program change function, you are replacing the program output buffer memory contents with a program from program memory. The data is simply copied from program memory to the buffer. The data previously in the buffer is erased. If you make changes to the current program and do not want to lose those changes, then you must write the changed data back to the program memory before calling another program. (F01 write/rename).
- In this mode you can initialize the parameters so that the VCA, VCF, delay, and other sections of the synthesizer will not have any effect on the sound. (Use F00 initialize parameters).  
If you will be working on a multisound in another mode, please initialize the program parameters beforehand.

#### [6] System Mode

##### ■ System mode functions

This mode lets you handle programs and multisounds as complete systems. You can edit systems, write them to disk and get (load) them from disk to memory.

- The system mode offers the following facilities for editing program memory and wave memory.

- Directory of program names in program memory.
- Directory of multisound names and lengths in wave memory, with indication of free space.
- Loading of all (32) programs from a system on disk.
- Loading of a single program from disk.
- Loading of a single multisound from disk.
- Deletion of multisounds from wave memory.

Other system save and load functions include the following:

- You can save all programs in program memory to a specific system on disk. (Effective when changing only the program parameters.)
- You can save a whole system to disk, including all of its programs, multisounds and MIDI parameters.
- You can load a whole system from disk, including its programs, multisounds, and MIDI parameters.

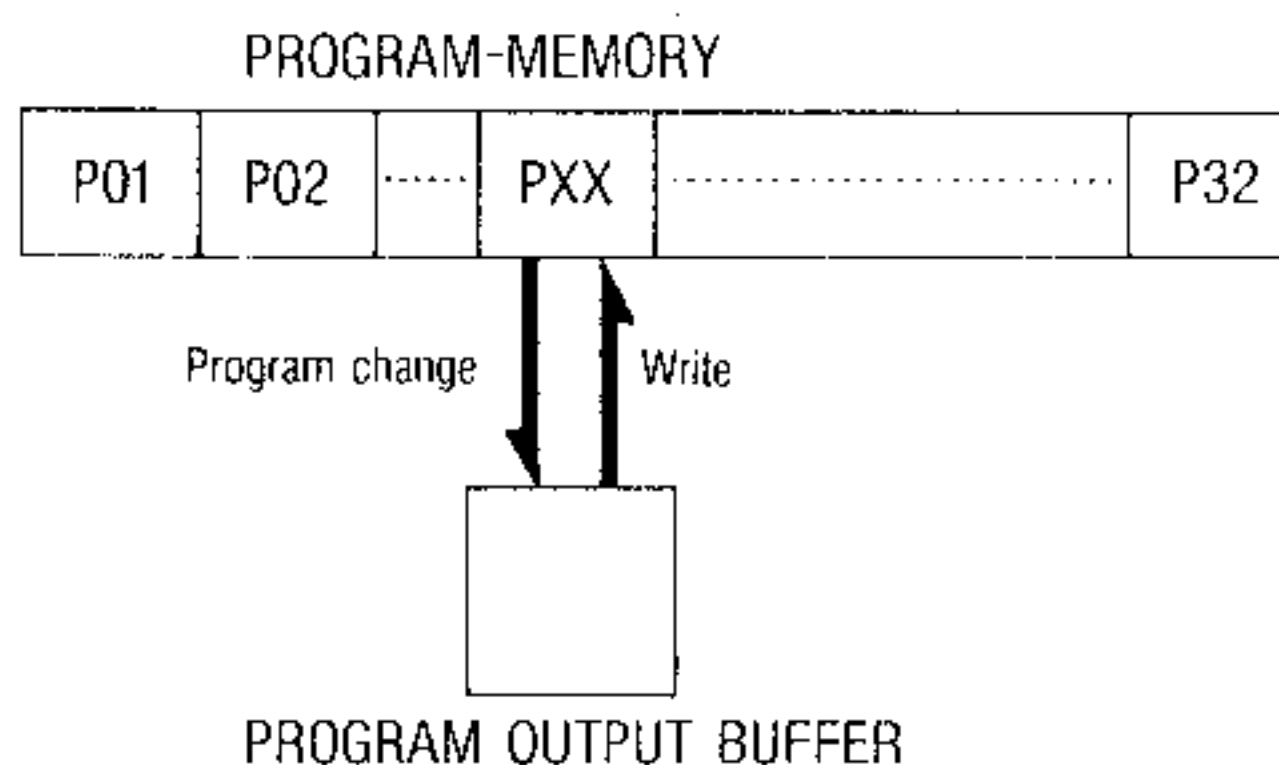

- Initial display for system mode.

```

*** SYSTEM MODE ***
Select (0-9): _

```

- The normal procedure for making a system for performance on the DSS-1 is as follows.

1. In the system mode, assemble the multisounds that you will need.
2. In the system mode, assemble the programs that you will need.
3. In the program parameter mode, assign multisounds to OSC-1 and OSC-2. If necessary, also adjust values for VCF, VCA, delay, and other parameters.
4. In the program parameter mode, write changed values from program output buffer to program memory.
5. Repeat steps 3 and 4 to make your 32 programs.
6. In the system mode, save the system to disk.

This completes one system and preserves it on disk. To perform with this system again, use the F1 GET SYSTEM function to load it from disk to memory.

System structure

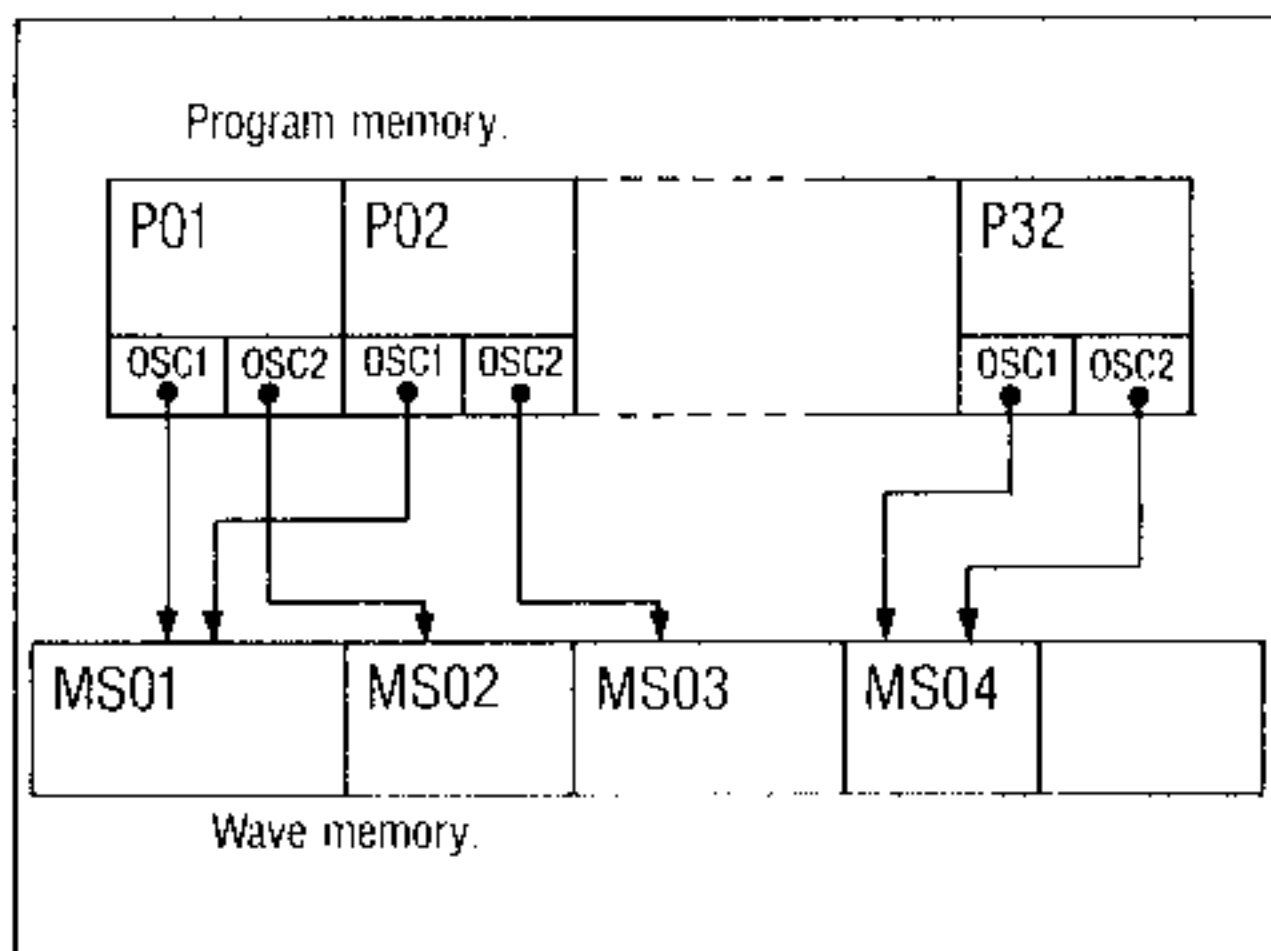

**Note:**

You can't make a complete system by only collecting programs and multisounds. You must use the program parameter mode to assign multisounds to the oscillators and then write the changes to program memory.

## 7| Disk Utility Mode

### ■ Functions in the disk utility mode.

This mode lets you perform the following tasks with your disks.

- Format newly purchased disks to ready them for use in the DSS-1.
- Protect saved data from accidental erasure or change.
- Display a directory of saved multisound, sound, and program names.
- Delete unwanted multisounds and sounds from disks.
- Display used and free (available) number of blocks on a disk.

**Note:**

If you delete a multisound that is used by a system on a disk, then you will get an "Incompleted" message if you try to get (load) that system from disk to memory.

- Initial display for disk utility mode.

```
*** DISK UTILITY ***
Select (0-7):_
```

# 2. Example applications of modes

**1 To just listen.**

You can listen to the sound that you sampled or created.



**2 To set up a patch (create a tone color).**

You use the VCA, VCF, And other parameters to process the basic sound that you sampled or created. You can then use the program that you have made.

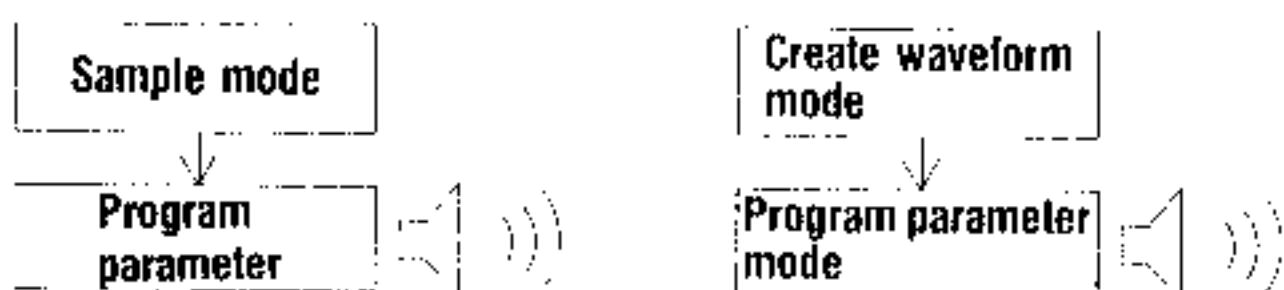

**3 To make the raw materials for sound sources.**

Save the basic sounds to disk.



**4 To process the raw materials.**

Process the sound that you saved in the previous step, then save it to disk again.

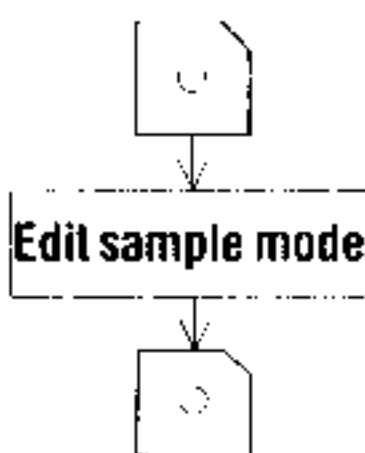

**5 To make a sound source.**

Save sampled or created sound to disk as a multisound. Or assemble sounds made in steps 3 and 4 and save them as a multisound on disk.

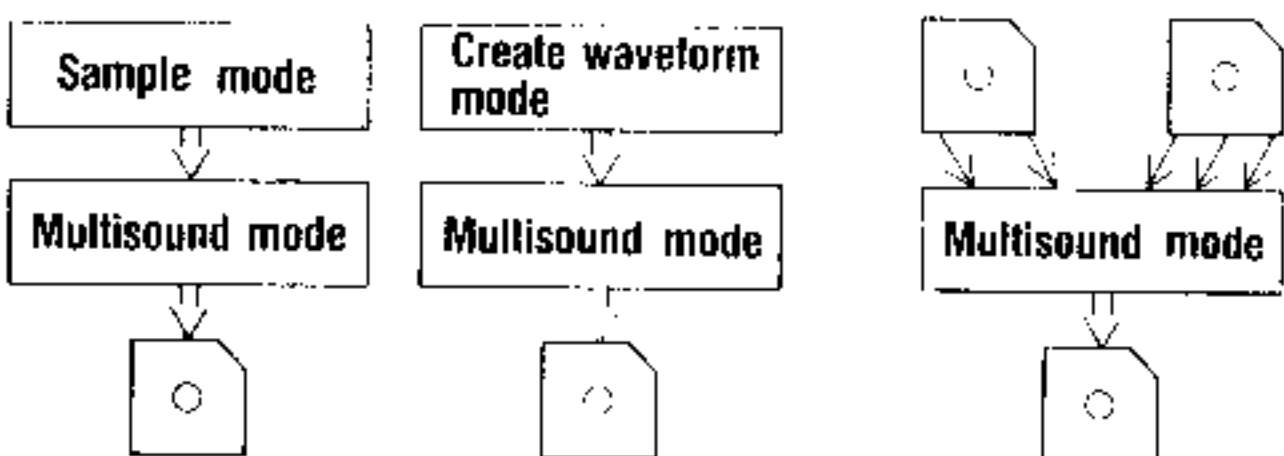

**6 Making a system**

Take the multisounds that you made in step 5, and assign them to OSC-1 and OSC-2 using the program parameters. Write to program memory if you want to save a program. After completing your program and multisound collection, write the whole thing to disk by using the save system function.

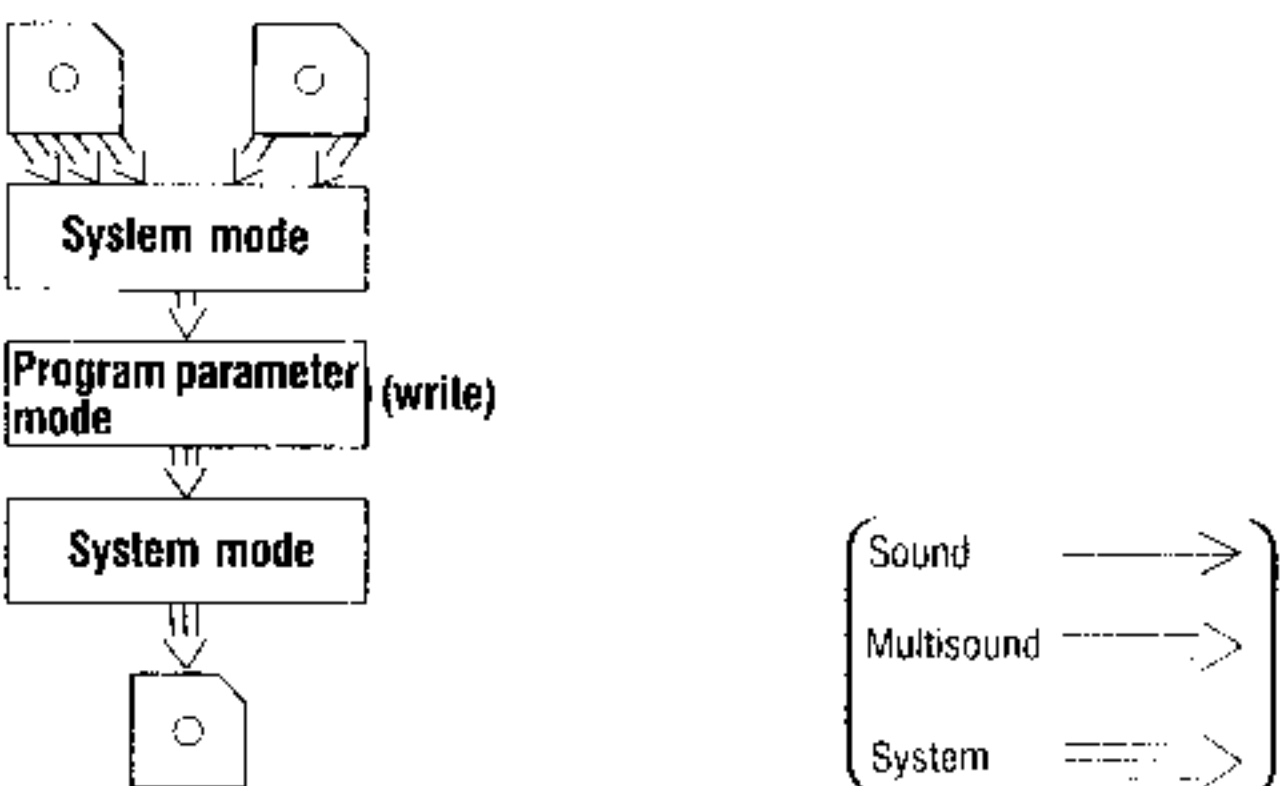

# SAMPLE MODE



## 1. Initial Operation

### 1 Initial functions

- Here we set the sampling frequency, total time parameter values.
- The relationship between total time and sampling frequency determines the actual recording time length as shown in the chart.

S. Fra	TOTAL TIME	
	Half	Full
16kHz	8.0sec	16.0sec
24kHz	5.5sec	11.0sec
32kHz	4.0sec	8.0sec
48kHz	2.75sec	5.5sec

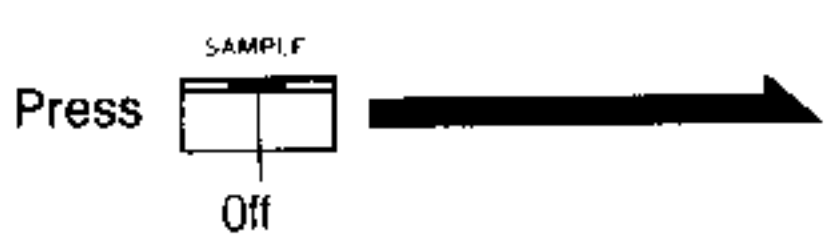
### 2 Initial Operation

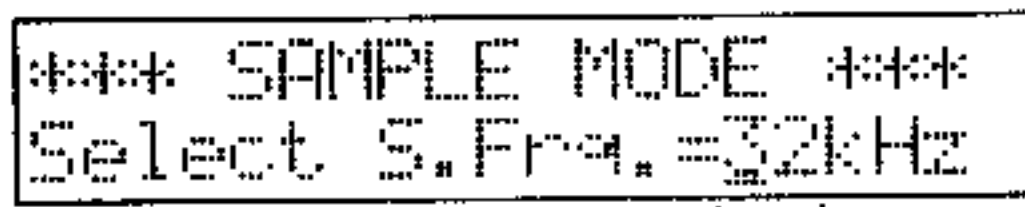
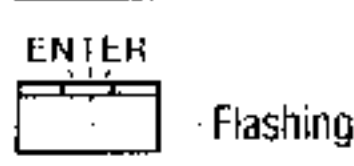
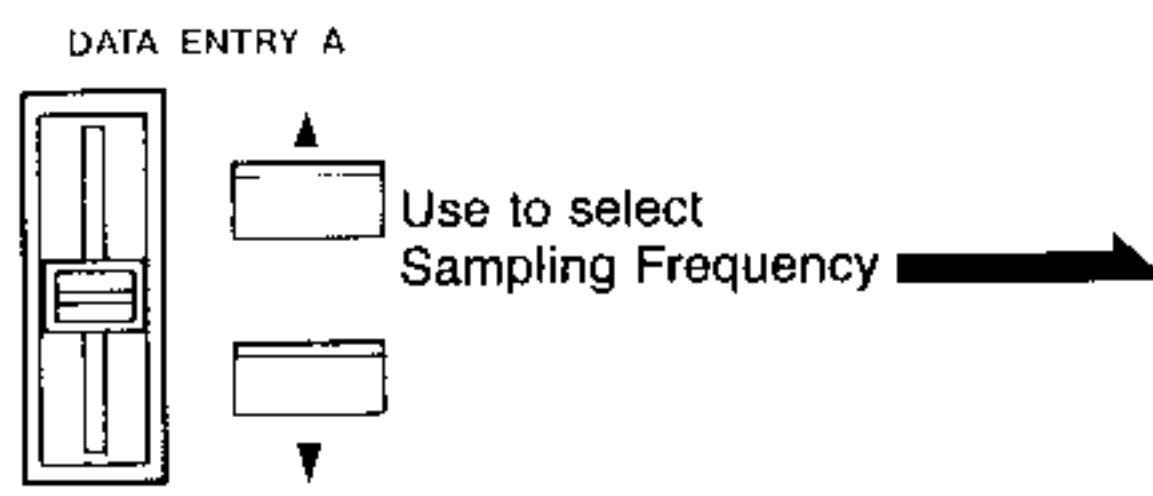
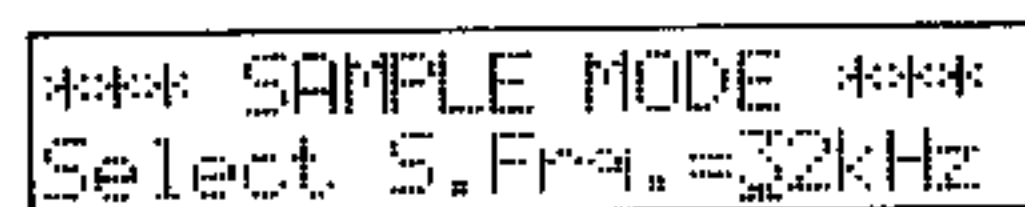
Operation	Operation of DSS-1
<p>1 Press the SAMPLE key to select the SAMPLE mode.</p> 	<ul style="list-style-type: none"> <li>● This selects the sampling mode and prompts you to select a sampling frequency.</li> </ul> <p>Sample mode display.</p>  <p>Prompt for sampling frequency.</p>   <p>Indicates current sampling frequency (defaults to 32 kHz when power is turned on).</p>
<p>2 Use DATA ENTRY A to select a sampling frequency.</p> 	<ul style="list-style-type: none"> <li>● The display shows the selected sampling frequency.</li> </ul>  <p>(Example indicates 32 kHz sampling rate.)</p>

③ Press the ENTER key to finalize your choice.



- You are now prompted for the total time for the recording.

```
Select TOTAL TIME
 4.0 or 8.0 (Sec)
```



④ Use the CURSOR keys to move the cursor (the underline in the display) to your choice.

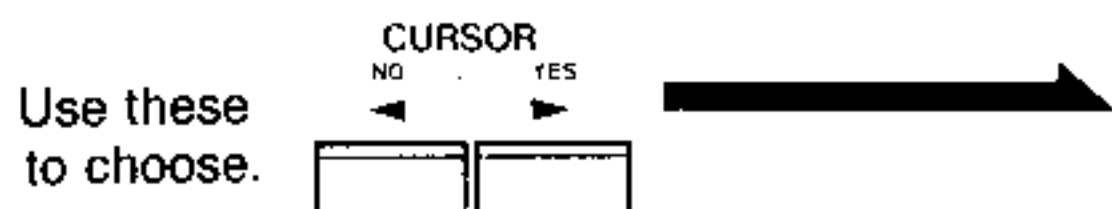

- Next "F1 SAMPLE NO./MEM. DIV" is selected.

```
Select TOTAL TIME
 4.0 or 8.0 (Sec)
```

(8.0 seconds is chosen in this example.)

⑤ Press the ENTER key to finalize your choice.



- At the same time this puts you in the "memory division select" condition.

- Cursor moves to your choice.

```
F1  SMPL-NO.  MEM.DIV
      01       01
```



⑥ Perform memory division setting.  
(See section on "F1 SAMPLE NO./MEM. DIV.")

# 2. About Each of the Functions

## FO SAMPLE START

### 1) About the sample start function

- Samples the signal from the AUDIO IN jack and stores that sample in the memory block with the sample number specified by the F1 SAMPLE NO. /MEM DIV. function.
- You can sample repeatedly as many times as you like. Each sample will replace the previous one in the selected memory block. This makes it easy to keep trying until you get satisfactory results.
- Input signal level is shown on the peak hold bar graph meter while sampling. this allows you to adjust the input to obtain an appropriate signal level.
- You can monitor the input signal via the regular audio outputs, so you can hear what it sounds like.

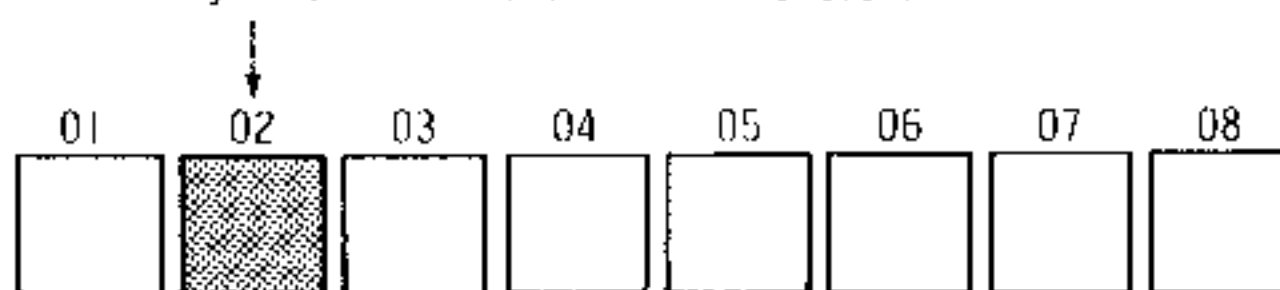

**Example:** Using a memory division of 8.

Memory block as specified by sample number selected by F1 SAMPLE NO. /MEM. DIV function.

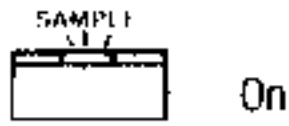
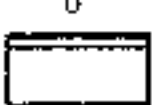
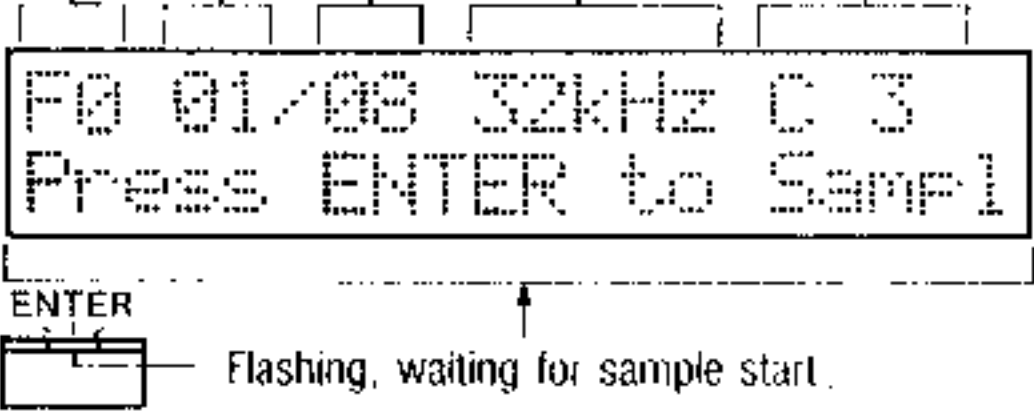

**Input signal from audio in jack is sampled and recorded in this memory block.**

## 2 Sample start function.

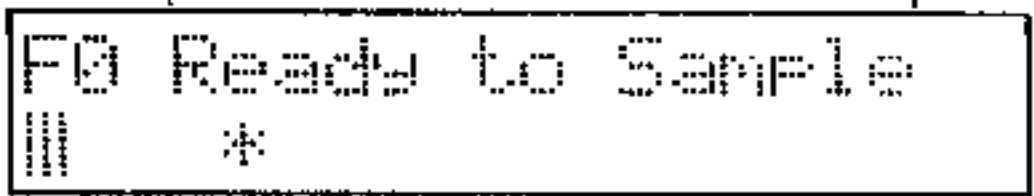
Operation	Operation of DSS-1
<p>0: Confirm that the SAMPLE mode is selected and that you have completed the INITIAL operations (detailed in the previous section starting on page 61).</p>	<ul style="list-style-type: none"> <li>Indicates SAMPLE mode.</li> </ul> 
<p>1: Press the number 0 key in the 10-key pad. This selects the sample start function.</p> <p>Press  →</p>	<ul style="list-style-type: none"> <li>The DSS-1 stands by for sample start.</li> </ul> <p>Indicates sample start function.</p> <p>Sample number.</p> <p>Memory division.</p> <p>Sampling frequency.</p> <p>Original key.</p>  <p>ENTER Flashing, waiting for sample start.</p>
<p>2: Confirm the sample number, memory division, sampling frequency, and original key. Then press ENTER when you wish to finalize these settings and go ahead with sampling.</p> <p>Press  →</p>	<ul style="list-style-type: none"> <li>Display while waiting for audio input signal.</li> </ul> <p>Shows that DSS-1 is ready to sample.</p>  <p>Indicates trigger level (threshold).</p> <p>Indicates input signal level.</p>



③ Input the sound that you wish to sample.

- The DSS-1 begins sampling when the input signal level exceeds the trigger level. It automatically stops sampling at the end of the selected sampling time.
- Then it asks if you wish to try over again.

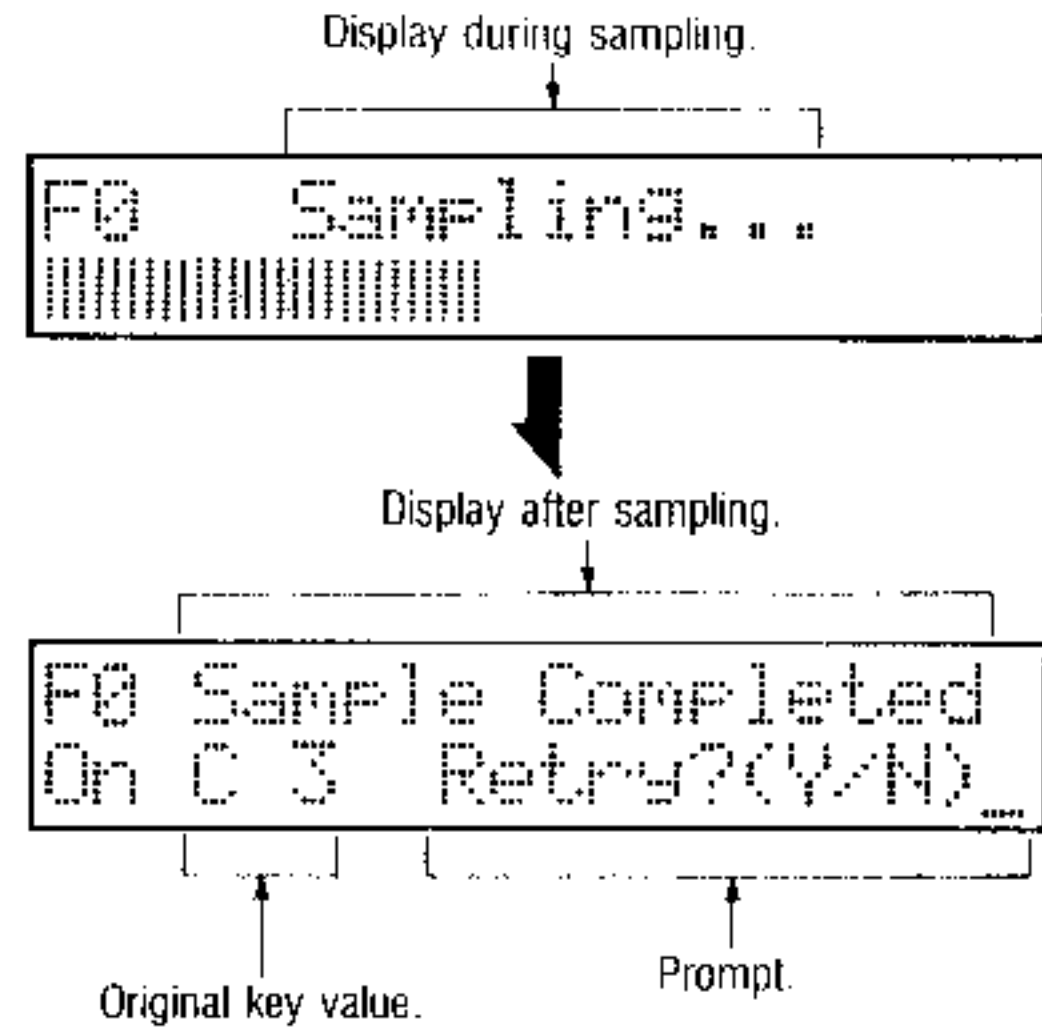

④ Press the YES or NO key to reply.

★ Play the keyboard and listen to your sampled sound. If you want to try again, press the YES key.



★ Play the keyboard and listen to your sampled sound. If you are satisfied with the sound and do not wish to try again, then press the NO key.



- Pressing YES takes you back to where the DSS-1 is standing by for sample start. Continue from step 2 above.

- This ends the sample start function and returns you to the functions selection menu.

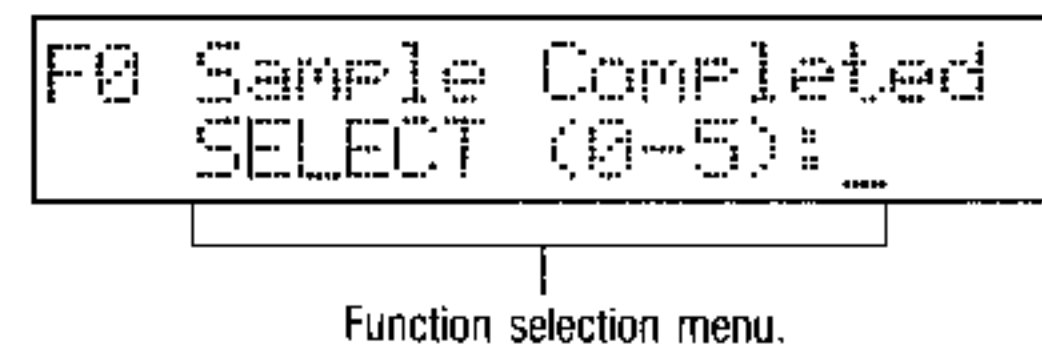





In step 2 you can get stuck if the trigger level is so high that the input signal can not reach it. If this seems to be happening, press the DELETE/CANCEL key to abort the function.

Example of display when the input signal does not reach the trigger level.

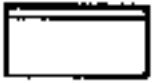
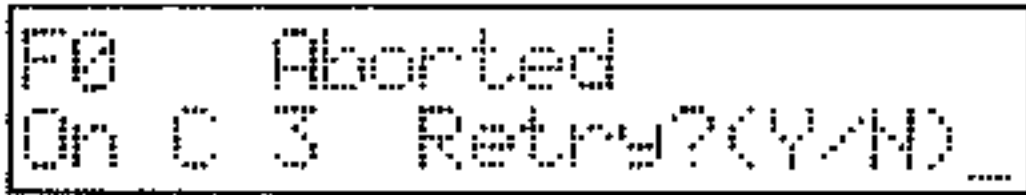
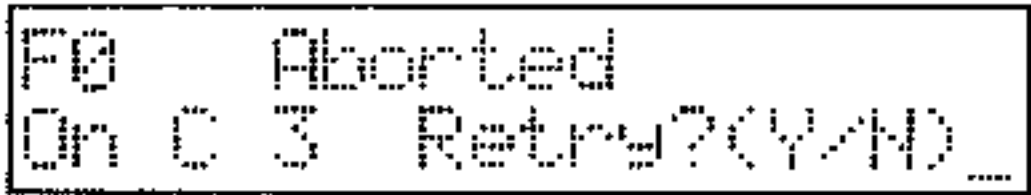
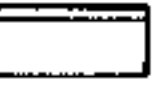

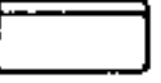
Input signal level indication. Trigger level indication.

Operation	Operation of DSS-1
<p>i) Press the DEL/CANCEL key.</p> <p>Press  </p>	<ul style="list-style-type: none"> <li>This aborts the operation so the DSS-1 stops waiting for the input signal to exceed the trigger level. It then asks you whether you wish to try the sampling start function again.</li> </ul> <p>Indicates the operation was aborted.</p>  <p>Original key. Prompt.</p>
<p>ii) Reply by pressing the YES or NO key.</p> <p>★ Press YES if you wish to try again.</p> <p>Press  </p> <p>★ Press NO if you want to quit the sampling start function.</p> <p>Press  </p>	<ul style="list-style-type: none"> <li>Pressing YES takes you back to where the DSS-1 is standing by for sample start. Continue from step 2 above.</li> <li>Stops sampling.</li> <li>This ends the sample start function and returns you to the function selection menu.</li> </ul> <p>Indicates that function was aborted.</p>  <p>Function selection menu.</p>

# F1 SAMPLE NO./MEM. DIV.

- 1 Sample number and memory division function.
- Setting the memory division and setting the sample number are different operations though they appear in the same initial prompt. Follow the directions below.

### A. Memory division setting

- This takes the total sample area of memory as determined by the total time setting and divides it up into blocks which are assigned to the keyboard.

- You have five choices. You can divide memory into 16, 8, 4, 2, or 1 (no division) blocks.
- As soon as you make your choice, the DSS-1 makes memory blocks and gives each of them a sample number.
- The sampling time for each of these blocks is the total time divided by your choice of memory division.

- A. The function of memory division setting.
- B. The function of sample number setting.

**Example:** Total time set to HALF and memory division set to 4.

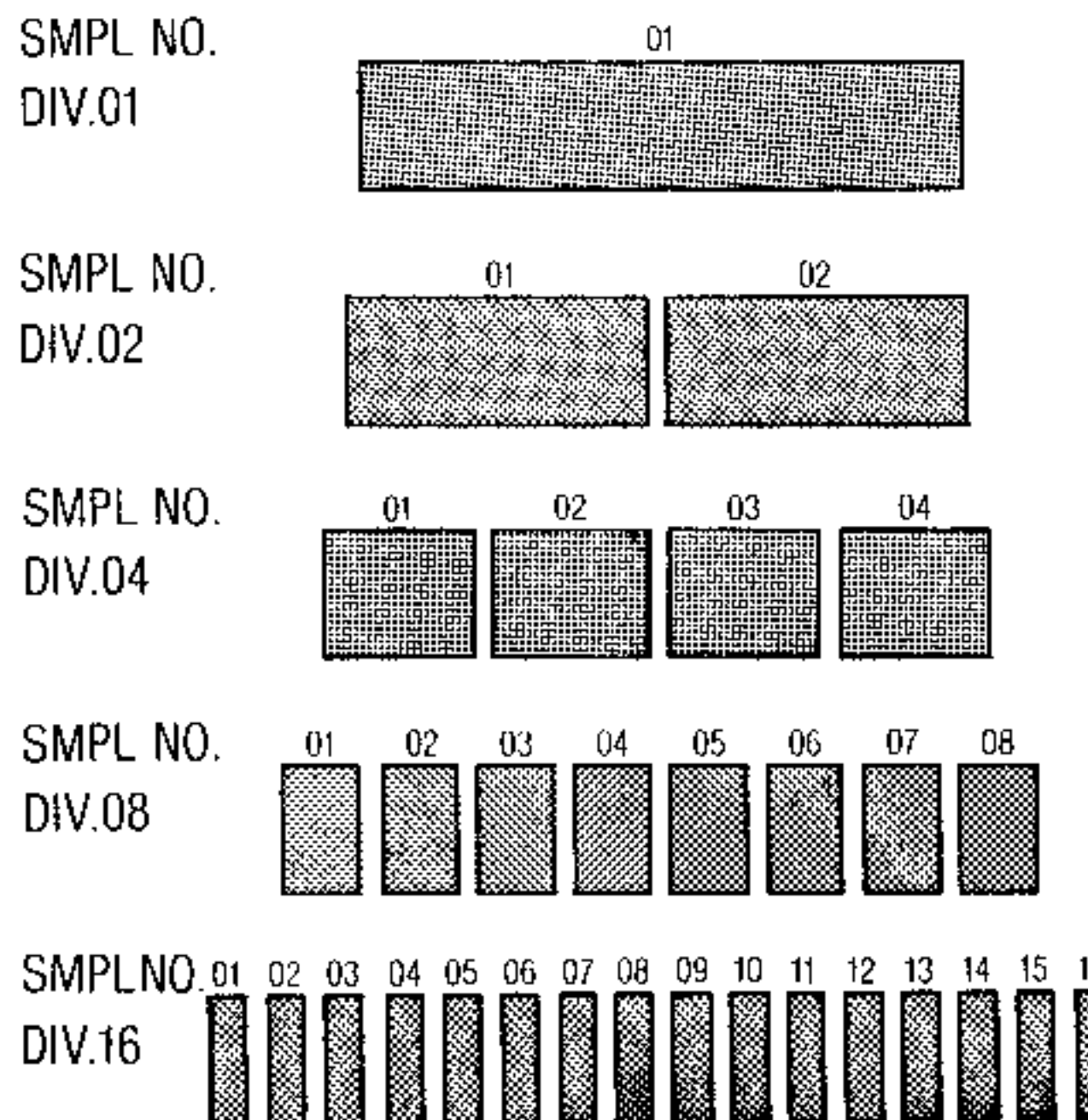
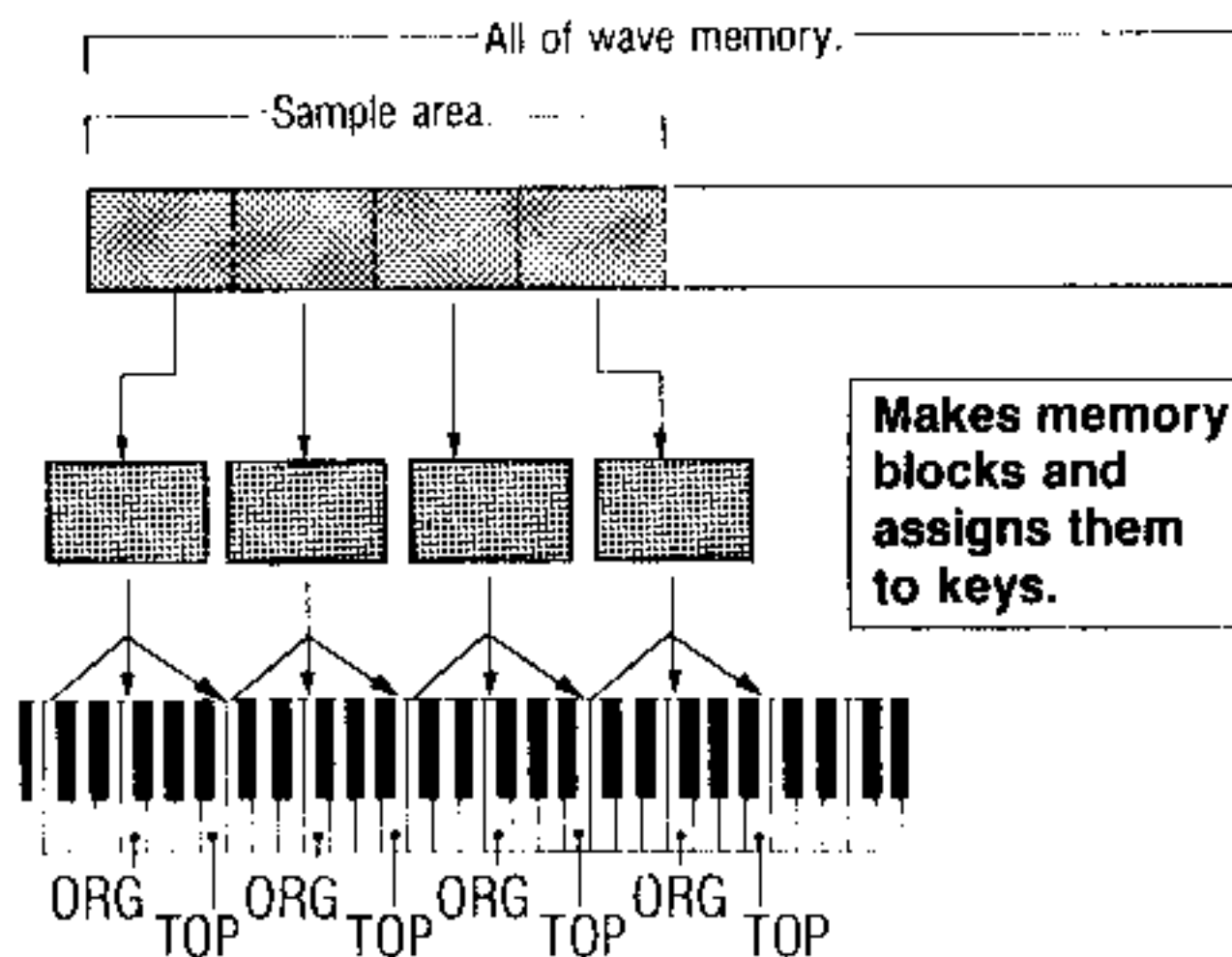

■ After the memory division has been selected and the memory blocks have been made, all the blocks must be assigned to the keyboard.

This can be done automatically or manually. With the "Auto-assign" method, the DSS-1 assigns each block to a particular predetermined key. With the "manual assign method, you decide the key to which to assign each of the blocks.

If you fail to perform sampling for an assigned memory block, then when you play the keyboard you will hear the previous sound from wave memory over the length of that block. When this occurs it is usually misinterpreted as a malfunction.

- Auto-assign.
- Manual assign.

■ The auto-assign method results in the assignments shown in this chart.

**Auto-Assign**

(Each memory block's "TR/NT" is set to TR.)

SAMPLE NO.		01	02	03	04	05	06	07	08	09	10	11	12	13	14	15	16
01	ORG	C3															
	TOP	F3															
02	ORG	C3	C5														
	TOP	F3	F5														
04	ORG	C3	C4	C5	C6												
	TOP	F3	F4	F5	F6												
08	ORG	C3	F#3	C4	F#4	C5	F#5	C6	F#6								
	TOP	E3	A#3	E4	A#4	E5	A#5	E6	A#6								
16	ORG	C3	D#3	F#3	A3	C4	D#4	F#4	A4	C5	D#5	F#5	A5	C6	D#6	F#6	A6
	TOP	D3	F3	G#3	B3	D4	F4	G#4	B4	D5	F5	G#5	B5	D6	F6	G#6	B6

■ In the manual mode, you assign the blocks beginning with the smaller sample number, assigning them from the low notes upward.

**NOTE:**  
With "manual assign" as well, the situation is different from the "ordinary key assign" in that you can not change the TR/NT. (It is fixed at TR.)

**B. Sample number setting**

■ From among the memory blocks (created by the memory division setting) select the sample number of the block that will be used for F0 SAMPLE START and F4 ORIGINAL/TOP KEY.



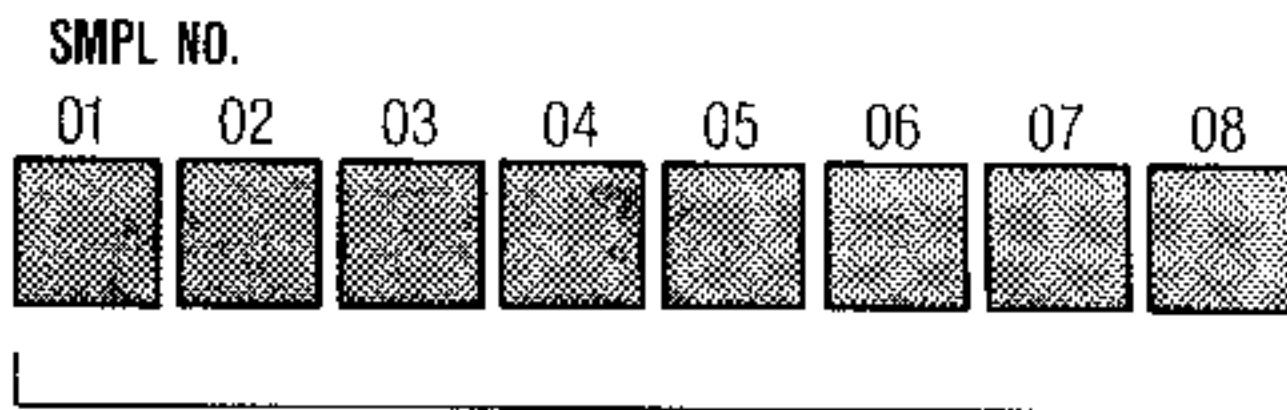

(Example: Memory division at 8.)

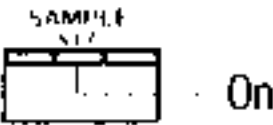

Select memory block for F0 SAMPLE START and F4 ORIGINAL/TOP KEY.

## 2) Sample number and memory division function procedures.

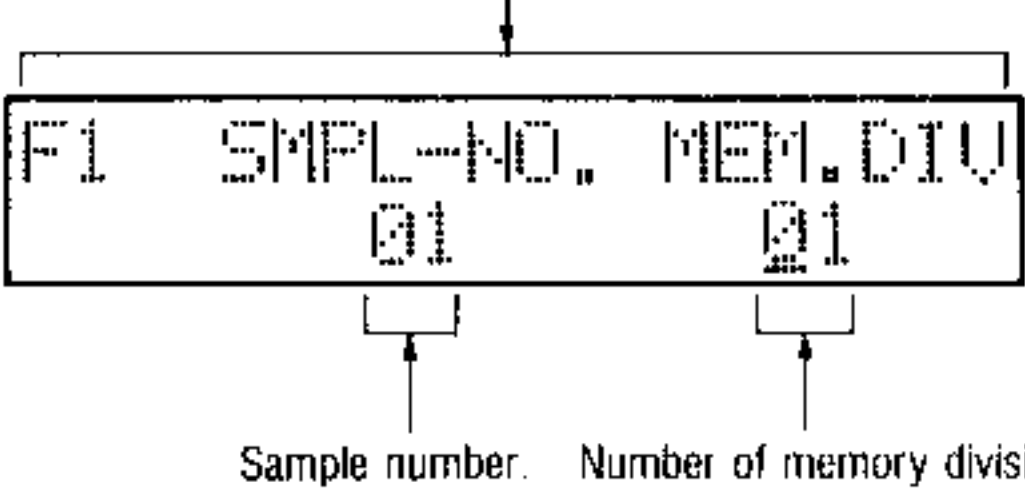
### A. Memory division setting/how to change.

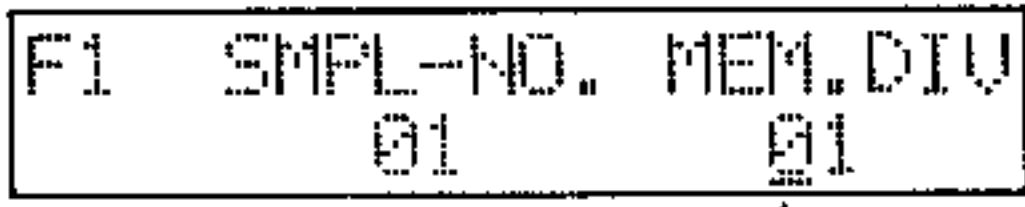
Operation	Operation of DSS-1
<p>① Confirm that the SAMPLE mode is selected and that you have completed the INITIAL operations (detailed in the previous section starting on page 61).</p>	<ul style="list-style-type: none"> <li>When in the sample mode.</li> </ul> 
<p>② Press key number 1 in the 10-key pad. This selects the sample number/memory division function.</p> <p>Press </p>	<ul style="list-style-type: none"> <li>You are shown the currently selected sample number and memory division. (These default to sample number 01 and memory division 01 when the power is turned on.)</li> </ul> <p>Shows sample number and memory division setting.</p> 
<p>③ Confirm that the cursor is on the memory division side of the display. If it isn't then press the YES cursor key to move it to the right.</p> <p>( Press  )</p>	<ul style="list-style-type: none"> <li>Memory division can now be set.</li> </ul> 

3 Use DATA ENTRY A to select the memory division.

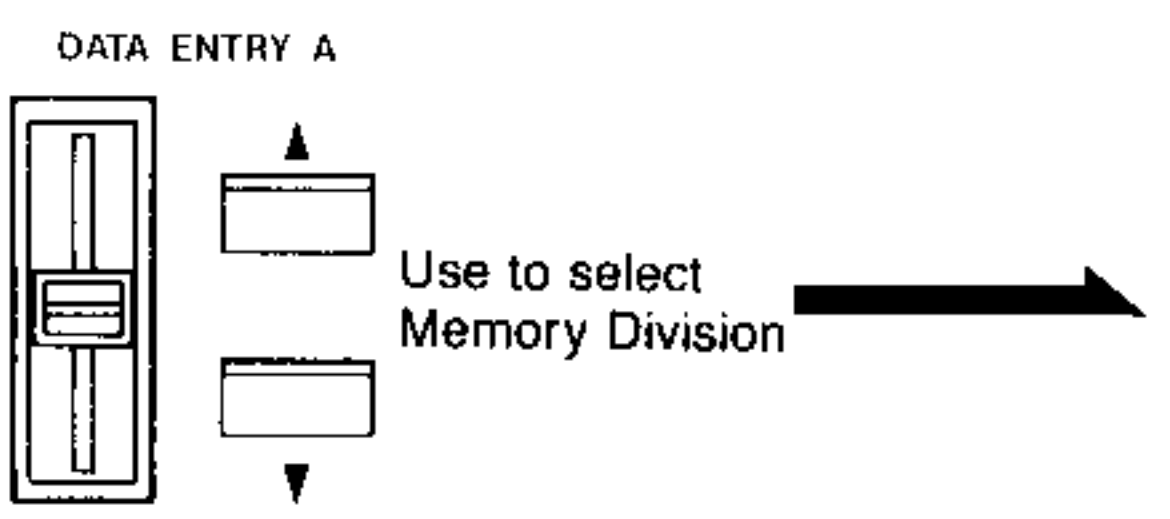

- Shows current value and waits for further input.

```
F1  SMPL-NO.  MEM.DIU
      01          08
```

Current memory division setting, at 8 in this example.

ENTER  
 -- Flashing, ready for input.

( If the initial setting does not appear as 01, it will revert to 01 as soon as you operate DATA ENTRY A. )

4 Press ENTER to finalize your decision.



- Memory division setting is now completed.
- Next you are asked whether or not you want automatic assignment of memory blocks.

```
F1  SMPL-KEY ASSIGN
      AUTO SET ?  (Y/N)_
```

Prompt.

- ⌚ Press the YES or NO key to reply.
- ★ Press the YES key if you desire automatic assignment.



- ★ If you do not want the memory blocks to be assigned automatically then press the NO key.

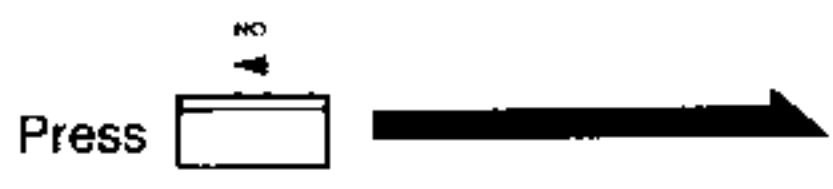

- All memory blocks are assigned automatically (as detailed in the previous section on the auto assign function).
- This ends the sample number/memory division function procedures. (So you are back to the condition where you can select other functions.)

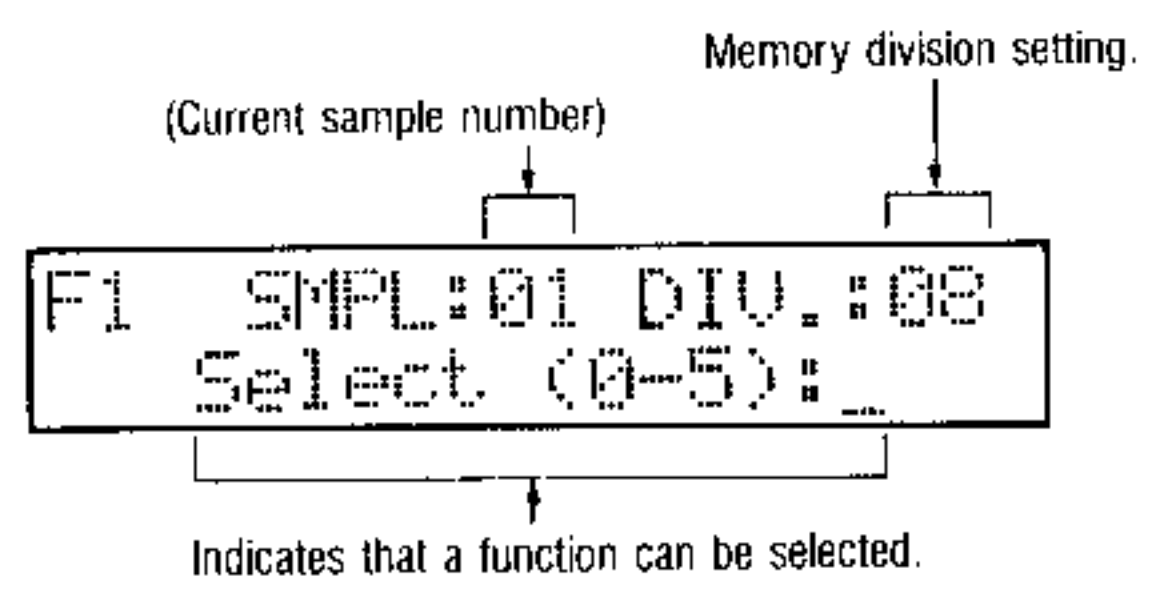

- This allows you to assign the blocks manually.
- From among the unassigned memory blocks the one with the smallest sample number is selected first and you are prompted for an assignment. The ENTER key's LED flashes as it waits for your input.

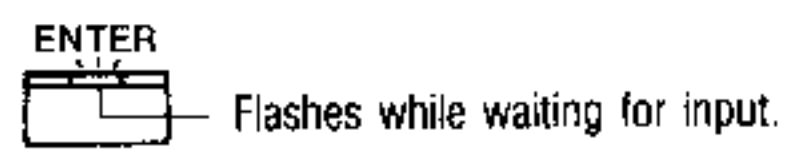
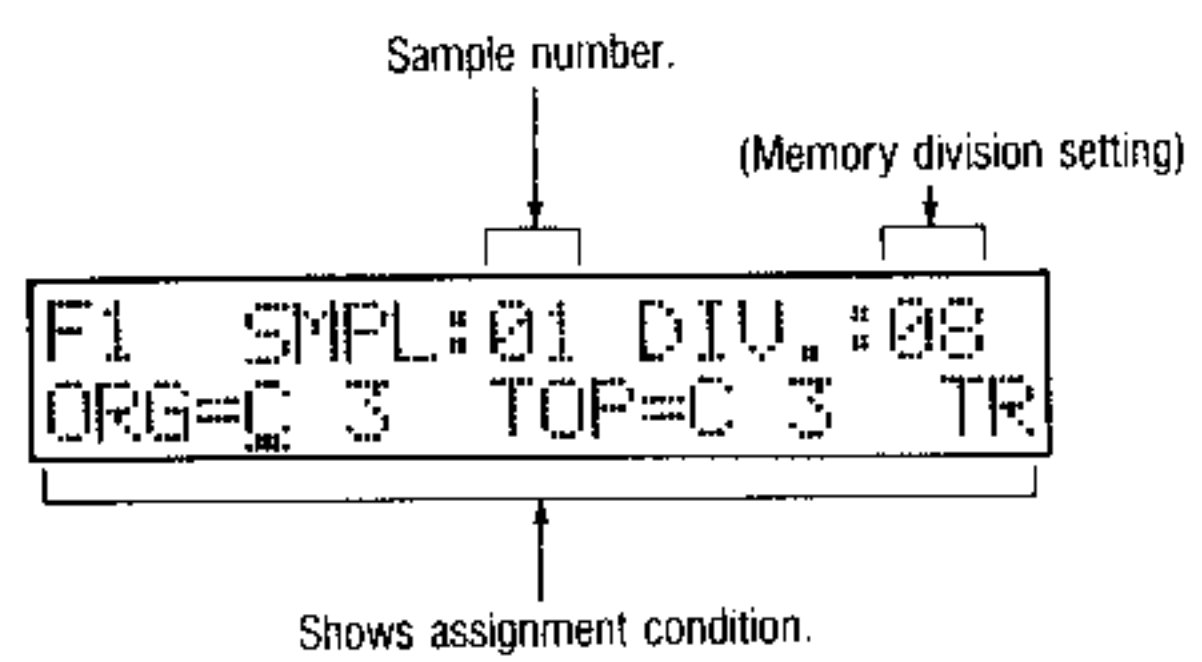

⑥ Use the cursor keys to move the cursor to the parameter (original key or top key) that you wish to adjust. Use DATA ENTRY A to adjust the value.

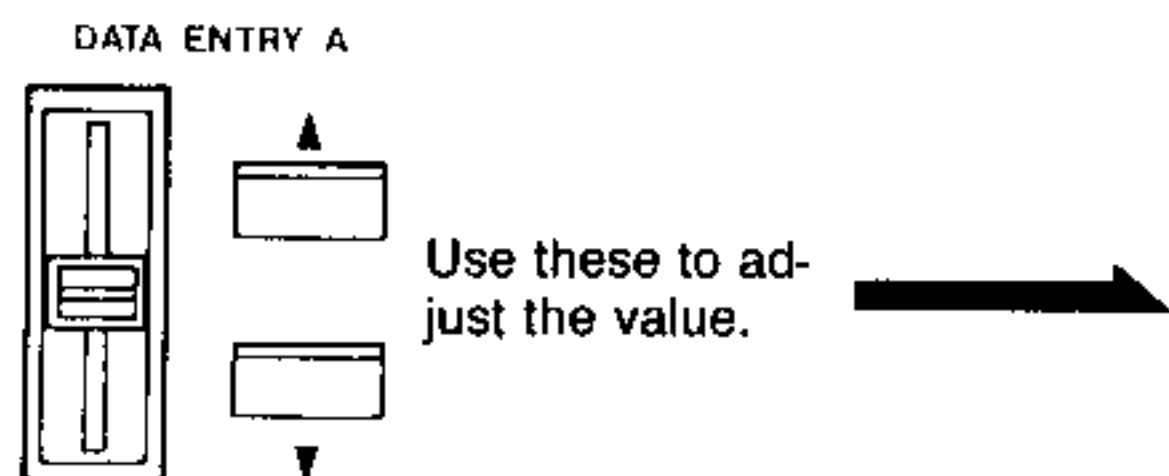
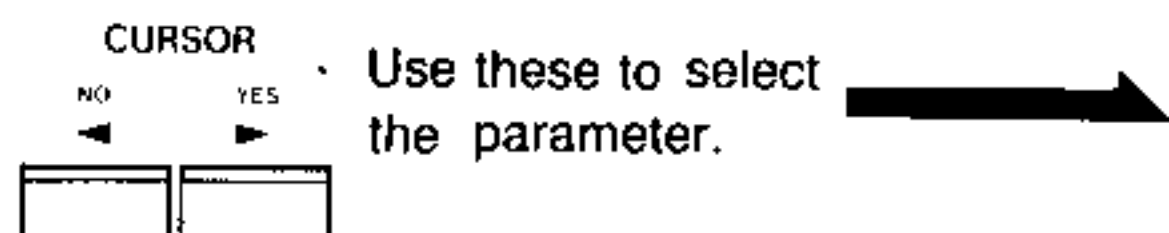

```
F1 SMPL:01 DIV.:08
ORG=C 3 TOP=C 3 TR
```

(Example shows selection of top key parameter.)

```
F1 SMPL:01 DIV.:08
ORG=C 3 TOP=C 4 TR
```

(Example shows top key value set to C4.)

⑦ Press ENTER to finalize your setting.



- That completes assignment of that memory block.
- If unassigned memory blocks remain, then you will be asked whether to continue to assign them.

Prompt.

```
F1 Continue ? (Y/N)
ORG=C 3 TOP=C 4 TR
```

- If there are no unassigned memory blocks then the sample number/memory division function is completed and you are returned to the function selection menu.



⑧ Use the YES and NO keys to reply.

★ To continue to assign memory blocks, press YES.



★ To stop manual assignment of remaining unassigned memory blocks, press NO.



- This takes you back to the situation in step ⑤. Proceed from step ⑥ to assign the next memory block.

- This discontinues manual assignment of memory blocks.
- This ends the sample number/memory division function and returns you to the function selection menu.

```
F1  SMPL:01  DIV.:03
      Select (0-5):_
```

  
Function selection menu.



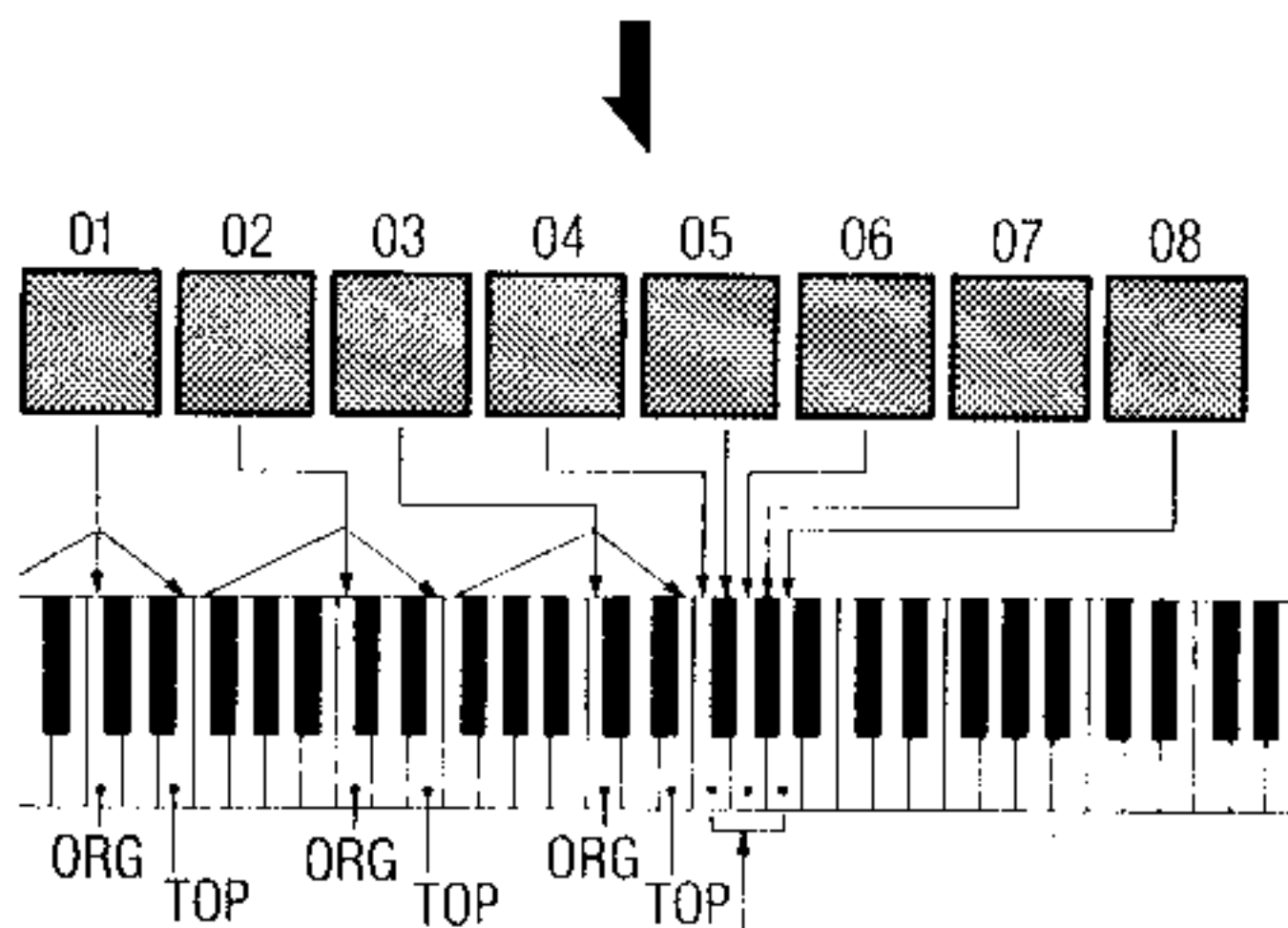
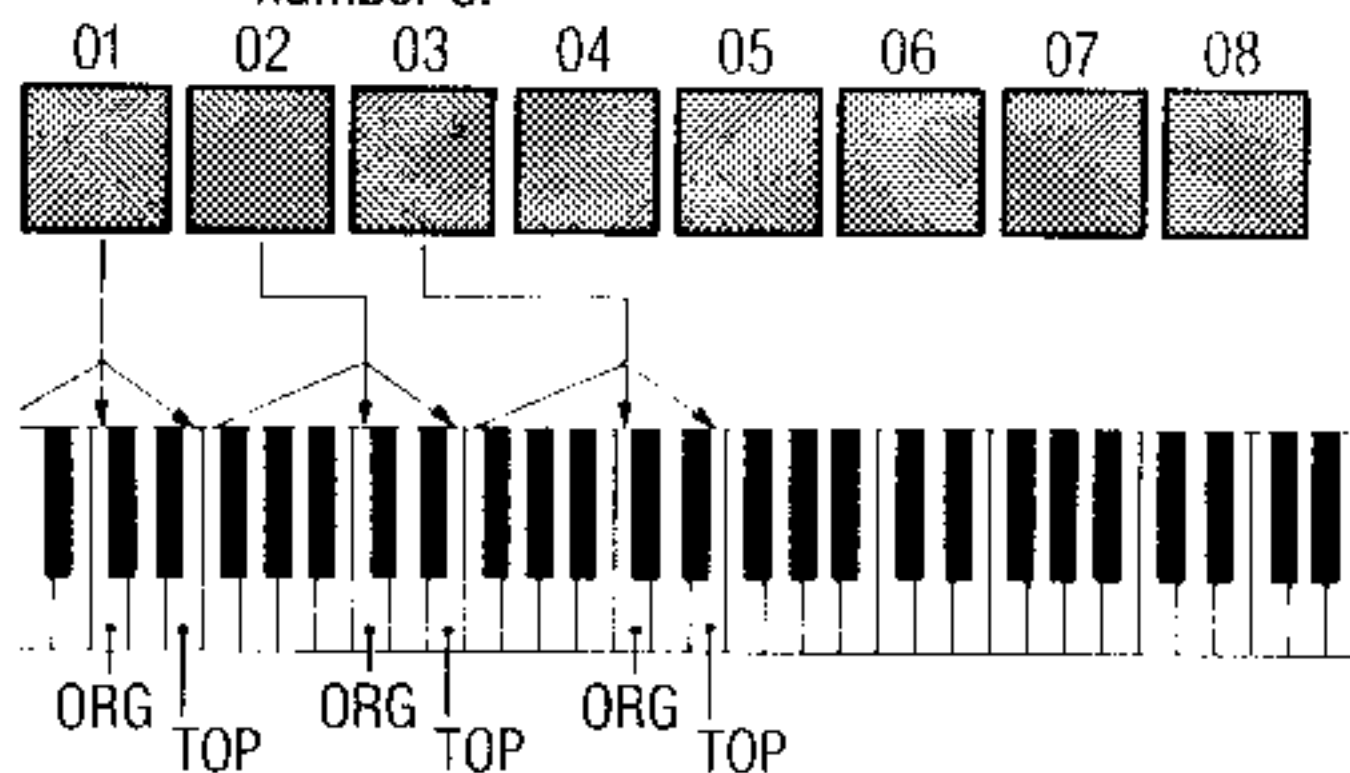

- If memory blocks are left over after interrupting manual assignment, then the DSS-1 automatically assigns them in semitone steps to the keys immediately above the "top key" assignment of the last assigned memory block.

**Example:** Suppose you interrupted the procedure after assigning memory blocks up through sample number 3.

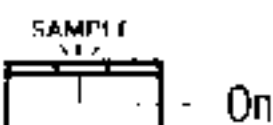
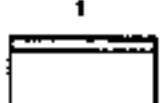

Sample number 3 is assigned to E, so sample numbers 4, 5, 6, 7, and 8 will be assigned to keys F, F#, G, G#, and A, respectively. (A side effect of this is that the original key and top key will be identical.)

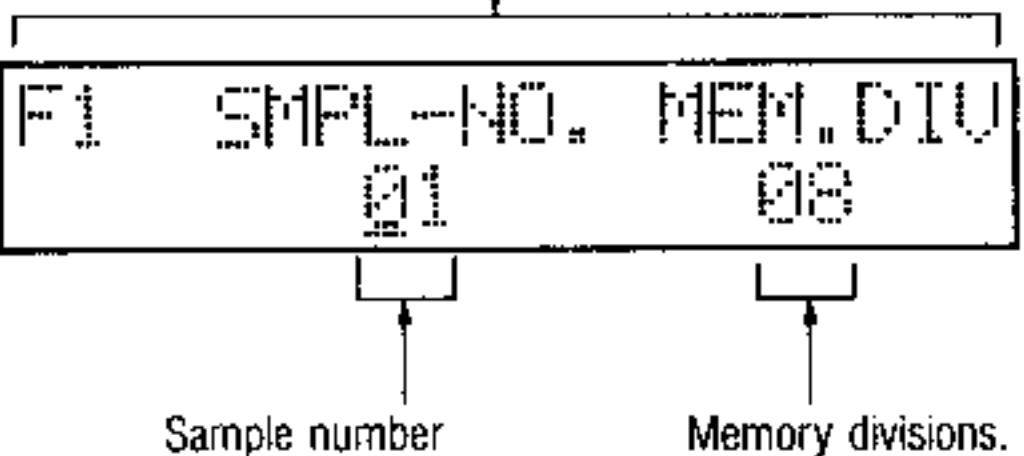
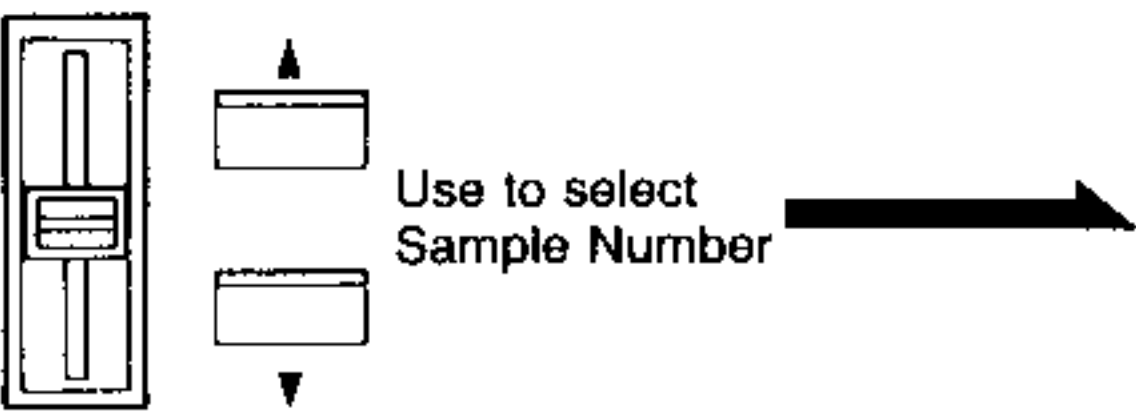
**B. Selecting the sample number.**

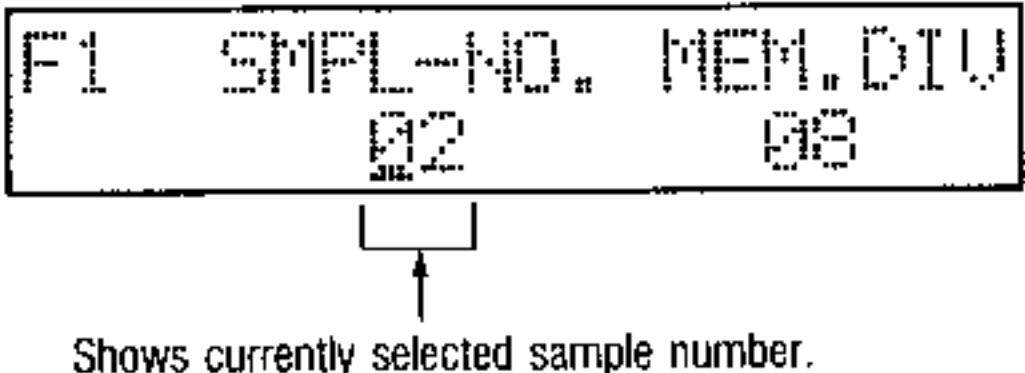
Operation	Operation of DSS-1
<p>① Confirm that the SAMPLE mode is selected and that you have completed the INITIAL operations (detailed in the previous section starting on page 61).</p>	<p>● The SAMPLE key LED lamp should be illuminated.</p>  <p style="text-align: center;">- On</p>
<p>② Press the number 1 key in the 10-key pad. This selects the sample number/memory division function.</p> <p style="text-align: center;">Press  </p>	<p>● You see a display of the current sample number and memory division number.</p> <p style="text-align: center;">Shows current sample number and number of memory divisions.</p> 
<p>③ Confirm that cursor is under the sample number. (If it isn't then use the cursor keys to move it there.) Use DATA ENTRY A to select the sample number.</p> <p style="text-align: center;">DATA ENTRY A</p>  <p style="text-align: center;">Use to select Sample Number </p>	 <p style="text-align: center;">Shows currently selected sample number.</p>

## F2 ATTN/GAIN

### 1. The attenuation/gain function

- This is used to control input signal level so that it is suitable for sampling.

- You set the levels for two parameters: gain and attenuation.

"Gain" is the amount of amplification applied to the signal. You can set it from 0dB (no amplification) to 40dB of gain, in steps of 10dB.

"Attenuation" is the amount that the signal is reduced. You can attenuate the signal in steps of 2dB, over a range of 0dB (no attenuation) to -10dB.

The gain setting combines with the attenuation setting to give you overall control over signal level in 2dB steps over a range of -10dB to 40dB.

The procedure is therefore to adjust the gain first, since it provides rough adjustment in 10dB steps. Then "fine tune" your setting by adjusting the attenuation, since this is adjustable in 2dB steps.

- When using this function, you can see the actual input signal level on the peak hold bar graph meter display.

If the input signal level exceeds the suitable level and causes clipping, the display shows the clipped portion by a dark block.

- Furthermore, the audio signal is sent to the DSS-1's outputs, so you can monitor it by ear as well.

#### Caution:

Excessive audio input can cause malfunction and possible damage. Please follow the directions here:

- Adjust the input so that the meter does not give a continuous reading all the way to the right. (It should not clip all the time.)
- When using studio equipment on which you can adjust the output voltage, do not set output any higher than 17dBm (10Vp-p).

#### Available gain values

0dB, 10dB, 20dB, 30dB, 40dB

#### Available attenuation values





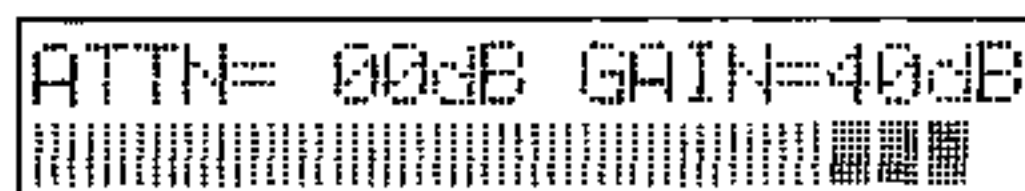

0dB, -2dB, -4dB, -6dB, -8dB, -10dB

ATTN= 00dB GAIN=40dB

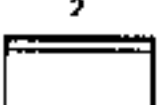

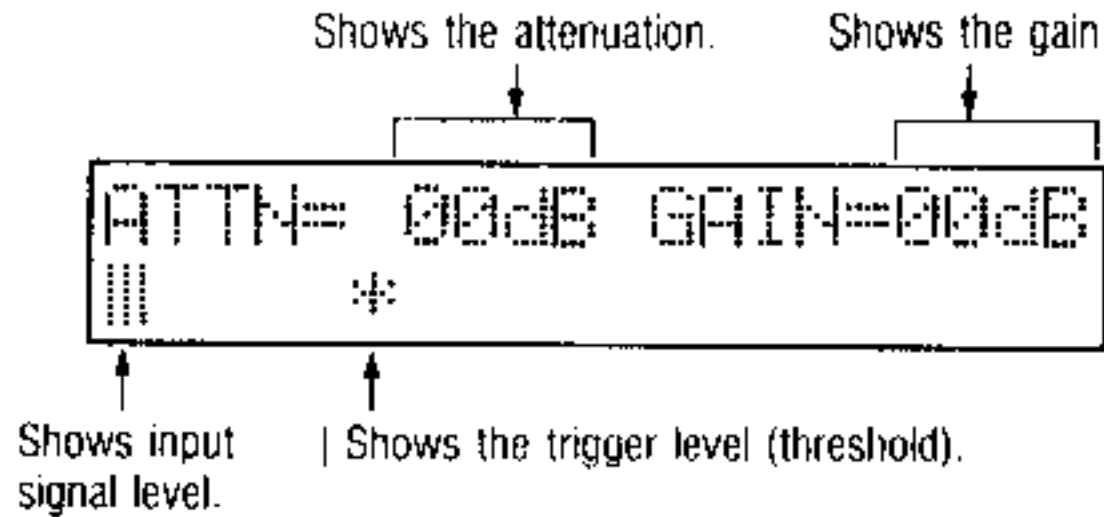
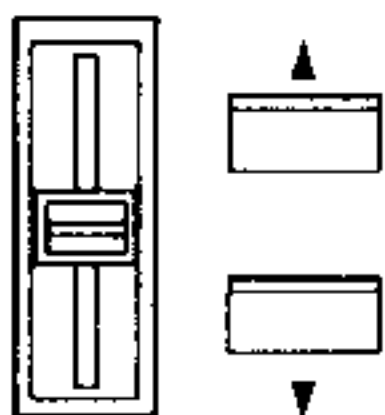
Indicates clipping.

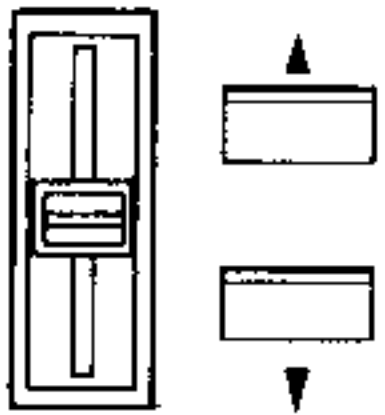
## 2. Procedures for setting attenuation and gain.

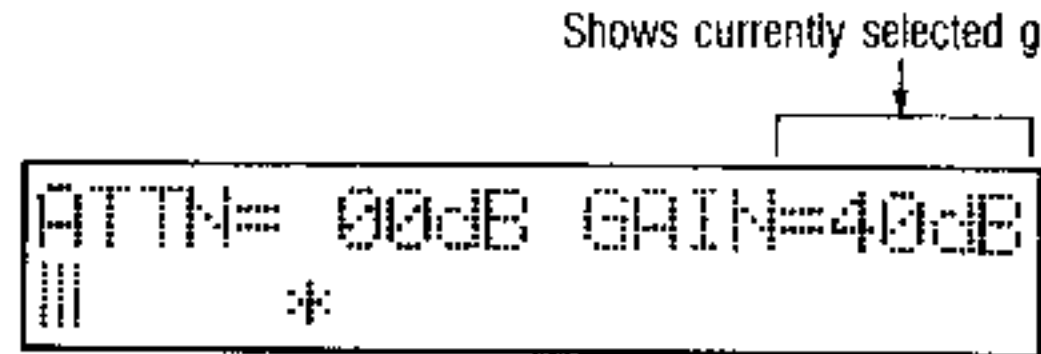
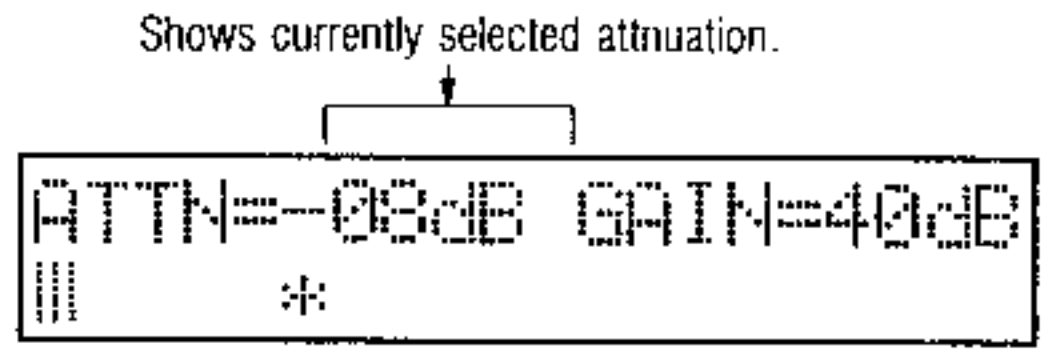
Operation	Operation of DSS-1
<p>① Confirm that the SAMPLE mode is selected and that you have completed the INITIAL operations (detailed in the previous section starting on page 61).</p>	<ul style="list-style-type: none"> <li>● Indicates SAMPLE mode.</li> </ul> 
<p>② Press number 2 in the 10-key pad.</p> <p>Press  </p>	<ul style="list-style-type: none"> <li>● This selects the attenuation/gain function. The display shows the current values.</li> </ul> 
<p>③ Use DATA ENTRY B for gain and DATA ENTRY A for attenuation setting.</p> <p><b>DATA ENTRY B</b></p>  <p>Use to select Gain </p> <p><b>DATA ENTRY A</b></p>  <p>Use to select Attenuation </p>	 

## F3 TRIGGER LEVEL

### 1. What is trigger level?



- This is the level or threshold that the input audio signal must reach before the DSS-1 begins sampling.

#### Available trigger values.

0 127

- You can see both the input signal level and the current trigger level setting on the display at the same time. So you can adjust trigger level as necessary, while viewing the signal. The trigger level setting is marked by a single star (\*).
- The input signal is also routed to the DSS-1 outputs so you can monitor it by ear as well.

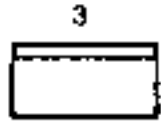
### 2. Trigger level function procedure.

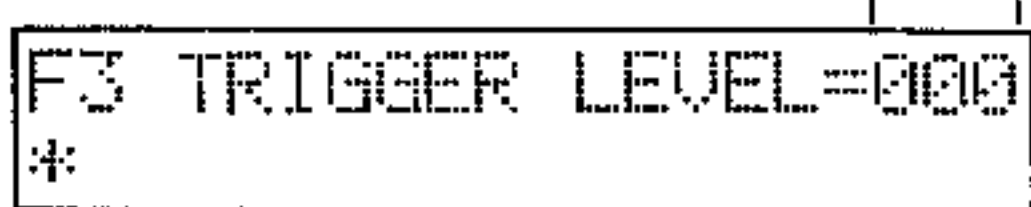
Operation	Operation of DSS-1
(0) Confirm that the SAMPLE mode is selected and that you have completed the INITIAL operations (detailed in the previous section starting on page 61).	<ul style="list-style-type: none"> <li>● SAMPLE key LED is illuminated.</li> </ul> 
(1) Press number 3 in the 10-key pad.  Press  	<ul style="list-style-type: none"> <li>● Selects the trigger level function. The display shows the current trigger level value.</li> </ul> <p>Current numeric value of trigger level.</p> <p>Shows numeric value of trigger level.</p>  <p>Shows where the trigger level is in relation to bar graph indication of input signal level.</p>

② Use DATA ENTRY A to set trigger level.

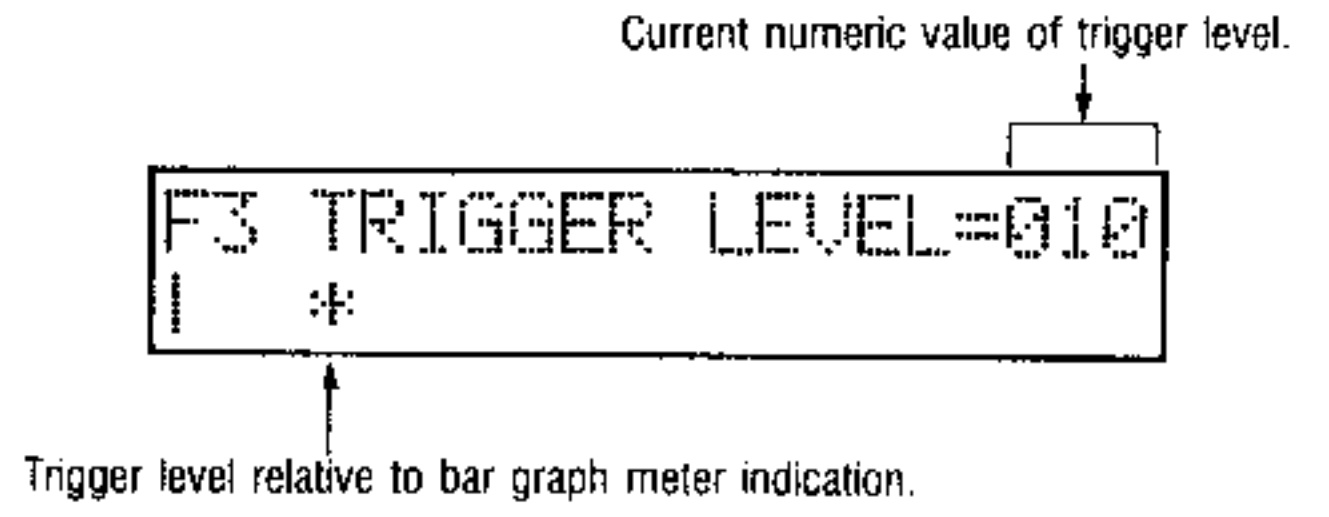
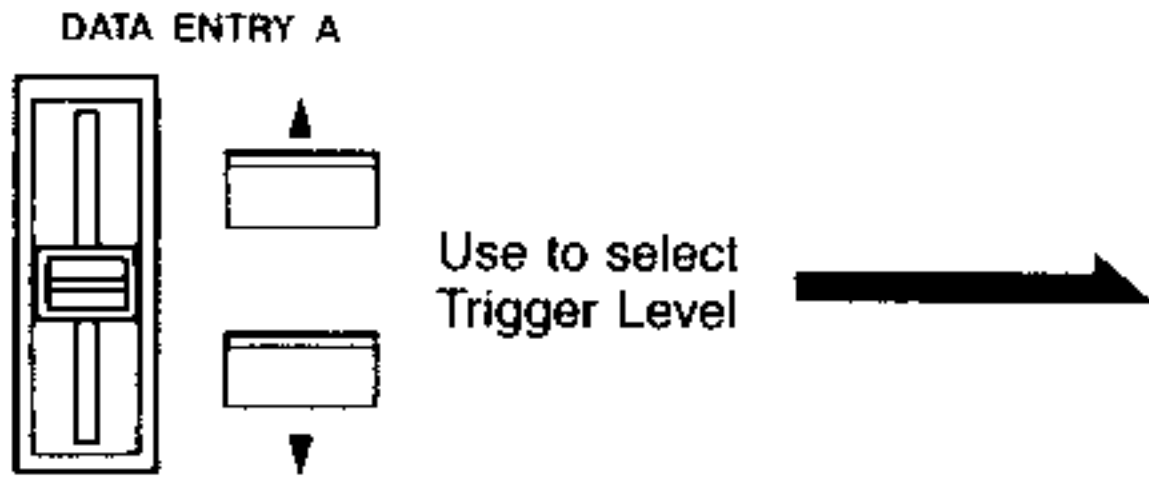

## F4 ORIGINAL/TOP KEY

### 1) About the original/top key function.

- This lets you change memory block assignments to the keyboard. These memory blocks and their sample numbers are specified by the F1 SAMPLE NO. /MEM. DIV. function. What we are changing here is the original key and top key assignments for particular blocks, where each block represents one sound sample.

(Example: memory division is 8.)

Memory block specified by sample number from F1 SAMPLE NO. /MEM. DIV. function.

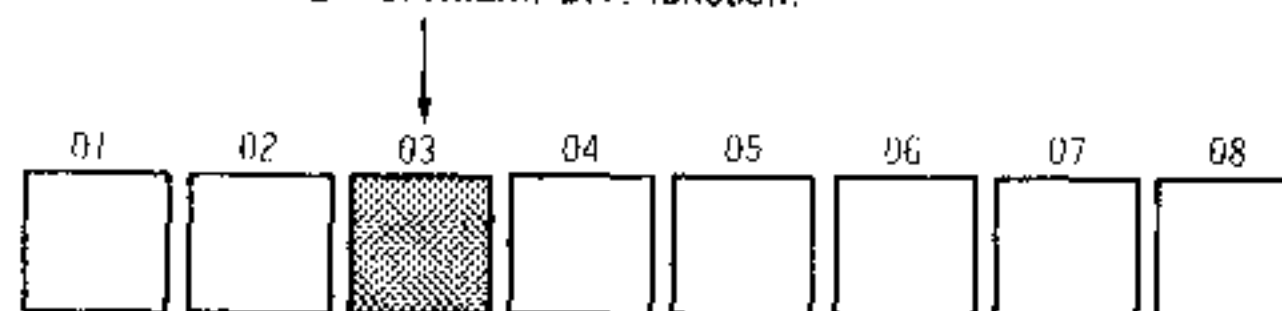

We will change the block's key assignments.

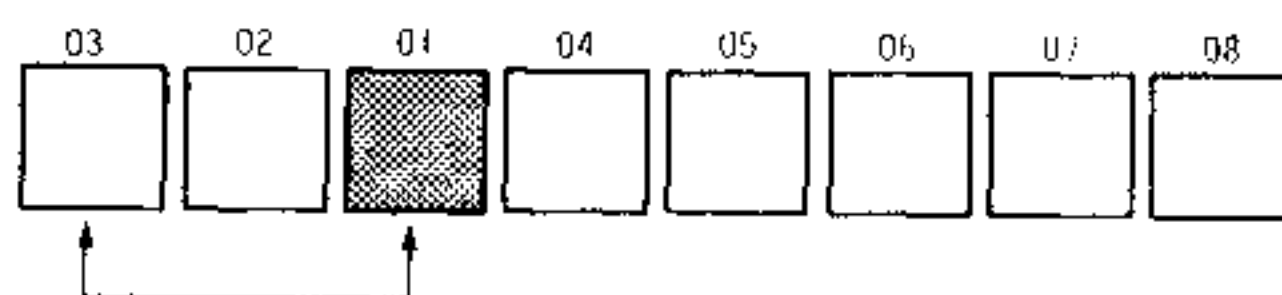







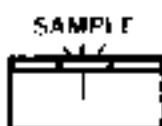
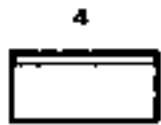

- Using this function, assignments can be changed before or after sampling for any particular memory block. However, memory block positions can not be rearranged.

#### Note:

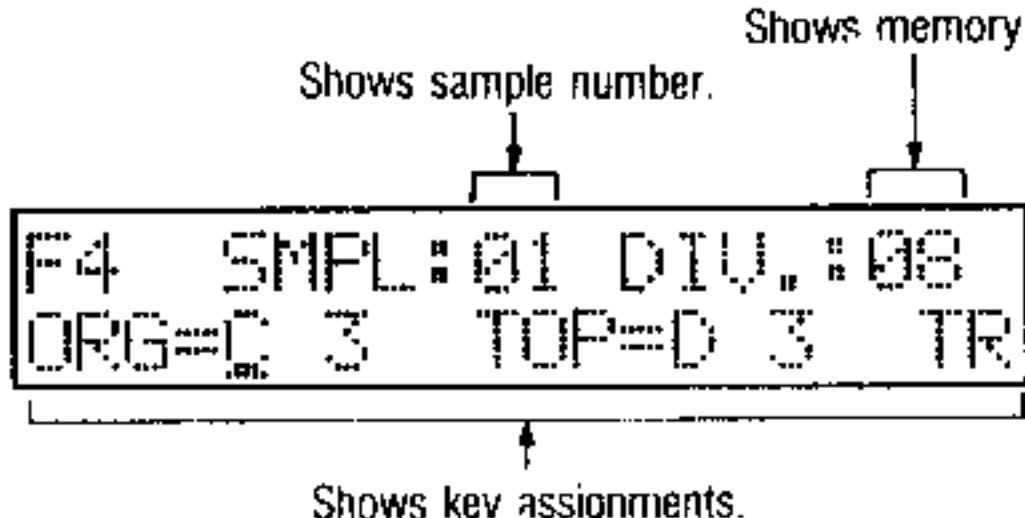
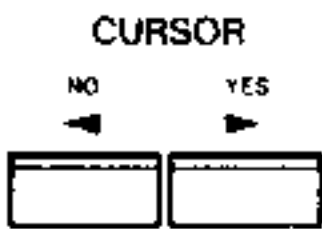
Sample mode key assignments are different from conventional key assignments in that you can not change the TR/NT condition. (It is fixed at TR.)

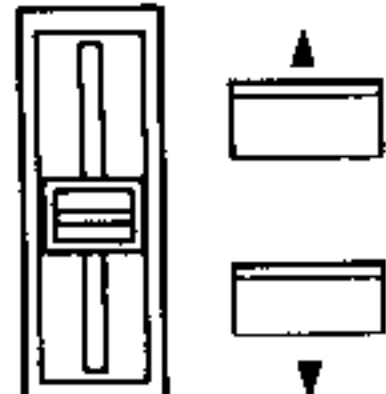

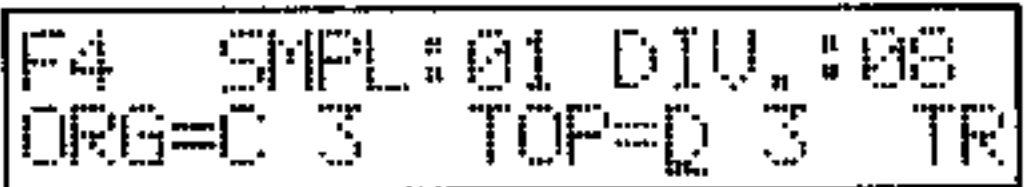
**2 Using the original/top key function.**

Operation	Operation of DSS-1
<p>① Confirm that the SAMPLE mode is selected and that you have completed the INITIAL operations (detailed in the previous section starting on page 61).</p>	<p>● Indicates SAMPLE mode.</p>  On
<p>① Press the number 4 key to select the original/top key function.</p> <p>Press  </p>	<p>● You now see the assignments for the memory block having the sample number specified when using the F1 function.</p> 
<p>② Use the CURSOR keys to select which assignment to change (original key or top key). Then use DATA ENTRY A to adjust the value.</p> <p><b>CURSOR</b></p> <p>NO YES</p>  <p>Use to select Original/Top Key </p> <p><b>DATA ENTRY A</b></p>  <p>Use to select Value </p>	 <p>Here cursor is under the top key value.</p>  <p>Here we have changed the top key value to F3.</p>

# F5 SAVE SAMPLE

## 1 About the save sample function.

- This lets you select a particular memory block, give its sampled sound a name, and save it to disk:

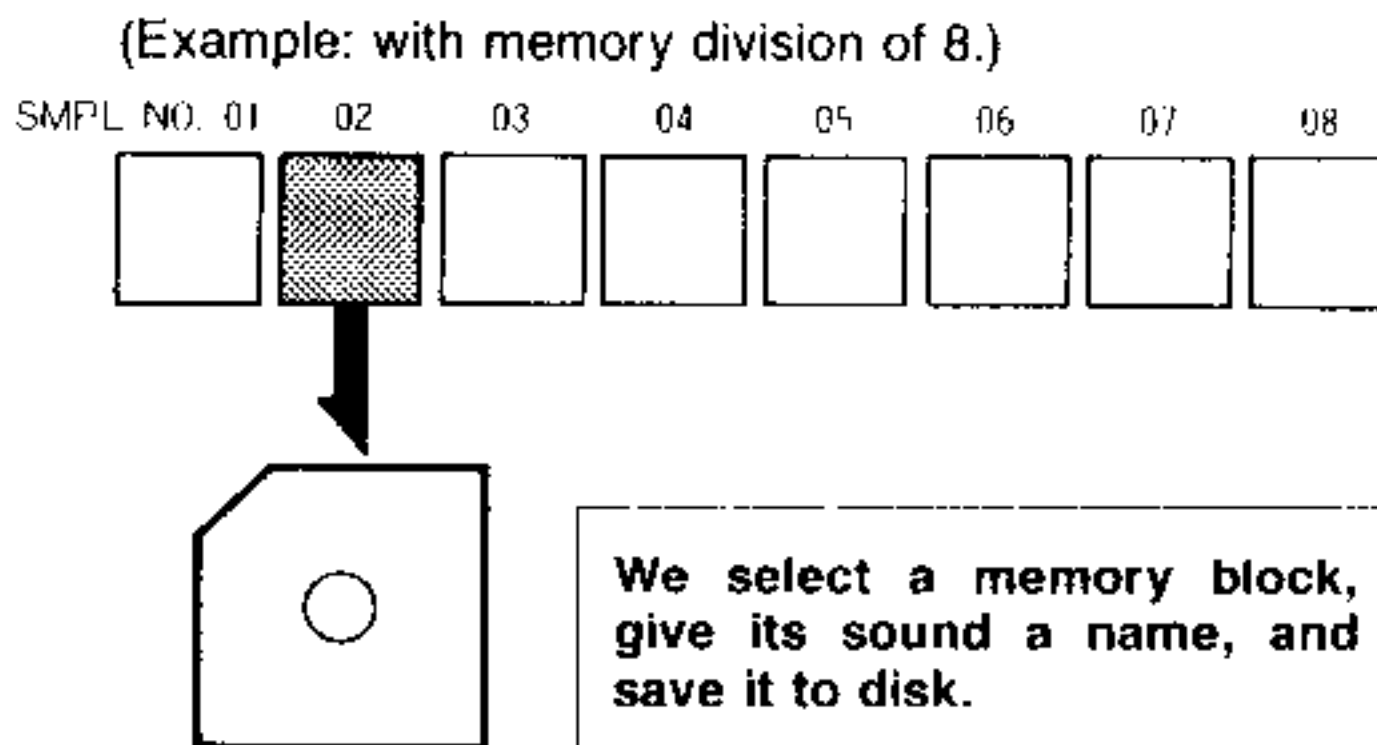

## 2 Using the save sample function.

Operation	Operation of DSS-1
<p>0) Confirm that the SAMPLE mode is selected and that you have completed the INITIAL operations (detailed in the previous section starting on page 61). Put a disk in the drive.</p>	<ul style="list-style-type: none"> <li>● Indicates SAMPLE mode.</li> </ul>
<p>1) Press key number 5 to select the save sample function.</p> <p>Press  </p>	<ul style="list-style-type: none"> <li>● Top line shows function number, sample number, and memory divisions. Bottom line prompts you to select a sample number.</li> </ul> <div style="text-align: center;"> <p>Shows memory divisions.</p> <p>Shows sample number.</p> <div style="border: 1px solid black; padding: 5px; display: inline-block;"> <p>F5 SMPL: 01 DIV.: 08 Select SMPL to Save</p> </div> <p>Shows sample select.</p> <p>ENTER</p>  Flashes while waiting.         </div>

- ② Use DATA ENTRY A to select the sample number that you wish to save to disk.

DATA ENTRY A

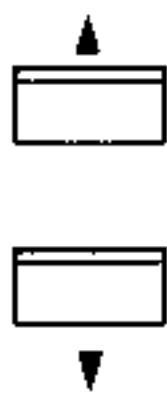
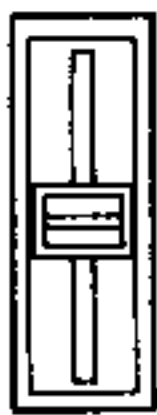

Use to select  
Sample Number



(例、+ Selected sample number appears here. 場合)

```
F5  SMPL:01 DIV.:08
Select SMPL To Save
```

- ③ Press ENTER to finalize your choice.

Press  →

- Next you are prompted for a name. (The name area defaults to "INO-NAME")  
The ENTER key flashes while waiting for a name.

```
F5  SMPL:01 DIV.:08
Input Name: INO-NAME
```

Shows a name.

Next you are prompted for a name.  
(The name area defaults to "INO-NAME").

ENTER

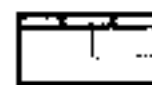

Flashes while waiting for a name.

④ Input a name by using the cursor keys and DATA ENTRY A.

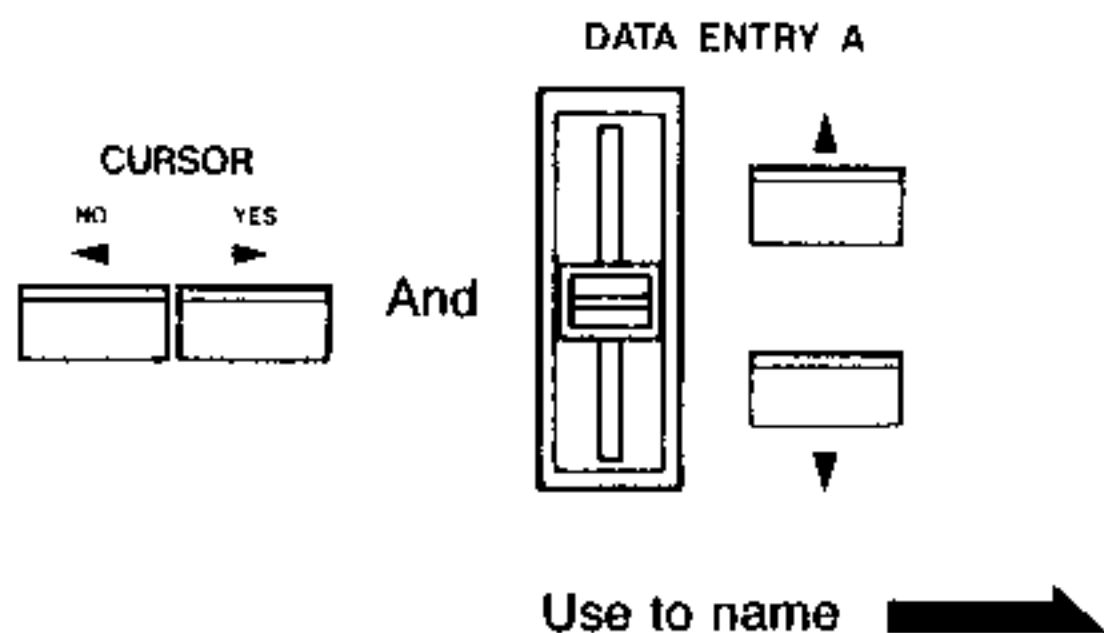

```
F5  SMPL: 01 DIV. : 08
Input Name: TEST-#01
```

Name appears here.  
(TEST-#01 is just an example)

★ You can clear the name area by pressing the cancel key.

⑤ Press enter to finalize your name.



● You are then asked whether it is okay to go ahead and save that sample to disk.

```
F5 TEST-#01 L=016366
Save SMPL#01 ?(Y/N)_
```

Shows function, name, and length.

Shows sample number.

Asks for confirmation.

⑥ Press YES or NO key.  
★ To save, press YES.



- Display asks you to wait while saving to disk.
- Then you are asked whether you wish to continue to use the save sample function.

```
F5 Saving...  
Please Wait a Minute
```



```
F5 Saving Completed  
Continue ? (Y/N)_
```

★ To abort and not save the sample, press NO.



- Display confirms function aborted and asks whether you wish to continue to use the save sample function.

```
F5 Aborted  
Continue ? (Y/N)_
```

- ⑦ Press YES to continue or press NO to quit.  
 ★ If you press YES then you can continue from step 2 above.



- ★ If you press NO then you leave the save sample function and are prompted to select another function.



- Pressing YES takes you back to where the DSS-1 is standing by for sample select. Continue from step 2 above.

- This ends the save sample function and returns you to the function select.

(If you had saved the sample before quitting, then the display says "Saving completed".)

```
F5 Saving Completed
Select (0-5):_
```

Shows you can select the function.

(If you had aborted before quitting, then the display says "Aborted".)

```
F5 Aborted
Select (0-5):_
```



Shows you can select the function.

- If you tell the DSS-1 to save to disk and it finds that there is already on the disk a sample having the same name then you will be asked whether you wish to write over the previous sample of the same name. If you answer yes, then the old sound will be deleted and your new sound will replace it on disk.

Display when you try to save using a name that already exists on disk.

Shows the name you try to delete.

```
F5 SOUND: TEST-#01
Delete Old ? (Y/N)_
```

Operation	Operation of DSS-1
<p>i) Use the YES and NO keys to reply.</p> <p>★ If you press YES then the old sound will be deleted and the new sound (in wave memory) having the same name will be saved in its place on the disk.</p> <p style="text-align: center;"> <small>YES</small>              Press         </p> <p>★ Press NO if you want to keep the old sound on disk.</p> <p style="text-align: center;"> <small>NO</small>              Press         </p>	<ul style="list-style-type: none"> <li>This is reflected in the display readouts. At the end you are asked whether or not to continue in the save sample function.</li> </ul> <pre data-bbox="1291 1182 1993 1312"> F5 SOUND: TEST-#01 Deleting... </pre> <p style="text-align: center;">↓</p> <pre data-bbox="1291 1436 1993 1566"> F5 Saving... Please Wait a Minute </pre> <p style="text-align: center;">↓</p> <pre data-bbox="1291 1719 1993 1849"> F5 Saving Completed Continue ? (Y/N)_ </pre> <ul style="list-style-type: none"> <li>Pressing NO will prevent the disk sound from being erased and will abort the saving procedure.</li> <li>The display confirms abortion and asks whether to continue in the same function.</li> </ul> <pre data-bbox="1291 2415 1993 2545"> F5 Aborted Continue ? (Y/N)_ </pre>
<p>ii) Following step is the same as step ①.</p>	

# CREATE WAVEFORM MODE

CREATE WAVEFORM MODE

## 1. About Each of the Functions

### F1 DRAW WAVEFORM

- ① About the draw waveform function.
  - With the draw waveform function, a multisound is created automatically in wave memory.
  - After drawing the waveform, you can edit it by specifying an address and then adjusting the level. The multisound is created automatically.

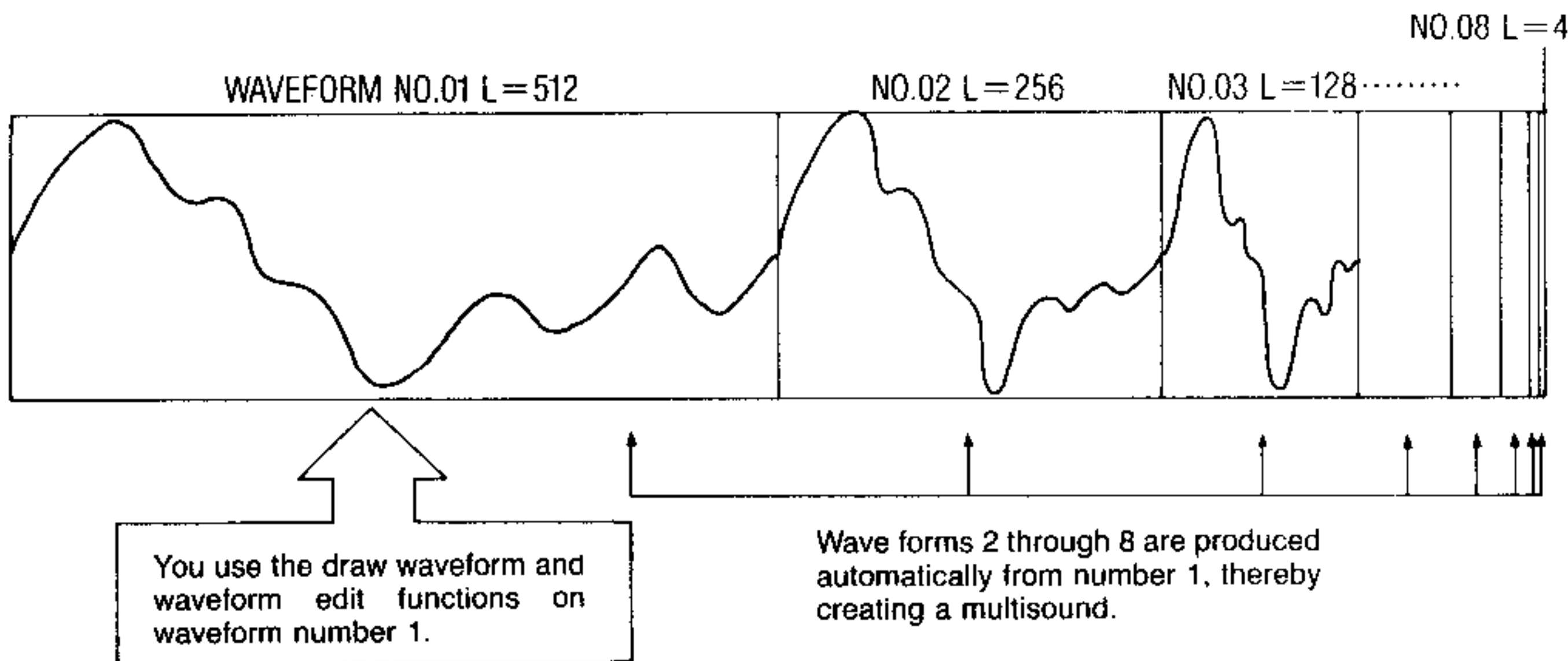
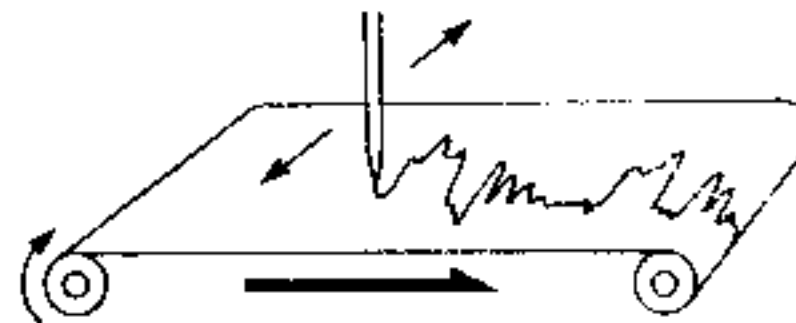

### ② Using the draw waveform function.

Operation	Operation of DSS-1
① Confirm that the CREATE WAVEFORM mode is selected. This means that the CREATE WAVEFORM key's LED lamp should be illuminated.	● Check key to see that LED is on.  <div style="text-align: center;">                         CREATE WAVEFORM   </div>



1 Press the number 1 key to select the draw waveform function.



- The display confirms the selection of function 1. It tells you to draw with slider A and tells you to press ENTER to start.

Shows draw waveform function.

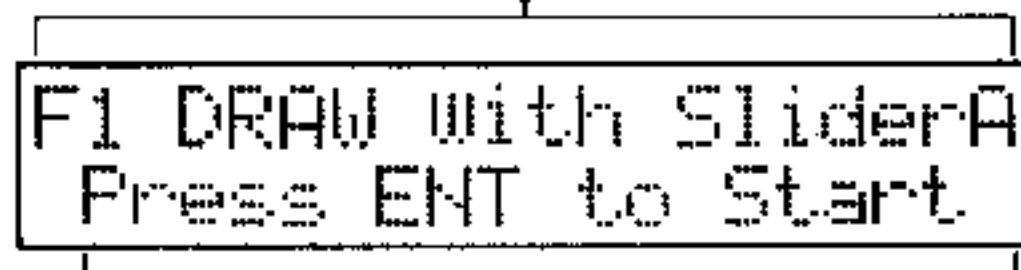

2 Start drawing waveform. Press the ENTER key to start. Move the DATA ENTRY A slider up and down to draw your waveform in relation to the time axis. Elapsed time is indicated on the display.



- Start drawing waveform.

Squares on upper line of display mean that slider is being moved.



Indicates elapsed time.

- After the time limit is reached, the function stops automatically and asks whether you wish to try again.

DATA ENTRY A



Use to change Level



③ Play the sound on the keyboard and decide whether to keep the wave or try again.



★ Press the NO key if you want to keep the wave and go ahead.



- Press the YES key to draw the wave again. This takes you back to step 2, above.

- If you press NO to keep the wave then the display asks whether you want to edit the waveform.

```
F1 Do You Want to
Edit WAVEFORM?(Y/N)_
```

④ Press the YES key if you wish to edit the waveform that you have drawn.



- You get the display for waveform editing. The top line shows the address and the level at that address in memory. The bottom line tells you to use the cursor keys and the DATA ENTRY A and B controls.

Shows the address.                      Shows the level at that address in memory.

```

      ↓                               ↓
ADDR=000: LEVEL=-2048
Use < > D.ENTRY A&B
  
```

(Possible ADDR (address) values: 000 ~ 511)  
 (Possible LEVEL values: -2048 ~ +2047)

★ If you do not want to edit the waveform then press the NO key.



★ This completes the draw waveform function and the display prompts you to select a function.

```
F1 WAVEFORM Draw
Select (1-3): _
```

Shows the function select.

⑤ Use the cursor keys, and the DATA ENTRY A and B controls to edit the waveform in memory.

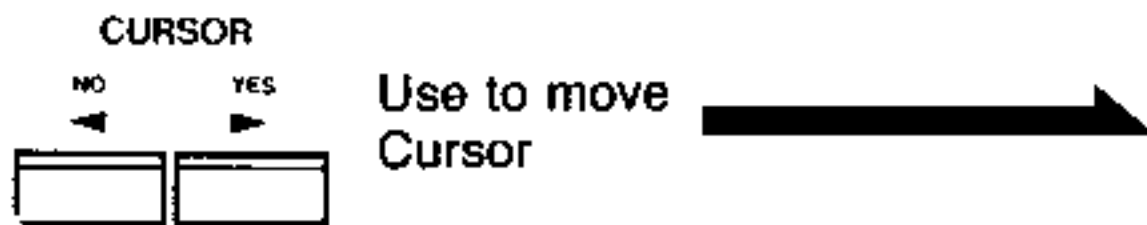

● Move the cursor to the places where you want to make changes.

(Example: When you select the level.)

```
ADDR=000: LEVEL=-2048
Use < > D.ENTRY A&B
```

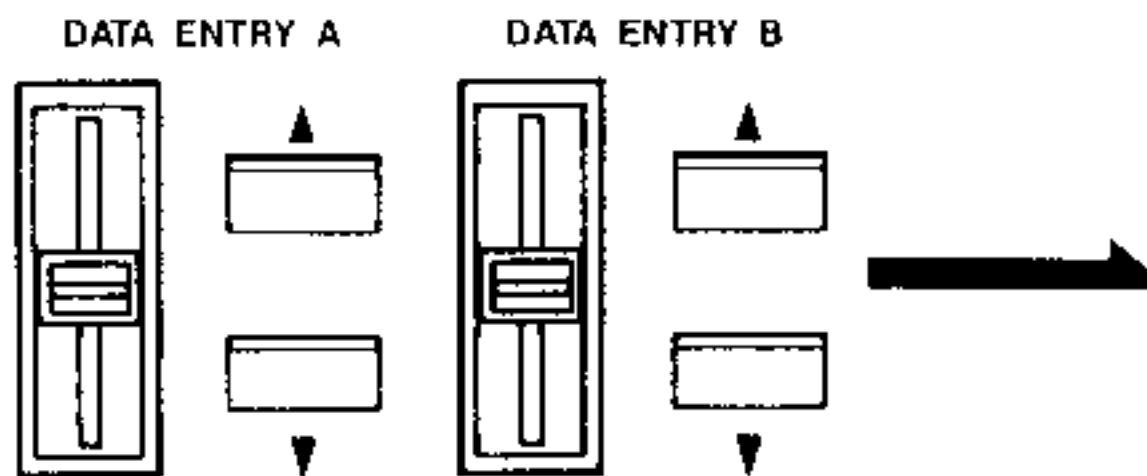

Use to select Address

● Shows selected address and current level setting.

(In this example the level is +2047.)

```
ADDR=000: LEVEL=+2047
Use < > D.ENTRY A&B
```

# F2 HARMONIC SYNTHESIS

## 1. What is harmonic synthesis?

■ The harmonic synthesis function adds together sine waves of different frequencies and levels, thereby creating a "multisound" in wave memory (RAM).

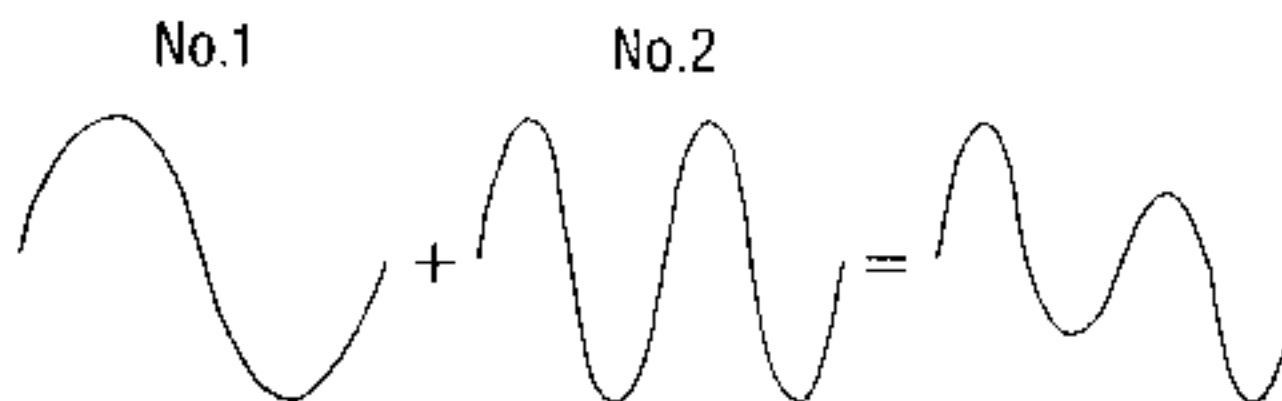

## 2. About the harmonics tables.

■ The DSS-1 offers you a choice of harmonics tables to use as the basis for harmonic synthesis. There are six initial choices.



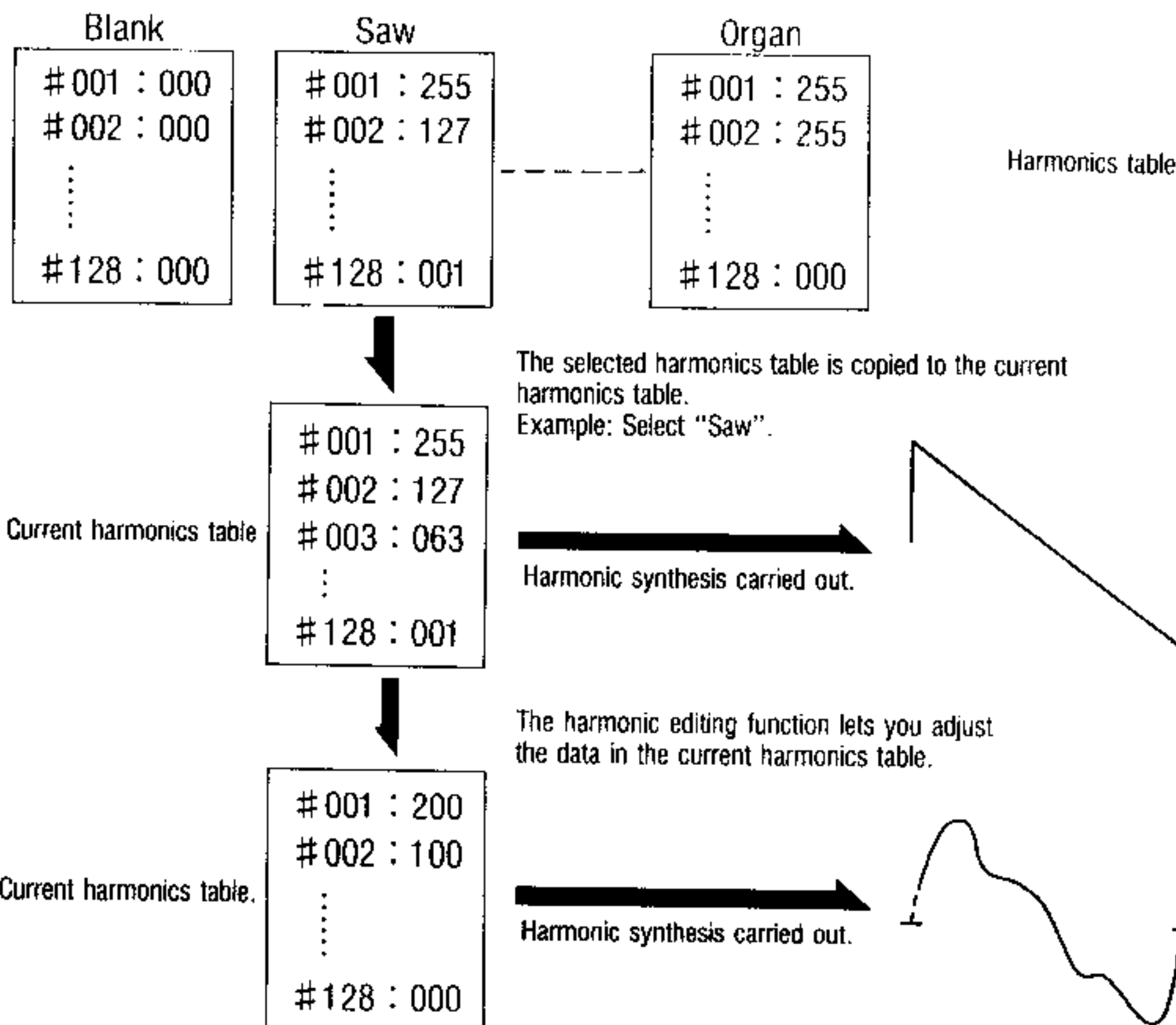

1. **BLANK**: Level is nil for all 128 harmonics.
2. **SAW**: A sawtooth wave.
3. **SQUARE**: A rectangular waveform.
4. **METAL**: A metallic gong-like waveform.
5. **CLAV**: A typical clavichord waveform.
6. **ORGAN**: A typical organ waveform.

■ When a harmonics table is selected, it is copied to the "current harmonics table" where you can work on it with the harmonic synthesis and editing functions.

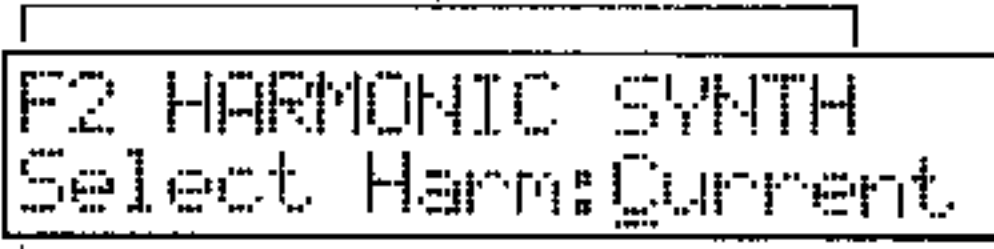

- Data in the current harmonics table is normally preserved even when you finish with the harmonic synthesis function. There are two exceptions.
  - 1) If you use the draw waveform function to draw a waveform. (The current harmonics table data is destroyed.)
  - 2) If you use the harmonic synthesis function to select another harmonics table (1 ~ 6). (The new data will overwrite the previous data.)
- Besides the above-mentioned choice of six harmonics tables, you can also choose "Current". Choosing the "current" option lets you use the current harmonics table data as is.

**2 Using the harmonic synthesis function.**

Operation	Operation of DSS-1
<p>① Confirm that you are in the CREATE WAVEFORM mode. Check to see that the CREATE WAVEFORM key's LED indicator is illuminated.</p>	<p>● Indicates CREATE WAVEFORM mode.</p> 
<p>② Press the number 2 key to select the harmonic synthesis function.</p> <p>Press </p>	<p>● The display confirms your choice of function and prompts you to select a harmonic table.</p> <p>Shows the harmonic synthesis function.</p>  <p> Flashes awaiting your choice.</p>

2 Use the DATA ENTRY A slider to choose a harmonic table.

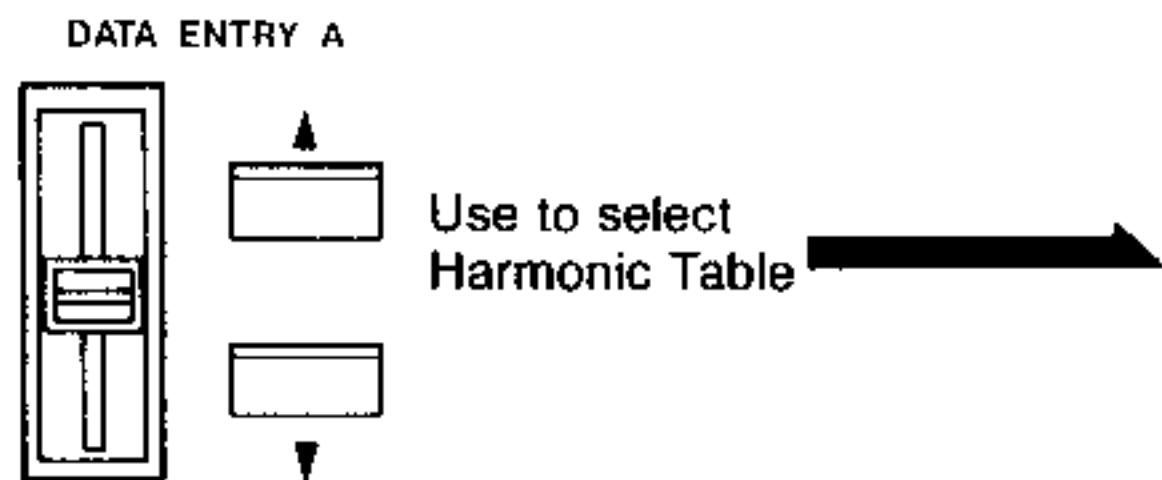

The display shows the selected harmonic table.

```
F2 HARMONIC SYNTH
Select Harm: Blank
```

(Example shows Blank.)

3 Press ENTER to finalize your selection.



- DSS-1 performs harmonic synthesis using the harmonic table.
- After completing the synthesis, it lets you edit the harmonics.

display while calculating harmonics.

```
F2 HARMONIC SYNTH
Calculating...
```

Display for editing.

Shows the number of the current harmonic. Shows its level.

```
HARM #001: LEVEL=000
Use DATA ENTRY A & B
```

4. Use DATA ENTRY A to select the harmonic.

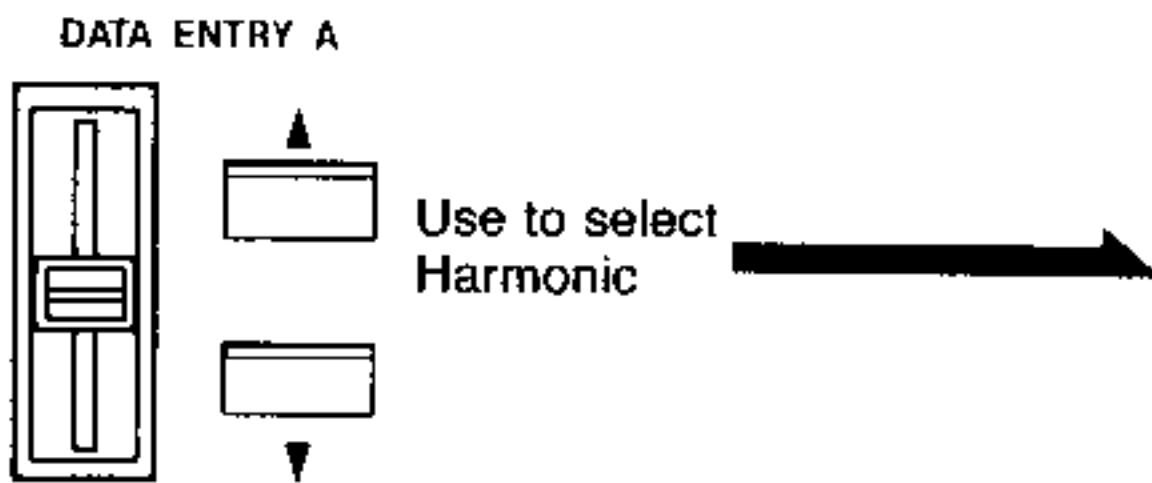

- Display shows current harmonic and its current level.

(This example shows the 11th harmonic and that its level is set to 0.)

```
HARM #011: LEVEL=000
Use DATA ENTRY A & B
```

5. Use DATA ENTRY B to adjust the level.

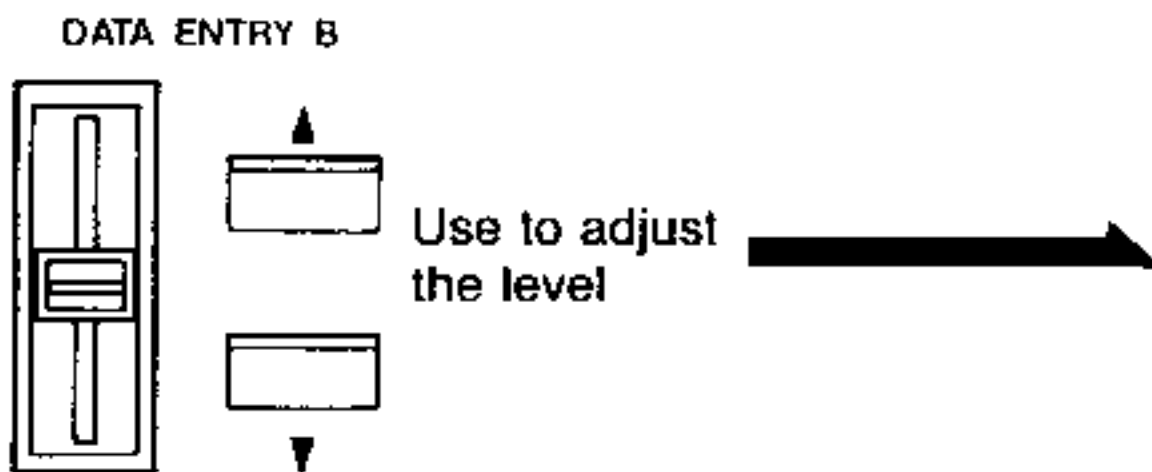

- Display shows current harmonic and your selected level. It waits for you to make changes as you like.

(Here the level is set to 10.)

```
HARM #011: LEVEL=010
Press ENT to Synth
```

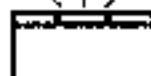
ENTER  
 Flashes, waiting for input.

- ⑥ Repeat steps ④ and ⑤ to select harmonics and adjust their levels.



- Press ENTER to finalize your adjustments.
- The DSS-1 then synthesizes the waveform based on the harmonic levels that you set in the previous steps. After completing the calculation, it takes you back to the editing condition in step ③. You can then continue with harmonic synthesis, repeating the procedure from step ④.

Display during calculation.

```
HARM #011:LEVEL=010  
Calculating...
```

Display for editing.

```
HARM #011:LEVEL=010  
Use DATA ENTRY A & B
```





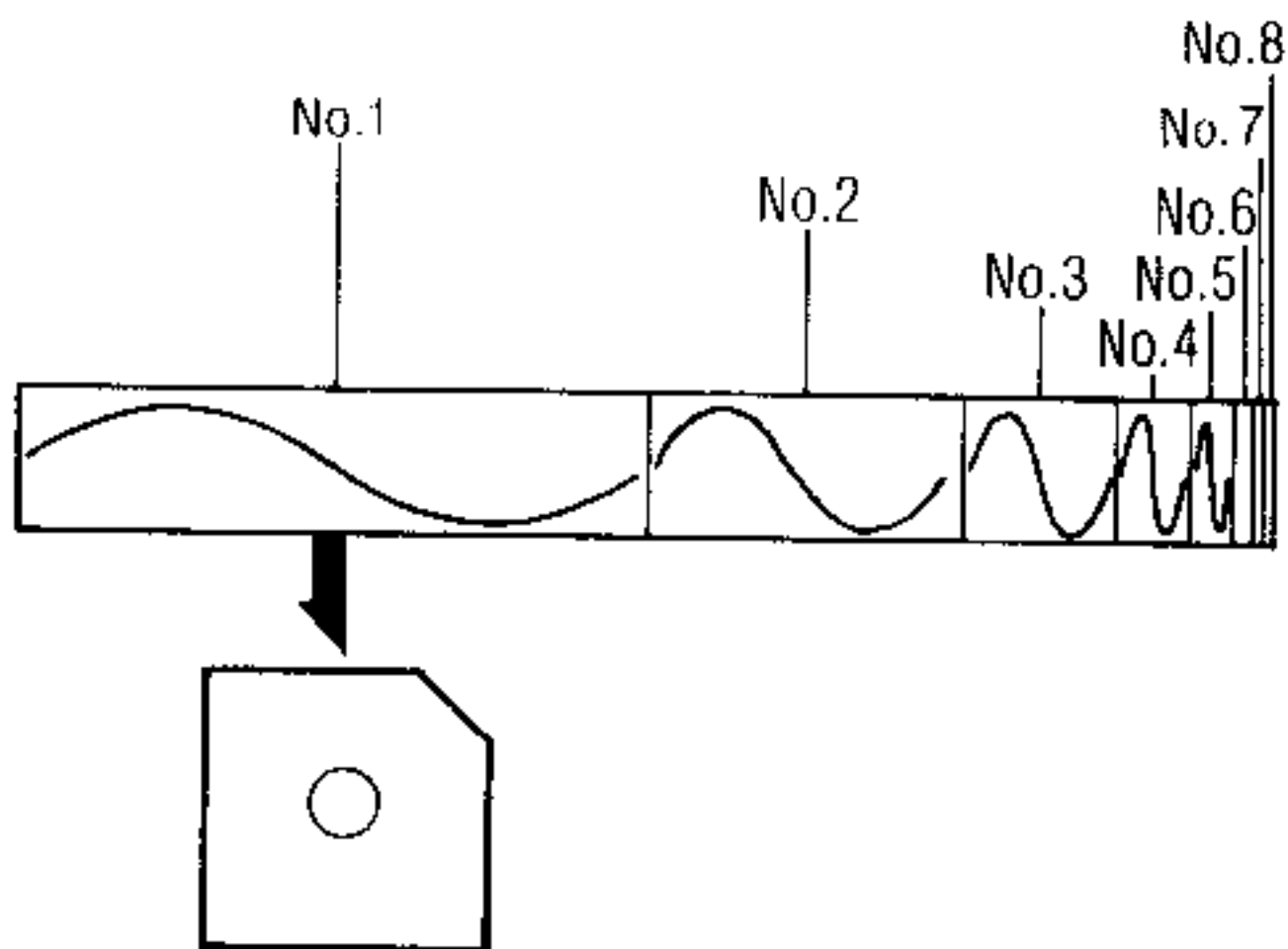

# F3 SAVE WAVEFORM

## 1) Using the Save Waveform function.

■ This function lets you save on disk the waveforms that you create using the F1 DRAW WAVEFORM and F2 HARMONIC SYNTHESIS methods.

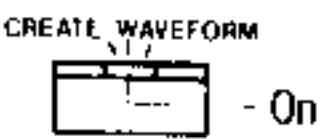
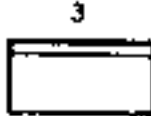

## 2) Using the save waveform function.

Operation	Operation of DSS-1
<p>① You must be in the CREATE WAVEFORM mode and you must have just completed making a waveform by using the F1 DRAW WAVEFORM or F2 HARMONIC SYNTHESIS methods.</p>	<p>● The CREATE WAVEFORM key's indicator is illuminated.</p> 
<p>① Press the number 3 key to select the save waveform mode.</p> <p>Press  </p>	<p>● The display confirms the F3 function and asks you to select a waveform.</p>  <p> Flashes awaiting your choice.</p>

2 Use the DATA ENTRY A slider to choose the waveform that you wish to save to disk.

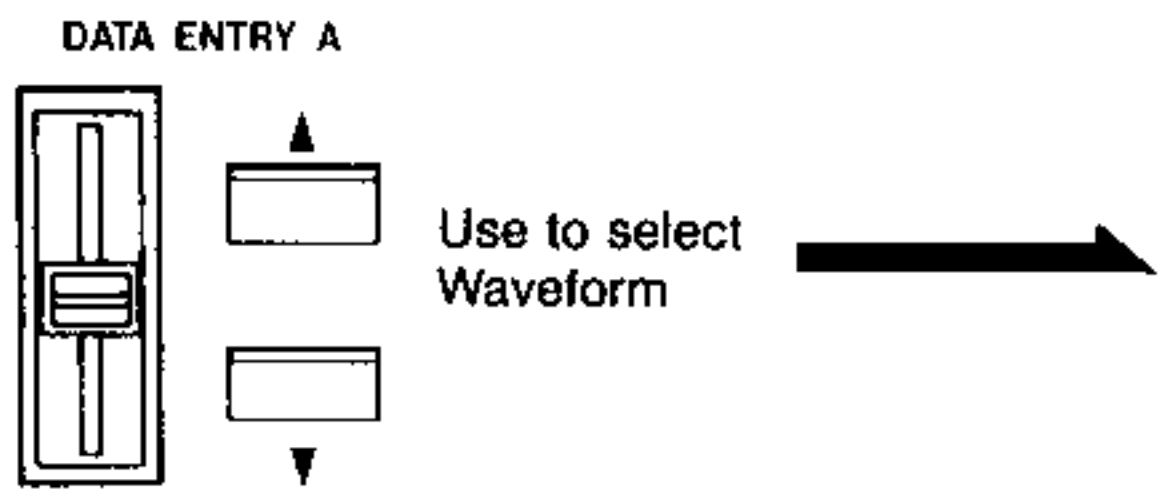

```
F3 SELECT WAVEFORM  
WAVEFORM: 02 KEY: B2
```

Shows the selected waveform number. Shows its original key.

3 Press the ENTER key to finalize your choice.



• You are prompted to name the waveform.

```
F3 SELECT WAVEFORM  
Input Name: _NO-NAME
```

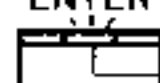
 Flashes awaiting input of a name.

4 Use the cursor keys and DATA ENTRY A to input a name.

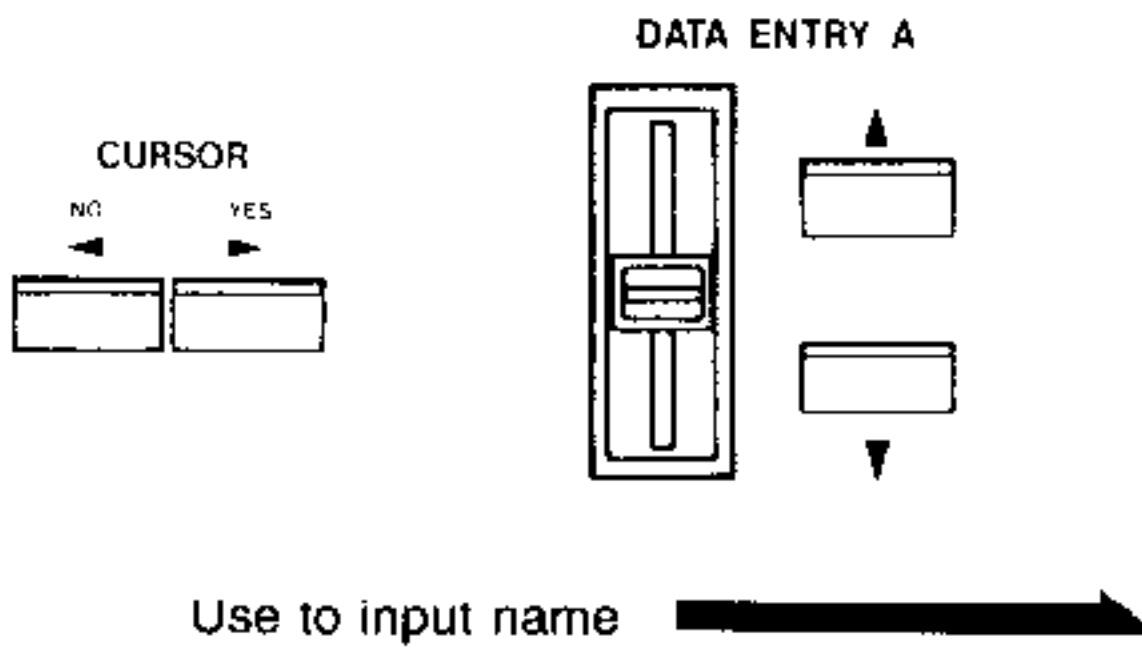

★ The cancel key can be used to clear the name.

```
F3 SELECT WAVEFORM
Input Name: TEST-#02
```

Display shows name in this area.  
(Example shows "TEST-#02")

5 Press ENTER to finalize name.



● Display shows the name that you gave and the length of the waveform. You are requested to confirm whether you wish to go ahead and save.

Shows the name of waveform.

Shows the length of waveform.

```
F3 TEST-#02 L=000256
Save ? (Y/N)_
```

6 Press the YES or NO key to reply.

★ To save, press YES.



- Display asks you to wait while saving to disk.
- Then you are asked whether you wish to continue to use the save waveform function.

```
F3 Saving...  
Please Wait a Minute
```



```
F3 TEST-#02 Saved  
Continue ? (Y/N)_
```

★ To abort and not save the waveform, press NO.



- Display confirms function aborted and asks whether you wish to continue to use the save waveform function.

```
F3 Aborted  
Continue ? (Y/N)_
```

⑦ Press YES to continue or press NO to quit.

★ If you press YES then you can continue from step ⑥ above and save other waveforms.



★ If you press NO then you leave the save waveform function and are prompted to select a function.



- Pressing YES takes you back to where the DSS-1 is standing by for waveform select. Continue from step ⑥ above.

- This ends the save waveform function and returns you to the function select.

(If you had saved the waveform before quitting, then the display says "Saved".)

```
F3 TEST-#01 Saved
Select (1-3):_
```

(If you had aborted before quitting, then the display says "Aborted".)

```
F3 Aborted
Select (1-3):_
```

- If you press YES in step (6), then DSS-1 first checks the disk directory to see if the name that you entered already exists. If it finds a waveform of the same name, then it asks you whether it is okay to delete that sound or not. refer to F5 SAVE SAMPLE (in the sample mode) for details on this procedure.

# EDIT SAMPLE MODE

## 1. About Each of the Functions

### F1 SELECT SAMPLE

#### 1 Select Sample Function.

■ This loads or transfers multisounds to the edit work area from the wave memory area or from a disk. This is necessary to allow editing using functions F3 through F8 in this mode.

#### Note:

Wave memory is used as the editing work area when in the edit sample mode. Therefore, when you complete the select sample procedure, all previous sounds or multisounds will be lost.



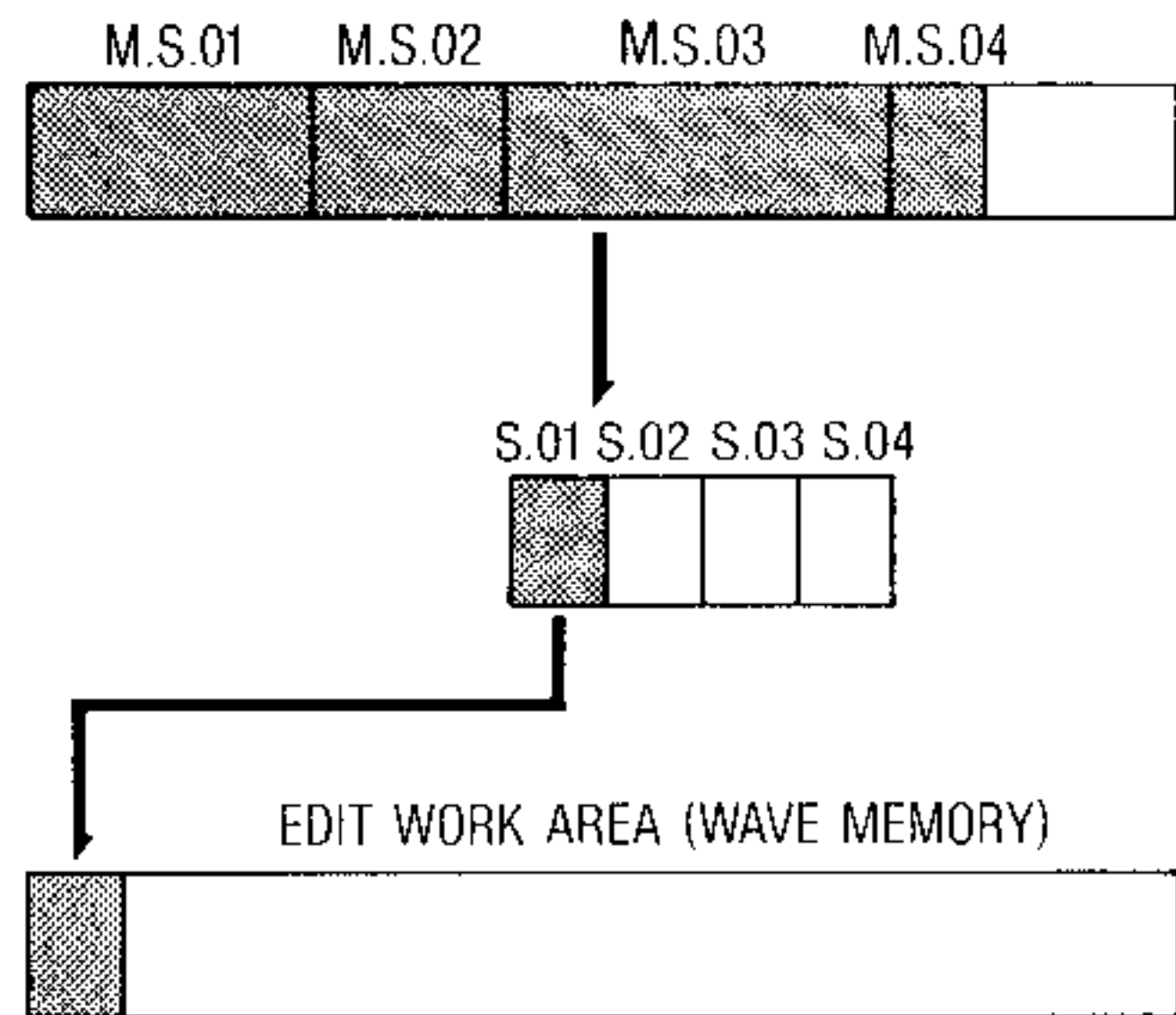

#### A. Getting a sound from wave memory.

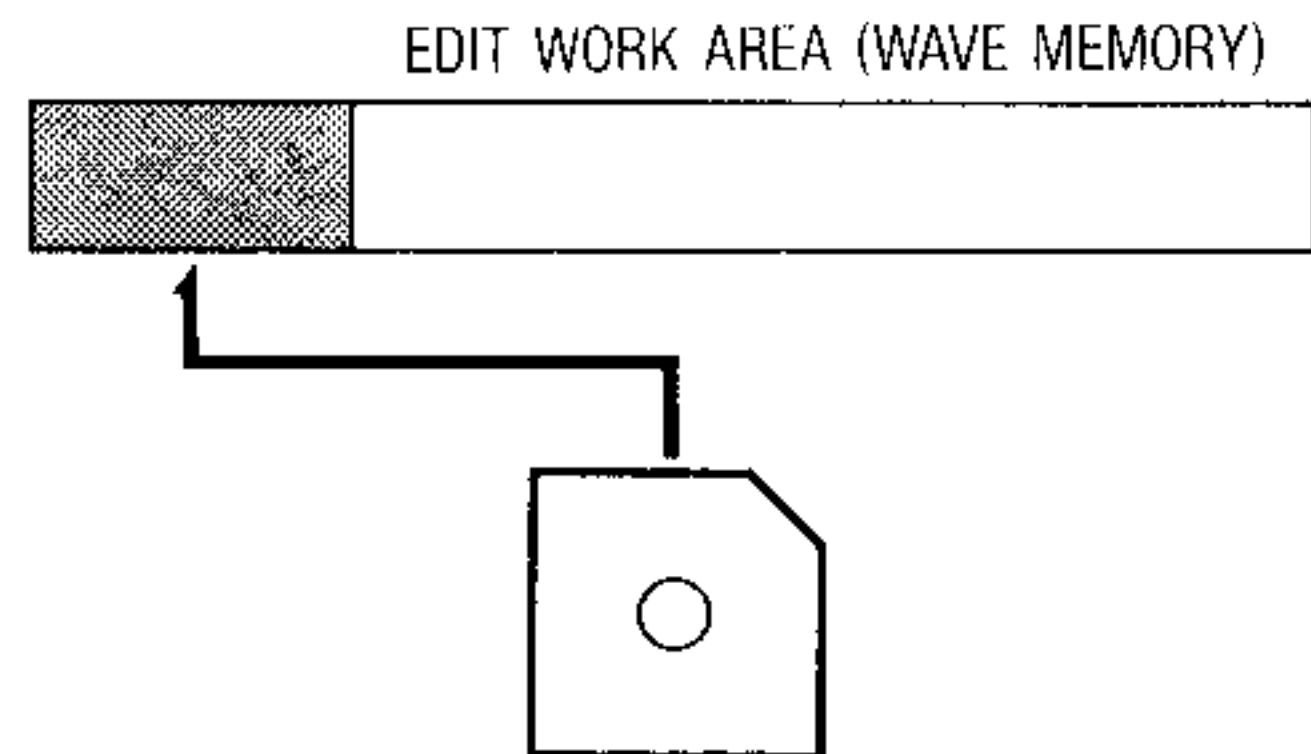

#### B. Getting a sound from disk.

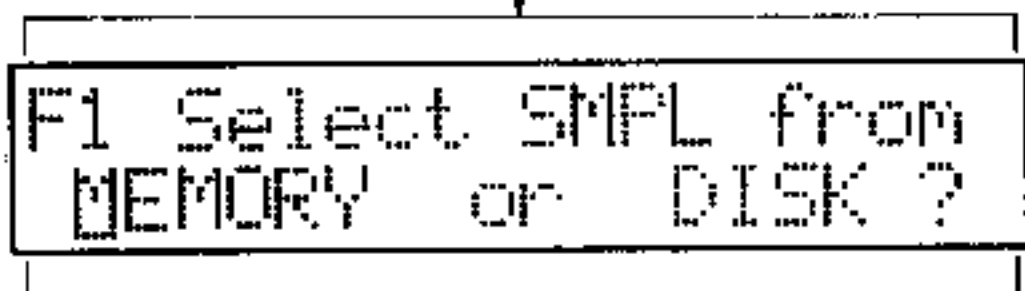

② Using the select sample function.  
**A. Getting a sound from wave memory.**

Operation	Operation of DSS-1
<p>① Confirm that the EDIT SAMPLE mode has been selected. The EDIT SAMPLE key should be lit.</p>	<ul style="list-style-type: none"> <li>● Indicates EDIT SAMPLE mode.</li> </ul> 
<p>① Press the number 1 key to select the select sample function.</p> <p>Press </p>	<ul style="list-style-type: none"> <li>● The display asks whether you wish to select a sample from memory or from disk.</li> </ul> <p>Shows the select function.</p>  <p>Shows sample selection.</p> 

② Make sure that the cursor is under the MEMORY side of the display, then press ENTER.



- The display readies for multisound selection. The lower line shows the multisound number, name, and length.

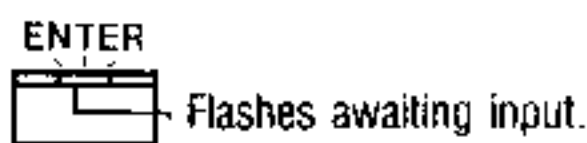
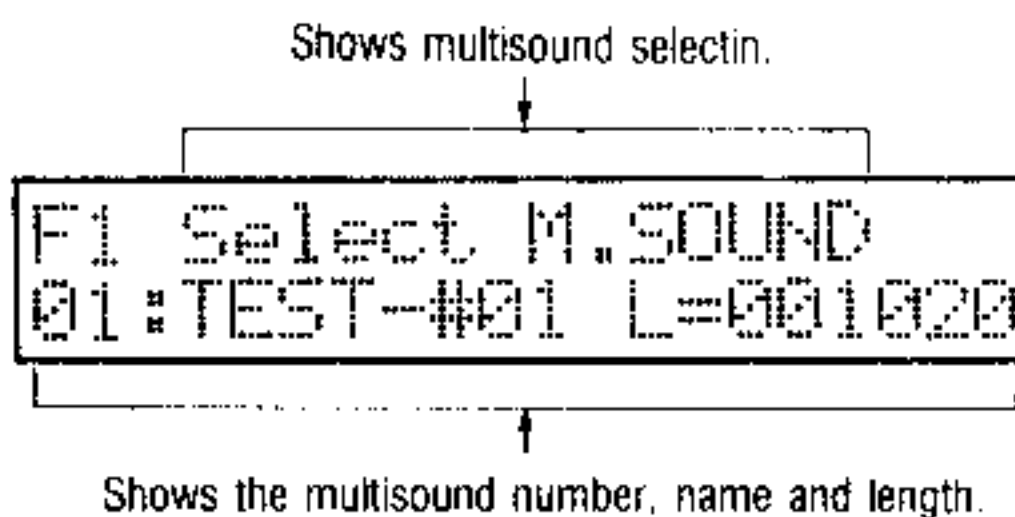

③ Use the DATA ENTRY A controls to select a multisound.

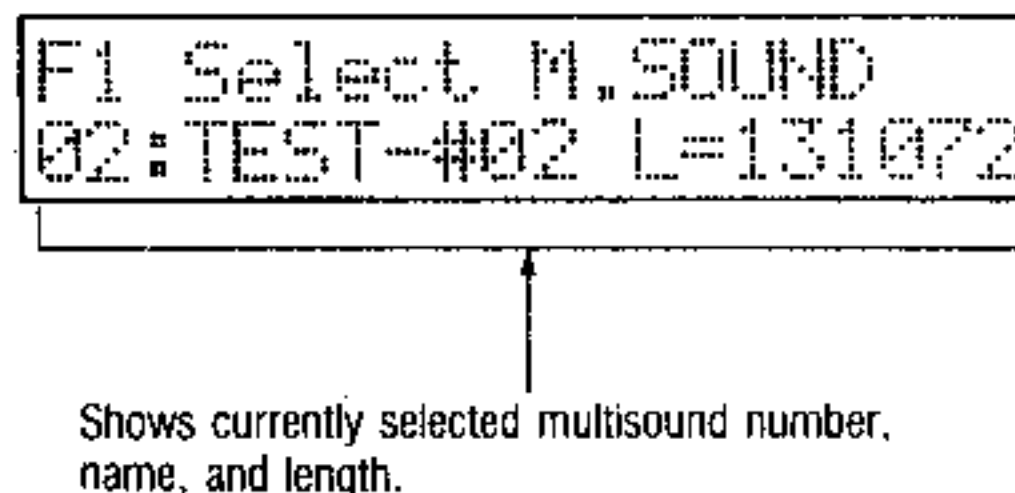
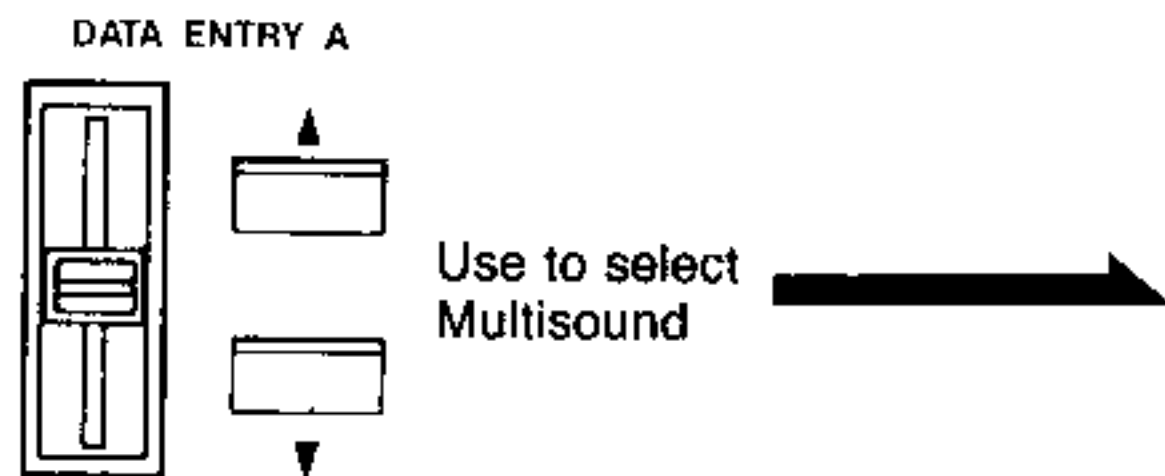



4. Press ENTER to finalize your choice.



- This completes multisound selection and advances to sound selection.

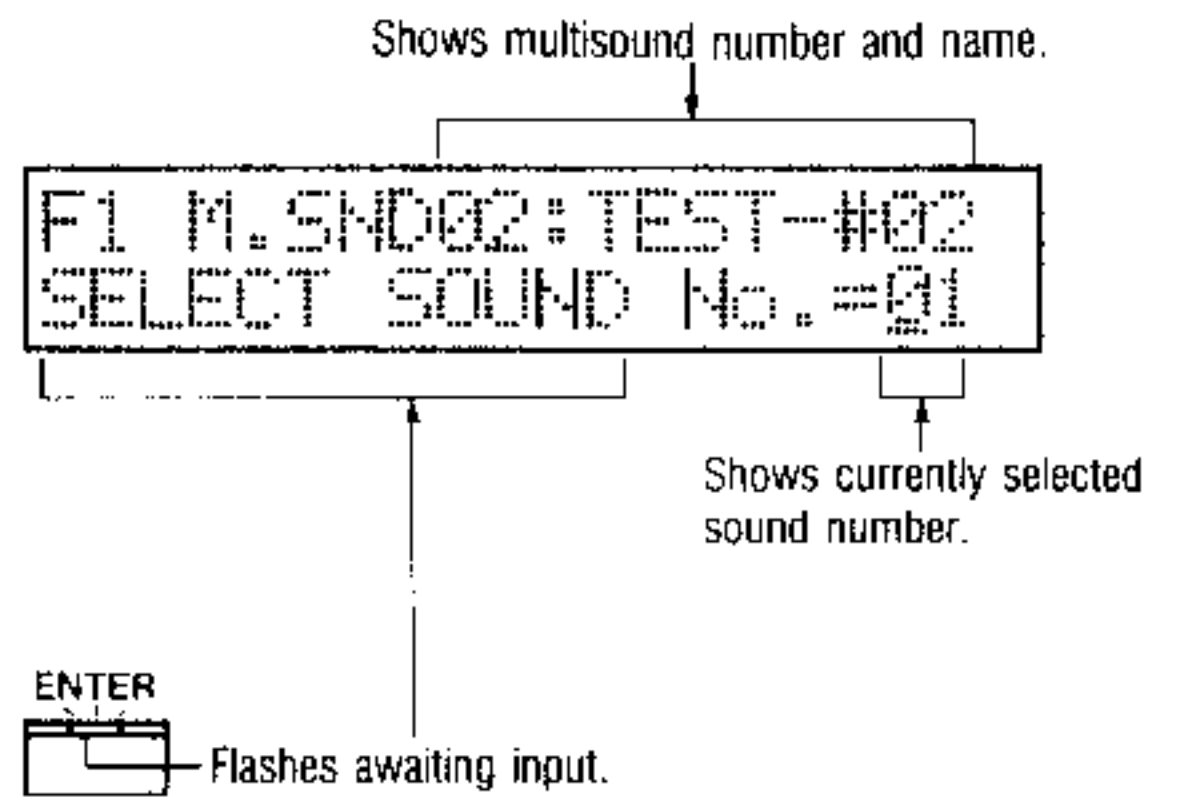

5. Use DATA ENTRY A or the keyboard to select a sound.

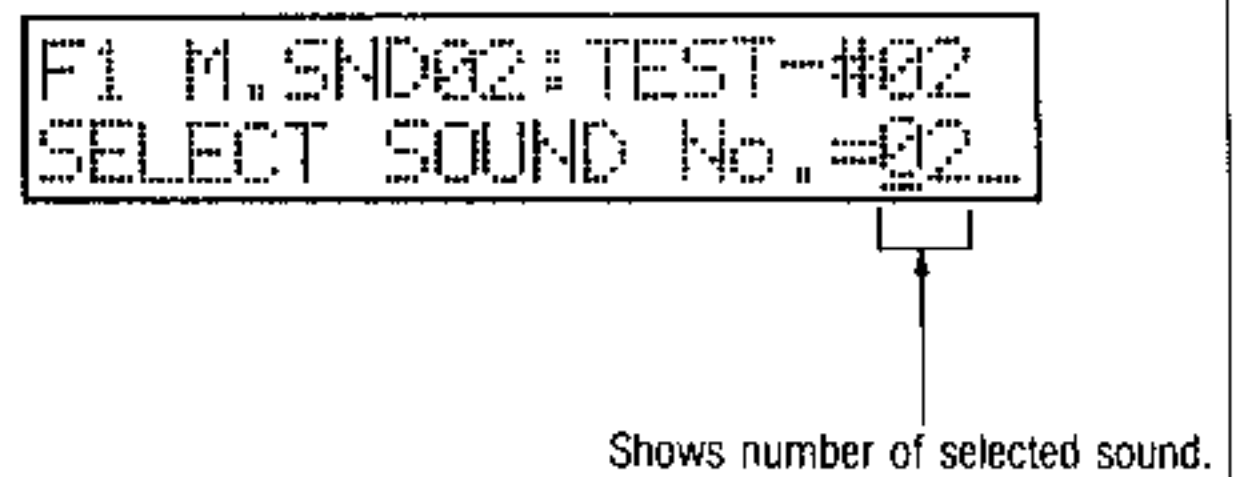
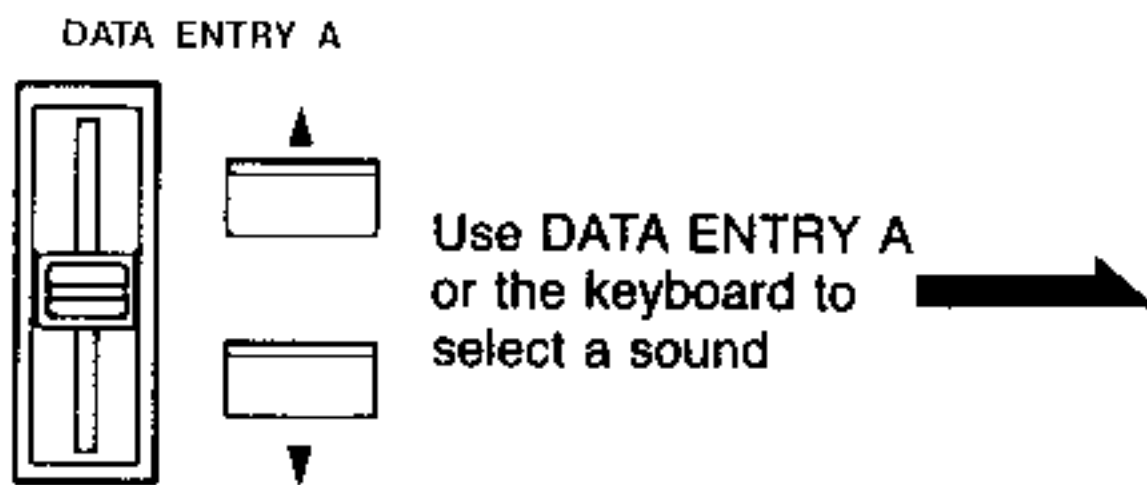

⑥ Press ENTER to finalize your selection.



- After the sound is selected you are asked whether to go ahead and get the sound into the work area.

Shows the multisound number and the selected sound number.

```
F1 Get M02: S02 (Y/N) _
L=016384 SF=32kHz
```

Shows the selected sound length and sampling frequency.

⑦ Check the display and press the YES key if you wish to go ahead and get the sound.



- After getting the sound, the display shows current key assignments and waits for key assignment settings.

```
F1 This Will Take
a While
```



```
F1 M02: S02 Got
ORG=C 3 TOP=F 3 TR
```



Flashes awaiting key assignment settings.

★ If you check the status of the sound and decide not to load it to the work area then press the NO key.



- This stops the process of getting a sound and aborts the select sound function. You are returned to step 0 and prompted to select another function or mode.

```
F1  Aborted
    Select (1-2):_
```

Shows the select sound function.

⑧ Use the cursor keys to select key assignments.

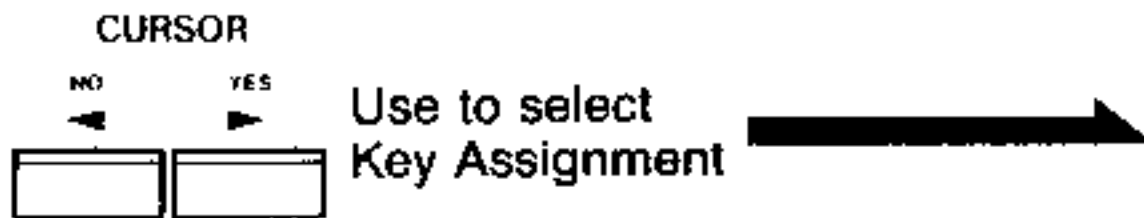

- The cursor flashes to mark the selected key assignment to work on.

```
F1 M02: S02 Got
   ORG=C 3  TOP=F 3  IR
```

The cursor flashes.

⑨ Use DATA ENTRY A to select the key assignment conditions.

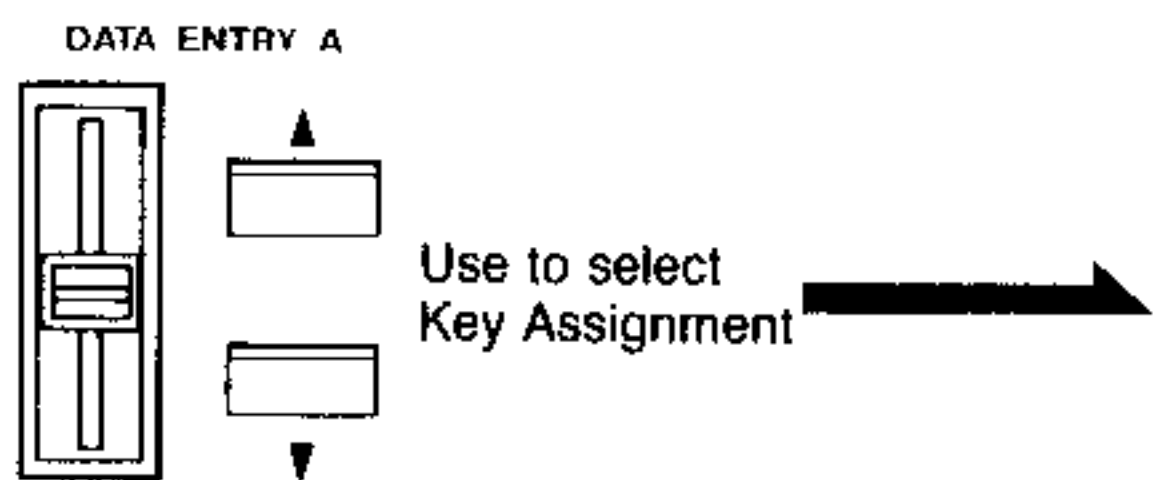

```
F1 M02:502 Got
ORG=C 3 TOP=F 3 NT
```

Shows currently selected key assignment.

⑩ After setting key assignment, press ENTER.



- This finalizes the changes.
- The display returns to the situation in step ⑧, prompting you to select another function or change modes.

```
F1 SAMPLE Selected
Select (1-8):_
```

Shows you can select another function.

**B. Getting a sound from disk.**

Operation	Operation of DSS-1
① Confirm that the EDIT SAMPLE mode has been	● Indicates EDIT SAMPLE mode.

③ Press ENTER.



- This selects disk and starts a search on the disk. Then you are prompted to use DATA ENTRY A to select a sound.

```
F1 Searching for  
SOUNDS on Disk
```



```
F1 Use DATA ENTRY A  
Select&Press ENTER
```

④ Use DATA ENTRY A to select a sound.

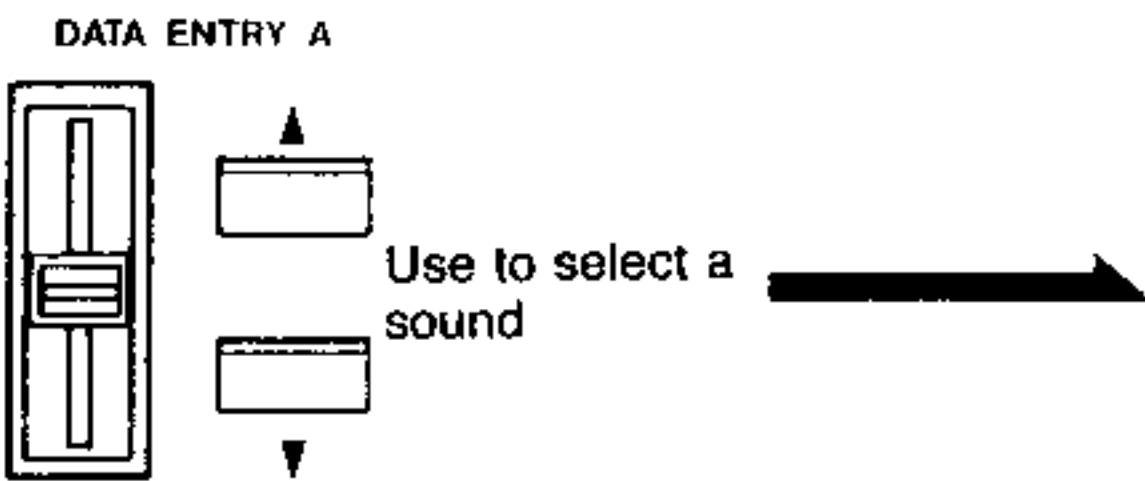

- Display shows selected sound name.

```
F1 Select SOUND  
SOUND : IEST-#01
```

↑  
Shows the selected sound name.

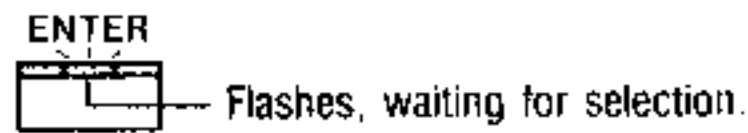

5 Press ENTER to finalize choice.



- The DSS-1 reads the length and sampling frequency of the sound and displays this data with the name of the sound. You are asked whether you wish to get this sound to the work area or not.

```
F1 Loading...
Please Wait a Minute
```

Shows the name of the sound and asks whether or not to get it to the work area.

```
F1 Get TEST-#01(Y/N)
L=000121 SF=32kHz ?...
```

Shows the length. Shows the sampling frequency.

6 Check the sound's name, length, and sampling frequency. If you wish to load, then press the YES key.



- The selected sound is loaded and the key assignment settings are displayed.

```
F1 Loading...
Please Wait a Minute
```

```
F1 Loading Completed
ORG=C 3 TOP=F 3 TR
```

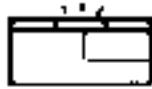
ENTER  
 Flashes awaiting key assignment setting.

★ If after checking the status you decide not to load, then press the NO key.



- This aborts the function and returns you to step u where you can either select another function or change modes.

```
F1  Aborted
      Select (1-8):_
```

Shows you can select another function.

⑦ Use the CURSOR keys to select key assignment.

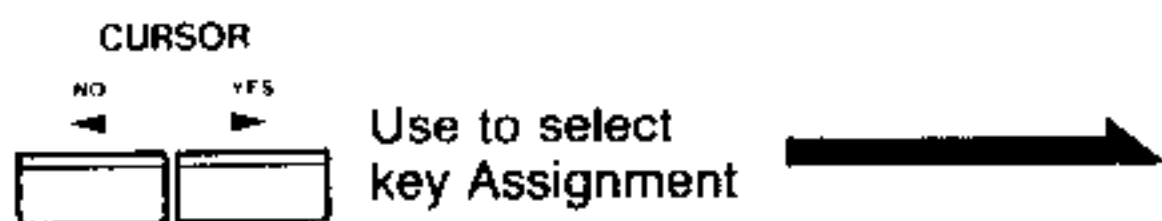

- Cursor flashes under item to be changed.

```
F1 Loading Completed
ORG=C 3  TOP=F 3  IR
```

The cursor flashes.



8 Use DATA ENTRY A to set key assignment.

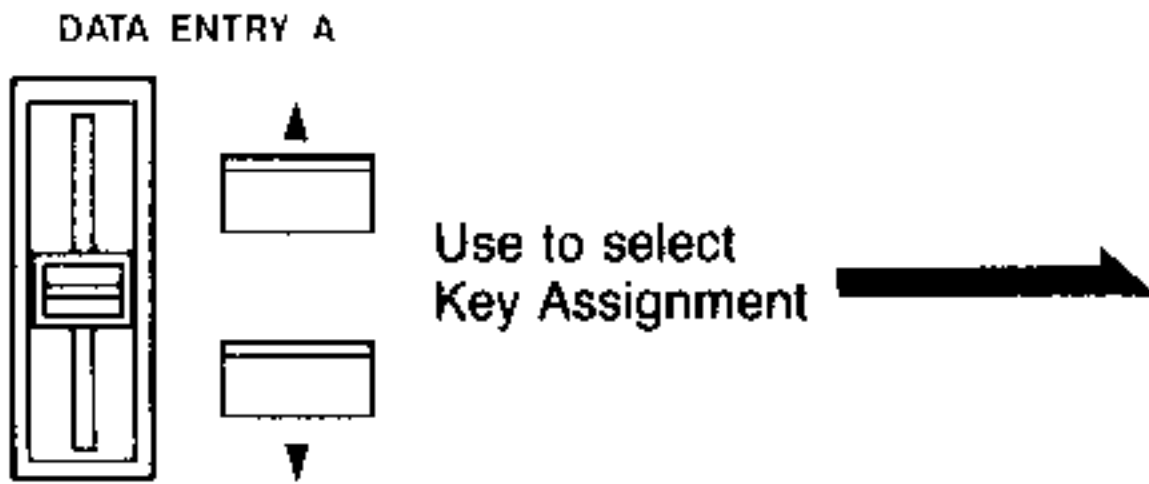

- Shows currently selected key assignment.

```
F1 Loading Completed
ORG=C 3 TOP=F 3 NT
```

Shows currently selected key assignment.

9 Press ENTER to finalize setting.



- After completion, the display returns to the initial condition, permitting you to select another function or change modes.

```
F1 SAMPLE Selected
Select (1-8): _
```



Shows you can select another function.

## F2 AUTO REPEAT ON/OFF

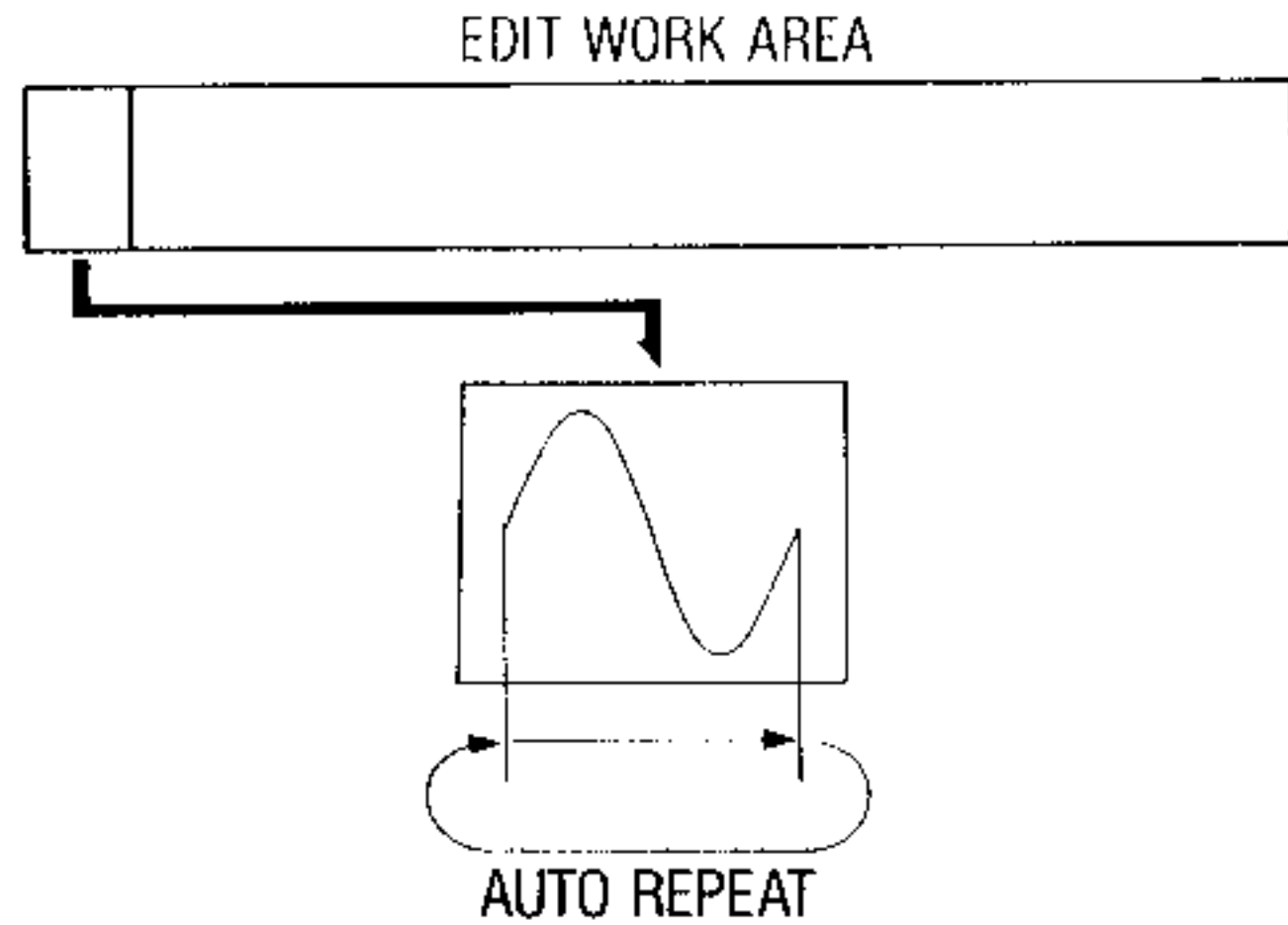
- ① **Purpose of auto repeat on/off function.**
  - Provides automatic repeated reproduction of the sample in the edit work area. Usually you turn this function on when editing a single wave cycle.

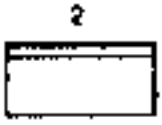

### 2. Using the truncate start/length function.

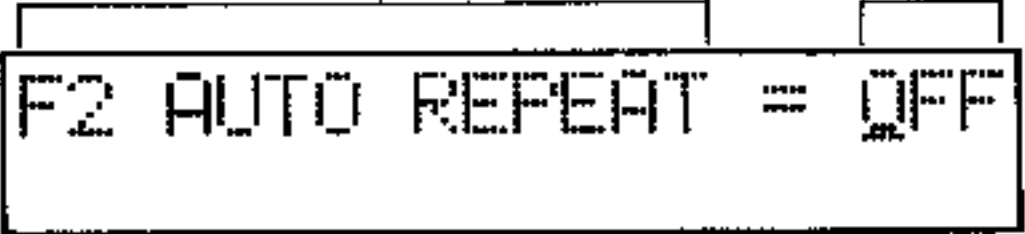
Operation	Operation of DSS-1
① Go into the EDIT SAMPLE mode. Confirm that the EDIT SAMPLE key is lit.	<ul style="list-style-type: none"> <li>● Indicates EDIT SAMPLE mode.</li> </ul> 
② Press the number 2 key to select the auto repeat on/off function.  Press  	<ul style="list-style-type: none"> <li>● You are prompted to input.</li> </ul> <p>Shows the auto repeat on/off function.</p> <p>Shows the setting.</p> 

- 2 Use the DATA ENTRY A controls to select ON or OFF as desired.

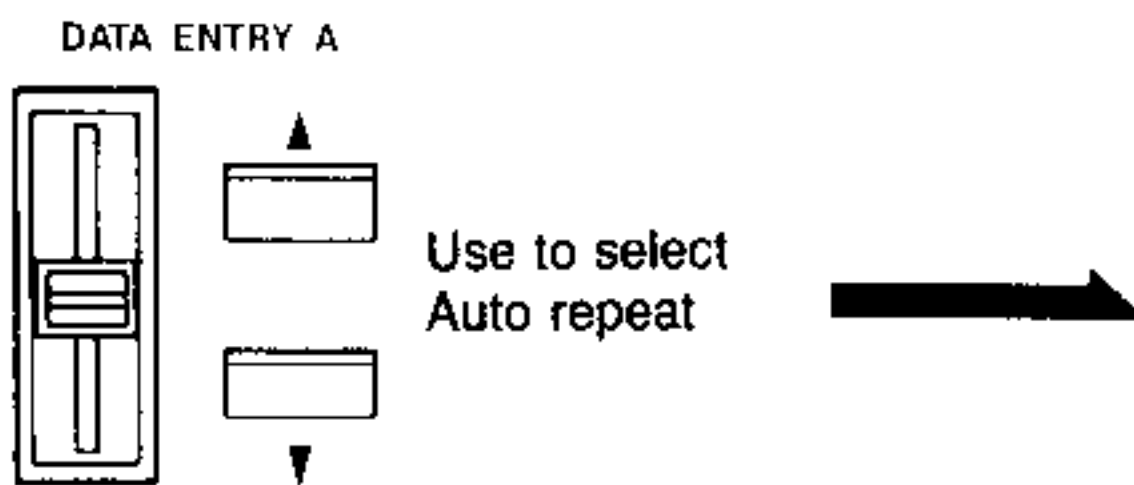

Shows currently selected setting.

F2 AUTO REPEAT = ON

## F3 TRUNCATE START/LENGTH

### 1 Purpose of truncate start/length function.

■ This lets you cut off a piece of a sound that you have loaded into the work area (using F1). You specify the starting point and the length of the section to be cut out. Afterward, you can use the F8 SAVE/RENAME SAMPLE function to save the truncated sector to disk. This is handy for cutting samples down to smaller sizes.

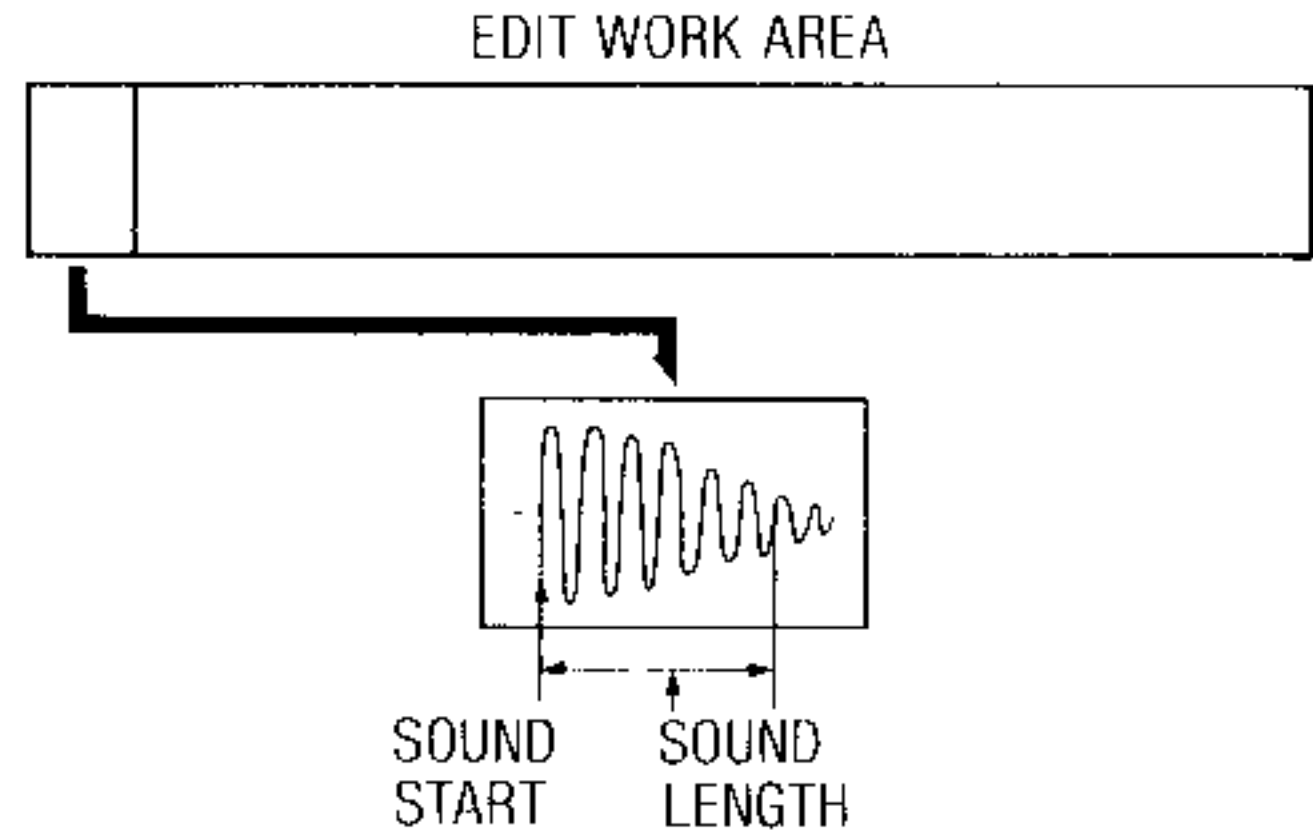

### ■ About the Auto Truncate capability.

This is effective when editing the SS (sound start) and SL (sound length) parameters.

While editing SS, if you press the ENTER key, then the SS point will move inward to ① in the example. Press ENTER again and it will move to ②. Similarly, while editing SL, if you press the ENTER key, the SL will shorten to point ① in the example. Press ENTER again and it will shorten again to point ②. In other words, auto truncate shortens the sound while cutting at the zero cross point.

Direction of automatic truncation

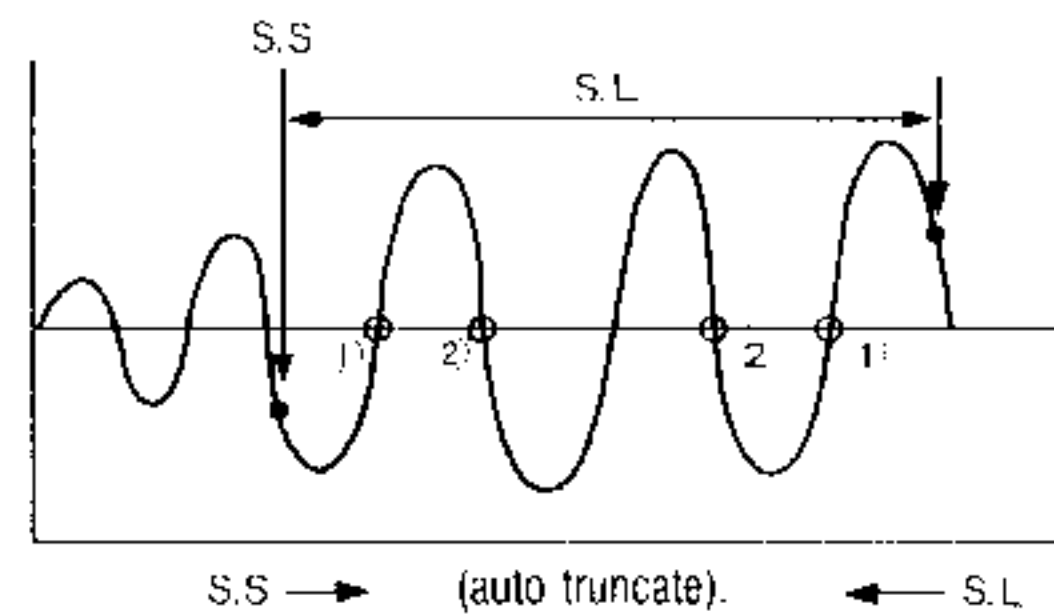

### ■ Using the DATA ENTRY A and B sliders and arrow keys to enter numeric values.

These cover six places. The DATA ENTRY A slider covers the 10,000 and 100,000 places. The DATA ENTRY A keys handle the thousands place. The DATA ENTRY B slider covers the hundreds and tens, while the keys handle the ones.

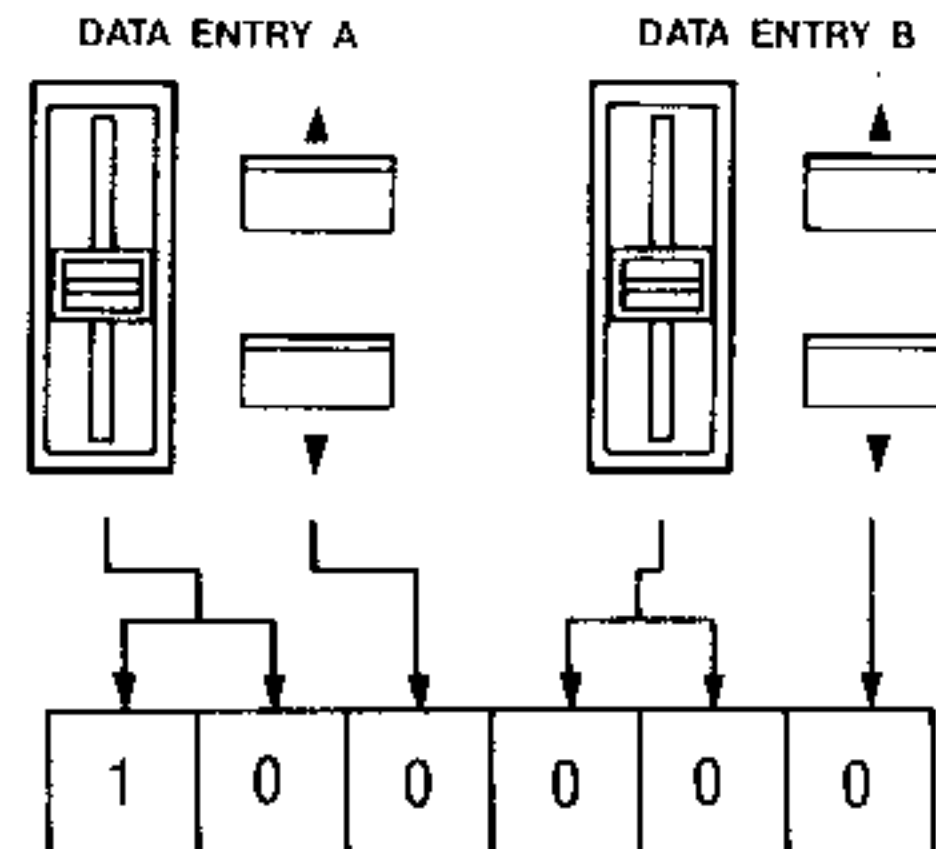

- When you edit the sound start point, the sound length becomes the actual sound length minus the sound start.



$$\text{(SOUND LENGTH)} = \text{(ACTUAL LENGTH)} - \text{(SOUND START)}$$

“Sound start” does not change when you edit “sound length”. The sum of the two is less than or equal to the actual sound length.

$$\text{(SOUND START)} + \text{(SOUND LENGTH)} \leq \text{(ACTUAL LENGTH)}$$

Actual length is the length displayed when you get a sound with F1. The initial values are 000000 for sound start, and the actual sound length for the sound length.

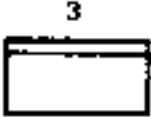
2 Using the auto repeat on/off function.

Operation	Operation of DSS-1
<p>① Confirm that the EDIT SAMPLE mode is selected (so its LED is illuminated).</p>	<ul style="list-style-type: none"> <li>● Indicates EDIT SAMPLE mode.</li> </ul> 
<p>① Press key 3. The selected function is confirmed on the display.</p> <p>Press  </p>	<ul style="list-style-type: none"> <li>● The display shows the current status of this function.</li> </ul> 

② Use the cursor keys to select the sound start (S.S.) and sound length (S.L.) parameters.

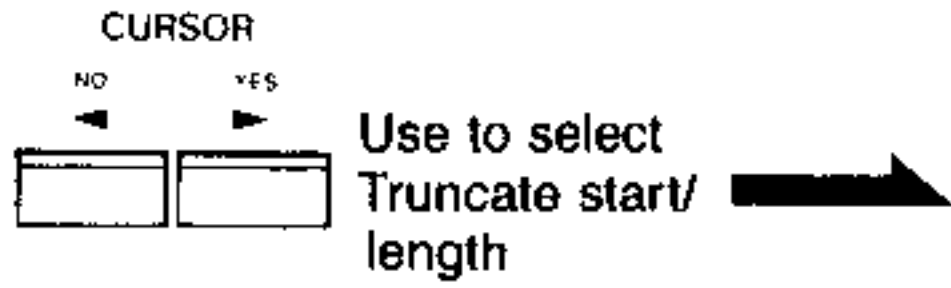

Shows you can select automatic truncation.

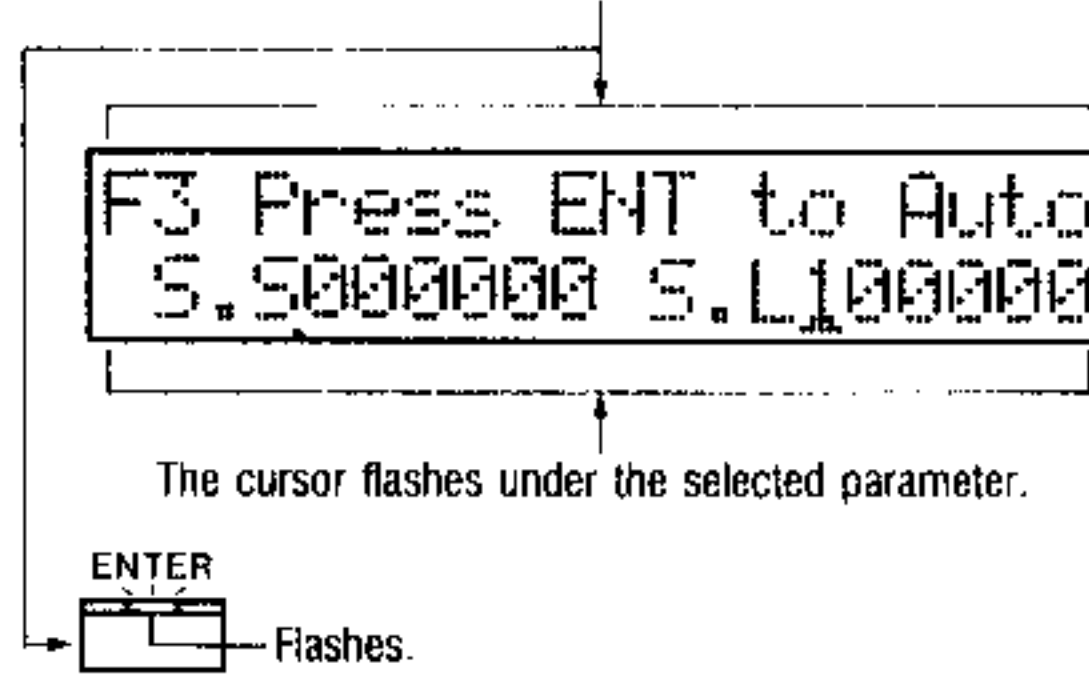

The cursor flashes under the selected parameter.

③ Use the DATA ENTRY A and B controls to truncate.

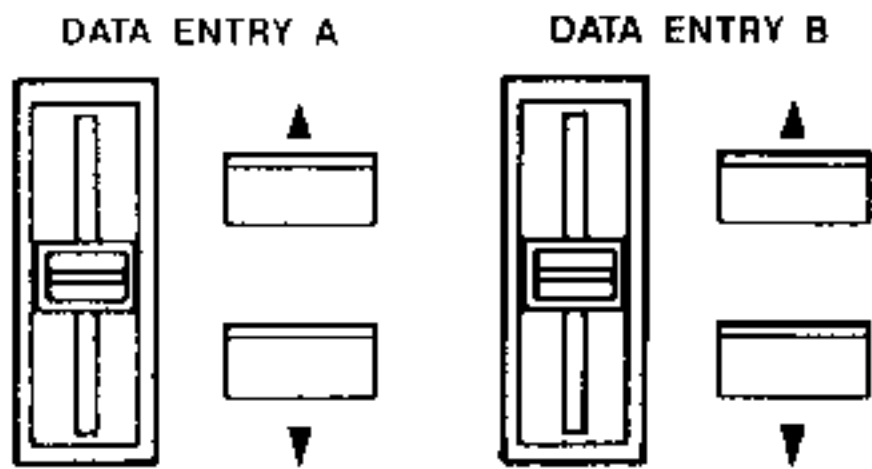

Use to truncate

● Change the sound start and/or length, as necessary. You can select automatic truncation.



Shows the current sound start and length.

4: Press the ENTER key for automatic truncation.



- The DSS-1 truncates the sample according to your settings. The display readout says "Searching" during this process. Afterward, the display shows the resulting start and length values of the automatic truncation.

```
F3 Searching...  
S.5000000 S.L090000
```



```
F3 Press ENT to Auto  
S.5000000 S.L089000
```

# F4 REVERSE SAMPLE

## [1] About the reverse sample function.

■ This reverses a waveform loaded into the edit work area. The effect is like a tape played backward.

**Note:**  
Reversing the sample defeats the F3 truncate sound start and length values. These are initialized back to their original values as existed immediately after getting the sound. (See F3 TRUNCATE START/LENGTH)

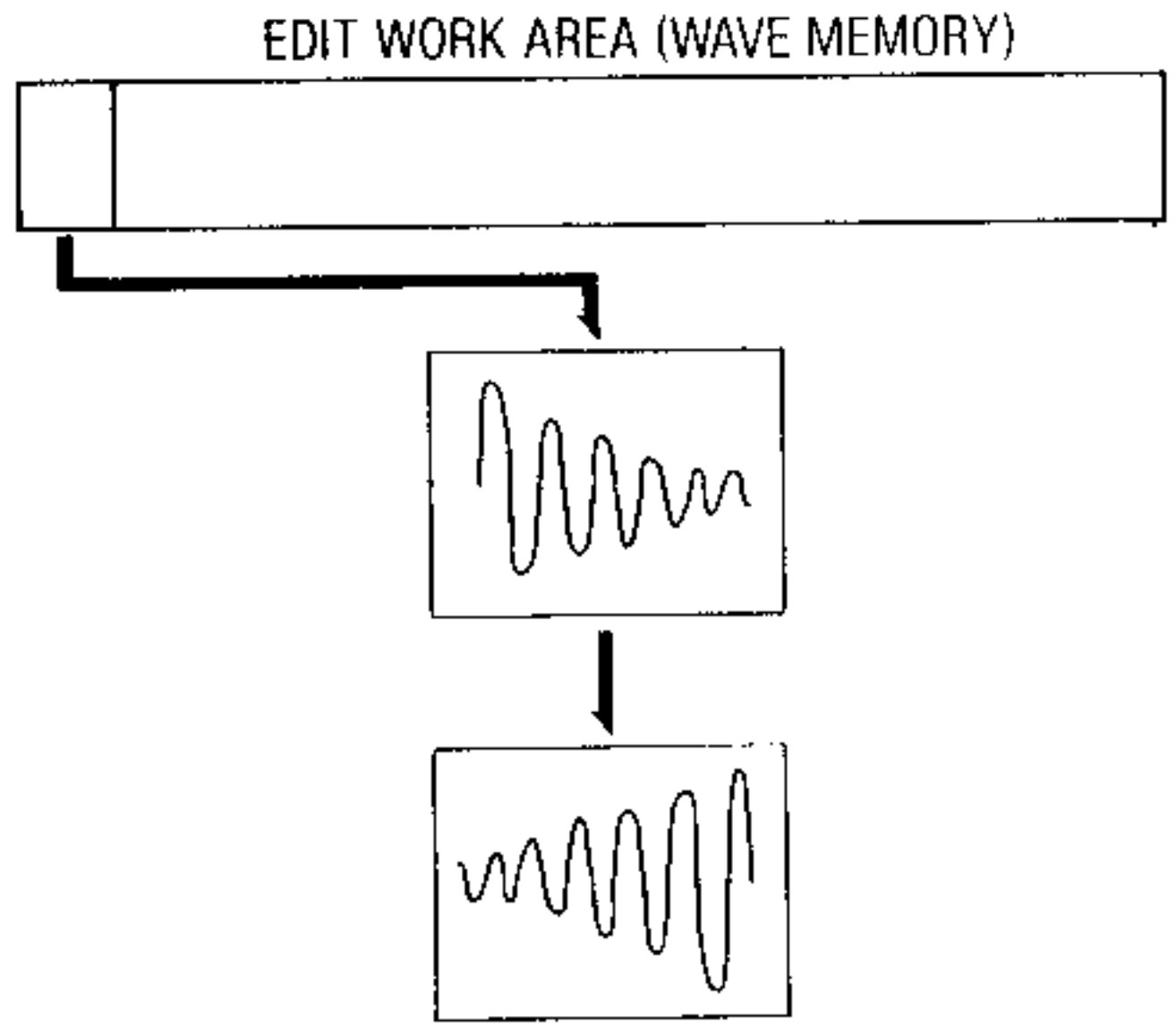

## [2] Using the reverse sample function

Operation	Operation of DSS-1
<p>① Go into the EDIT SAMPLE mode.</p>	<p>● Indicates EDIT SAMPLE mode.</p>  <p>The diagram shows a rectangular indicator light with the text "EDIT SAMPLE" above it and "On" to its right. The light is depicted as being illuminated.</p>



1. Press key 4 to select the reverse sample function.



- The display confirms your choice of function and prompts you to press the ENTER key to execute.

Shows the reverse sample function.

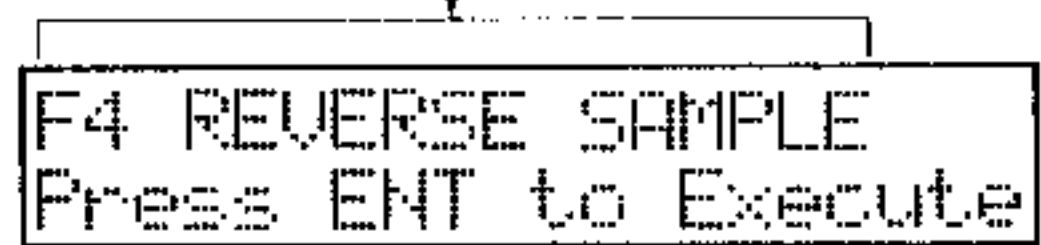

Flashes while waiting for you to press it.

2. Press the ENTER key to go ahead and reverse the sample.



- The display says it will take a while.

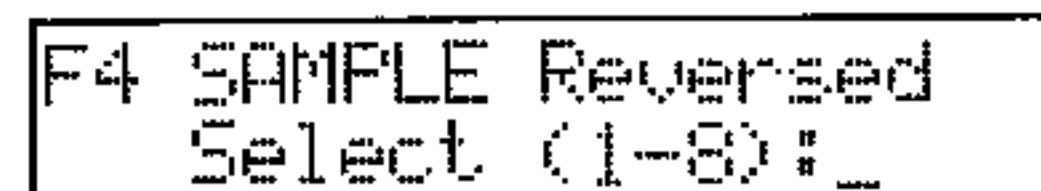
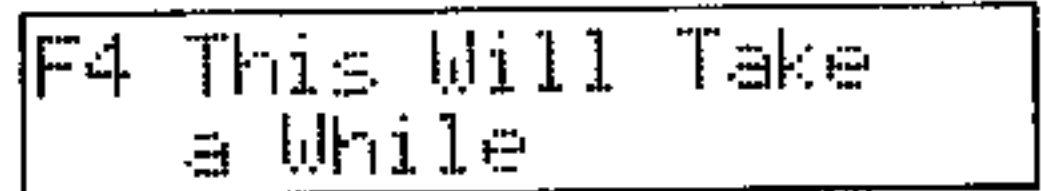

Then it confirms completion and prompts for function selection.

# F5 LINK SAMPLES

**1. Purpose of link samples function.**

■ This lets you take a sound that is in the edit work area (having loaded it in with F1) and link it to another sound from disk.

After linking, you can perform automatic level adjustment (auto level adjust) and cross fade linking (cross fade link).

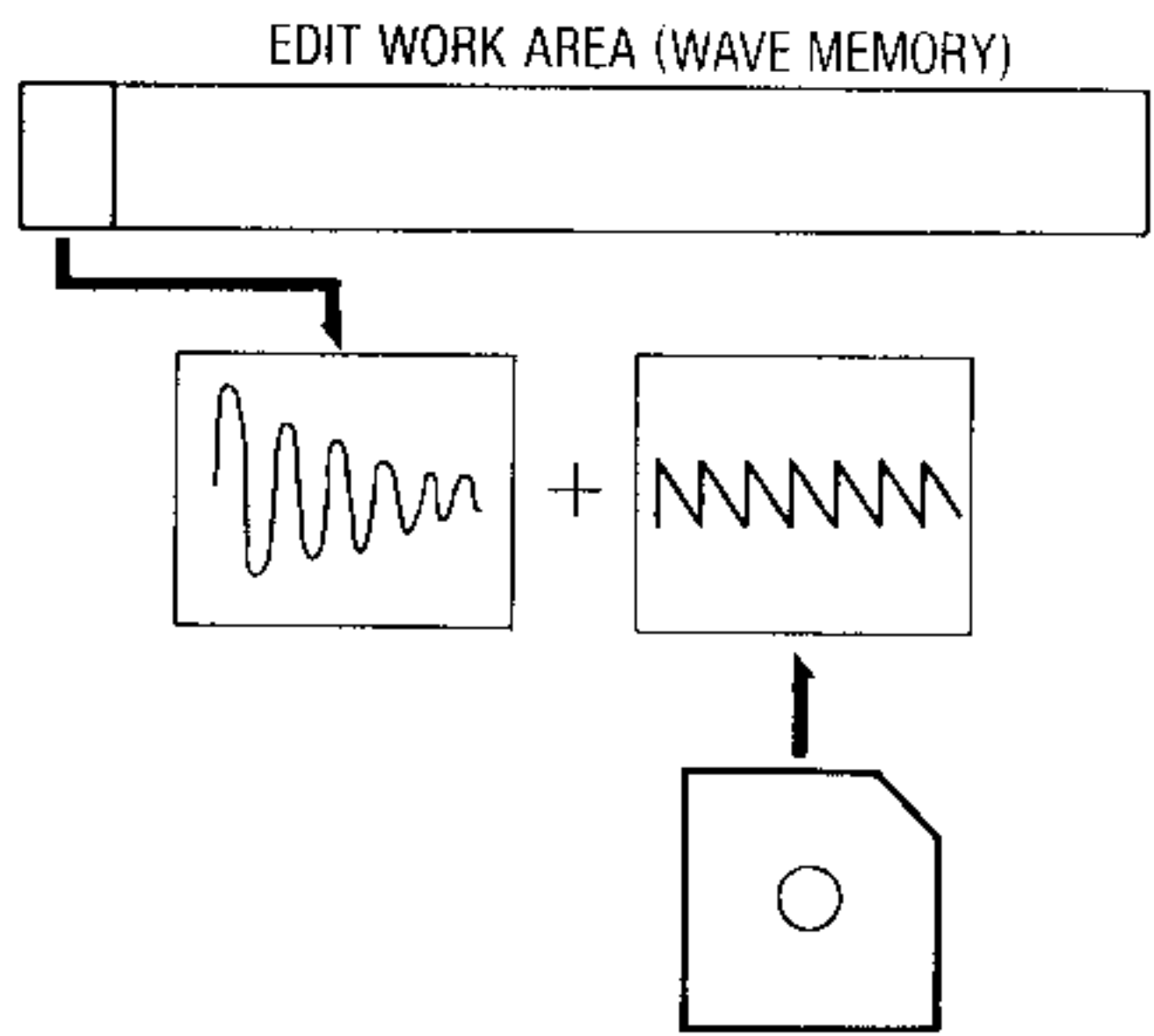

■ When the sound in the work area is truncated with F3, the link start point becomes as shown in the diagram. Remaining work area after the link start point is the maximum length of the sound that may be linked.

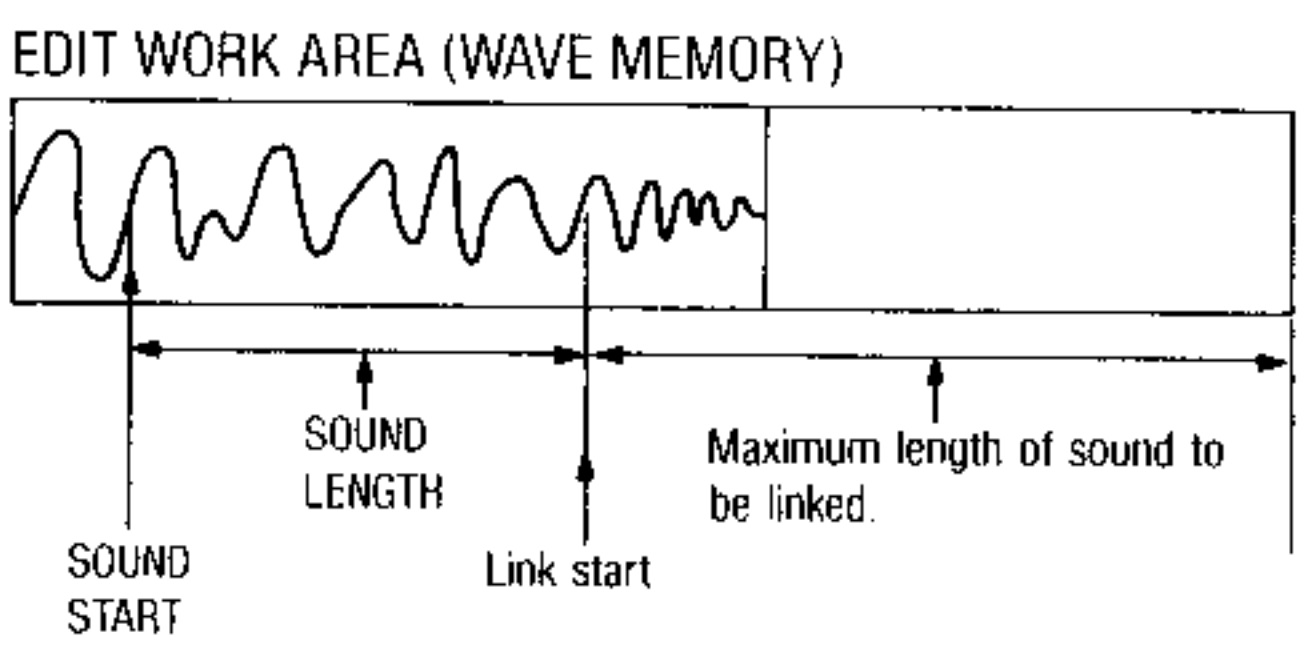

■ You can control the length of the sound (from disk) to be linked by setting the LOAD START ADDRESS.

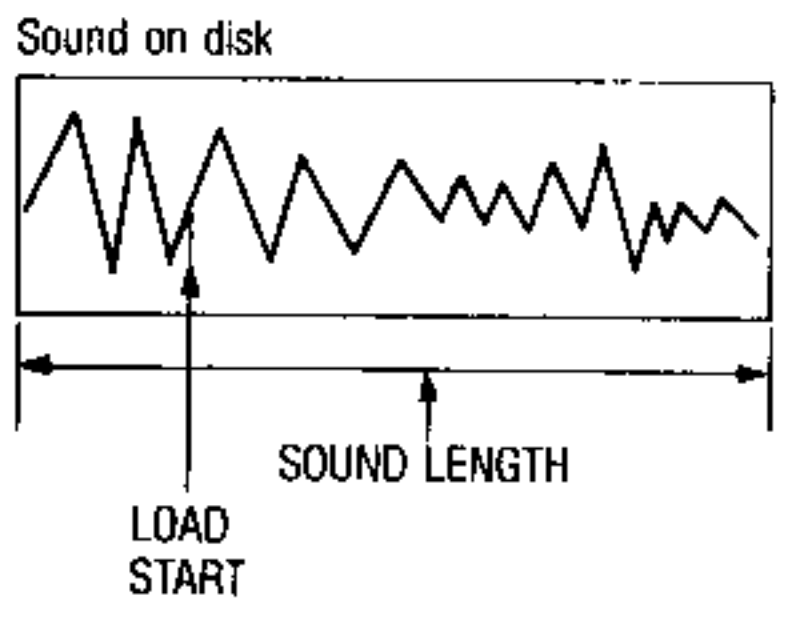

■ The "length to be linked" is the sound's length minus the LOAD START value. However, if this length exceeds the available area in wave memory ("the maximum length of the sound that may be linked"), then the sound is scaled to fit the available area.

■ **About the Auto Level Adjust capability.**

This provides smoother connection between the two linked waveforms by automatically finding the first point in the second waveform that has the same level as the end of the first waveform.

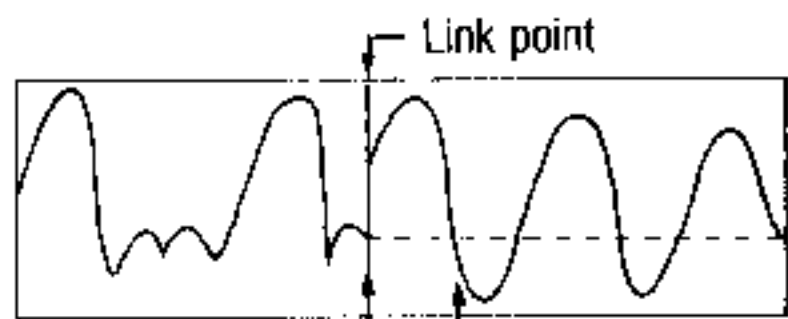

Here there is a point at the same level as the end of the first waveform.



**Auto level adjust is carried out.**

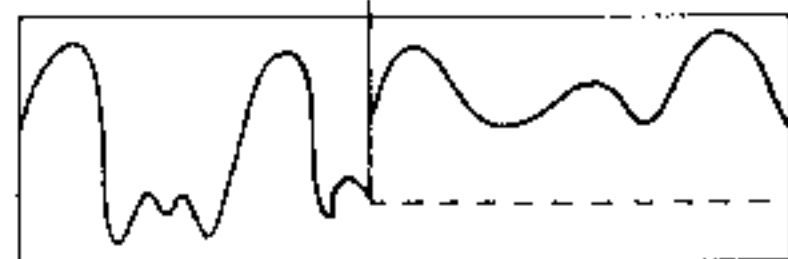
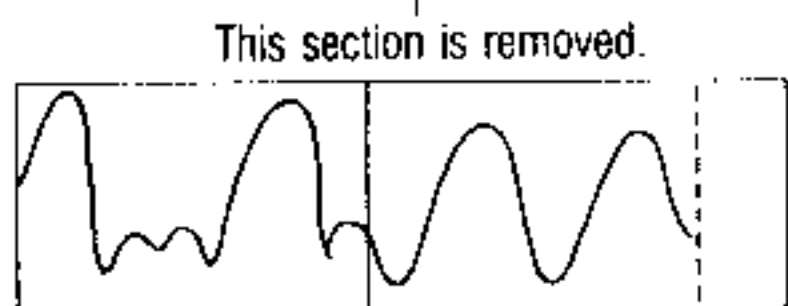

If no point can be found at the same level...

**Then auto level adjust is not possible.**

■ **About the Link Cross Fade capability.**

This provides a gradual change between the two linked sounds.

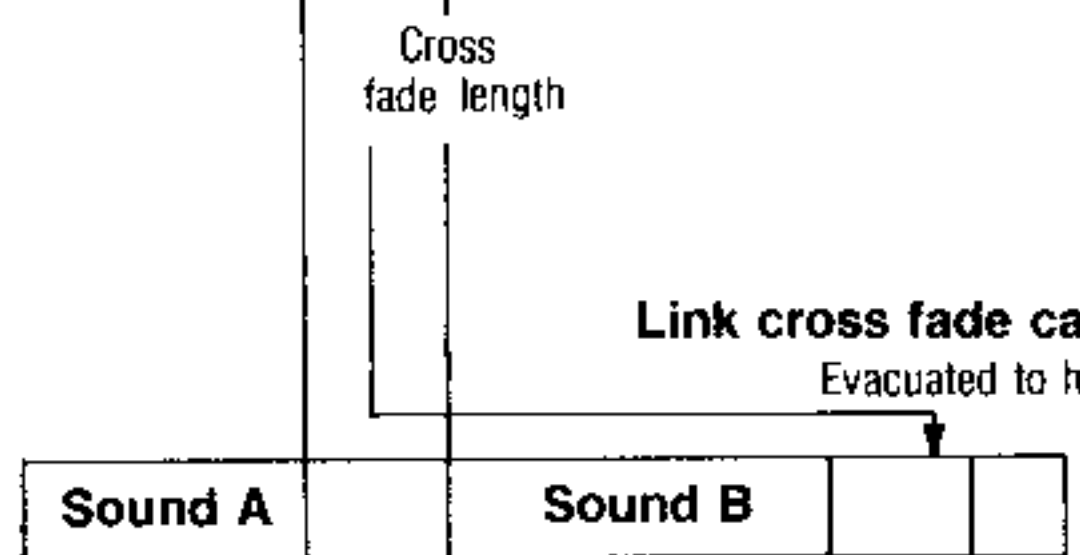
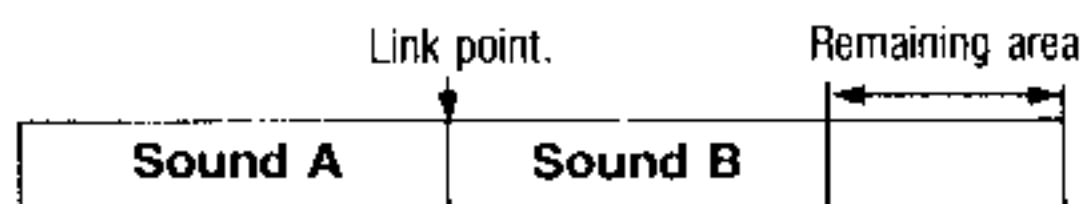

**Link cross fade carried out**  
Evacuated to here.

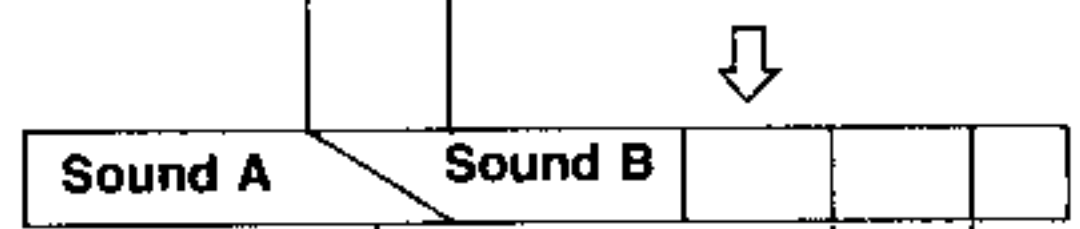





If link is redone, this is reinstated.

**Note:**

A link cross fade can not be carried out if the cross fade length is 000000. So, no cross fade is possible if there is no remaining space in the work area (wave memory).

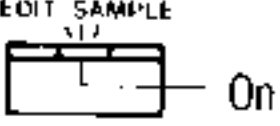
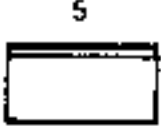
The cross fade length is set in multiples of 256 (256, 512, 768, etc.). therefore, a link cross fade is not possible if either the first sound (A) or the second sound (B) or the remaining area is shorter than 256.

2. Using the link sample function.

Operation	Operation of DSS-1
<p>① Select the EDIT SAMPLE mode.</p>	<ul style="list-style-type: none"> <li>● Indicates EDIT SAMPLE mode.</li> </ul>  <p>The diagram shows a rectangular indicator light with the text "EDIT SAMPLE" above it. A horizontal line extends from the right side of the light to the word "On".</p>
<p>② Press the number 5 key.</p> <p>Press  </p>	<ul style="list-style-type: none"> <li>● Display prompts to insert disk and press ENTER.</li> </ul> <p>Shows the link samples function.</p>  <p>The diagram shows a rectangular screen display with the text "F5 LINK SAMPLES" on the top line and "Insert Disk &amp; ENTER" on the bottom line. Arrows point from the text above and below to the screen.</p>  <p>The diagram shows a rectangular indicator light with the text "ENTER" above it. A horizontal line extends from the right side of the light to the text "Flashes while waiting for you to insert disk."</p>

② Take the disk that has the sample that you want to link and put the disk in the drive. Then press ENTER.

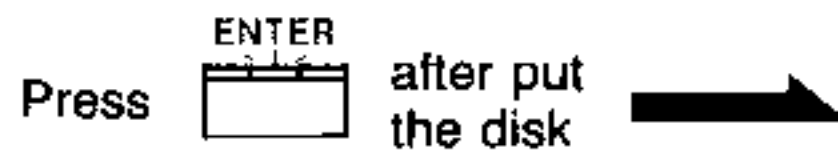

- The display says that it is searching for sounds on the disk. Then it tells you to use DATA ENTRY A to select, and press ENTER to execute.

```
F5 Searching for
SOUNDS on Disk
```



```
F5 Use DATA ENTRY A
Select&Press ENTER
```

③ Use DATA ENTRY A to select the sound that you want to link.

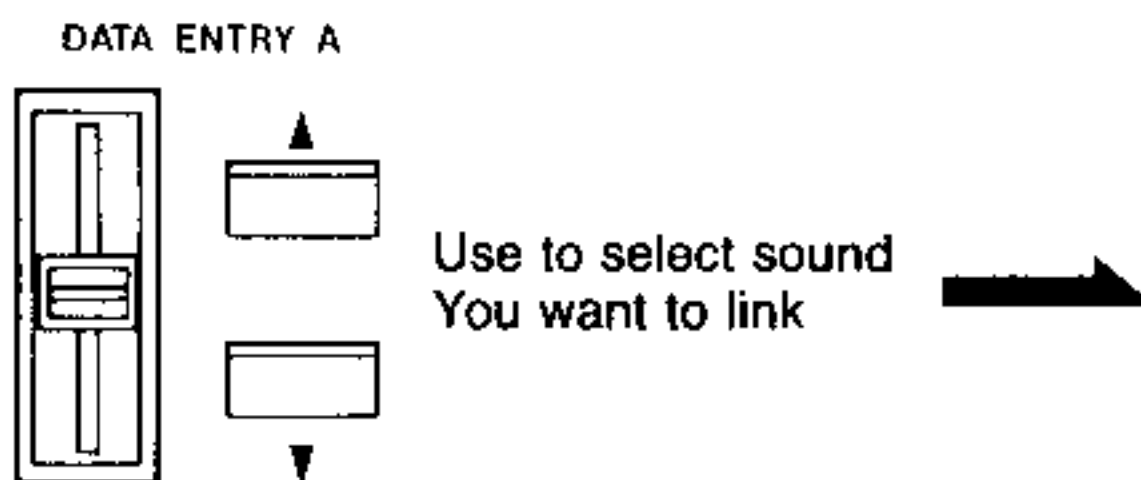

```
F5 Select SOUND
SOUND : TEST-#01
```

 Shows the currently selected sound.



④ After selecting the sound to link, press the ENTER key to finalize your choice.

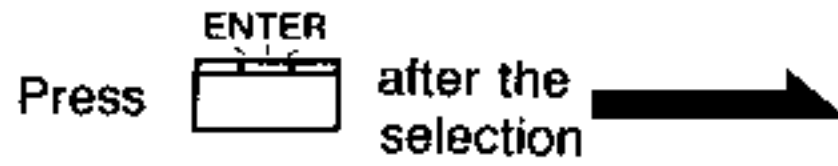

- The DSS-1 checks the length of the sound on the disk and shows its value after the name in the display. You can now adjust the LOAD START address which will be the starting address for linking. (See the link samples function.)

```
F5 Loading...
Please Wait a Minute
```

Shows the name of the sound and its length.

```
F5 TEST-#01=100000
LOAD START =000000
```

 Becomes the link start address.

⑤ Use DATA ENTRY A and B to set the address of the link start point.

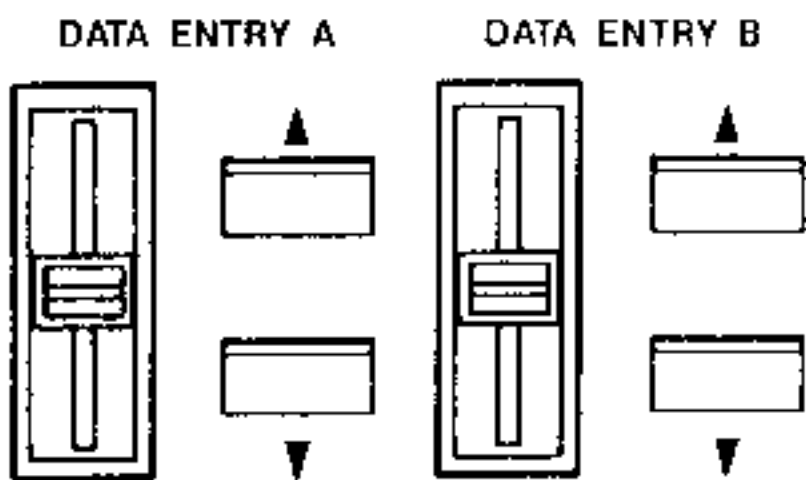

Use to select Start Address for linking 

```
F5 TEST-#01 =100000
LOAD START =020000
```

Shows the selected address.

6: Press ENTER to finalize your load start address



- The name link address, and sampling frequency of the sound to be linked are shown on the display. You are asked whether or not to execute the link.

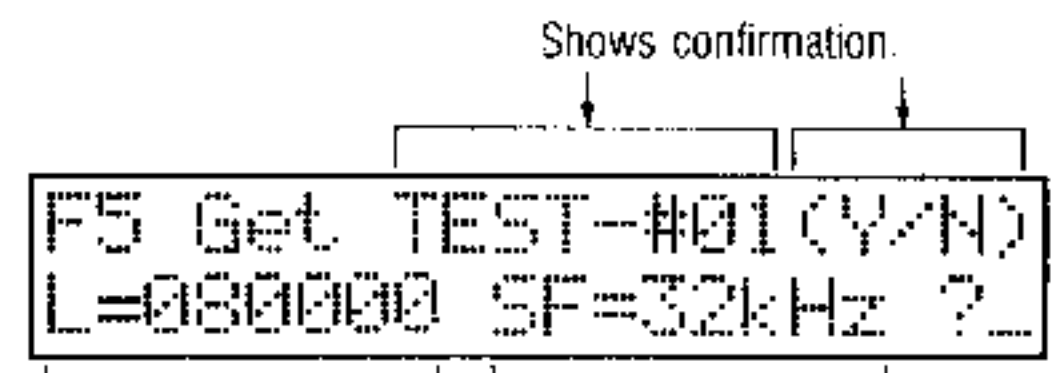

7: Press YES to go ahead and get the sound for linking.



- The sound to be linked is loaded from the specified address and linked.
- Afterwards, you are asked if you want to adjust the link.



★ If you decide not to load, press the NO key.



- This will abort the function and ask whether you wish to try to link again.

```
F5  Aborted
Retry to Link?(Y/N)_
```

⑧

★ If you wish to adjust the link, press the YES key.



- The adjustment is performed. After completion you are asked if you want to adjust again.

```
F5  This Will Take
    a While
```



```
F5  Completed
Adjust Again? (Y/N)_
```



★ Press NO if you don't want to adjust the link.



- You are then asked whether you want a cross fade or not.

```
F5 SAMPLES Linked
Cross Fade?(Y/N)_
```

⑨

★ Press YES if you want to adjust the link again.



- The display repeats the readouts from step ⑧ on.

★ If you don't want to adjust the link again, press NO.



- You are asked if you want a cross fade.

```
F5 Completed
Cross Fade?(Y/N)_
```

⑩:

★ Press YES if you want a cross fade.



★ Press NO if you do not want a cross fade.



● The display waits for you to specify a length.

```

F5 CROSS FADE LINK
FADE LENGTH = 000000
  
```

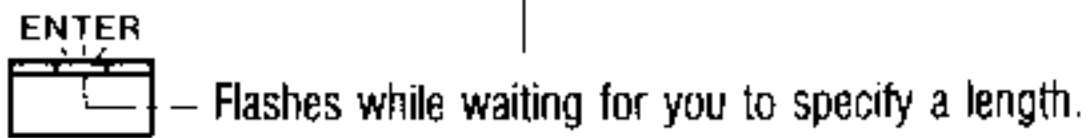

● This aborts the function and asks if you want to try to link again.

(Display says **Completed** if you answered yes in step ⑧.)

```

F5 Completed
Retry to Link?(Y/N)_
  
```

(Display says **SAMPLES Linked** if you answered no.)  
(To step ⑨)

```

F5 SAMPLES Linked
Retry to Link?(Y/N)_
  
```

① Use DATA ENTRY A to input the fade length.

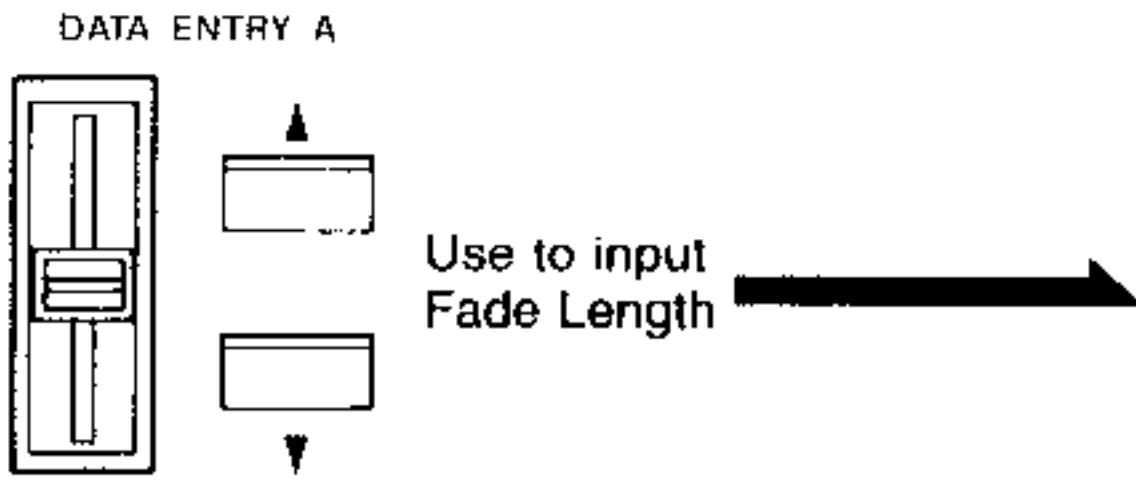

```
F5 CROSS FADE LINK
FADE LENGTH = 000256
```

↑  
Shows the input fade length.

② Press ENTER.



- After the cross fade is performed, the display asks if you want to try to link again.

```
F5 This Will Take
a While
```



```
F5 X-FADE Completed
Retry to Link?(Y/N)
```

③ Press the YES key to link again.



- The disk search will be performed again as in step ②. Continue from step ③ to link other sounds.

★ Press NO if you do not want to link again.



- This exits the link sample function and lets you choose another function or change modes.

(If you press NO in step 7, then the display says Aborted.)

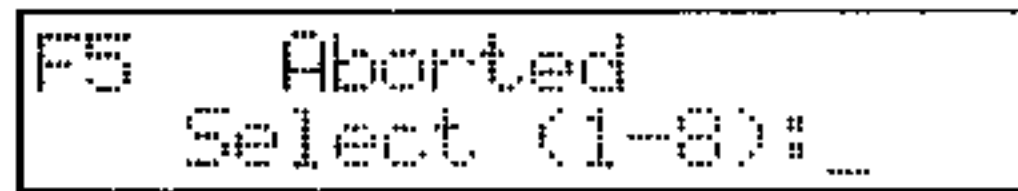

Shows you can select a function.

(If you performed the cross fade, the display says X-FADE Completed.)

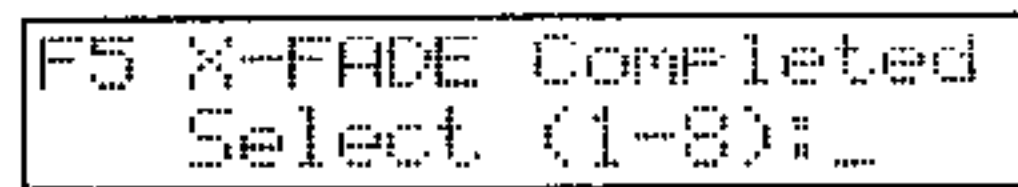

Shows you can select a function.

(If you pressed YES in step 8, the display says completed.)

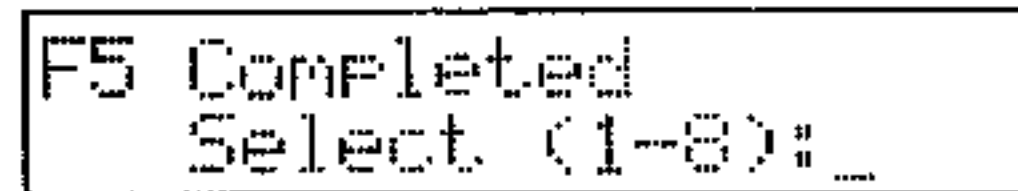

Shows you can select a function.

(If you pressed NO in step 8, the display says SAMPLES Linked.)

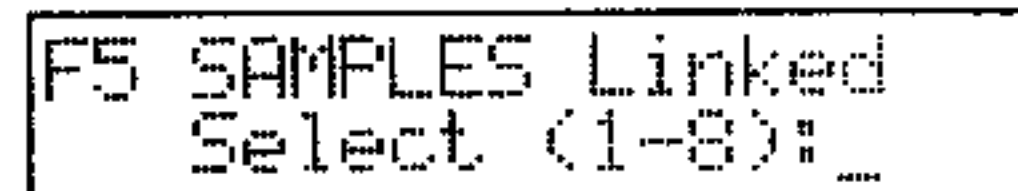

Shows you can select a function.

## F6 MIX SAMPLES

### 1! About the mix samples function

- This function is used to mix a sound that has been loaded (by using F1) into the edit work area together with a sound from disk.

- Before actually mixing the sounds, you can simulate a mix and monitor the effect while adjusting the volume and pitch of the sounds. When F2 AUTO REPEAT is on, then the repeat is matched to the longer of the two sounds.

- Each of the sounds to be mixed can be no longer than 131,071. If a sound is longer than that, then it can not be mixed.

- Sounds loaded for mixing have their sound start and length values cancelled (so the F3 settings are not effective). If the sound in the work area is too long to be mixed, shorten it and save it back to disk before using it. (See F8 SAVE/RENAME SAMPLE).

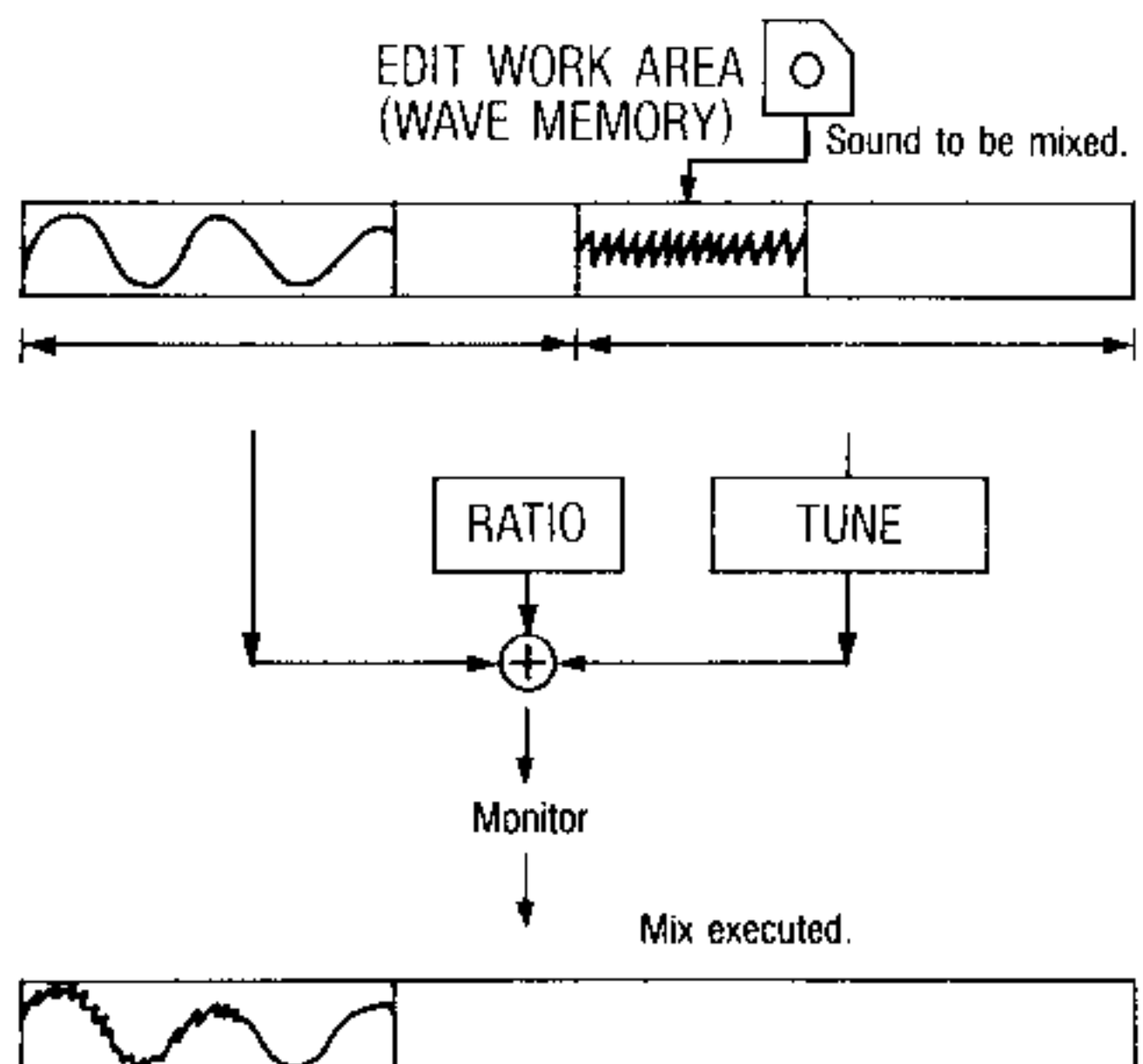
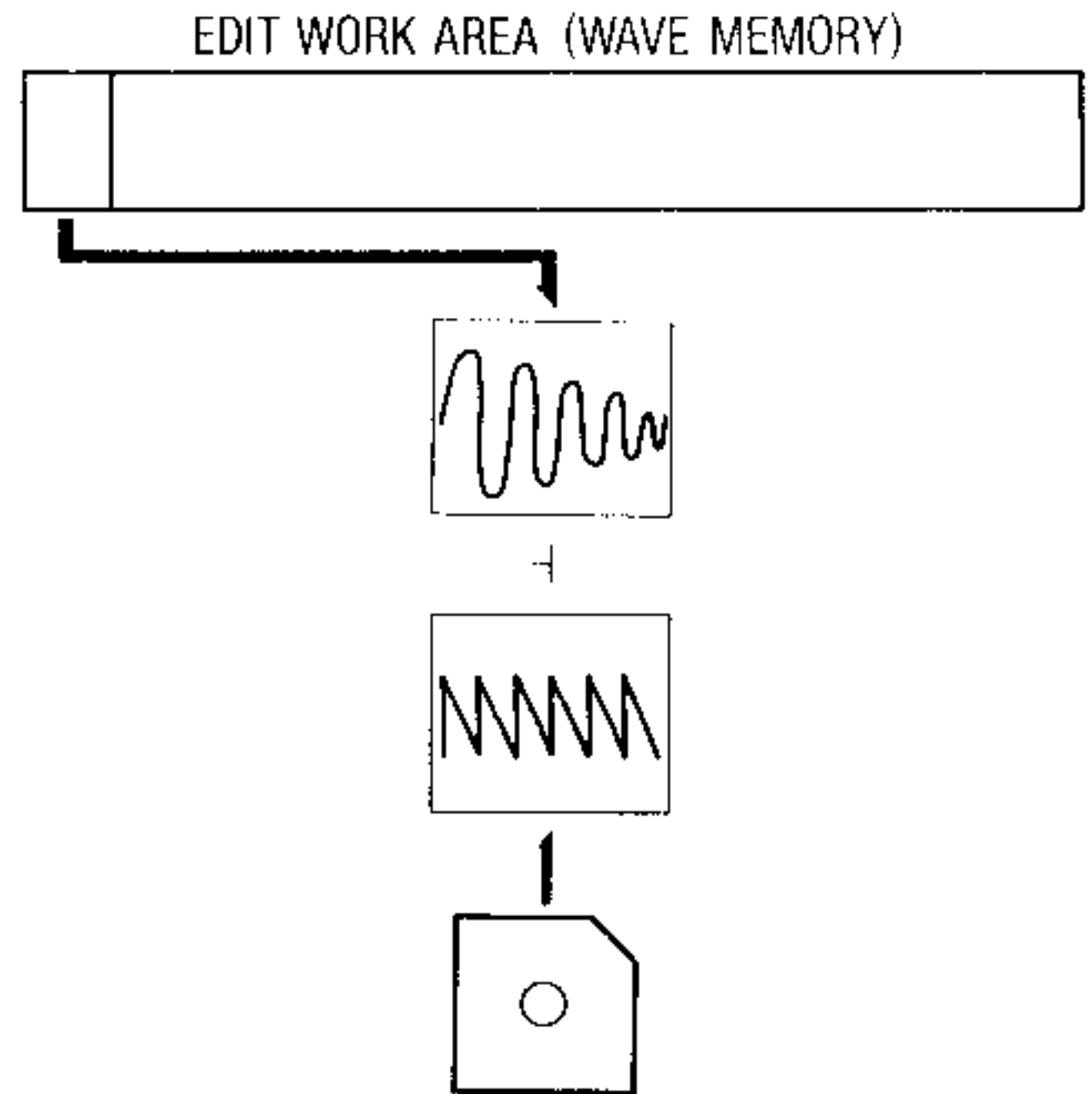

- Sounds may be used with AUTO REPEAT turned off. If the sound being mixed is sufficiently long, then TUNE affects it as shown in the diagram.

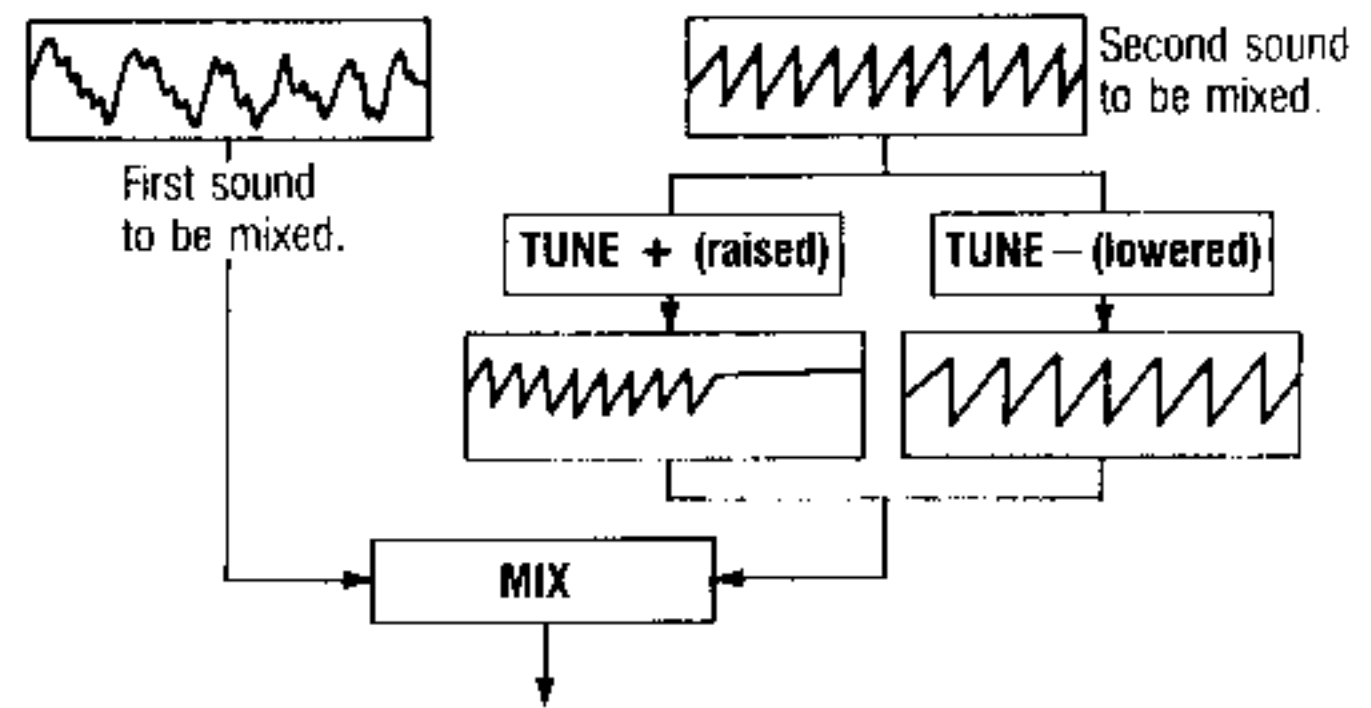

- If the sounds being mixed are single full wave cycles, then the waveform mixed is affected by TUNE as shown in the diagram.

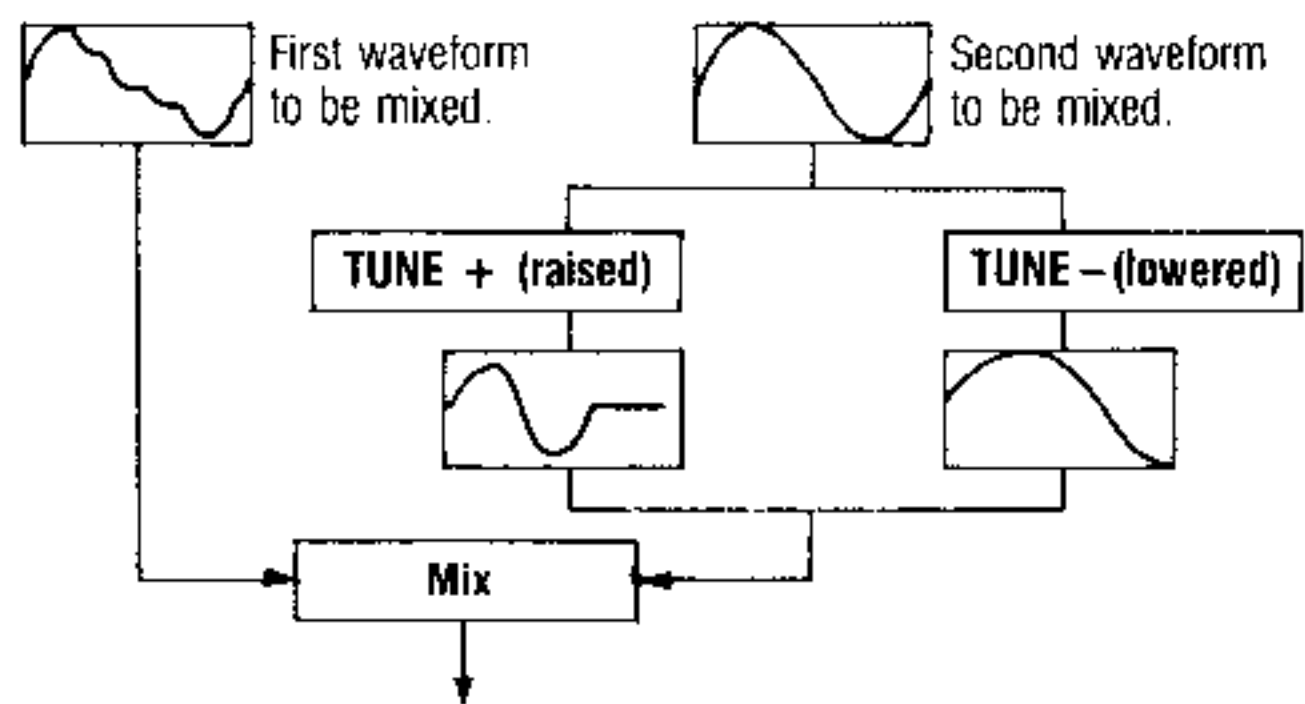



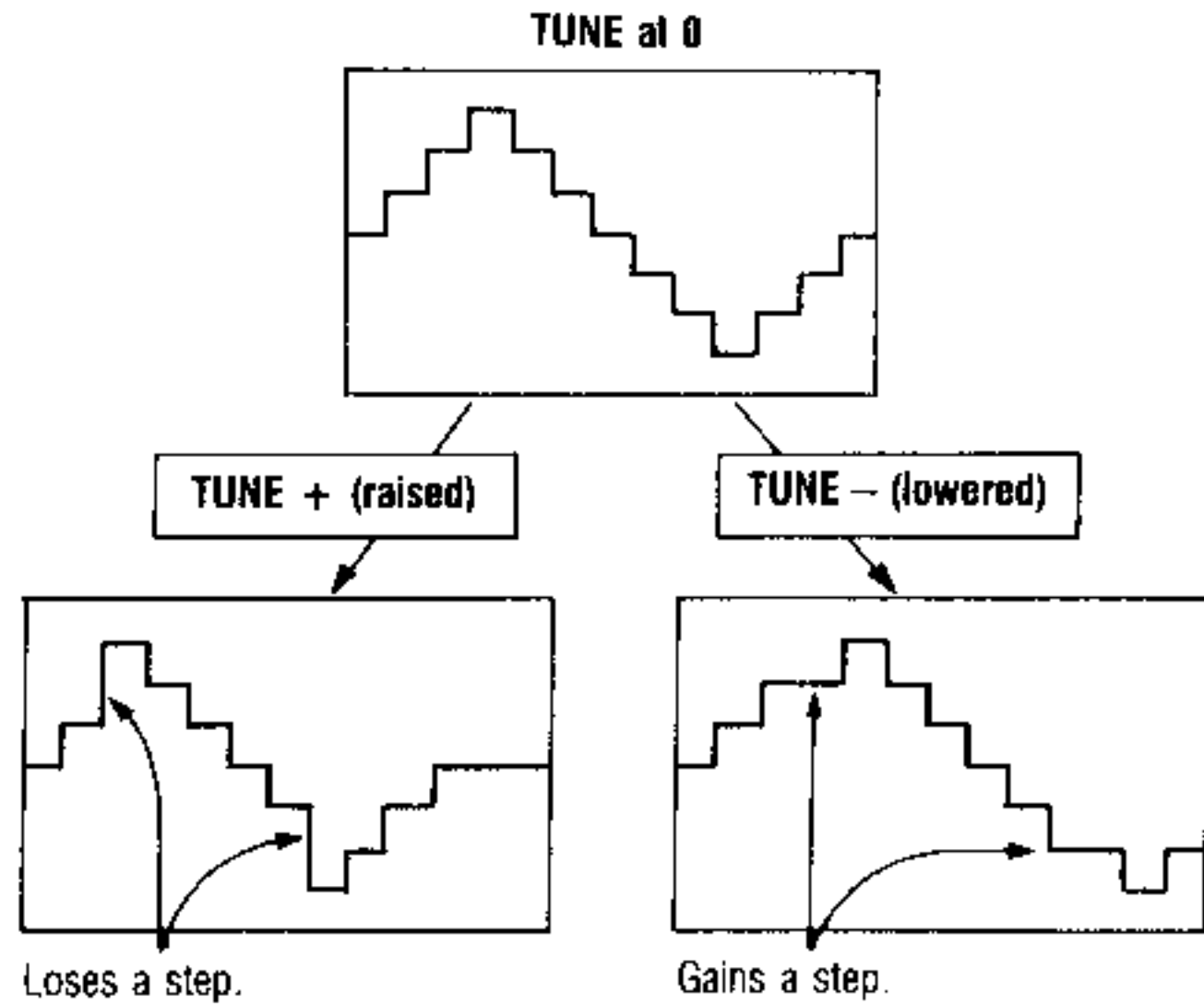

Therefore, when AUTO REPEAT is on for single full waves, and TUNE is at a value other than 0. Then the pitch will not change but the timbre will change as a result of the mix. Setting TUNE to 0 is therefore safer in this situation. (Otherwise, the monitored trial mix sounds different from the executed mix.)

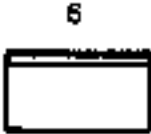

- The waveform of the sound taken from disk is affected by the TUNE value when mixed, as shown in the diagram here. This may cause the actual results of the mix to sound rougher than the trial monitor mix.



2 Using the mix samples function

Operation	Operation of DSS-1
<p>① Confirm that the EDIT SAMPLE mode is selected.</p>	<ul style="list-style-type: none"> <li>● Indicates EDIT SAMPLE mode.</li> </ul> 
<p>② Press key number 6.</p> <p>Press  </p>	<ul style="list-style-type: none"> <li>● The display prompts you to insert the disk and press ENTER.</li> </ul> <p>Shows the mix samples function.</p>   <p>Flashes while waiting for you to insert disk.</p>

② Take the disk that has the sample that you want to mix and put the disk into the drive. Then press ENTER.

Press  after putting in the disk 

- The display will confirm that it is searching for sounds on the disk.

F6 Searching for  
SOUNDS on Disk



F6 Use DATA ENTRY A  
Select&Press ENTER

Shows waiting for selection of sound.

③ Use DATA ENTRY A to select the sound to be mixed.

DATA ENTRY A



Use to select the sound to  be mixed

- Then it will tell you to use DATA ENTRY A to select, and ENTER to finalize.

F6 Select SOUND  
SOUND : TEST-#01

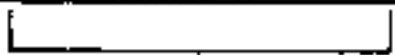
  
Shows the select sound name.

ENTER  Flashes while selecting sound.



4. Press ENTER to finalize your choice.

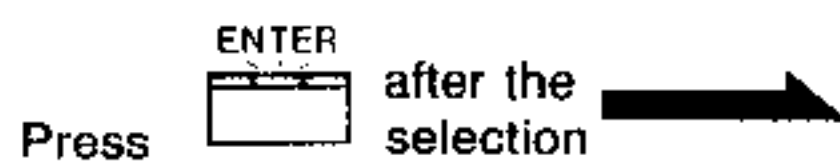

- The DSS-1 reads the length and sampling frequency of the sound (on the disk) to be mixed and displays this data with the name of the sound. You are asked whether you/wish to get this sound to the work area or not.

```
F6 Loading...
Please wait a Minute
```

Shows confirmation.

```
F6 Get TEST-#01(Y/N)
L=100000 SF=32kHz ?
```

the sound's length

the sound's sampling frequency

5. Press the YES or NO key to replay.



- After loading, the DSS-1 enters the "second sample condition" and stands by for you to set the mixing ratio (RATIO) and tuning (TUNE) values. The effect of the mix is simulated during this process.

Initial display for second sample condition.

```
F6 Loading...
Please wait a Minute
```

```
2nd SAMPLE CONDITION
RATIO=_50% TUNE= 00
```

ENTER

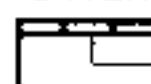

Flashes while waiting for you to input.

★ Press NO if you want to abort.



- This returns you to step 10 where you can select another function or change modes.

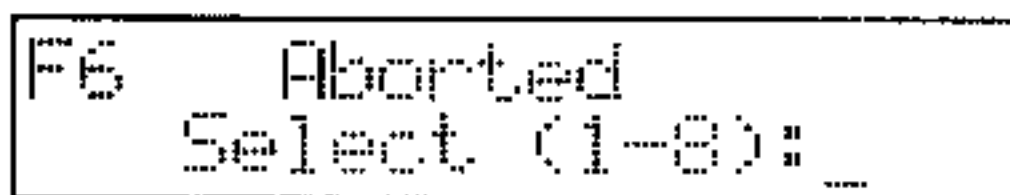

Shows you can select a function.

⑥ Use the cursor keys to move to the sample condition that you wish to adjust.

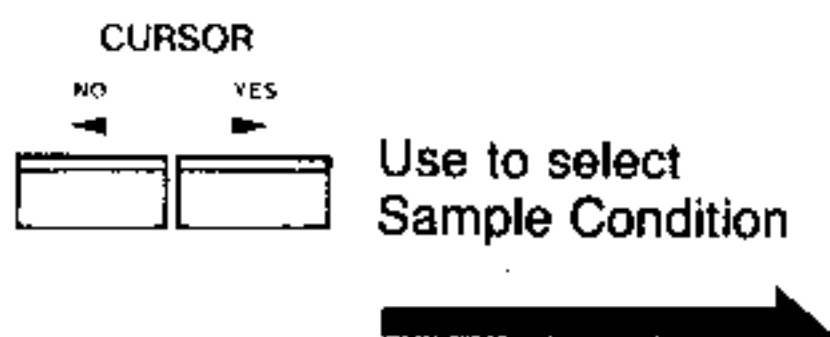

- The cursor flashes under the selected item.



The cursor flashes.

( Possible RATIO values: 00% ~ 100% )  
( Possible TUNE values: -31 ~ +31 )

7 Play the keyboard and monitor the sound while using the DATA ENTRY A controls to adjust the value of the selected parameter.

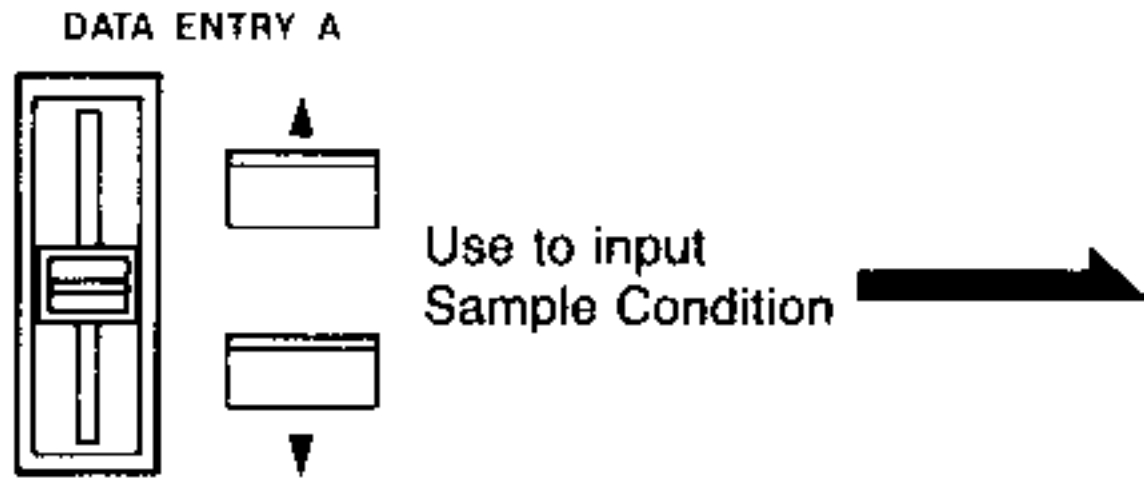

```
2nd SAMPLE CONDITION
RATIO= 50% TUNE=+01
```

Shows currently input sound condition.

8 After adjusting RATIO and TUNE, press the ENTER key to execute the mix.



- You can now hear the result of the executed mix.
- The display will confirm that samples have been mixed. You can select another function or change modes.

```
F6 This Will Take
a While
```



```
F6 Samples Mixed
Select (1-8): _
```

★ To escape without going through with the mix, press the DEL/CANCEL key.



- This cancels the mix function.
- You can now select another function or change modes.

Says that mix was cancelled.

```
F6 MIX Canceled
Select (1-8): _
```

Shows you can select a function.

# F7 VIEW/EDIT SAMPLE DATA

## 1 About the view/edit sample data function

- After getting a sound into the edit work area using F1, this function lets you select each address and adjust the data value as you like.
- You are not limited in your selection of addresses by the sound start/length settings edited in F3.

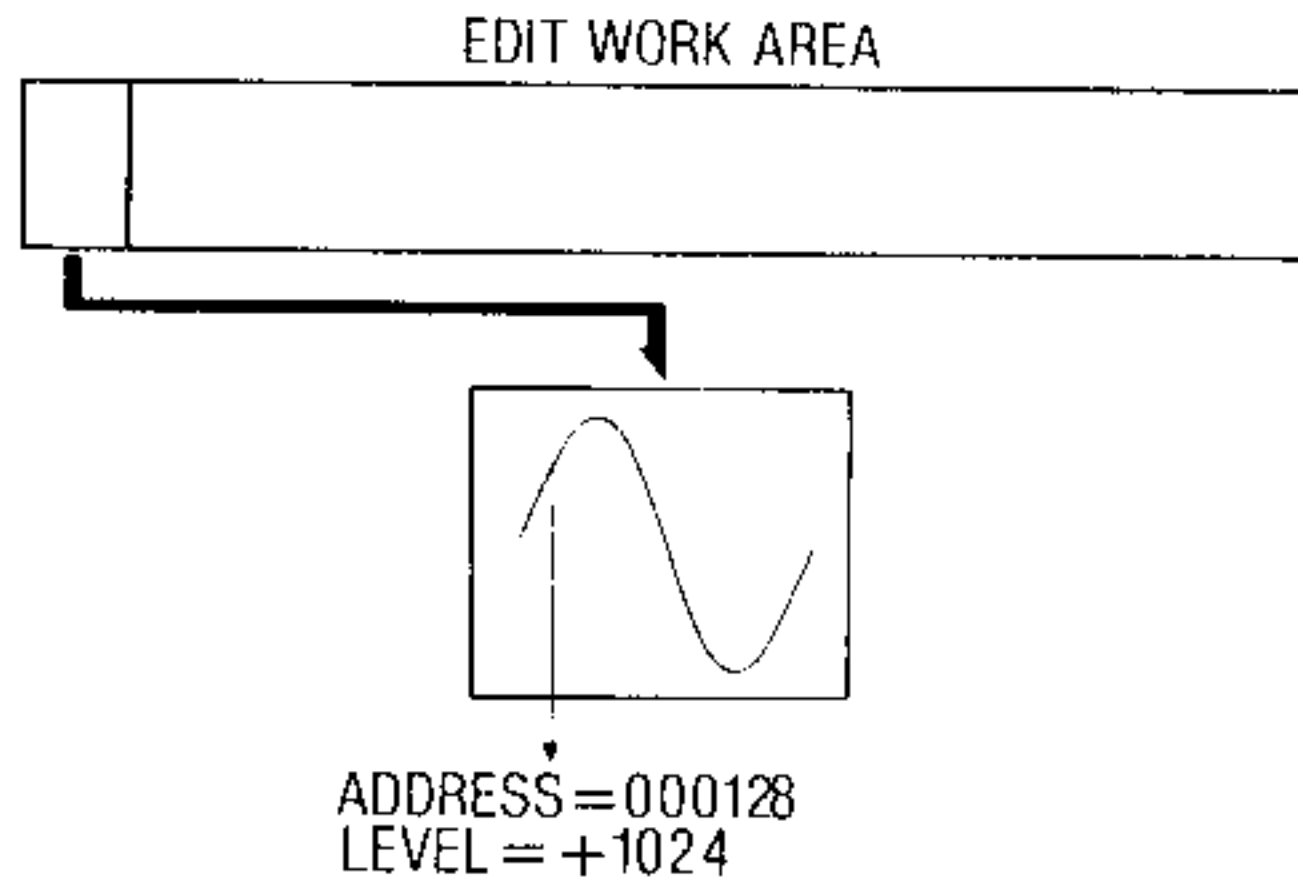

## 3 Using the view/edit data function

Operation	Operation of DSS-1
<p>① Select the EDIT SAMPLE mode.</p>	<ul style="list-style-type: none"> <li>● Indicates EDIT SAMPLE mode.</li> </ul> 
<p>② Press key number 7.</p> <p style="text-align: center;">Press <span style="border: 1px solid black; padding: 2px 5px;">7</span> </p>	<ul style="list-style-type: none"> <li>● The display shows the address and data value.</li> </ul> <p style="text-align: center;">Shows the view/edit sample data.</p> <div style="border: 1px solid black; padding: 5px; text-align: center;"> <p>F7 VIEW&amp;EDIT S.DATA AD=000000 DATA=+0001</p> </div> <p style="text-align: center;">Shows the address.      Shows the data value.</p>

2 Use DATA ENTRY A or B to select the address.

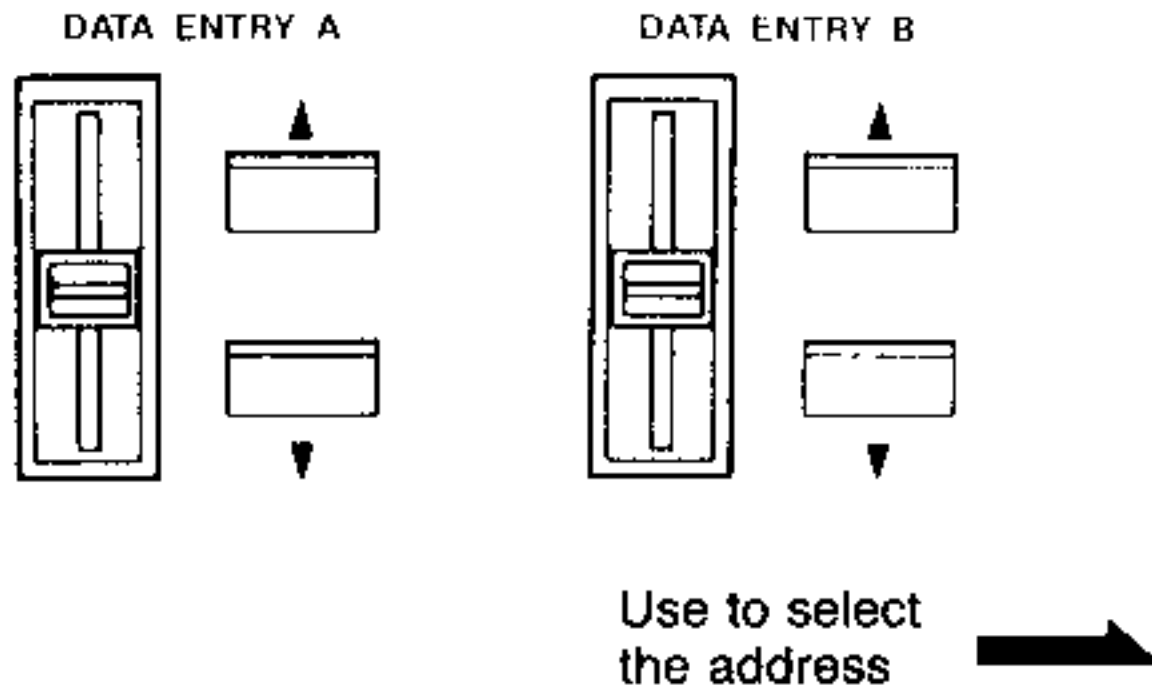

● Shows the data value of selected address.

```
F7 VIEW&EDIT S.DATA
AD=021900 DATA=-0111
```

Shows the selected address. Shows the data value of selected address.

3 Press the YES cursor key to move the cursor to the data value in the display.



● The cursor moves to the data value in the display.

```
F7 VIEW&EDIT S.DATA
AD=021900 DATA=-0111
```

The cursor flashes.

④ Use DATA ENTRY A or B to adjust the data value.

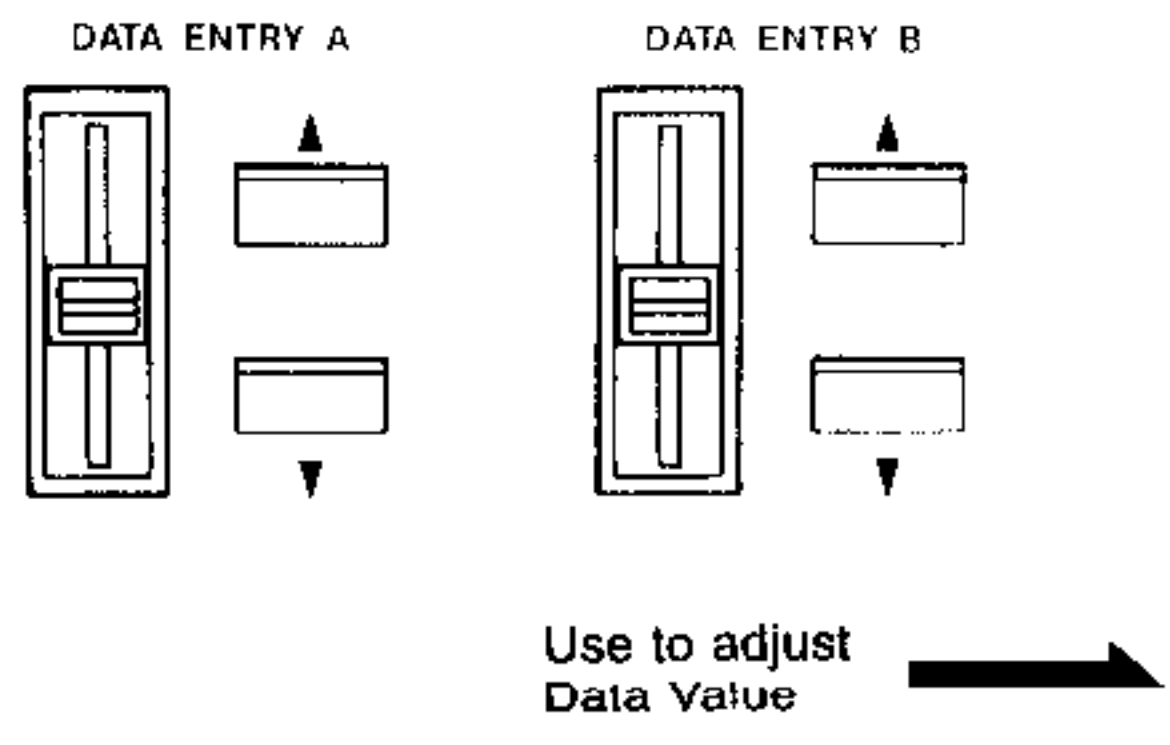

```
F7 VIEW&EDIT S.DATA  
AD=021900 DATA=+1099
```

↓  
The data value changes.

⑤ Now you can use the NO cursor to move back to the address side of the display and change to another address.

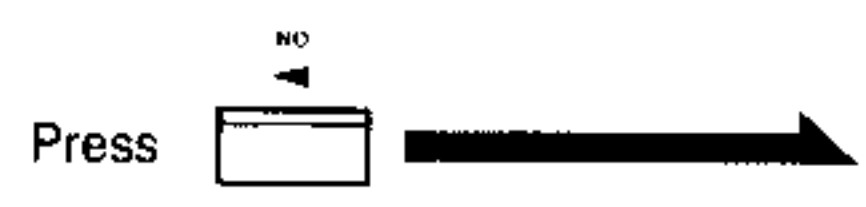

● Continue in this fashion.

```
F7 VIEW&EDIT S.DATA  
AD=021900 DATA=+1099
```

↑  
The cursor flashes.

● The cursor moves back to the address side of the display.



## F8 SAVE/RENAME SAMPLE

### 1. About the save/rename sample function

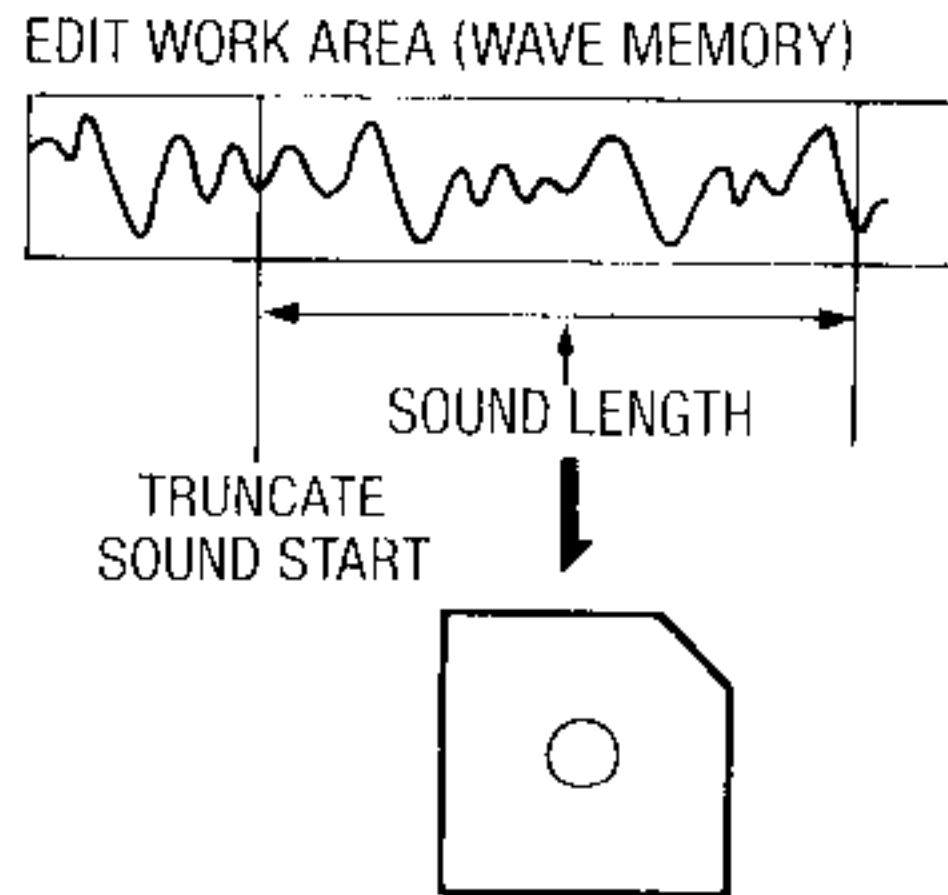
- Lets you give a name to sound in the work area and save to disk.
- The sound data saved to disk is the data within the area set by the F3 function.
- Using F1 and F8, it is possible to retrieve individual sounds from a completed multisound.
- If you press YES in step (5), then the DSS-1 first checks the disk directory to see if the name that you entered already exists. If it finds a sound of the same name, then it asks you whether it is okay to delete that sound or not. Refer to F5 SAVE SAMPLE (in the sample mode) for details on this procedure.



### 2. Using the save/rename sample function

Operation	Operation of DSS-1
<p>① Select the EDIT SAMPLE mode.</p>	<ul style="list-style-type: none"> <li>● Indicates EDIT SAMPLE mode.</li> </ul> 
<p>① Press the number 8 key.</p> <p style="text-align: center;">Press <span style="border: 1px solid black; padding: 2px 5px; display: inline-block; width: 20px; height: 15px; text-align: center; vertical-align: middle;">8</span> </p>	<ul style="list-style-type: none"> <li>● The display shows default sample name and asks if you want to rename.</li> </ul> <p style="text-align: center;">Shows the save/rename function.</p> <div style="text-align: center; margin-bottom: 5px;">Shows default name.</div> 

2) Press YES if you want to rename.



• The display waits for you to input a name.

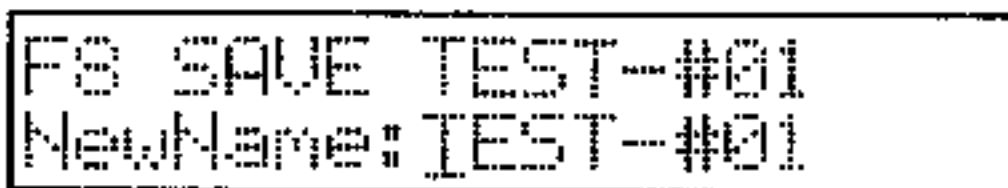

Shows waiting for input of a name.

ENTER

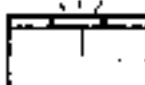

Flashes while waiting for you to save.

★ Press NO if you do not want to rename.



• This will take you to the display in step 4. The display will show the sample name and length and ask whether to save or not.

Shows the sample name and length.

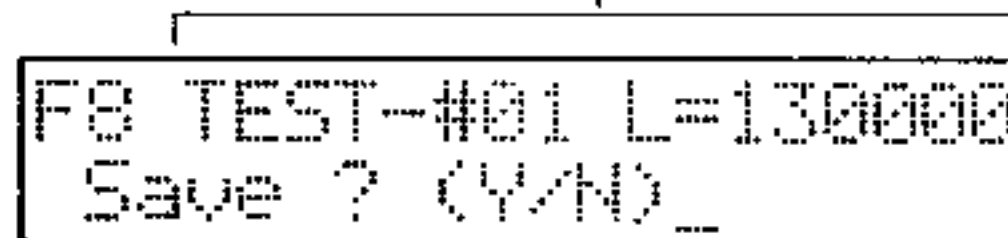



3. Use DATA ENTRY A to input a name.

DATA ENTRY A

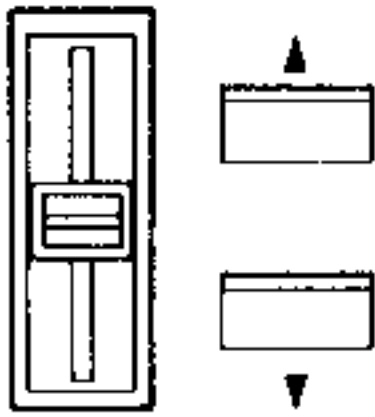

Use to input a new name

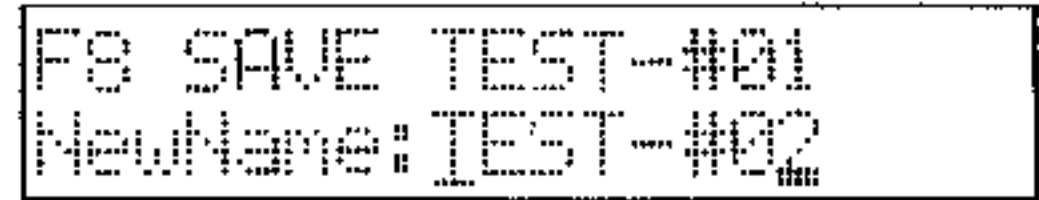

Shows the input name.

ENTER

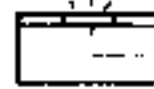

Flashes while waiting for you to save.

4. Press ENTER.

Press



• The display shows the sample and length. It asks if you want to save.

Shows the sample name and length.

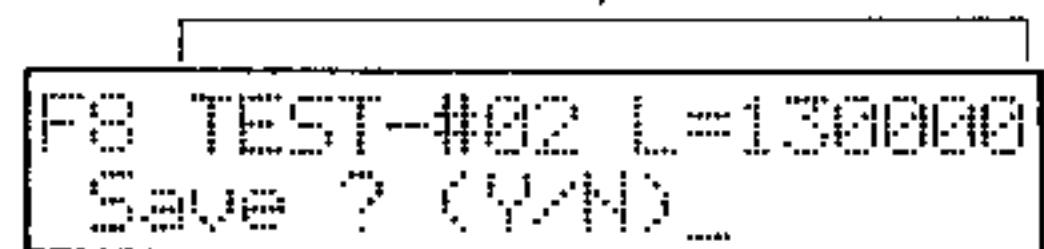

Shows confirmation.

5 Press YES to save.



- The data is saved to disk. You can now select another function or change modes.

```
F8 Saving...  
Please Wait a Minute
```



```
F8 Saving Completed  
Select (1-8):_
```

Shows you can select function.

★ Press NO if you want to abort.



- This returns to step 0 where you can select another function or change modes.

```
F8 Aborted  
Select (1-8):_
```

Shows you can select function.

■ If you press YES in step 5, then the DSS-1 first checks the disk directory to see if the name that you entered already exists. If it finds a sound of the same name, then it asks you whether it is okay to delete that sound or not. Refer to F5 SAVE SAMPLE (in the sample mode) for details on this procedure.

# MULTISOUND MODE

## 1. About Each of the Functions \_\_\_\_\_

### FO GET SOUNDS

#### 1 About the get sounds function



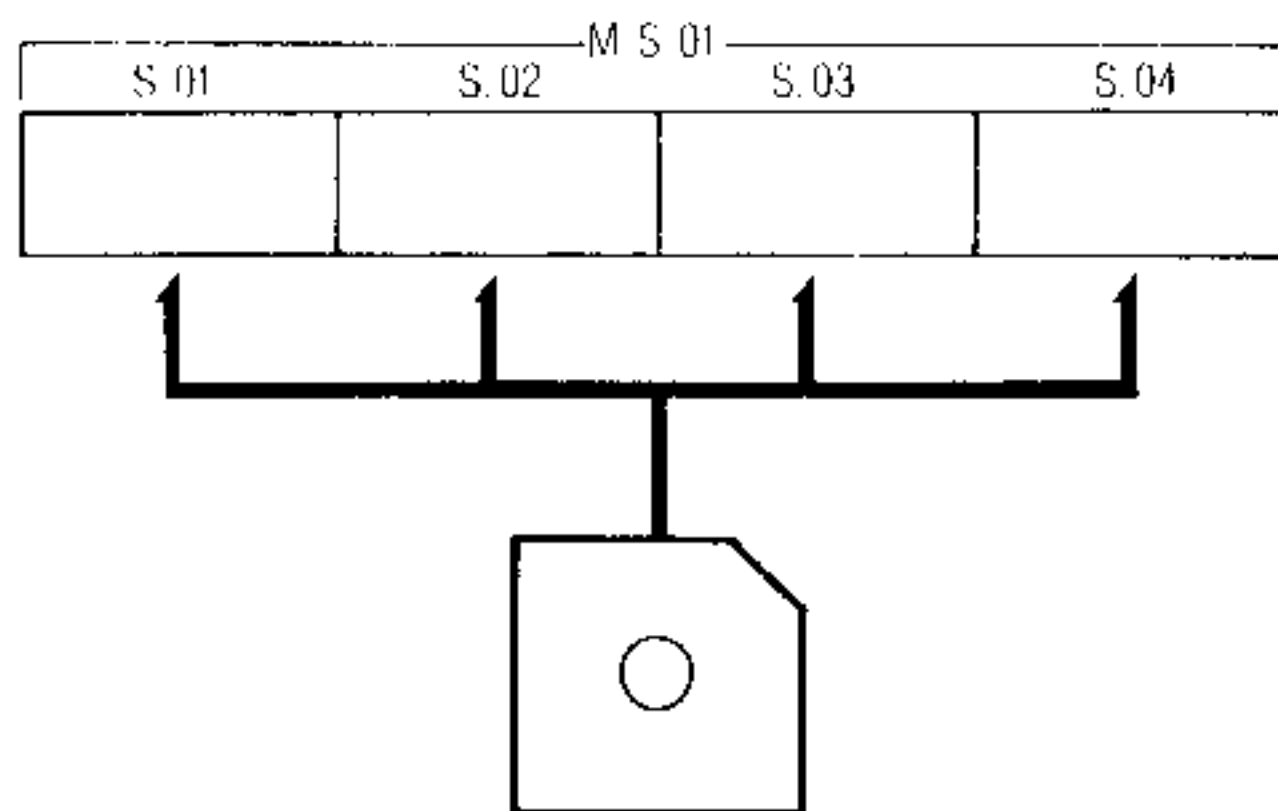



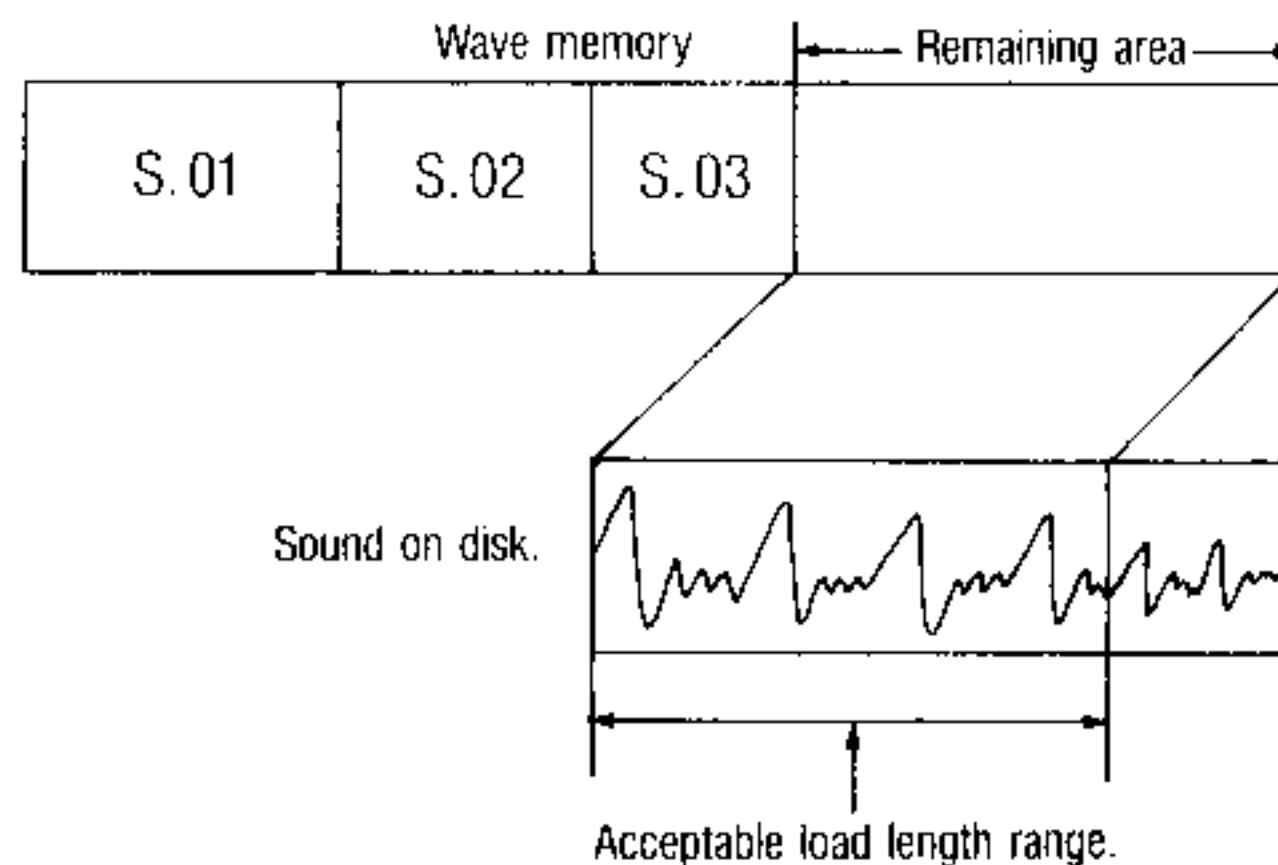

- This is used to get sounds from disk to wave memory and assign them to the keyboard (starting at the lower part of the keyboard with sound number 01 and working up) to create a multisound.
- Before getting any sounds, you are asked if you want the loop on or off. If the sounds that you will get are single full wave cycles, then please answer YES to turn the loop on.
- Sound assignments must start with the lowest range of the keyboard that you will use. You cannot later change the order of the assigned sounds.
- Wave memory is used as the work area for creating multisounds. The completed multisound appears as MULTI SOUND No. 1 in the "system" resident in the DSS-1.  
(Multisounds previously present in the DSS-1 resident system are all lost.)
- The GET SOUND function is cancelled if the number of sounds in the multisound under construction exceeds 16, or if the sum of the sound lengths comes to equal the size of wave memory (262,886).
- You can control the length of the sound loaded from disk by setting its LOAD LENGTH.

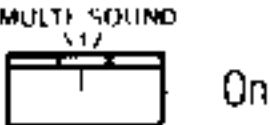

Example: Trying to get sound number 04 after getting sound number 03.

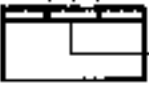

## 2 Using the get sounds function

Operation	Operation of DSS-1
<p>① Select the MULTISOUND mode.</p>	<ul style="list-style-type: none"> <li>● Indicates MULTISOUND mode.</li> </ul>  <p>MULTISOUND On</p>
<p>① Press the 0 key.</p> <p>Press  </p>	<ul style="list-style-type: none"> <li>● The display prompts you to insert a disk and press ENTER.</li> </ul> <p>Shows the get sounds function.</p>  <p>ENTER  Flashes while waiting for you to insert disk.</p>
<p>② Put in the disk that has the sounds. Then press ENTER.</p> <p>Press  after you put in the disk </p>	<ul style="list-style-type: none"> <li>● The display asks: LOOP ON?</li> </ul> 

3. Press YES if you want to go ahead with loop on.



- After searching for sounds on disk, the display tells you to use DATA ENTRY A to select.

```
F0 Searching for  
SOUNDS on Disk
```



```
F0 Use DATA ENTRY A  
Select&Press ENTER
```

Shows waiting for you to select a sound to load.

★ Press NO if you want to go ahead with loop off.



- After searching for sounds on disk, the display tells you to use DATA ENTRY A to select.

```
F0 Searching for  
SOUNDS on Disk
```



```
F0 Use DATA ENTRY A  
Select&Press ENTER
```

Shows waiting for you to select a sound to load.

4 Use DATA ENTRY A to select a sound to load.

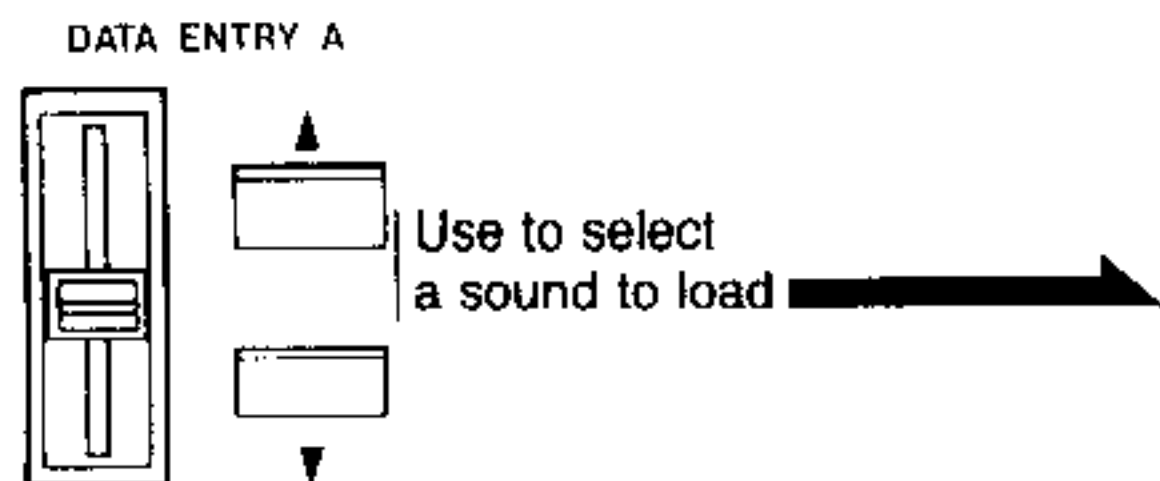

```
F0 Select SOUND
SOUND#01: TEST-#01
```

Shows the sound number

Shows the sound's name.

ENTER

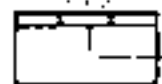

Flashes

Shows you can select the function.

5 Press ENTER



- The length of the sound on disk is found and displayed after the name.
- You can now adjust the value of the load length, which represents the portion of the sound that you wish to get.

```
F0 Loading...
Please Wait a Minute
```

Shows the selected sound's name. Shows the selected sound's length.

```
F0 TEST-#01=012138
LOAD LENGTH=012138
```

Shows the length that you want to load.

ENTER

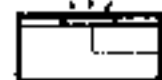

Flashes while you are selecting the length.

④ Use DATA ENTRY A or B to adjust the length of the sound that you want to load.

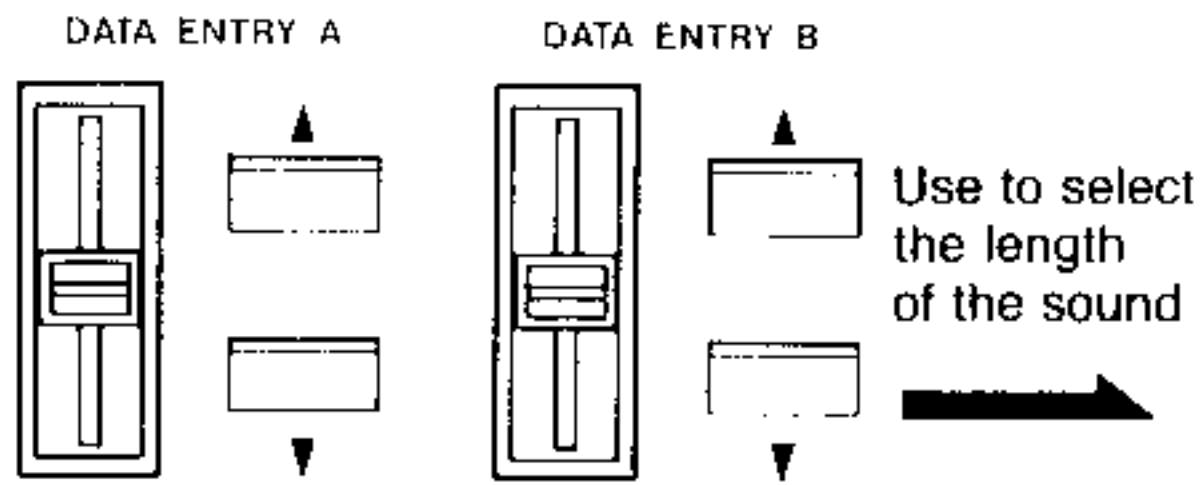

```
F0 TEST-#01=012138
LOAD LENGTH=010739
```

Select the length of the sound that you want to load.

⑤ Press ENTER.



● The display asks for confirmation.

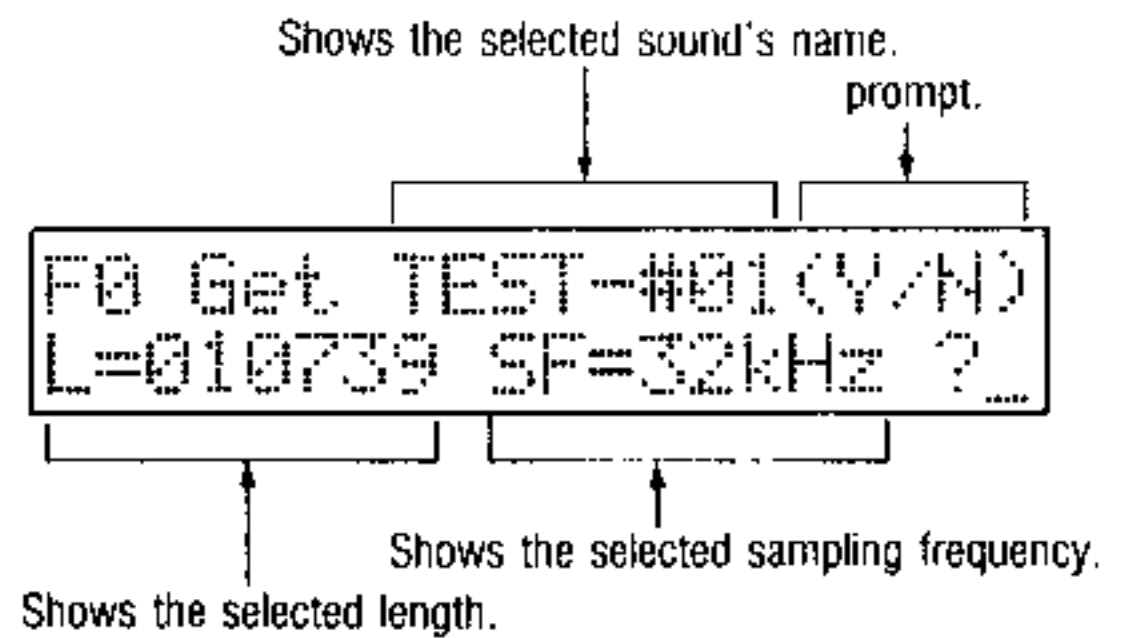

⑧ Press YES to go ahead and get the sound.



- After loading you are free to change the key assignments.

```
F0 Loading...
Please Wait a Minute
```



```
F0 Loading Completed
ORG=C 3  TOP=C 3  TR
```

Shows you can select original key, top key, and transpose mode.

★ Press NO to abort. The display asks if you want to retry.



- Then you are asked whether you wish to retry.  
(To step 11 )

```
F0 Aborted
Retry ? (Y/N)_
```



9 Move the cursor to the parameter that you want to change.

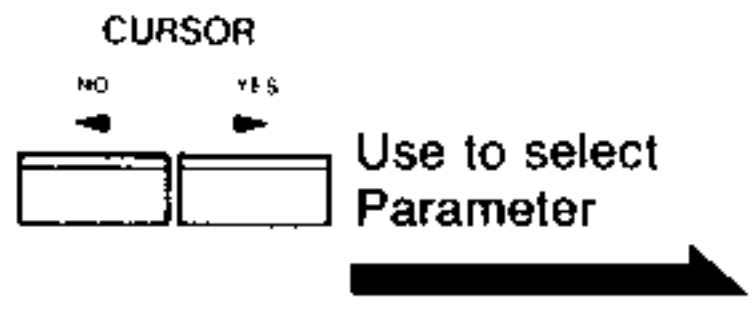

• You can select the parameter after moving the cursor.

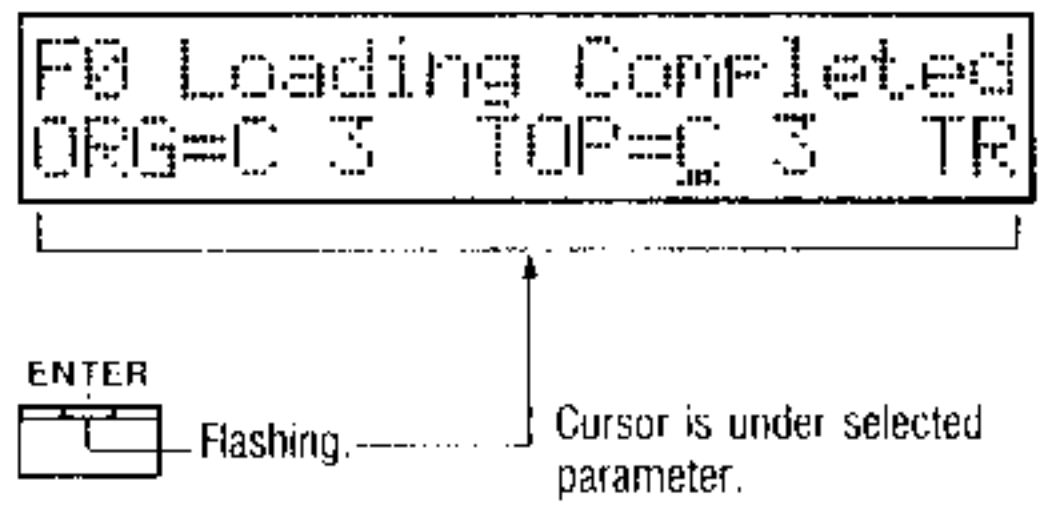

10 Use DATA ENTRY A to adjust the value of the parameter.

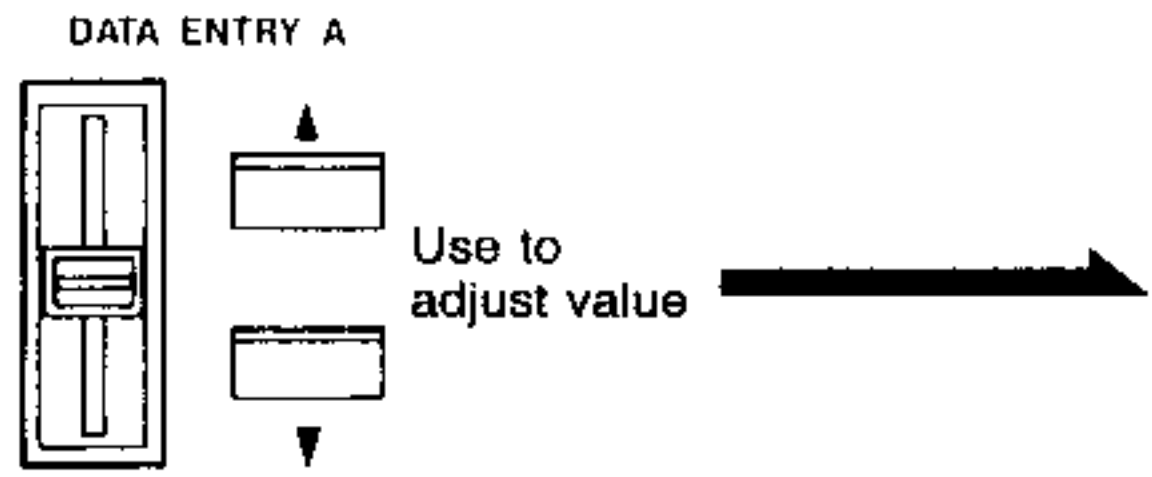

• Adjust value shown.



11 Press ENTER.



• After getting the sound for the displayed sound number, the display asks whether you accept the result.

Shows the sound's name that you loaded.



② Play the keyboard, check the sound, and press the YES key if you are satisfied.



● If you want the sound, press NO.

```
F0 SOUND01:TEST-#01
More SOUNDS?(Y/N)_
```

★ If you don't want the sound, press NO.

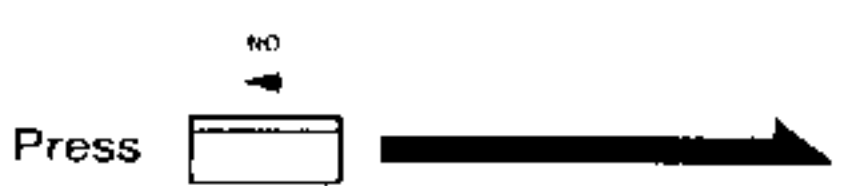

● This is asking if you wish to get a different sound for the currently displayed sound number.

```
F0 SOUND01:TEST-#01
Retry ? (Y/N)_
```

(This takes you to step ③)

③ To continue getting sounds, press YES.



● You are prompted to insert a disk and press ENTER.

```
F0 GET SOUNDS
Insert Disk & ENTER
```



★ If you don't want to continue to get sounds, press NO.



You can now select another function or change modes.

```
F0 M. SND Completed
Select (0-9):
```

Shows you can select a function.

⑭ Put a disk in the drive and press ENTER.



- You can now repeat the procedure from step ④.
- At this point, if you have pressed the YES key in step (⑫) then the sound number changes. If you pressed NO, then it remains the same.

```
F0 Searching for
SOUNDS on Disk
```

```
F0 Use DATA ENTRY A
Select&Press ENTER
```

Shows waiting for selection.

15 Press YES to go ahead and get sounds.



★ To finish or abort, press NO.



- This lets you repeat the procedure from step 14.

```
F0 GET SOUNDS
Insert Disk & ENTER
```



Flashes while waiting for you to insert disk.

- You can now select another function or change modes.

(Display says Aborted if you pressed NO in step 8.)

```
F0 Aborted
Select (0-9):_
```

Shows you can select a function.

(Display says Completed if you pressed NO in step 12.)

```
F0 M.END Completed
Select (0-9):_
```

Shows you can select a function.



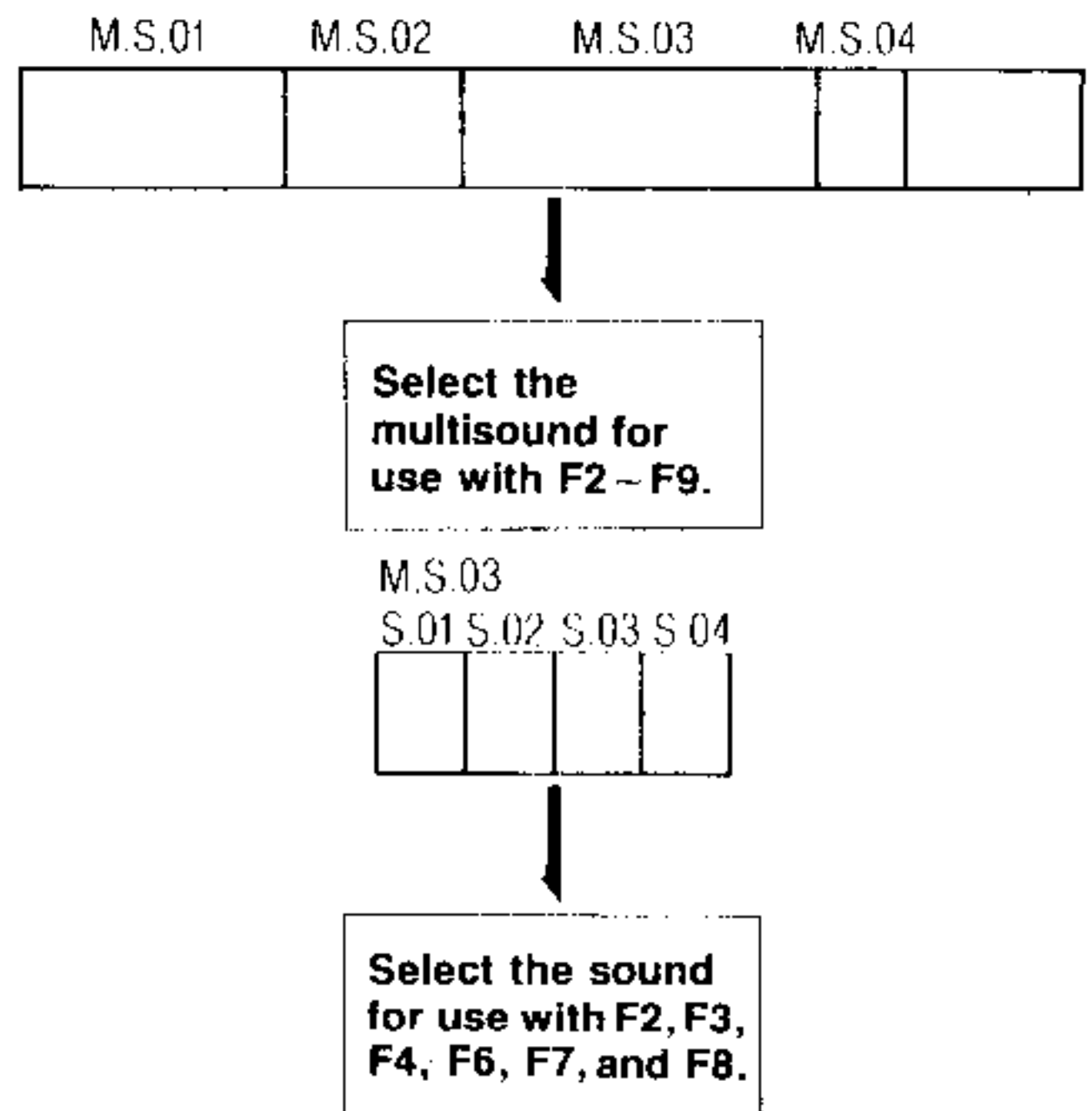

## F1 SELECT M. SOUND/SOUND

### 1. The select multisound/sound function

- This lets you select from wave memory the multisound for use with F2 through F9, and then the sound for use with F2, F3, F4, F6, F7, and F8.
- Sound number 1 of the multisound currently assigned to OSC-1 is selected automatically as the default upon entering the multisound mode.

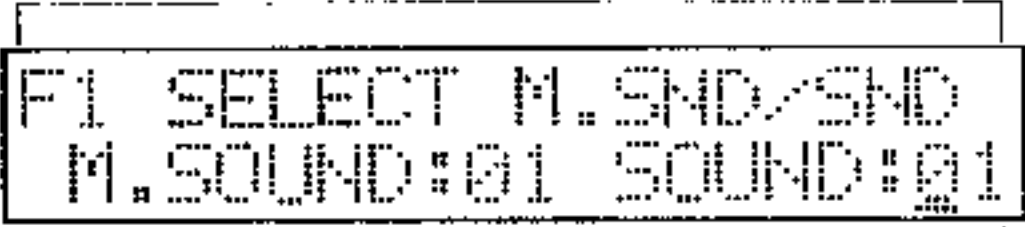
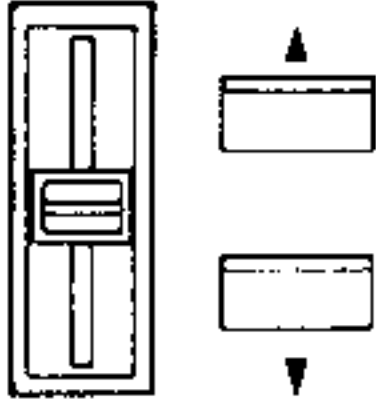

2. Using the select M. sound/sound function

Operation	Operation of DSS-1
<p>0. Select the MULTISOUND mode.</p>	<p>● Indicates MULTISOUND mode.</p> 
<p>1. Press the number 1 key.</p> <p>Press  </p>	<p>● The display shows the multisound number and the sound number.</p> <p>Shows the selected M. sound/sound.</p> 
<p>2. Use DATA ENTRY A or the keyboard to select a sounds.</p> <p>DATA ENTRY A</p>  <p>Use to select a sound </p>	 <p>Shows the selected sound.</p>

### To change a multisound

3) To change a multisound, first move the cursor to the left side of the display. Press the NO key to do this.



- The cursor moves to the left side of the display and wait for you to select a multisound.

```

F1 Select M.SND/SND
M.SOUND:01 SOUND:04
  
```

Shows waiting for selection of multisound.

4) Then use DATA ENTRY A to select a multisound.

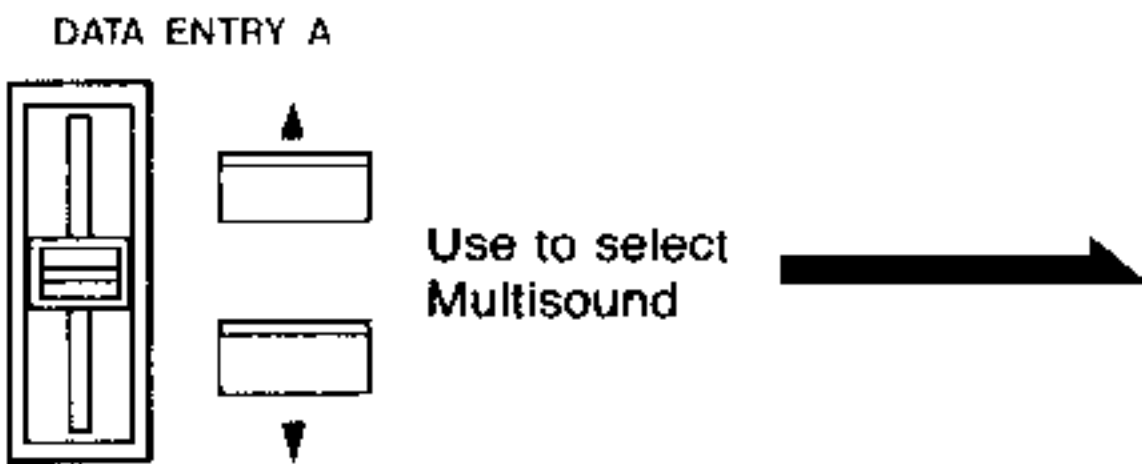

- You can now select a multisound. (Sound number returns to 1)



```

F1 SELECT M.SND/SND
M.SOUND:02 SOUND:01
  
```

Shows the selected multisound number.



5: Press ENTER.

Press  after the selection 

- The selected multisound is assigned to OSC-1 and OSC-2, so you can check the sound.

```
F1 SELECT N.SND/SND
M.SOUND:02 SOUND:01
```

ENTER  Stop flashing.

6: Move the cursor to the right.

Press  

- You can now select a sound as in step 2).



## F2 REL. PARAMS(TUNE/LEV/Fc)

[1] The relative parameter function.

- This enables fine adjustment of the tuning, level, and cutoff frequency of a sound within a multisound selected using F1.
- The "compare" capability lets you alternately listen to the newly assigned value and the previous value.

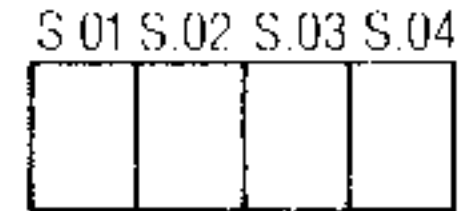

This enables fine adjustment of the tuning, level, and cutoff frequency of a sound within a multisound selected using F1.

### TUNE parameter values

-63-- 0 -- +63





### LEVEL parameter values

01-- 64

### CUTOFF (Fc) parameter values

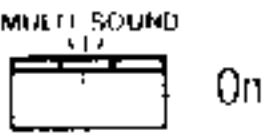
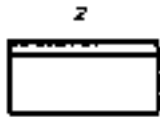
01--64

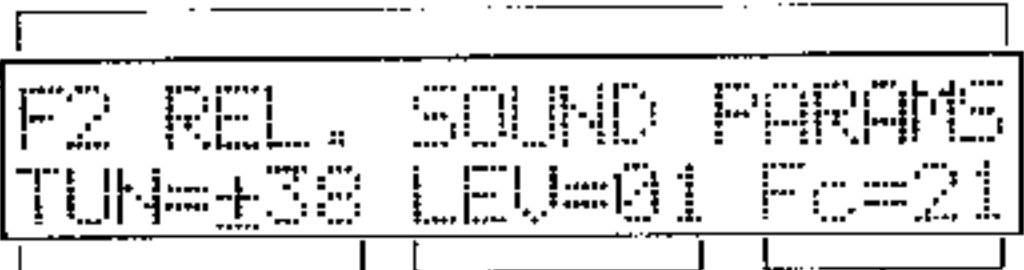
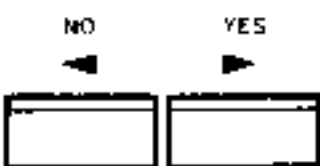
2. Using the relative parameter function

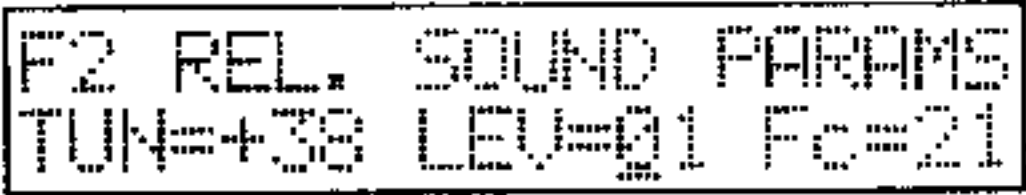
Operation	Operation of DSS-1
<p>① Select the MULTISOUND mode.</p>	<ul style="list-style-type: none"> <li>Indicates MULTISOUND mode.</li> </ul> 
<p>② Press the number 2 key.</p> <p>Press  </p>	<ul style="list-style-type: none"> <li>The lower line of the display shows the current values for the three parameters: tuning, level, and cutoff frequency.</li> </ul> <p>Shows the relative parameter function.</p>  <p>Shows the selection of tuning.      Shows the selection of level.      Shows the selection of cutoff frequency.</p>
<p>③ Move the cursor under the value of the parameter that you want to adjust.</p> <p>CURSOR NO      YES  Use to select Parameter </p>	<ul style="list-style-type: none"> <li>You can adjust the value after moving the cursor.</li> </ul> 

3. Use DATA ENTRY A to change the value of the parameters as necessary.

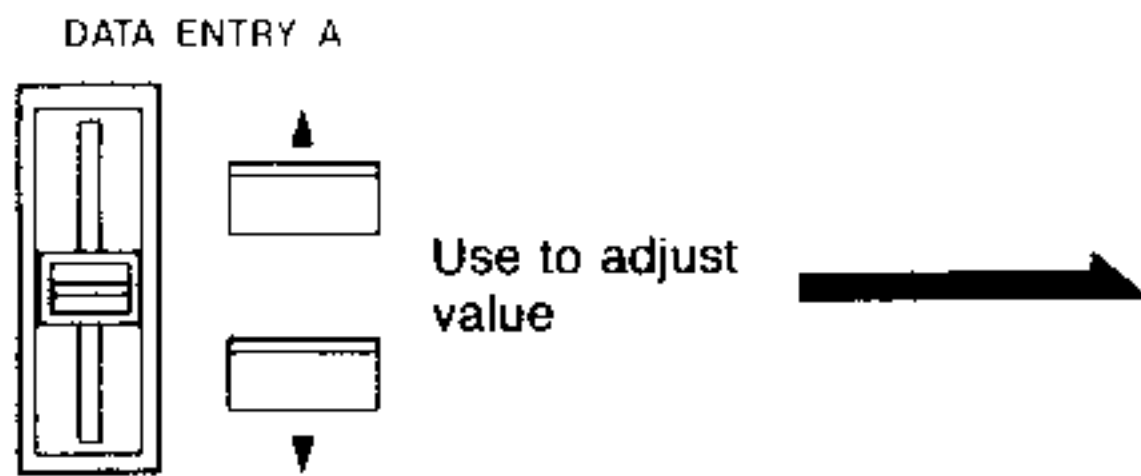

```
F2 REL. SOUND PARAMS
TUN=+38 LEV=05 Fc=21
```

■ Use the COMPARE key to make comparisons between the effects of newly assigned and previous settings.

i) Pressing the COMPARE key once recalls the setting that existed previously (that which appeared immediately upon selecting the relative parameters function).



- Recalls the previous value of the parameter at the cursor position.

```
F2 REL. SOUND PARAMS
TUN=+38 LEV=01 Fc=21
```

ii) Press the COMPARE key again to bring back the new setting.



- Brings back the new value of the parameter at the cursor position.

```
F2 REL. SOUND PARAMS
TUN=+38 LEV=05 Fc=21
```

★ Repeating the above two steps (that is, repeatedly pressing the COMPARE key) lets you compare the effects of the new setting with the previous setting.

# F3 ORIGINAL/TOP KEY

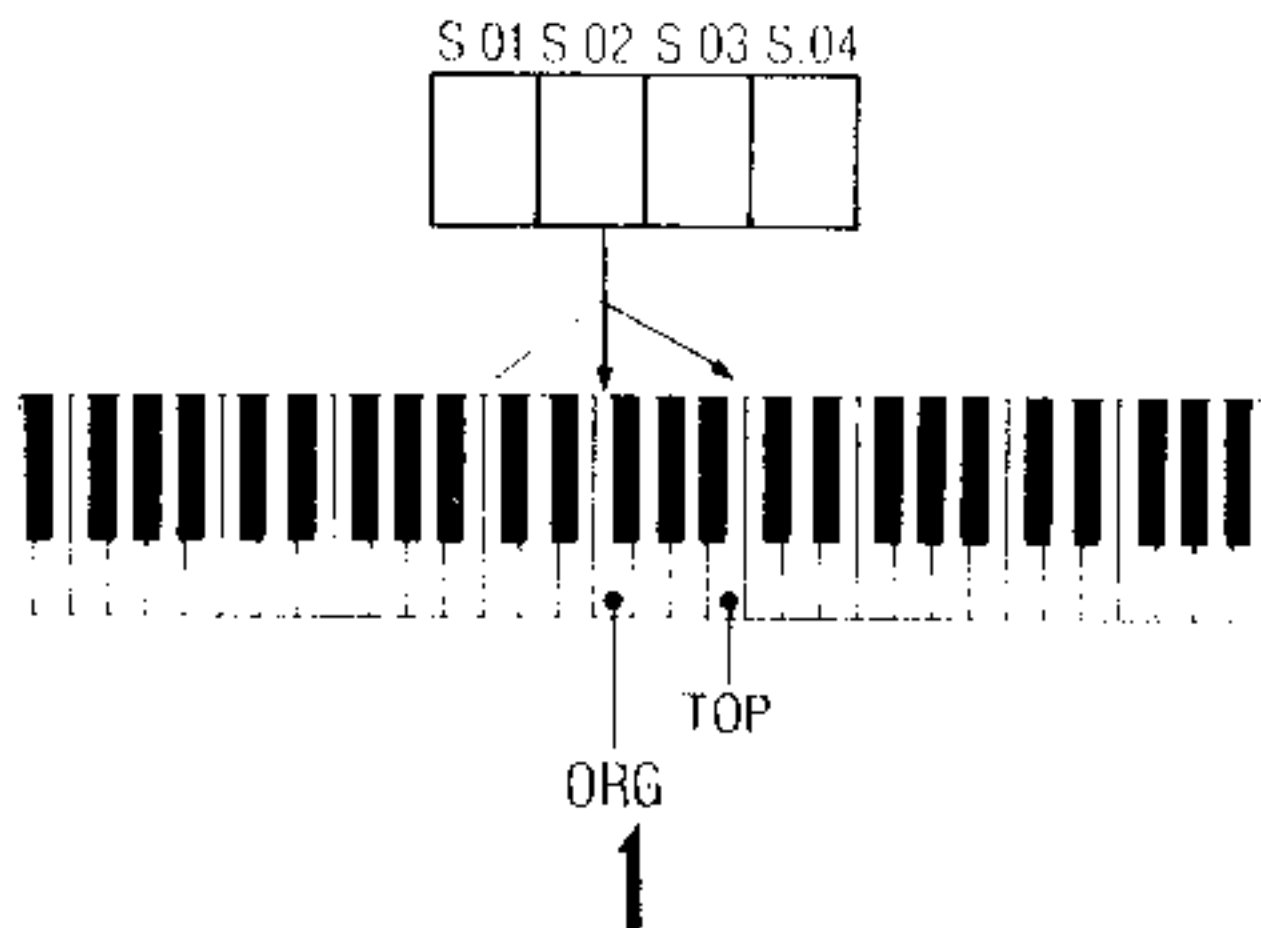

## 1) About the original/top key function

- Allows you to set or change the key assignments for sounds within a multisound selected with F1.

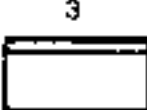

Allows you to set or change the key assignments for sounds within a multisound selected with F1.

## 2) Using the original/top key function

Operation	Operation of DSS-1
<p>① Select the MULTISOUND mode.</p>	<ul style="list-style-type: none"> <li>● Indicates MULTISOUND mode.</li> </ul> 
<p>② Press the number 3 key.</p> <p>Press  </p>	<ul style="list-style-type: none"> <li>● The display shows the multisound number and sound number on the upper line.</li> </ul> <p>Shows the multisound number and sound number.</p>  <p>Shows the setting for the original key.      Shows the setting for the top key.      Shows the setting for the transpose mode.</p>

② Use the cursor keys to move the cursor to the parameter that you want to change.

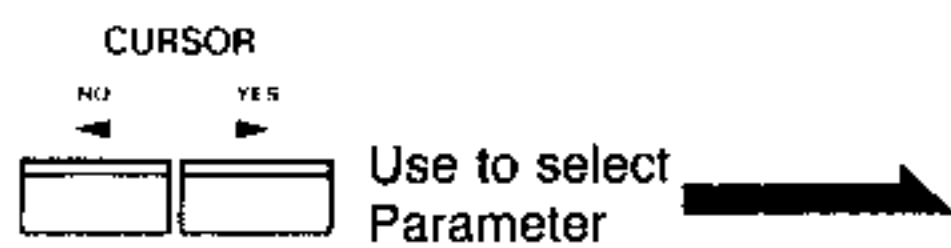

● You select the parameter by moving the cursor.

```
F3 M.SND:01 SOUND:01  
ORG=C 3 TOP=F 3 IR
```

③ Use DATA ENTRY A to make the changes.

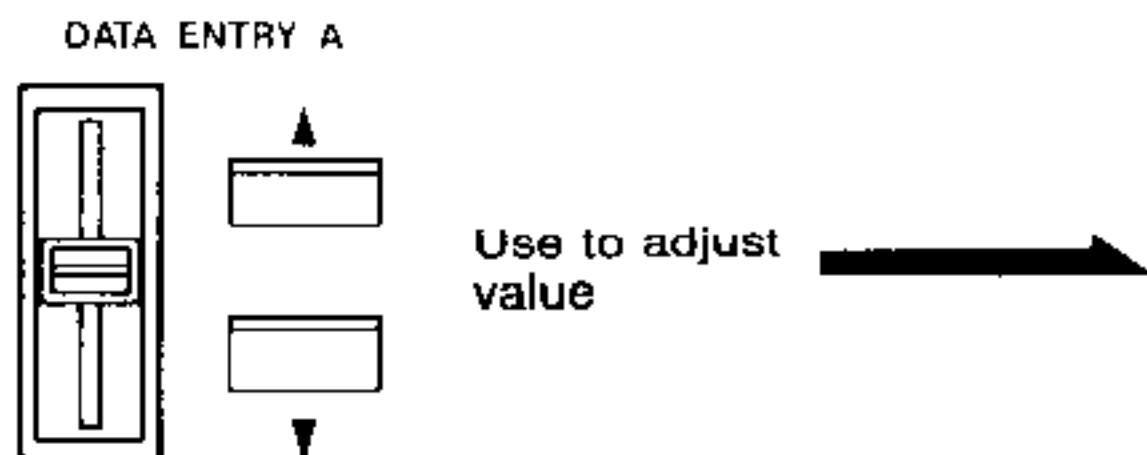

```
F3 M.SND:01 SOUND:01  
ORG=C 3 TOP=F 3 NT
```

Shows the current values.

## F4 SOUND START & LENGTH

### 1 About the sound start & length function

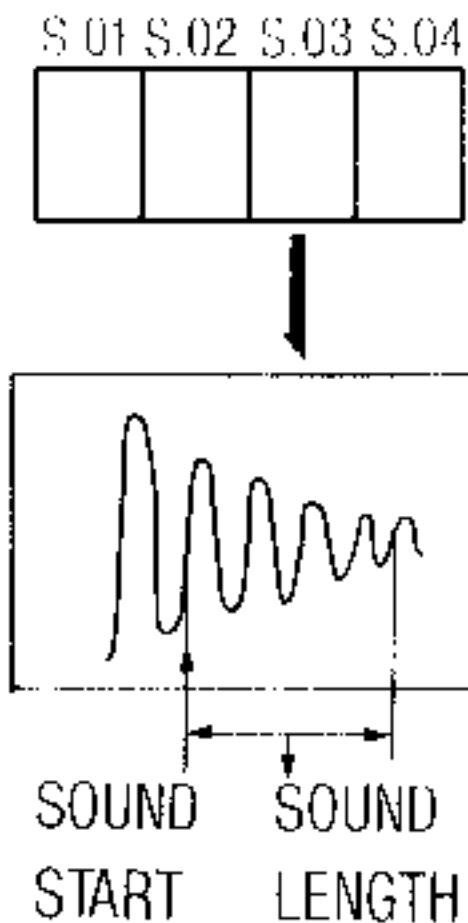

- For setting the sound start and sound length values of the sound within a multisound selected with F1.

Changing the sound start or length simultaneously with the press or release of a key on the keyboard may result in no sound or hanging sound. Take care avoid this situation.



For setting the sound start and sound length values of a sound within a multi sound selected with F1.

### 2 Using the sound start & length function

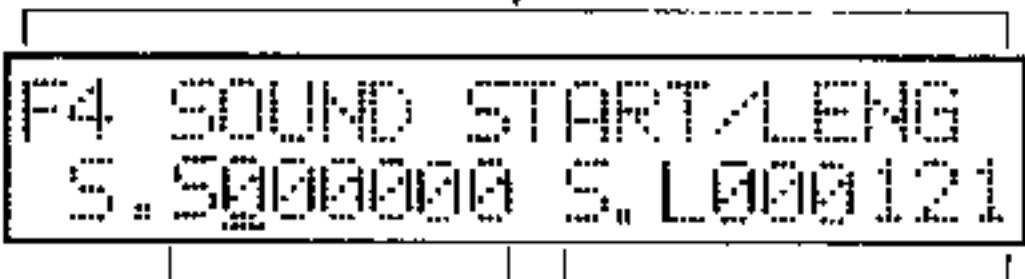
Operation	Operation of DSS-1
0 Select the MULTISOUND mode.	<ul style="list-style-type: none"> <li>Indicates MULTISOUND mode.</li> </ul> 
① Press the number 4 key.  Press  	<ul style="list-style-type: none"> <li>The display shows the sound start (S.S.) and sound length (S.L.) values.</li> </ul> <p>Shows the sound start &amp; length function.</p>  <p>Shows the sound start. Shows the sound length.</p>

② Move the cursor to the parameter value that you want to change.

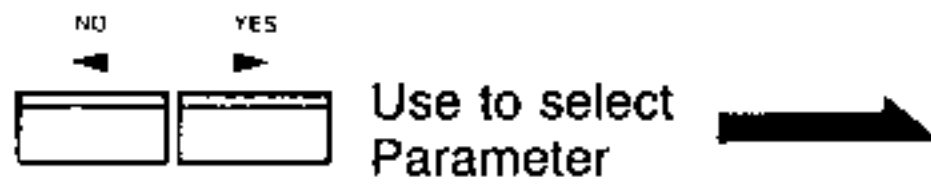

● You can select the parameter by moving the cursor.

```
F4 SOUND START/LENG
S. 5000000 S. L000121
```

③ Use DATA ENTRY A and B to adjust the value.

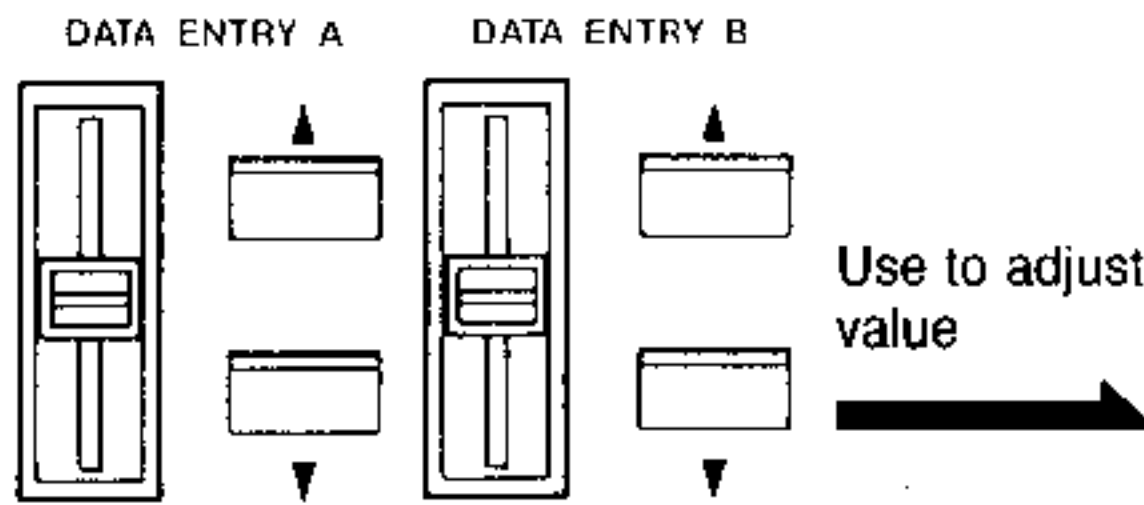

● You can adjust the value after moving the cursor.

```
F4 SOUND START/LENG
S. 5000000 S. L000107
```

■ Use the COMPARE key to make comparisons between the effects of newly assigned and previous settings.

i) Pressing the COMPARE key once recalls the setting that existed previously (that which appeared immediately upon selecting the Sound Start & Length function).



● Recalls the setting that existed previously.

```
F4 SOUND START/LENG
S. 5000000 S. L000121
```

ii) Press the COMPARE key again to bring back the new setting.



● Brings back the new setting.

```
F4 SOUND START/LENG
S. 5000000 S. L000107
```

★ Repeating the above two steps (that is, repeatedly pressing the COMPARE key) lets you compare the effects of the new setting with the previous setting.

# F5 LOOP ON/OFF

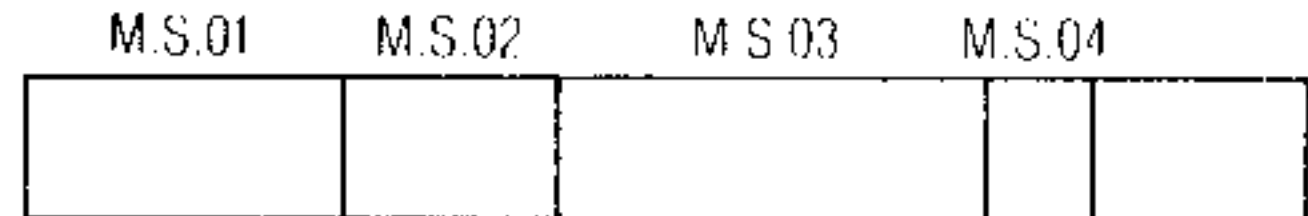

## 1 About the loop on/off function

- Lets you switch the loop on and off for the multisound selected by F1.

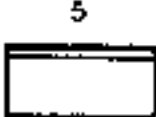

Lets you switch the loop on and off for the multisound selected by F1.

## 2 Using the loop on/off function

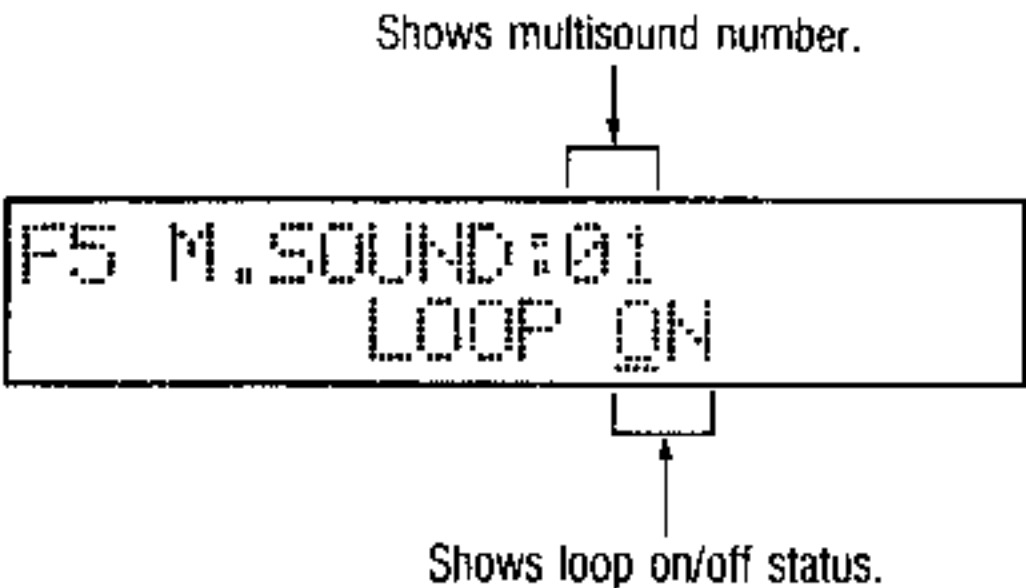
Operation	Operation of DSS-1
<p>① Select the MULTISOUND mode.</p>	<ul style="list-style-type: none"> <li>● Indicates MULTISOUND mode.</li> </ul> 
<p>② Press the number 5 key.</p> <p>Press  </p>	<ul style="list-style-type: none"> <li>● Displays multisound number on upper line. Lower line shows loop on/off status.</li> </ul> 



2 Use DATA ENTRY A to select loop on or off status.

DATA ENTRY A

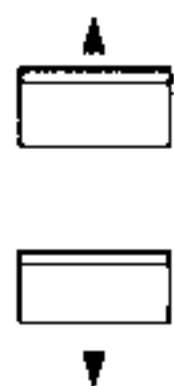
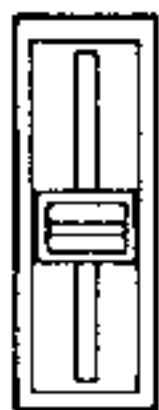

Use to select  
Loop on/off



F5 M. SOUND:01  
LOOP ON

Shows loop on or off status.

# F6 LOOP START & LENGTH

## About the loop start & length function

- Allows you to set the loop start and loop length parameters of a sound within a multisound as selected with F1.

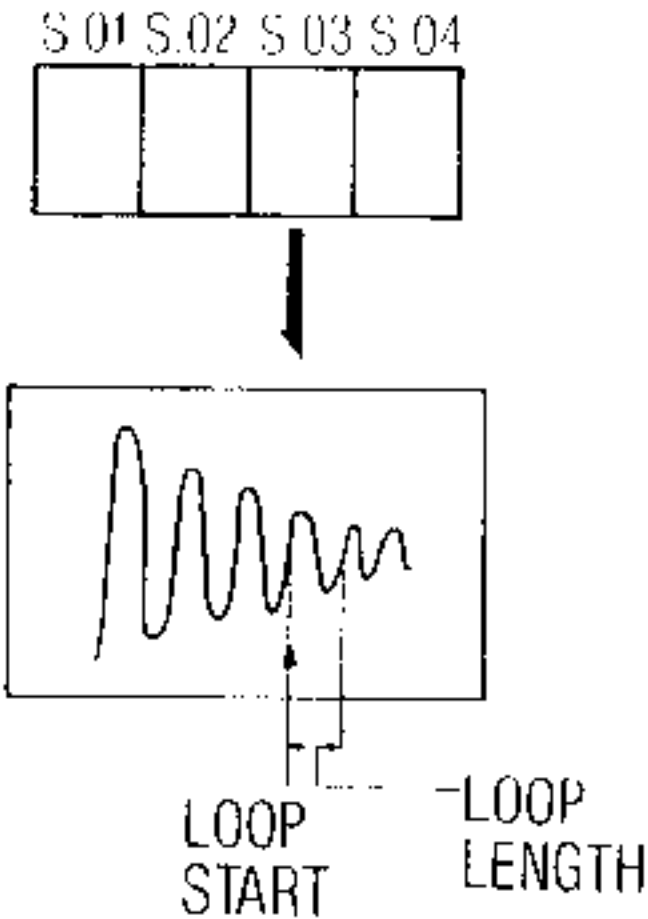

## Auto Zero Cross Search capability.

This automatically finds appropriate places for the loop start and loop length points by looking for the zero cross points and polarity changes.

An example is shown in the diagram. Assume that loop start is initially set at point (A), so that the sum of loop start and loop length is loop end point (B). Now if we execute the auto zero cross search, it looks backward for the closest zero cross point to (B), which is (1) and establishes that as the new loop end. Then it looks for the closest zero cross point to (A) that has the same polarity change as (A). This point [1] is set as the new loop start point. (So that loop length is now (1) minus [1].) Now each time you press the left cursor key, the loop start point goes to the next suitable point to the left ([2] then [3], etc.). (Note that the loop start value gets smaller as loop length gets longer.)

Likewise, pressing the right cursor key moves the loop start position back (from [2] to [1], for example). (So that the loop start value increases while the loop length value decreases.)

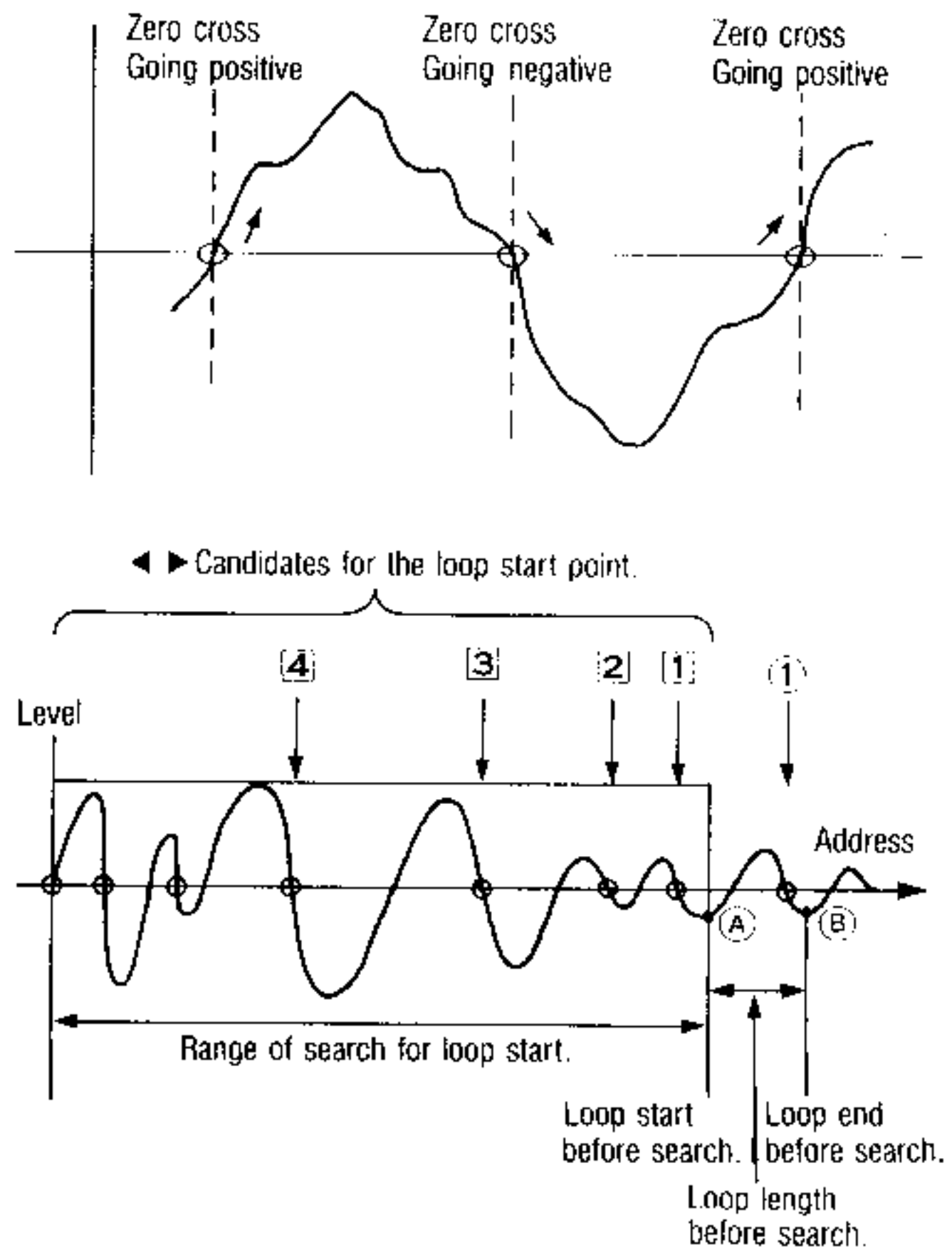

**Relationship between the sound start/length and the loop start/length settings.**

■ **When loop is off.**

Plays once from A to B.

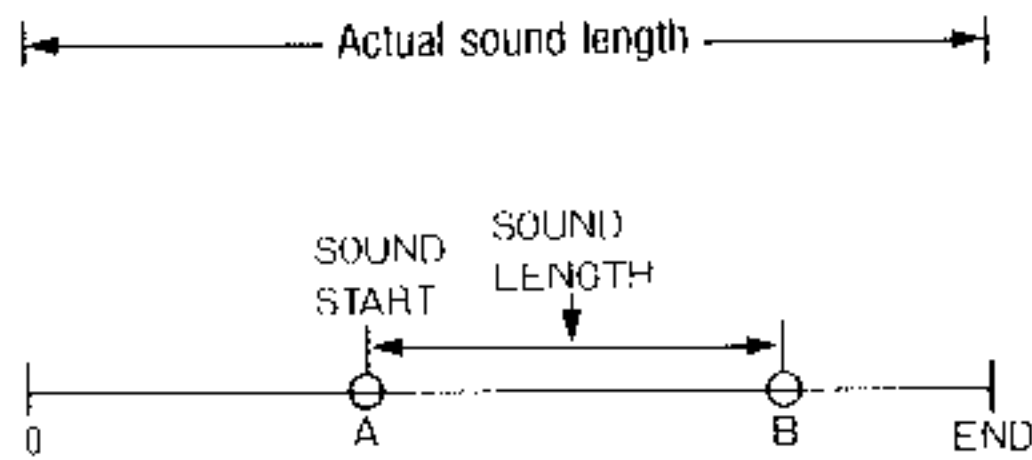

■ **When loop is on.**

Plays A to C to D, then loops C to D, C to D, etc. (Loops from C to D)

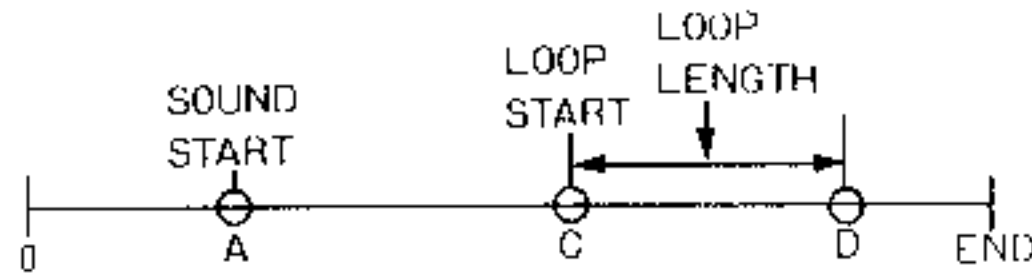

Plays A to D, then loops C to A to D, C to A to D, etc. (Loops from C to D)

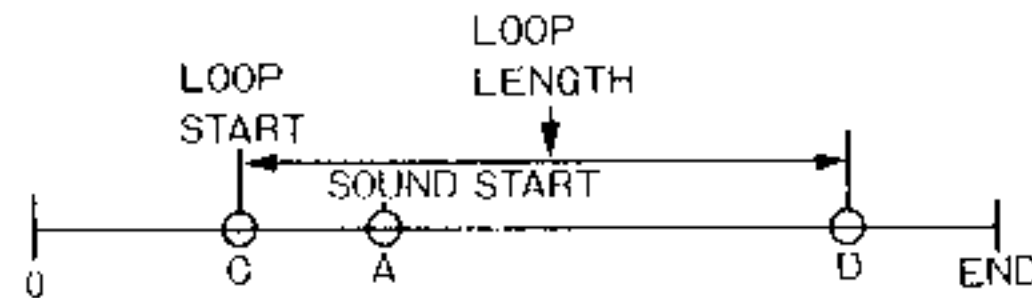

As shown in the diagrams, if loop is on, then play always starts at sound start (A), goes to the point specified by loop start plus loop length (D), then loops back from loop start (C) to the end of the loop length. The loop is then repeated. Therefore, it is not allowable to have (A) further to the right than (D), nor to have (D) further to the right than the end of the sound (END).

- To prevent loop start from affecting loop length, the longer the loop length, the less room you will have to adjust the loop start.

Range over which loop start may be adjusted.

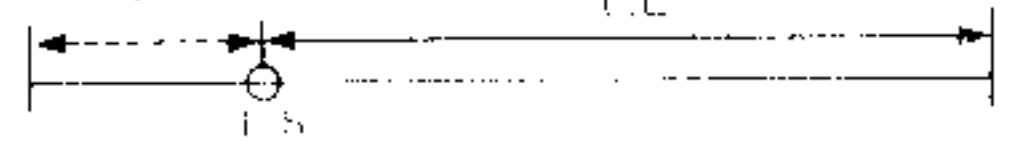



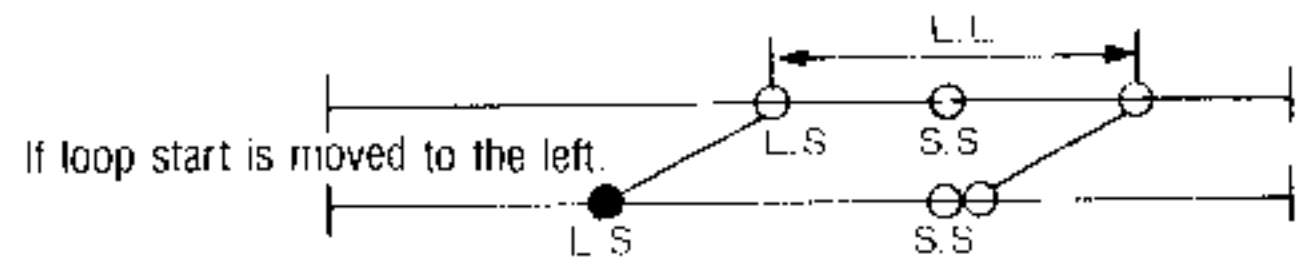
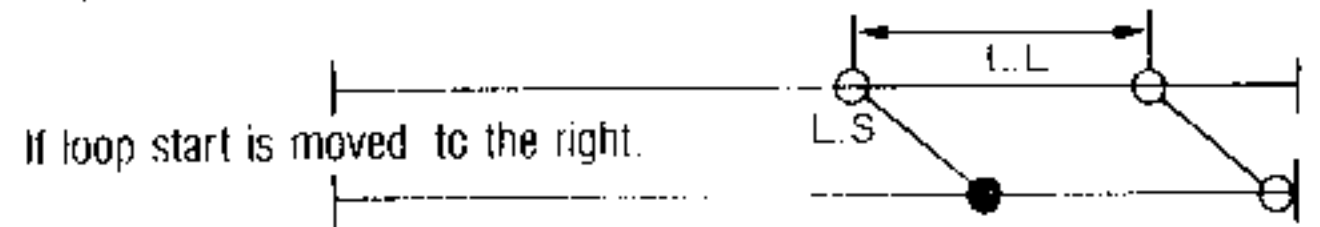

- Loop start plus loop length can not extend further to the right than the end of the sound. Changing loop start does not cause a change in loop length, so loop start can be moved to the right no farther than the solid dot in the diagram. Furthermore, loop start can be moved to the left only so far as the sum of loop start and loop length coincides with the sound start position.

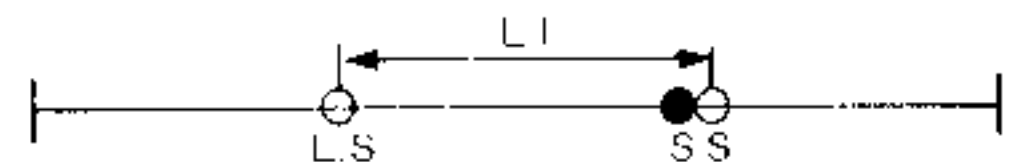
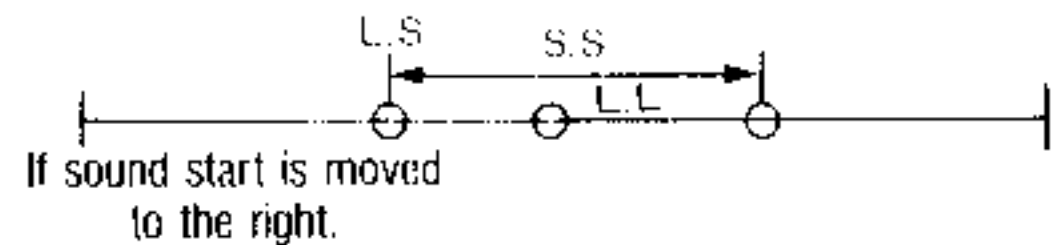

- For the same reasons, you can not move sound start further to the right than the sum of loop start and loop length (the solid dot in the diagram).

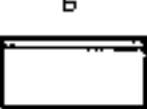

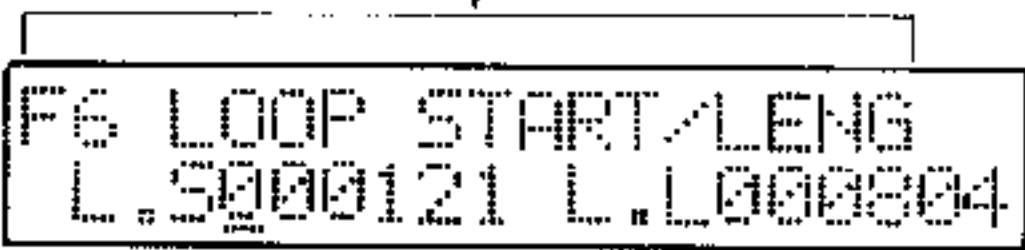
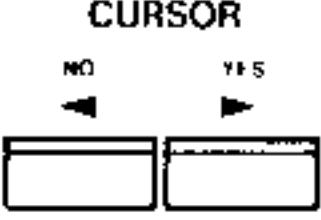
## 2 Using the loop start &amp; length function

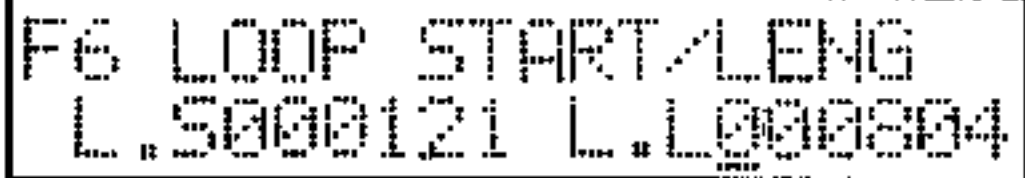
Operation	Operation of DSS-1
0 Select the MULTISOUND mode.	<ul style="list-style-type: none"> <li>Indicates MULTISOUND mode.</li> </ul> 
1 Press the number 6 key.  Press  	<ul style="list-style-type: none"> <li>Display shows loop start address (L.S.) and loop length (L.L.) values on the lower line.</li> </ul> <p>Shows the loop start &amp; length.</p>  <p>Shows loop start address.      Shows loop length.</p>
2 Move the cursor to the parameter that you want to change.   Use to select Parameter 	<ul style="list-style-type: none"> <li>You can select the parameter by moving the cursor.</li> </ul> 

3 Use DATA ENTRY A or B to change the value of the parameter at the cursor position.

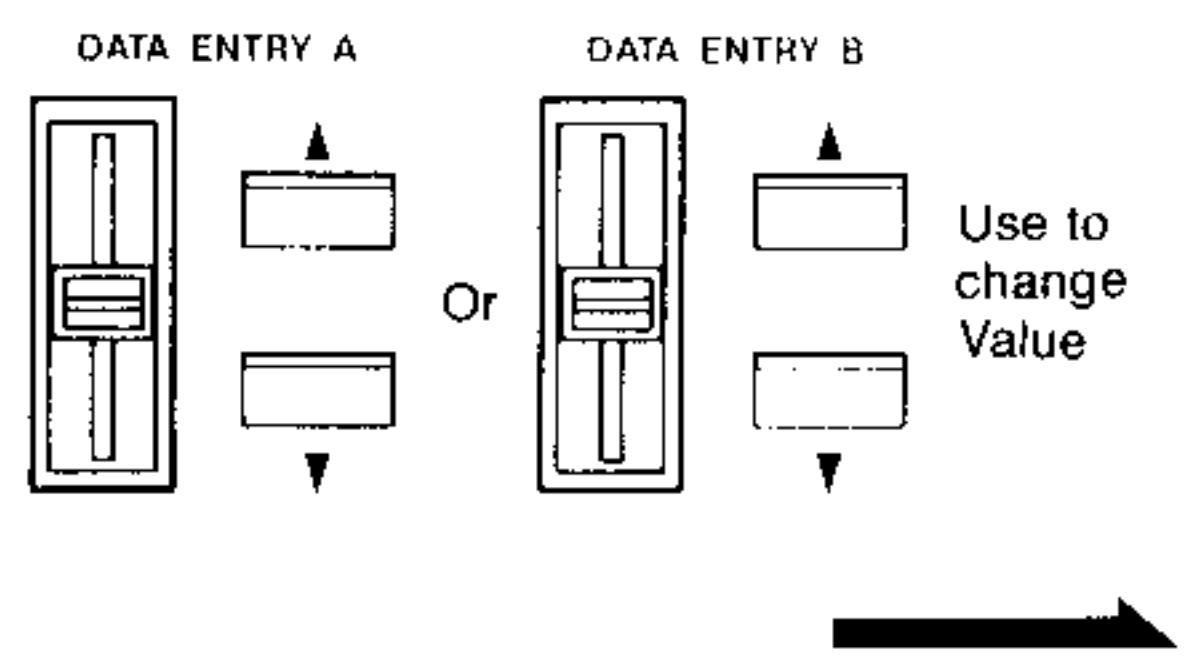

● The display tells you that you can press ENTER to enable auto loop.

Shows you can select auto loop.

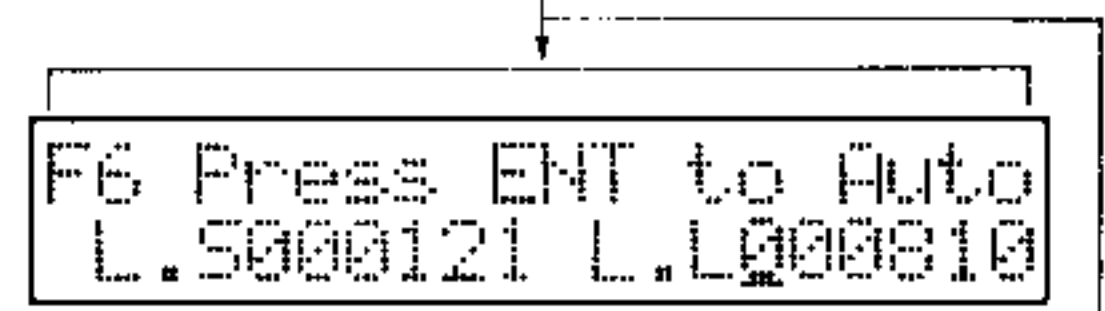

Shows the selected loop start address and length.

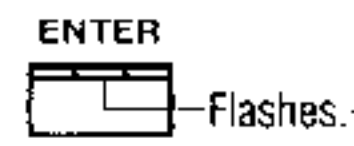

4 (To perform auto loop)  
After setting the start address and length, press the ENTER key.



● A zero cross positive polarity search is performed. It is then possible to select the zero cross point.

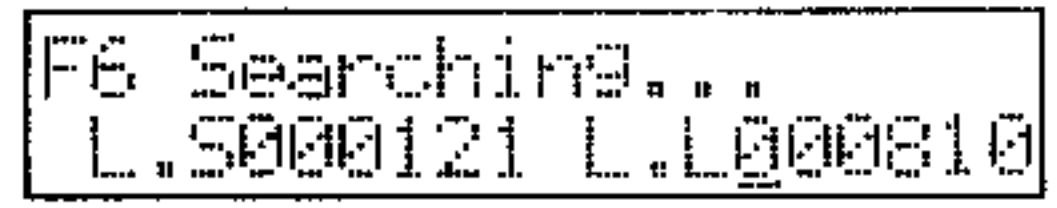

Shows you can search for the zero cross point using the cursor keys.



5 Use the cursor keys to select the zero cross point.

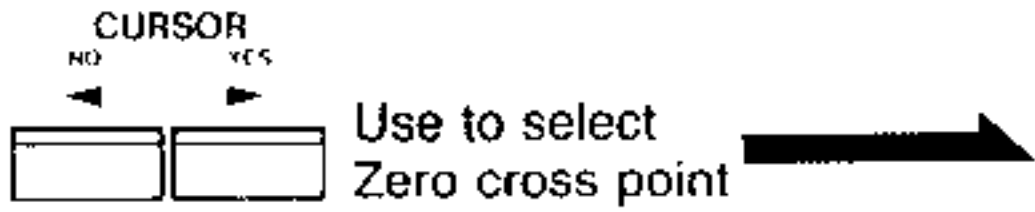

- Select the zero cross point using the cursor keys.

Shows you can return to manual operation using the cancel key.

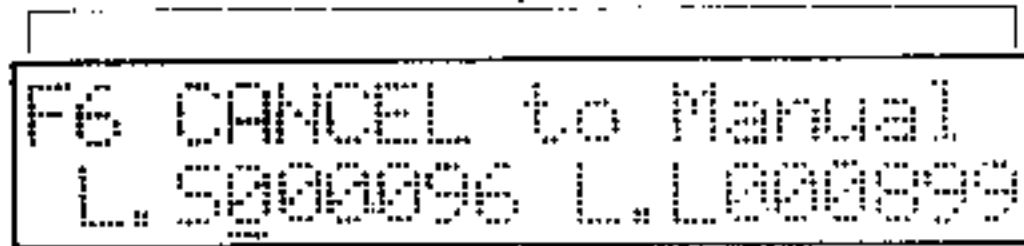

6 You can use the cancel key to return to manual operation.



- This lets you repeat from step 2, setting the loop start and length parameter values.

■ When you are in the manual operation, you can use the COMPARE key to make comparisons between the effects of newly assigned and previous settings.

i) Pressing the COMPARE key once recalls the setting that existed previously (that which appeared immediately upon selecting the Loop Start & Length function).



- Recalls the setting that existed previously.

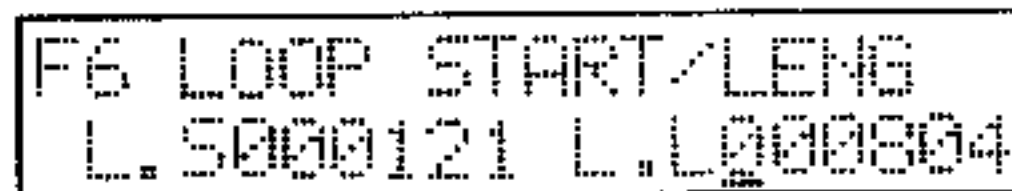

ii) Press the COMPARE key again to bring back the new setting.



- Brings back the new setting.

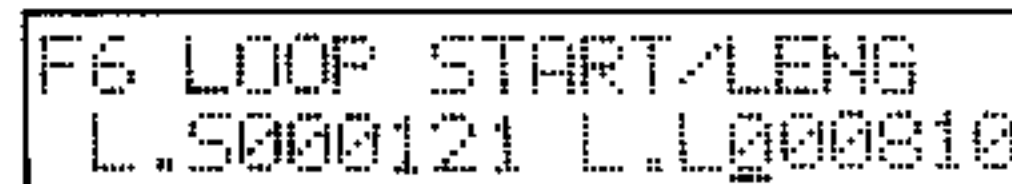

★ Repeating the above two steps (that is, repeatedly pressing the COMPARE key) lets you compare the effects of the new setting with the previous setting.

## F7 LOOP PROCESS(X-FADE/B&F)

### 1. About the loop process (cross-fade/back-and-forth) function.

- This comprises the cross-fade function and the back-and-forth function. these two functions are distinct from each other.

#### A. The cross-fade function

#### B. The back-and-forth function

#### A. The cross-fade function.

- Once you have used F1 to select a sound from a multisound and then used F6 to set the loop start and length parameters, you can use the cross-fade function to take a portion of the waveform of a particular length from in front of the start point and mix it into the end which has been attenuated over a portion of the same length.

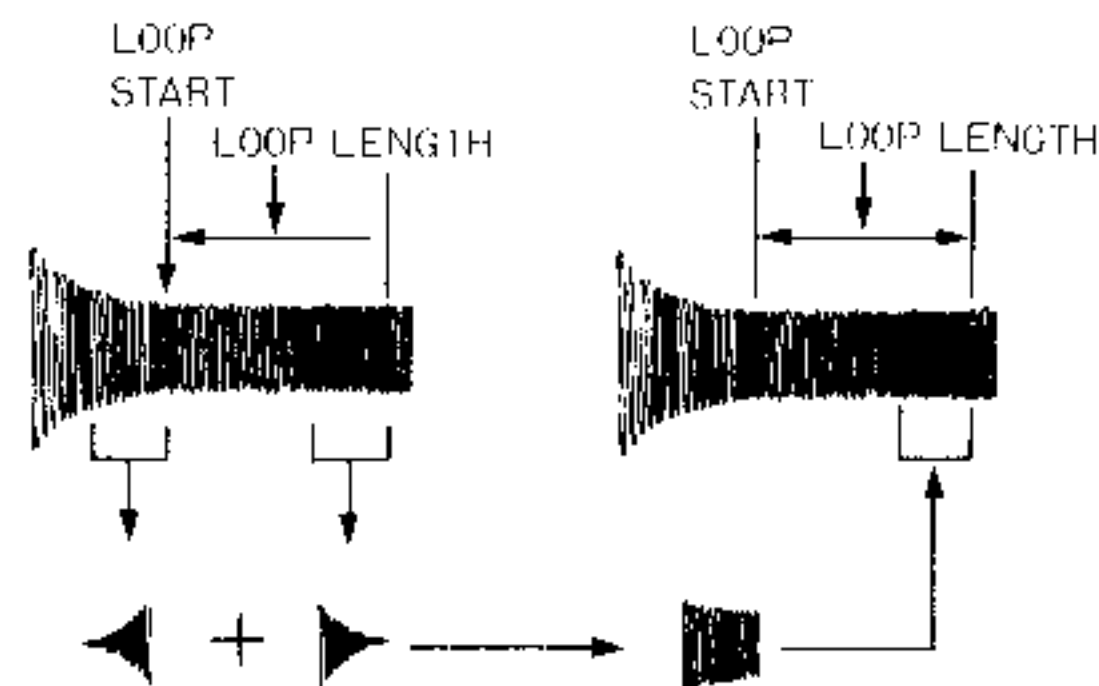

- Immediately before a cross fade is executed, the area to be overwritten is "evacuated" to the remaining area that is free in wave memory. Therefore, a cross fade can not be carried out if insufficient free area remains.

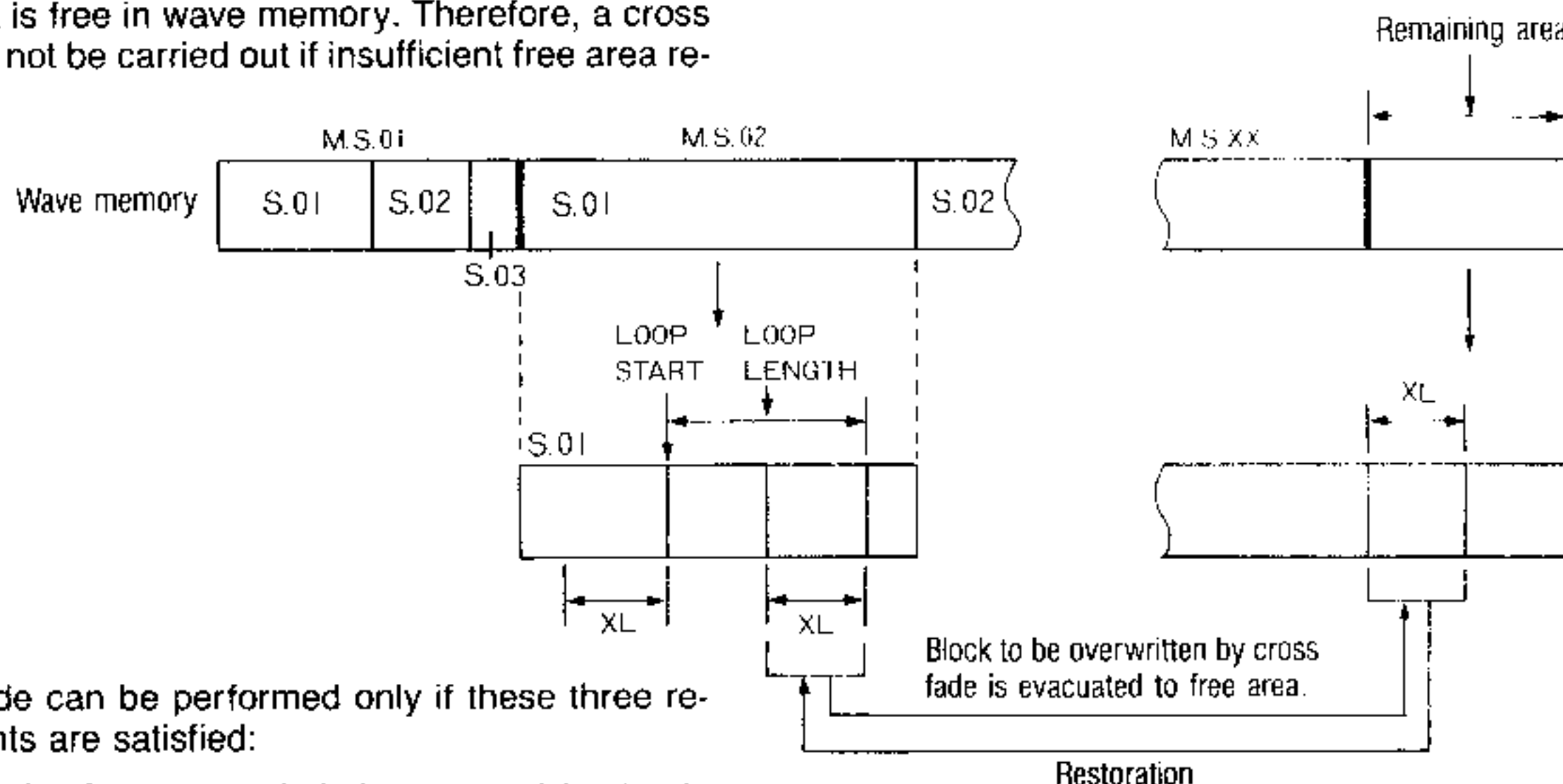

- Cross fade can be performed only if these three requirements are satisfied:
- Immediately after a cross fade is executed (and only before doing anything else) it is possible to put the evacuated data back into its original position, thereby restoring the sound to its previous condition.
- For the cross fade length you can choose any integer value (1, 2, 3, etc.) up to 256 or any multiple of 256 (256, 512, 768, ...).

Where XL is cross fade length.  
 $XL < LOOP\ START$   
 $XL < OR = LOOP\ LENGTH$   
 $XL < OR = REMAINING\ AREA$

**B. The back-and-forth function.**

■ This takes the portion from the start of the loop address up to about half of the loop length, reverses the waveform and uses it to replace the remaining length of the end of the sound waveform. This also assumes that a sound has been selected from a multisound using F1 and that you have used F6 to specify the loop start and length parameters.

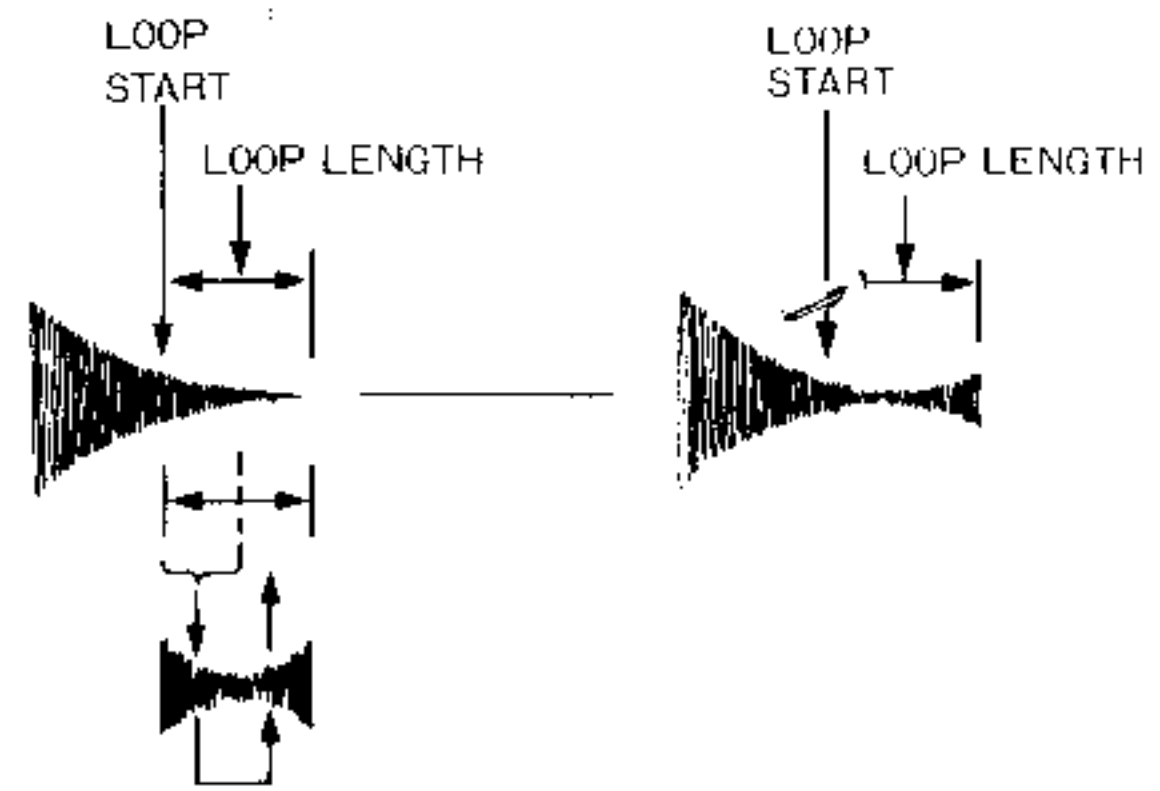

■ Before executing a "back & forth" the data from the loop region is evacuated to the remaining free area of wave memory. Therefore, the back & forth operation can not be carried out if remaining area is shorter than loop length.

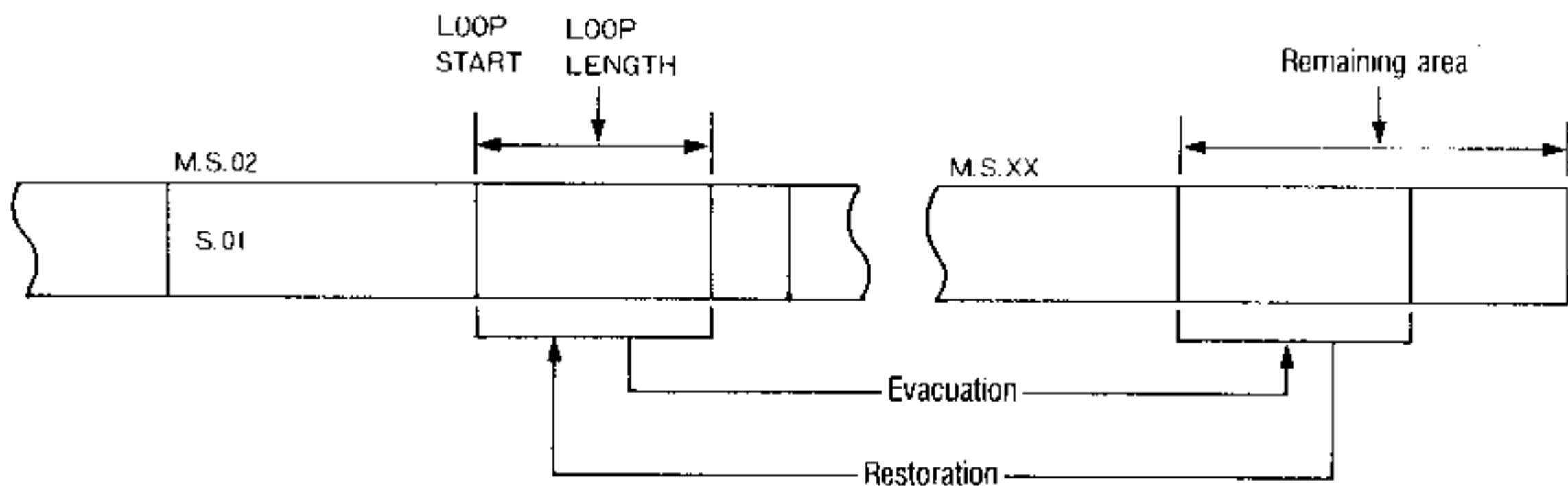







■ The evacuated data can be put back in its original position, thereby restoring the original sound. This is possible only if done immediately after the back & forth operation is executed.

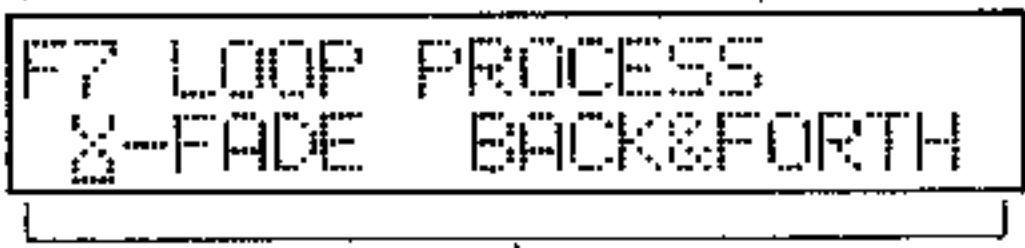
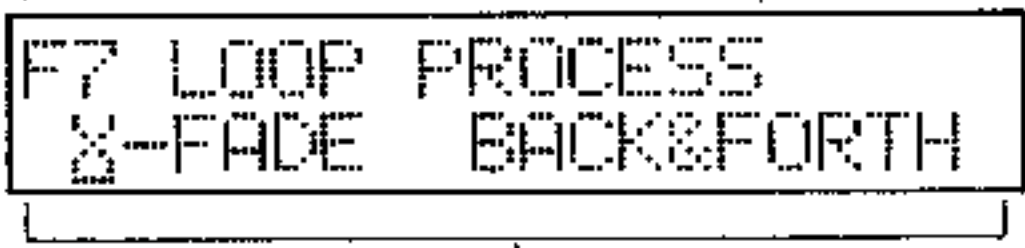
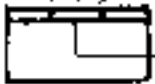

2 Using the loop process function.

A. Using cross-fade.

Operation	Operation of DSS-1
<p>0. Select the MULTISOUND mode.</p>	<ul style="list-style-type: none"> <li>● Indicates MULTISOUND mode.</li> </ul>  <p>MULTISOUND On</p>
<p>① Press the number 7 key.</p> <p>Press  </p>	<ul style="list-style-type: none"> <li>● The display gives you a choice of X-FADE or BACK &amp; FORTH.</li> </ul> <p>Shows the loop process function.</p>  <p>ENTER  Flashes. Shows you can choose X-FADE or BACK &amp; FORTH</p>
<p>② Press the NO cursor key to move the cursor to the X-FADE (cross-fade) position.</p> <p>Press  </p>	 <p>Shows the selected cross-fade.</p>

③ Press ENTER.

Press  after the confirmation 

● You are prompted to set the fade length.



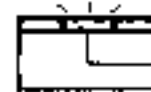

Shows the cross-fade

F7 CROSS FADE LOOP  
FADE LENGTH = 000000

 Flashes. Shows you can set the fade length.

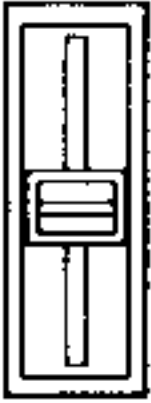
④ Use DATA ENTRY A or B to set the length.  
を設定します。

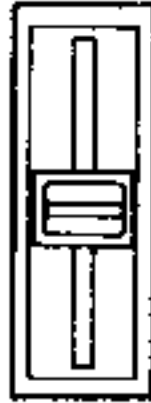
DATA ENTRY A      DATA ENTRY B

        Or         Use to select Length

F7 CROSS FADE LOOP  
FADE LENGTH = 000512

Shows the selected fade-length.

(DATA ENTRY B is used for integer values up to 256.)

5. Press ENTER to input your length setting.

ます。

Press  after the selection 

- The display asks if you are sure that you want to do a cross-fade with this length.

Shows the selected length.

F7 XFADE L = 000512  
Are You Sure? (Y/N)\_

6. Press YES if you are sure.

Press  

- After performing the cross-fade, you are asked if you want to make this sound permanent.

F7 This Will Take  
a While

F7 Make This Sound  
Permanent ? (Y/N)\_

★ If you want to abort the cross-fade, press NO.

Press  

- The display asks if you want to retry.

F7 X-FADE Aborted  
Retry ? (Y/N)\_

(This takes you to step 8.)

⑦ If you want to keep the results of the cross-fade, press YES.



★ If you do not wish to keep the results of the cross-fade then press NO.



- You are asked if you want to try once more.

```
F7 X-FADE Completed  
Retry ? (Y/N)_
```

- The result is cancelled and the sound is restored to its condition prior to execution of the cross fade.
- You are asked if you would like to try a cross fade again.

Display during restoration of sound data.

```
F7 This Will Take  
a While
```



```
F7 X-FADE Cancelled  
Retry ? (Y/N)_
```

8) Press YES if you want to retry.



★ Press NO if you wish to quit.



- This takes you back to step 3 where you can change the fade length before trying again.

- You can now select another function or change modes.

(Display says Aborted if you pressed NO in step 6.)

```
F7 X-FADE Aborted
Select (0-9): _
```

Shows you can select a function.

(Display says Completed if you pressed YES in step 7.)

```
F7 X-FADE Completed
Select (0-9): _
```





Shows you can select a function.

(Display says Cancelled if you pressed NO in step 7.)

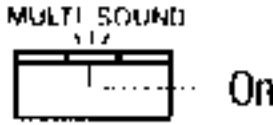
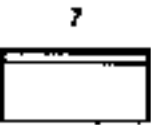

```
F7 X-FADE Cancelled
Select (0-9): _
```

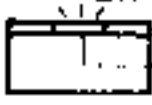
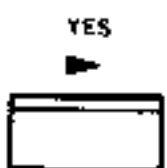
Shows you can select a function.

**B. Using the back-and-forth function.**

Operation	Operation of DSS-1
<p>① Select the MULTISOUND mode.</p>	<p>● Indicates MULTISOUND mode.</p> 
<p>① Press the number 7 key.</p> <p>Press  →</p>	<p>● The display gives you a choice of X-FADE or BACK &amp; FORTH.</p> <p>Shows the loop process function.</p>  <p>ENTER  — Flashes — Shows you can choose cross-fade or back &amp; forth.</p>
<p>② Press the YES cursor key to move the cursor to the BACK &amp; FORTH (back-and-forth) position.</p> <p>Press  →</p>	 <p>Shows back &amp; forth selected.</p>

3. Press ENTER after you confirm back-and-forth selection.

Press  after the confirmation 

- You are prompted to press ENTER if you wish to execute the function.

Shows back & forth.

F7 BACK & FORTH LOOP  
Press ENT to Execute

 - Flashes while waiting for you to press ENTER.

4. Press ENTER.

Press  

- The back-and-forth transformation is performed and the display asks if you want to keep the sound.

F7 This Will Take  
a while

F7 Make This Sound  
Permanent ? (Y/N)\_

⑤: If you want to keep the results of the back-and-forth processing, press YES.



★ Press NO if you do not want to keep the sound.



- The display asks if you want to try again.

```
F7 Completed
  Retry ? (Y/N)_
```

- The result is cancelled and the sound is restored to its condition prior to execution of the back & forth operation.
- You are asked if you would like to try a back & forth operation again.

Display during restoration of sound data.

```
F7 This Will Take
  a While
```



```
F7 Cancelled
  Retry ? (Y/N)_
```



⑥ Press YES if you wish to try again.



★ Press NO to quit.



- This takes you back to step③:

- You can now select another function or change modes.

(The display says Completed if you pressed YES in step⑤.)

```
F7 Completed
Select(0-9):_
```

Shows you can select a function.

(The display says Cancelled if you pressed NO in step⑤.)

```
F7 Cancelled
Select(0-9):_
```

Shows you can select a function.

# F8 REPLACE SOUND

## 1. About the replace sound function

- This takes a sound from a disk and puts it in a particular sound number position within the multisound selected by F1.

The length of the sound within the multisound does not change. So if a shorter sound is gotten from disk and used for replacement, there will be some left over area. (See diagram.) Likewise, if the replacement is longer, then the excess is thrown out.





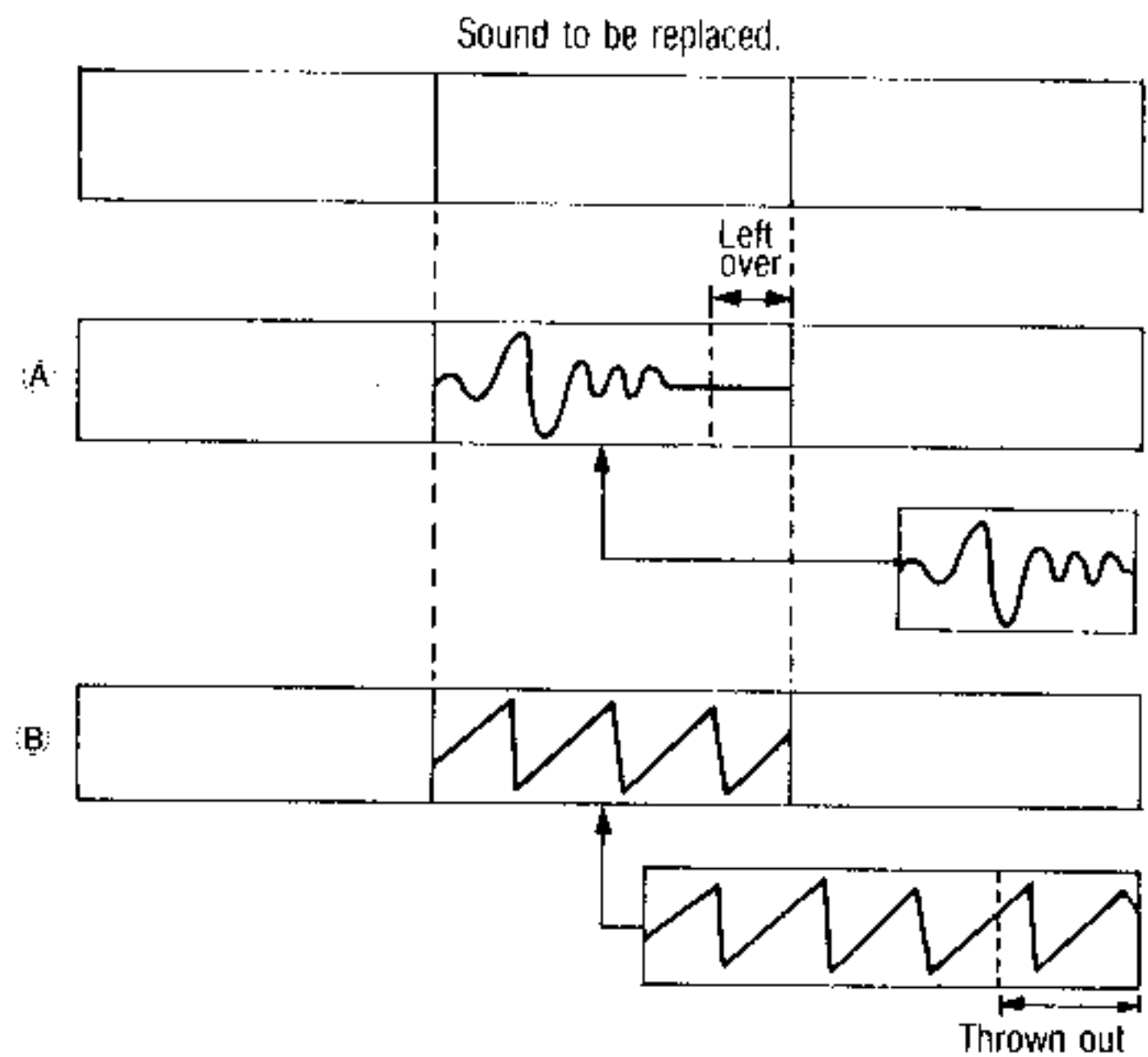
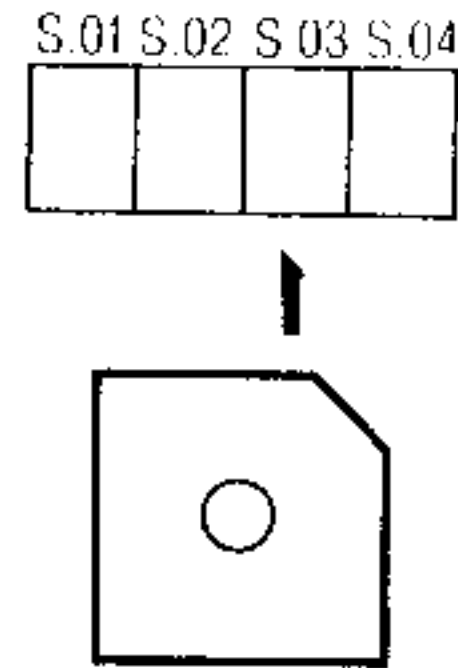

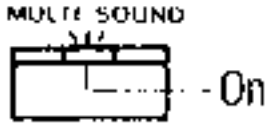
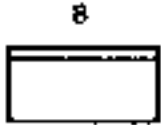

Previously set loop start/length and sound start/length parameter values are all cancelled and return to initial (default) values.

- The multisound name appears when you operate the DATA ENTRY A controls.
- At the same time, the ENTER key LED flashes to indicate standby for selection.

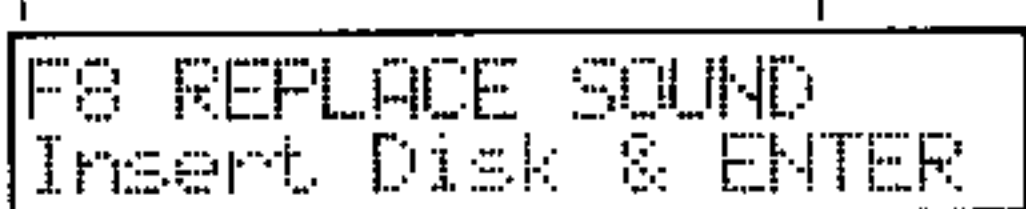
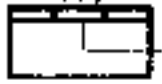

MULTISOUND MODE

2 Using the replace sound function

Operation	Operation of DSS-1
<p>0 Select the MULTISOUND mode.</p>	<ul style="list-style-type: none"> <li>Indicates MULTISOUND mode.</li> </ul>  <p>MULTISOUND On</p>
<p>① Press the number 8 key.</p> <p>Press  </p>	<ul style="list-style-type: none"> <li>You are prompted to insert a disk and press ENTER.</li> </ul> <p>Shows the replace sound function.</p>  <p>F8 REPLACE SOUND Insert Disk &amp; ENTER</p>  <p>ENTER Flashes while waiting for you to insert disk.</p>
<p>② Take the disk that has the sound that are going to use for replacement. Put the disk in the drive. Press the ENTER key.</p> <p>Press  after insert- ing disk </p>	<ul style="list-style-type: none"> <li>After logging onto the disk, the display tells you that you can use the DATA ENTRY A controls to select a sound.</li> </ul>  <p>F8 Searching for SOUNDS on Disk</p>   <p>F8 Use DATA ENTRY A Select&amp;Press ENTER</p>

③ Use DATA ENTRY A to select a sound to use for replacement.

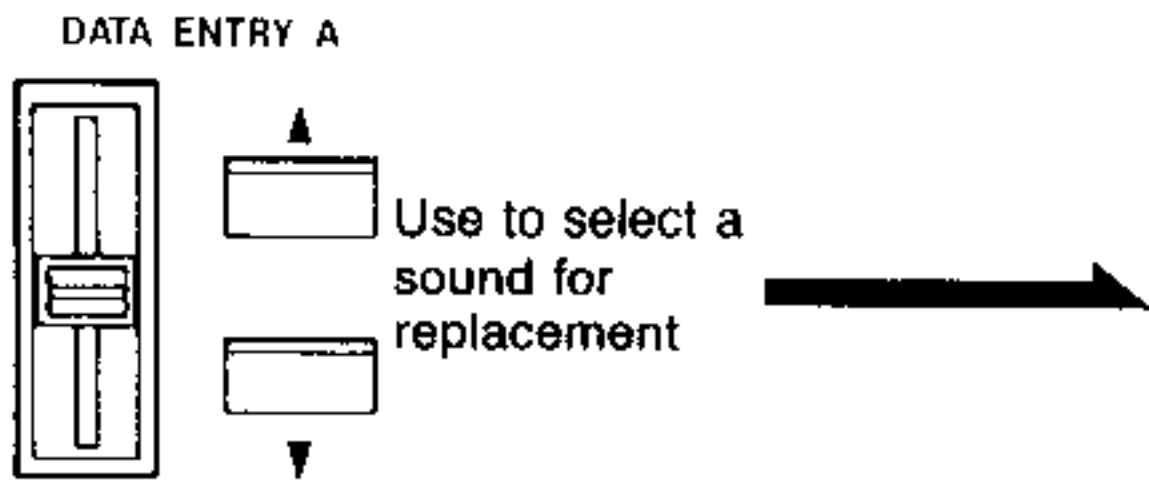

```
F8 Select SOUND
SOUND#01:TEST-#01
```

Shows selected sound's name.

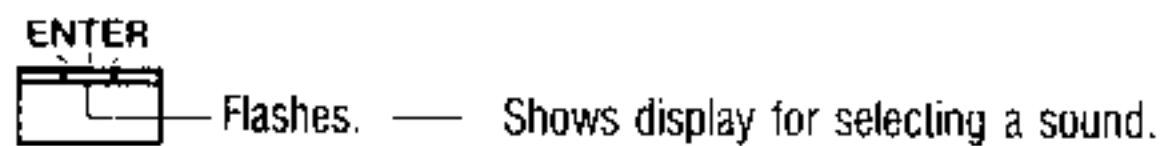

Example: Sound number 01 will be changed to TEST-#01 from disk.

④ Press ENTER to input your choice.



- The selected sound's actual length and sampling frequency are obtained from the disk and shown on the display. You are asked if it is okay to load that sound.

Display while obtaining data about sound from disk.

```
F8 Loading...
Please wait a minute
```

Selected sound's name. Asks for reply of YES or NO.

```
F8 Get TEST-#01(Y/N)
L=000121 SF=32kHz ?
```

Actual length of selected sound.

Sampling frequency of selected sound.

- 5 Confirm the sound and press YES to go ahead and use it for replacement.



- After loading and replacement, you are asked if you want to retry.
- Asks if you wish to try replacement again.

```
F8 Loading...
Please Wait a Minute
```



```
F8 Loading Completed
Retry ? (Y/N) _
```

- ★ If you don't want to use that sound to replace the one in memory, press the NO key.



- Sound replace function is cancelled.
- This aborts the function. You can now choose another function or change modes.

```
F8 Aborted
Select (0-9): _
```

 Shows you can select a function.

6 Press YES to do it again.



★ Press NO to quit.



● This takes you back to the situation after step 1. You can proceed from step 2.

● You can now choose another function or change modes.

```
F8 Loading Completed
Select (0-9):_
```

Shows you can select a function.



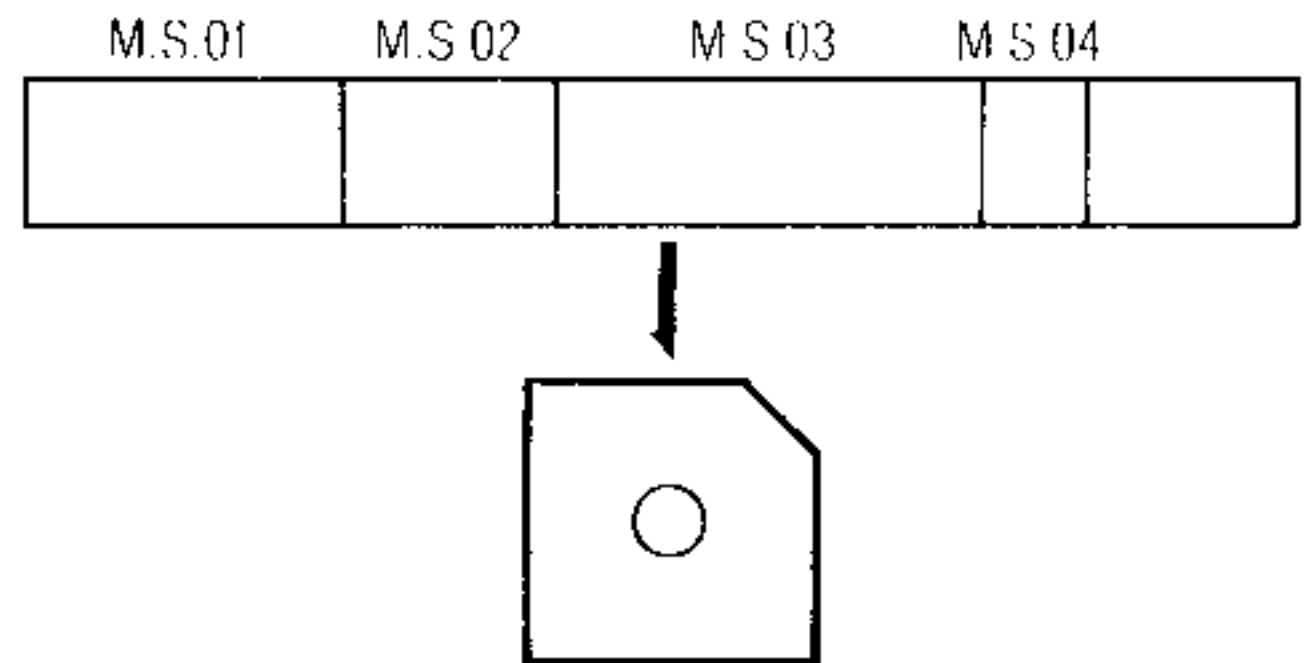

# F9 SAVE/RENAME M.SOUND

## 1 About the save rename M. sound

- This lets you name or rename and save to disk a multisound selected by F1 or newly created by F0, or another function.



## 2 Using the save rename M. sound function

Operation	Operation of DSS-1
<p>① Select the MULTISOUND mode.</p>	<ul style="list-style-type: none"> <li>● Indicates MULTISOUND mode.</li> </ul> 
<p>② Press the number 9 key.</p> <p>Press  </p>	<ul style="list-style-type: none"> <li>● The display shows the current name and asks if you want to change it.</li> </ul> <p>Shows the current name.</p> 

② Press YES if you want to go ahead and change the name.



★ Press NO if you do not want to rename the multisound.



● You can now rename.

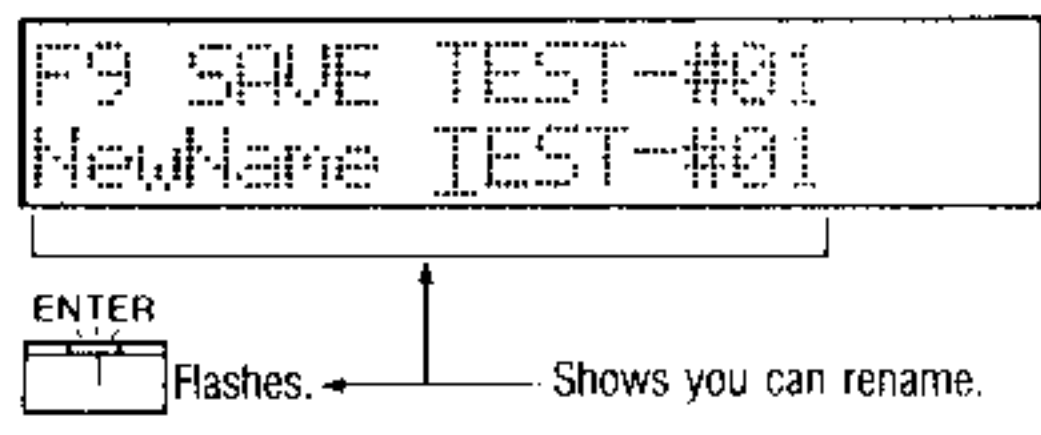

● You are asked if you want to save the sound. The upper display line shows the name and length.

(Skip to step 5)

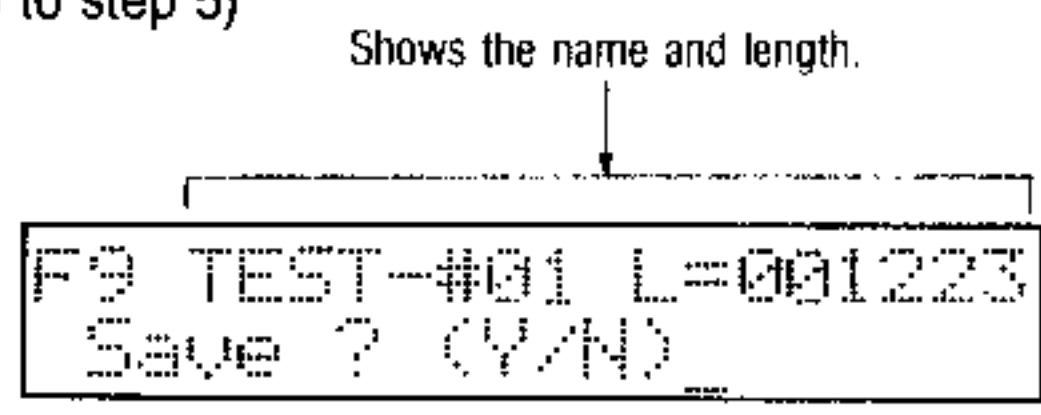

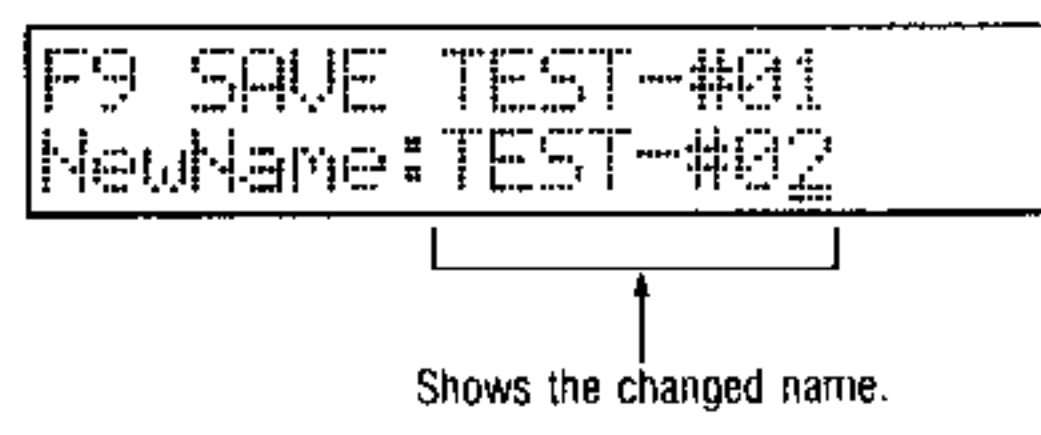
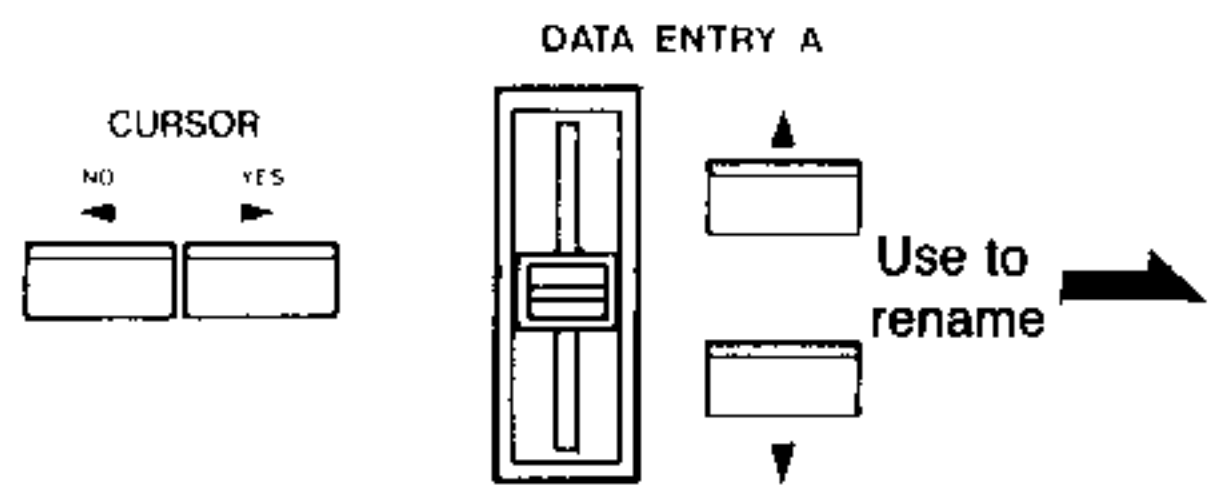

③ Use the CURSOR keys and DATA ENTRY A to change the name.





4. Press ENTER to execute.

Press  after the renaming 

- The new name is registered in the resident system. (This completes renaming.)
- You are asked whether it is okay to save the multisound under the new name.

Shows the renamed multisound to save.

```
F9 TEST-#02 L=001223
Save ? (Y/N) _
```

5. Press YES if you want to save.

Press  

- After save is completed, you can choose another function or change modes.

```
F9 Saving...
Please Wait a Minute
```

```
F9 Saving Completed
Select (0-9): _
```

Shows you can select a function.

★ Press NO if you do not wish to save the multisound.



- This aborts the function.
- You can now choose another function or change modes.

```
F9  Aborted
      Select (0-9):_
```

Shows you can select a function.



■ If you press YES in step ⑤, then the DSS-1 first checks the disk to see if the name that you entered has already been used for a multisound saved previously. If it finds a multisound of the same name, then it asks you whether it is okay to delete that multisound or not. It can only save the multisound from wave memory using the same name if it first deletes the multisound of that name on the disk. This is why it

- If a multisound of the same name exists already on disk, then the following display appears.

Name of multisound on disk to be deleted.

```
F9 M. SND:TEST-#02
      Delete Old ? (Y/N)_
```

Asks question.

Operation	Operation of DSS-1
<p>Use the YES or NO key to reply.</p> <p>★ Press YES key if you wish to delete the multisound on the disk that has the same name.</p> <p>Press </p>	<ul style="list-style-type: none"> <li>● The DSS-1 deletes the multisound on the disk and then saves the multisound from wave memory to disk under that name.</li> <li>● After saving, the function is completed and you can select another function or change modes.</li> </ul> <p>While deleting</p> <pre data-bbox="1278 1153 1975 1281">F9 M. SND: TEST-#02 Deleting...</pre> <p>While saving</p> <pre data-bbox="1278 1388 1975 1515">F9 Saving... Please Wait a Minute</pre> <p>Display when saving has been completed.</p> <pre data-bbox="1278 1643 1975 1784">F9 Saving Completed Select (0-9): _</pre> <p>Shows you can select a function.</p>
<p>★ If you do not wish to delete the multisound on the disk, then press the NO key.</p> <p>Press </p>	<ul style="list-style-type: none"> <li>● Cancels deletion of the multisound on the disk and aborts saving of the multisound from wave memory.</li> <li>● Indicates that delete and save operations have been aborted.</li> </ul> <pre data-bbox="1278 2468 1975 2596">F9 Aborted Select (0-9): _</pre> <p>Shows you can select a function.</p>

# PROGRAM PARAMETER MODE

## 1. About Each of the functions\_\_\_\_\_



### FOO INITIALIZE PARAMS

#### 1 About the initialize params function

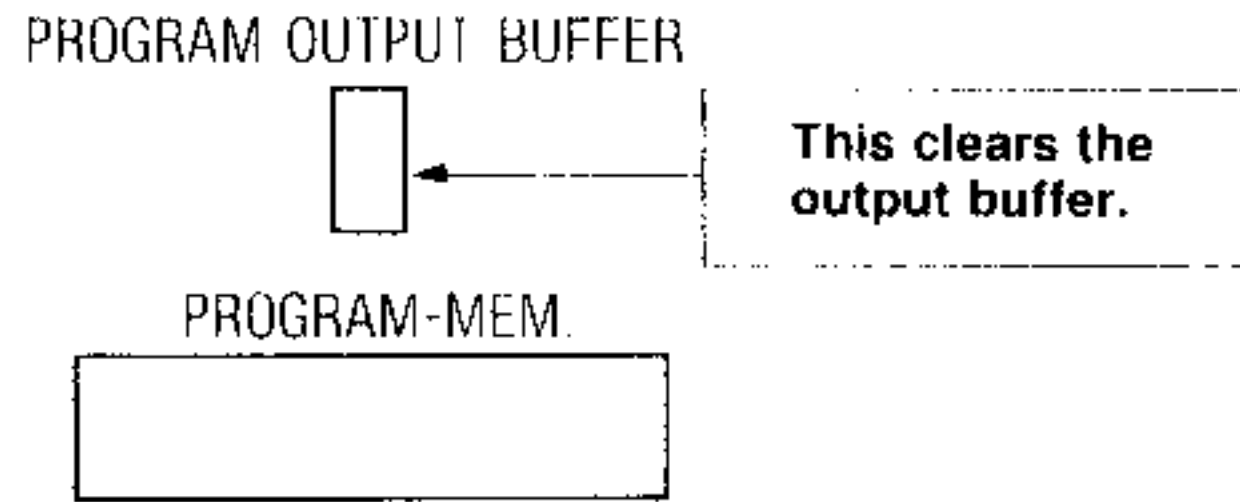
- The initialize parameters function is used to initialize (reset or clear) the data in the program output buffer. This function is required before using other modes to make multisounds.

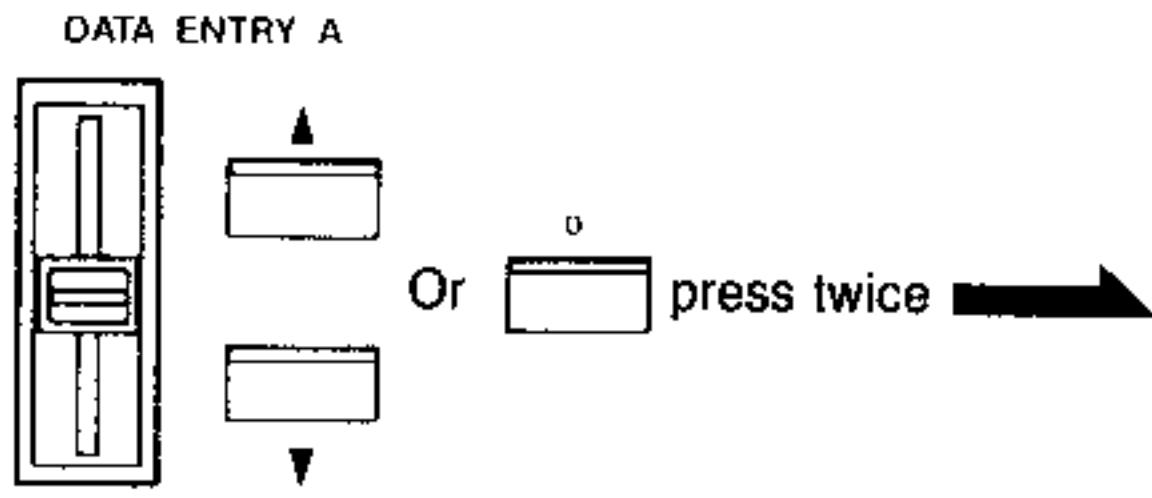
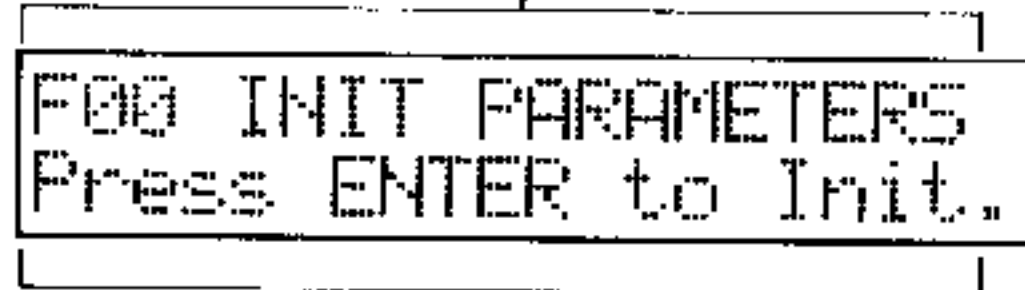

## 2. Using the initialize params function

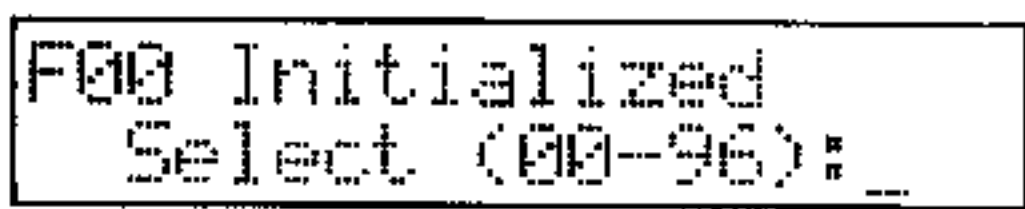
Operation	Operation of DSS-1
<p>0 Select the PROGRAM PARAMETER mode.</p>	<ul style="list-style-type: none"> <li>Indicates PROGRAM PARAMETER mode.</li> </ul>  <ul style="list-style-type: none"> <li>The display prompts you to choose a function.</li> </ul>
<p>1 Press the 0 key twice or use DATA ENTRY A to select the initialize parameters function.</p> 	<ul style="list-style-type: none"> <li>The display prompts you to initialize and press ENTER.</li> </ul> <p>Shows the initialize params function.</p>  <p>ENTER Flashes while waiting to initialize.</p>
<p>2 Press ENTER.</p> 	<ul style="list-style-type: none"> <li>This completes the function. You can now choose another function or change modes.</li> </ul>  <p>Shows you can select a function.</p>

# F01 WRITE/RENAME

## 1 About the write/rename function

- This lets you take the program created in the program output buffer and write it to a program memory number of your choice.

**Note:**

If you go to the play mode after only renaming and not writing, the new program name will still be displayed. However, please remember that this name applies only to the program in the program output buffer. Do not make the mistake of assuming that this has been written to program memory.

PROGRAM OUTPUT BUFFER

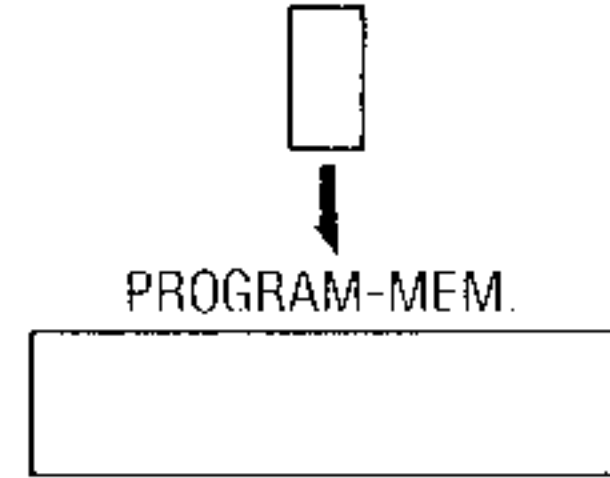

## 2 Using the write/rename function

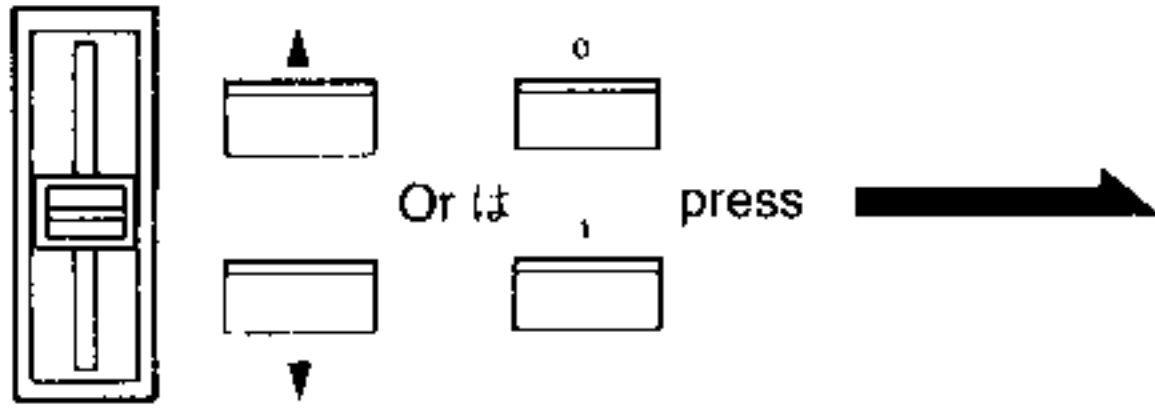
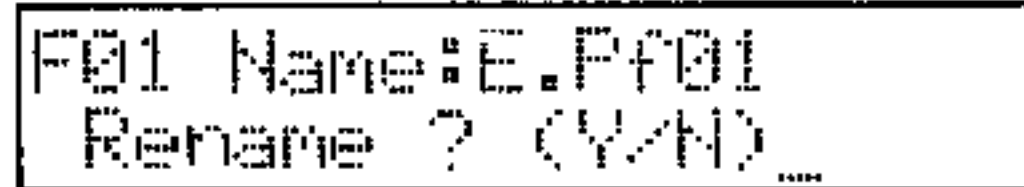
Operation	Operation of DSS-1
<p>0 Select the PROGRAM PARAMETER mode.</p>	<ul style="list-style-type: none"> <li>● Indicates PROGRAM PARAMETER mode.</li> </ul> <p>PROGRAM PARAMETER</p>  <ul style="list-style-type: none"> <li>● The display prompts you to choose a function.</li> </ul>
<p>1 Press 0 then 1, or use DATA ENTRY A to select the write/rename function.</p> <p>DATA ENTRY A</p>  <p>Or は 0 press →</p>	<ul style="list-style-type: none"> <li>● You are asked if you want to rename.</li> </ul> <p>Shows the program name to rename.</p> 

PROGRAM PARAMETER MODE

2. Press YES if you want to give the program a different name.

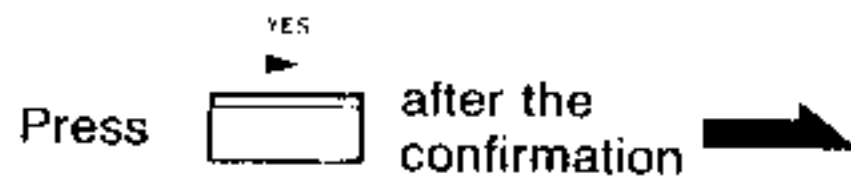

★ Press NO if you do not want to change from the current name.

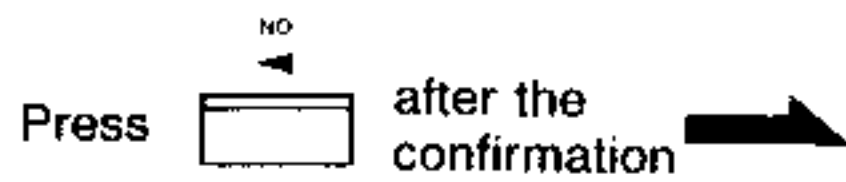

- The upper line of the display shows the current name.

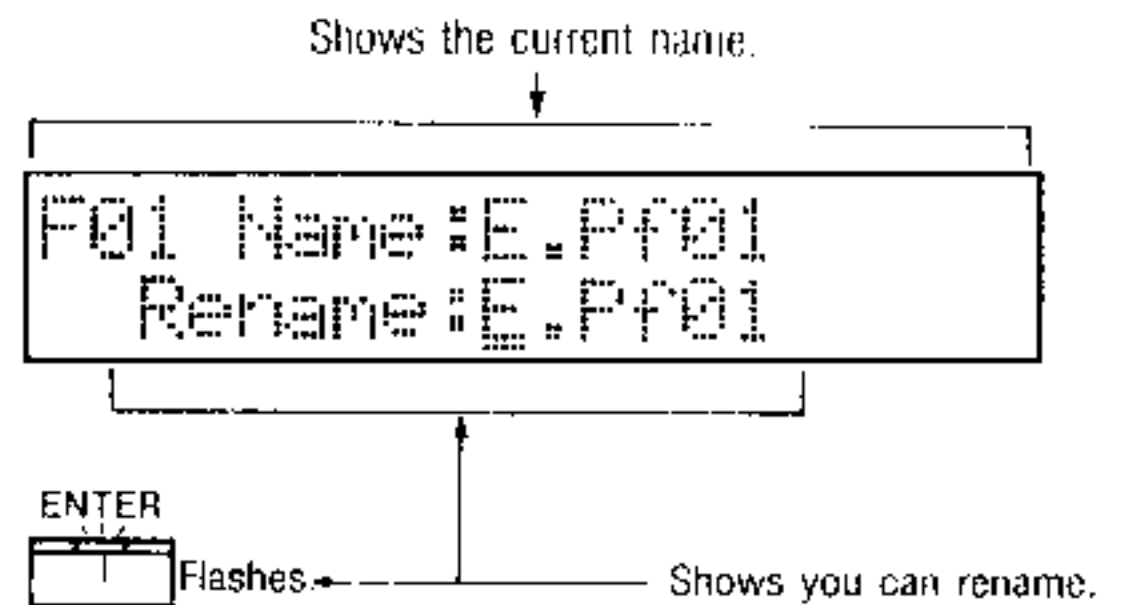

- Go to steps 3 and 4 to proceed to rename.

- This skips to selection of the program number to write to.

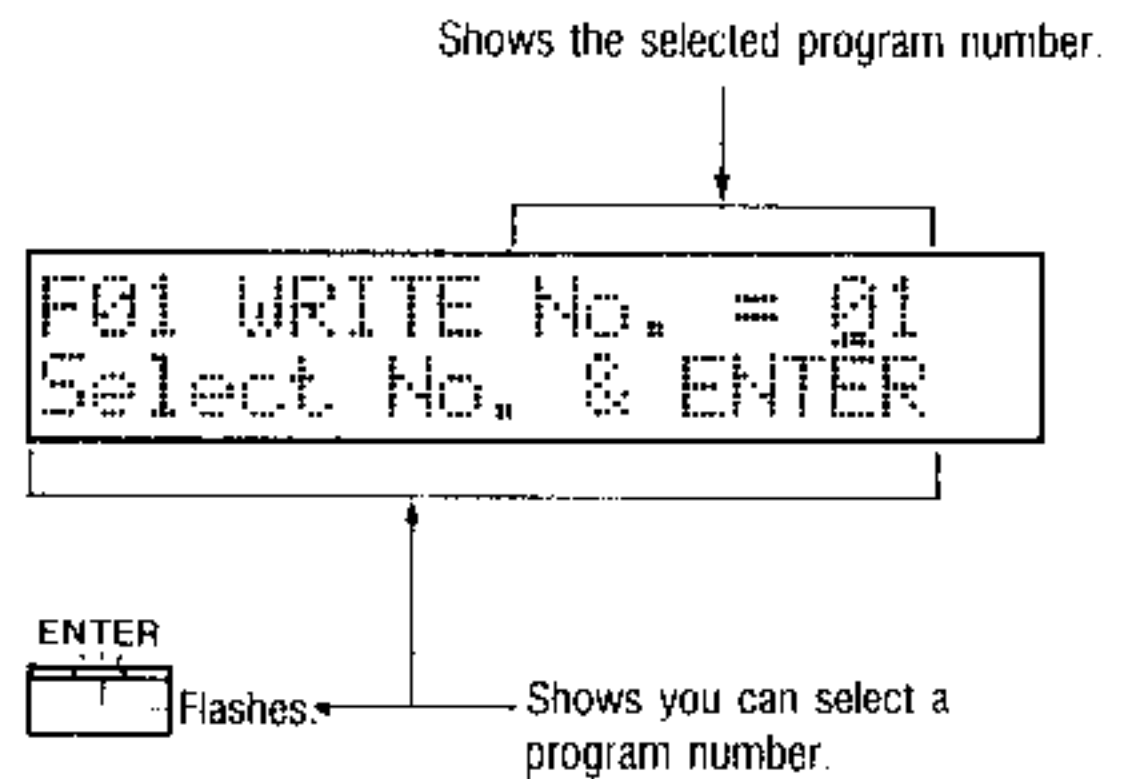

- Go step ⑤ to select a program number.

③ Move the cursor under each of the characters that you want to change. Then use DATA ENTRY B to select the character to use in the name.

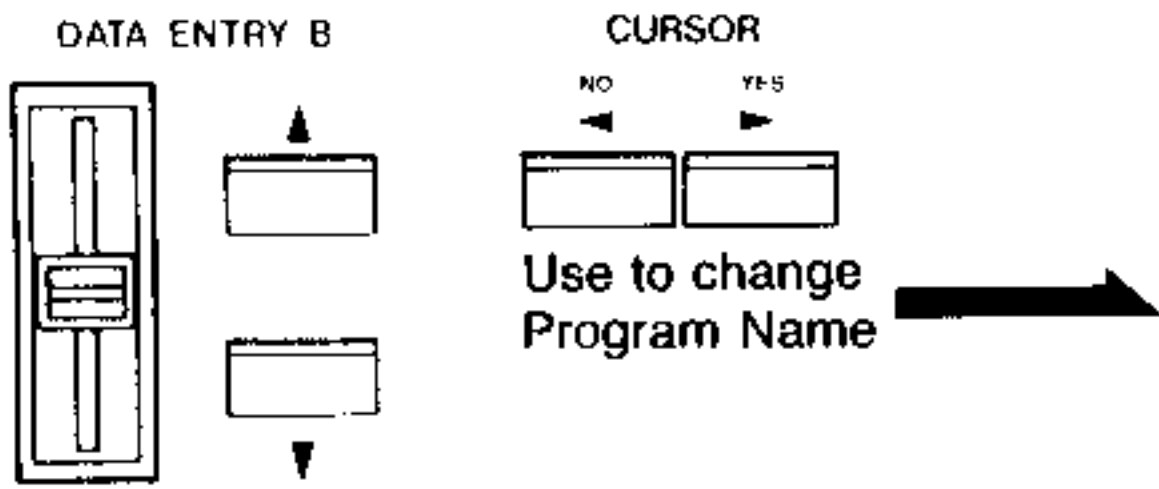

★ You can clear the name by pressing the cancel key.

● You can now change the program name.

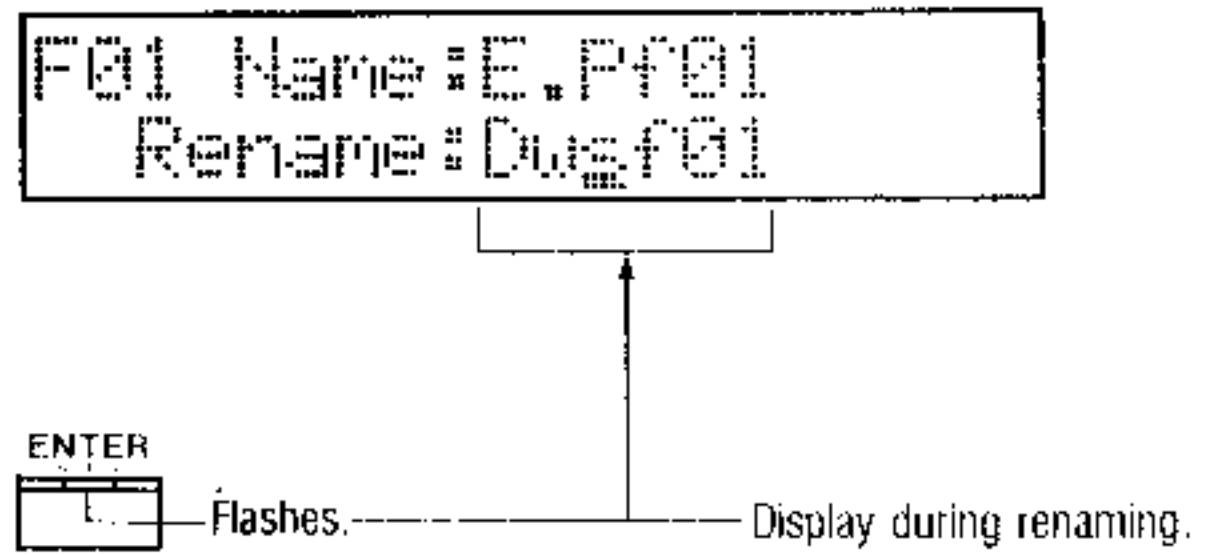

④ Press ENTER to change to the new name.



● The new name is displayed. Then you are prompted to select a program number.

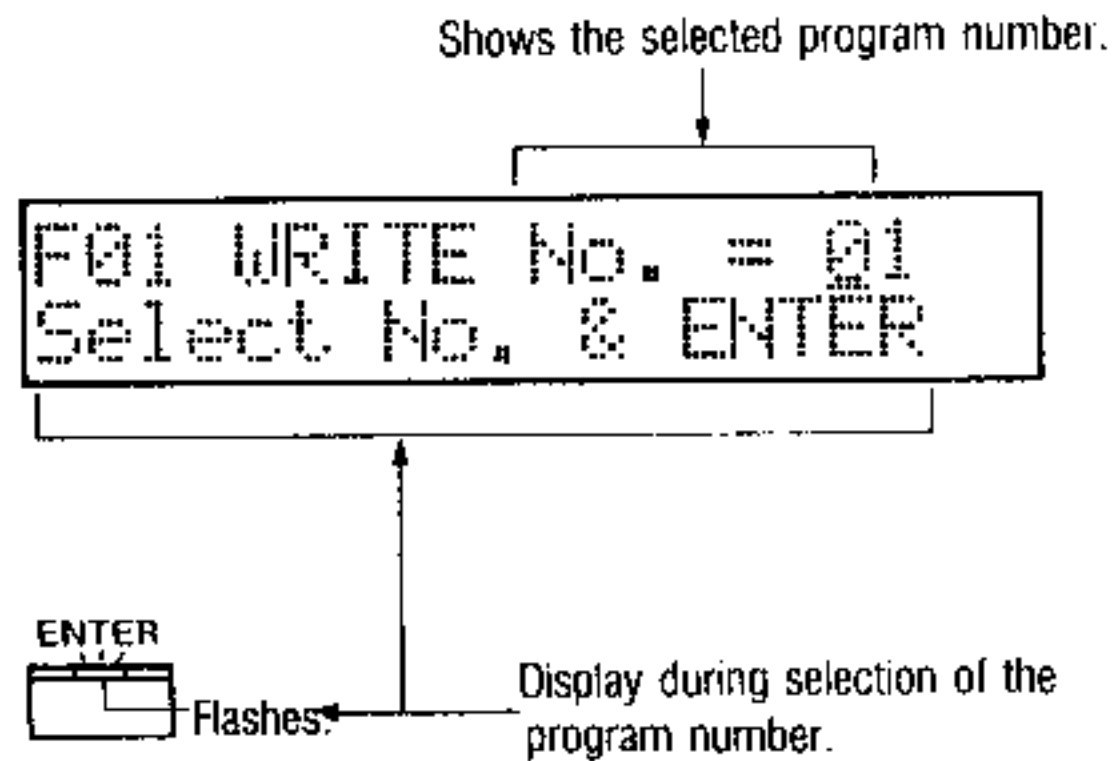



5. Use DATA ENTRY B to select the program number under which you will store the program.

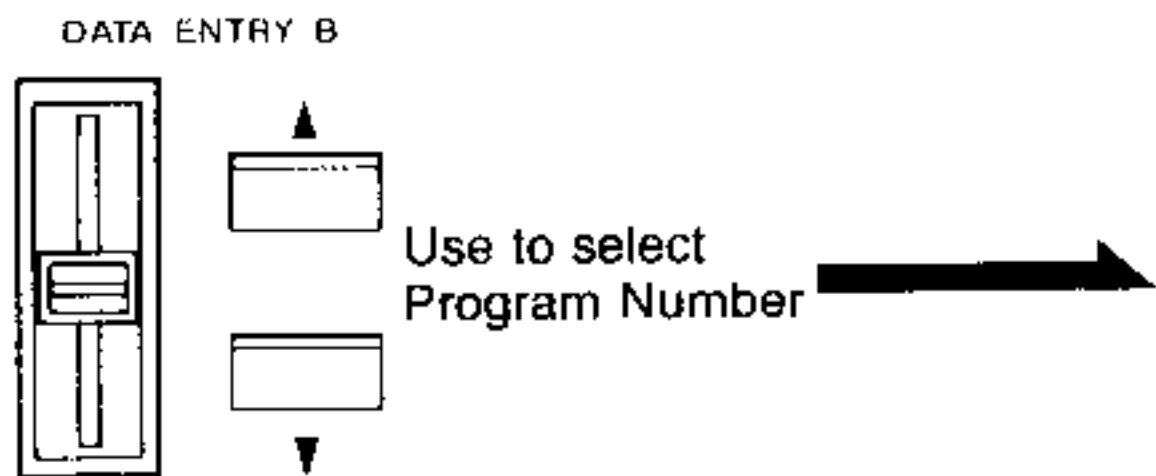

- You can now select the program number.

Shows the selected program number.

```
F01 WRITE No. = 03
Select No. & ENTER
```

- ⑥ Press ENTER to input selection.



- You are asked if it is okay to write to memory.

Shows the selected program number.

```
F01 WRITE No. = 03
Write in Mem.?(Y/N)_
```

① Press YES to write.

Press  for confirmation 

- After completion, the display asks if you wish to continue with this function.

```
F01 WRITE No. = 03
Continue ? (Y/N)_
```

★ Press NO if you check the program number and decide not to write to memory.

Press  after checking 

- You are asked if you wish to continue.

```
F01 PGM Not Written
Continue ? (Y/N)_
```

⑧ Press YES if you want to continue to use the rename/write function.



★ Press NO if you wish to quit the function.



- This takes you back to the prompt in step ①. You can continue from step ②.

- You can now choose another function or change modes.

(Display confirms writing to the program number if you pressed YES in step ⑦.)

```
F01 WRITE No. = 03
Select (00-96): _
```

Shows you can select a function.

(Display says PGM Not Written if you pressed NO in step ⑧.)

```
F01 PGM Not Written
Select (00-96): _
```

Shows you can select a function.

# OSC FUNCTION GROUP

F11 through F21 are DSS-1 oscillator control functions. These are used to select the multi-sound, octave, mix ratio, oscillator modulation, and other variables.

## F11 OSC OCT

### 1) Oscillator octave function.

■ DSS-1 multisound sounds can be assigned over the range of C#-1 to G9. Five octaves within this range correspond to the actual keyboard. The oscillator octave function lets you select which five octaves these will be. As shown in the diagram, the 16' OSC OCT setting gives you C<sub>1</sub> ~ C<sub>6</sub>, 8' gives you C<sub>2</sub> ~ C<sub>7</sub>, and 4' gives you C<sub>3</sub> ~ C<sub>8</sub>.

Possible values for OSC-1

16', 8', 4'

Possible values for OSC-2

16', 8', 4'

Total range over which sounds can be assigned.

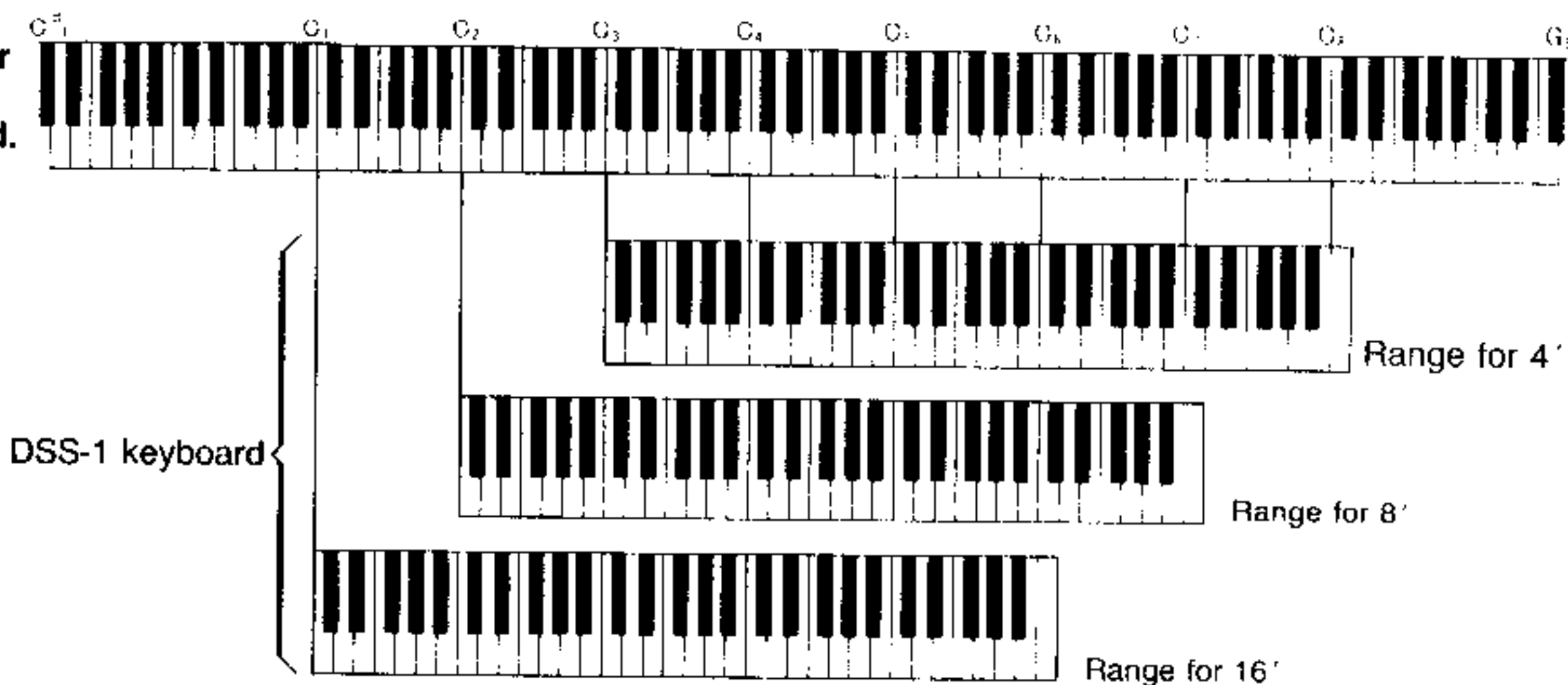

★ It is possible to set the oscillator octave so that the keyboard is shifted higher than the range covered by the assigned sounds. In this case no sound will be produced when you play the keyboard.

For example, if sounds are assigned over the area of C<sub>1</sub> ~ C<sub>7</sub> and you specify 4' for the OSC OCT value, then you will get no sound from the top keyboard octave (C<sub>7</sub> ~ C<sub>8</sub>).

Obviously you must assign sounds to octaves that you will wish to use.

### 2) Using the oscillator octave function.

■ Select the oscillator octave function by pressing 11 on the number keys or by moving the DATA ENTRY A slider.

■ Use the cursor keys to select the parameter that you wish to change (i.e., OSC1 or OSC2). Then use the data entry B slider to adjust the value.

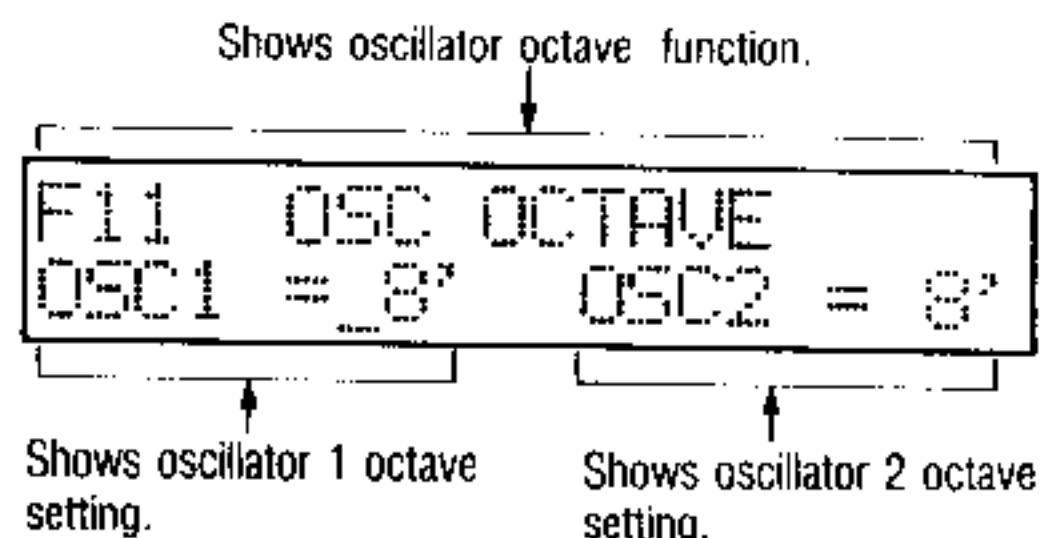

# F12 OSC1 MULTI SOUND

## 1 About the multisound function

- The oscillator-1 multisound function determines the multisounds used by OSC1.

## 2 Using the multi sound function

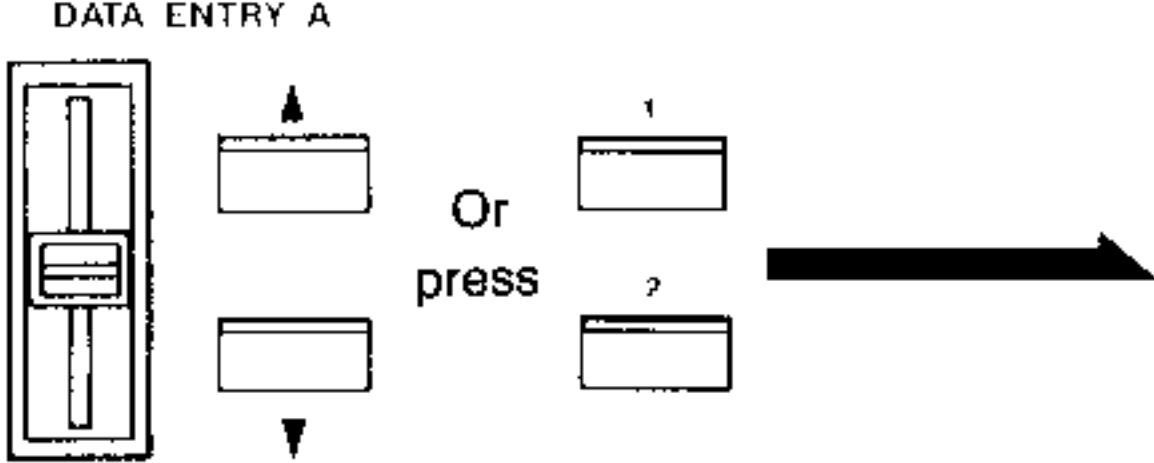
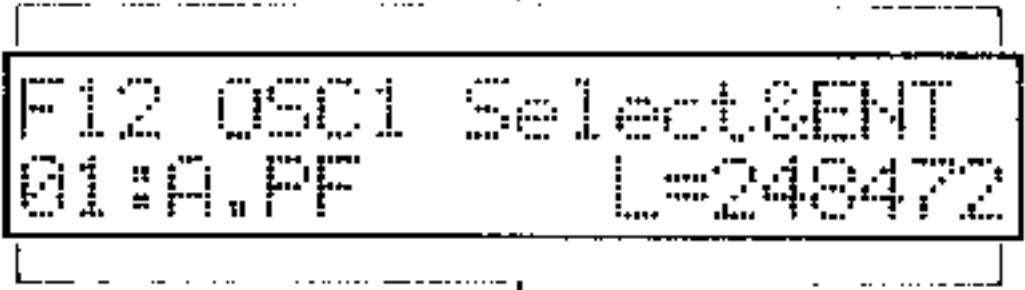
Operation	Operation of DSS-1
<p>0 Select the PROGRAM PARAMETER mode.</p>	<ul style="list-style-type: none"> <li>● Indicates the PROGRAM PARAMETER mode.</li> </ul>  <ul style="list-style-type: none"> <li>● The display prompts you to choose a function.</li> </ul>
<p>① Press 1 then 2, or use DATA ENTRY A to select the OSC1 MULTI SOUND function.</p> 	<ul style="list-style-type: none"> <li>● The display shows the currently selected multisound.</li> </ul> <p>Shows the OSC1 multisound function.</p>  <p>Shows you can select multisound.</p>

2 Use DATA ENTRY B to select a multisound.

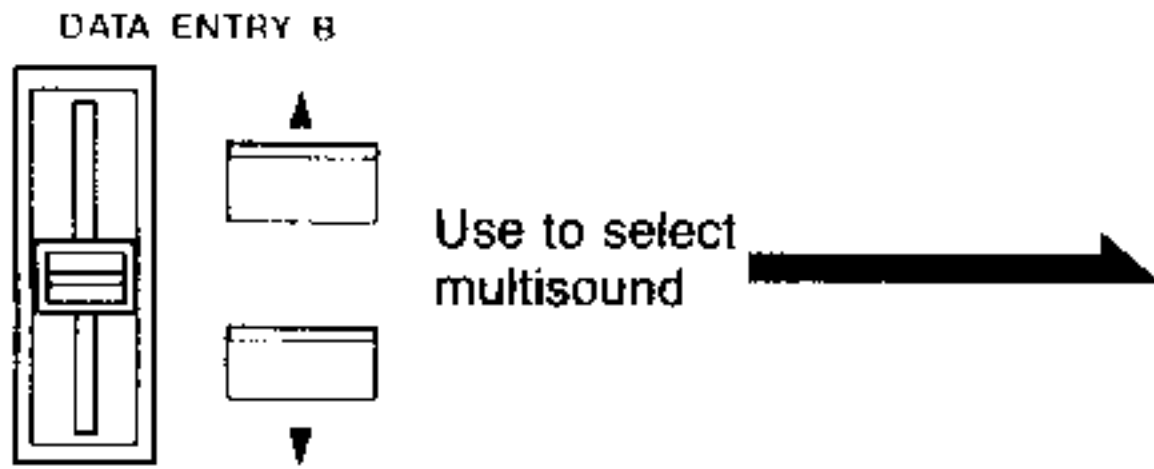

• You can now select a multisound.

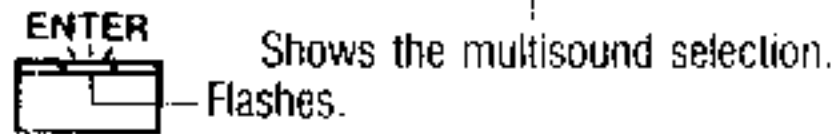
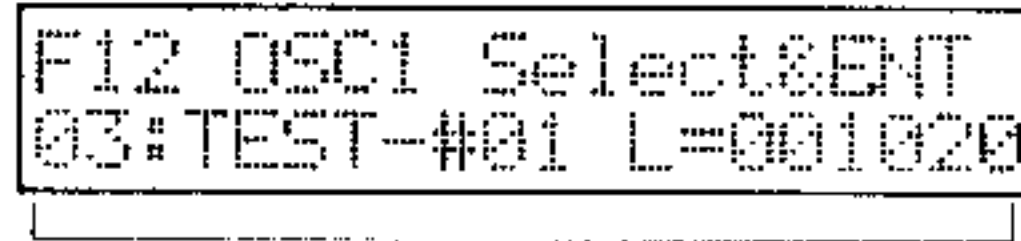

• The ENTER key normally flashes at this point. But if the displayed multisound has already been selected then the ENTER key does not flash.

3 Press ENTER to go ahead.

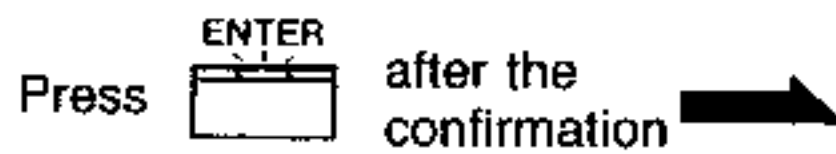

• The displayed multisound is registered and the ENTER key stops flashing.

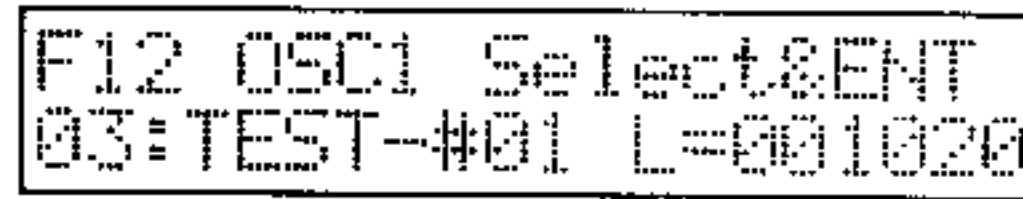

## F13 OSC 2 MULTI SOUND

### 1. Oscillator-2 multisound function.

■ Used to select the multisound for oscillator 2.

### 2. Using the oscillator-2 multisound function.

■ Refer to instructions for oscillator-1 multisound function operation.

```
F13 OSC2 Select&ENT
01:A.PF      L=248472
```

## F14 MIX RATIO

### 1. The mix ratio function.

■ Adjusts volume balance between oscillator-1 and oscillator-2.

### 2. Using the mix ratio function.

■ Press 1 then 4, or use DATA ENTRY A to select the MIX RATIO function.

■ Use DATA ENTRY B to adjust the value.

#### Possible mix ratio values

OSC 1	100%	50%	0%
	↓	↓	↓
OSC 2	0%	50%	100%

Mix ratio display.

```
F14 OSC MIX RATIO
OSC1=037% OSC2=063%
```

Values for oscillator 1 and 2 are shown.

## F15 OSC 2 DETUNE & INTERVAL

### 1. The oscillator-2 detune & interval function

■ Used to change the pitch of oscillator-2 relative to oscillator-1.

#### ● Detune:

Detuning raises the pitch of oscillator-2 very slightly so that it beats with oscillator-1, thereby making a fatter sound or chorus-like effect.

#### ● Interval:

Here we set oscillator-2 at a note higher than oscillator-1, so that the difference in pitch produces an interval. Note that this shifts the whole keyboard range up, much like the effect of the F11 OSC OCT function. While the oscillator octave function shifts the keyboard range in octave steps, the interval function shifts it in semi-tone steps.

#### Possible detune values

00~63

#### Possible interval values

00~11

2) **Using the oscillator-2 detune & interval function.**

■ Press 1 then 5, or use DATA ENTRY A to select the OSC DETUNE & INTERVAL function.

■ Move the cursor to the parameter that you wish to change. Use DATA ENTRY B to change the value.

Display for oscillator-2 interval & detune function.

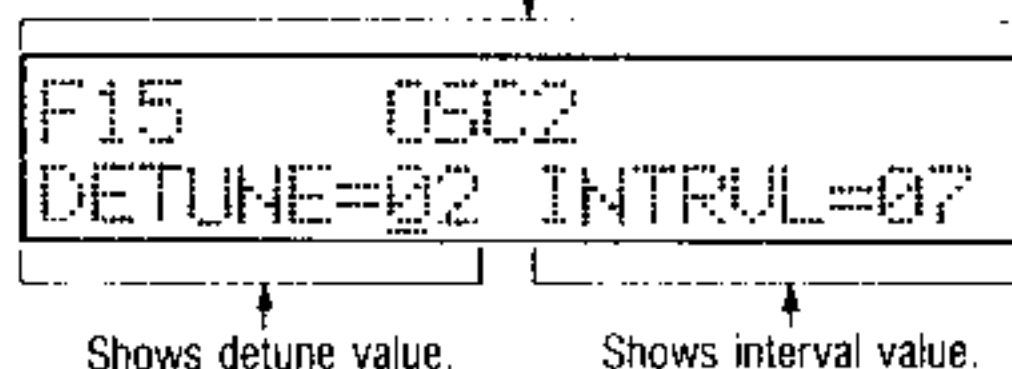

## F16 SYNC MODE, D/A RESOLUTION

1) **Sync mode, D/A (digital-to-analog) resolution function.**

■ This function allows you to generate various special effects by synchronizing the oscillators and changing the D/A resolution.

● **Sync mode:**

As the DSS-1 reads the data for the oscillator-1 and oscillator-2 waveforms from memory, the sync mode can be used to force oscillator-2 readout timing to follow that of oscillator-1. This works only if both waveforms are looped.

As shown in the diagram, ordinarily the waveforms go through their cycles independently of each other. If you turn the sync mode on, then the oscillator-2 waveform will be restarted whenever the oscillator-1 waveform is restarted. This creates complex harmonics in the oscillator-2 waveform. Sync is particularly effective when used in combination with other effects such as oscillator modulation (vibrato) and autobend.

● **D/A resolution:**

This lets you change the number of bits used for conversion from the stored digital data to the analog signal used by the oscillator. Using 12 bits gives you maximum resolution, the norm. Using less than 12 bits produces a progressively rougher approximation of the original signal, at the same time adding considerable new harmonic content which may be desirable.

2) **Using the sync mode, D/A resolution function.**

■ Press 1 then 8, or use DATA ENTRY A to select the SYNC MODE, D/A RESOLUTION function.

■ Use the dursor keys to select the parameter that you wish to adjust. Then use DATA ENTRY B to change the value.

Possible sync values

OFF, ON

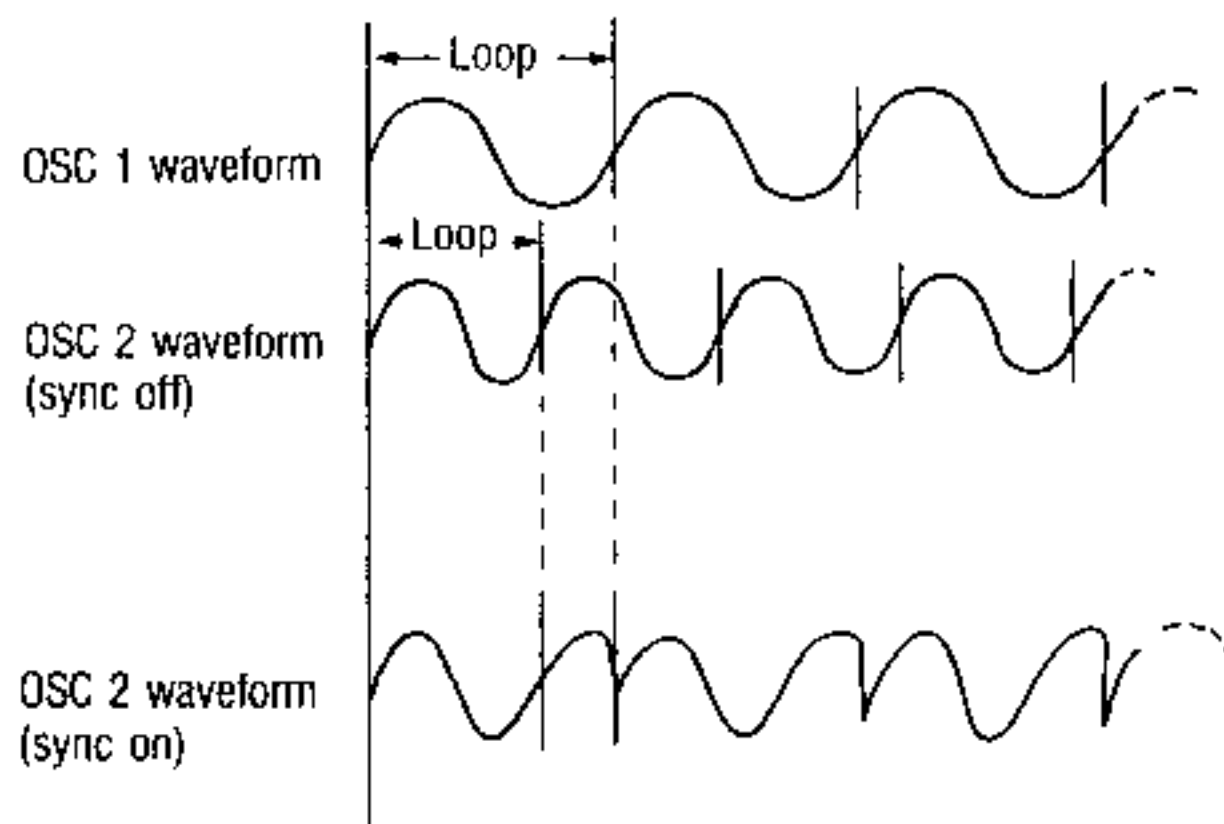

Possible D/A resolution values

6 bit, 7 bit, 8bit, 10 bit, 12 bit

Display for sync mode, D/A resolution function.

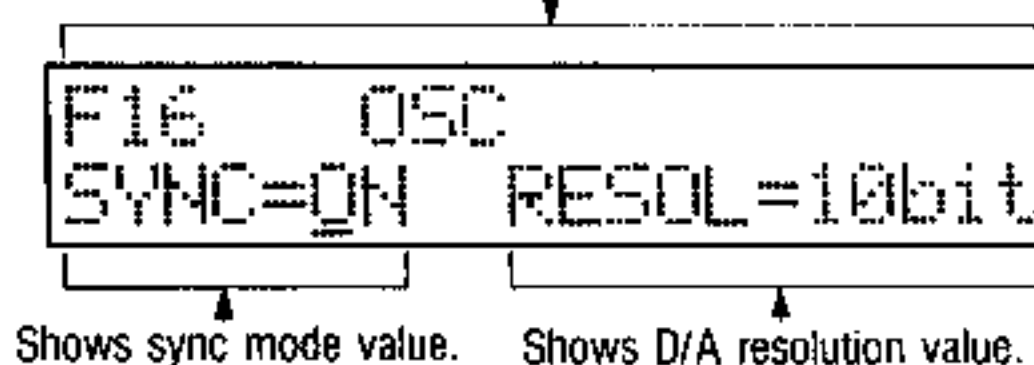



## F17 OSC MG MOD

### 1) Oscillator modulation mode function.

■ This function controls modulation of the oscillator frequency, producing various vibrato effects (regular pitch fluctuations).

Four parameters are covered, as follows:

#### ● Modulation mode:

Offers four options of which oscillators, if any, are to be affected.

#### ● Frequency:

Controls the speed of the vibrato (by adjusting the modulating signal frequency).

#### ● Intensity:

Controls the depth of modulation, that is, the amount of pitch fluctuation in the vibrato effect.

#### ● Delay:

Lets you delay the onset of the vibrato effect after you play a note.

<p><b>Possible modulation mode settings</b></p> <p>OFF, OSC 1, OSC 2, BOTH</p>
<p><b>Possible frequency values</b></p> <p>00 - 31</p>
<p><b>Possible intensity values</b></p> <p>00 - 15</p>
<p><b>Possible delay values</b></p> <p>00 - 15</p>

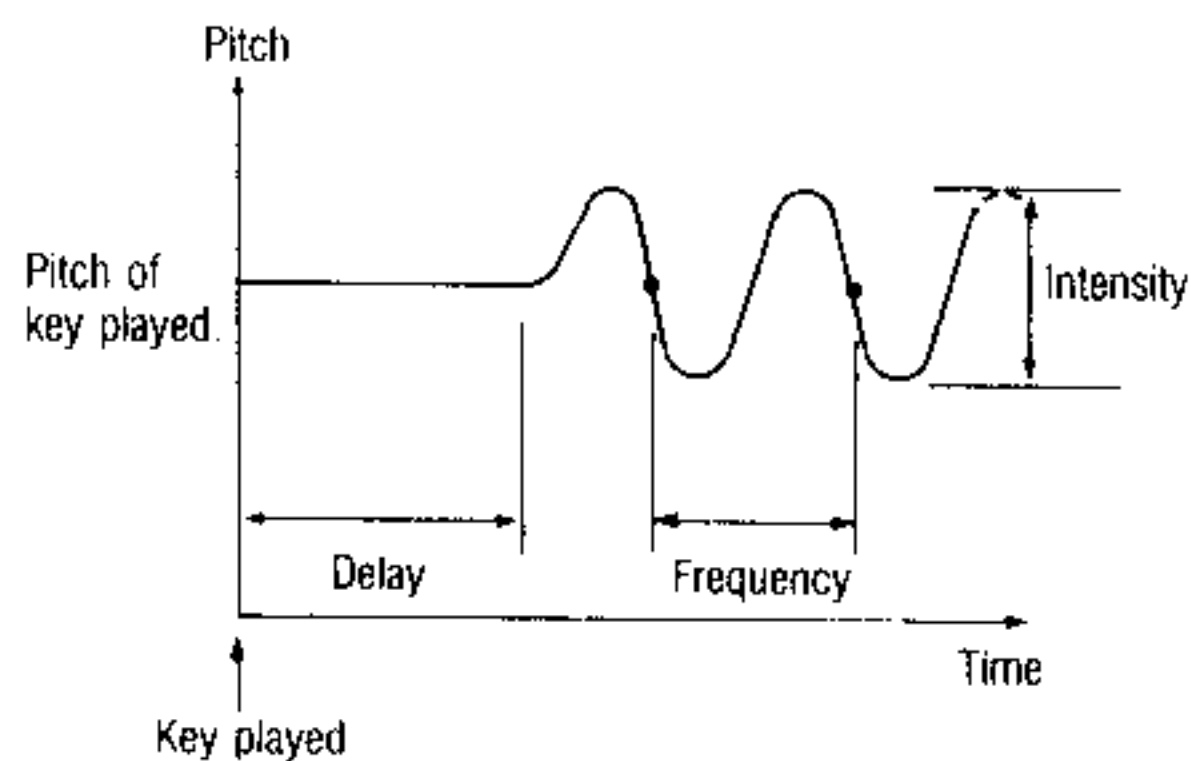

### 2) Using the oscillator modulation mode function.

■ Press 1 then 7, or use DATA ENTRY A to select the OSC MG MOD function.

■ Use the cursor keys to select parameters. Then use DATA ENTRY B to adjust the values.

Display for oscillator modulation mode function.

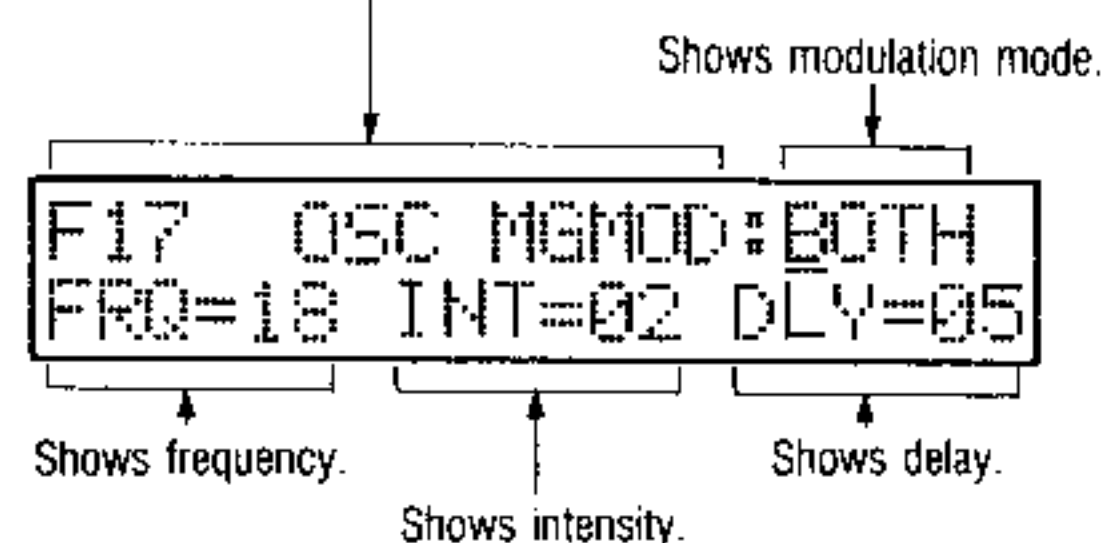

# F18 AUTO BEND MODE

## 1] The auto bend mode function

■ This function controls pitch bends produced automatically when keys are played. Pitch starts at a point above or below the normal key pitch and bends to reach the normal key pitch. This is useful for human voice and some brass instrument effects.

### ● Mode:

Lets you choose which, if any, of the oscillators will be used for the effect.

### ● Polarity:

Selects whether the pitch will bend down or up to the normal note pitch.

### Possible mode values

OFF, OSC 1, OSC 2, BOTH

### Possible polarity values

DOWN, UP

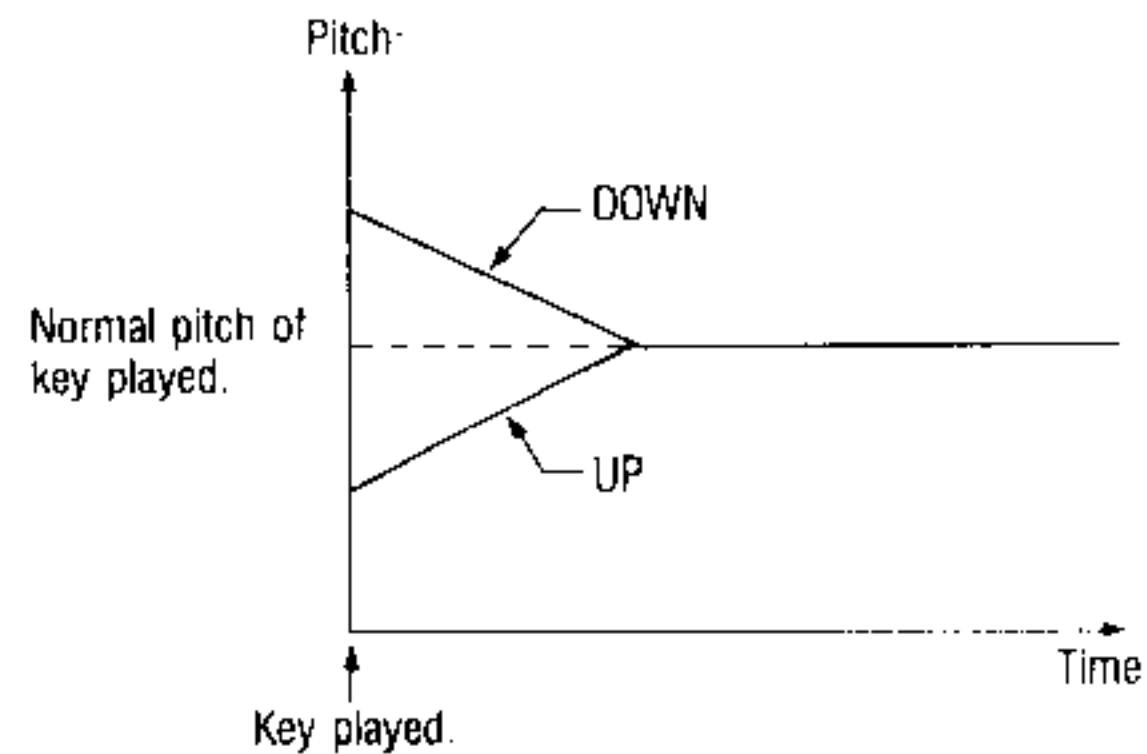

## 2] Using the auto bend mode function.

■ Press 1 then 8, or use DATA ENTRY A to select the AUTO BEND MODE function.

■ Move the cursor to the parameter that you want to change. Then use DATA ENTRY B to change the value.

Auto bend mode display.

```
F18 AUTO BEND
MODE=BOTH POL.=UP
```

Mode setting.

Polarity setting.

# F19 AUTO BEND TIME & INT

**[1] The auto bend time & intensity function.**

■ Lets you adjust the amount of pitch change and the rate at which it occurs, in relation to the auto bend mode (F18) settings for mode and polarity.

● **Time:**  
Determines the slope of pitch change. The shorter the time, the steeper the slope.

● **Intensity:**  
Determines how high or low above normal pitch the bend will start.

**Possible time values**  
00 - 31

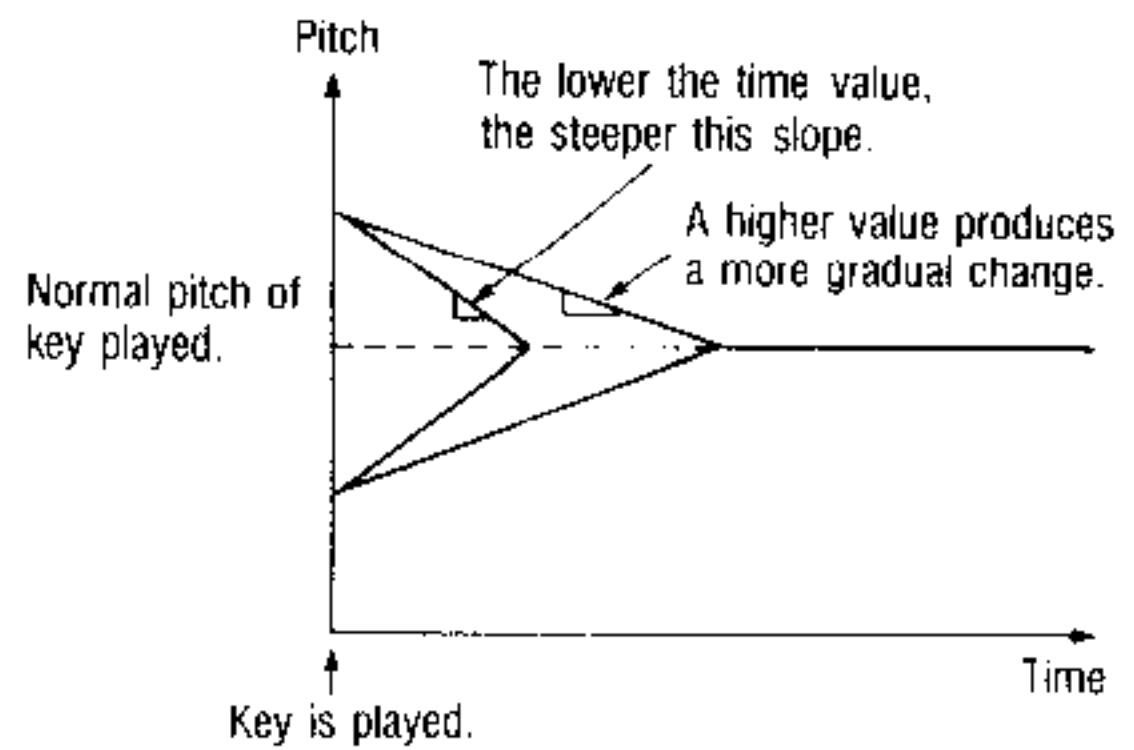

**Possible intensity values**  
000 - 127

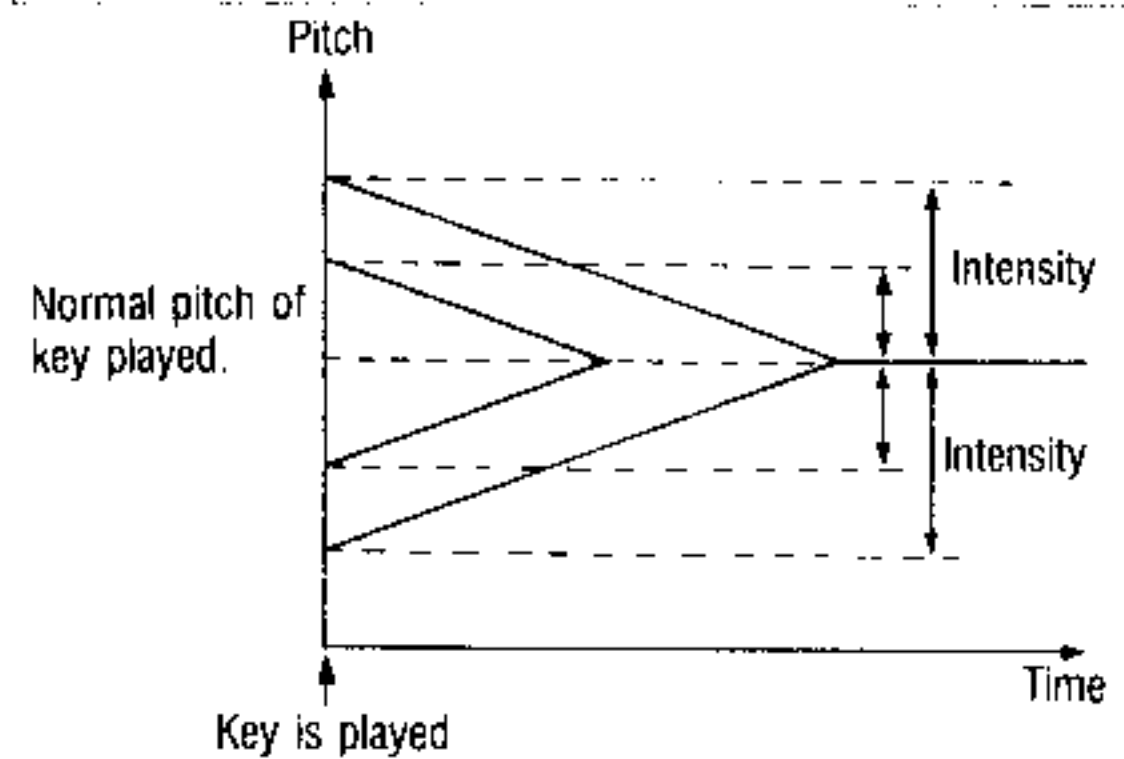

Shows auto bend time and intensity function.

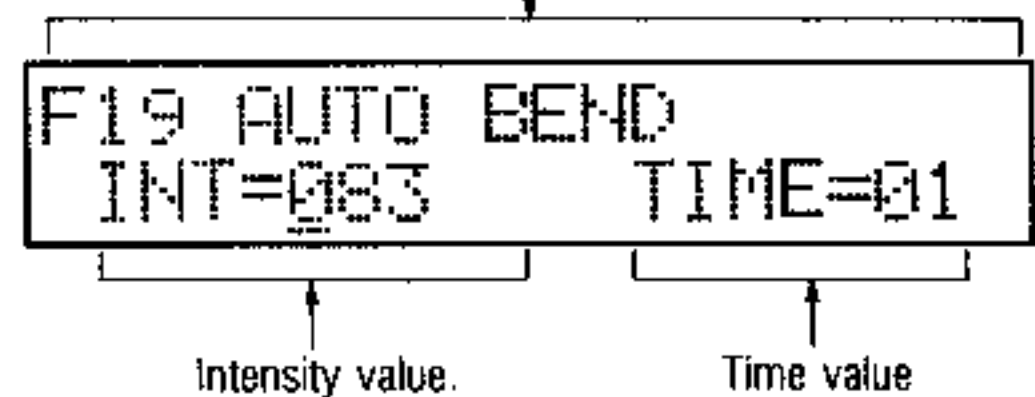

**[2] Using the auto bend time & intensity function.**

■ Press 1 then 9, or use DATA ENTRY A to select the AUTO BEND TIME & INTENSITY function.

■ Use the cursor keys to select a parameter. Then use DATA ENTRY B to adjust its value.

■ **Note:** if the intensity value is too high when in the auto bend down mode, then pitch may not change initially when some keys are played. This condition is indicated by a "W" in the display.

This occurs when the intensity setting pushes the pitch bend starting point beyond the "pitch transpose upper limit" (determined by the relationship between sampling frequency and readout frequency) of the sound assigned to that part of the keyboard.

A sound with a sampling frequency of 32kHz, for instance, will have a "pitch transpose upper limit" of one octave. If you take such a sound and raise the intensity setting too high, then you get this situation with some keys in the sound's assigned range.

● Intensity too high for sound.

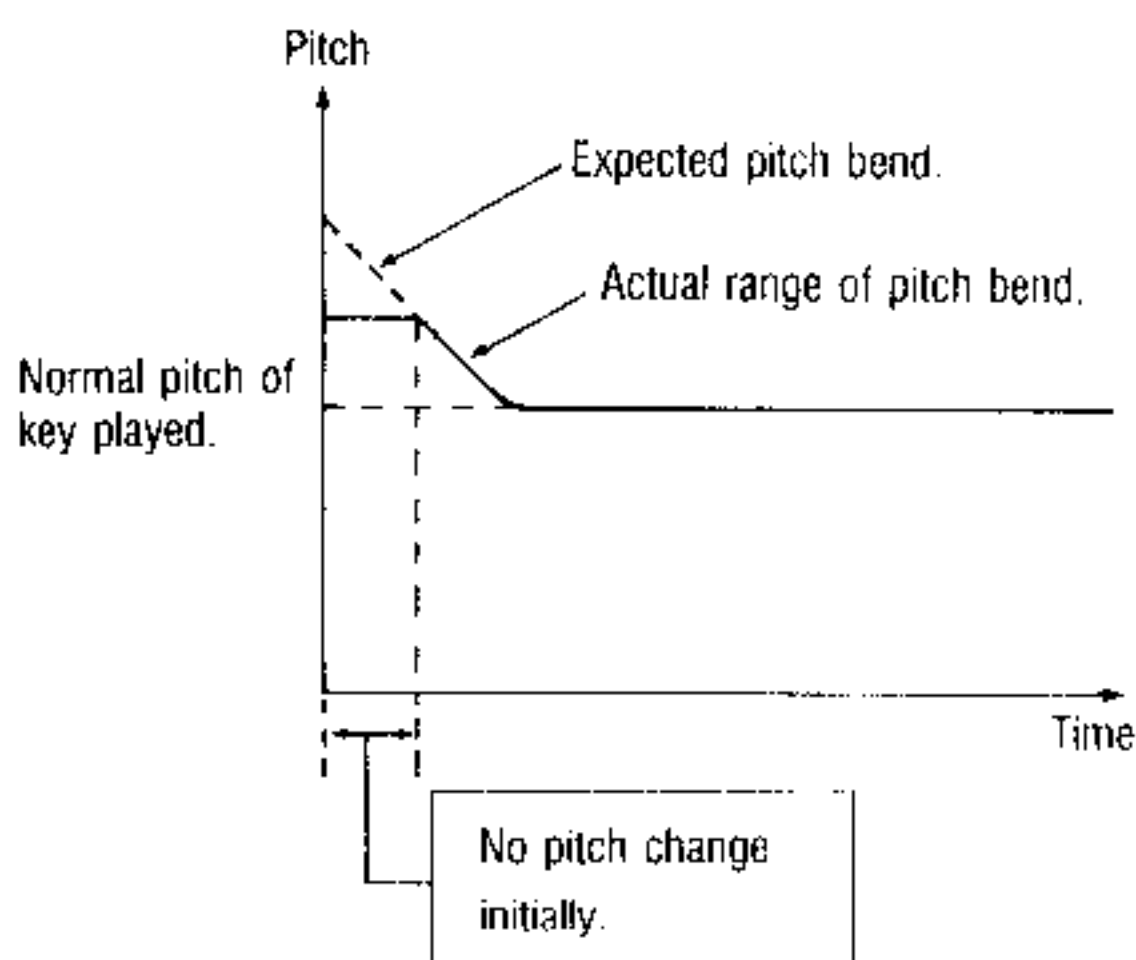

A "W" appears in the display if keys producing this effect appear within the keyboard.

```
F19 AUTO BEND
INT=015:W TIME=10
```

Indicates warning.

## F21 NOISE LEVEL

### 1 About the noise level function.

■ As a sound source in addition to oscillator-1 and oscillator-2, you can also access white noise. This is a random waveform that includes all audio frequencies. Useful for adding "breath noise" to wind instrument sounds and for effects like wind, surf, and gunshots.

### 2 Using the noise level function.

■ Press 2 then 1, or use DATA ENTRY A to select the NOISE LEVEL function.

■ Use DATA ENTRY B to adjust the value.

#### Possible noise level values

00~63

Noise level display.

```
F21 WHITE NOISE
LEVEL = 00
```

Current value.

#### Note:

If no multisound is assigned to the keyboard (when power is first turned on or if sounds have been erased), then only the lowest octave on the keyboard will produce noise.

# VCF FUNCTION GROUP

F31 through F35 are the DSS-1 VCF control functions. The voltage controlled filters (VCF) can be used to affect tone color or timbre. This is achieved by removing or emphasizing portions of the harmonic structure of the waveforms from the three sound sources (oscillator-1, oscillator-2, noise). These are low pass filters. They attenuate frequencies above the cutoff frequency.

## F31 VCF MODE & EG POL

### 1] The VCF mode & EG polarity function

■ The VCF mode refers to the steepness of the filter cutoff slope. EG polarity comes into effect only if you use the envelope generator to modulate the VCF, in which case this determines whether the filter cutoff frequency will be swept up or down during the attack.

#### ● VCF mode:

Choose from  $-12$  decibels per octave attenuation or  $-24$ dB/oct. The steeper  $-24$ dB setting cuts off more harmonics and creates more obvious filter modulation effects. Given the same cutoff frequency, the  $-12$ dB setting will produce a somewhat brighter sound, since it attenuates more gradually, passing more harmonics above the cutoff.

#### ● EG polarity:

When using the envelope generator to control the filter cutoff frequency, you can set polarity to positive or negative. The positive setting is used for conventional effects in which the sound becomes brighter during the attack.

Possible VCF mode settings.

24dB, 12dB

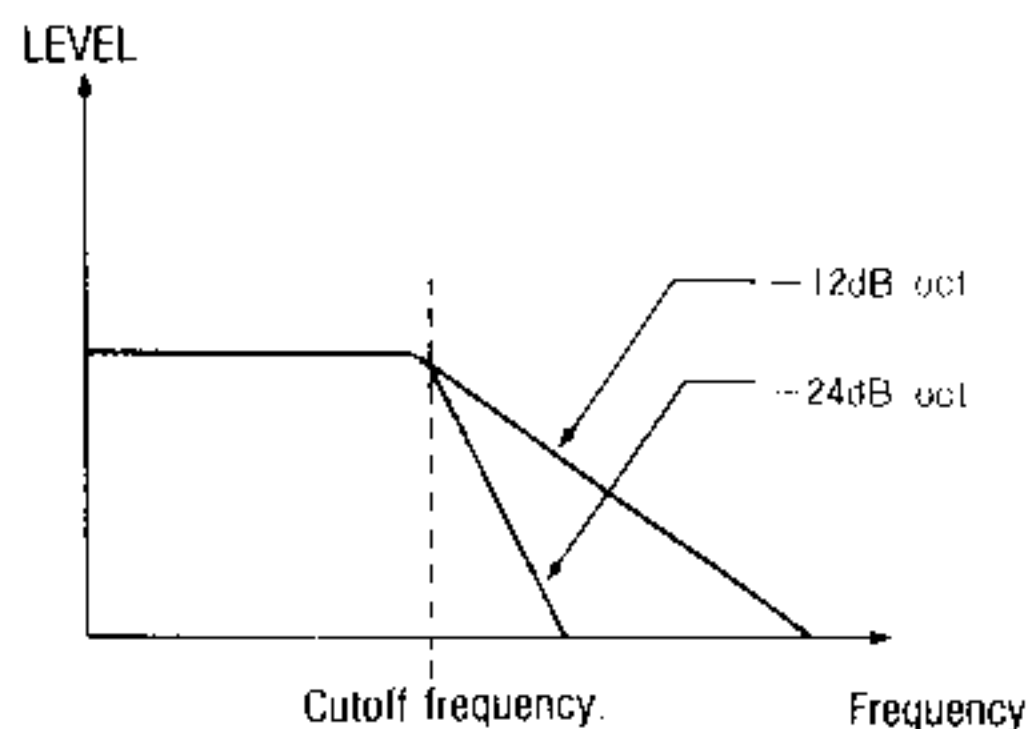

Possible EG polarity settings.

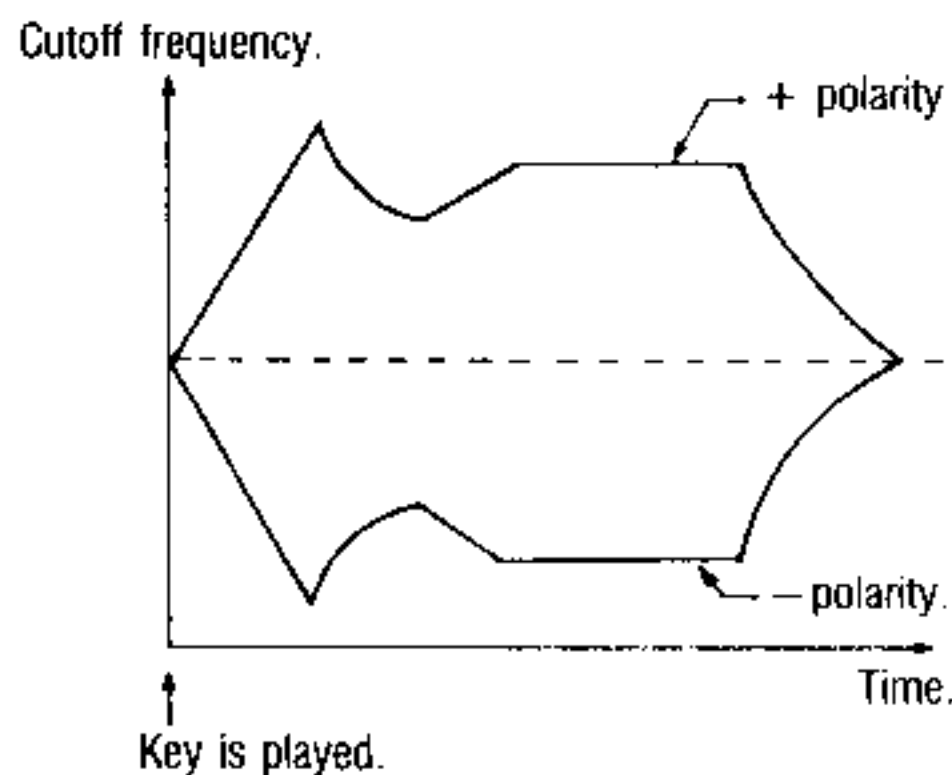

2) Using the VCF mode & EG polarity function.

- Press 3 then 1, or use DATA ENTRY A to select the VCF MODE & EG POL function.
- Move the cursor to the parameter that you wish to change. Then use DATA ENTRY B to adjust its value.

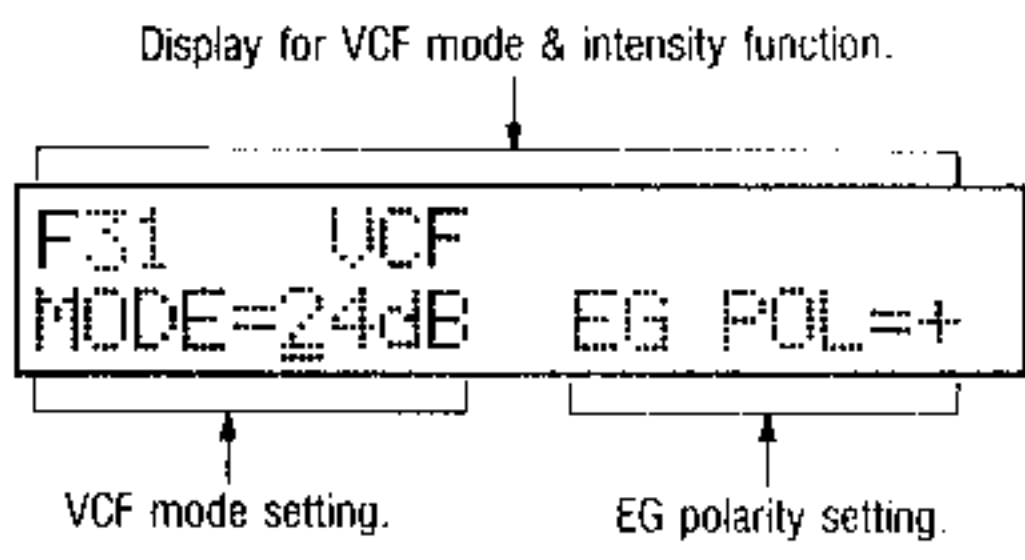

## F32 VCF CUTOFF & EG INT

1) The VCF cutoff & EG intensity function.

- Lets you adjust the filter cutoff frequency and the intensity of modulation by the envelope generator.

● **VCF cutoff:**  
Sets the cutoff frequency of the low pass filter. This kind of filter starts to attenuate frequencies above the cutoff. The higher the value, the brighter the sound. At 127, no harmonics are removed, so there is no effect on the timbre. The lower the value, the more harmonics are removed, so the duller or more mellow the sound's tone color.

● **EG Intensity:**  
This parameter determines the intensity of envelope generator (VCF EG) modulation of the VCF cutoff frequency. When you play a note, the cutoff frequency changes according to the VCF EG envelope settings.

Possible VCF cutoff frequencies.

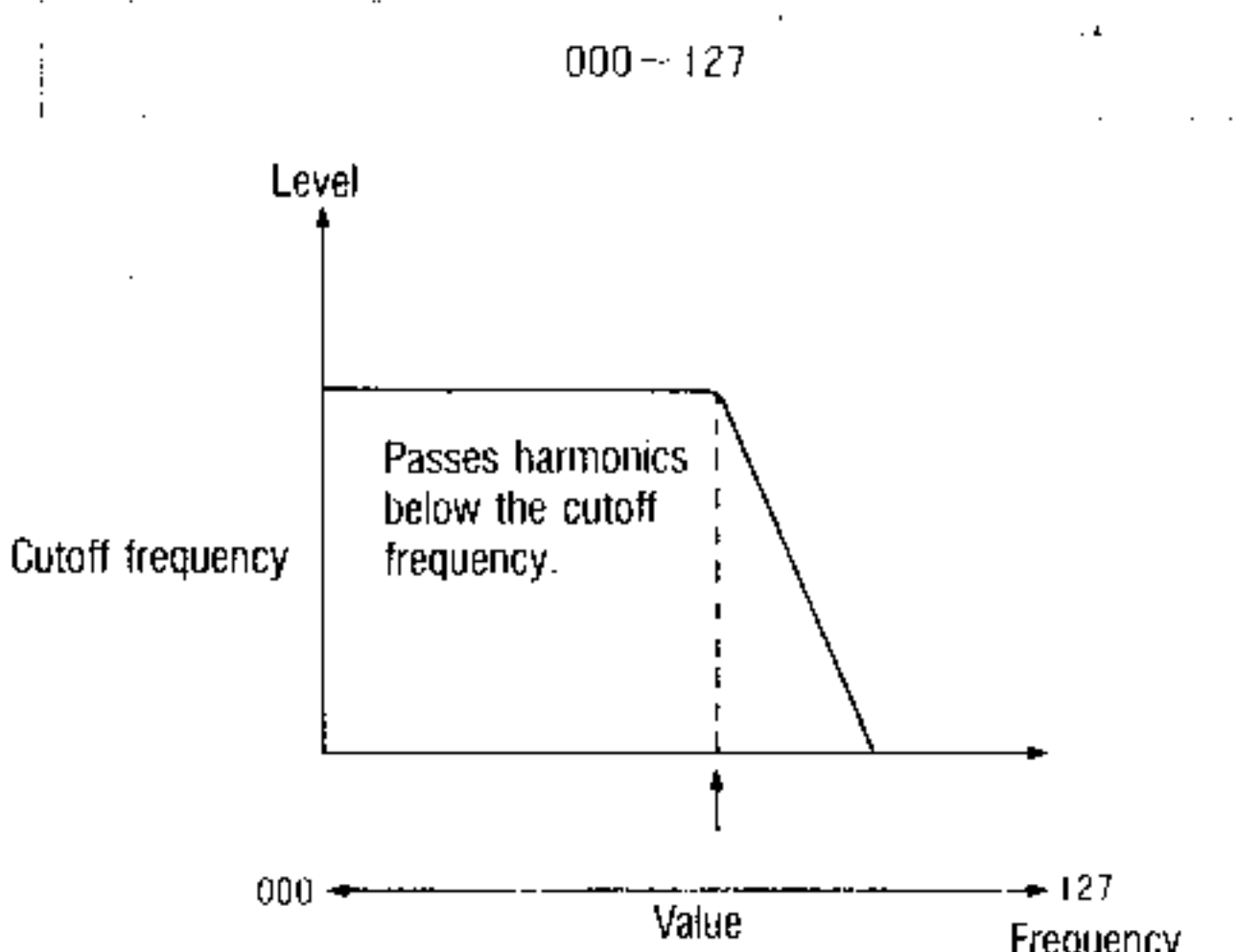

Possible EG Intensity values

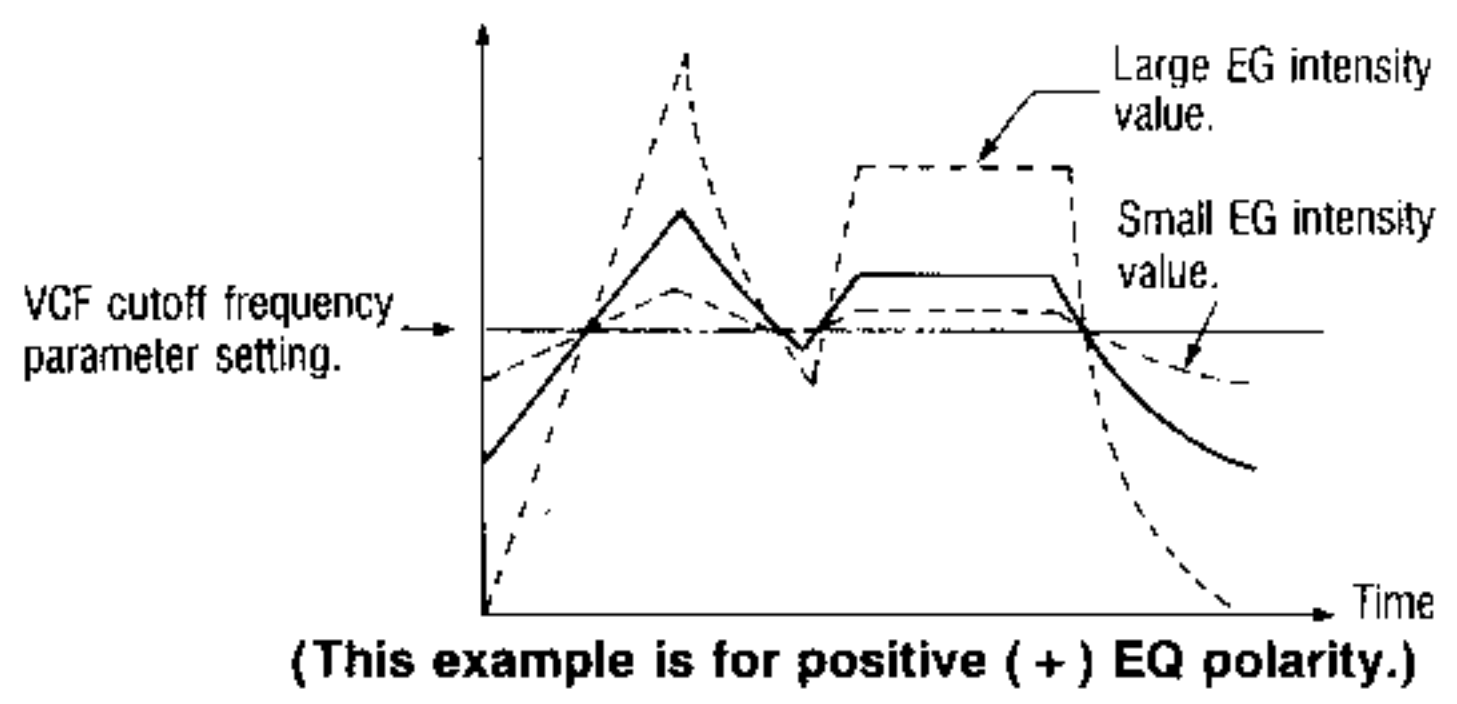
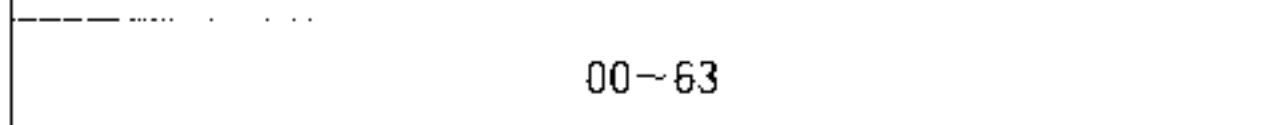

PROGRAM PARAMETER MODE

2) Using the VCF cutoff & EG intensity function.

■ Press 3 then 2, or use DATA ENTRY A to select the VCF CUTOFF & EG INT function.

■ Use the cursor keys to select a parameter. Then use DATA ENTRY B to adjust its value.

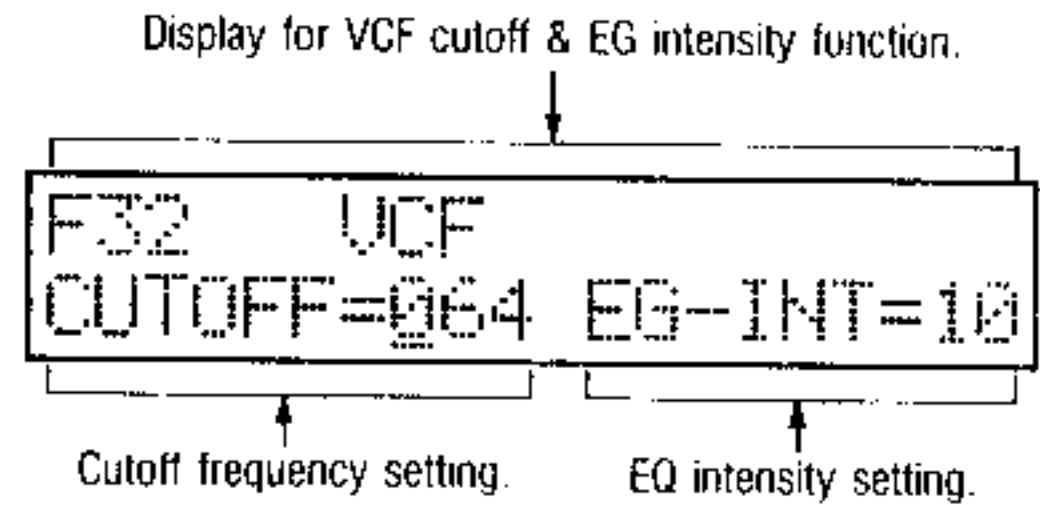

## F33 VCF RESO & KBD TRACK

1) VCF resonance and keyboard tracking function.

■ Resonance creates a peaky or bandpass type sound by emphasizing the harmonics near the cutoff frequency. Keyboard tracking determines the degree to which the cutoff frequency changes in proportion to the pitch of notes played on the keyboard.

● Resonance:

The higher the value of this parameter, the stronger the resonance peak in the vicinity of the cutoff frequency. Near the maximum value of 63, the VCF goes into self-oscillation, producing a sound that is audible as separate from the oscillator sound.

● Keyboard tracking:

With keyboard tracking, the sound gets brighter as you play higher notes, as is the case with most acoustic instruments. The value of this parameter determines the degree to which the change in cutoff frequency is proportional to the change in keyboard pitch.

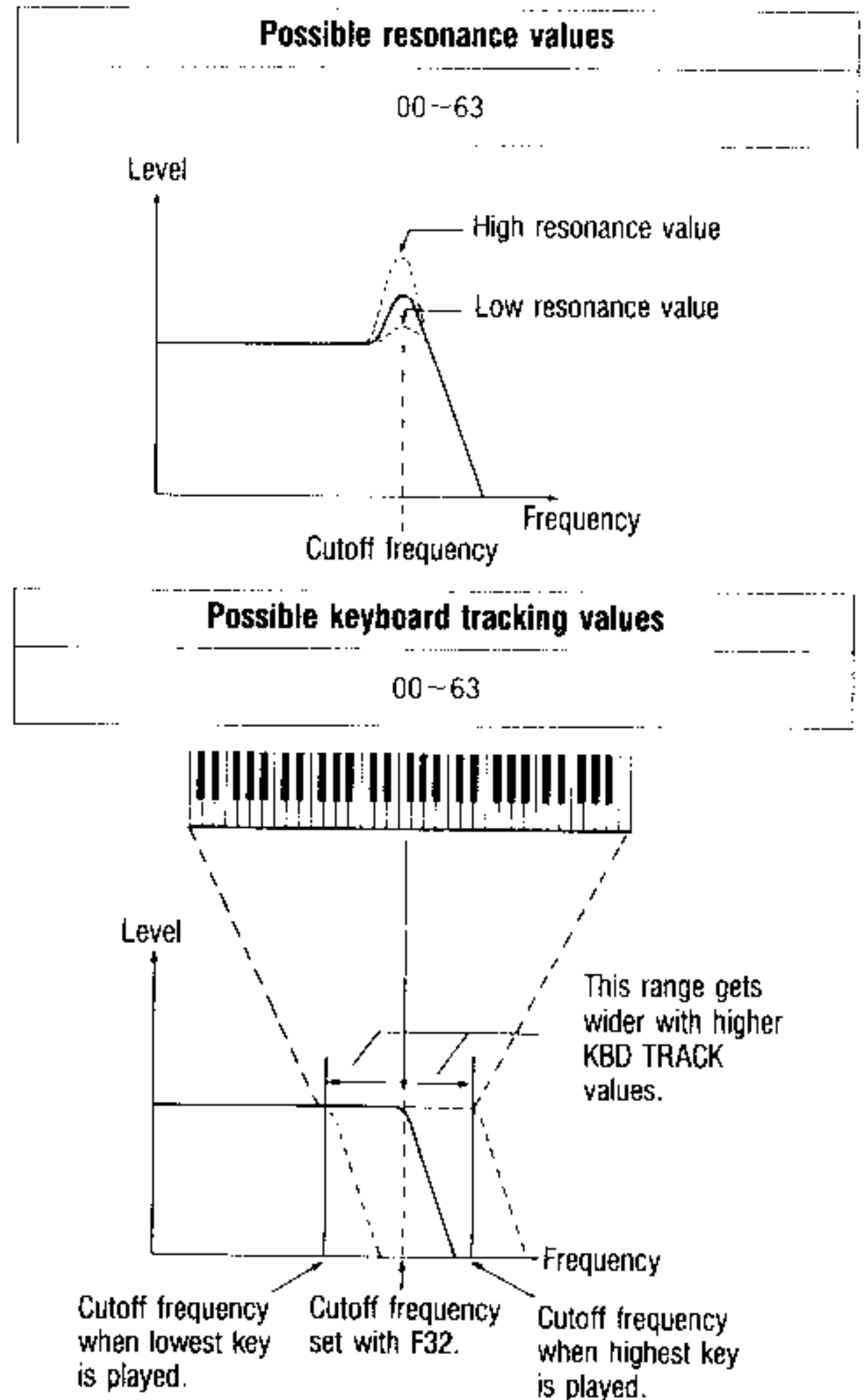

2: Using the VCF resonance & keyboard tracking function.

- Select the function by pressing 33 on the number keys or by moving the DATA ENTRY A slider.
- Move the cursor to the parameter that you wish to change. Then use DATA ENTRY B to adjust its value.

Display for VCF resonance & keyboard tracking function.

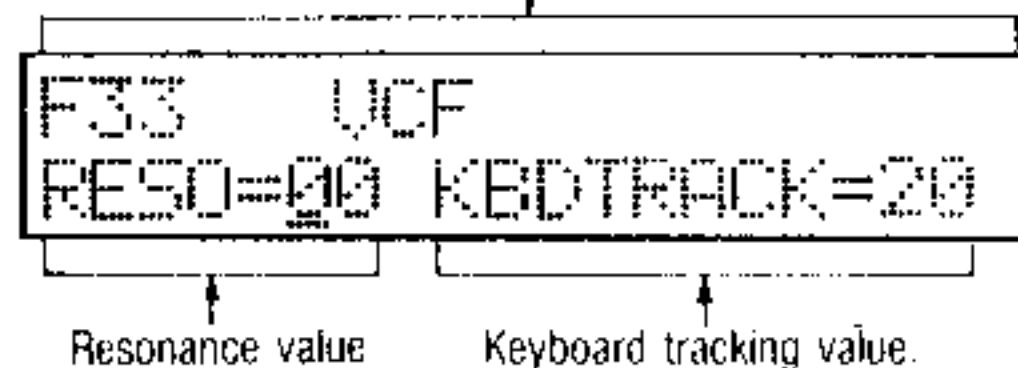

## F34 VCF MG MOD

□ The VCF modulation mode function.

- This lets you modulate the VCF cutoff frequency to create wah-wah and related effects in which there is a regular variation in the sound's timbre. There are three parameter values that may be adjusted.

- **Frequency:**  
Controls the speed of the filter modulation effect.
- **Intensity:**  
Controls the depth of the modulation, that is the amount of change in the cutoff frequency.
- **Delay:**  
Determines the delay before the onset of the effect after a key is played.

<b>Possible frequency values</b>
00--63
<b>Possible intensity values</b>
00--63
<b>Possible delay values</b>
00--63

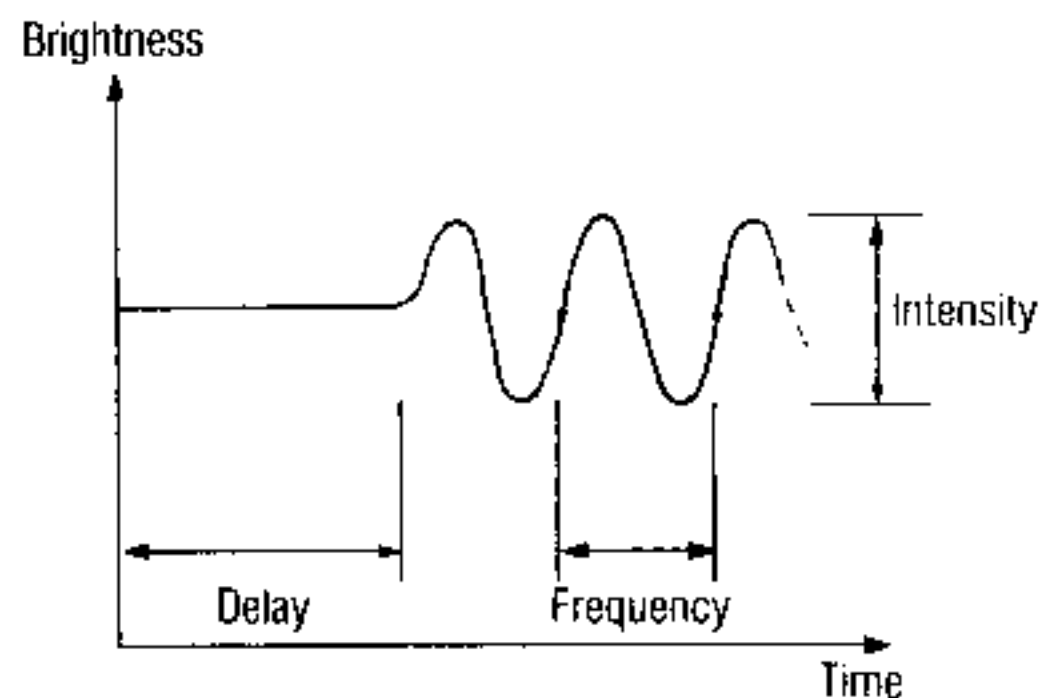



2. **Using the VCF modulation mode function.**

- Press 3 then 4, or use DATA ENTRY A to select the function.
- Use the cursor keys to select a parameter. Use DATA ENTRY B to adjust its value.

## F35 VCF EG

[1] **About the VCF function.**

- This lets you set up an envelope (a voltage contour) to modulate the filter cutoff frequency each time you play a note. This determines the way the timbre of the sound changes over time. The way this operates is affected by the F31 EG polarity and F32 EG intensity settings. There are six parameters that can be set within the VCF envelope generator function.

- **Attack time:** controls how long it takes (after a key is played) for the EG to reach its initial maximum voltage before the decay time begins. The greater the value, the more gradual the tonal change.
- **Decay time:** The time it takes from the end of the attack to the break point level. The greater the value, the more gradual the possible change in tone color.

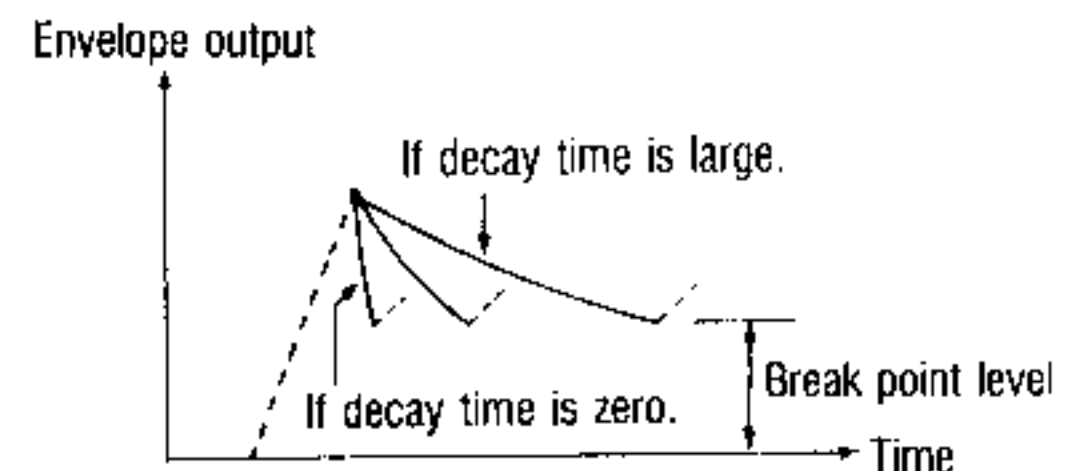
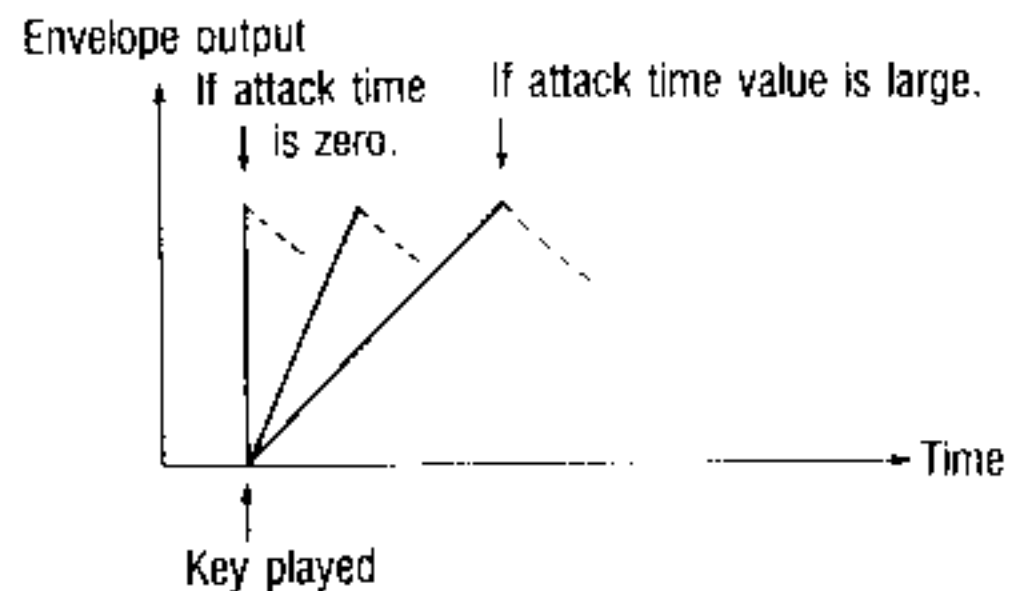
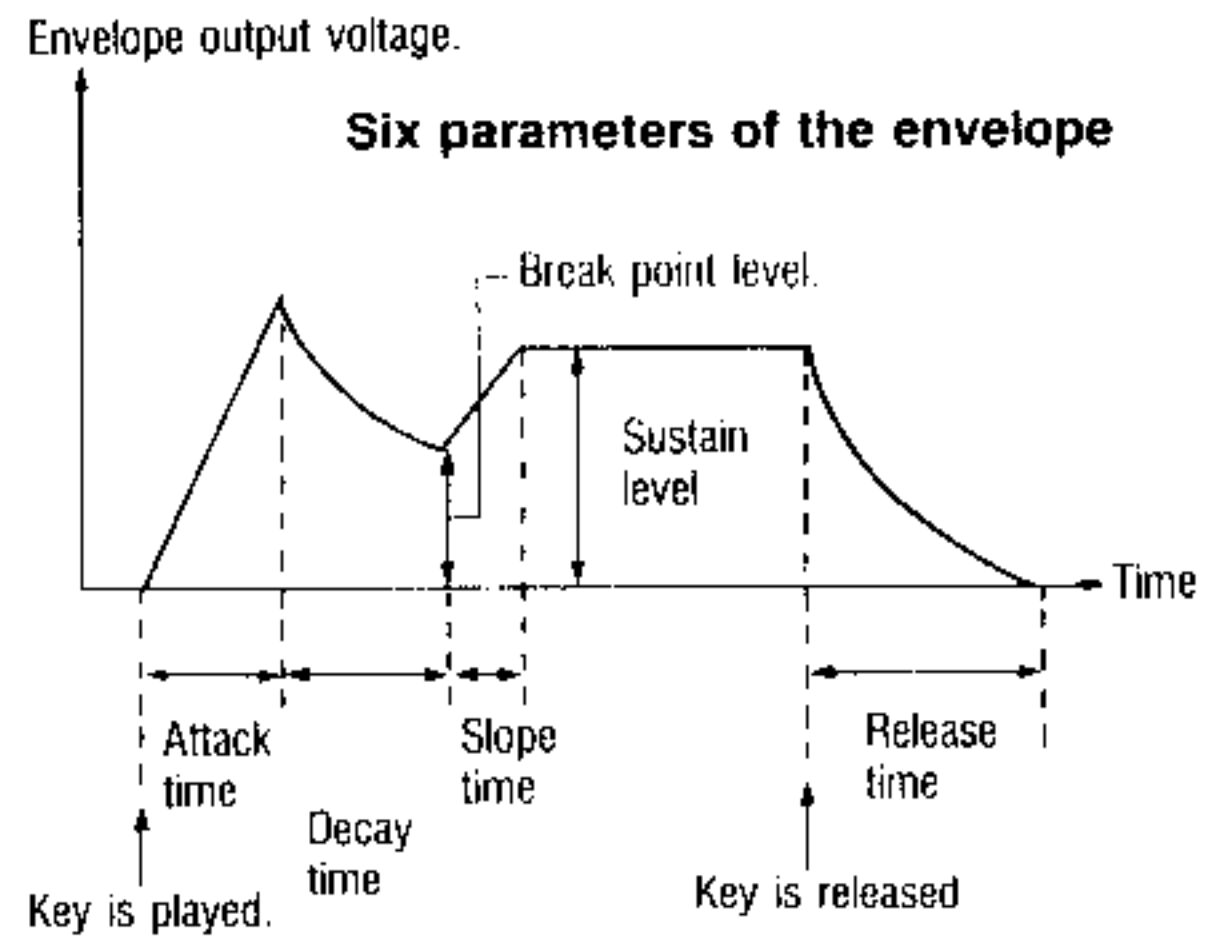
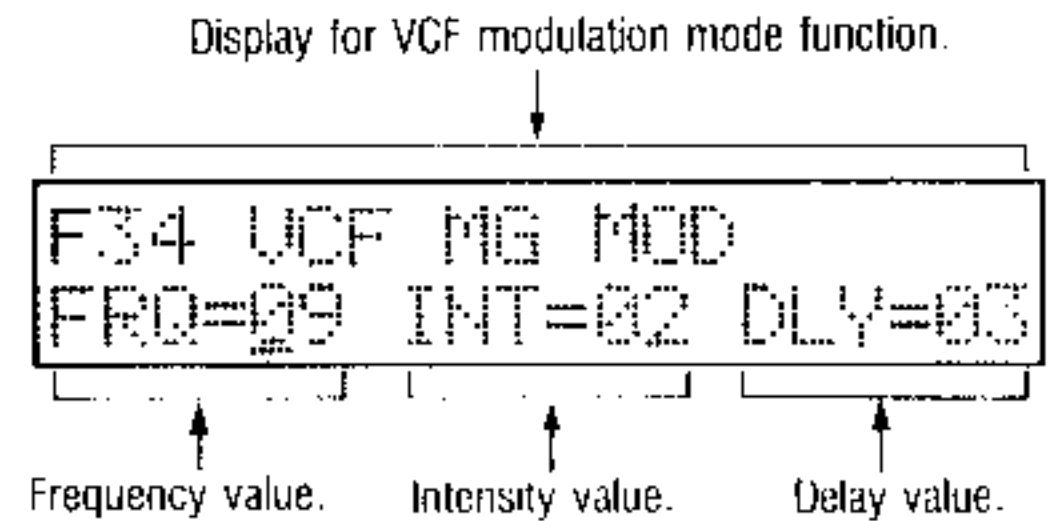

● **Break point level:**

Sets the level at which the decay time ends.

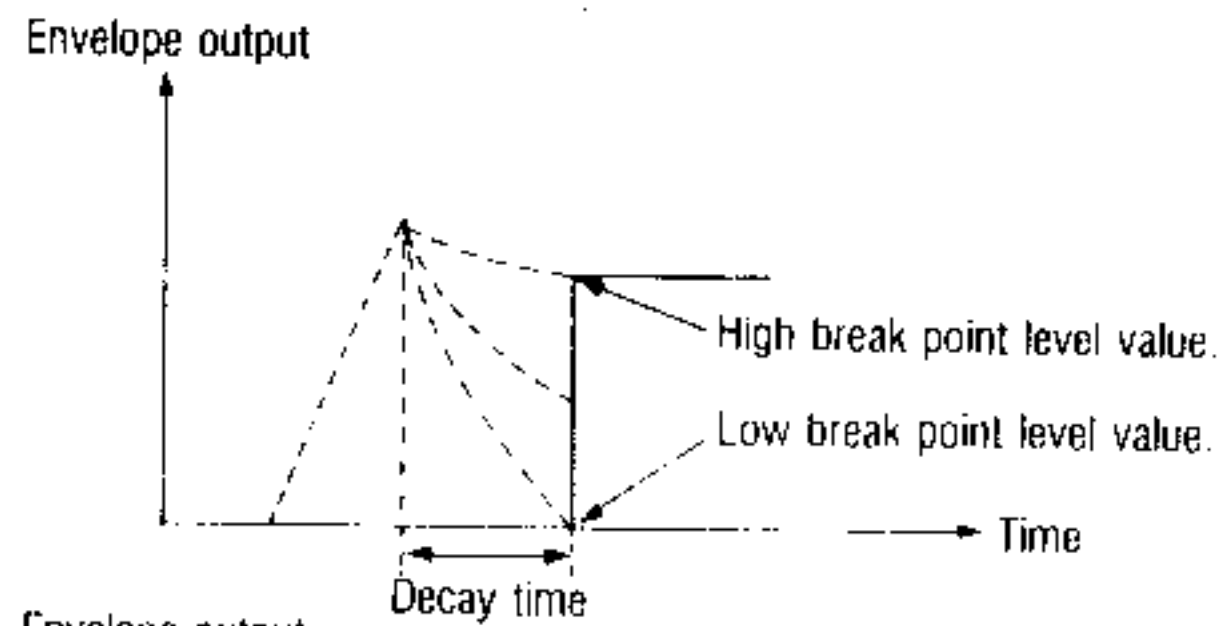

● **Slope time:**

Controls how long it takes for the envelope voltage to change from the break point level to the sustain level. The greater the value, the more gradual the tonal change (assuming that there is a difference in level between break point and sustain.)

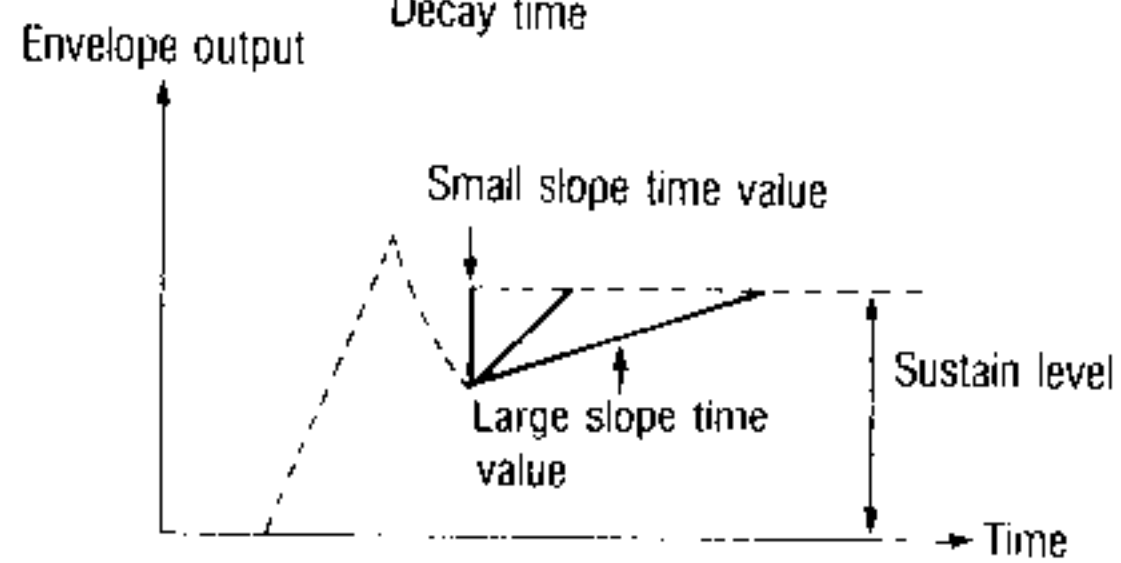

● **Sustain level:**

Sets the (voltage) level at which the slope time ends.

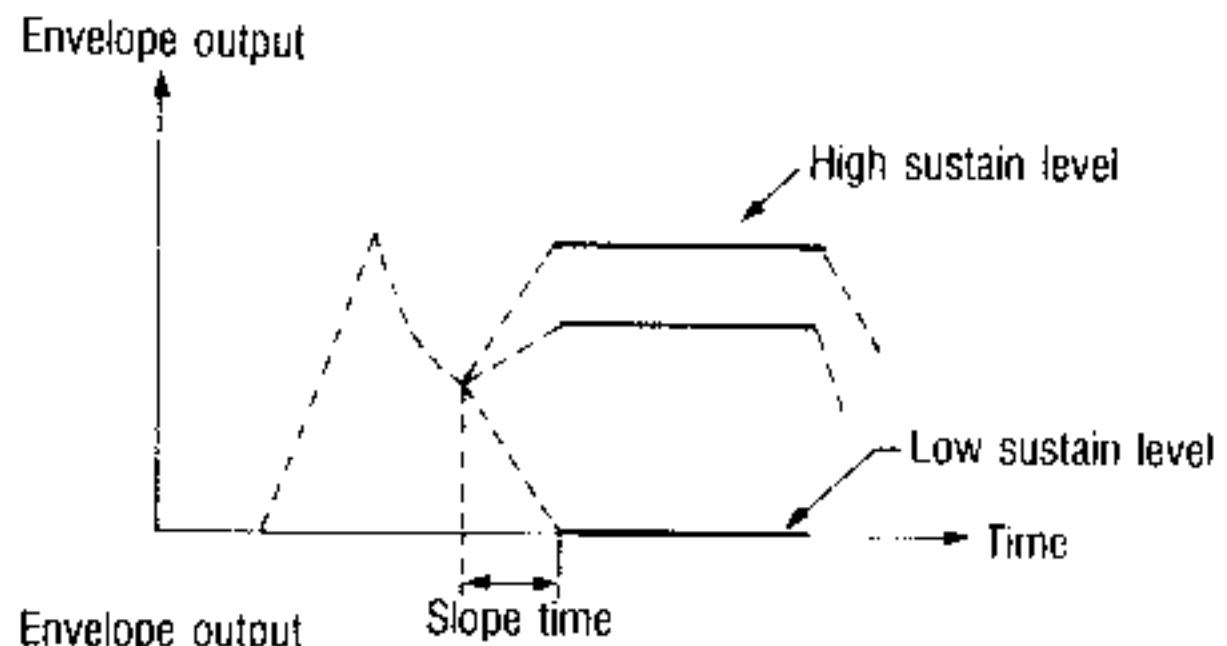

● **Release time:**

Determines the length of time that the sound continues to change after you release a key. The greater the value, the more gradual the change (assuming that the sustain level is high enough that there will be a change).

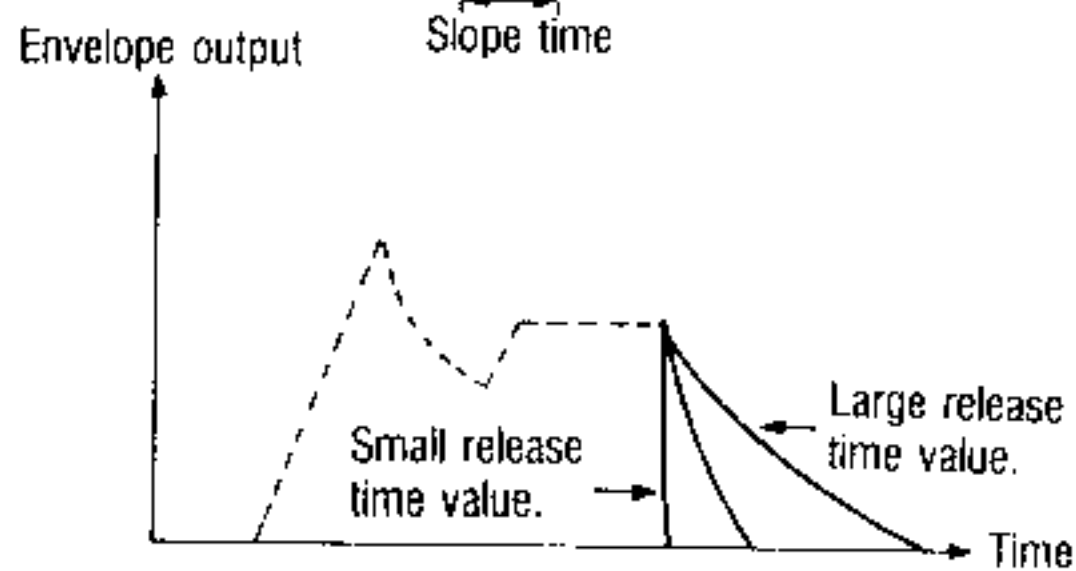

2] **Using the VCF EG Function**

■ Press 3 then 5, or use DATA ENTRY A to select the function.

■ Use the cursor keys to select a parameter. Use DATA ENTRY B to adjust its value.

Display for the VCF EG function.

UCF	A	D	B	S	S	R
EG	03	32	50	10	56	10

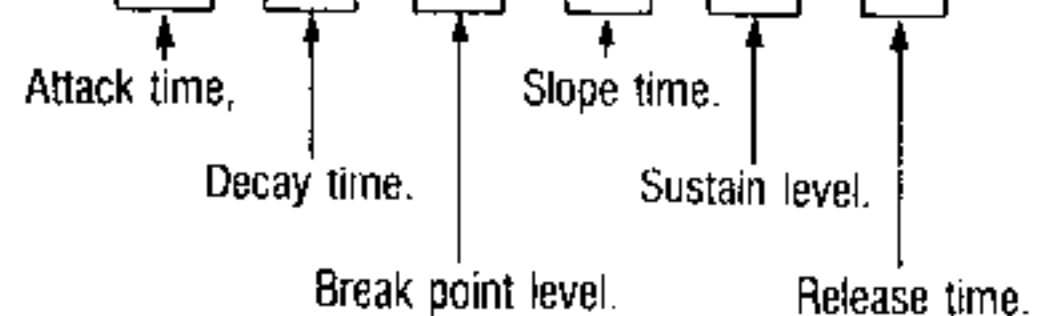

# VCA FUNCTION GROUP

F36 through F38 are the DSS-1 VCA control functions. The voltage controlled amplifiers (VCA) are used for control of the volume of the sound from VCF.

## F36 VCA TOTAL LEVEL

### 1] The VCA total level function.

- Determines the overall volume level of the sound in a particular program. Since this value is stored along with the rest of each patch, you can use it to avoid undesirable volume variations when you change sounds.

### 2] Using the VCA total level function.

- Select the function by pressing 3 then 6 on the number keys or by moving the DATA ENTRY A slider.
- Use DATA ENTRY B to adjust the value.

Possible VCA total level values.

00 - 63

Display for VCA total level function.

F36 VCA  
TOTAL LEVEL = 50

Total level setting.

## F37 VCA DEC KBDTRACK

### 1] The VCA decay keyboard tracking function.

- This lets you make the VCA EG decay time get progressively longer or shorter in proportion to keyboard pitch. For example, if you want to replicate guitar or piano decay characteristics then you would choose a value (above 0) that would cause a shorter decay at higher notes.

Possible VCA decay keyboard tracking values.

63 - 0 - 63

Decay  
keyboard tracking.



(Values 0 to 63)



(Values - 63 to 0)



**2] Using the VCA decay keyboard tracking function.**

- Press 3 then 7, or use DATA ENTRY A to select the function.
- Use DATA ENTRY B to adjust the value.

Display for VCA decay keyboard tracking function.



Current value for this parameter.

## F38 VCA EG

**1] The VCA envelope generator function.**

- The VCA EG lets you create an envelope (voltage contour) that controls the VCA (voltage controlled amplifiers), there by determining how the volume changes over time. The VCA envelope is like that described for the VCF EG. It has six parameters:

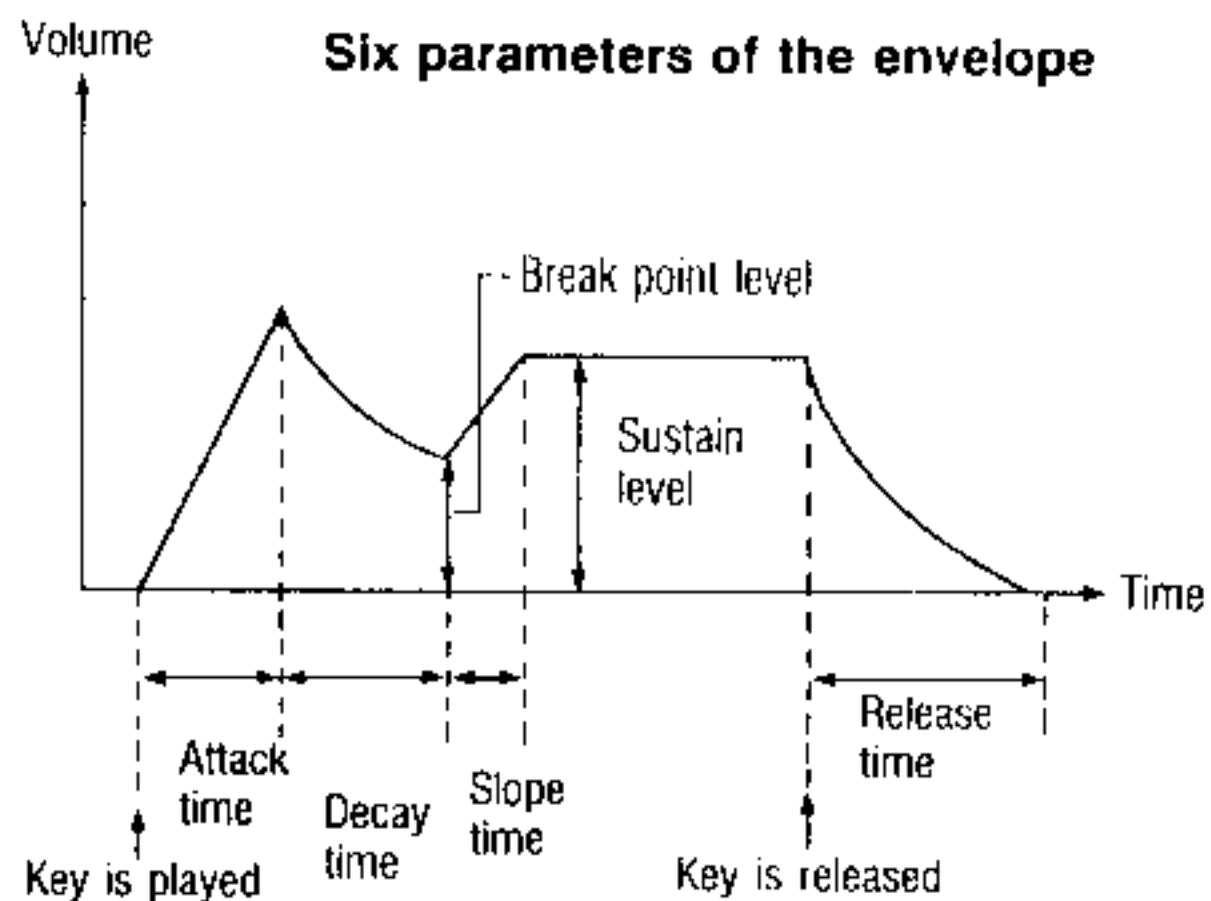

● **Attack time:**

Controls how long it takes (after a key is played) for the EG to reach its initial maximum voltage before the decay time begins. The greater the value, the slower the volume change.

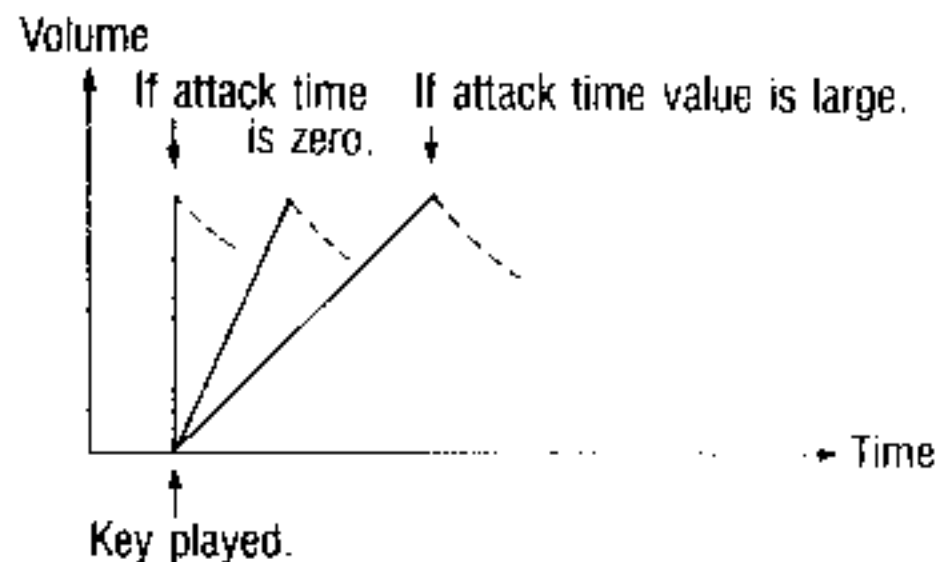

● **Decay time:**

The time it takes from the end of the attack to the break point level. The greater the value, the more gradual the possible change in volume.

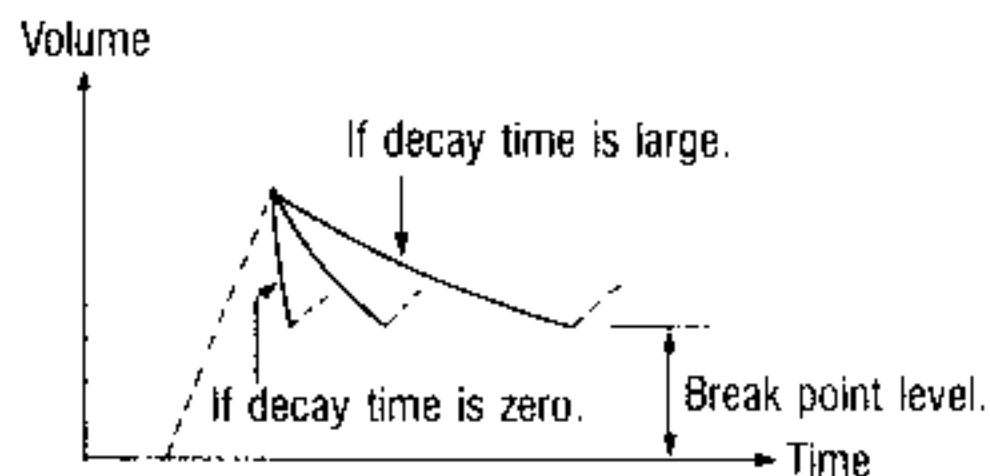

- **Break point level:**  
Sets the level at which the decay time ends.

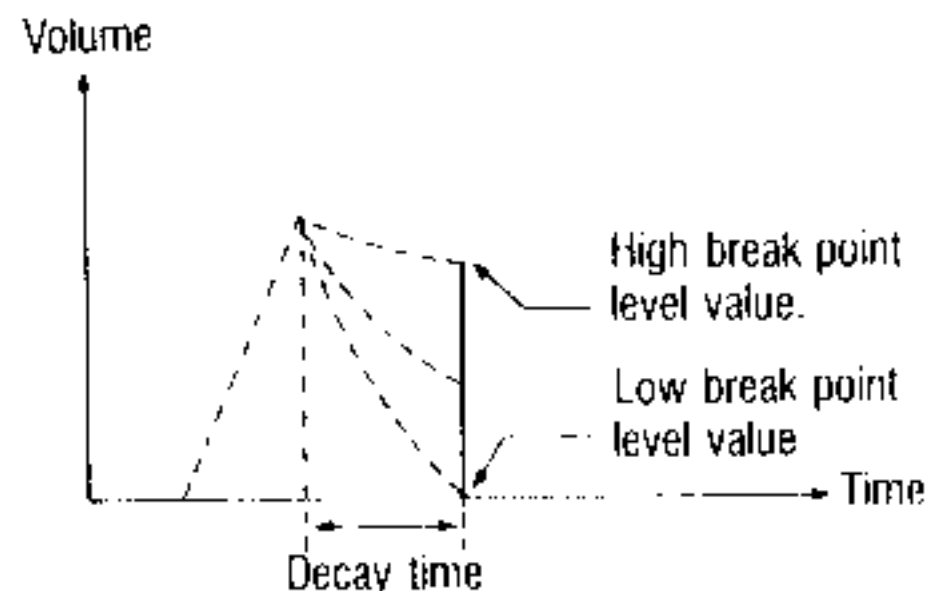

- **Slope time:**  
Controls how long it takes for the envelope voltage to change from the break point level to the sustain level. The greater the value, the more gradual the volume change (assuming that there is a difference in level between break point and sustain).

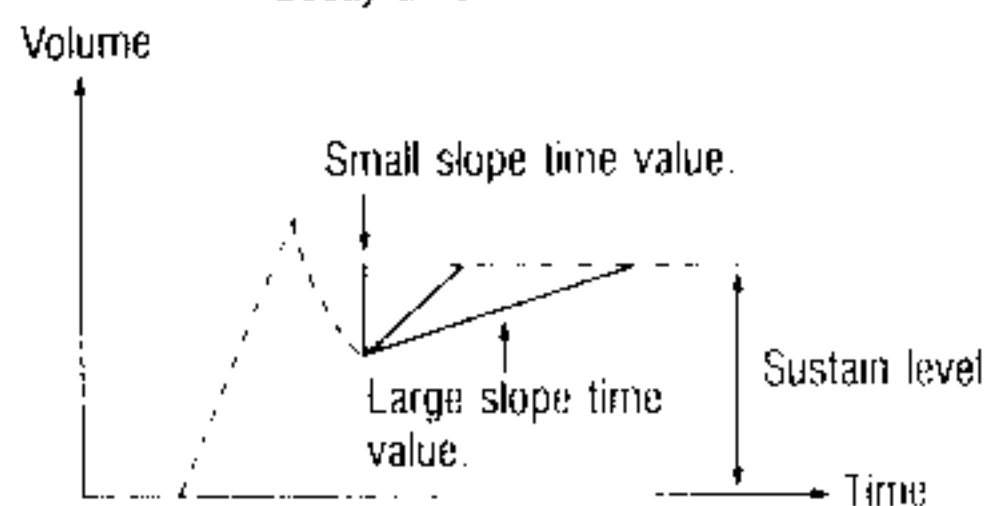

- **Sustain level:**  
Sets the (voltage) level at which the slope time ends.

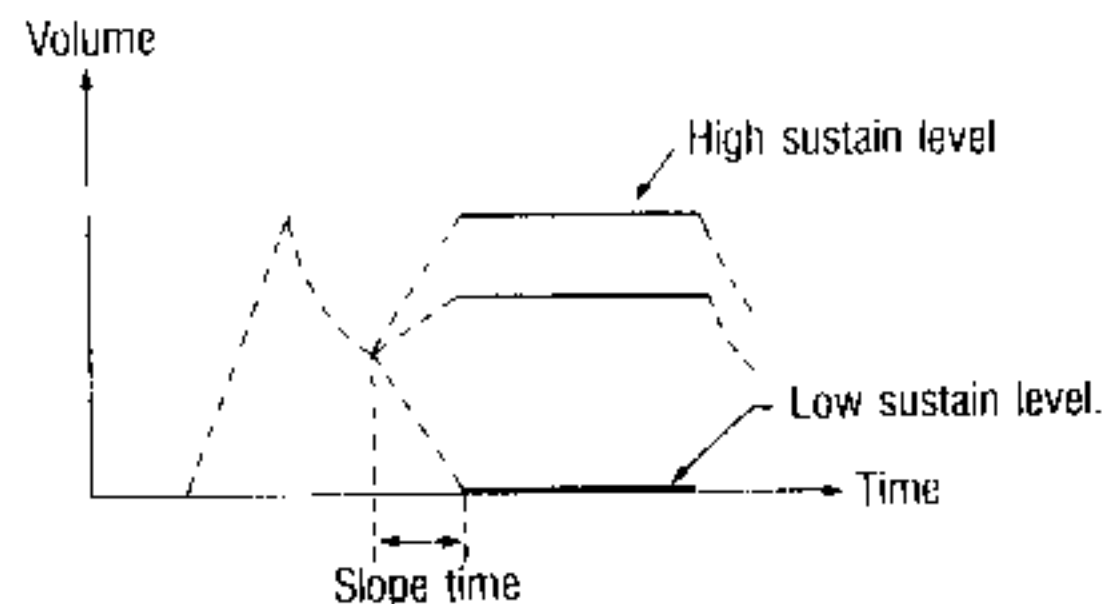

- **Release time:**  
Determines how long it takes for the sound to fade away after you release a key. The greater the value, the more gradually the volume will be attenuated. (This assumes that the sustain level is high enough so that there will be a change).

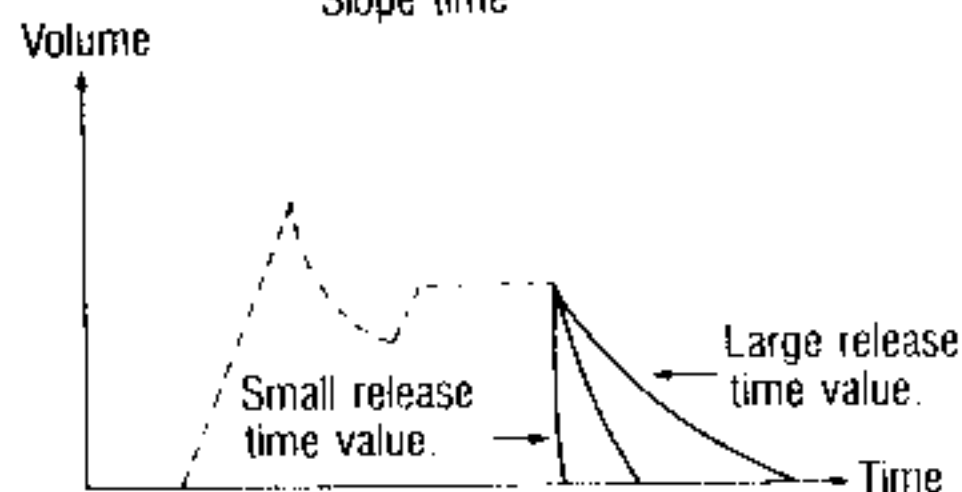

2. Using the VCA EG Function

- Press 3 then 8, or use DATA ENTRY A to select the function.

- Use the cursor keys to select a parameter. Use DATA ENTRY B to adjust its value.

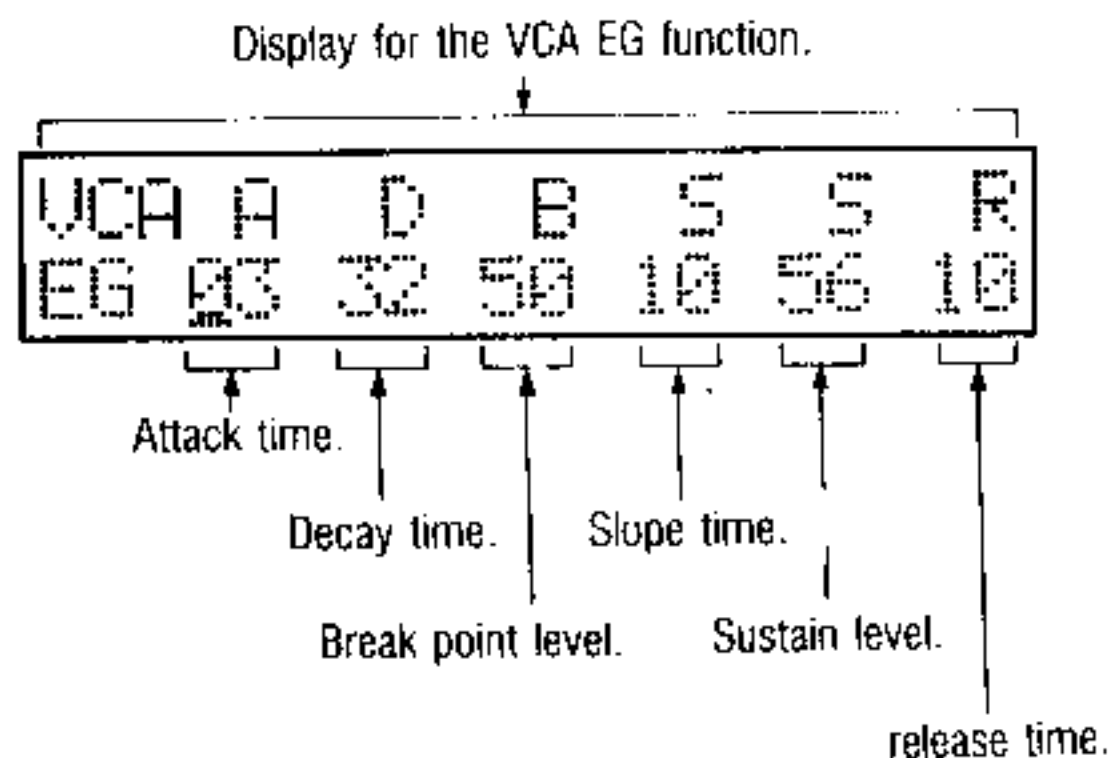

# VELOCITY FUNCTION GROUP

F41 through F46 are the velocity sensitive functions which let you control various aspects of the sound according to how hard you play the keyboard.

## F41 AUTO BEND INT

### 1 The auto bend Intensity function

- The higher the value, the greater the pitch bend that will be produced when you play harder. Even if the F19 function's auto bend parameter is set to zero, you can still obtain an auto bend effect by raising the intensity value in F41.

Possible auto bend intensity values.

00 - 63

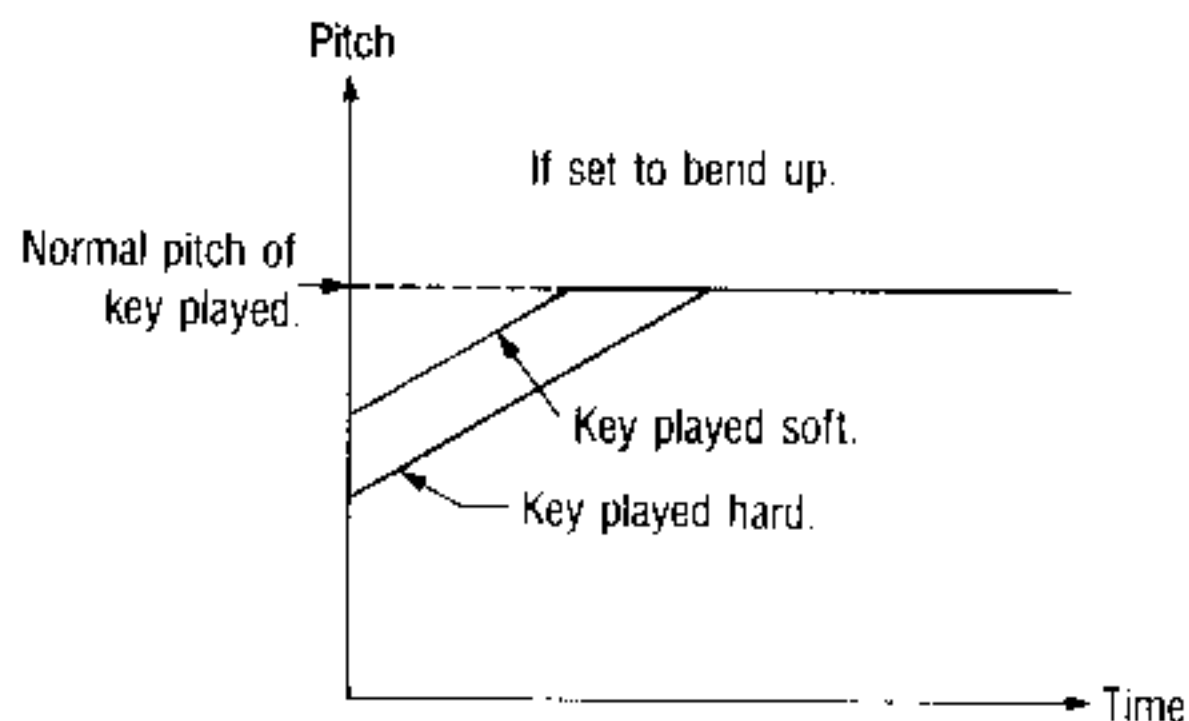

### 2 Using the auto bend intensity function.

- Press 4 then 1, or use DATA ENTRY A to select the function.
- Use DATA ENTRY B to adjust the value.

Display for auto bend intensity function.

```
F41 A.BEND VEL-SENS.  
INTENSITY = 10
```

Intensity value.

## F42 VCF EG CUTOFF

### 1 The VCF EG cutoff function.

- This lets you control the filter cutoff frequency according to how hard you play. As with most acoustic instruments this lets you obtain brighter sounds when you play harder.

#### Possible values for VCF EG cutoff.

00 ~ 63

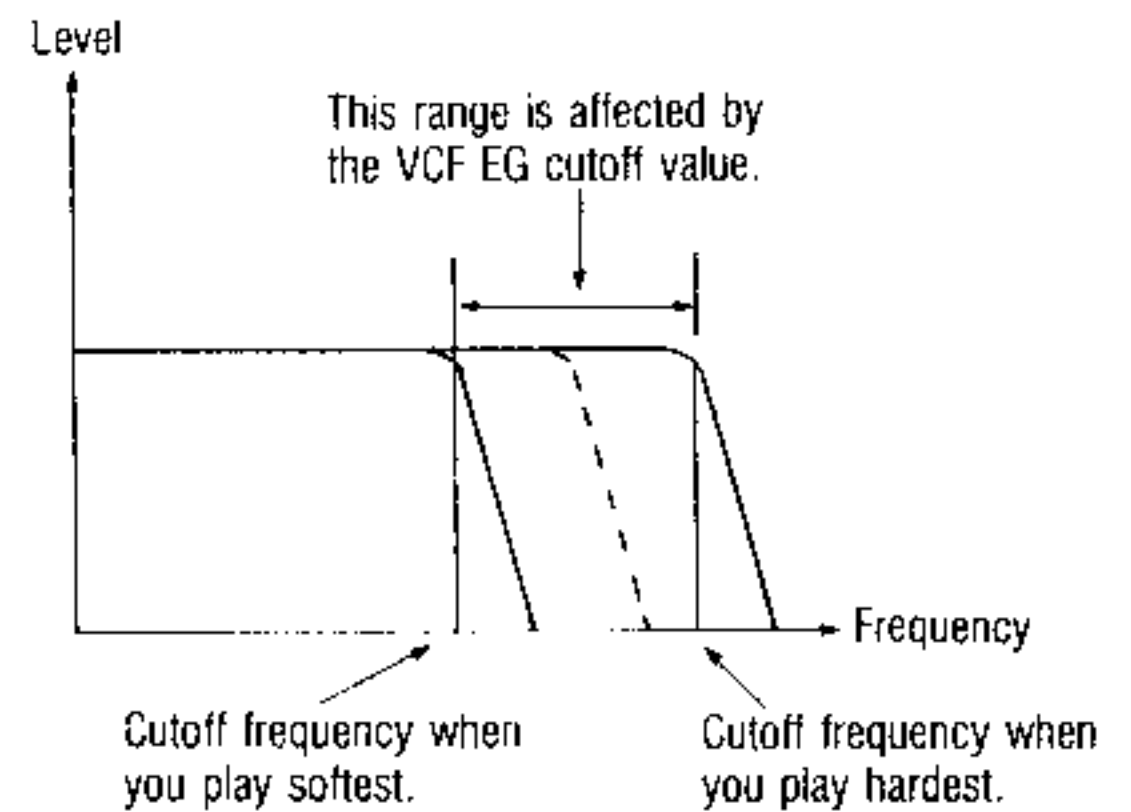

### 2 Using the VCF EG cutoff function.

- Select the function by pressing 4 then 2 on the number keys or by moving the DATA ENTRY A slider.
- Use DATA ENTRY B to adjust the value.

Display for VCF EG cutoff function.

```
F42 VCF EG VEL-SENS.  
CUTOFF = 05
```

Cutoff value.

## F43 VCF EG (ATK, DEC, SLP)

### 1 The VCF EG (attack, decay, slope) function.

- This lets you control the filter modulation envelope's attack time, according to how hard you play. This gives you a way to simulate techniques such as tonguing and breath control in brass instruments.

#### Possible attack values.

00 ~ 63

#### Possible decay values.

00 ~ 63

#### Possible slope values.

00 ~ 63

- **Attack:**

The greater the value, the shorter the attack when you play harder and the longer the attack when you play softer.

- **Decay:**

The greater the value, the shorter the decay when you play harder and the longer the decay when you play softer.

- **Slope:**

The greater the value, the shorter the slope when you play harder and the longer the slope when you play softer.

## 2 Using the VCF EG (attack, decay, slope) function.

- Press 4 then 3, or use DATA ENTRY A to select the function.
- Use the cursor keys to select parameters. Use DATA ENTRY B to adjust their values.

## F44 VCA EG LEVEL

### 1 About the VCA EG level function.

- This lets you control the dynamic volume sensitivity of the keyboard. The higher the value, the greater the sensitivity.

Typical decay time variation according to velocity.

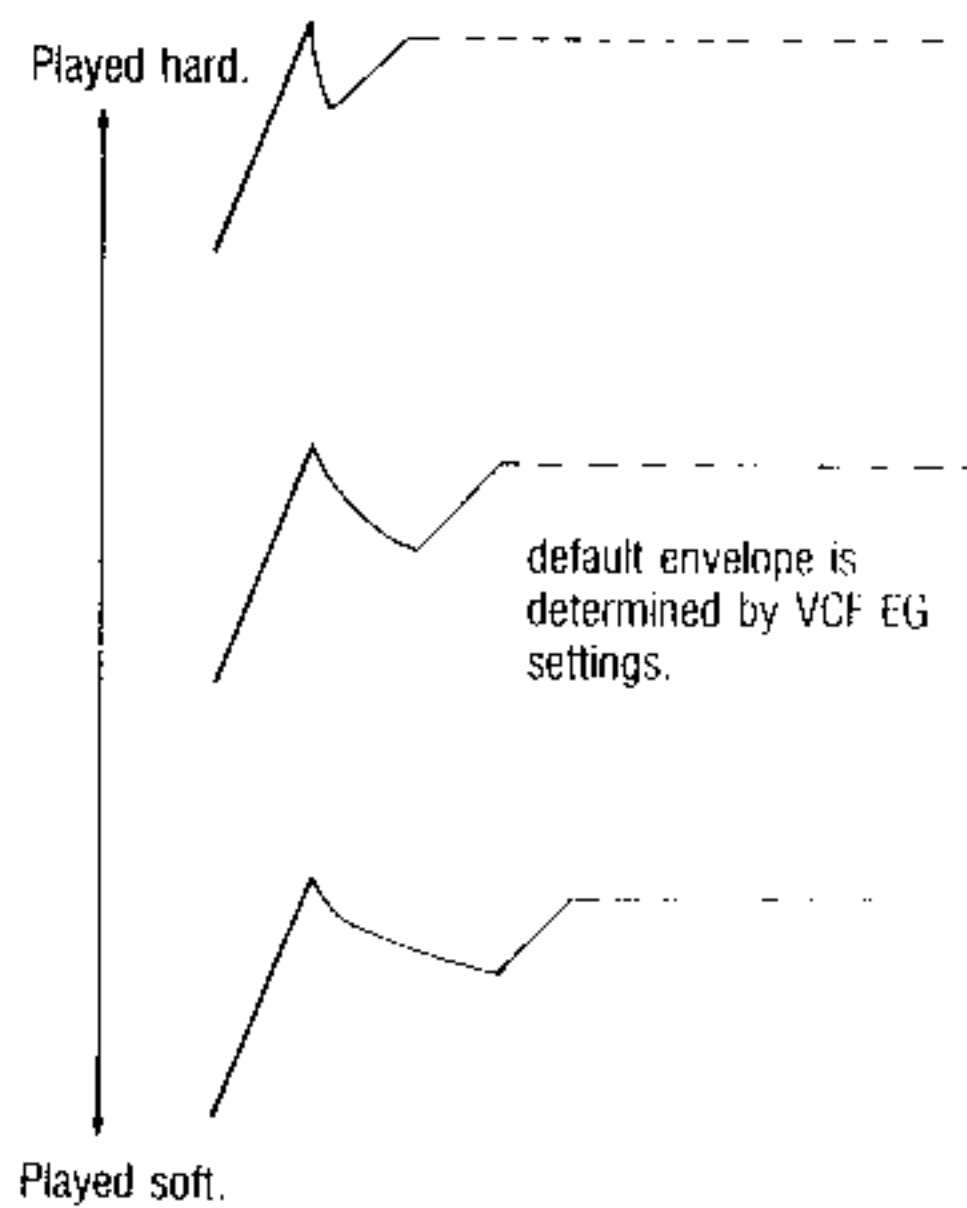

Display for the VCF EG (attack, decay, slope) function.

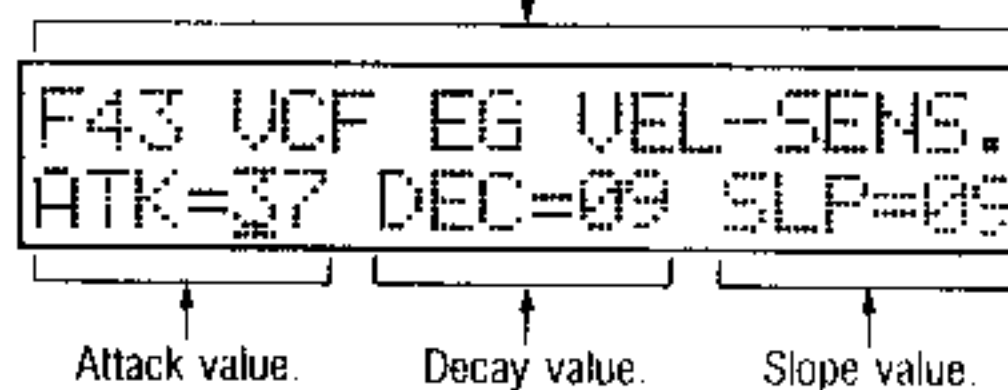

Possible VCA EG level function values.

00-63

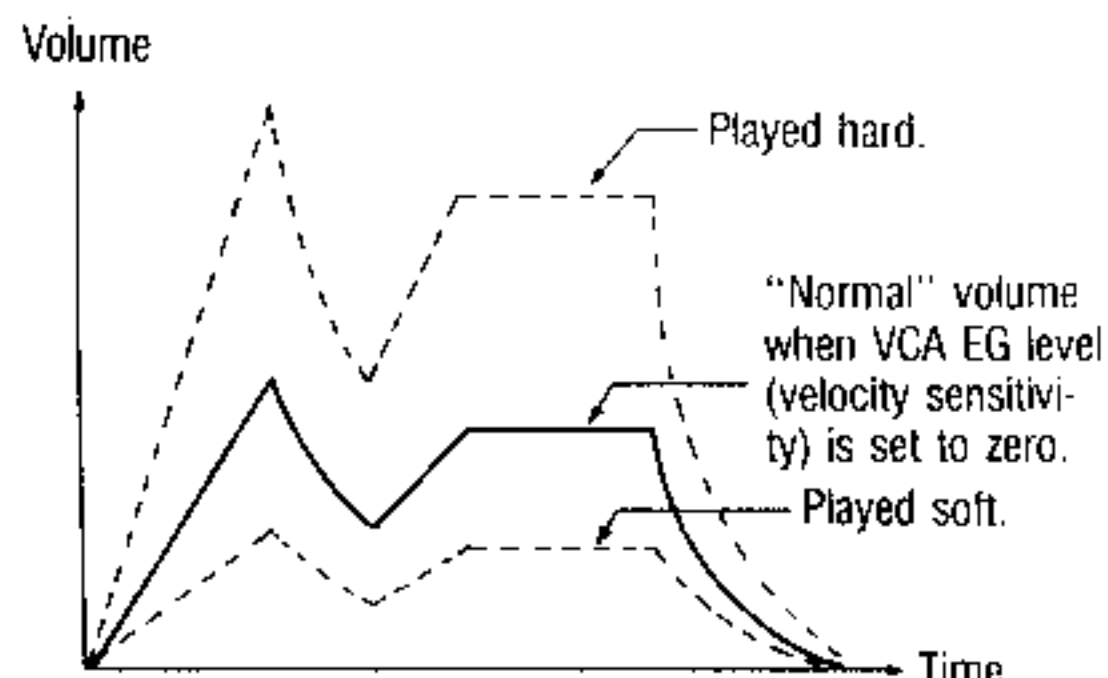



2| **Using the VCA EG level function.**

- Select the function by entering 44 using the number keys or by moving the DATA ENTRY A slider.
- Use DATA ENTRY B to adjust the value.

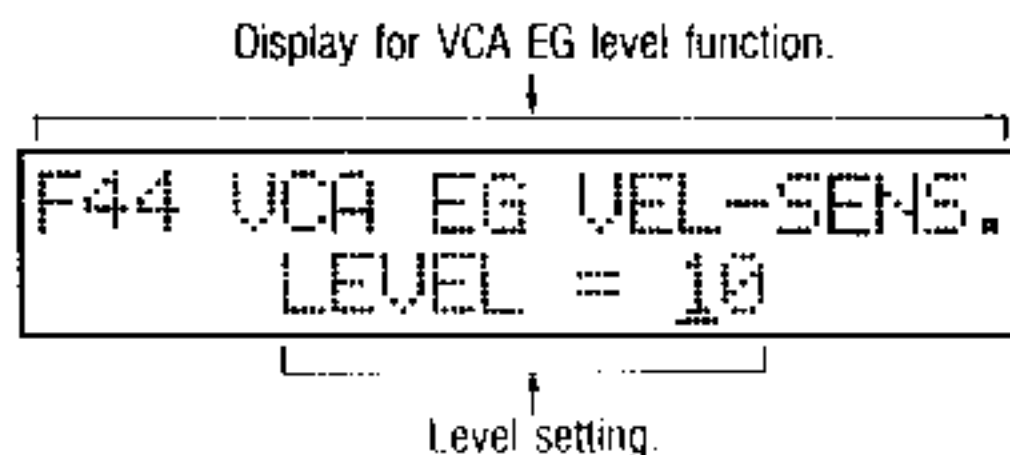

## F45 VCA EG (ATK, DEC, SLP)

1| **The VCA EG (attack, decay, slope) function.**

This lets you control the VCA EG attack time, decay time, and slope time, according to how hard you play. This gives you a way to simulate the changes in attack and other characteristics of the volume envelope that occur in acoustic instruments.

<b>Possible attack values.</b>
00--63
<b>Possible decay values.</b>
00--63
<b>Possible slope values.</b>
00--63

● **Attack:**

The greater the value, the shorter the attack when you play harder and the longer the attack when you play softer.

● **Decay:**

The greater the value, the shorter the decay when you play harder and the longer the decay when you play softer.

● **Slope:**

The greater the value, the shorter the slope when you play harder and the longer the slope when you play softer.

Typical attack time variation according to velocity.

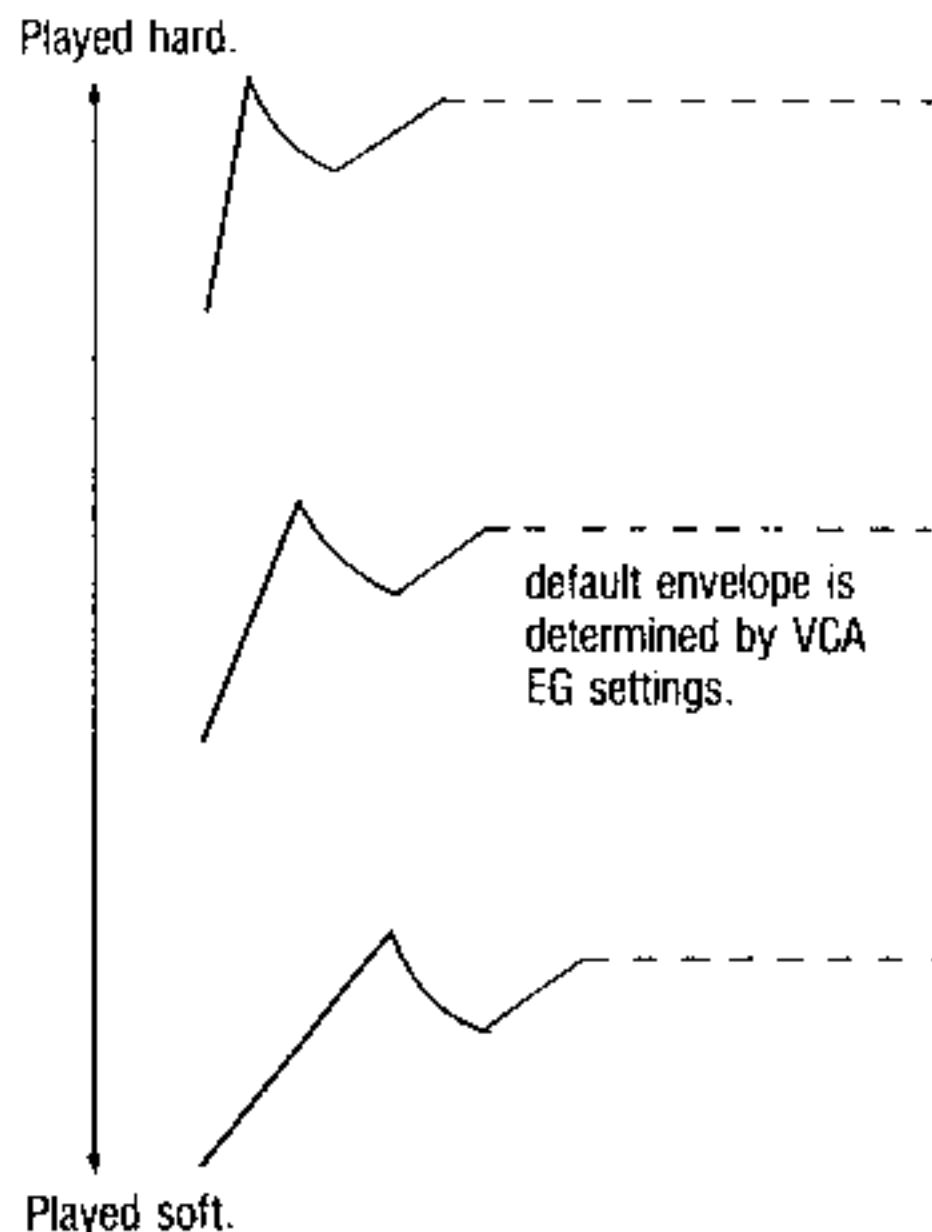

## 2i Using the VCA EG (attack, decay, slope) function.

- Press 4 then 5, or use DATA ENTRY A to select the function.
- Use the cursor keys to select parameters. Use DATA ENTRY B to adjust their values.

Display of the VCA EG (attack, decay, slope) function.

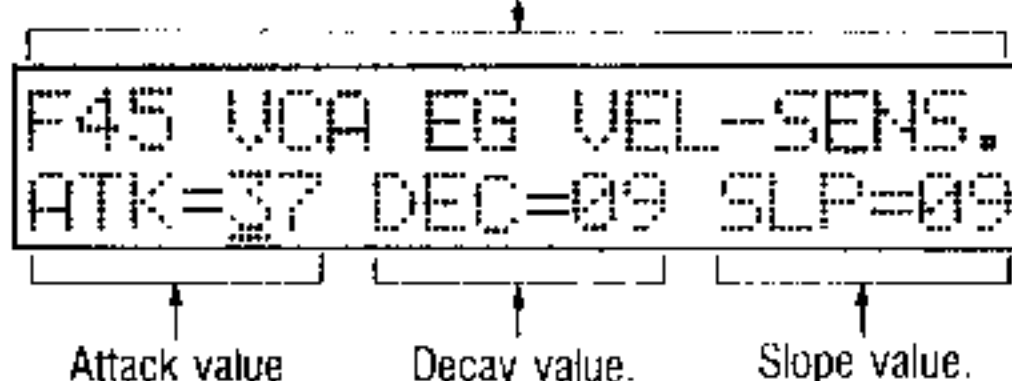

## F46 VELOCITY SWITCH

### 1 About the velocity switch function.

- This lets you switch between the multisound assigned to oscillator-1 and oscillator-2 according to how hard you play the keyboard. Therefore, you can switch sounds merely by changing the way you play (assuming that you have different multisounds assigned to the two oscillators). To obtain completely different sounds, the F14 mix ratio should be set to 100% vs. 0% (or vice versa). The velocity switch function value determines how hard you have to play to make the switch.

Possible velocity switch values.

00-31

Multisound switch level	Effect
00	No switch. Function is off.
01	Switches even if you play softly.
31	Does not switch unless you play hard.

- This function exchanges the oscillator multisounds assigned by F12 and F13. It does not change the F16 oscillator octave, F15 oscillator-2 detune & interval, F14 mix ratio, or other settings pertaining to the volume, mix ratio, or other aspects of oscillator operation.

As an example, if we have piano at 16' and strings at 8' with a 70% to 30% mix ratio, then after the switch we will have strings at 16' and piano at 8' with a mix ratio of 70% to 30%.

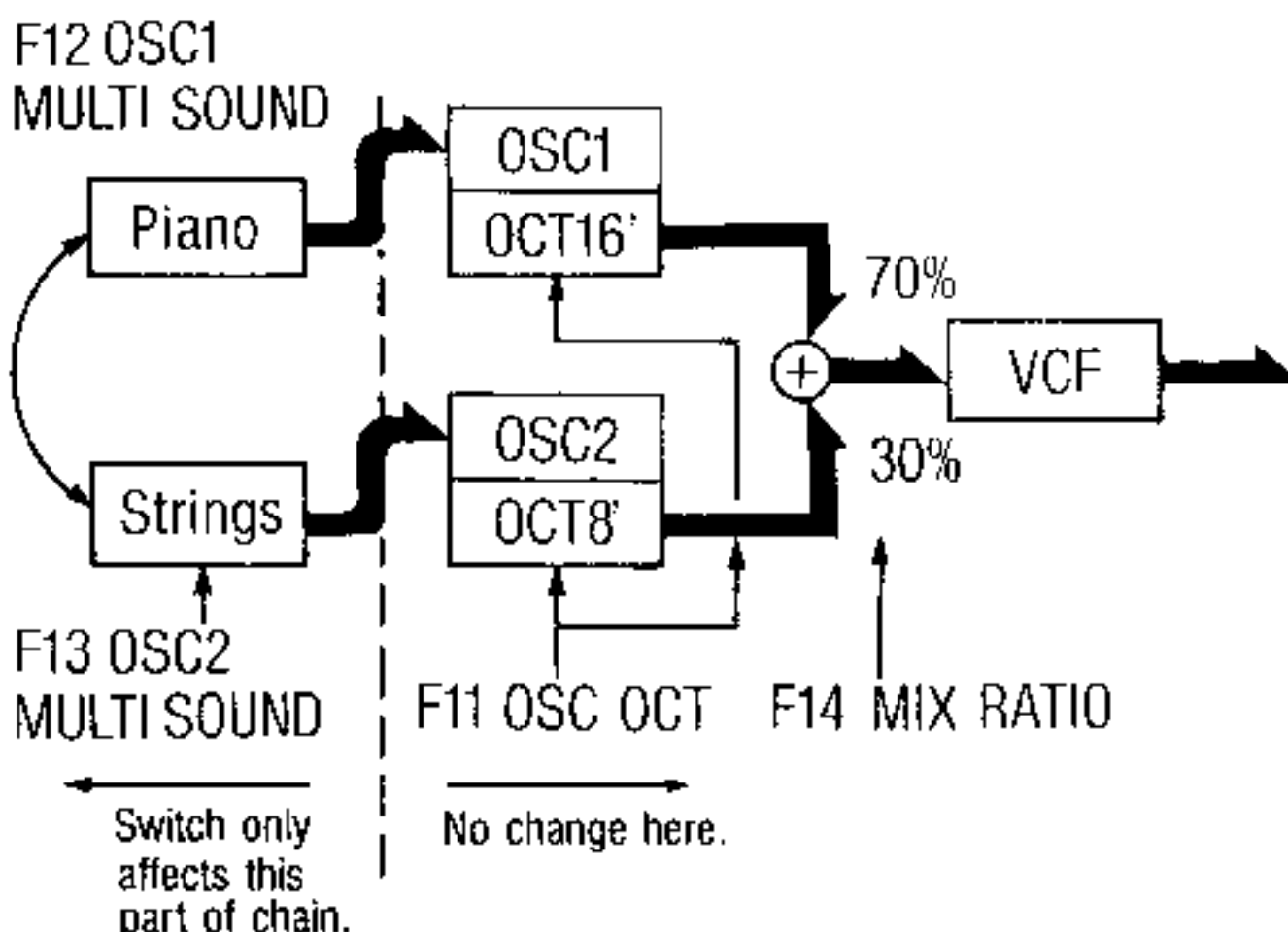

## 2. Using the velocity switch function.

- Select the function by pressing 4 then 6 on the number keys or by moving the DATA ENTRY A slider.

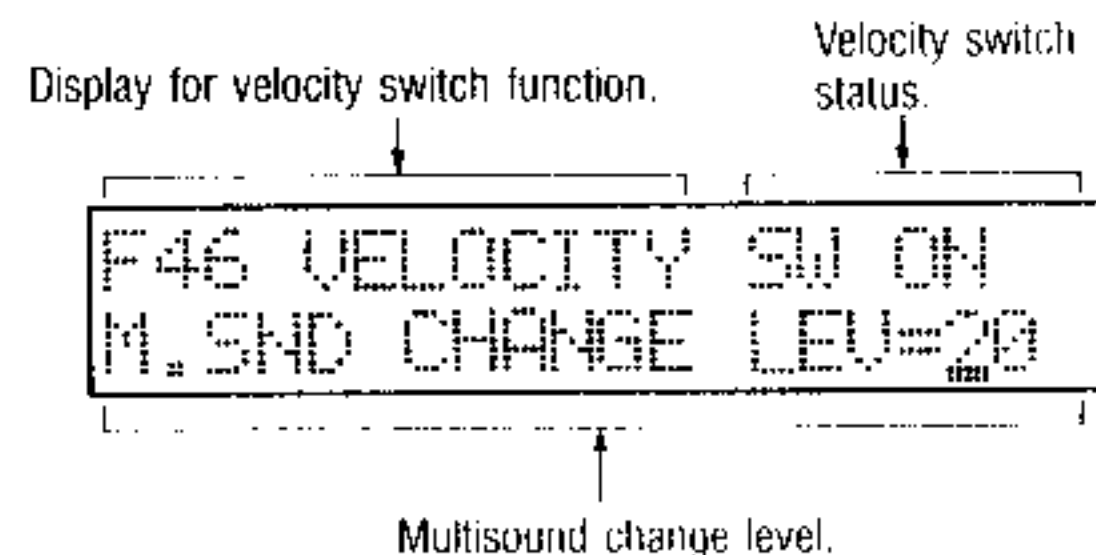

- Use DATA ENTRY B to adjust the value.

# AFTER TOUCH FUNCTION GROUP

If you keep pressing down after bringing a key to the end of its stroke then you can access the after-touch function. After-touch can be used to control vibrato, wah-wah, and other effects. Functions numbered F51 through F53 are use to control the after-touch effects.

## F51 OSC MG MOD INT

### 1. The oscillator modulation intensity function.

- This determines how sensitive vibrato intensity will be to after-touch pressure. The higher the setting, the greater the intensity when you press hard. Vibrato frequency is determined by the F17 oscillator modulation mode function.

Possible mode settings for VCF cutoff/MG modulation.

00 - 15

### 2. Using the oscillator modulation intensity function.

- Press 5 then 1, or use DATA ENTRY A to select the function.

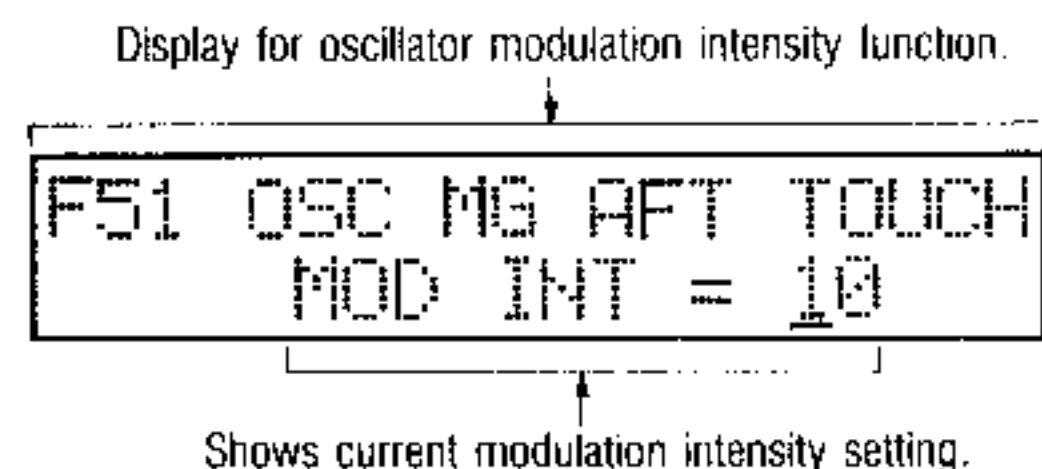

- Use DATA ENTRY B to adjust the value.

## F52 VCF CUTOFF/MG MOD

### 1) The VCF cutoff/MG modulation function.

This lets you use after-touch to sweep the cutoff frequency or control cyclic modulation (wah-wah effect) of the VCF. You can choose either CUTOFF or MG-MOD.

Possible mode settings  
MG-MOD, CUTOFF

#### ● Cutoff:

If you select this mode, then after-touch pressure causes an upward filter sweep, increasing the brightness of the sound. The higher the value, the greater the timbral change.

Possible values  
00--15

#### ● MG modulation:

If you select this mode, then after-touch pressure controls the intensity of the wah-wah effect (cyclic filter modulation). The higher the value, the greater the change.

Wah-wah frequency (speed) is determined by the F34 VCF modulation mode function setting.

If mode is set to cutoff.

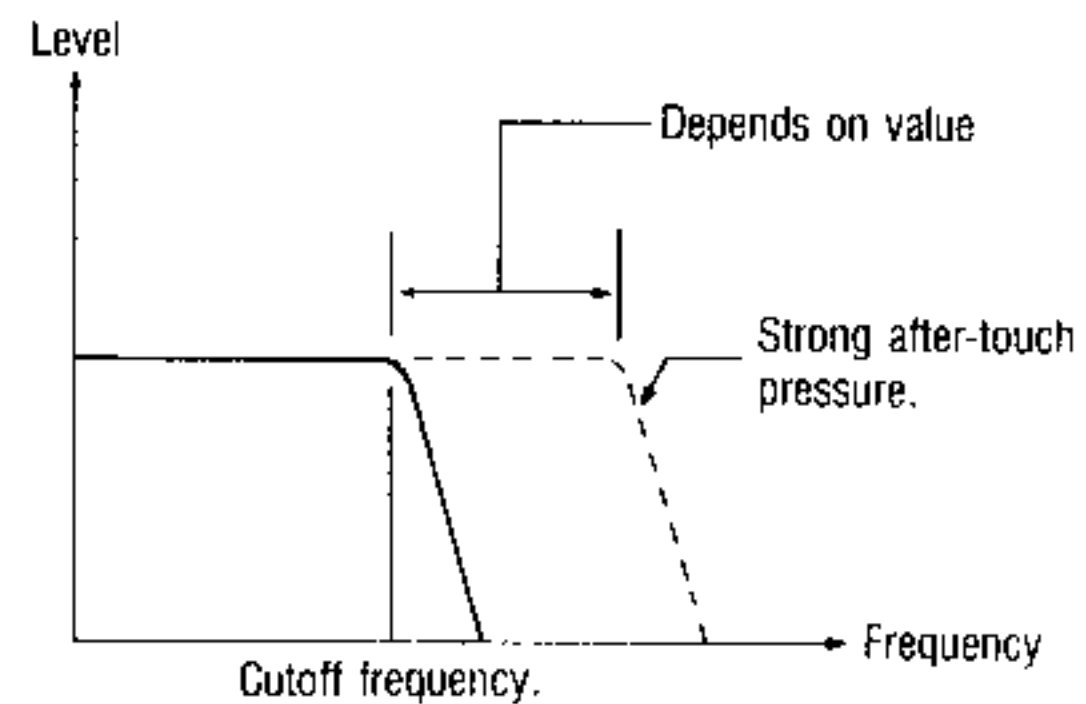

### 2) Using the VCF cutoff/MG modulation function.

- Select the function by pressing 5 then 2 on the number keys or by moving the DATA ENTRY A slider.
- Move the cursor to the parameter that you wish to change. Then use DATA ENTRY B to select its value.

Display for the VCF cutoff/MG modulation function.

F52 VCF AFT TOUCH  
MODE=MG-MOD VALUE=10

Mode selection.      Value

## F53 VCA TOTAL LEVEL

### 1 The VCA total level function

- This lets you use after-touch to control VCA total level. Higher values allow control to begin from lower levels.

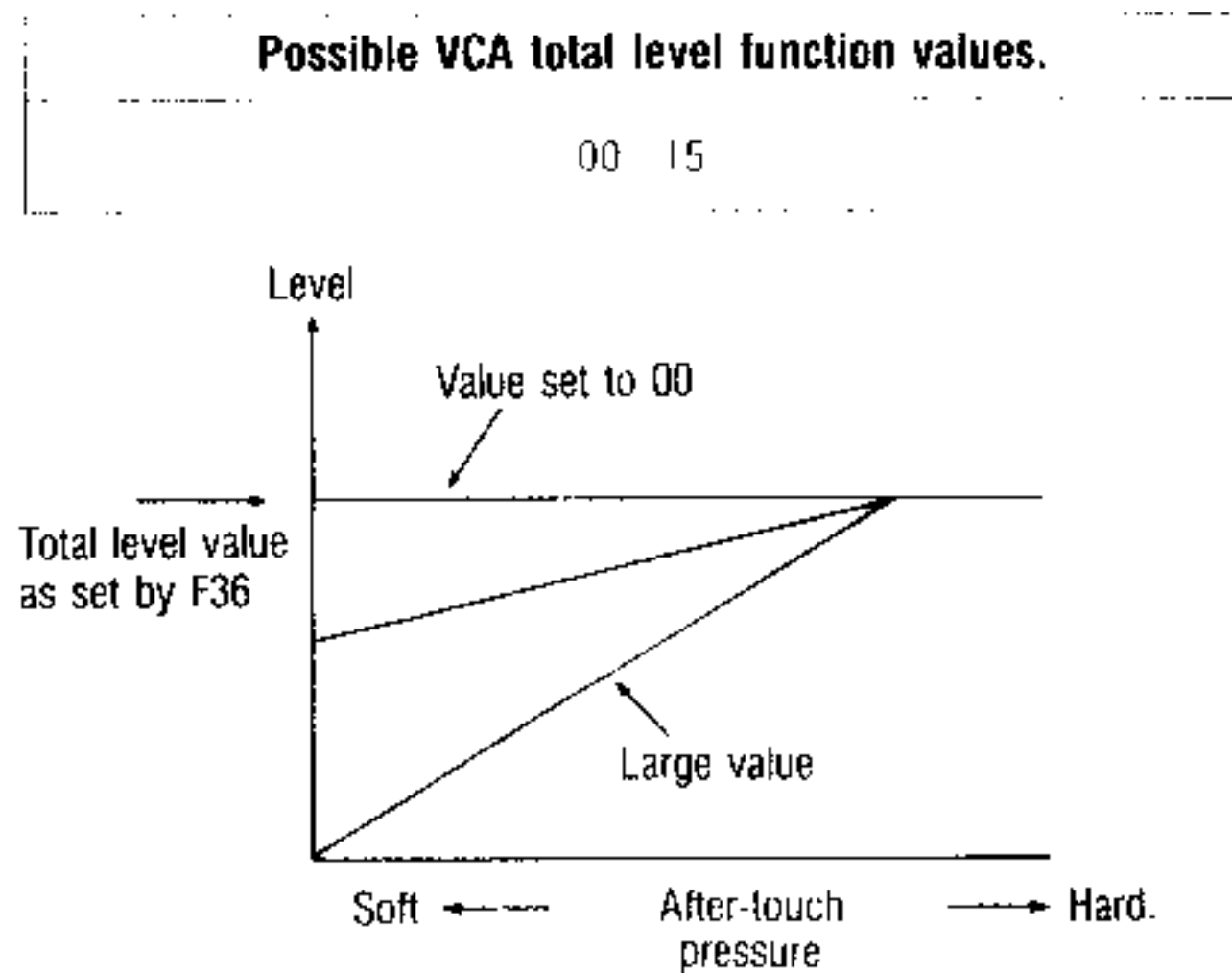

### 2 Using the VCA total level function

- Press 5 then 3, or use DATA ENTRY A to select the function.
- Adjust the value by moving DATA ENTRY B.

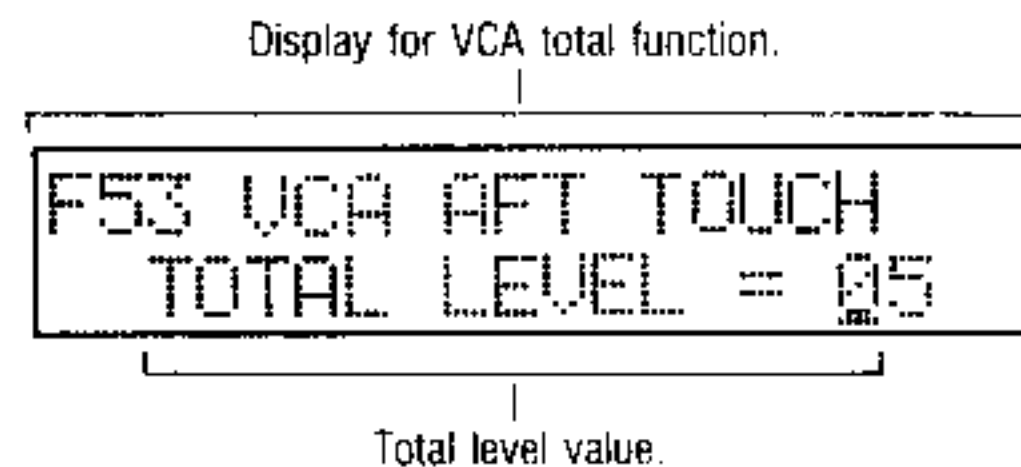

## JOY STICK FUNCTION GROUP

The DSS-1 joystick can be used to control a variety of effects. F61 and F62 let you adjust parameters for pitch bends and filter sweep.

## F61 PITCH BEND RANGE

### 1 About the pitch bend range function

- This sets the range of pitch change produced when the joystick is moved left and right. It can be set in semitone steps up to a maximum range of one octave up and down.

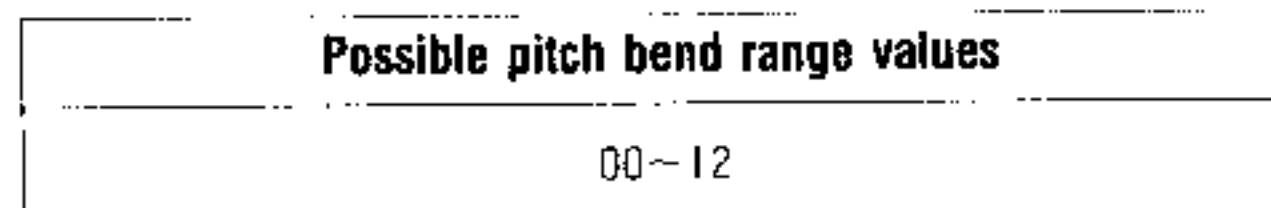

**1 Using the pitch bend range function.**

- Select the function by pressing 6 then 1 on the number keys or by moving the DATA ENTRY A slider.
- Use DATA ENTRY B to adjust the value.

- Note that if this parameter's value is set too high then some keys may not change in pitch when you move the joystick to the right. This condition is indicated by a "Warning" in the display. This occurs when the pitch bend extends beyond the "pitch transpose upper limit" of the sound assigned to that part of the keyboard.

(Refer to page 40.)

A sound with a sampling frequency of 32kHz, for instance will have a "pitch transpose upper limit" of one octave. If you raise the intensity setting too high, then you may exceed this range when you bend the pitch upward.

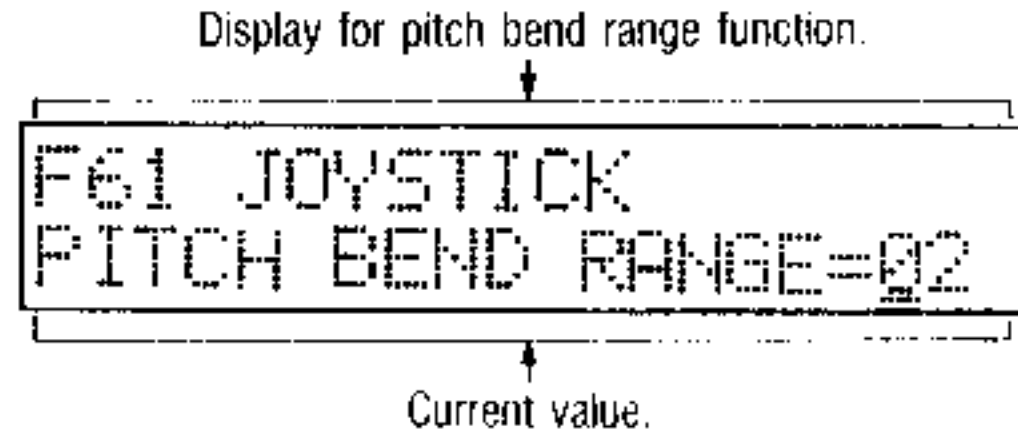

- Possible situation for some keys when pitch bend range is set very high.

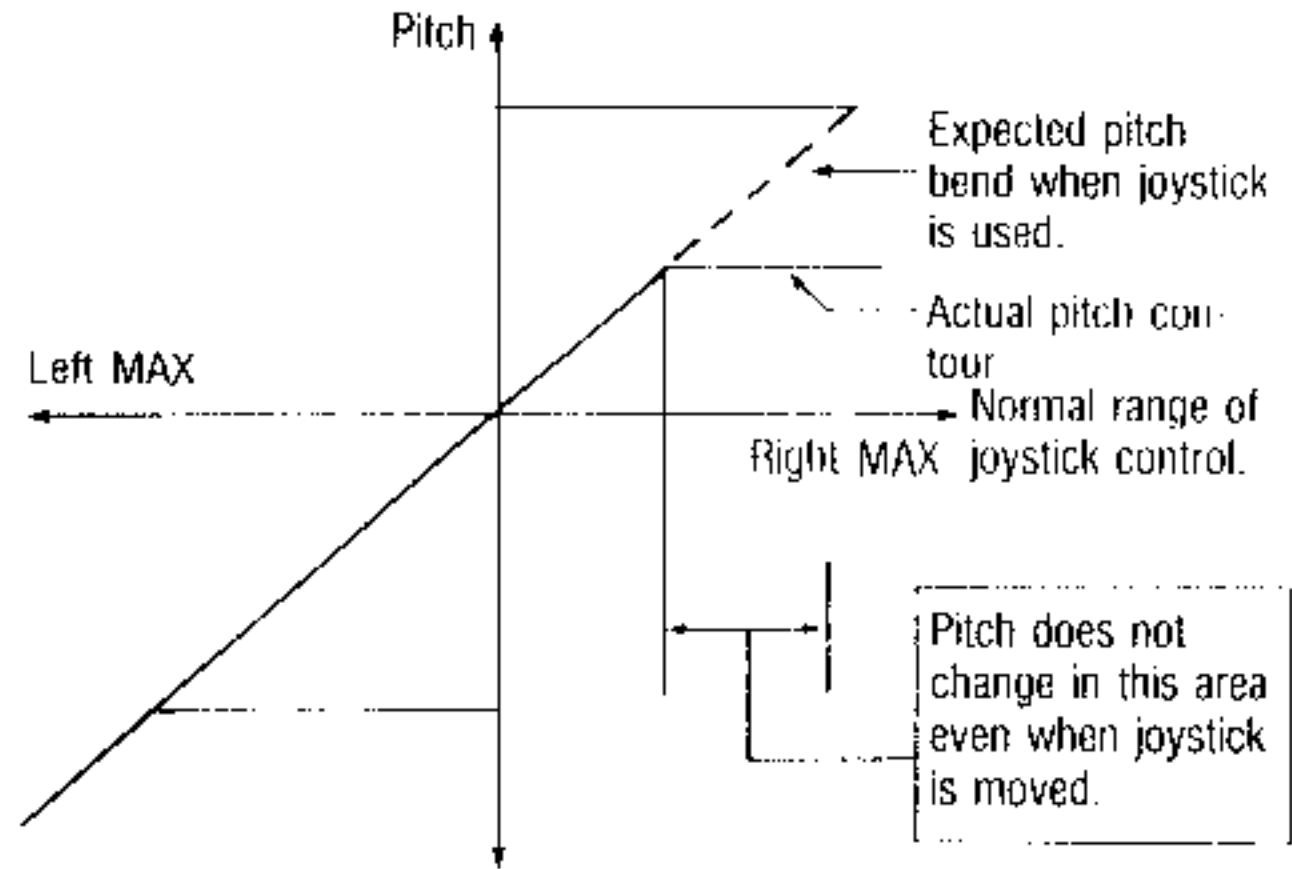

A "Warning" appears in the display if keys producing this effect appear within the keyboard.

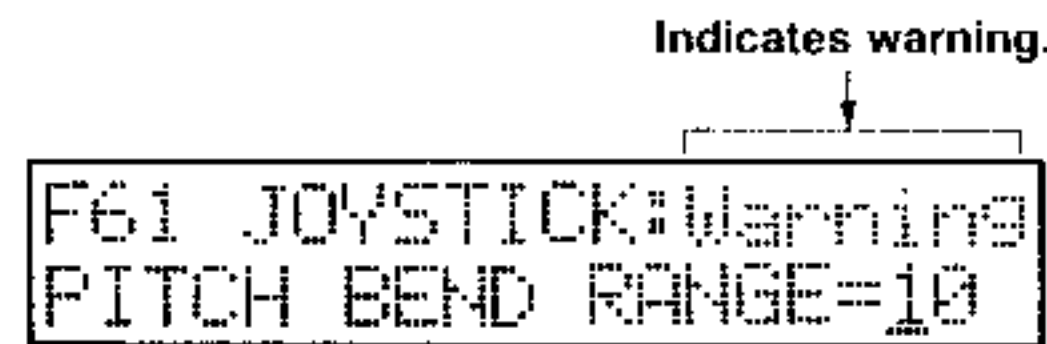

## F62 VCF SWEEP ON/OFF

**1 About the VCF sweep on/off function.**

- Left and right movement of the joystick can be used to sweep the VCF cutoff frequency up and down. F62 lets you choose to turn this feature on or off.

**2 Using the VCF sweep on/off function.**

- Press 6 then 2, or use DATA ENTRY A to select the function.
- Adjust the value by moving DATA ENTRY B.

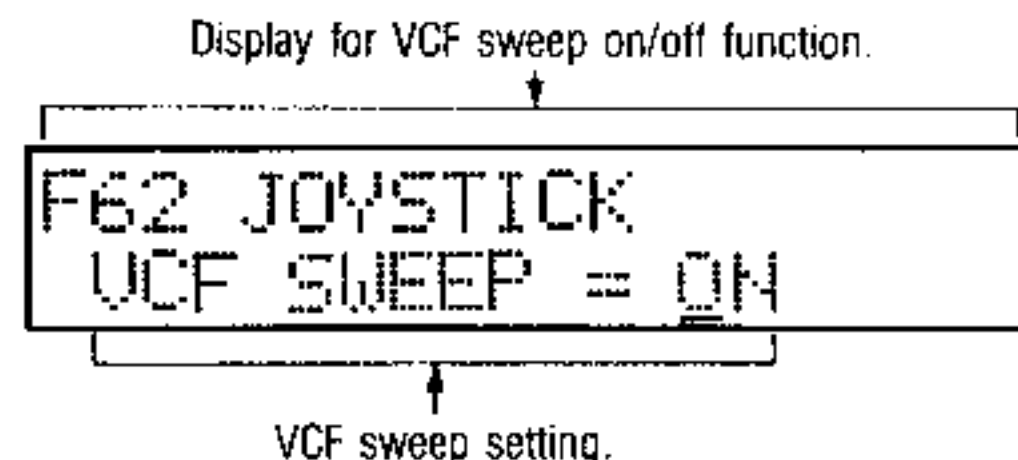
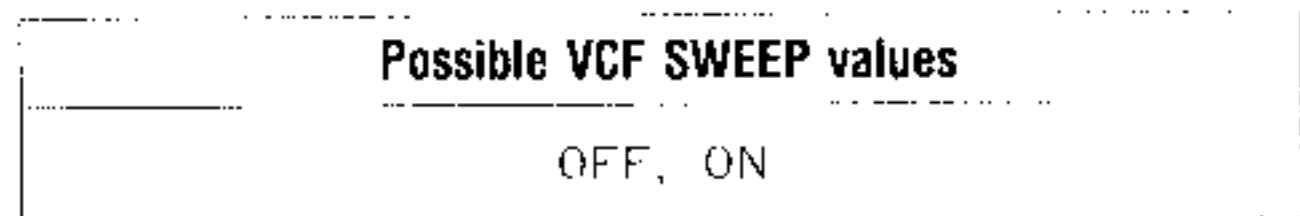

# KEY ASSIGN FUNCTION GROUP

The DSS-1 has eight synthesizer voices. The functions in this group let you decide how the voices will be used when keys are played. You have a choice of three key assign modes. (POLY-1, POLY-2, and UNISON). You can also select how many voices will be used and the degree of detuning when using the UNISON mode.

## F63 KEY ASSIGN MODE

### 1) About the key assign mode.

■ Choose the POLY-1, POLY-2, or UNISON mode, according to the sound and playing style that you intend to use.

#### ● POLY-1:

Here the eight voices are assigned sequentially as notes are played. If the same note is played repeatedly, it will be articulated repeatedly (overlapping previous notes) since it is produced by a new voice each time. For polyphonic play.

#### ● POLY-2:

Here the same voice will be used if the same key is played repeatedly. Therefore, it will not be articulated separately and will not overlap. For polyphonic play.

#### ● UNISON:

This is a monophonic mode that is useful for playing melody, lead solo and bass parts. Voices are used in accordance with the settings in the F64 unison detune & voices function.

This uses multiple triggering, causing the envelope to retrigger every time a new key is pressed (so you can play legato style and get a new note with each key played, without having to release the previous key).

Possible values for key assign.

POLY-1, POLY-2, UNISON



Always changes to the next voice each time a key is played.

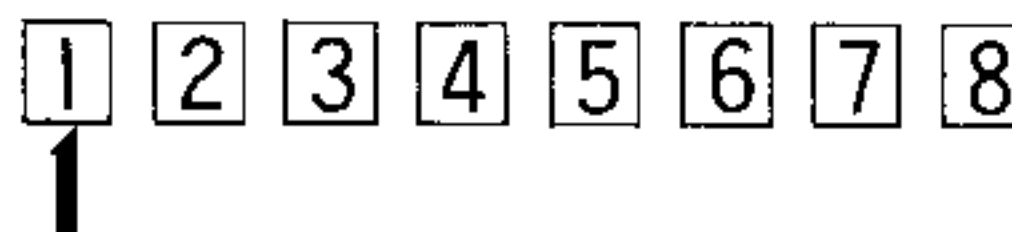

If the same key is played repeatedly then the same voice is used. (Other voices are used as other keys are played.)

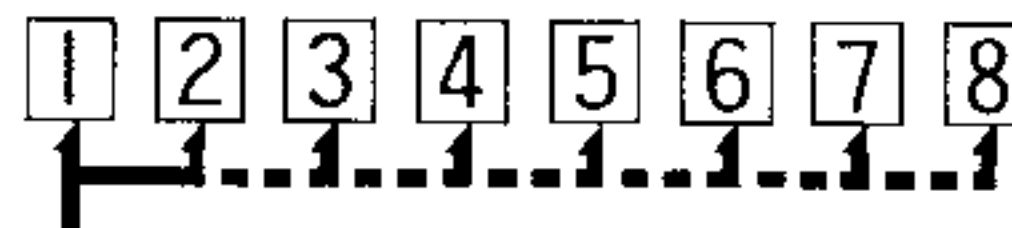

When a key is played, voices are used according to settings in F64.

**2) Using the key assign mode function.**

- Press 6 then 3, or use DATA ENTRY A to select the function.
- Use DATA ENTRY B to adjust the value.

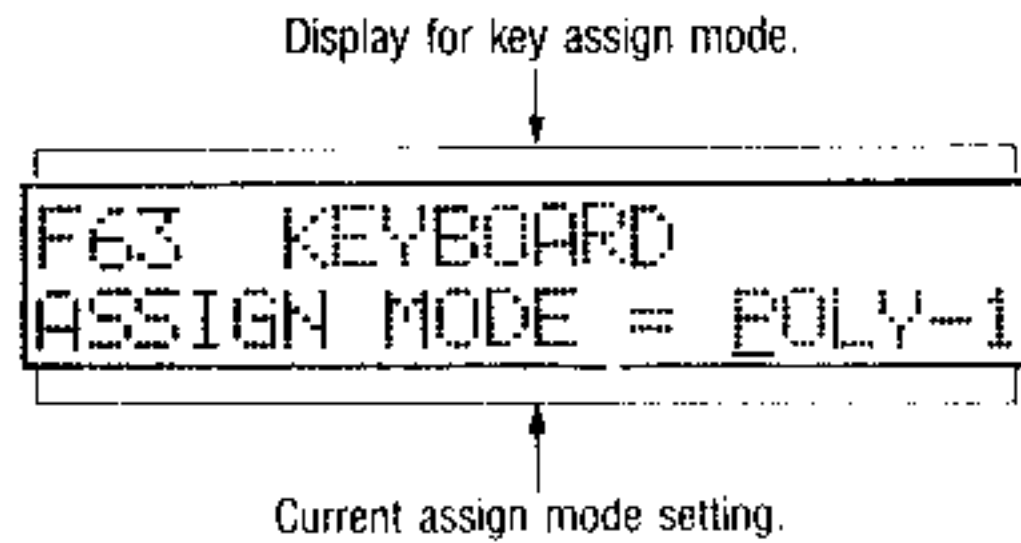

## F64 UNISON DETUNE & VOICES

**1) The unison detune & voices function.**

- This determines the fatness of the sound when the unison mode is selected. There are two parameters.
- **Unison detune:**  
The voices are detuned by a small amount as set in this parameter. The larger the value, the more the detuning, and therefore the fatter the sound.
- **Voices:**  
You can choose to use two, four, six or eight of the voices when in the unison mode.

**Possible unison detune values.**

01 - 08

**Possible voices values.**

02, 04, 06, 08

**2) Using the unison detune & voices function.**

- Press number keys 6 then 4, or move the DATA ENTRY A slider to select the function.
- Move the cursor to the parameter that you wish to change. Then use the DATA ENTRY B slider to change the setting.

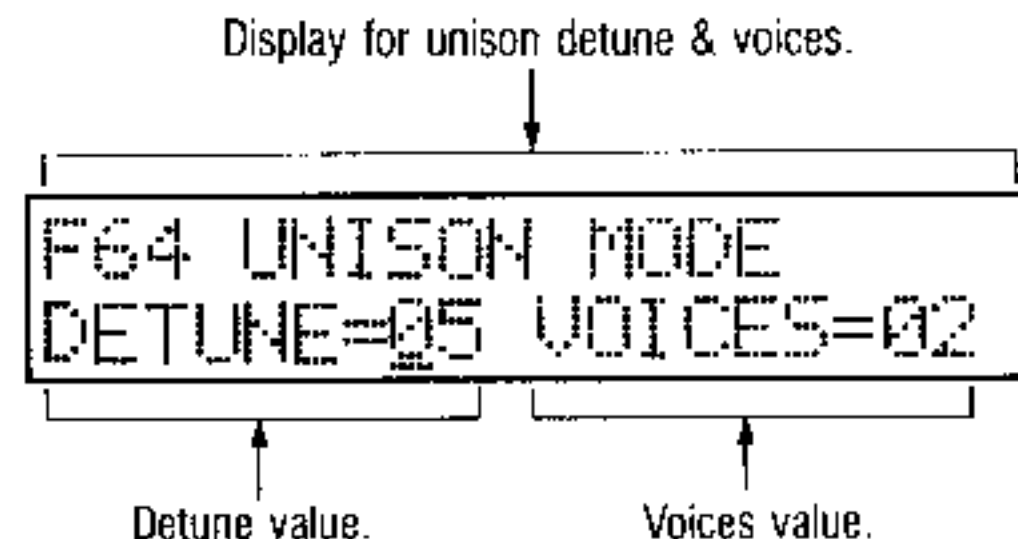



# EQUALIZER/DIGITAL DELAY FUNCTION GROUP

F65 through F96 are functions concerned with the equalizer and digital delay. These affect the tone, and delay effects such as chorusing, doubling, and hollow reverb.

## F65 EQ (BASS, TREBLE)

1 | The equalizer (bass, treble) function.

■ These parameters let you adjust the bass and treble aspects of the tone of the audio signal downstream from the VCA.

● **Bass:**  
Lets you boost or attenuate the low bass.

● **Trebles:**  
Lets you boost or attenuate the high treble.

Possible bass values.

4 - +8

Possible treble values.

-4 - +8

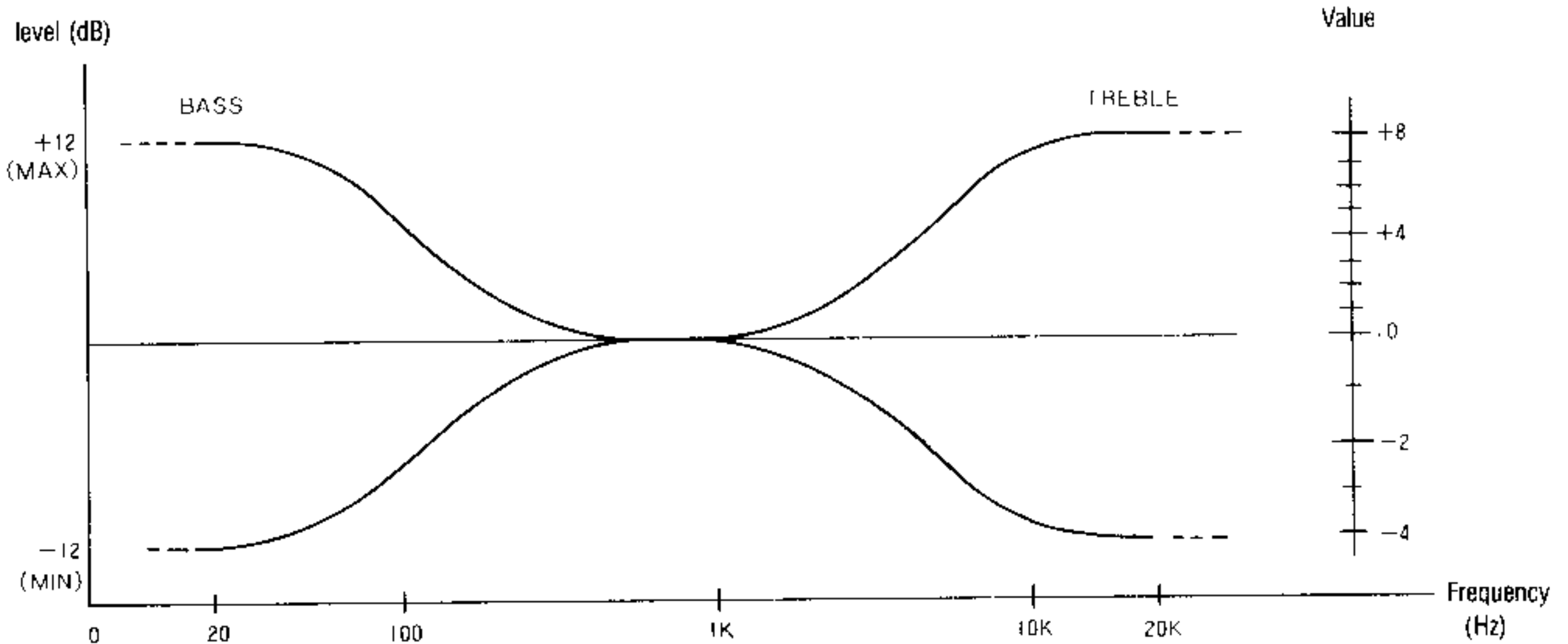

2 | Using the equalizer (bass, treble) function.

■ Press number keys 6 then 5, or move the DATA ENTRY A slider to select the function.

Display for equalizer (bass, treble) function.

```

F65 EQ LEVEL
BASS =+4  TREBLE =+2
    
```

Bass value

Treble value.

■ Move the cursor to the parameter that you wish to change. Then use the DATA ENTRY B slider to adjust the value.

# F71 DDL MG FREQUENCY

## 1 DDL MG frequency function

- The DSS-1 digital delay is equipped with two dedicated modulation generators. Each MG can be set to a different frequency. Using these, the DDL-1 and DDL-2 delay times can be modulated independently or together, making possible a broad spectrum of valuable effects.

### Possible values for the DDS MG frequency function.

A.....00--63

B.....00--63

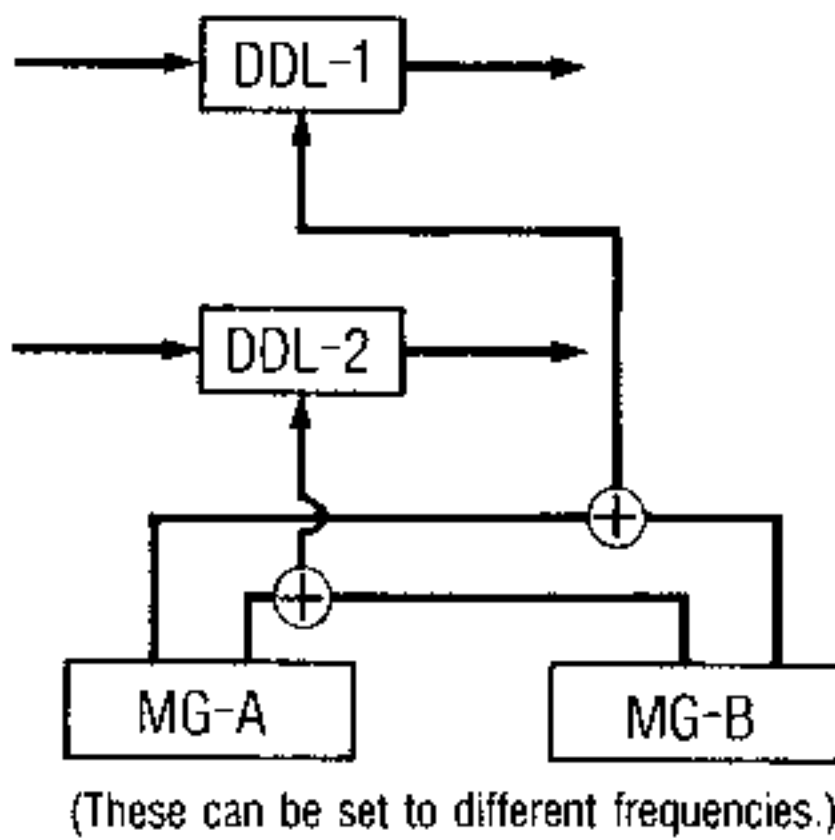

## 2 Using the DDL MG frequency function.

- Press 7 then 1 in the number key pad, or move the DATA ENTRY A slider to select the function.

Display for the DDL MG frequency function.

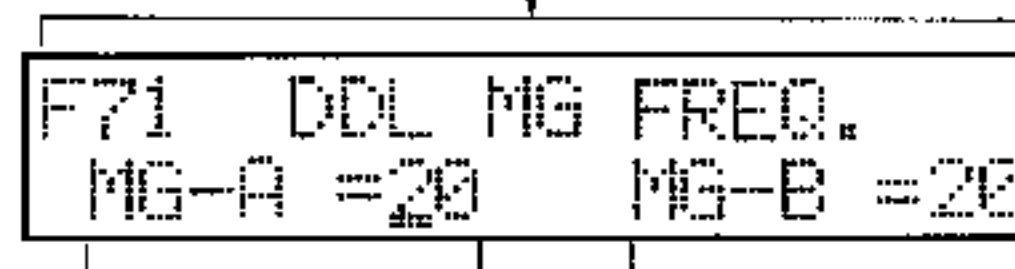

Setting for modulation generator A.    Setting for modulation generator B.

- Move the cursor to the parameter that you wish to change. Then use the DATA ENTRY B slider to make the adjustment.

## F81, F92 TIME

### 1 The time function.

- This lets you set the delay time for one or the other of the digital delays, DDL-1 or DDL-2. The delay time may be set over a range of 0ms (zero milliseconds) to 500ms (half a second). The shorter settings are used for chorusing and flanging effects. The longer delay times are used for long and short delay or echo effects.

### 2 Using the time function.

- Use the number keys or the DATA ENTRY A slider to select function F81 or F92.

- Use DATA ENTRY B to adjust the value.

## F82, F93 FEED BACK

### 1 The feedback function.

- This lets you adjust the amount of feedback in the delay effect produced by DDL-1 or DDL-2. Feedback refers to taking the delayed output signal and feeding it back into the input to be delayed again. With longer delay times, the amount of feedback determines the number of discrete echoes. With shorter delay times, a large feedback setting can produce flanging effects.

### Possible time values.

000ms - 500ms

Display for the time function.

```
F81  DDL-1
    TIME = 085ms
```

Current delay time setting.

```
F92  DDL-2
    TIME = 250ms
```

### Possible feedback values.

00-15

## ② Using the feedback function.

- Press 8 then 2 (or 9 then 3), or use DATA ENTRY A to select the function.

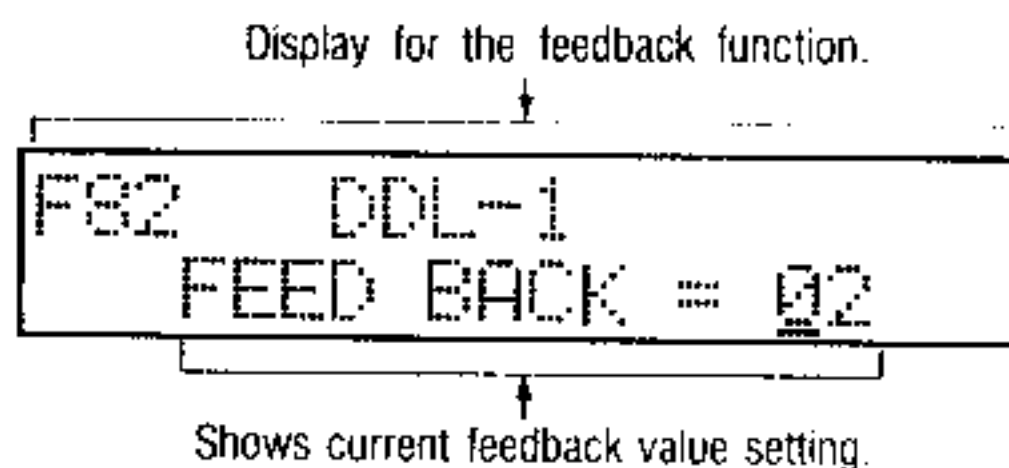

- Use DATA ENTRY B to adjust the value.

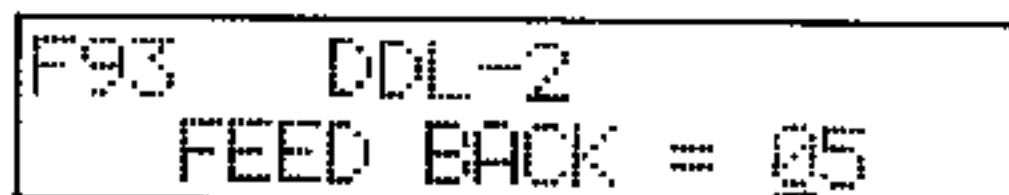

## F83, F94 EFFECT LEVEL

### ① The effect level function.

- This lets you adjust the level of the delayed sound from DDL-1 or DDL-2 in the mix. At a setting of 00, you hear only the direct sound, without any delay effects.

#### Possible values for the effect level function.

00~15

## ② Using the effect level function.

- Press 8 then 3 (or 9 then 4), or use DATA ENTRY A to select the function.

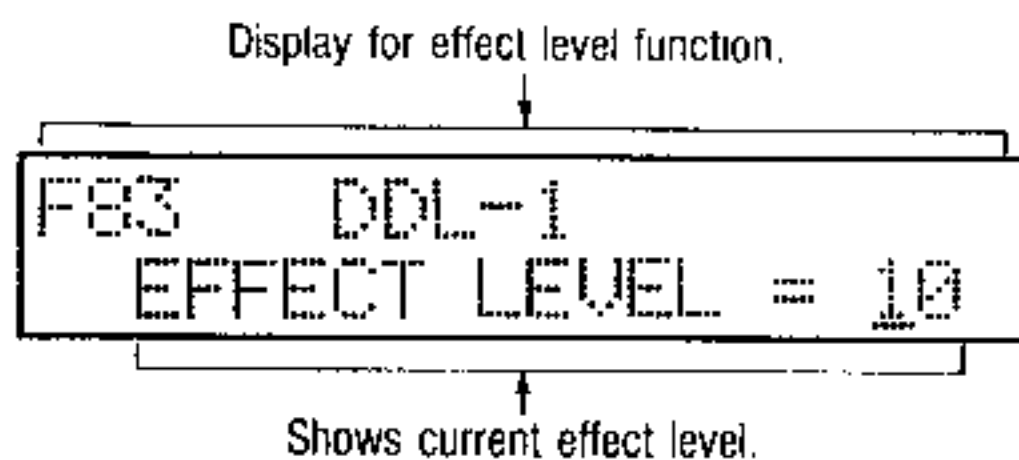

- Use DATA ENTRY B to adjust the value.

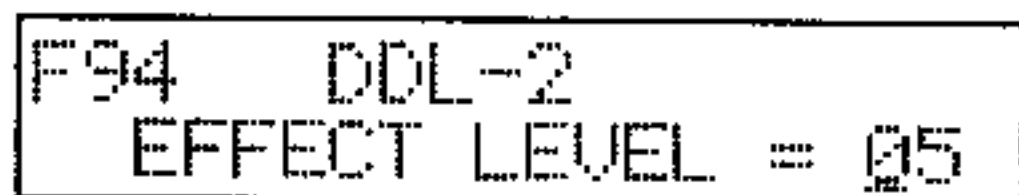

## F84, F95 MOD INT

### 1] The modulation intensity function.

■ This controls the intensity of modulation of the DDL-1 and DDL-2 delay times as applied by the two modulation generators (MG-A and MG-B). (Each of the DDLs can be modulated by both of the MGs.) Raising the value of MG-A, for instance, means that the delay time will be modulated more strongly by the MG-A frequency. The same goes for MG-B. If both are given values higher than 00 (and if they are set to different frequencies), then the modulating waveform becomes quite complex, with corresponding complexity of the effect produced by the digital delay.

#### Possible values for the modulation intensity function.

A.....00 - 63

B.....00 - 63

- Example, using modulation generators A and B set at different frequencies.

MG-B output waveform.

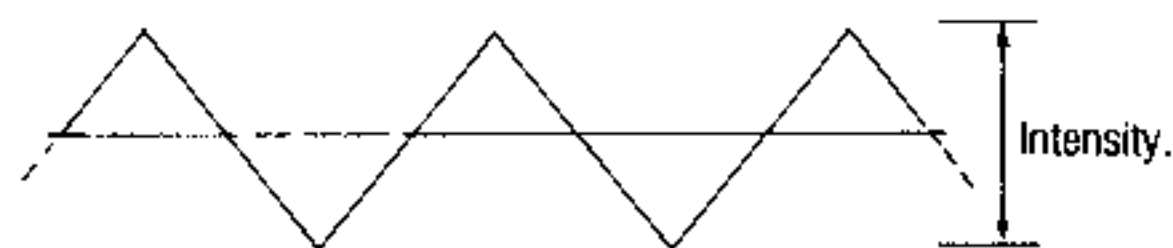

MG-A output waveform.

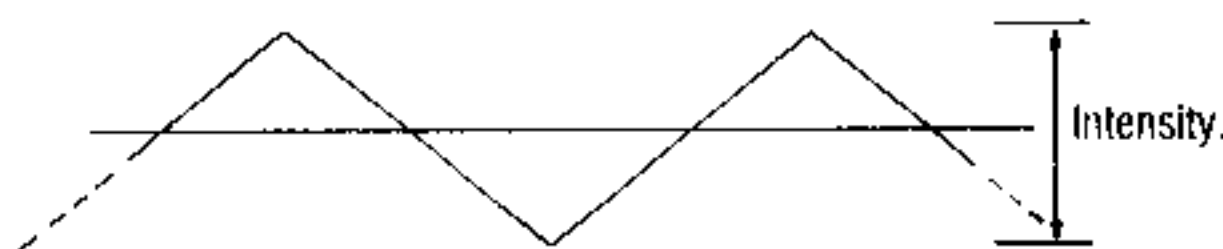

MG-A and MG-B output used together.

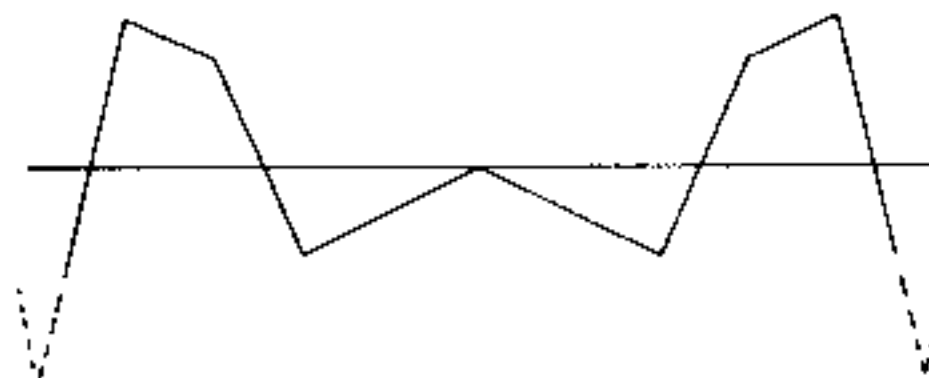

**2. Using the modulation intensity function.**

- Press number keys 8 then 4 (or 9 then 5), or move the DATA ENTRY A slider to select the function.

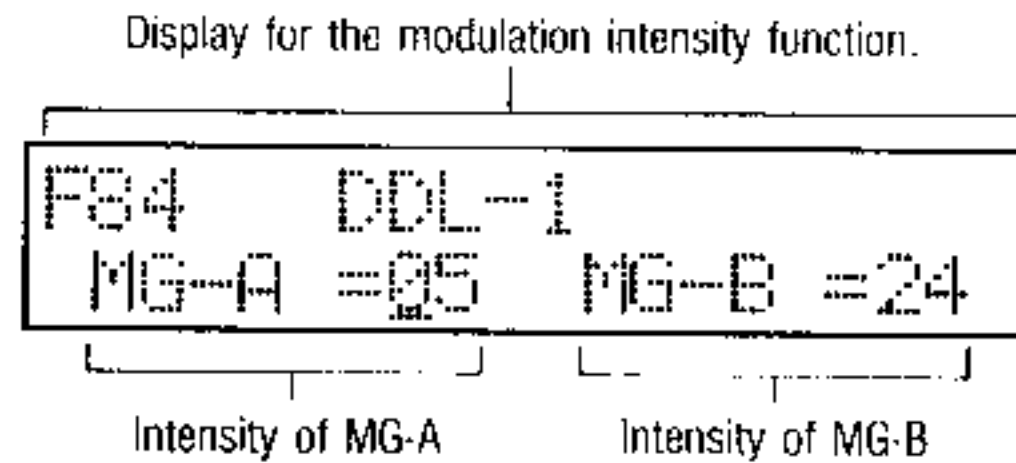

- Move the cursor to the parameter that you wish to change. Then use the DATA ENTRY B slider to change the value.

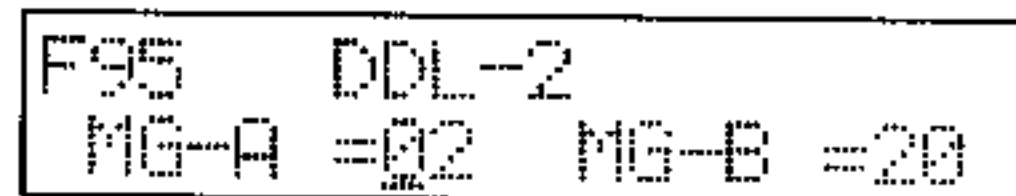

# F91 INPUT SIGNAL SELECT

**1. About the input signal select function.**

- This gives you a choice of which signal to use as the input for DDL-2. You may choose either the direct signal or the DDL-1 output signal. For typical stereo effects, you would choose to use the direct sound since this will give you an independent delay for each of the two outputs.
- For other effects, you may choose DDL-1 as the input, thereby connecting the two delays in series and modulating the first effect with the second effect.

**Possible input signal select function values.**

DIRECT, DDL-1

- The delays may be internally connected as shown here.

If DIRECT is chosen.

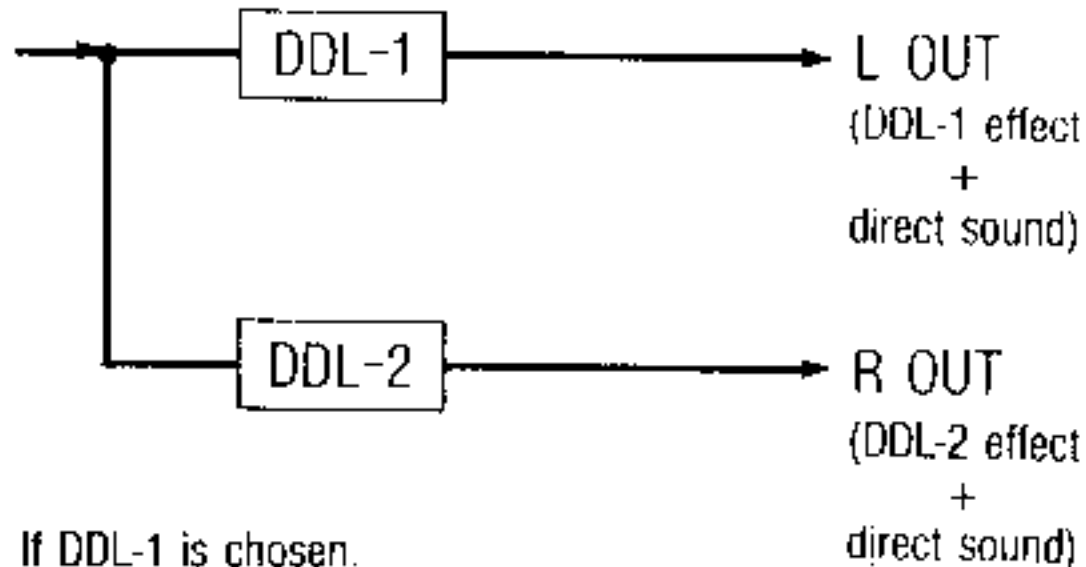

If DDL-1 is chosen.

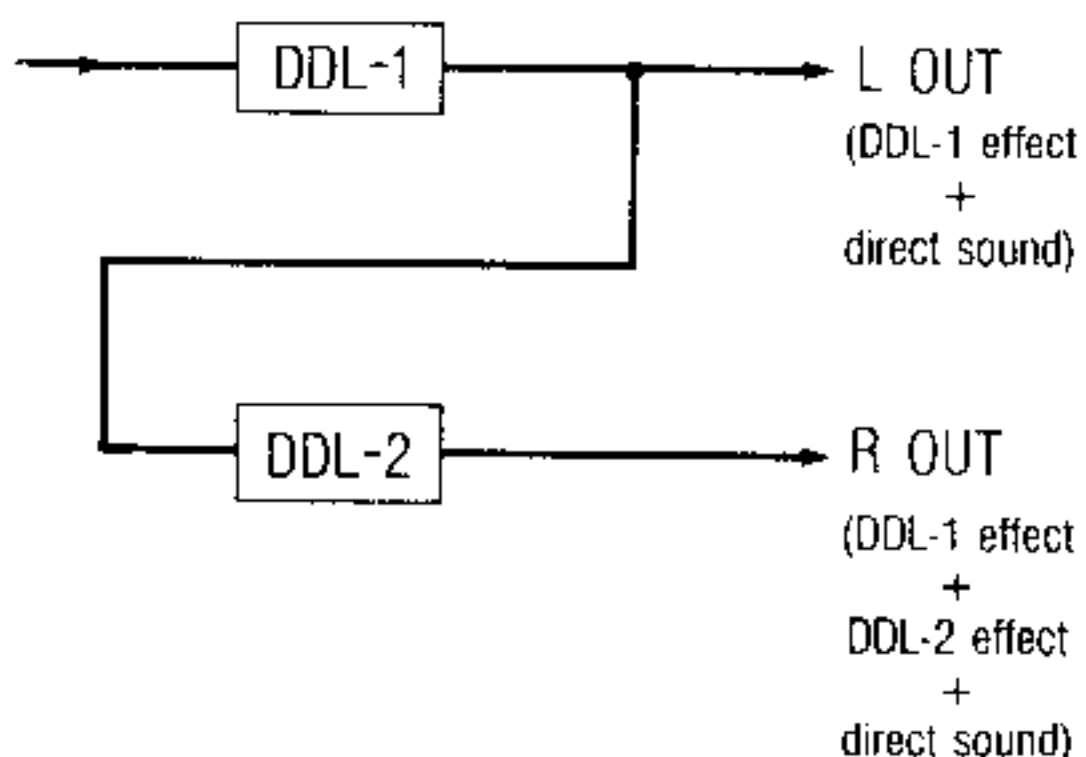

## F96 MOD INVERT SW

### 1] About the modulation invert switch function.

- If this is on, then the phase of the waveform is reversed for the signal modulating DDL-2. This is typically used in stereo chorusing and other effects where you want more spacious ambience in the sound.

### Possible settings for the modulation invert switch function.

OFF, ON

- Diagram of modulation invert switch operation.

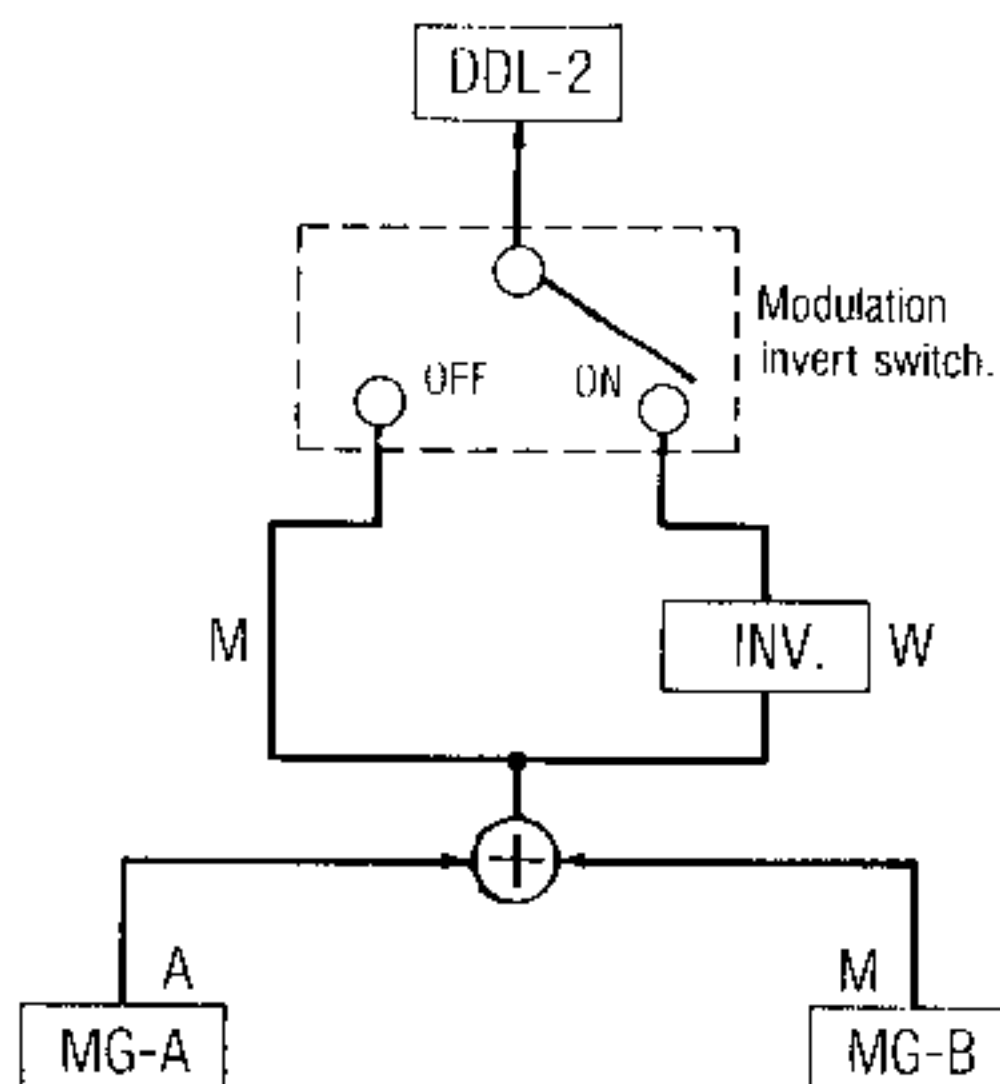

### 2] Using the modulation invert switch function.

- Press 9 then 6, or use DATA ENTRY A to select the function.

Display for the modulation invert switch function.

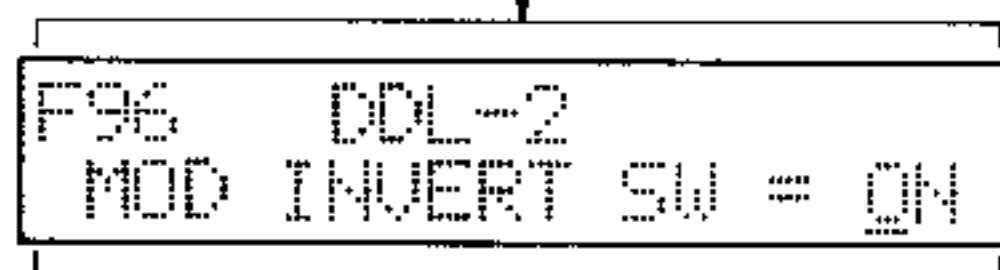

Current modulation invert switch setting.

- Use DATA ENTRY B to adjust the value.

# SYSTEM MODE

## 1. About Each of the Functions

### F1 GET SYSTEM

#### About the get system function

- This function lets you select one of the four "systems" on a disk and load it into memory.

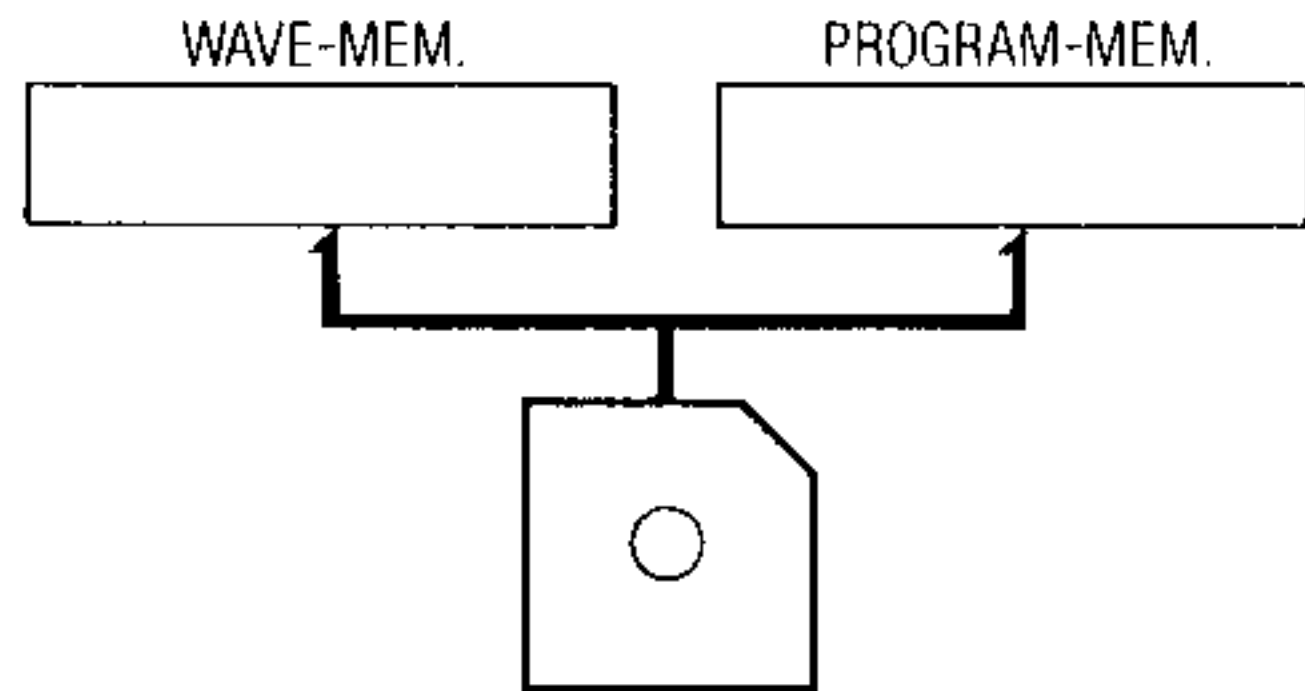







The sounds go into wave memory and the programs go into program memory.

- When you get a system you also get MIDI parameters that have been saved with that system.

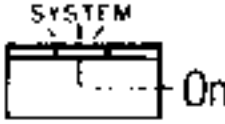
- If you perform the "get system" function when one of the system's multisounds (as stored in its multisound list) has been deleted, then the display will say "SYSTEM Incompleted". If you use F7 to view the multisound directory, in place of the deleted multisound name you will see "?NO-MSND".

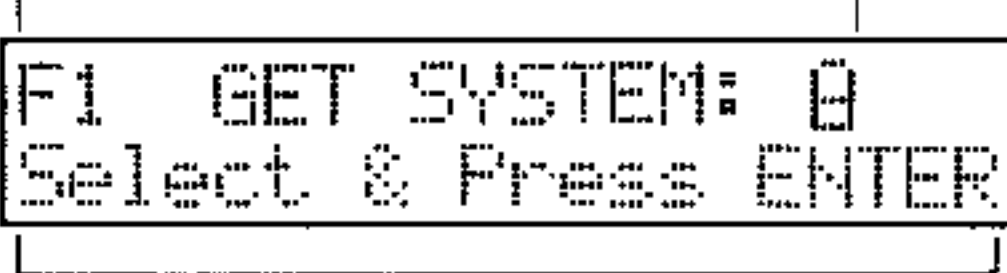

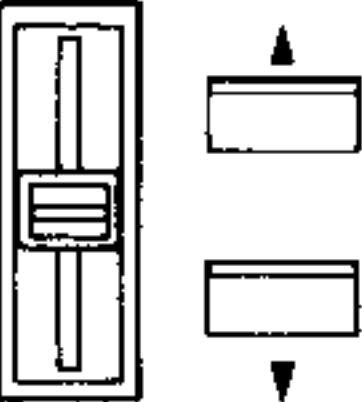
② Using the get system function

Operation	Operation of DSS-1
<p>① Select the SYSTEM mode. Put in the disk that has the system that you want to load.</p>	<ul style="list-style-type: none"> <li>● Indicates SYSTEM mode.</li> </ul> 
<p>② Press the number 1 key.</p> <p>Press </p>	<ul style="list-style-type: none"> <li>● The display shows the currently selected system.</li> </ul> <p>Shows the get system function.</p>  <p>ENTER  Shows you can select the system.</p>
<p>③ Use DATA ENTRY A to select the system of your choice.</p> <p>DATA ENTRY A</p>  <p>Use to select System of your choice </p>	<p>Shows the selected system.</p> 

3 Press ENTER.



- You are asked whether it is okay to get the selected system.

Shows the load system.

```
F1 GET SYSTEM: A
Are You Sure? (Y/N)_
```

4 Press YES or NO to reply.

- ★ Press YES to proceed to load the selected system from disk to memory.



- The display confirms loading and gives you the function selection prompt upon completion.

```
F1 Loading...
Please Wait a Minute
```

Shows the loaded system.

```
F1 SYS:A Completed
Select (1-9):_
```

Shows you can select a function.

★ Press NO to abort.



- You can now choose another function or change modes.

```
F1  Aborted
    Select (1-9): _
```

Shows you can select a function.



## F2 SAVE SYSTEM

### 1 About the save system function

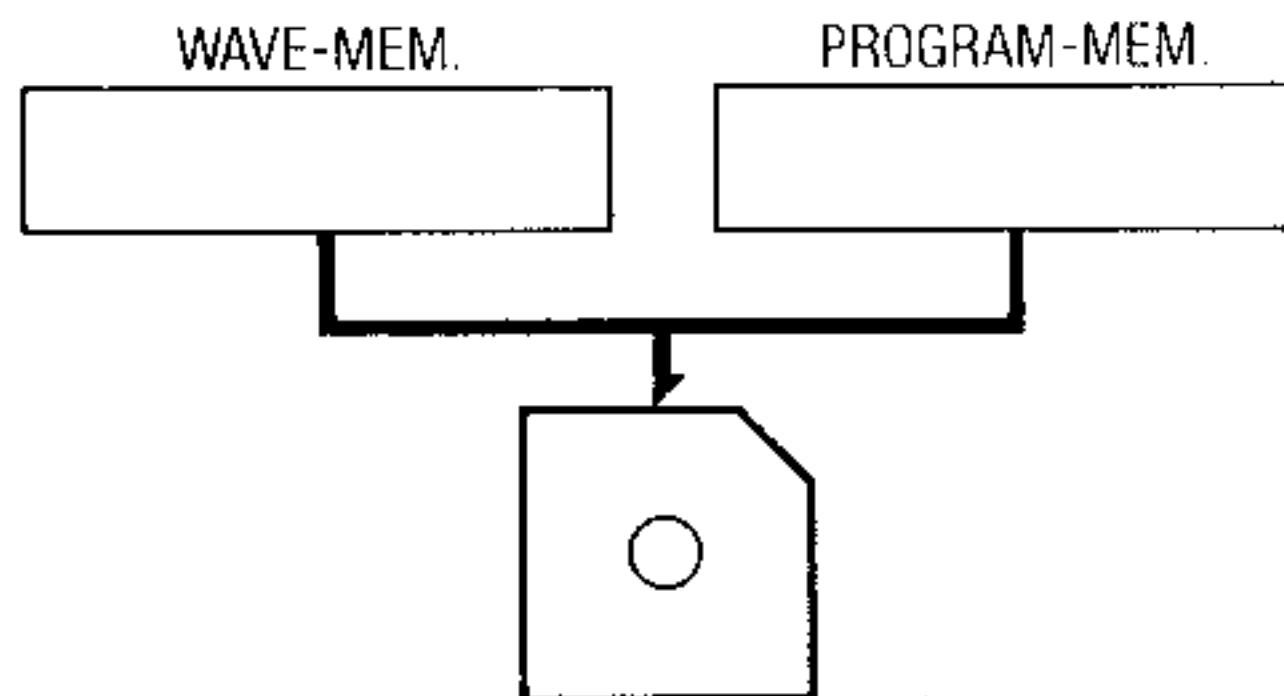
- This function is used to save the system in memory to disk as a system labeled A, B, C, or D.
- Saving a system having no multisounds is the same as using the All Program Save function. The display will show "No M. SNDs Exist". The program contents on disk will change.
- Current MIDI parameters are saved with the system.

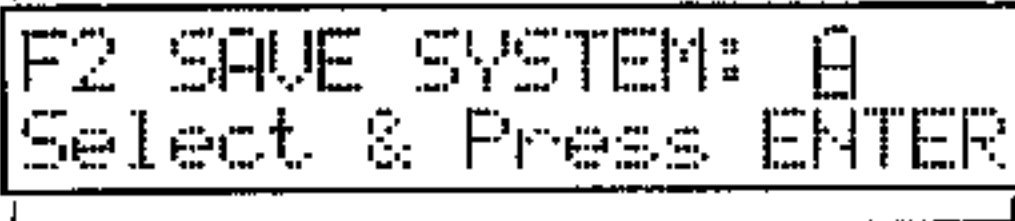

### 2 Using the save system function.

Operation	Operation of DSS-1
<p>① Select the SYSTEM mode. You must have a disk in the drive. You will save the system to the disk that is in the drive. Therefore, don't put in a disk that is full of systems that you want to keep.</p>	<ul style="list-style-type: none"> <li>● Indicates SYSTEM mode.</li> </ul> 
<p>② Press the number 2 key.</p> 	<ul style="list-style-type: none"> <li>● The display shows the currently selected system.</li> </ul> <p>Shows the save system function.</p>  <p>ENTER indicator light icon.</p> <p>Flashes. Shows you can select a system.</p>

- 2 Use DATA ENTRY A to select the system letter (A, B, C, D) under which you wish to save the system that currently resides in memory.

DATA ENTRY A

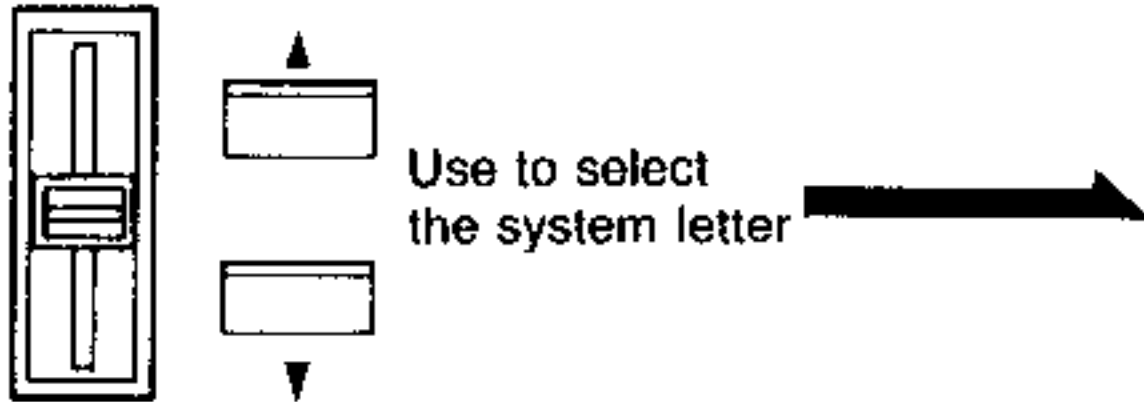

Shows the selected system.

```
F2 SAVE SYSTEM: B
Select & Press ENTER
```

- 3 Press ENTER to proceed.



- You are asked to confirm whether it is okay to save the system in memory to disk under the system letter displayed.

Shows the displayed system.

```
F2 SAVE SYSTEM: B
Are You Sure? (Y/N)_
```

- 4 Reply by pressing the YES or NO key.  
★ If you wish to save the system to that disk as the selected system letter, then press YES.



- After saving, you can choose another function or change modes.

```
F2 Saving...
Please wait a Minute
```

Shows the saved system.

```
F2 SYSTEM: A Saved
Select (1-9): _
```

Shows you can select a function.

★ Press NO if you do not want to save the system in memory to the inserted disk under the selected system letter.



- This aborts the function. You can now choose another function or change modes.

```
F2   Aborted
      Select (1-9):_
```

Shows you can select a function.

- When saving a system, the DSS-1 checks the disk to see whether there are any multisounds already on the disk that have the same name as any multisound in wave memory. If there is duplication, then you are asked whether it is okay to delete the multisound(s) on the disk. If you don't delete, then the multisound in wave memory having the duplicate name will not be saved. The system save function then continues. If you delete, then the system save function continues, saving those multisounds from wave memory to disk under those names.

Refer to the F9 SAVE/RENAME M.SOUND function in the multisound mode for details on the deletion operation.



# F3 PROGRAM DIRECTORY

## 1 About the program directory function

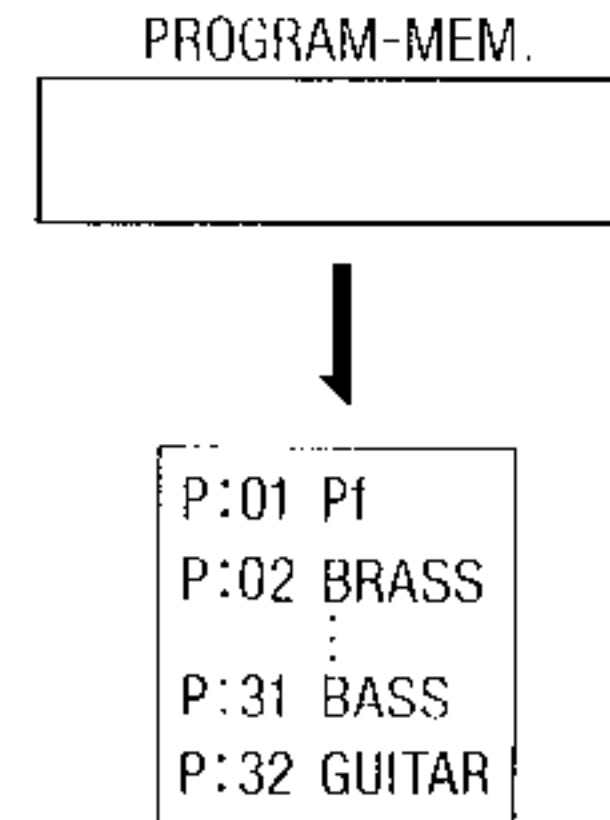
- This function displays the names of programs currently residing in program memory.

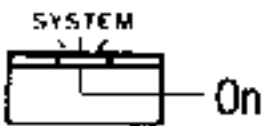

## 2 Using the program directory function

Operation	Operation of DSS-1
<p>① Confirm selection of the SYSTEM mode.</p>	<ul style="list-style-type: none"> <li>● Indicates SYSTEM mode.</li> </ul>  <ul style="list-style-type: none"> <li>● The display prompts you to choose a function.</li> </ul>
<p>② Press the number 3 key.</p> <p>Press </p>	<ul style="list-style-type: none"> <li>● The display shows the currently selected system.</li> </ul> <p>Display for program directory.</p>  <p>Says use DATA ENTRY A.</p>

SYSTEM MODE

2 Use DATA ENTRY A to look at the program directory.

DATA ENTRY A

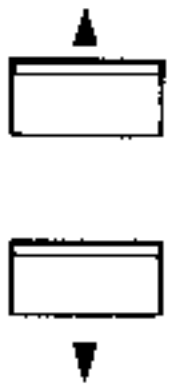
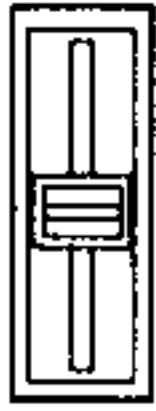

Use to look at the Program Directory



```
F3 PROGRAM DIRECTORY  
No.01 : TEST-#01
```

Shows the program number and name



# F4 GET PROGRAM

## 1 About the get program function

- This gets a program from a system on disk and loads it into the program output buffer.
- Within this function you can write the loaded program to any program memory number that you like.

### Note:

The program name displayed in the play mode is the name of the program currently in the program output buffer. Therefore, if at this point you go to the play mode without writing, the name of the program that you got will be displayed but will not have been written to the program memory.

### Example:

1. Select program change P01: "P01:A"
2. In the system mode, get program name "B" but don't write it.
3. Display just after going to the play mode: "P01:B"
4. Select program change P01: "P01:A"

(In step 4, the contents of the program output buffer were changed to A. Program B was lost in the process.)

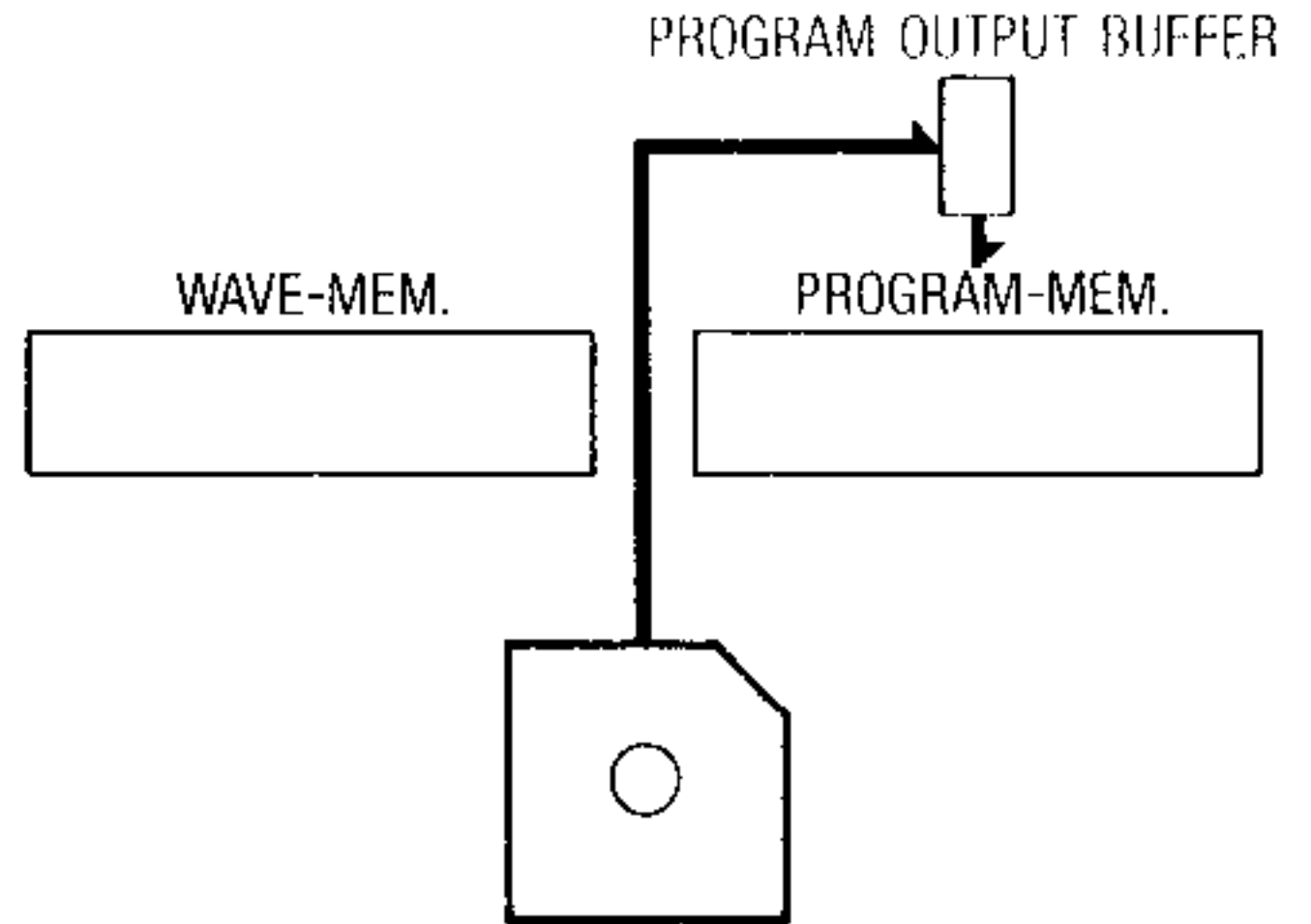

## 2 Using the get program function

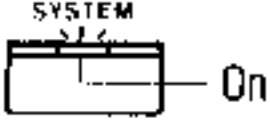
Operation	Operation of DSS-1
<p>① Confirm the SYSTEM mode.</p>	<ul style="list-style-type: none"> <li>● Indicates SYSTEM mode.</li> </ul> 
<p>① Put in the disk that has the program that you wish to load. Press the number 4 key.</p> <p style="text-align: center;">Press <span style="border: 1px solid black; padding: 2px 5px;">4</span> </p>	<ul style="list-style-type: none"> <li>● The display shows the default values for system and program parameters.</li> </ul> <p style="text-align: center;">Shows the get program function.</p> <div style="border: 1px solid black; padding: 5px; text-align: center;"> <p>F4 GET PROGRAM SYSTEM: 0 PROGRAM: 01</p> </div> <p style="text-align: center;">ENTER  Flashes. — Shows you can select a program.</p>

SYSTEM MODE

2. Move the cursor to SYSTEM and/or PROGRAM, then use DATA ENTRY A to select the desired letter or number, as the case may be.

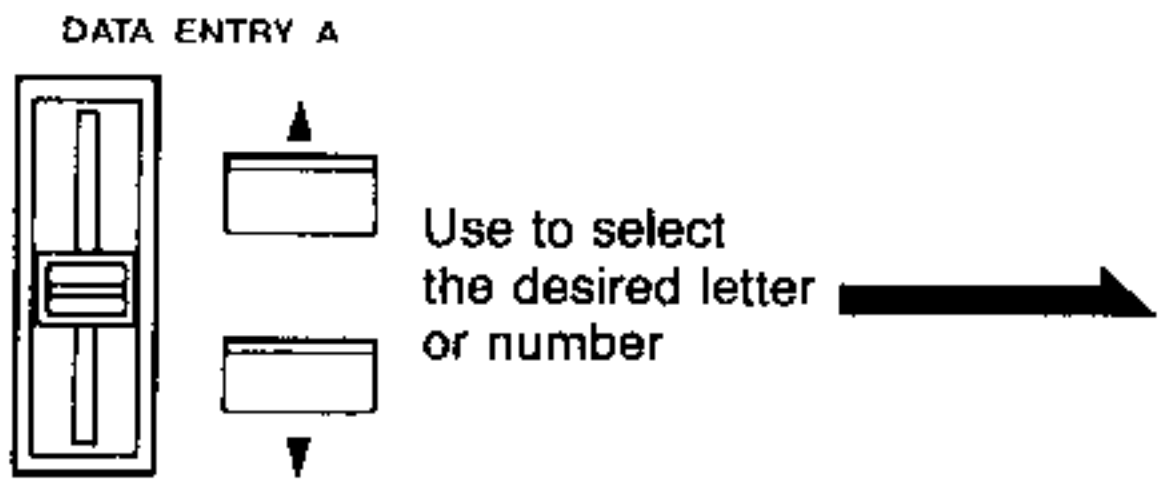
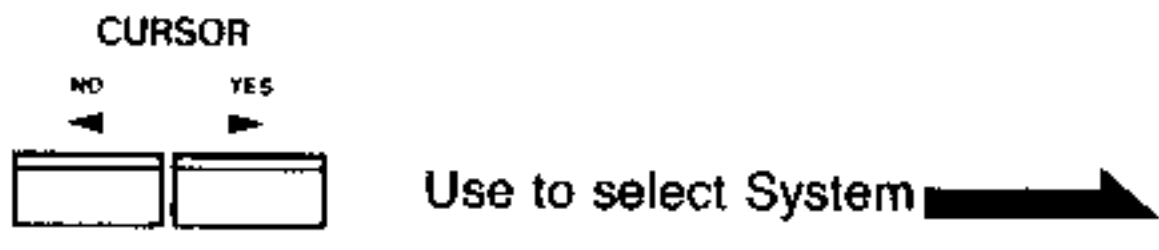

```
F4 GET PROGRAM
SYSTEM:A PROGRAM:01
```

(Example shows the selection of program.)

```
F4 GET PROGRAM
SYSTEM:A PROGRAM:12
```

(Example shows the selection of program number 12.)

3. Press ENTER to proceed.



● You are asked whether it is okay to go ahead and get the displayed system and program.

Shows the system that you load.

Shows the program number that you load.

```
F4 SYS:A PGM:12
Are You Sure? (Y/N)_
```

- 4 Use the YES or NO key to replay.  
★ Press YES to access the program.



- The display shows the program name and asks if you want to load it to memory.

```
F4 Loading...  
Please Wait a Minute
```



Shows the program name that you loaded.

```
F4 TEST-#01 Loaded  
Write in Mem.?(Y/N)_
```

- ★ Press NO if you do not want to get that program.



- This aborts the procedure and asks if you wish to retry. Proceed to step 8.

```
F4 Aborted  
Retry ? (Y/N)_
```

⑤ Press YES or NO to respond.

★ To write the program to memory, press YES.



★ Press NO if you do not want to write the program to memory.



- You are asked to choose a number under which to write the program in memory.

Shows the number written in memory.

```
F4 WRITE No. = 01
Select No. & ENTER
```



Flashes. Shows the selection of number.

- You are asked if you want to try again.

```
F4 Not Be Written
Retry ? (Y/N)_
```

⑥ Use DATA ENTRY A to select the number to which to write the program in memory.

DATA ENTRY A

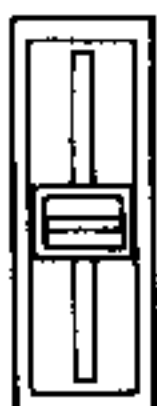



Use to select the number



Shows the program number selected in memory.

```
F4 WRITE No. = 04
Select No. & ENTER
```

7) Press the ENTER key to go ahead and write to the selected number in memory.

Press  after the selection 

- The prompt asks if you want to do it again.

Shows the program number written in memory.

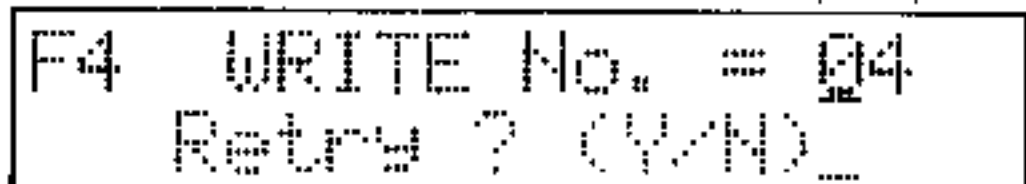

```
F4 WRITE No. = 04
Retry ? (Y/N)_
```

8) Press YES if you want to use this function again.

Press  

- This takes you back to the system and program selection stage so you can proceed from step 7.

★ Press NO to quit.

Press  

- You can now choose another function or change modes.

The display shows "write" if you press YES in step 8.



```
F4 WRITE No. = 04
Select (1-9):_
```

Shows you can select a function.

The display shows "not to be written" if you pressed the NO key in step 8.



```
F4 Not Be Written
Select (1-9):_
```

Shows you can select a function.

The display shows "aborted" if you pressed the NO key in step 7.

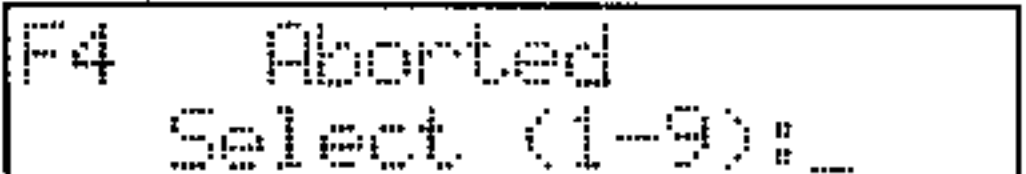

```
F4 Aborted
Select (1-9):_
```

Shows you can select a function.



# F5 GET ALL PROGRAMS

## 1. About the get all programs function

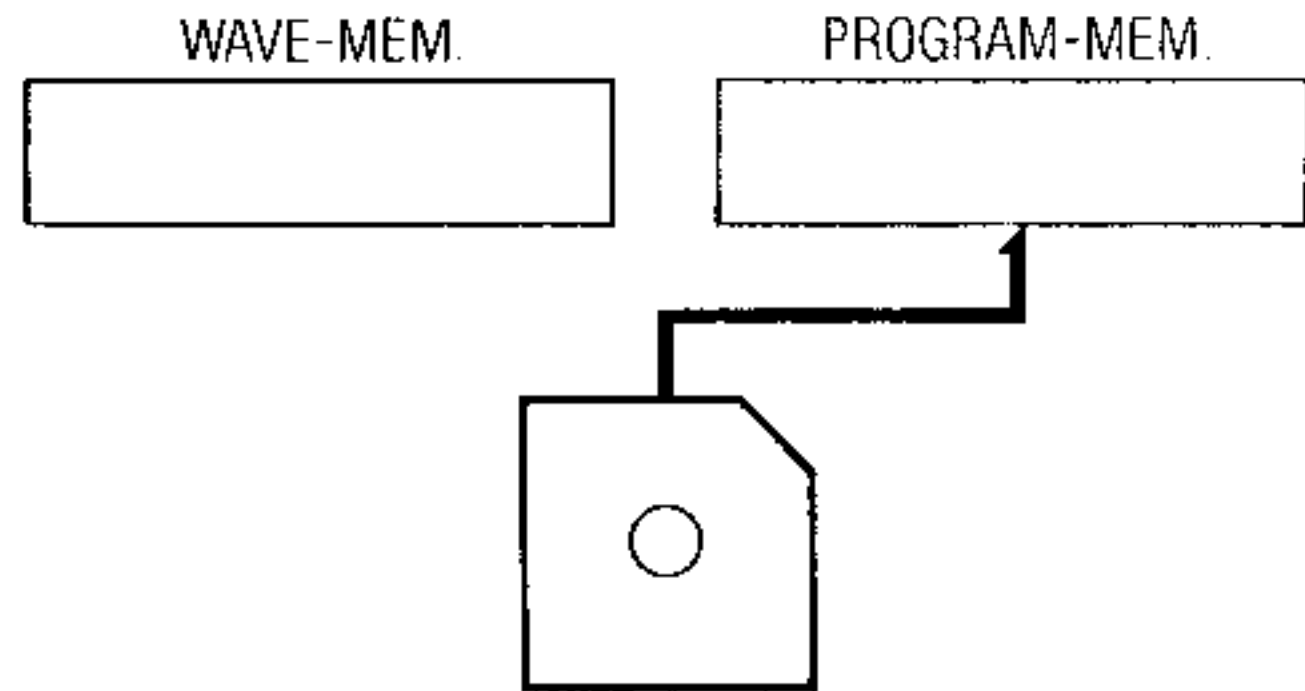
- This loads all 32 programs from a particular system on the disk to the program memory in the DSS-1.

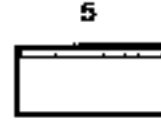

## 2. Using the get all program function

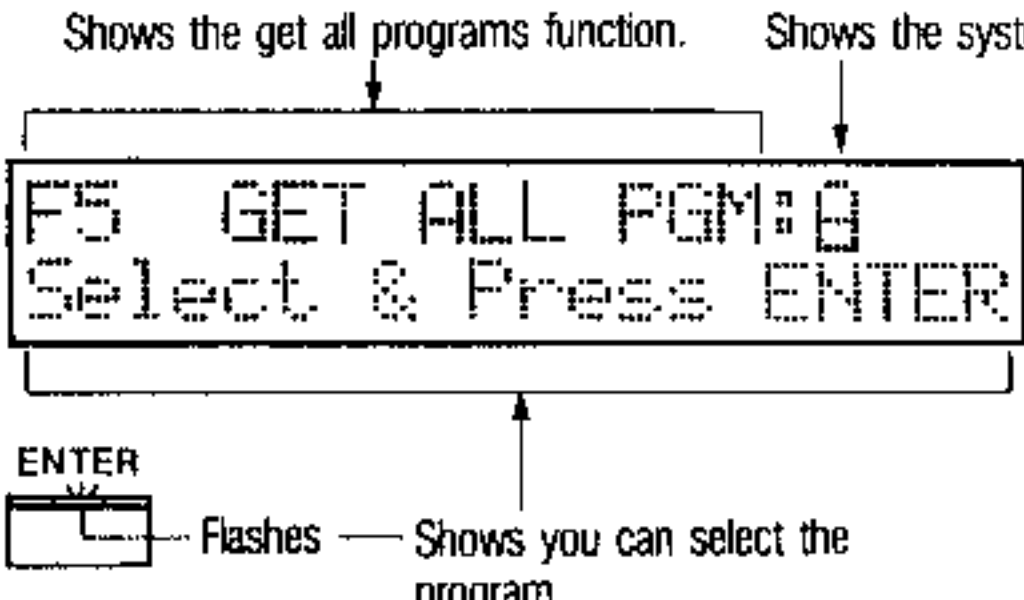
Operation	Operation of DSS-1
<p>0. Select the SYSTEM mode.</p>	<ul style="list-style-type: none"> <li>● Indicates SYSTEM mode.</li> </ul>  <p>The diagram shows a rectangular box with the word 'SYSTEM' above it and 'On' to its right. An arrow points from the top of the box to the word 'SYSTEM'.</p> <ul style="list-style-type: none"> <li>● The display prompts you to choose a function.</li> </ul>
<p>① Press the number 5 key.</p> <p>Press  </p>	<ul style="list-style-type: none"> <li>● The display shows the currently selected system.</li> </ul>  <p>The diagram shows a display screen with two lines of text: 'F5 GET ALL PGM: 0' and 'Select &amp; Press ENTER'. Above the screen, two arrows point to the first and second lines, labeled 'Shows the get all programs function.' and 'Shows the system.' respectively. Below the screen, an arrow points to the 'ENTER' key icon, which is labeled 'Flashes'. A line connects this 'Flashes' label to the text 'Shows you can select the program.' below it.</p>

SYSTEM MODE

2 Use DATA ENTRY A to select the system that has the programs that you want to get.

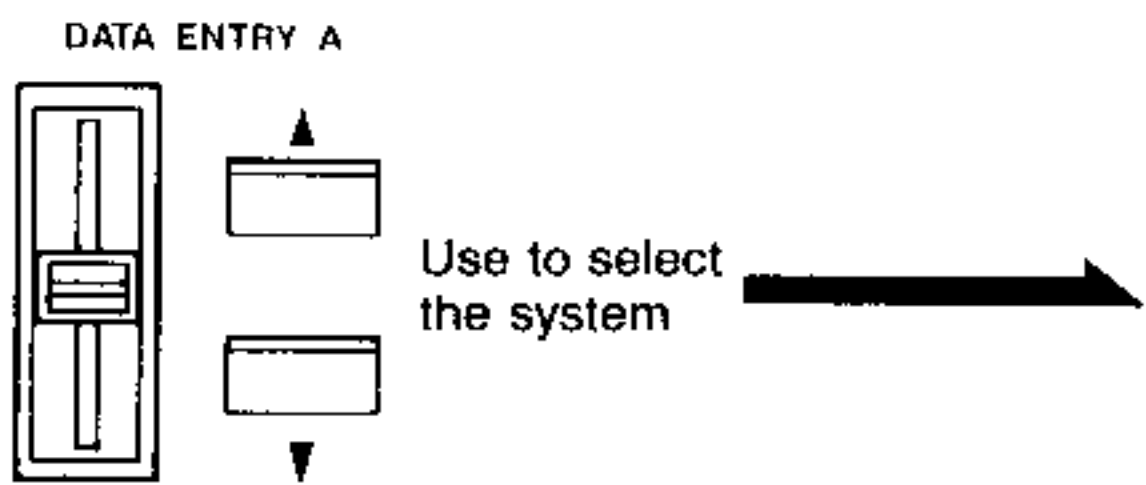

Shows the selected system name.

```
F5 GET ALL PGM:9
Select & Press ENTER
```

3 Press ENTER to go ahead.



- You are asked whether it is okay to get all the programs from the selected system.

Shows the system name that you want to load.

```
F5 GET ALL PGM:A
Are You Sure? (Y/N)...
```

④ Press YES to load.



- This completes the function. You can now choose another function or change modes.

```
F5 Loading...
Please Wait a Minute
```

Shows the completion of the function.

```
F5 Loaded from A
Select (1-9): _
```

Shows you can select a function

★ If you do not want to load those programs, press NO to abort.



- You can now choose another function or change modes.

```
F5 Aborted
Select (1-9): _
```

Shows you can select a function.





# F6 SAVE ALL PROGRAMS

## 1. About the save all programs function

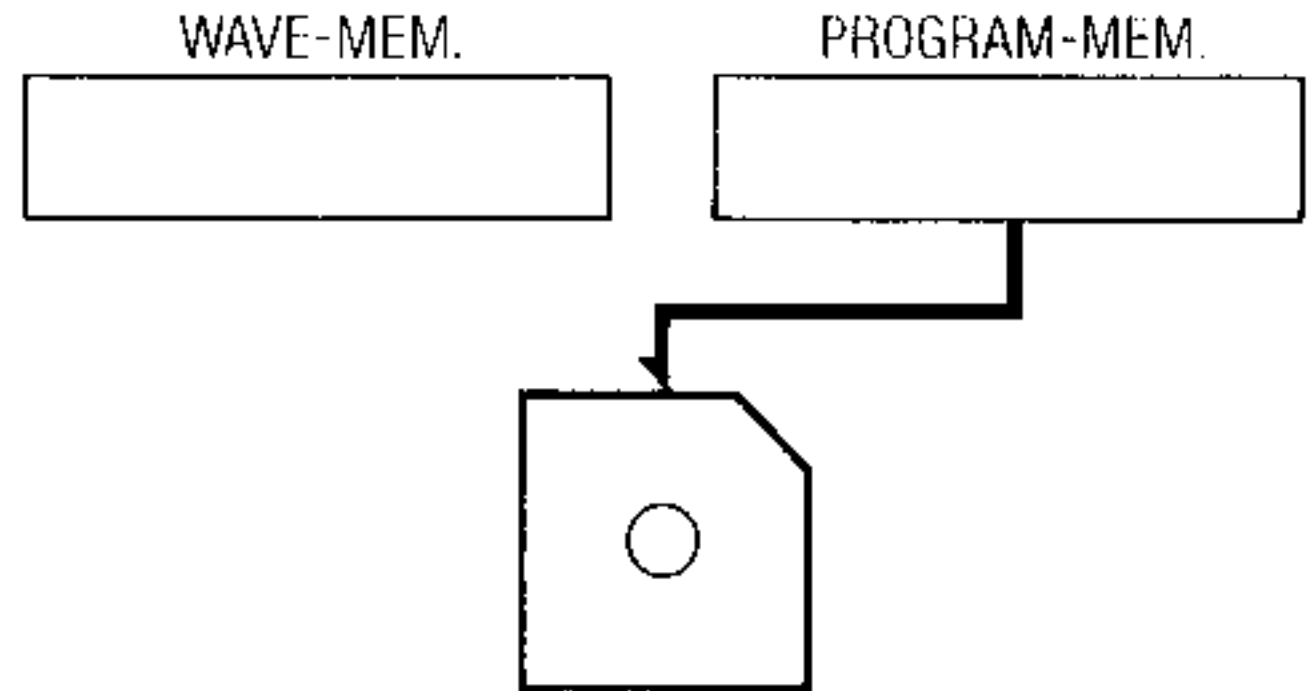
- This function lets you save all of the programs currently residing in program memory to the system name (A, B, C, D) of your choice.

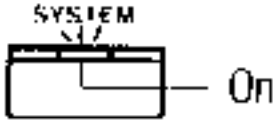
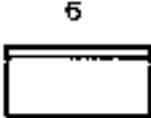

## 2. Using the save all programs function

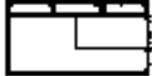
Operation	Operation of DSS-1
<p>① Confirm that the SYSTEM mode is selected.</p>	<ul style="list-style-type: none"> <li>● Indicates SYSTEM mode.</li> </ul>  <ul style="list-style-type: none"> <li>● The display prompts you to choose a function.</li> </ul>
<p>② Press the number 6 key.</p> <p>Press  </p>	<ul style="list-style-type: none"> <li>● You are prompted to select the system name.</li> </ul> <p>Shows the save all programs function. Shows the system.</p>  <p>ENTER  Flashes. Shows you can select a system.</p>

2 Use DATA ENTRY A to select the system on the disk to which to save the programs.

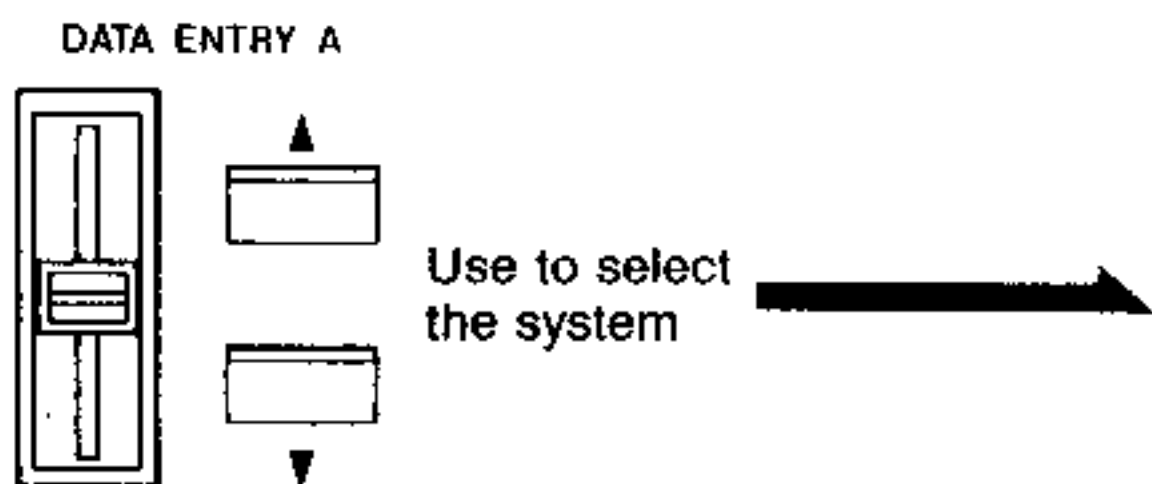

Shows the selected system name.

F6 SAVE ALL PGM:A  
Select & Press ENTER

3 Press the ENTER key after selecting the destination system.



- The system on the disk is specified. You are asked if it is okay to save all of the programs in memory to that system.

Name of selected destination system on disk.

F6 SAVE ALL PGM:A  
Are You Sure? (Y/N)...

- 6. Press the YES key if you do wish to save all programs from memory to the selected system on the disk.



- ★ Press the NO key if you do not wish to save all programs from memory to the selected system on the disk.



- You can now choose another function or change modes.

```
F6 Saving...  
Please Wait a Minute
```

Shows the completion of the function.

```
F6 Saved to A  
Select (1-9):_
```

Shows you can select a function

- You can now choose another function or change modes.

```
F6 Aborted  
Select (1-9):_
```

Shows you can select a function.





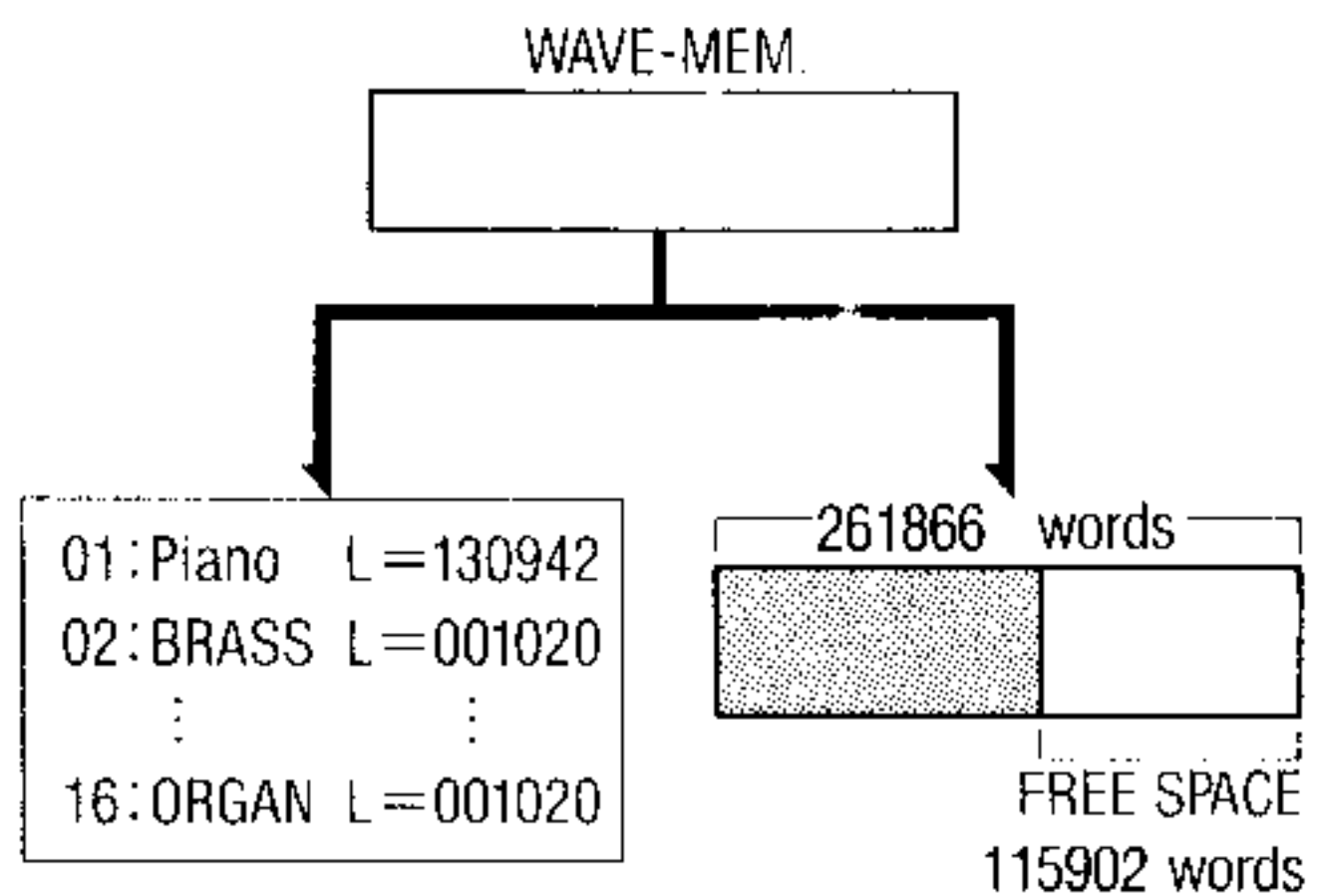

## F7 M.SOUND DIR/FREE SPACE

### 1 About the multisound directory/free-space function.

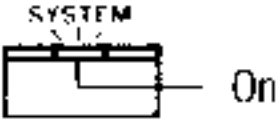
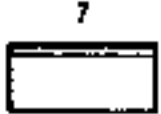
- This lists the name and length of each multisound in wave memory and shows the amount of free space (in word units) that is still available.



2 Using the multisound directory/free-space function

Operation	Operation of DSS-1
<p>① Confirm that the SYSTEM mode is selected.</p>	<p>● Indicates SYSTEM mode.</p> 
<p>① Press the number 7 key.</p> <p>Press  </p>	<p>● The display shows the currently selected system.</p> <p>Shows the m. sound directory/free-space function.</p>  <p>Says use DATA ENTRY A.</p>
<p>② Use DATA ENTRY A to view the directory.</p> <p>DATA ENTRY A</p>  <p>Use to view Directory </p>	<p>Shows the amount of free space.</p>  <p>Shows the multisound number.</p> <p>Shows the multisound name.</p> <p>Shows the multisound length.</p>

## F8 ERASE MULTISOUND

### About the erase multisound function

- This lets you erase a specified multisound from memory.

All multisounds above the erased sound in memory are shifted down to fill the address space left by the deleted multisound. The numbers of these shifted multisounds are also reduced by one.

**Example:** If multisound 02 is erased.

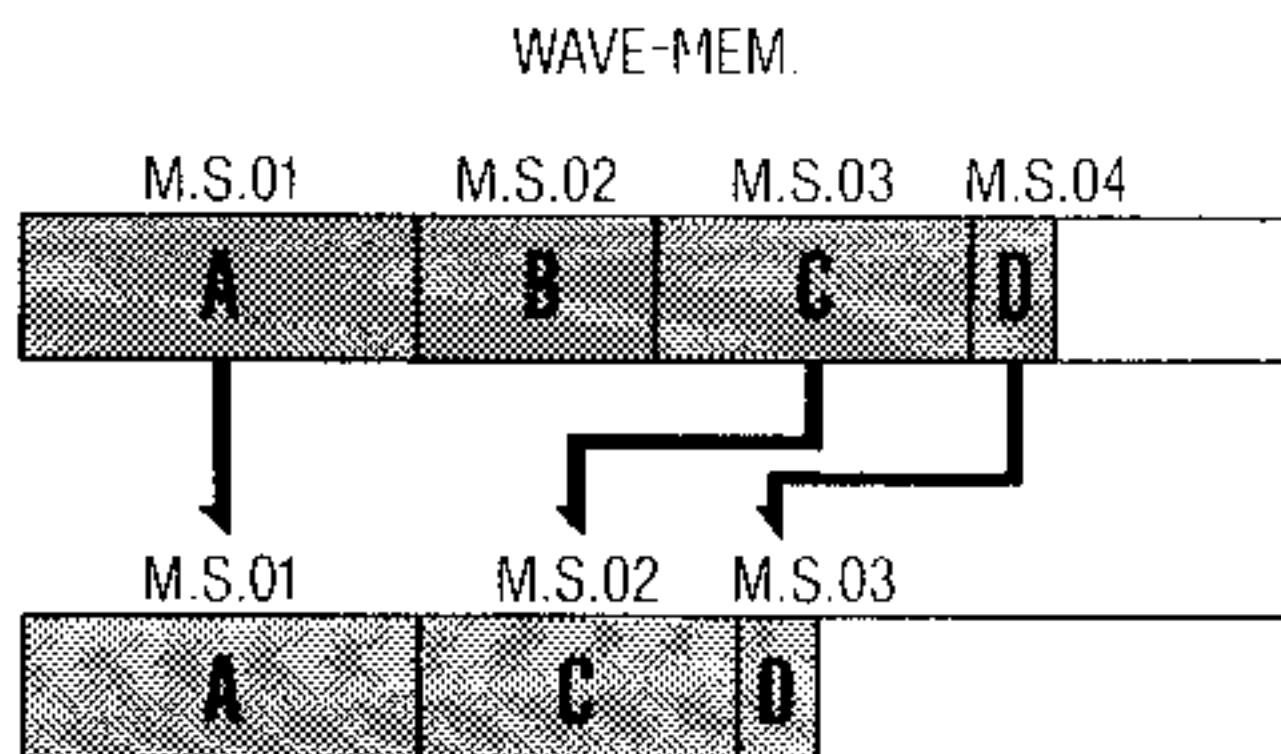

- Changes are made automatically in the assignments (made in the program parameter mode) of multisound numbers to OSC-1 and OSC-2.

Program No.	P.01	P.02	P.03	P.04		P.31	P.32	
Multi-sound	OSC1	01	02	03	04		02	04
	OSC2	01	02	01	03		04	04

Program No.	P.01	P.02	P.03	P.04		P.31	P.32	
Multi-sound	OSC1	01	01	02	03		01	03
	OSC2	01	01	01	02		03	03

### Using the erase multisound function

Operation	Operation of DSS-1
0: Select the SYSTEM mode.	<ul style="list-style-type: none"> <li>● Indicates the SYSTEM mode.</li> </ul>

Press the number 8 key.



- The display shows the currently selected system.

Shows the erase multi sound function.

```
F8 ERASE MULTI SOUND
Select & Press ENTER
```

Shows waiting for the selection of multisound.

- 2 Use DATA ENTRY A to select the multisound that you want to erase.

DATA ENTRY A

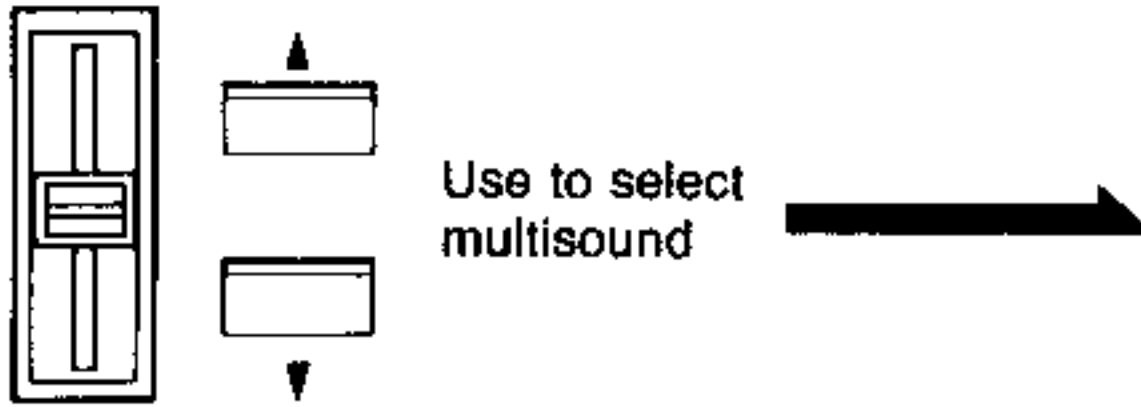

```
F8 ERASE MULTI SOUND
01:TEST-#01 L=010739
```

ENTER

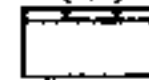

Flashes.

Shows the currently selected multisound's number, name, and length.

- 3 Press ENTER to input your choice.



- You are asked if you want to erase the displayed multisound.

Name of multisound that you want to erase.

```
F8 Erase 01:TEST-#01
L=010739 (Y/N)_
```

Prompt.

Length of multisound that you want to erase.

4. Use the YES or NO key reply.

★ If YES, the sound will be erased and you will be asked if you wish to continue.



- After erasing a multisound, you will be asked if you wish to continue.

```
F8 This Will Take  
a While
```

Shows the erased multisound's name.

```
F8 TEST-#01 Erased  
Continue ? (Y/N)_
```

★ If no, the operation will be cancelled and you will be asked if you want to continue.



- Display confirms function canceled and asks whether you wish to continue to use the erase multisound function.

```
F8 Canceled  
Continue ? (Y/N)_
```



5: Press YES or NO to reply.

★ To continue with this function, press YES. This takes you back to the display in step 1.



★ To quit the function, press NO. You are given the function selection prompt.



● This takes you back to the display in step 1. You can continue with the procedure from step 2.

● You can now select another function or charge modes.

(If you pressed YES in step 4, the display says Erased.)

```
F8 TEST-#01 Erased
Select (1-9)_
```

Shows you can select a function.

(If you pressed NO in step 4, the display says Cancelled.)

```
F8 Canceled
Select (1-9)_
```

Shows you can select a function.



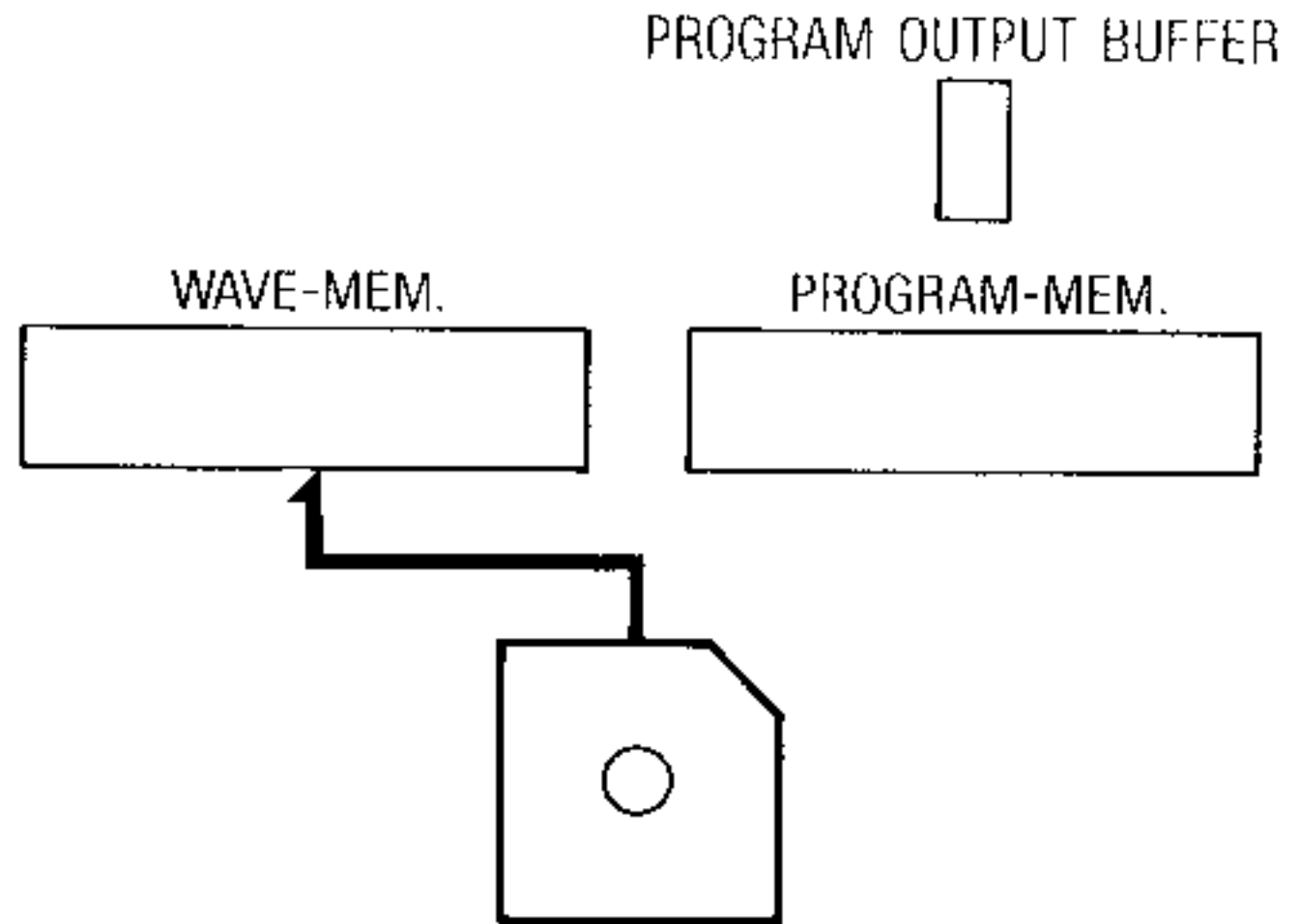

# F9 GET MULTISOUND

## 1 About the get multisound function

- This lets you select the multisounds that you need from disk and load them into wave memory. OSC1 MULTISOUND and OSC2 MULTISOUND contents in the program output buffer change to the loaded multisounds which are assigned to these oscillators. Therefore you can listen to the multisounds immediately.

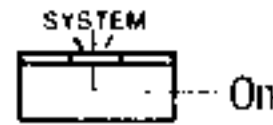
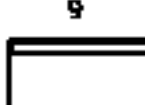

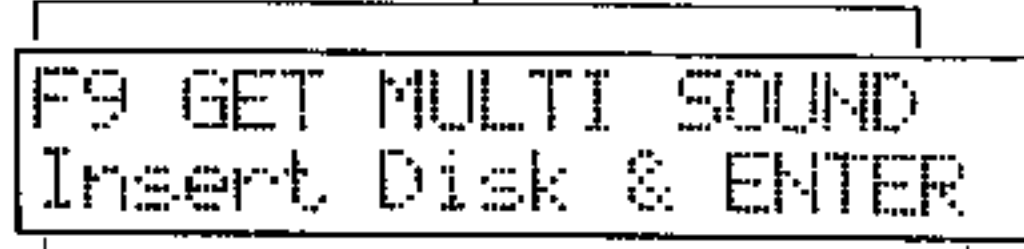
## 2 Using the get multisound function

Operation	Operation of DSS-1
<p>0: Select the SYSTEM mode.</p>	<ul style="list-style-type: none"> <li>● Indicates the SYSTEM mode.</li> </ul> 
<p>1 Press the number 9 key..</p> <p>Press  </p>	<ul style="list-style-type: none"> <li>● The display shows the currently selected system.</li> </ul> <p>Shows the get multisound function.</p>  <p>ENTER  Flashes while waiting for you to insert disk.</p>

SYSTEM MODE

2. Put in the disk that has your desired multisounds. Then press ENTER.



• You can select the multisound after inserting disk.

```
F9 Searching for
M.SOUNDS on Disk
```



```
F9 Use DATA ENTRY A
Select&Press ENTER
```

Prompts you to select a multisound.

3. Use DATA ENTRY A to select the multisound to get.

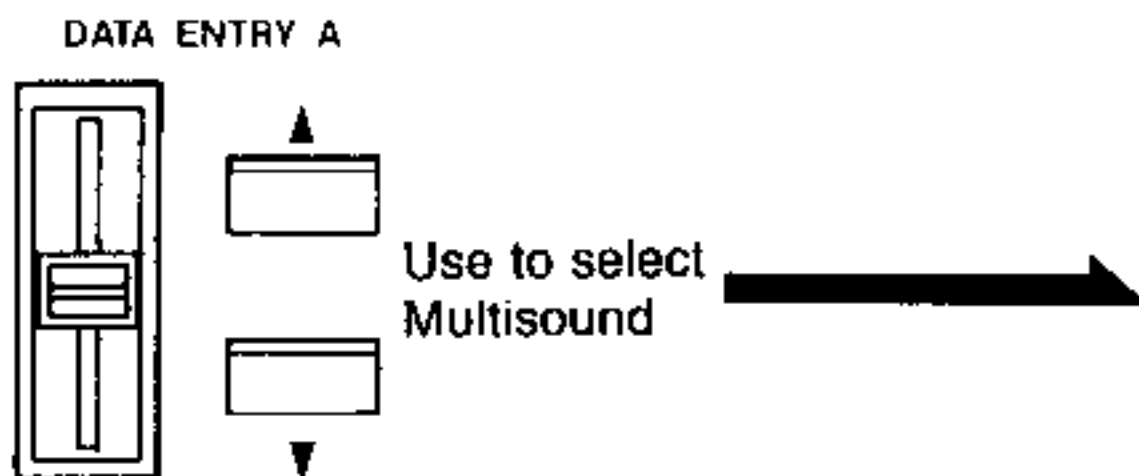



• Shows which multisound number the selected multisound will have when loaded into the system.

```
F9 Select M.SOUND
M.SND:#01 : TEST-#01
```

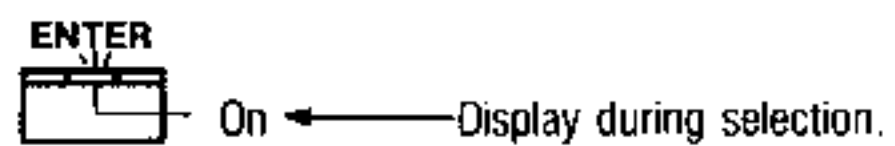
Shows the multisound selection. Shows the name.



④ Press ENTER to go ahead.

Press  after the selection 

- You are asked for confirmation.

Shows the multisound name that you load.  
Shows the multisound length that you load.

```

F9 TEST-#01 L=052337
Are You Sure? (Y/N)_
  
```

⑤ Press YES or NO to reply.

- ★ Press YES to load. After loading you are asked if you want to continue.

Press  

- Display asks you to wait while loading.
- Then you are asked whether you wish to continue to use the get multisound function.

```

F9 Loading...
Please Wait a Minute
  
```

Shows the loaded multisound's name.

```

F9 TEST-#01 Loaded
Continue ? (Y/N)_
  
```

★ Press NO to interrupt the operation. The display asks if you wish to continue to use this function.



- Display confirms function canceled and asks you whether you wish to continue to use the get multi-sound function.

Shows the multison's name and length that you tried to load.

```
F9 TEST-#01 L=052337
Continue ? (Y/N)_
```

⑥ Press YES to continue to use this function.



- This takes you back to the display in step 1. You can continue with the procedure from step 2.

★ Press NO to abort the function.



- You can now select another function or change modes.

(The display says Loading Completed if you pressed YES in step ⑤.)

```
F9 Loading Completed
Select (1-9):_
```

Shows you can select a function.

(The display says Aborted if you pressed NO in step ⑤.)

```
F9 Aborted
Select (1-9):_
```

Shows you can select a function.

# DISK UTILITY MODE

## 1. About each of the Functions \_\_\_\_\_

### FO FORMAT DISK

#### 1 About the format disk function

- After purchasing blank disks you must use this function to format the disks before you can use them.

(Formatting the disk does not have any effect on internal memory contents.)

After purchasing blank disks you must use this function to format the disks before you can use them.

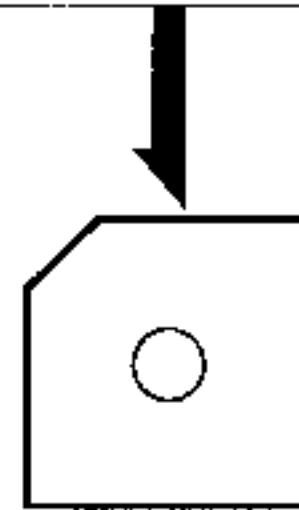





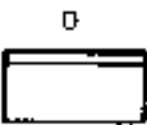

#### **CAUTION:**

The formatting function erases any and all previous information from the disk. You can not recover information lost in this way. Be very careful not to accidentally format a disk that contains your sounds and patches.

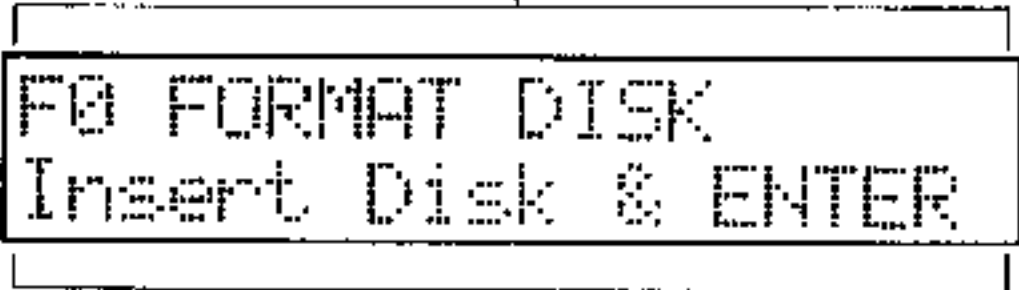
The F1 DISK PROTECT function does not prevent formatting or protect data on the disk if you try to format a disk. However, the physical WRITE PROTECT tab on the disk will prevent erasure and formatting.

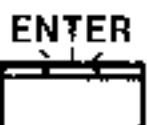
## 2 Using the format disk function

Operation	Operation of DSS-1
<p>① Select the DISK UTILITY mode.</p>	<ul style="list-style-type: none"> <li>● Indicates DISK UTILITY mode.</li> </ul> 
<p>① Press the number 0 key.</p> <p>Press  </p>	<ul style="list-style-type: none"> <li>● The display prompts you to insert disk and press ENTER.</li> </ul> <p>Shows the format disk function.</p>  <p> Flashes while waiting for you to insert disk.</p>
<p>② Put in a disk to be formatted and then press ENTER.</p> <p>Press  </p>	<ul style="list-style-type: none"> <li>● You are asked if you want to format the disk.</li> </ul> 

③ If you truly want to format that disk (and permanently erase any and all data that may be on it), then press the YES key.



- You can now format that disk. (It takes about 2 min. 30 sec. to format.)
- After formatting, you are asked if you wish to continue to format disks.

```
F0 FORMAT DISK
  Formatting...
```



```
F0 DISK Formated
Continue ? (Y/N)_
```

★ Press NO to abort the function.



- Display confirms function aborted. You can select another function or change modes.

```
F0   Aborted
      Select (0-7):_
```

Shows you can select a function.



4 Press YES or NO to reply.

★ To continue with this function, press YES.



★ To quit the function, press NO.



● This takes you back to the display in step 1, then you continue from step 2.

● You can now choose another function or change modes.

```
F0 DISK Formated
Select (0-7): _
```

Shows you can select a function.

---

## F1 DISK PROTECT (SET/RESET)

### 1 About the disk protect (set/reset) function

- This is one way of protecting the information on a disk from accidental erasure or change. You SET this to protect a disk (i.e. prevent erasure or change). You RESET it to return to normal and allow erasure or change.

Protect the information on a disk from accidental erasure or change.

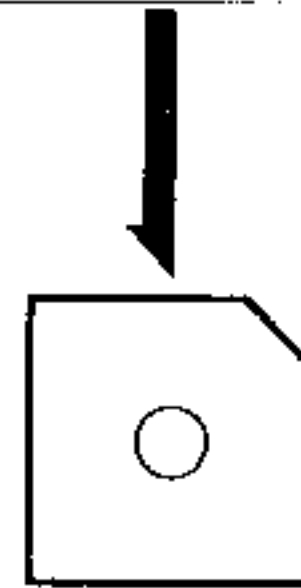





- Note that if a disk is protected then you can not save data to it. You can always retrieve (read) data from a disk no matter what its PROTECT status.

**Caution:**

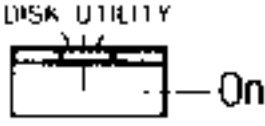
This function gives no protection against disk formatting using the F0 FORMAT DISK function. Formatting wipes out everything. For protection against accidental formatting, you must set the physical write protect tab (read-only tab) on the disk so that the hole is open. See the section on WRITE PROTECT.

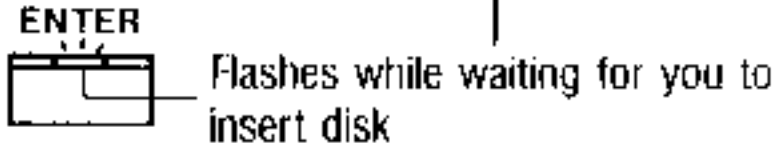
## 2 Using the disk protect (set/reset) function

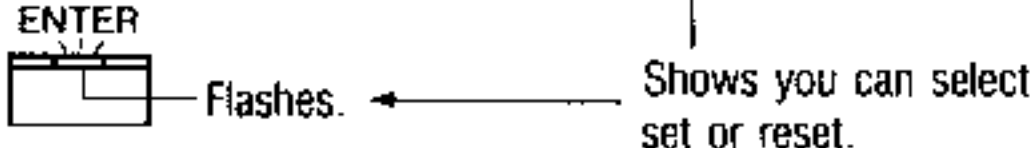
Operation	Operation of DSS-1
<p>0. Select the DISK UTILITY mode.</p>	<ul style="list-style-type: none"> <li>Indicates DISK UTILITY mode.</li> </ul> 
<p>1. Press the number 1 key.</p> <p>Press </p>	<ul style="list-style-type: none"> <li>The display shows the currently selected system.</li> </ul> <p>Shows the protect disk (set/reset) function.</p>   <p>ENTER Flashes while waiting for you to insert disk</p>
<p>2. Insert the disk that you want to protect or unprotect into the slot. Press ENTER.</p> <p>Press </p>	<ul style="list-style-type: none"> <li>You can select set or reset.</li> </ul>   <p>ENTER Flashes. Shows you can select set or reset.</p>

3 Move the cursor under SET (to protect) or RESET (to unprotect and allow changes).

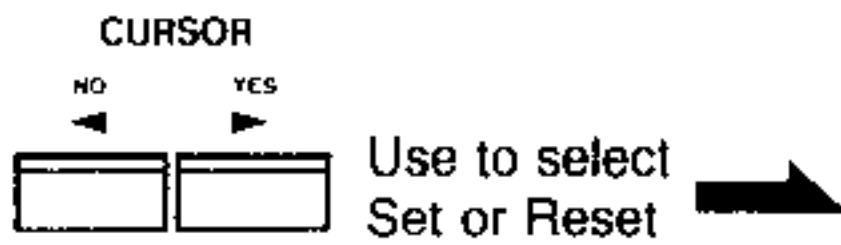

```
F1 PROTECT DISK
      SET / RESET
```

Shows the cursor under the selected set or reset.  
(Example shows when you choose protect set.)

4 Press ENTER.



- You are asked whether it is okay to go ahead with the SET PROTECTION or RESET PROTECTION procedure.

(Set protection)

```
F1 SET PROTECTION
Are You Sure? (Y/N)_
```

(Reset protection)

```
F1 RESET PROTECTION
Are You Sure? (Y/N)_
```

5 Press YES to execute.



★ Press NO to abort.



- You can now choose another function or change modes.

(Set protection)

```
F1 DISK Protecting  
Please Wait a Minute
```



```
F1 DISK Protected  
Select (0-7):_
```

Shows you can select a function.

(Reset protection)

```
F1 DISK Unprotecting  
Please Wait a Minute
```



```
F1 DISK Unprotected  
Select (0-7):_
```

Shows you can select a function.

- You can now choose another function or change modes.

```
F1 Aborted  
Select (0-7):_
```

Shows you can select a function.

## F2 PROGRAM DIRECTORY

### 1 About the program directory function.



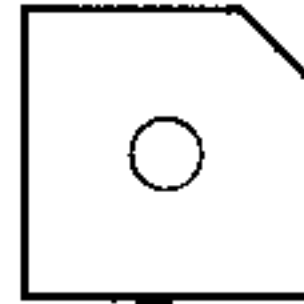

- This shows you the names of all 32 programs in a specified system (A, B, C, or D) on a disk. This is the easy way to check what programs you have on a disk.



```

SYS:B
P:01 Pf
P:02 BRASS
  ...
P:31 BASS
P:32 GUITAR
  
```

### 2 Using the program directory function.

Operation	Operation of DSS-1
0 Select the DISK UTILITY mode.	<ul style="list-style-type: none"> <li>● Indicates DISK UTILITY mode.</li> </ul> 
1 Press the number 2 key.  Press 	<ul style="list-style-type: none"> <li>● The display shows the currently selected system.</li> </ul> <p>Shows the program directory function.</p>  <p>ENTER  Flashes while waiting for you to insert disk.</p>

2 Insert a disk and press ENTER.



• You can select the system.

```
F2 PROGRAM DIR
Select SYSTEM:A
```

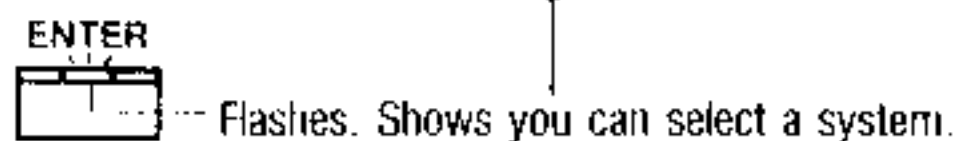

3 Use DATA ENTRY A to select a system.

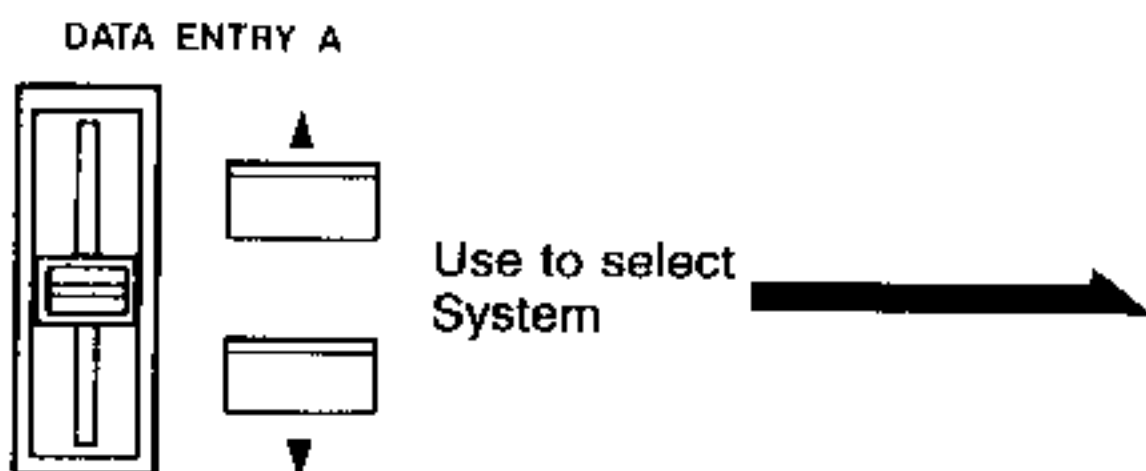

```
F2 PROGRAM DIR
Select SYSTEM:D
```

Shows the currently selected system.   
(Example shows when you choose system: D)

4 Press ENTER.



• You can move through the program directory after inserting disk.

```
F2 Use DATA ENTRY A
.SYS:D P:01 PF1
```

Shows you can move through the program directory.

5 Use DATA ENTRY A to move through the directory as shown on the bottom line of the display.

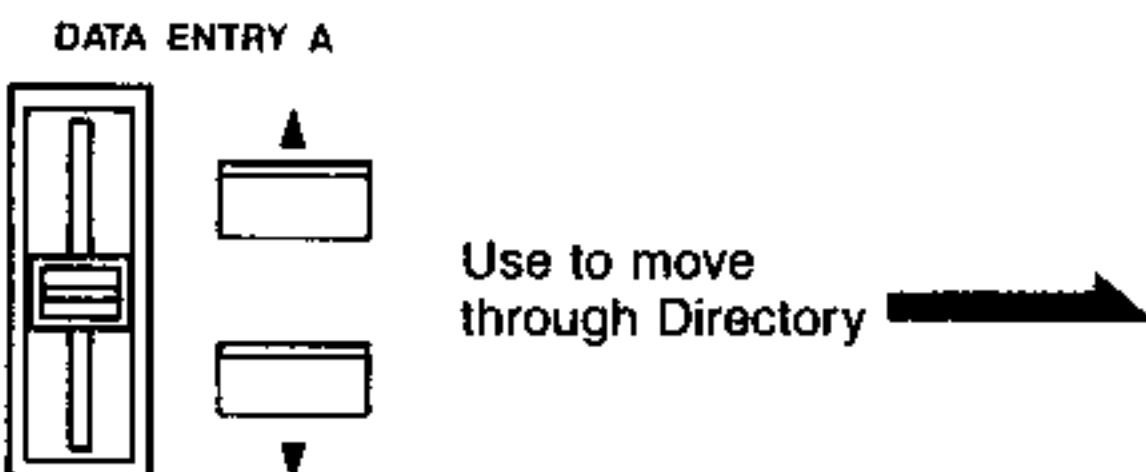

```
F2 Use DATA ENTRY A
SYS:D P:03 BR1
```

Shows the system. Shows the program number and name.



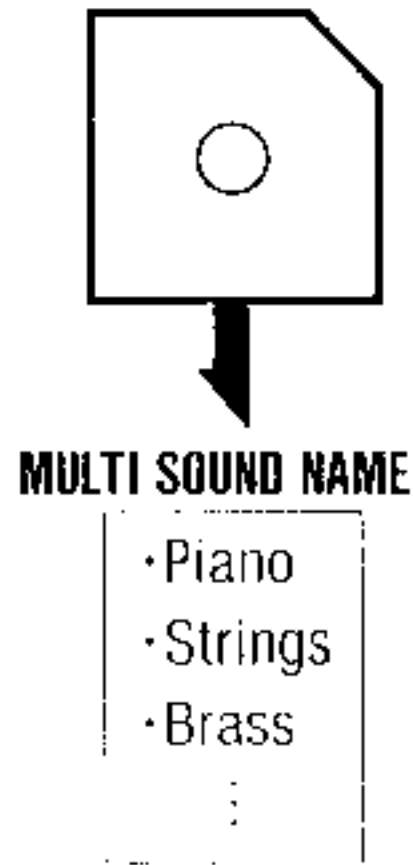

# F3 MULTISOUND DIRECTORY

## 1 About the multisound directory function.

- This gives a directory of multisounds on a disk.

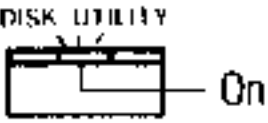

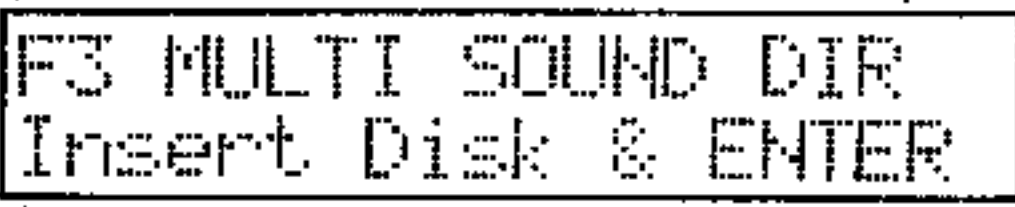

## 2 Using the multisound directory function.

Operation	Operation of DSS-1
<p>0 Select the DISK UTILITY mode.</p>	<ul style="list-style-type: none"> <li>● Indicates DISK UTILITY mode.</li> </ul> 
<p>1 Press the number 3 key.</p> <p>Press </p>	<ul style="list-style-type: none"> <li>● You can select the multisound directory after inserting disk.</li> </ul> <p>Shows the multisound directory function.</p>  <p>ENTER  Flashes while waiting for you to insert disk.</p>



2 Insert a disk and press ENTER.

Press  after inserting a disk 

● After searching the disk, this lets you move through the multisound directory.

```
F3 Searching for  
M. SOUNDS on Disk
```





```
F3 Use DATA ENTRY A  
M. SND Name: A. PFVF
```

Shows you can move through the multisound directory.

③ Use DATA ENTRY A to move through the directory as shown on the bottom line of the display.

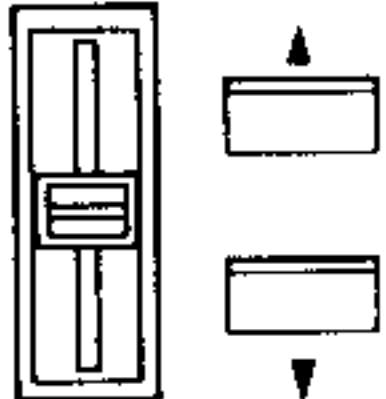
DATA ENTRY A



Use to move through Directory 

```
F3 Use DATA ENTRY A  
M. SND Name: PUSAWA
```

Shows the multisound name.

# F4 SOUND DIRECTORY

## 1 About the sound directory function

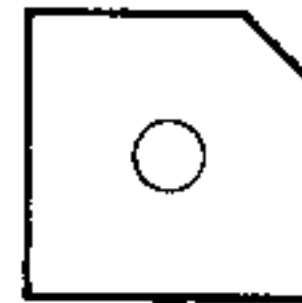

- This gives a directory of sound on a disk.



SOUND NAME

```
·Pf- #01
·Pf- #03
·Pf- #03
:
```

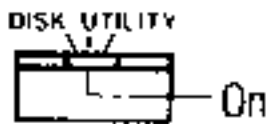
## 2 Using the directory function

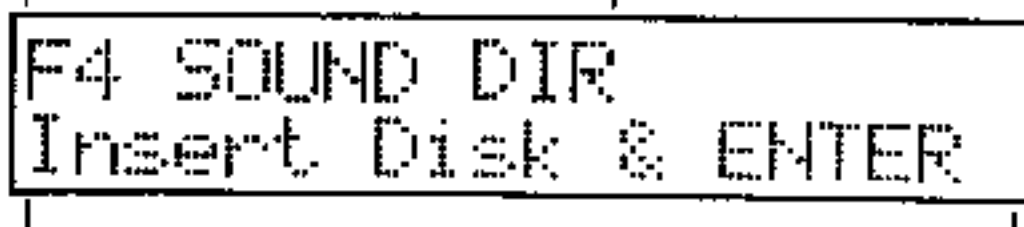
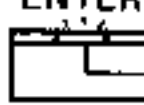
Operation	Operation of DSS-1
<p>① Select the DISK UTILITY mode.</p>	<p>● Indicates DISK UTILITY mode.</p> 
<p>② Press the number 4 key.</p> <p>Press </p>	<p>● You can select the sound directory after inserting a disk.</p> <p>Shows the sound directory function.</p>  <p>ENTER  Flashes while waiting for you to insert disk.</p>

DISK UTILITY MODE

② Insert a disk and press ENTER.



- After searching the disk, this lets you move through the sound directory.

```
F4 Searching for
SOUNDS on Disk
```



```
F4 Use DATA ENTRY A
SOUND Name: HP#1
```

Shows you can move through the sound directory.

③ Use DATA ENTRY A to move through the directory which is shown on the bottom line of the display.

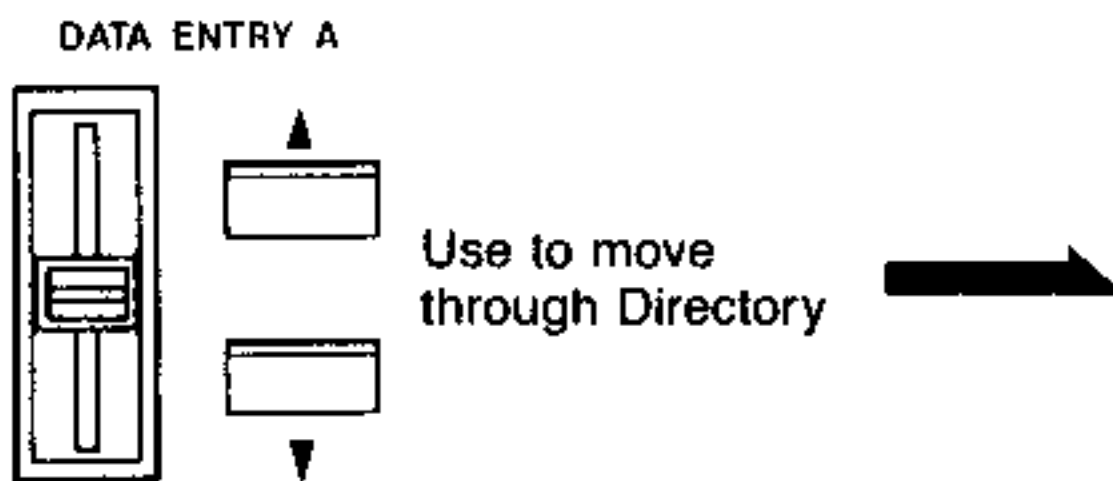

```
F4 Use DATA ENTRY A
SOUND Name: EB#1
```

Shows the sound name.



# F5 DELETE SOUND

## 1 About the delete sound function.

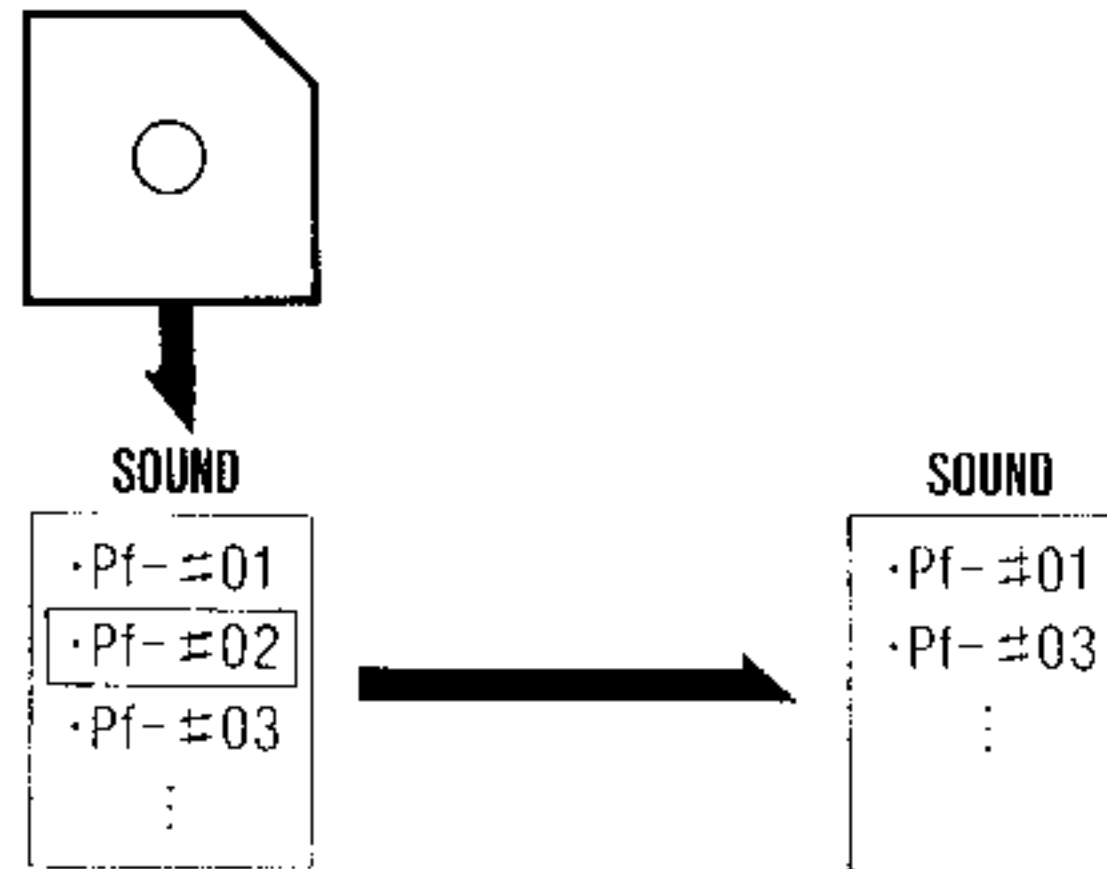
- This function lets you delete (erase) particular sounds from a disk. By deleting unwanted sounds you can open up that much more free area for saving new data.

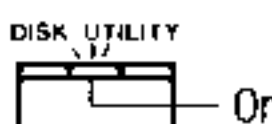

## 2 Using the delete sound function.

Operation	Operation of DSS-1
0. Select the DISK UTILITY mode.	<ul style="list-style-type: none"> <li>● Indicates DISK UTILITIES mode.</li> </ul> 
1. Press the number 5 key.  Press 	<ul style="list-style-type: none"> <li>● The display shows the currently selected system.</li> </ul> <p style="text-align: center;">Shows the delete sound function.</p> <div style="border: 1px solid black; padding: 5px; text-align: center;"> <p>F5 DELETE SOUND Insert Disk &amp; ENTER</p> </div> <p style="text-align: center;">ENTER</p>  <p style="text-align: center;">Flashes while waiting for you to insert disk.</p>

2. Insert the disk that has the sound(s) that you wish to remove. Press the ENTER key.



- After searching the disk, this lets you select a sound.

F5 Searching for  
SOUNDS on Disk





F5 Use DATA ENTRY A  
Select&Press ENTER

Shows you can select a sound.

3. Use DATA ENTRY A to select the sound to be deleted.

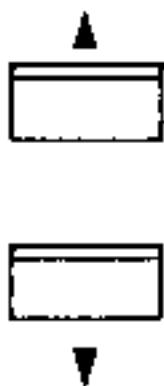
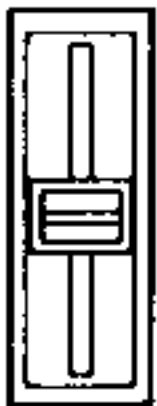
DATA ENTRY A



Use to select  
a sound 

- Display shows the sound name.
- ENTER key flashes while waiting for selection.

F5 Use DATA ENTRY A  
Select Name: BR#1

Shows the sound name.

ENTER

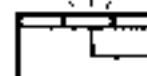

Flashes while waiting for selection.

4 Press ENTER to input your choice.



- The display asks if it is okay to go ahead and delete the selected sound.

Shows the sound name to be deleted.

```
graph TD; A[Shows the sound name to be deleted.] --> B[F5 SOUND:BR#1  
Are You Sure? (Y/N)_];
```

5 Press YES to delete. Or press NO to abort.

★ Press YES to proceed to load the selected sound from disk to memory.



- After deleting, you are asked if you wish to continue to use the sound function.

```
graph TD; A[F5 Deleting...  
Please Wait a Minute] --> B[Shows the deleted sound name.];
```

Shows the deleted sound name.

```
graph TD; A[Shows the deleted sound name.] --> B[F5 BR#1 Deleted  
Continue ? (Y/N)_];
```

★ Press NO to abort.



- In either case you are asked whether you wish to continue to use this function.

```
F5  Aborted
Continue ? (Y/N)_
```

6 Press YES to delete. Or press NO to abort.

★ Press YES to proceed to load.



- If you answer YES then you get the display in step 7 and can proceed from step 7.

★ Press NO to abort.



- Otherwise (if you answer NO) you are given the function selection prompt.

(The display says deleted if you pressed YES in step 5.)

```
F5 BR#1 Deleted
Select (0-7):_
```

Shows you can select a function.

(The display says aborted if you pressed NO in step 5.)

```
F5  Aborted
Select (0-7):_
```

Shows you can select a function.



# F6 DELETE MULTISOUND

## 1 About the delete multisound function

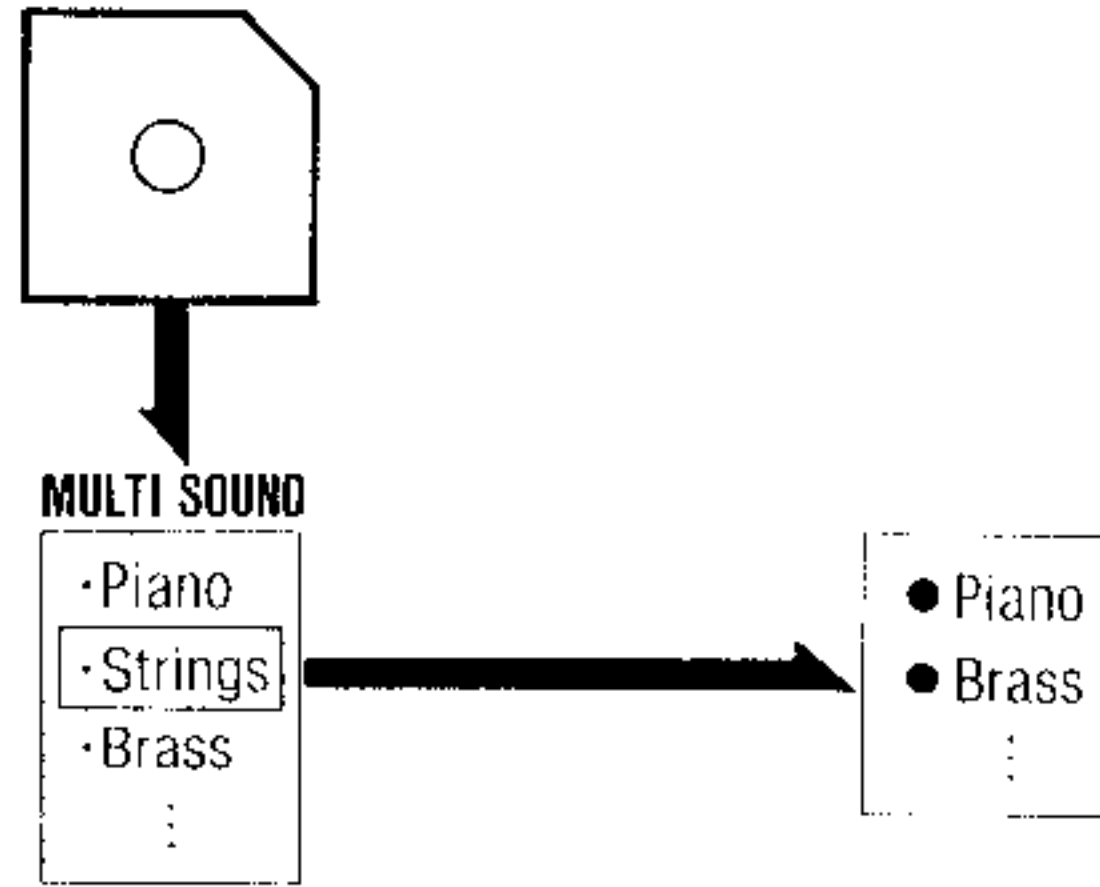
- This function lets you delete (erase) particular multisounds from a disk. By deleting unwanted multisounds you can open up more free area for saving new data.
- Deleting a multisound used by a system on the disk will cause that system (or those systems) to become incomplete. Delete with care.

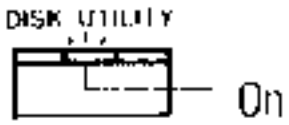
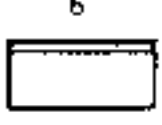

## 2 Using the delete multisound function.

Operation	Operation of DSS-1
<p>0 Select the DISK UTILITY mode.</p>	<ul style="list-style-type: none"> <li>● Indicates DISK UTILITIES mode.</li> </ul>  <ul style="list-style-type: none"> <li>● The display prompts you to choose a function.</li> </ul>
<p>1) Press the number 6 key.</p> <p>Press  →</p>	<ul style="list-style-type: none"> <li>● The display shows the currently selected system.</li> </ul> <p>Shows the delete multisound function.</p>   <p>Flashes while waiting for you to insert disk.</p>

DISK UTILITY MODE



2 Insert the disk that has the multisound(s) that you wish to remove. Press the ENTER key.



• You can select a multisound after inserting a disk.

```
F6 Searching for  
M. SOUNDS on Disk
```



```
F6 Use DATA ENTRY A  
Select&Press ENTER
```

Shows you can select a multisound.

3 Use DATA ENTRY A to select the multisound to be deleted.

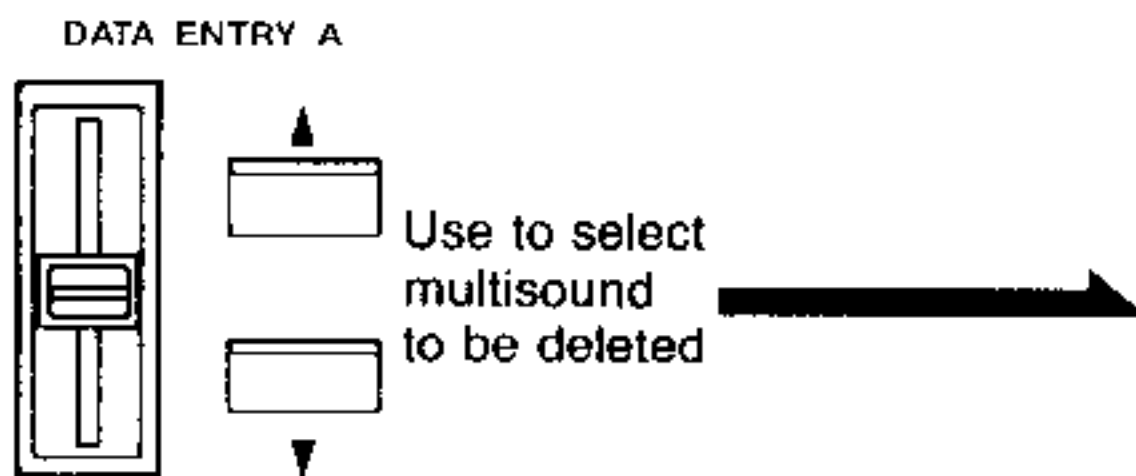

• The currently selected multisound name is shown on the lower line of the display.

```
F6 Use DATA ENTRY A  
Select Name: TEST-#01
```

Shows the multisound name.

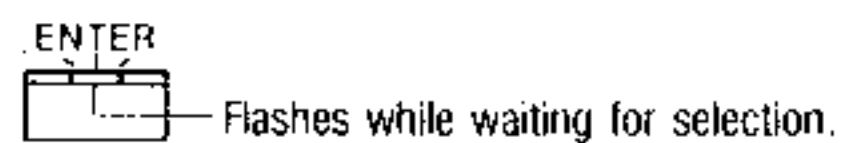

④ Press ENTER to input your choice.



- The display asks if it is okay to go ahead and delete the selected multisound.

Shows the multisound name to be deleted.

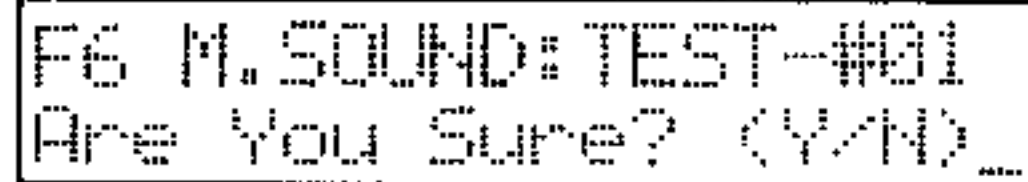

```
F6 M.SOUND: TEST-#01
Are You Sure? (Y/N)_
```

⑤ Press YES to delete. Or press NO to abort.



- In either case you are asked whether you wish to continue to use this function.

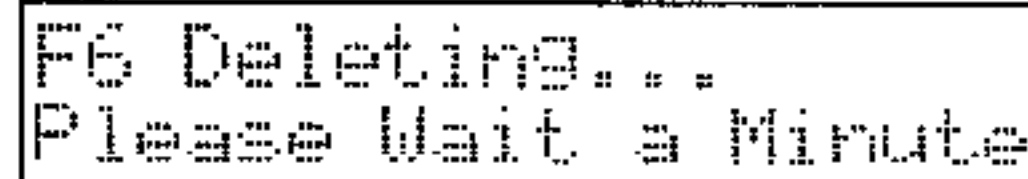

```
F6 Deleting...
Please Wait a Minute
```

Shows the deleted multisound name.



```
F6 TEST-#01 Deleted
Continue ? (Y/N)_
```

★ Press NO to abort.



- In either case you are asked whether you wish to continue to use this function.

```
F6  Aborted
Continue ? (Y/N)_
```

Ⓞ Press YES to delete. Or press NO to abort.

★ Press YES to proceed to load.



- If you answer YES then you get the display in step 1 and can proceed from step 2.

★ Press NO to abort.



- Otherwise (if you answer NO) you are given the function selection prompt.

(The display says deleted if you pressed YES in step ⑤.)

```
F6 TEST-#01 Deleted
Select (0-7):_
```

Shows you can select a function.

(The display says aborted if you pressed NO in step ⑤.)

```
F6  Aborted
Select (0-7):_
```

Shows you can select a function.

## F7 DISK STATUS

### 1 About the disk status function

- Shows the size of the used and free data storage areas on a disk. This is useful to find out how many more sounds and multisounds you can store on a disk.

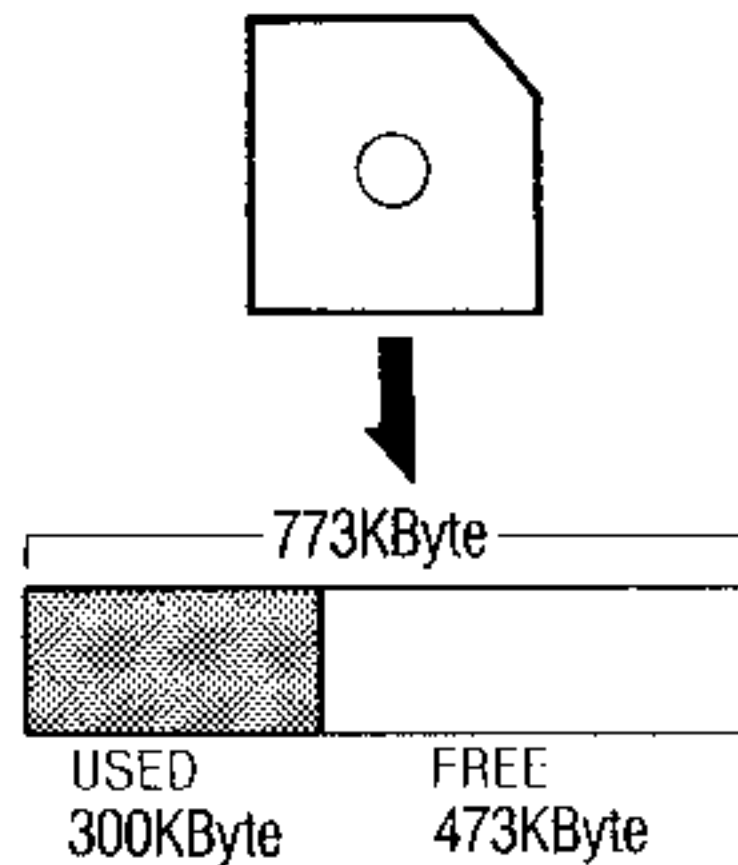





- The unit of display is the KByte (K) or kilobyte. One floppy disk used in this system has a capacity of 773K. (In the DSS-1, 1kByte = 1 block)

- This chart shows the relationships between the length of sounds and multisounds (measured in data words) and the number of blocks required for storage.

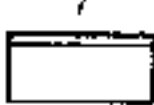
	Length (words).	Number of blocks used.
Full disk	About 520,000	773 (773K)
8 second sound sampled at 32kHz	261,886	About 384 (384K)
Multisound made by create waveform mode	1,020	2(2K)

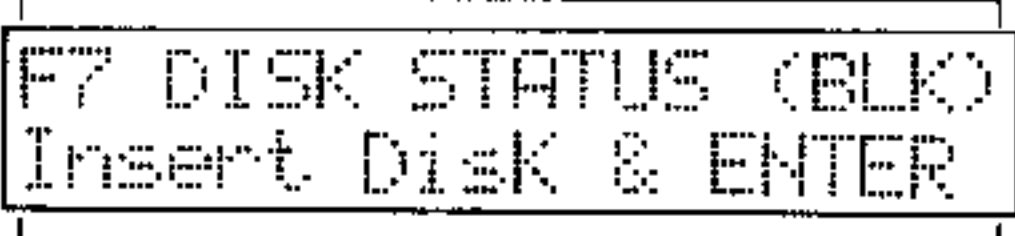
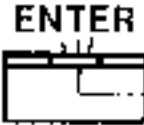
## 2: Using the disk status

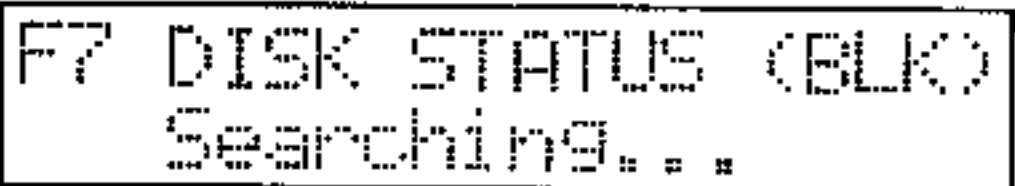
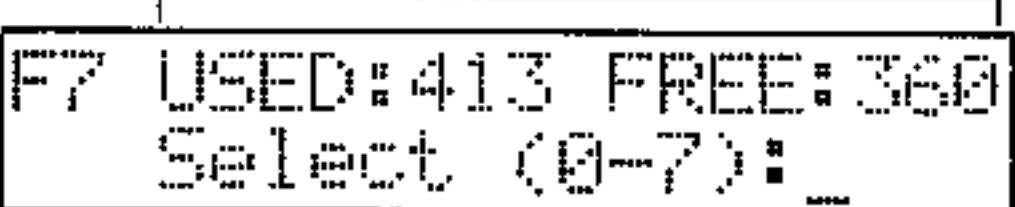
Operation	Operation of DSS-1
<p>0. Select the DISK UTILITY mode.</p>	<ul style="list-style-type: none"> <li>Indicates DISK UTILITIES mode.</li> </ul>  <p>The indicator shows a box with 'DISK UTILITY' above it and 'On' to its right.</p>
<p>1. Press the number 7 key.</p> <p>Press  </p>	<ul style="list-style-type: none"> <li>The display shows the disk status function, and waits for you to insert disk.</li> </ul> <p>Shows the disk status function.</p>  <p>The display shows: F7 DISK STATUS (BLK) Insert Disk &amp; ENTER</p>  <p>Flashes. Prompts you to insert disk.</p>
<p>2. Insert the disk that you want to check. Then press the ENTER key.</p> <p>Press  </p>	<ul style="list-style-type: none"> <li>The display will show the amount of used disk space and the amount of free disk space. You can now choose another function or change modes.</li> </ul>  <p>The display shows: F7 DISK STATUS (BLK) Searching...</p> <p>Shows the disk status.</p>  <p>The display shows: F7 USED: 413 FREE: 360 Select (0-7): _</p> <p>Shows you can select a function.</p>

# MIDI MODE

## 1. About each of the Functions

### F1 CHANNEL SELECT

#### 1 About the channel select function.

- This function is used to set the MIDI send and receive channel numbers.

The power on default is channel 1 for both transmission and reception.

#### Caution:

Do not change the MIDI Transmission channel number while operating the keyboard, the joystick, or a foot switch connected to the rear panel damper jack.

#### The receive channel values



1ch ~ 16ch

#### The send channel values

1ch ~ 16ch

You can choose any MIDI channel number from 1 through 16 as the send channel or as the receive channel.

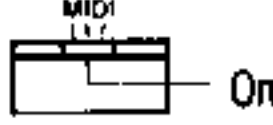
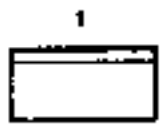
#### 2 Using the channel select function.

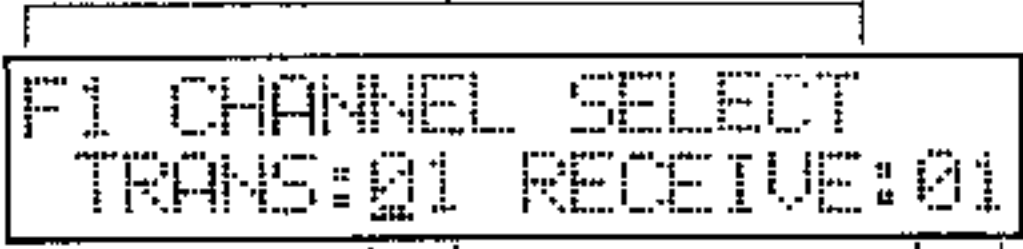
Operation	Operation of DSS-1
① Select the MIDI mode.	<ul style="list-style-type: none"><li>● Indicates MIDI mode.</li></ul> 
② Press the number 1 key.  Press  	<ul style="list-style-type: none"><li>● The display shows the current settings.</li></ul> <p>Shows the channel select function.</p>  <p>Shows the receive channel.      Shows the send channel.</p>

2: Use the CURSOR keys to move the cursor to the send (TRANS) or receive side of the display.

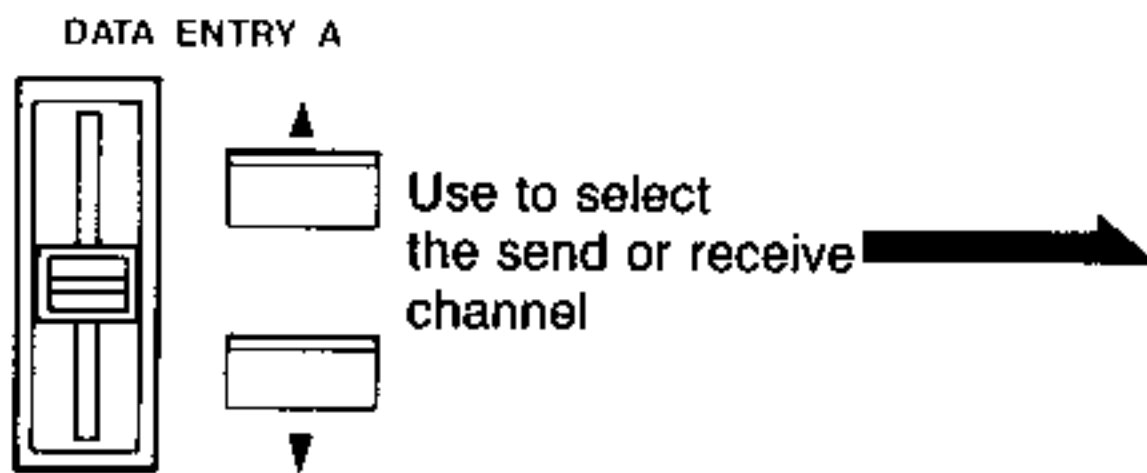
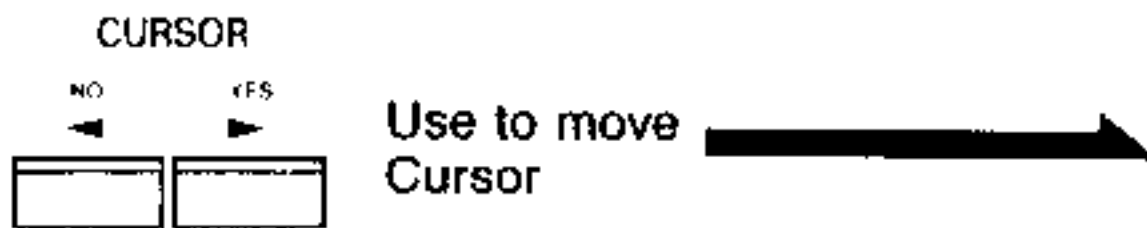

- Then use DATA ENTRY A to select the channel number that you want.

```
F1 CHANNEL SELECT  
TRANS:01 RECEIVE:01
```

(Example shows display when you select the receive channel.)

- Adjust value of parameter at cursor position.

```
F1 CHANNEL SELECT  
TRANS:01 RECEIVE:16
```

(Example shows receive channel set to 16.)

## F2 FUNCTION SELECT

### 1 About the function select function

- This provides filtering for reception of MIDI program change and for transmission and reception of control change, pitch bender, and channel pressure (after-touch).

#### Program change can be set to:

OFF, MODE1, MODE2, MODE3

#### Modulation can be set to:

ON, OFF

#### After-touch can be set to:

ON, OFF

- When a program change message is received, the DSS-1 responds according to your setting in this function. This is shown in the chart here.

Receive Program No.	OFF	MODE 1	MODE 2	MODE 3
0-31	NO CHANGE	SYS A: 1-32	SYS C: 1-32	Current 1-32
32-63	NO CHANGE	SYS B: 1-32	SYS D: 1-32	Current 1-32
64-95	NO CHANGE	SYS C: 1-32	SYS A: 1-32	Current 1-32
96-127	NO CHANGE	SYS D: 1-32	SYS B: 1-32	Current 1-32

- Turn the modulation (MDD) parameter on to enable transmission and reception of control change and pitch bender messages. Turn MOD off to filter out transmission and reception of these message.

- Turn the after-touch (AFT) parameter on to enable transmission and reception of channel pressure messages. Turn MOD off to filter out these messages.

#### NOTE:







If the program change mode is MODE 2 or MODE 3 and the required system name for the received program number is different from the currently resident system name in memory, then the GET SYSTEM function is performed automatically.

(But MIDI parameters will not be loaded.)

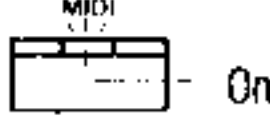
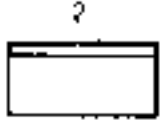
Example: If the program change mode is MODE 2 and system A is in memory, then if program number 32 is received, system D will be loaded and the selected program number will be number 1. (SYS D: P01)

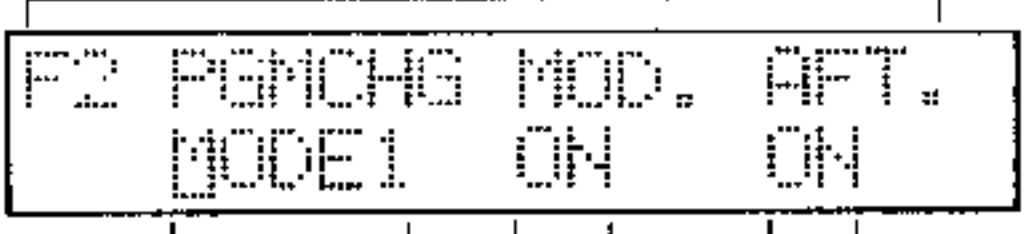

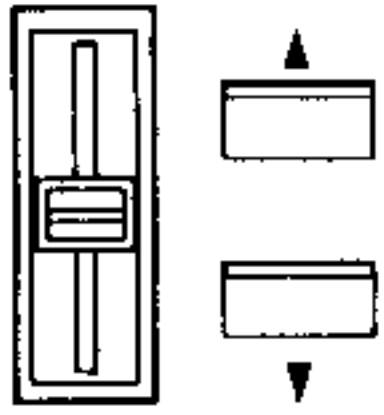
## 2 Using the function select function

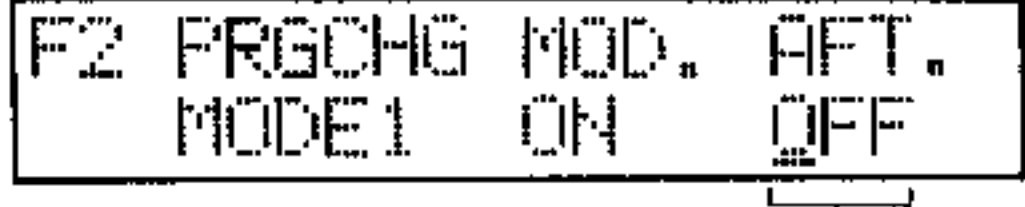
Operation	Operation of DSS-1
<p>0 Select the MIDI mode.</p>	<ul style="list-style-type: none"> <li>Indicates MIDI mode.</li> </ul>  <p>MIDI On</p>
<p>1 Press the number 2 key.</p> <p>Press  </p>	<ul style="list-style-type: none"> <li>Use DATA ENTRY A to adjust the value at the cursor position.</li> </ul> <p>Shows the function select function.</p>  <p>Shows program change. Shows after-touch. Shows modulation.</p>
<p>2 Use the CURSOR keys to move the cursor under the current setting of the parameter that you want to change.</p> <p>CURSOR NO YES  Use to move Cursor </p> <p>DATA ENTRY A  Use to change setting </p>	<ul style="list-style-type: none"> <li>You can adjust the Value where the cursor is displayed.</li> </ul>  <p>(Example: When you select after-touch.)</p> <ul style="list-style-type: none"> <li>Then use DATA ENTRY A to change the value.</li> </ul>  <p>(Example: When you turn after-touch off.)</p>

# F3 OMNI MODE





## 1 About the omni mode function

■ This function lets you change the DSS-1's OMNI mode.

■ Note that the OMNI mode also changes according to OMNI ON and OMNI OFF messages received over MIDI.

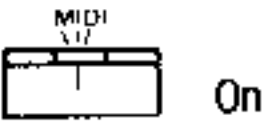
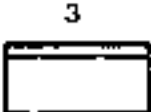
The OMNI mode values
ON, OFF

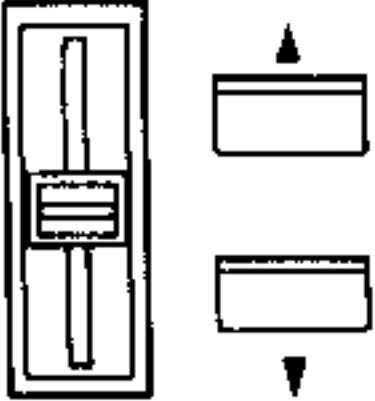
## 2 Using the omni mode function

Operation	Operation of DSS-1
<p>① Select the MIDI mode.</p>	<ul style="list-style-type: none"> <li>Indicates MIDI mode.</li> </ul> 
<p>② Press the number 3 key.</p> <p>Press  →</p>	<ul style="list-style-type: none"> <li>The display shows the current OMNI setting.</li> </ul> <p>Shows the omni mode function.</p>  <p>Shows omni mode on.</p>
<p>③ Use DATA ENTRY A to change the OMNI mode setting.</p> <p>DATA ENTRY A</p>  <p>Use to change OMNI mode setting →</p>	<ul style="list-style-type: none"> <li>Shows the selected OMNI setting.</li> </ul>  <p>(Example shows omni mode off.)</p>

# F4 LOCAL ON/OFF



## 1 About the local on/off function

■ This function lets you switch local control on or off.

■ This setting also changes according to LOCAL OFF messages received over MIDI.

The LOCAL ON/OFF values
ON, OFF

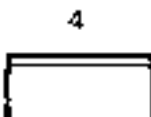
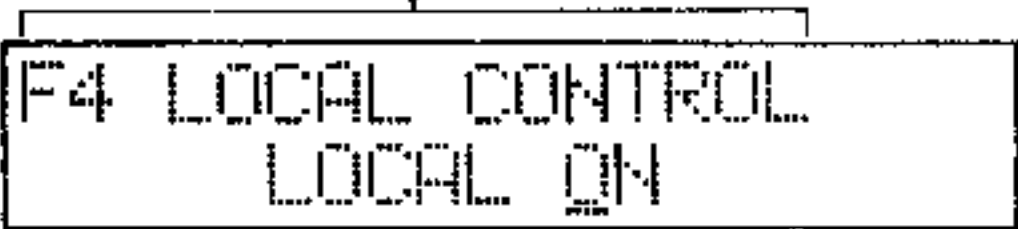
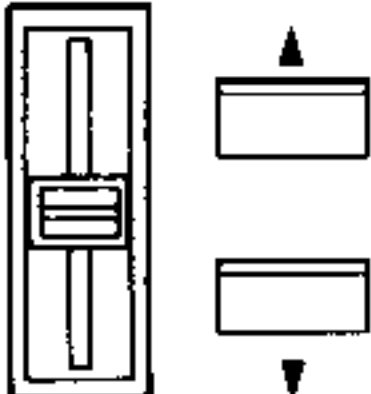
## 2 Using the local on/off function

Operation	Operation of DSS-1
<p>① Select the MIDI mode.</p>	<ul style="list-style-type: none"> <li>Indicates MIDI mode.</li> </ul> 
<p>① Press the number 4 key.</p> <p>Press  →</p>	<ul style="list-style-type: none"> <li>The display shows the current LOCAL CONTROL setting.</li> </ul> <p>Shows the local on/off function.</p>  <p>Shows local control on.</p>
<p>② Use DATA ENTRY A to change the setting.</p> <p>DATA ENTRY A</p>  <p>Use to change the setting →</p>	<ul style="list-style-type: none"> <li>The display shows the selected setting.</li> </ul>  <p>(Example shows local control off.)</p>

## F5 SAVE MIDI PARAMETERS

### 1 About the save MIDI parameters function

■ This lets you save the current MIDI parameter settings to disk. These include the F1 CHANNEL SELECT, F2 FUNCTION SELECT and F3 OMNI MODE values.

■ Saved parameters are loaded from disk together with the systems that they were saved with.

**Note:**



The LOCAL ON/OFF parameter setting is not saved to disk.

### MIDI PARAMETER-MEM.

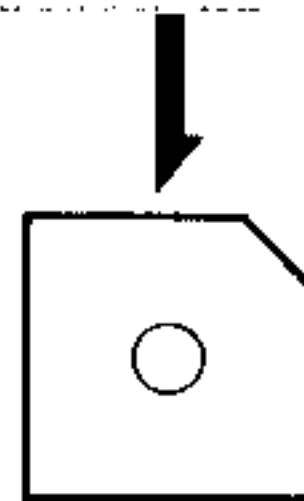
TRANS  
RECEIVE  
PGMCHG  
MOD.  
AFT.  
OMNI MODE

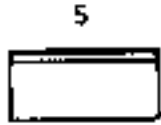

### 2 Using the save MIDI parameters function

Operation	Operation of DSS-1
<p>0 Select the MIDI mode and make sure that there is a disk in the drive.</p>	<p>● Indicates MIDI mode.</p>  <p>The diagram shows a rectangular box with 'MIDI' written above it. Inside the box, there are two horizontal lines. The top line is solid, and the bottom line is dashed. To the right of the box, the word 'On' is written.</p>
<p>1 Press the number 5 key.</p> <p>Press  </p>	<p>● You are asked whether or not you want to save the current MIDI parameter settings to disk.</p> <p>Shows the save midi parameters function.</p>  <p>The screenshot shows a rectangular dialog box with a border. Inside, the text reads: 'F5 SAVE MIDI PRMTR' on the first line and 'Are You Sure? (Y/N)_' on the second line. An arrow points from the text 'Shows the save midi parameters function.' to the top center of the dialog box.</p>

2. Press YES or NO to reply.

★ Press YES to save the MIDI parameter settings to disk.



- The display will confirm completion of the task and give you the function selection prompt.

```
F5 Saving...  
Please Wait a Minute
```



```
F5 Saving Completed  
Select (1-5):_
```

Shows you can select a function.

★ Press NO to abort.



- The display will confirm abortion and give you the function selection prompt.

```
F5 Aborted  
Select (1-5):_
```

Shows you can select a function.

# 2. DSS-1 MIDI IMPLEMENTATION

## 1. TRANSMITTED DATA

### 1-1 CHANNEL MESSAGES

STATUS	SECOND	THIRD	DESCRIPTION
1000 nnnn	0kkk kkkk	0100 0000	Note Off kkk kkkk = 36-96 (NO KEY TRANSPOSE) - 30-101 (KEY TRANSPOSE)
1001 nnnn	0kkk kkkk	0vvv vvv	Note On kkk kkkk = 36-96 (NO KEY TRANSPOSE) - 30-101 (KEY TRANSPOSE) vvv vvv = 14-127 (7 bit resolution)
1011 nnnn	0000 0001	0vvv w00	OSC Modulation vvv w00 = 0-124 (5 bit resolution)
1011 nnnn	0000 0010	0vvv w00	VCF Modulation vvv w00 = 0-124 (5 bit resolution)
1011 nnnn	0100 0000	0000 0000	Damper Off
1011 nnnn	0100 0000	0111 1111	Damper On
1100 nnnn	0ppp pppp		Program Change ppp pppp = 0-127
1101 nnnn	0vvv vvvv		Channel Pressure (After-Touch) vvv vvv = 0-126 (6 bit resolution)
1110 nnnn	0000 0000	0bbb bbbb	Pitch Bender Change bbb bbbb = 0-127 (7 bit resolution)

\* nnnn = channel numbers 0 to 15

\* 0kkk kkkk: note number

If key transpose is used, then the transmitted note number is the transposed value (regular note range of 36 to 96 minus up to 6 or plus up to 5.

\* 0ppp pppp: program number

Program numbers are represented on the display by system programs according to this chart.

Display	Program number	Display	Program number	Display	Program number	Display	Program number
SYSA P01 →	0	SYSB P01 →	32	SYSC P01 →	64	SYSD P01 →	96
SYSA P02 →	1	SYSB P02 →	33	SYSC P02 →	65	SYSD P02 →	97
SYSA P31 →	30	SYSB P31 →	62	SYSC P31 →	94	SYSD P31 →	126
SYSA P32 →	31	SYSB P32 →	63	SYSC P32 →	95	SYSD P32 →	127

### 1-2 SYSTEM EXCLUSIVE MESSAGES

#### 1) DEVICE ID

BYTE	DESCRIPTION
1111 0000	Exclusive Status
0100 0010	KORG ID 42H
0011 nnnn	Format ID 3nH (n=ch)
0000 1011	DSS-1 ID 0BH
1111 0111	EOX

#### 2) DSS-1 SYSTEM EXCLUSIVE MESSAGES

BYTE	DESCRIPTION
1111 0000	Exclusive Status
0100 0010	KORG ID 42H
0011 nnnn	Format ID 3nH (n=ch)
0000 1011	DSS-1 ID 0BH
0fff ffff	Function ID
0ddd dddd	See [3]
0ddd dddd	See [3]
1111 0111	EOX

#### NOTE: FUNCTION ID

- 42H (Mode Data)
- 45H (Multi Sound List)
- 44H (Multi Sound Parameter Dump)
- 43H (PCM Data Dump)
- 46H (Program Name List)
- 40H (Program Parameter Dump)
- 23H (Data Load Completed)
- 24H (Data Load Error)
- 21H (Write Completed)
- 22H (Write Error)

## 2. RECOGNIZED RECEIVE DATA

### 2-1 CHANNEL MESSAGES

STATUS	SECOND	THIRD	DESCRIPTION
1000 nnnn	0kkk kkkk	0xxx xxxx	Note Off velocity will be ignored
1001 nnnn	0kkk kkkk	0vvv vvvv	Note On vvv vvv = 1-127 (7 bit resolution)
1001 nnnn	0kkk kkkk	0000 0000	Note Off
1011 nnnn	0000 0001	0vvv vvvv	OSC Modulation vvv vvv = 0-127 (7 bit resolution)
1011 nnnn	0000 0010	0vvv vvvv	VCF Modulation vvv vvv = 0-127 (7 bit resolution)
1011 nnnn	0000 0111	0vvv vvvv	Volume vvv vvv = 0-127 (7 bit resolution)
1011 nnnn	0100 0000	0vvv vvvv	Damper Off
1011 nnnn	0100 0000	0vvv vvvv	Damper On vvv vvv = 0-63
1011 nnnn	0100 0000	0vvv vvvv	Damper On vvv vvv = 64-127
1011 nnnn	0111 1010	0000 0000	Local Control Off
1011 nnnn	0111 1010	0111 1111	Local Control On
1011 nnnn	0111 1011	0000 0000	All Notes Off
1011 nnnn	0111 1100	0000 0000	Omni Mode Off
1011 nnnn	0111 1101	0000 0000	Omni Mode On
1100 nnnn	0ppp pppp		Program Change
1101 nnnn	0vvv vvvv		Channel Pressure (After-Touch) vvv vvv = 0-127 (7 bit resolution)
1110 nnnn	0xxx xxxx	0bbb bbbb	Pitch Bender Change LSB will be ignored.

\* Mode messages are received only on the specified channel even if OMNI is on.

\* 0kkk kkkk = 0 to 127: note number

\* 0ppp pppp = 0 to 127: program number

The MIDI mode function 2 program change mode settings affect received program numbers as shown in this chart.

Receive program number.	Program change mode.	MODE1	MODE2	MODE3	OFF
0-31		SYS A   32	SYS C   32	Current   32	No Change
32-63		SYS B   32	SYS D   32	Current   32	No Change
64-95		SYS C   32	SYS A   32	Current   32	No Change
96-127		SYS D   32	SYS B   32	Current   32	No Change

### 2-2 SYSTEM REAL TIME MESSAGE

BYTE	DESCRIPTION
1111 1110	Active Sensing

### 2-3 SYSTEM EXCLUSIVE MESSAGES

#### 1) DEVICE ID REQUEST

BYTE	DESCRIPTION
1111 0000	Exclusive Status
0100 0010	KORG ID 42H
0100 nnnn	Format ID 4nH (n=ch)
1111 0111	EOX

#### 2) DSS-1 SYSTEM EXCLUSIVE MESSAGES

BYTE	DESCRIPTION
1111 0000	Exclusive Status
0100 0010	KORG ID 42H
0011 nnnn	Format ID 3nH (n=ch)
0000 1011	DSS-1 ID 0BH
0fff ffff	Function ID
0ddd dddd	See [3]
0ddd dddd	See [3]
1111 0111	EOX

**NOTE: FUNCTION ID**

- 12H (Mode Request)
- 13H (Play Mode Request)
- 16H (Multi Sound List Request)
- 45H (Multi Sound List)
- 15H (Multi Sound Parameter Request)
- 44H (Multi Sound Parameter Dump)
- 14H (PCM Data Request)
- 43H (PCM Data Dump)
- 17H (Program Name List Request)
- 10H (Program Parameter Request)
- 40H (Program Parameter Dump)
- 41H (Program Parameter Change)
- 11H (Write Request)

**3DS-1 SYSTEM EXCLUSIVE FORMAT**

**1. MODE REQUEST (FUNCTION ID = 12, RECEIVE ONLY)**

FORMAT	DESCRIPTION
F0 42 3n 0B 12 F7	Mode Request

**2. MODE DATA (FUNCTION ID = 42, TRANSMIT ONLY)**

FORMAT	DESCRIPTION
F0 42 3n 0B 42	Mode Data Header
aa (1 byte)	Mode Data (NOTE 1)
F7	EOX

**NOTE 1: MODE DATA**

- 00 (PLAY MODE)
- 01 (SAMPLE MODE)
- 02 (EDIT SAMPLE)
- 03 (CREATE WAVE FORM MODE)
- 04 (MULTI SOUND MODE)
- 05 (MIDI MODE)
- 06 (SYSTEM MODE)
- 07 (DISK UTILITY MODE)
- 08 (PROGRAM PARAMETER MODE)

**3. PLAY MODE REQUEST (FUNCTION ID = 13, RECEIVE ONLY)**

FORMAT	DESCRIPTION
F0 42 3n 0B 13 F7	Play Mode Request

**4. MULTISOUND LIST REQUEST (FUNCTION ID = 16, RECEIVE ONLY)**

FORMAT	DESCRIPTION
F0 42 3n 0B 16 F7	Multi Sound List Request

**5. MULTISOUND LIST (FUNCTION ID = N45, SAME FOR TRANSMIT AND RECEIVE)**

FORMAT	DESCRIPTION
F0 42 3n 0B 45	Multi Sound List Header
aa (1 byte)	Number of Multi Sounds
bb-----bb (14 bytes)	Multi Sound 1 Data (NOTE 1)
cc-----cc (14 bytes)	Multi Sound 2 Data
ss (1 byte)	Last Multi Sound Data
F7	Check Sum (see 4)-(3)
	EOX

**NOTE 1: MULTI SOUND DATA**

FORMAT	DESCRIPTION
dd-----dd (8 bytes)	Multi Sound Name (see 4)-(4)
ee-----ee (6 bytes)	Multi Sound Length

**6. MULTISOUND PARAMETER REQUEST (FUNCTION ID = 15, RECEIVE ONLY)**

FORMAT	DESCRIPTION
F0 42 3n 0B 15	Multi Sound Parameter Request Header
aa (1 byte)	Multi Sound No. - 1
F7	EOX

**7. MULTISOUND PARAMETER DUMP (FUNCTION ID = 44, SAME FOR TRANSMIT AND RECEIVE)**

FORMAT	DESCRIPTION
F0 42 3n 0B 44	Multi Sound Parameter Dump Header
aa (1 byte)	Multi Sound No. - 1
bb-----bb (8 bytes)	Multi Sound Name (see 4)-(4)
cc-----cc (6 bytes)	Multi Sound Length
dd (1 byte)	bit 7 - 6: 01 (Loop On) 00 (Loop Off)
	bit 5 - bit 0: Number of Sounds
ee (1 byte)	Max Interval (NOTE 1)
ff-----ff (36 bytes)	Sound 1 Parameter (NOTE 2)
gg-----gg (36 bytes)	Sound 2 Parameter
ss (1 byte)	Last Sound Parameter
F7	Check Sum (see 4)-(3)
	EOX

**NOTE 1: MAX INTERVAL**

Sets maximum value obtained with following formula.  
(The lower 7 bits of the twos complement.)

$$(Top\ key) - (Org\ key) + \begin{cases} 12 (16kHz) \\ 7 (24kHz) \\ 0 (32kHz) \\ 5 (48kHz) \end{cases}$$

**NOTE 2: SOUND PARAMETER**

FORMAT	DESCRIPTION
hh (1 byte)	Top Key (MIDI Note No.)
ii (1 byte)	Original Key (MIDI Note No.)
jj (1 byte)	Relative Tune 1 (-63) - 127 (+63)
kk (1 byte)	Relative Level (-1 - 64)
ll (1 byte)	Relative Cutoff (-1 - 64)
mm-----mm (6 bytes)	Sound Word Length
nn-----nn (6 bytes)	Sound Start Address (see 4)-(5)
pp-----pp (6 bytes)	Sound Length
qq-----qq (6 bytes)	Loop Start Address (see 4)-(5)
rr (6 bytes)	Loop Length
tt (1 byte)	bit 7 - 6: 00 (Transpose), 01 (Non Transpose)
	bit 5 - bit 0: Sampling Frequency
	0 (32kHz)
	1 (24kHz)
	2 (16kHz)
	3 (48kHz)

**8. PCM DATA REQUEST (FUNCTION ID = 14, RECEIVE ONLY)**

FORMAT	DESCRIPTION
F0 42 3n 0B 14	PCM Data Request Header
aa-----aa (6 bytes)	Start Address (Absolute)
bb-----bb (6 bytes)	Last Address + 1 (Absolute)
F7	EOX

**9. PCM DATA DUMP (FUNCTION ID = 43, SAME FOR TRANSMIT AND RECEIVE)**

FORMAT	DESCRIPTION
F0 42 3n 0B 43	PCM Data Dump Header
aa-----aa (6 bytes)	Start Address (Absolute)
bb-----bb (6 bytes)	Last Address + 1 (Absolute)
cc-----cc (2 bytes)	PCM Data of Start Address (see 4)-(2)
dd-----dd (2 bytes)	PCM Data of Last Address
ss	Check Sum (see 4)-(3)
F7	EOX





16.DSS-1 PROGRAM PARAMETER MAP

PROGRAM PARAMETER	PARAMETER No. (NOTE 1)	OFFSET (NOTE 1)	VALUE RANGE (DECIMAL)
OSC 1 MIX RATIO (F14)	0	0	0-100(NOTE 2)
OSC 2 MIX RATIO (F14)	1	1	0-100(NOTE 2)
AUTO BEND INTENSITY (F19)	2	2	0-127
NOISE LEVEL (F21)	3	3	0-63
VCF MODE (F31)	4	4	0(12dB) 1(24dB)
VCF EG POLARITY (F31)	5	5	0(-) 1(+)
VCF CUTOFF (F32)	6	6	0-127
VCF EG INTENSITY (F32)	7	7	0-63
VCF RESONANCE (F33)	8	8	0-63
VCF KBDTRACK (F33)	9	9	0-63
VCF MG-FREQUENCY (F34)	10	10	0-63
VCF MG-DELAY (F34)	11	11	0-63
VCF MG-INTENSITY (F34)	12	12	0-63
VCF EG-ATTACK (F35)	13	13	0-63
VCF EG-DECAY (F35)	14	14	0-63
VCF EG-BREAK POINT (F35)	15	15	0-63
VCF EG-SLOPE (F35)	16	16	0-63
VCF EG-SUSTAIN (F35)	17	17	0-63
VCF EG-RELEASE (F35)	18	18	0-63
VCA DECAY KBDTRACK (F37)	19	19	0-63 (0-63) 64-127(0--63)
VCA TOTAL LEVEL (F36)	20	20	0-63
VCA EG-ATTACK (F38)	21	21	0-63
VCA EG-DECAY (F38)	22	22	0-63
VCA EG-BREAK POINT (F38)	23	23	0-63
VCA EG-SLOPE (F38)	24	24	0-63
VCA EG-SUSTAIN (F38)	25	25	0-63
VCA EG-RELEASE (F38)	26	26	0-63
VEL. SENS.- A. BEND INTENSITY (F41)	27	27	0-63
VEL. SENS.- VCF CUTOFF (F42)	28	28	0-63
VEL. SENS.- VCF EG ATTACK (F43)	29	29	0-63
VEL. SENS.- VCF EG DECAY (F43)	30	30	0-63
VEL. SENS.- VCF EG SLOPE (F43)	31	31	0-63
VEL. SENS.- VCA EG LEVEL (F44)	32	32	0-63
VEL. SENS.- VCA EG ATTACK (F45)	33	33	0-63
VEL. SENS.- VCA EG DECAY (F45)	34	34	0-63
VEL. SENS.- VCA EG SLOPE (F45)	35	35	0-63
AFT. TOUCH- OSC MG INTENSITY (F51)	36	36	0-15
AFT. TOUCH- VCF (MG) CUTOFF (F52)	37	37	0-15
AFT. TOUCH- VCF PARAMETER SLCT. (F52)	38	38	0(MG) 1(CUTOFF)

PROGRAM PARAMETER	PARAMETER No. (NOTE 1)	OFFSET (NOTE 1)	VALUE RANGE (DECIMAL)
AFT TOUCH- VCA LEVEL (F53)	39	39	0-15
JOYSTICK PITCH BEND RANGE (F61)	40	40	0-12
JOYSTICK VCF SWEEP (F62)	41	41	0(OFF) 1(ON)
EQUALIZER TREBLE (F65)	42	42	0-12(-4~+8)
EQUALIZER BASS (F65)	43	43	0-12(-4~+8)
DDL MG-A FREQ. (F74)	44	44	0-63
DDL MG-B FREQ. (F74)	45	45	0-63
(LOW)		46	
DDL-1 TIME (F81)	46	46	0-500(NOTE 3)
(HIGH)		47	
DDL-1 FEEDBACK (F82)	47	48	0-15
DDL-1 EFFECT LEVEL (F83)	48	49	0-15
DDL-1 MG-A INTENSITY (F84)	49	50	0-63
DDL-1 MG-B INTENSITY (F84)	50	51	0-63
DDL-2 INPUT SELECT (F91)	51	52	0(DIRECT) 1(DDL-1)
(LOW)		53	
DDL-2 TIME (F92)	52	54	0-500(NOTE 3)
(HIGH)		54	
DDL-2 FEEDBACK (F93)	53	55	0-15
DDL-2 EFFECT LEVEL (F94)	54	56	0-15
DDL-2 MG-A INTENSITY (F95)	55	57	0-63
DDL-2 MG-B INTENSITY (F95)	56	58	0-63
DDL-2 MOD. INVERT SW (F96)	57	59	0(NORMAL) 1(INVERT)
OSC 1 MULTI SOUND No. (F12)	58	60	0-15(1-16)
OSC 2 MULTI SOUND No. (F13)	59	61	0-15(1-16)
MAX OSC BEND RANGE	60	62	0-12 NOTE 4
SYNC MODE SW (F16)	61	63	0(OFF) 1(ON)
D/A RESOLUTION (F16)	62	64	0(6 bits) 1(7 bits) 2(8 bits) 3(10 bits) 4(12 bits)
OSC 1 OCTAVE (F11)	63	65	0(16) 1(8) 2(4)
OSC 2 OCTAVE (F11)	64	66	0(16) 1(8) 2(4)
OSC 2 DETUNE (F15)	65	67	0-63
OSC 2 INTERVAL (F15)	66	68	0-11
OSC MG SELECT (F17)	67	69	0(OFF) 1(OSC 1) 2(OSC 2) 3(BOTH)
OSC MG-FREQUENCY (F17)	68	70	0-31
OSC MG-INTENSITY (F17)	69	71	0-15

PROGRAM PARAMETER	PARAMETER No. (NOTE 1)	OFFSET (NOTE 1)	VALUE RANGE (DECIMAL)
OSC MG-DELAY (F17)	70	72	0-15
AUTO BEND SELECT (F18)	71	73	0(OFF) 1(OSC 1) 2(OSC 2) 3(BOTH)
AUTO BEND-POLARITY (F18)	72	74	0(DOWN) 1(UP)
AUTO BEND-TIME (F19)	73	75	0-31
UNISON DETUNE (F64)	74	76	0-7(1-8)
VEL. SENS. OSC CHANGE (F46)	75	77	0-31
KEY ASSIGN MODE (F63)	76	78	0(POLY 2) 1(POLY 1) 2(UNISON)
UNISON VOICES (F64)	77	79	0(2) 1(4) 2(6) 3(8)

**NOTE:**

- Parameter No.: Parameter number used for program parameter change.  
Offset: Byte offset within program parameter dump.  
Numbers within parentheses are parameter numbers used when editing within the DSS-1.
- Must be set for both oscillators so that  $OSC1 + OSC2 = 100$ .

**3. DDL TIME Format**

LOW	0	b6	b5	b4	b3	b2	b1	b0
HIGH	0	0	0	0	0	0	b8	b7

- The MAX BEND RANGE value is limited to the range of 0 to 12, derived by subtracting from 12 the larger MAX INTERVAL value of the multisounds assigned to OSC1 and OSC2. This must be reset if there is a change in the multisound MAX INTERVAL.

# 3. Using the System Exclusive Messages

■ The DSS-1 handles the following information as system exclusive messages.

## Data that can be transmitted and received.

The DSS-1 sends data upon receiving particular request messages. The DSS-1 also changes parameter settings upon receiving particular data.

<b>MULTISOUND LIST</b>	: A list of multisounds in the DSS-1 system. Sent when a <b>SOUND LIST REQUEST</b> message is received.
<b>MULTISOUND PARAMETER DUMP</b>	: The parameter data for one multisound in the DSS-1 system. This is used, for instance, when computing PCM data addresses. Sent when a <b>MULTISOUND PARAMETER REQUEST</b> is received.
<b>PCM DATA DUMP</b>	: Refers to PCM data within the specified area of DSS-1 PCM data memory. Sent when a <b>PCM DATA REQUEST</b> message is received.
<b>PROGRAM PARAMETER DUMP</b>	: Refers to data for a single program in program memory. Sent when a <b>PROGRAM PARAMETER DUMP REQUEST</b> is received. If the DSS-1 receives this data, it stores it in the program output buffer (not directly in program memory).

## Data that is only transmitted.

This data is sent upon receiving particular system exclusive messages.

<b>DEVICE ID</b>	: Name of device, sent when <b>DEVICE ID REQUEST</b> is received.
<b>MODE DATA</b>	: Data indicating DSS-1 mode, sent when <b>MODE REQUEST</b> is received.
<b>PROGRAM NAME LIST</b>	: The program name list from program memory, sent when a <b>PROGRAM NAME LIST REQUEST</b> is received.
<b>DATA LOAD COMPLETED</b>	: Indicates successful reception of data. A response to <b>MULTISOUND LIST</b> , <b>MULTISOUND PARAMETER DUMP</b> , <b>PCM DATA DUMP</b> , or <b>PROGRAM PARAMETER DUMP</b> .
<b>DATA LOAD ERROR</b>	: Indicates a problem with data reception. A response to errors in the format or checksum.
<b>WRITE COMPLETED</b>	: Indicates successful completion of program write operation. A response to a <b>WRITE REQUEST</b> .
<b>WRITE ERROR</b>	: Indicates that the program write was not performed because the <b>WRITE REQUEST</b> program number was not within the range of 0 to 31. A reply to a <b>WRITE REQUEST</b> .

## Data that is only received.

These are "request messages" which ask the DSS-1 for information or cause a change in some aspect of DSS-1 operation.

<b>DEVICE ID REQUEST</b>	: A request for the <b>DEVICE ID</b> of the receiving device.
<b>PLAY MODE REQUEST</b>	: Changes DSS-1 mode to the play mode.

<b>MODE REQUEST</b>	: A request for <b>MODE DATA</b> .
<b>MULTISOUND LIST REQUEST</b>	: A request for the multisound list.
<b>MULTISOUND PARAMETER REQUEST</b>	: A request for a multisound parameter dump.
<b>PCM DATA REQUEST</b>	: A request for a PCM data dump.
<b>PROGRAM NAME LIST REQUEST</b>	: A request for the program name list.
<b>PROGRAM PARAMETER REQUEST</b>	: A request for a program parameter dump.
<b>PROGRAM PARAMETER CHANGE</b>	: Change parameter values in the program output buffer.
<b>WRITE REQUEST</b>	: A request to write data from the program output buffer to program memory. Depending on the program number received, the response will be <b>WRITE COMPLETED</b> or <b>WRITE ERROR</b> .

■ Using these system exclusive messages you can exchange data with a computer equipped with a MIDI interface and suitable software.

■ Connections are as shown here.

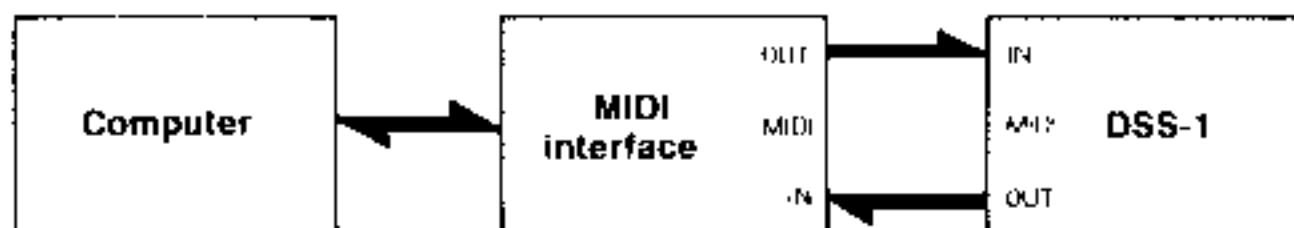

■ DSS-1 exclusive messages use the send/receive channel numbers determined by MIDI mode **F1 CHANNEL SELECT**. These must match on the computer in order to send and receive system exclusive messages. Messages on the wrong channels are ignored. (They are not affected by the channel mode message **OMNI mode**.)

**Important Note:** Unpredictable behavior may result if you send data to the DSS-1 that is outside the specified bounds. Check your data if strange things are happening. There could also be bugs in the software.

■ The DSS-1 must be in the **PLAY MODE** for transmission and reception of system exclusive messages other than reception of **DEVICE ID REQUEST**, transmission of **DEVICE ID**, reception of **MODE REQUEST**, transmission of **MODE DATA**, and reception of **PLAY MODE REQUEST**.

■ When the DSS-1 is not in the play mode but is in a mode from which it can switch into the play mode, then a **PLAY MODE REQUEST** can be used to change it to the play mode. After doing this you should transmit a **MODE REQUEST** to confirm the play mode and then go ahead with transmission and reception of the system exclusive messages.

■ When transferring **MULTISOUND LIST** and **MULTISOUND PARAMETER** data to the DSS-1, it is necessary for the two to have the same **NUMBER OF MULTISOUNDS**, **MULTISOUND NAME**, and **MULTISOUND LENGTH**.

■ The **MULTISOUND LENGTH** is used to find the absolute address for PCM data. Therefore, be careful when changing the **MULTISOUND LENGTH** if there are several multisounds resident in the DSS-1.

■ Typical applications:

(1) To edit PCM data.

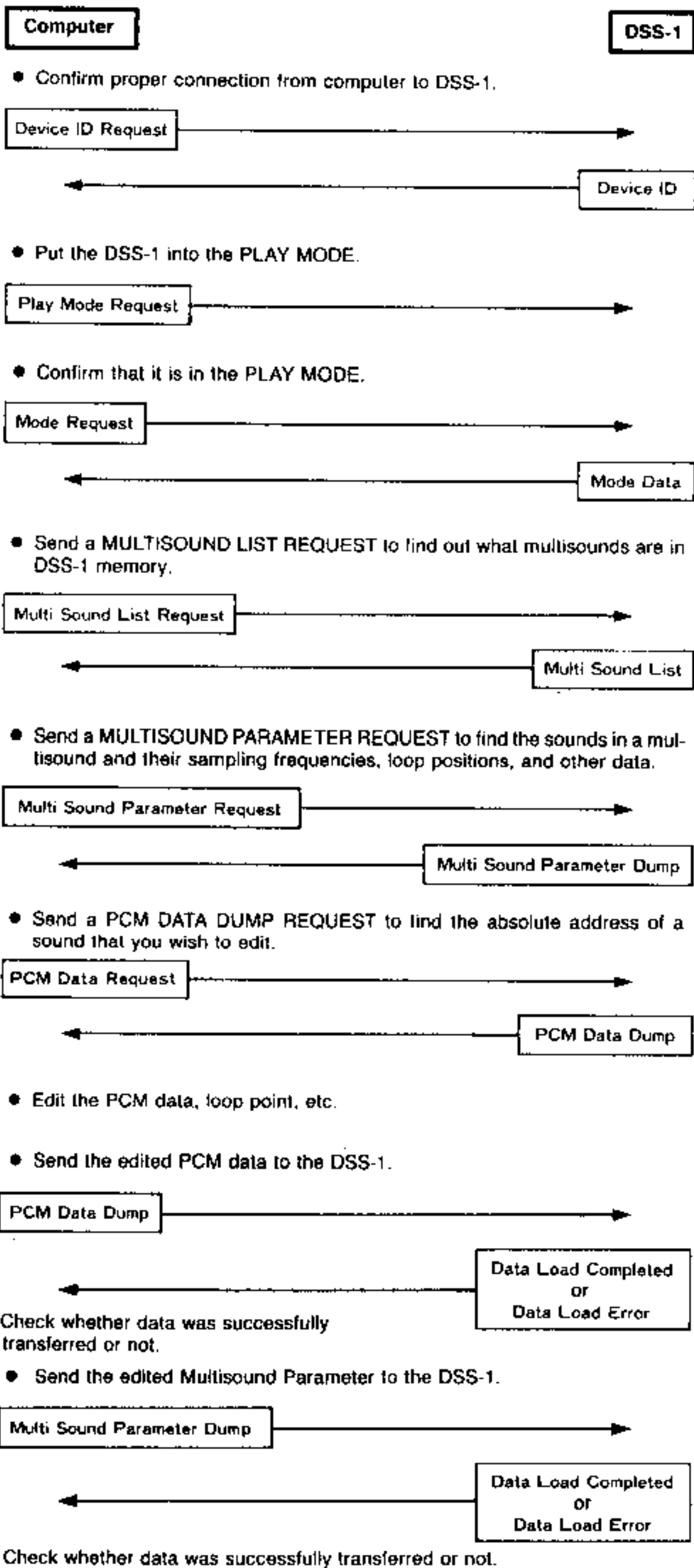

● Send a MULTISOUND LIST if the edit resulted in a change in the MULTISOUND LIST.

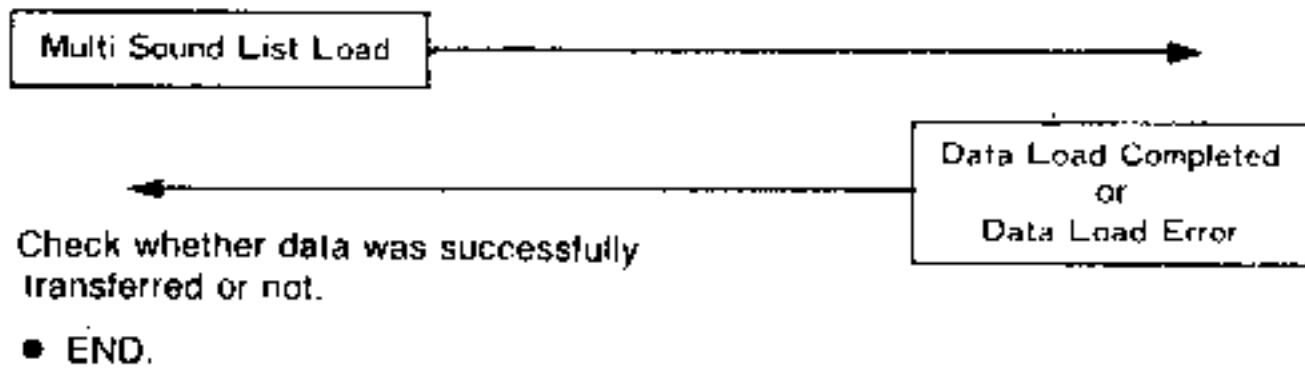

(2) To edit program parameters.

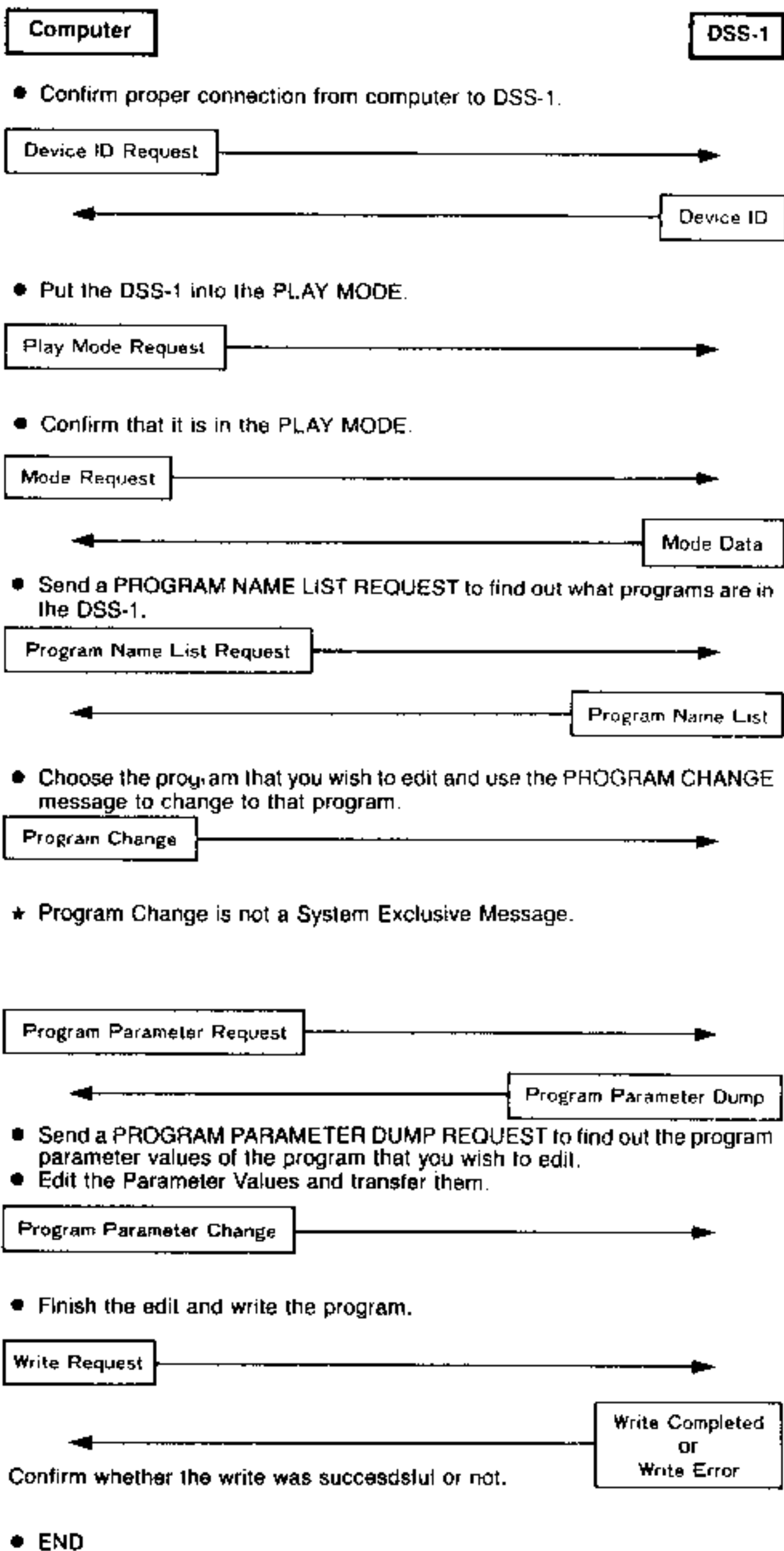

# **N O T I C E**

Korg products are manufactured under strict specifications and voltages required by each country. These products are warranted by the Korg distributor only in each country. Any Korg product not sold with a warranty card or carrying a serial number disqualifies the product sold from the manufacturer's/distributor's warranty and liability. This requirement is for your own protection and safety.

# SPECIFICATIONS & OPTIONS

---

- **KEYBOARD:** C~C 61 Keys, Velocity, After Touch
- **CONTROLLERS:** Joystick (X Axis: OSC/VCF fc Bend, +Y Axis: OSC Modulation, -Y Axis: VCF Modulation), Program Up Jack, Sustain Damper Jack
- **CONFIGURATION:** 8 Voices, 16 Oscillators, (2 Oscillators per Voice), 8 VCF Modules, 8 VCA Modules
- **SOUND SOURCES:** Waveforms Obtained by Sampling, 128 Harmonic Synthesis, or "Drawing" can be edited, assigned to sections of the keyboard and looped. 12-bit quantization. Sampling Frequencies and Times: 16kHz, 16s, 24kHz, 11s, 32kHz, 8s, 48kHz, 5.5s (can be used together as one sound source), Number of Keyboard Split Points: Up to 16
- **NUMBER OF SOUND SOURCES:** Up to 16 in internal wave RAM, Up to 120 per Disk
- **EFFECTS:** Digital Delay x2, Equalizer HIGH & LOW (All Programmable)
- **NUMBER OF PROGRAMS:** 32 in memory, 128 on disk
- **BUILT-IN DISK DRIVE:** Takes 3.5-inch, Double Sided, Double Density (1MB unformatted) Floppy Disks, 770K Bytes PCM Data Storage Capacity per Disk
- **SUPPLIED ACCESSORIES:** Floppy Disks x4, AC Power Cord
- **DIMENSIONS:** 1171 (W) x 436 (D) x 123 (H) mm
- **WEIGHT:** 18.5kg
- **OPTIONS:** PS-1 PEDAL SWITCH, PS-2 PEDAL SWITCH, TWC-030 TWIN CABLE (3m), DS-1 DAMPER SWITCH, KH-1000 DYNAMIC STEREO HEADPHONES, HC-DSS HARD CASE, MIDI CABLE (7m/10m/12m), MF-2DD MICRO FLOPPY DISKS, SOUND PROGRAM LIBRARY

★ Specifications subject to change without notice.

# ERROR MESSAGES

Message	Meaning
Drive Not Ready/ Set Disk or CANCEL	There is no disk set in the drive. To cancel, hold down the CANCEL key for two seconds or more.
UNFORMATED./	The disk in the drive has not been formatted for the DSS-1. You must format the disk in the DSS-1 in order to use it in this drive.
PROTECTED./ (HARD)	Format, save, and delete functions can not be carried out because the disk's write protect tab is in the protect or write disable (read only) position. Reset the tab to the write enable (read/write) position. Then try again.
PROTECTED./ (SOFT)	The disk is set to the write protect mode, so you can not perform save or delete operations. Use disk utility mode F1 to reset the protection, then try again.
DISK FULL./	Free area on the disk is insufficient to store the sounds or multisounds that you are trying to save. Or, the save procedure will cause the number of sounds and multisounds to exceed the limits of the disk. In either case, you can delete sounds or multisounds from the disk to make space, or you can save to a different disk.
SYSTEM Incompleted	An incomplete system has been loaded because a multisound or multisounds that were supposed to be in the system were not found on the disk. Check the relationships (dependencies) between the programs and multisounds. This message may appear also if there is a data error in the MIDI parameters or multisound list. Refer to the DATA ERROR message.

Message	Meaning
NO M.SNDS EXIST	There are no multisounds in the system. In other words, the system has not been finished.
NO SOUNDS	There is not a single sound on the disk.
NO M.SNDS	There is not a single multisound on the disk.
NO FILE./	The multisound or sound that you tried to get does not exist on that disk.
DATA ERROR./	Data written or read from disk is garbled and meaningless. Most data errors are caused by dirt on the disk or damage to the disk. This problem also occurs if the disk and the drive are not very compatible or if the drive heads are dirty. If this message appears when getting data, try taking out the disk, inserting it again, and then repeating the get procedure several times. If this message appears when saving data, there is a danger of corrupting other data on that disk, so use a new disk to save the data. Use the old disk for getting data only. * To clean the heads, insert a commercially available dual sided head cleaning disk and perform the sound directory function two or three times.

# DIGITAL SAMPLING SYNTHESIZER MODEL DSS-1 MIDI Implementation Chart

Function...	Transmitted	Recognized	Remarks
Basic Channel Default Changed	1 1 — 16	1 1 — 16	
Mode Default Messages Altered	3 × .....	1 OMNI ON, OMNI OFF	
Note Number : True voice	36 — 96 (NOTE 1) .....	0 — 127	
Velocity Note ON Note OFF	○ 9n, v = 14 — 127 × 8n, v = 64	v = 1 — 127 ×	
After Touch Key's Ch's	× ○	× ○	(NOTE 2)
Pitch Bender	○	○	7 bit reso (NOTE 3)
Control Change 1 2 7 64	○ ○ × ○	○ ○ ○ ○	OSC Modulation VCF Modulation Volume Damper Pedal Switch (NOTE 3)
Program Change : True #	○ 0 — 127 .....	○ 0 — 127	(NOTE 4)
System Exclusive	○	○	(NOTE 5)
System Common : Song Position : Song Select : Tune	× × ×	× × ×	
System Real Time : Clock : Commands	× ×	× ×	
Aux Messages : Local ON/OFF : All Notes OFF : Active Sensing : Reset	× × × ×	○ ○ ○ ×	
Notes	<p>NOTE 1: When transpose is active, the range is adjusted by the amount of the transpose value (-6, -5, -4, -3, -2, -1, 1, 2, 3, 4, 5).</p> <p>NOTE 2: After touch transmission and reception depends upon the after touch parameter settings.</p> <p>NOTE 3: Pitch bender and control change transmission and reception depend on modulation parameter settings.</p> <p>NOTE 4: Program change transmission range depends on the system being used. Response to received program change data depends on the program change parameter settings.</p> <p>NOTE 5: System exclusive messages can generally only be sent and received in the play mode.</p>		

Mode 1: OMNI ON, POLY    Mode 2: OMNI ON, MONO  
Mode 3: OMNI OFF, POLY    Mode 4: OMNI OFF, MONO

○ : Yes  
× : No



# KORG Distributors List

## ANDORRA

Marrugat  
Avinguda Meritxell, 25. ANDORRA LA VELLA  
(Principat d'andorra)  
Phone: 20132-22115

## AUSTRALIA

Music Link Australia Pty Ltd.  
42 Victoria Street, Richmond, Victoria 3121  
Phone: (03) 429 9299

## AUSTRIA

Weiss & Kadlec  
Trestler Strasse 261, 1232 Wien  
Phone: 0222/674539

## BAHRAIN

Marshall Boutique  
P.O. Box No. 925, Government Road  
Phone: 251664

## BARBADOS

A & B Music Supplies Ltd  
Hadley House, Prince Alfred St., Bridgetown  
Phone: (809) 427 5384/429-5217

## BELGIUM

Coninx Music Import  
Grote Markt 5, 3600 Genk  
Phone: (011) 357736

## BERMUDA

Rihijuoma's The Music Makers  
Queen St Black Stone 1617 Hamilton  
Phone: (809 29) 5-0890

## BRASIL

Franz Purwin  
Caixa Postal 14475  
22 412 Rio de Janeiro RJ BRASIL  
Phone: (021) 257-1939

## CANADA

Erikson (A Division of Jam Industries Ltd.)  
378 Isabey Street St-Laurent, Quebec Canada  
H4T 1W1  
Phone: 514-738-3000

## CANARY ISLANDS

Musicanarias S L  
Post code 38004 Rambla de Puerto 60 Santa  
Cruz de Tenerife  
Phone: (922) 27 06 09

## CHILE

Industrias Musicales Arriagada  
Moneda 720 Of 110 CP Santiago  
Phone: 331819

## COSTA RICA

Almacén J.M. Arcua V  
Apartado 926, San José  
Phone: 24 88 98

## CYPRUS

Leon's Music Stores  
P.O. Box 1440, Limassol  
Phone: 051-73111, 051-86079

## CZECHOSLOVAKIA

Media  
Strakonická 510  
150 00 PRAHA 5  
Phone: 54 53 46 9

## DENMARK

Hagstrom MUSIK EN GROS  
Øresundsvej 14B, DK-2300 København S  
Phone: 01554812

## ECUADOR

Casa Musical Victor Freire  
P.O. Box 6521 Guayaquil  
Phone: 522572

## EGYPT

Al Fanny Trading Office  
(Abdallah George Youssef)  
P.O. Box 2904, El Horieh, Heliopolis Cairo  
Phone: 697603

## EL SALVADOR

Almacenes Sman S.A. de C.V.  
P.O. Box (06) 800, San Salvador  
Phone: 22 0555

## ENGLAND

Rose Means & Co. Ltd - KORG (UK)  
32-34 Gordon House Road, London NW6 1NE  
Phone: 01 267 5152

## FIJI ISLANDS

CINEPHOTO ELECTRONICS  
Div of South Sea Souvenirs  
P.O. Box 288, Suva City  
Phone: 24305, 25260

## FINLAND

Kaukomarkkinat Oy  
Kutojantie 4, SF-02630, ESPOO 63  
Phone: 358-0-523711

## FRANCE

Gaffarel Musique SA  
Z.I. des Béthunes, 12, Av., Alsace-Lorraine,  
95310 Saint-Ouen-l'Aumône  
Phone: (1) 30.37.28.65

## FRENCH POLYNESIA

CONSCIENCE MUSIC SHOP  
Rue Jeanna d'Arc, P.O. Box 1860,  
Papeete Tahiti  
Phone: 2. 85. 63

## PEDRON MUSIC HOUSE

B.P. 2725, Papeete Tahiti  
Phone: 3. 71. 89

## GREECE

Bon Studio  
8 Zaimi Str., Athens 10683  
Phone: 3633.572

## HONG KONG

Tom Lee Music Co., Ltd.  
15/F., World Shipping Centre,  
Harbour City, 7 Canton Road,  
Kowloon  
Phone: 3 7221098

## HUNGARY

KONSUMEX  
Hungarian Foreign Trade Company  
1441 Budapest, P.O. Box 58  
Phone: 530-511

## ICELAND

Tónkvísi  
Lautasvegí 17, 101 Reykjavík  
Phone: 25336

## ITALY

CGD Messaggerie Musical spa  
via M.F. Quintiliano, 40, 20138 Milano  
Phone: 02/50841

## ISRAEL

Sommerfeld Music Centre  
8, Ben-Yehuda Road, Tel-Aviv  
Phone: 296775

## JORDAN

Forelise Music Center  
P.O. Box 3152, Jabat Amman, Amman  
Phone: 604955

## Twang Music Center

P.O. Box 35034, Amman  
Phone: 644201

## KOREA

White Tiger Enterprise Co.  
81-2 Yunhi-Dong, Sudaemoo-ku, Seoul  
Phone: 322-5557

## KUWAIT

Technice Trading Co., Ltd  
P.O. Box 5032, KUWAIT, Arabian Gulf  
Phone: 423917

## LEBANON

Amount's  
Sadat St Ras Beirut  
Phone: 232417

## MALTA

Audio & Auto Sound  
61 Villambrosa Street, Hamrun  
Phone: 606457

## MEXICO

Casa de Musica, S.A. de C.V.  
Bolivar No. 75, cod Postal 06080 México, D.F.  
Phone: 512-73 37, 747-23-17

Casa Veerkamp, S.A.  
Grandes Almacenes de Musica  
Mesones 21, Apartado Postal M-851  
Mexico 1, D.F.  
Phone: (91-5) 585-33-11

Casa Wagner de Gradalajara, S.A.  
Corona 202, Guadafajara, Jal  
Phone: 13-14-14

## NEW CALEDONIA

SOUND PACIFIC  
39 Rue de Sebastopol Noumes  
Phone: 27 23 93

## NEW ZEALAND

Custom Music Limited  
P.O. Box 9648, newmarket, Auckland 1  
Phone: 500-272, 500-535

## NORWAY

Hagstrom Musikk A/S  
Nadderudvn 63, 1347 Hoste  
Phone: 248090

## PANAMA

Compania Alfaro, S.A.  
Apartado 200, Panama 1.  
Phone: 23 0292

## PARAGUAY

Music Hall SAIC  
Palma 567, Asuncion  
Phone: 46-715

## PHILIPPINES

Universal Systems Products Corporation  
2nd Floor, Natividad Building  
2308 Pasong Tamo Extension  
Makati, Metro Manila  
Phone: 86-75-67, 87-98-41

## POLAND

Centrala Handlowa Przemyslu Muzycznego  
ul, Długa 5, 00 263 Warszawa  
Phone: 31-15-73, 31-32-31

## R.O.C

Hai Kuo Musical Instrument Co., Ltd.  
2nd Fl., No. 23, Sec. 1, Chung Hsiao-West  
Road, Taipei, Taiwan  
Phone: 02-314-3113

## REP. OF SOUTH AFRICA

Hohner (South Africa) (Pty.) Ltd.  
2nd Floor, Mayveer House, 160 President  
Street, (cor, Nugget Street) 2001 Johannesburg  
Phone: 402-3726

## SINGAPORE

City Music Co., Pte., Ltd  
1 Sophia Road, #02-12/13 Peace Centre  
Singapore 0922  
Phone: 337 7058, 337 7545, 337 3549

## SPAIN

Letusa S.A.  
Las Fraguas s/n, Apartado de Correos 125,  
Alcorcon (Madrid)  
Phone: (91) 612 3376

## SWEDEN

MUSITECH AB  
Malmbergsgatan 4, S-211 38 Malmö  
Phone: 040 706 25

## SWITZERLAND

Musik-Meyer AG  
Spitalstr. 74, 8952 Schlieren  
Phone: 01 730 55 05

## SYRIA

Meka Music House  
MGRDITCH KAZANJIAN  
P.O. Box No 340, Shouhada St, Azizieh Aleppo  
Phone: 20861

Sarkis Kalaydjian  
102 Maternie St. (Maydan), Aleppo  
Phone: 43357

## THAILAND

Beh Ngiep Seng Ltd., Part.  
No. 110 Nakorn Kasem Soi 1 Bangkok  
Phone: 222-5281

## THE NETHERLANDS

Milestone B.V.  
Gildenweg 16, Zwijndrecht, P.O. Box 207  
Phone: (078) 10 0044

## U.A.E.

Abdulla Sultan Al Sharhan  
Music Gallery  
P.O. Box 1675, Deira-Dubai  
Phone: 221509

## U.S.A

KORG U.S.A., Inc.  
89 Frost St., Westbury, New York 11590  
Phone: 516-333-9100

## URUGUAY

Man/Pozza Internacional  
Casilla de Correo 6243, Montevideo

## WEST GERMANY

Musik-Meyer GmbH  
Postfach 1729, 3550 Marburg/Lahn  
Phone: 06421/81051