

The background of the page features a series of overlapping circles of varying sizes, some of which are partially cut off by the edges. Several thin, curved lines extend from the top right towards the center, each ending in a small circle, resembling drumsticks or a stylized graphic element. The Yamaha logo is positioned in the top right corner.

YAMAHA

DD-9
DIGITAL PERCUSSION

Owner's Manual
Bedienungsanleitung
Manual d'emploi
Manual de instrucciones

The serial number of this product may be found on the bottom of the unit. You should note this serial number in the space provided below and retain this manual as a permanent record of your purchase to aid identification in the event of theft.

Model No. DD-9

Serial No. _____

**Entsorgung leerer Batterien
(nur innerhalb Deutschlands)**

Leisten Sie einen Beitrag zum Umweltschutz. Verbrauchte Batterien oder Akkumulatoren dürfen nicht in den Hausmüll. Sie können bei einer Sammelstelle für Altbatterien bzw. Sondermüll abgegeben werden. Informieren Sie sich bei Ihrer Kommune.

Welcome

Congratulations! You are now the proud owner of a powerful new musical instrument capable of inspiring and fueling your musical creativity. This is not just another digital percussion instrument. The DD-9 is the result of passion, vision, and commitment from people who want you to enjoy yourself every time you play it. We're sure you'll agree as you discover the limitless possibilities of your new digital percussion instrument! Keep this manual in a safe place for future reference.

Contents

<i>The DD-9 At a Glance</i>	2
<i>Setting Up</i>	3
<i>Playing the Demo</i>	4
<i>Percussion Set</i>	4
<i>Pad Assign</i>	5
<i>Style</i>	5
<i>Tempo</i>	6
<i>Tap Start</i>	6
<i>Auto Roll</i>	7
<i>Sound Effect</i>	7
<i>Troubleshooting</i>	8
<i>Specifications</i>	8
<i>Percussion Set List</i>	33
<i>Voice List</i>	33

Taking Care of the DD-9

Avoid Heat

Avoid placing the DD-9 near windows, heaters or other areas subject to excessive heat or in a car exposed to direct sunlight.

Avoid Dust and Moisture

Avoid locations where the DD-9 is likely to be exposed to excessive dust or moisture.

Avoid Physical Shocks

Do not subject the DD-9 to strong physical shocks and avoid placing heavy objects on it.

Avoid Television and Radio Interference

The DD-9 contains digital circuitry and may cause interference if it is placed too close to radio or television receivers. If interference occurs, move the DD-9 farther away from the

affected receiver(s).

Cleaning the DD-9

Use only a soft, dry or slightly damp cloth to clean the DD-9. Never use solvents or thinners to clean the instrument.

Avoid Power Cord Damage

Do not place the DD-9 where somebody is liable to step on, trip over or crush the power cord or any other connecting cables.

Making Connections

Before making any connections, turn off the power of the DD-9 and any other equipment. Lower the volume on all audio equipment to the minimum level when turning the power on.

The DD-9 At a Glance

Front View

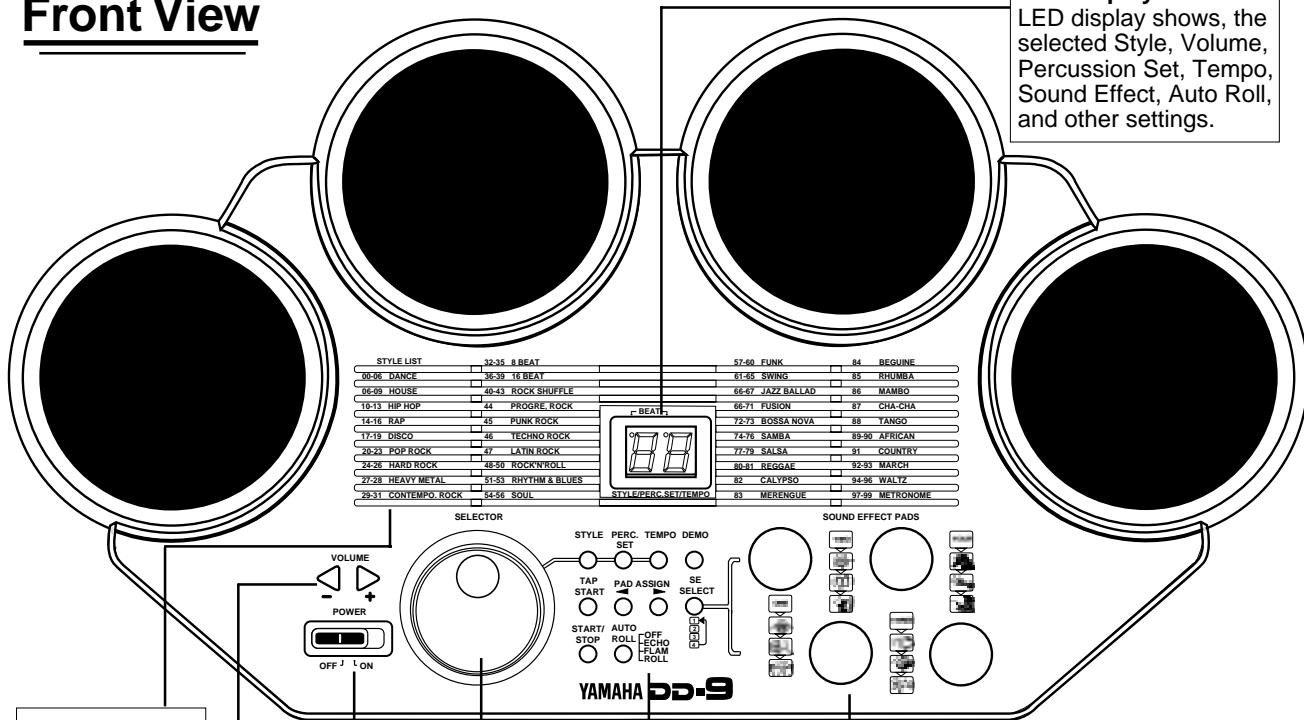

LED display
LED display shows, the selected Style, Volume, Percussion Set, Tempo, Sound Effect, Auto Roll, and other settings.

STYLE list
The Style list is on the front panel for easy reference.

SOUND EFFECT pads
The DD-9 has four Sound Effect pads featuring a total of 16 realistic sound effects.

VOLUME buttons
The volume of the DD-9 is controlled by the two VOLUME buttons. The maximum volume is automatically set when you turn on the power. Holding down either the ◀ or ▶ button decreases or increases the volume rapidly.

POWER switch
To turn on the DD-9, move the POWER switch to the right; to turn it off move the POWER switch to the left.

SELECTOR dial
The SELECTOR dial can be an extremely quick way to adjust the Percussion Set, Pad Assignment, Auto Rhythm Style, Tempo and Sound Effect sets. Refer to each section appropriately, for details.

Operating buttons
STYLE (See page 5.)
PERC. SET (See page 4.)
TEMPO (See page 6.)
DEMO (See page 4.)
TAP START (See page 6.)
PAD ASSIGN (See page 5.)
SE SELECT (See page 7.)
START/ STOP (See pages 4, 5 and 6.)
AUTO ROLL (See page 7.)

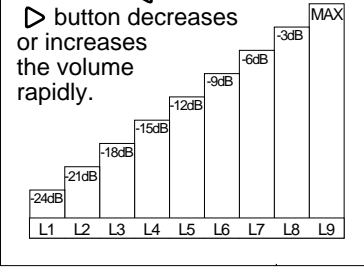

Side View

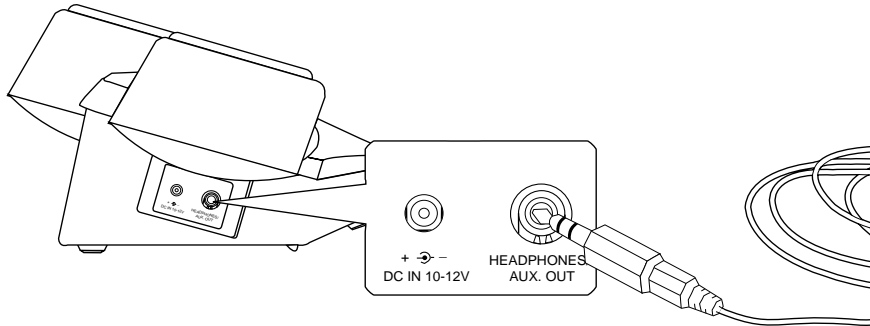

Supplied Accessories

- Percussion Sticks
- Voice List

Setting Up

Percussion Pads

Striking two percussion pads at the same time produces simultaneous sounds according to the voices assigned to the respective pads.

Sensitivity

The DD-9's main percussion pads feature touch sensors so that they respond just like acoustic percussion instruments. Striking the percussion pads with different force results in relatively loud or soft sounds accordingly. Be careful not to strike the pads with excessive force as this may seriously damage the percussion pad sensors.

Headphones

You can use a standard pair of stereo headphones, such as Yamaha's HPE-3 or HPE-150, with the DD-9 for private practice.

To connect headphones insert the headphone plug into the HEADPHONES/AUX. OUT jack. The DD-9's internal speakers will switch off automatically when you plug in a pair of headphones.

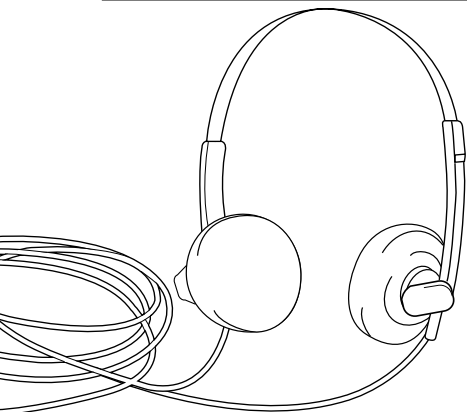

Supplying Power

The DD-9 will operate on either an optional power adaptor or optional batteries.

▼ To connect a power adaptor:

1. Connect only a Yamaha PA-1, PA-1B or PA-3 power adaptor to the DC IN jack of the DD-9.
2. Plug the power adaptor into an AC power outlet.

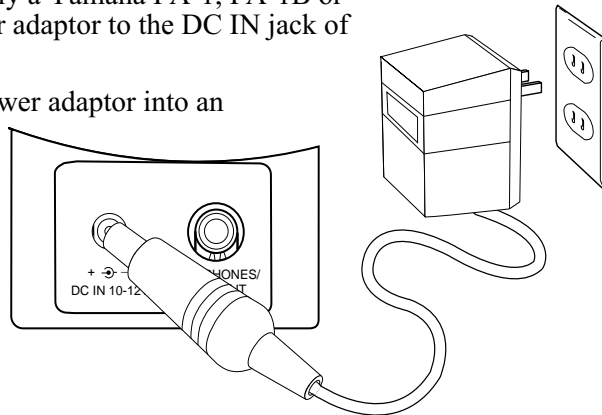

Caution: The use of any other power adaptors may cause serious damage to the DD-9.

▼ To insert batteries:

1. Remove the battery compartment cover located on the bottom of the DD-9.

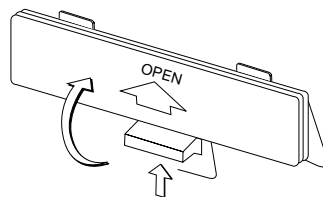

2. Insert six (6) 1.5 V "AA" (R-6, SUM-3) or equivalent batteries into the battery compartment.

Make sure the polarities are lined up as indicated in the battery compartment.

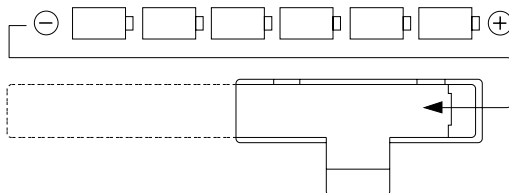

3. Replace the battery compartment cover securely.



Caution: To prevent damage due to battery leakage, remove all the batteries from the instrument when it is not to be used for an extended period of time.

- When the batteries are low, replace with a complete set of six new batteries. Never mix old and new batteries or different types of batteries. The batteries are low when the DD-9's voices become noticeably distorted or the DD-9 resets to default settings unexpectedly.

Playing the Demo

To give you an idea of the DD-9's sophisticated capabilities, it comes with a demonstration song.

▼ To play back the demonstration song:

1. Press the DEMO button.



2. To stop playback, press either the DEMO button again or the START/STOP button.

DEMO



OR

START/
STOP



You can begin playing the DD-9's percussion pads as soon as you turn the POWER switch on and adjust the volume to an appropriate level.

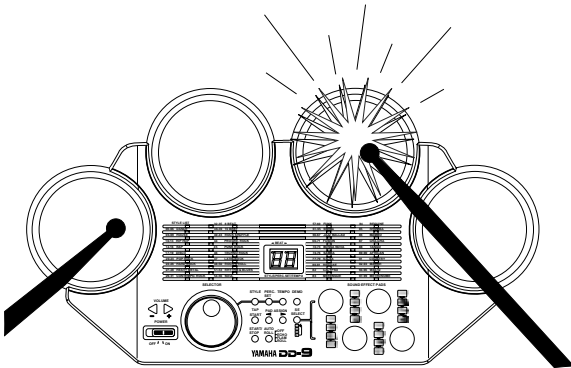

Percussion Set

The DD-9 allows you to choose from ten different Percussion Sets quickly and easily. Nine Percussion Sets have preset voice combinations. (See Percussion Set List on page 33.) The DD-9 has one Custom Percussion Set allowing you to combine any four of the DD-9's voices into a set. (See "Pad Assign" on page 5.)

▼ To select a Percussion Set:

1. Press the PERC. SET button to enter the Percussion Set mode.

PERC.
SET



The current Percussion Set number appears in the LED display.

You have approximately three seconds after the PERC. SET button is released to start selecting a Percussion Set before the DD-9 returns to the Auto Rhythm Style mode.

2. Press the PERC. SET button repeatedly or turn the SELECTOR dial until the desired Percussion Set number appears in the LED display.

PERC.
SET



OR

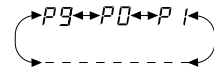
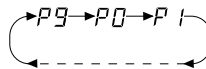
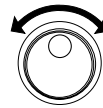

The Percussion Set numbers only cycle forward when you press the PERC. SET button.

The SELECTOR dial turns either clockwise or counterclockwise and the Percussion Set numbers cycle up or down accordingly.

- ❑ Percussion Sets appear in the LED display as P0-P9. P0 is the Custom Percussion Set and P1-P9 represent different combinations of four voices.
- ❑ Percussion Set P1 is automatically selected when the power is turned on.

Pad Assign

The DD-9 contains a total of 55 high quality voices that can be assigned to each of the four percussion pads. The Custom Set pad assignment allows any combinations of the 55 voices.

▼ To assign a voice to a percussion pad:

1. Strike the percussion pad to which you want to assign a voice.



2. Press and hold either the ◀ or ▶ PAD ASSIGN button.



The currently assigned voice number is shown in the LED display.

3. While holding either PAD ASSIGN button, strike the same percussion pad repeatedly or turn the SELECTOR dial until the desired voice number appears in the LED display. (See the supplied Voice List or page 33.)

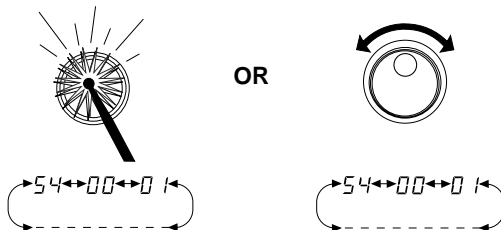

Voice numbers cycle from 00 to 54 to 00 when striking the percussion pad.

The ◀ PAD ASSIGN button decreases the voice number and the ▶ PAD ASSIGN button increases the voice number.

4. Release the ◀ or ▶ PAD ASSIGN button.
A new voice is now assigned to the designated percussion pad.
5. Repeat steps 1 to 4 for any or all of the other DD-9 percussion pads to set the four percussion pads to the desired voice(s).

- ❑ The DD-9 always returns to Custom Set P0 when assigning voices to a percussion pad.
- ❑ All pad assignment changes are memorized in Custom Set P0 until the power is turned off.

Style

The DD-9 features a large variety of Auto Rhythm Styles including variations of basic 8 and 16 beat patterns as well as more exotic styles such as Son Afro and Calypso. You can play along with any of the DD-9 Auto Rhythm Styles. (See the front panel for the Style list.)

▼ To select and play back an Auto Rhythm Style:

1. Press the STYLE button repeatedly or turn the SELECTOR dial until the desired Auto Rhythm Style number appears in the LED display.

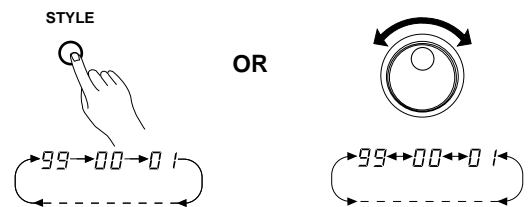

The Auto Rhythm Style numbers only cycle forward when you press the STYLE button.

The SELECTOR dial turns either clockwise or counterclockwise and the Auto Rhythm Style numbers cycle up or down accordingly.

2. Press the START/STOP button.



The currently selected Auto Rhythm Style plays back.

To stop playback, press the START/STOP button again.

- ❑ You can select another Auto Rhythm Style or enter the Tempo, Percussion Set or Sound Effect Set mode while any Auto Rhythm Style is playing.
- ❑ Auto Rhythm Style "Dance 1" is automatically selected and "00" appears in the LED display when the power is turned on.
- ❑ Auto Rhythm Style "00" is selected and appears automatically in the LED display when the demonstration song is stopped.

Tempo

The tempo can be adjusted in 35 steps, from 40 to 280 beats per minute (bpm). The steps are shown in the LED display as values from 01 to 35. The default tempo varies according to Auto Rhythm Style.

▼ To adjust the tempo:

1. Press the TEMPO button to enter the Tempo mode.

TEMPO



The currently selected Tempo value appears in the LED display and the right Tempo dot lights.

You have approximately three seconds after releasing the TEMPO button to start adjusting the tempo setting before the DD-9 returns to Auto Rhythm Style mode.

2. Press the TEMPO button repeatedly or turn the SELECTOR dial until the desired tempo value appears in the LED display.

TEMPO



OR

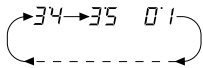

The tempo values only cycle forward when you press the TEMPO button.

The SELECTOR dial turns either clockwise or counterclockwise and the tempo values cycle up or down accordingly.

The range of available tempos is from 40 to 280 bpm. You can change the current tempo while any Auto Rhythm Style is playing.

Tap Start

The DD-9 features a Tap Start function that sets the overall tempo depending on how fast you strike the percussion pads. This is an advanced feature that is very useful for coordinating your playing tempo with the selected Auto Rhythm Style tempo.

▼ To set the tempo with Tap Start:

1. Press the TAP START button to enter the Tap Start mode.

TAP START



The left Tempo dot flashes at the current tempo indicating that you are in Tap Start standby mode.

To cancel the Tap Start mode, press the TAP START button again.

2. Strike any percussion pad three or four times depending on the time signature of the selected Auto Rhythm Style.
3. Playback of the currently selected Auto Rhythm Style will start at the desired tempo right after the third or fourth strike on the percussion pad.
4. To stop playback, press the START/STOP button.



To stop playback and enter Tap Start standby mode, press the TAP START button.

START/STOP



OR

TAP START



LED display Tempo Dots

The DD-9 has two tempo lights in the top of the LED display. During Auto Rhythm Style playback, the two lights flash in a specific pattern so you can keep the beat easily.

The tempo lights flash as follows:

1st measure				
	1st Beat	2nd Beat	3rd Beat	4th Beat
2nd measure				

Auto Roll

The DD-9 is equipped with three Auto Roll effects that help enhance your playing. The effects include ECHO, FLAM and ROLL. Each of these effects varies according to the selected tempo so that the initial strike starts the effect and the DD-9 keeps the beat throughout the effect's duration. Auto Roll effects work only with the percussion pads.

▼ To select an Auto Roll effect:

1. Press the AUTO ROLL button once to enter the Auto Roll mode.

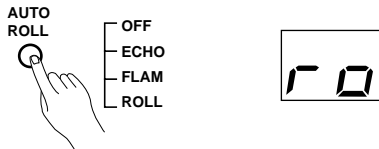

The current Auto Roll setting will appear in the LED display for approximately 3 seconds.

2. Select an effect from the list next to the AUTO ROLL button and press the AUTO ROLL button in succession until the desired effect setting appears in the LED display.

The Auto Roll OFF setting is automatically selected when the power is turned on.

- ❑ *The Auto Roll function may produce unexpected effects or not produce any effect at all, depending on the voice selected and the tempo setting.*

Effect Setting	Description
	<p>No Auto Roll effects are assigned.</p>
	<p>The DD-9 will produce a fading echo sound automatically.</p>
	<p>The DD-9 will produce a double note (called a flam) for every single note you play.</p>
	<p>The DD-9 will produce a drum roll synchronized with the tempo setting. Each time you strike a percussion pad a roll will follow.</p>

Sound Effect

The DD-9 has four sound effect pads that feature 16 realistic and versatile sound effects. A set of four different sound effects, represented by the symbols printed on the DD-9's front panel, is available for each sound effect pad.

▼ To select different sound effects:

1. Press the SE SELECT button to enter the Sound Effect mode.



The current sound effect set number will appear in the LED display.

You have approximately three seconds, after releasing of the SE SELECT button to start selecting the sound effect setting before the DD-9 returns to the Auto Rhythm Style mode.

2. Press the SE SELECT button repeatedly or turn the SELECTOR dial until the desired sound effect set number appears in the LED display.

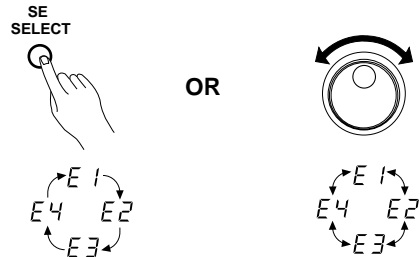

The sound effect set numbers only cycle forward from E1 to E4 when you press the SE SELECT button.

The SELECTOR dial turns either clockwise or counterclockwise and the sound effect set numbers cycle up or down accordingly.

Troubleshooting

In many cases, seemingly big problems or malfunctions can be remedied easily. Please check the following list before deciding that your DD-9 is broken.

If the problem is not listed here or the suggested remedy is ineffective, take the DD-9 to an authorized Yamaha dealer for proper diagnosis and repairs. Do not attempt to repair this digital percussion instrument as serious damage may occur.

A buzz or click occurs momentarily when the DD-9 is turned ON or OFF.

- This is a normal power surge noise that occurs when the POWER switch is operated.

The LED display is completely dark.

- The batteries are low and should be replaced immediately.

No sound comes from the speakers.

- The volume is turned down too low and should be adjusted up appropriately.
- A plug is inserted into the HEADPHONES/AUX. OUT jack and should be taken out immediately.

The wrong voice plays when you strike a percussion pad.

- The desired voice has not been assigned to the percussion pad. Use the PAD ASSIGN function to program the desired voice to the appropriate percussion pad.

The custom pad voice assignments have disappeared or defaulted.

- The batteries are low and should be replaced immediately.
- The POWER switch has been turned OFF and ON and the default voices have replaced the desired voices. Use the PAD ASSIGN function to program the desired voices again.

When the percussion pads are struck, the LED display goes dark momentarily and then changes to the default reading "00".

- The batteries are low and should be replaced immediately.

Specifications

Percussion pads	4 (touch sensitive)
SE pads	4
Percussion sets	9 preset + 1 custom
Auto Rhythm Styles	100
Instrument and Sound Effect Voices	55
Auxiliary Functions	Tap Start, Auto Roll, Auto Rhythm Style, Demonstration Song
Panel Controls	POWER switch, SELECTOR dial, VOLUME buttons, STYLE button, PERC. SET button, TEMPO button, TAP START button, PAD ASSIGN buttons, START/STOP button, AUTO/ROLL button, SE SELECT button, DEMO button
LED Display	STYLE/PERCUSSION SET/TEMPO and other settings
Connectors	DC IN 10-12V Headphones/AUX.OUT
Main amplifier	3.8W (EIAJ)
Speaker	10.0cm
Power Source	AC power adaptor YAMAHA PA-1, PA-1B, or PA-3 (sold separately)
	Batteries Six "AA" size, SUM-3, R-6, or equivalent batteries (sold separately)
Dimensions (W x D x H)	435mm x 236mm x 160mm (17 1/8" x 9 1/4" x 6 1/3")
Weight	1.4 Kg (3 lbs., 1oz.)
Supplied accessories	Percussion Sticks Voice List

* Specifications subject to change without notice.

Percussion Set List

	Name	PAD 1		PAD 2		PAD 3		PAD 4	
P0	CUSTOM SET	01	Bass Drum 2	04	Snare 2	10	E. Tom 1 Hi	18	Crash Cymbal
P1	BASIC SET	00	Bass Drum 1	03	Snare 1	13	Hi-Hat (Closed)	17	Ride Cymbal
P2	FILL IN SET	03	Snare 1	10	E. Tom 1 Hi	11	E. Tom 1 Low	18	Crash Cymbal
P3	ROCK SET	01	Bass Drum 2	04	Snare 2	09	Tom Low	18	Crash Cymbal
P4	DANCE SET	02	Bass Drum 3	06	Snare 3	12	E. Tom 2	49	Orchestra Hit
P5	LATIN SET 1	22	Conga Mute	20	Conga Hi	21	Conga Low	25	Cabasa
P6	LATIN SET 2	28	Timbale Hi	29	Timbale Low	26	Cowbell	18	Crash Cymbal
P7	LATIN SET 3	23	Agogo Hi	24	Agogo Low	27	Cuica	31	Hand Clap
P8	EFFECT SET	43	SFX 1	44	SFX 2	45	SFX 3	49	Orchestra Hit
P9	REMIX SET	04	Snare 2	05	Snare Reverse	18	Crash Cymbal	19	Crash Reverse

• The DD-9 percussion pads are numbered 1-4 from left to right.

Voice List

Type	No.	Voice	Type	No.	Voice
Bass Drums	00	Bass Drum 1 (Normal)	Percussion	28	Timbale Hi
	01	Bass Drum 2 (Heavy)		29	Timbale Low
	02	Bass Drum 3 (Electric)		30	Finger Snap
Snare Drums	03	Snare 1 (Normal)		31	Hand Clap
	04	Snare 2 (Heavy)		32	Cross Sticks
	05	Snare Reverse		33	Metronome
	06	Snare 3 (Electric)		34	"One"
	07	Rim Shot		35	Reverse Voice
Toms	08	Tom Hi		36	"Two"
	09	Tom Low		37	"Three"
	10	E. Tom 1 Hi		38	"Four"
	11	E. Tom 1 Low		39	Gorilla
	12	E. Tom 2	40	Cat	
Hi-Hats	13	Hi-Hat (Closed) 1	41	Dog	
	14	Hi-Hat (Open) 1	42	Horse	
	15	Hi-Hat (Closed) 2	43	SFX 1	
	16	Hi-Hat (Open) 2	44	SFX 2	
Cymbals	17	Ride Cymbal	45	SFX 3	
	18	Crash Cymbal	46	Beep	
	19	Crash Cymbal Reverse	47	Alarm	
Percussion	20	Conga Hi	48	Applause	
	21	Conga Low	49	Orchestra Hit	
	22	Conga Mute	50	Telephone	
	23	Agogo Hi	51	Horn	
	24	Agogo Low	52	Laughter	
	25	Cabasa	53	Breaking Glass	
	26	Cowbell	54	Metronome Accent	
	27	Cuica			

• Any of the above voices can be assigned to each of the four percussion pads.

For details of products, please contact your nearest Yamaha or the authorized distributor listed below.

Die Einzelheiten zu Produkten sind bei Ihrer unten aufgeführten Niederlassung und bei Yamaha Vertragshändlern in den jeweiligen Bestimmungsländern erhältlich.

Pour plus de détails sur les produits, veuillez-vous adresser à Yamaha ou au distributeur le plus proche de vous figurant dans la liste suivante.

Para detalles sobre productos, contacte su tienda Yamaha más cercana o el distribuidor autorizado que se lista debajo.

NORTH AMERICA

CANADA

Yamaha Canada Music Ltd.
135 Milner Avenue, Scarborough, Ontario, M1S
3R1, Canada
Tel: 416-298-1311

U.S.A.

Yamaha Corporation of America
6600 Orangethorpe Ave., Buena Park, Calif.
90620, U.S.A.
Tel: 714-522-9011

MIDDLE & SOUTH AMERICA

MEXICO

Yamaha De Mexico S.A. De C.V.,
Departamento de ventas
Javier Rojo Gomez No.1149, Col. Gpe Del
Moral, Deleg. Iztapalapa, 09300 Mexico, D.F.
Tel: 686-00-33

BRASIL

Yamaha Musical Do Brasil LTDA.
Ave. Reboucas 2636, São Paulo, Brasil
Tel: 55-11 853-1377

PANAMA

Yamaha De Panama S.A.
Edificio Interseco, Calle Elvira Mendez no.10,
Piso 3, Oficina #105,
Ciudad de Panama, Panama
Tel: 507-69-5311

OTHER LATIN AMERICAN COUNTRIES AND CARIBBEAN COUNTRIES

Yamaha Music Latin America Corp.
6101 Blue Lagoon Drive, Miami,
Florida 33126, U.S.A.
Tel: 305-261-4111

EUROPE

THE UNITED KINGDOM

Yamaha-Kemble Music (U.K.) Ltd.
Sherbourne Drive, Tilbrook,
Milton Keynes, MK7 8BL England
Tel: 0908-366700

IRELAND

Danfay Ltd.
61D, Sallynoggin Road, Dun Laoghaire, Co.
Dublin
Tel: 01-2859177

GERMANY/SWITZERLAND

Yamaha Europa GmbH.
Siemensstraße 22-34, D-2084 Rellingen, F.R. of
Germany
Tel: 04101-3030

AUSTRIA/HUNGARY/SLOVENIA/ ROMANIA/BULGARIA

Yamaha Music Austria Ges m b H.
Schleiergasse 20, A-1100 Wien Austria
Tel: 0222-60203900

THE NETHERLANDS

Yamaha Music Benelux B.V.,
Verkoop Administratie
Kanaalweg 18G, 3526 KL Utrecht,
The Netherlands
Tel: 030-828411

BELGIUM/LUXEMBOURG

Yamaha Music Benelux B.V.,
Brussels-office
Keiberg Imperiastraat 8, 1930 Zaventem,
Belgium
Tel: 02-7258220

FRANCE

Yamaha Musique France, Division
Instruments Electroniques et de Scène
BP 70-77312 Mame-la-Valée Cedex 2, France
Tel: 01-64-61-4000

ITALY

Yamaha Musica Italia S.P.A.,
Home Keyboard Division
Viale Italia 88, 20020 Lainate (Milano), Italy
Tel: 02-935-771

SPAIN

Yamaha-Hazen Electronica Musical, S.A.
Jorge Juan 30, 28001, Madrid, Spain
Tel: 91-577-7270

PORTUGAL

Valentim de Carvalho CI SA
Estrada de Porto Salvo, Paço de Arcos 2780
Oeiras, Portugal
Tel: 01-433-3398/4030/1823

GREECE

Philippe Nakas S.A.
Navarinou Street 13, P.Code 10680, Athens,
Greece
Tel: 01-364-7111

SWEDEN

Yamaha Scandinavia AB
J.A. Wettergrens gata 1, Box 30053,
400 43 Göteborg, Sweden
Tel: 031-496090

DENMARK

YS Copenhagen Liaison office
Finsensvej 86, DK-2000 Frederiksberg,
Denmark
Tel: 31-87 30 88

FINLAND

Fazer Music Inc.
Aleksanterinkatu 11, SF 00100 Helsinki,
Finland
Tel: 0435 011

NORWAY

Narud Yamaha AS
Østerdalen 29, 1345 Østerås
Tel: 02-24 47 90

ICELAND

Páll H. Pálsson
P.O. Box 85, Reykjavik, Iceland
Tel: 01-19440

OTHER EUROPEAN COUNTRIES

Yamaha Europa GmbH.
Siemensstraße 22-34, D-2084 Rellingen, F.R. of
Germany
Tel: 04101-3030

AFRICA

Yamaha Corporation,
International Marketing Division
Nakazawa-cho 10-1, Hamamatsu, Japan 430
Tel: 053-460-2311

MIDDLE EAST

TURKEY/CYPRUS
Yamaha Musique France, Division Export
BP70-77312 Mame-la-Valée Cedex 2, France
Tel: 01-64-61-4000

OTHER COUNTRIES

Yamaha Corporation,
International Marketing Division
Nakazawa-cho 10-1, Hamamatsu, Japan 430
Tel: 053-460-2311

ASIA

HONG KONG

Tom Lee Music Co., Ltd.
11/F, Silvercord Tower 1, 30 Canton Road,
Tsimshatui, Kowloon, Hong Kong
Tel: 730-1098

INDONESIA

PT. Yamaha Music Indonesia (Distributor)
PT. Nusantik
Gedung Yamaha Music Center,
Jalan Jend. Gatot Subroto Kav. 4,
Jakarta 12930,
Indonesia
Tel: 21-520-2577

KOREA

Cosmos Corporation
#131-31, Neung-Dong, Sungdong-Ku, Seoul
Korea
Tel: 02-466-0021-5

MALAYSIA

Yamaha Music Malaysia Sdn., Bhd.
16-28, Jalan SS 2/72,
Petaling Jaya,
Selangor,
Malaysia
Tel: 3-717-8977

PHILIPPINES

Yupangco Music Corporation
339 Gil J. Puyat Avenue, P.O.Box 885 MCPO,
Makati, Metro Manila, Philippines
Tel: 819-7551

SINGAPORE

Yamaha Music Asia Pte., Ltd.
80 Tannery Lane, Singapore 1334, Singapore
Tel: 747-4374

TAIWAN

Kung Hsue She Trading Co., Ltd.
No. 322, Section 1, Fu-Hsing
S. Road, Taipei 106, Taiwan, R.O.C.
Tel: 02-709-1266

THAILAND

Siam Music Yamaha Co., Ltd.
865 Phomprapha Building, Rama I Road,
Patumvan, Bangkok 10330,
Thailand
Tel: 2-215-3443

THE PEOPLE'S REPUBLIC OF CHINA AND OTHER ASIAN COUNTRIES

Yamaha Corporation,
International Marketing Division
Nakazawa-cho 10-1, Hamamatsu, Japan 430
Tel: 053-460-2311

OCEANIA

AUSTRALIA

Yamaha Music Australia Pty. Ltd.
17-33 Market Street, South Melbourne, Vic.
3205, Australia
Tel: 3-699-2388

NEW ZEALAND

Music Houses of N.Z. Ltd.
146/148 Captain Springs Road,
Te Papapa, Auckland, New Zealand
Tel: 9-634-0099

COUNTRIES AND TRUST TERRITORIES IN PACIFIC OCEAN

Yamaha Corporation,
International Marketing Division
Nakazawa-cho 10-1, Hamamatsu, Japan 430
Tel: 053-460-2311

HEAD OFFICE: Yamaha Corporation, Electronic Musical Instrument Division
Nakazawa-cho 10-1, Hamamatsu, Japan 430
Tel: 053-460-3273

YAMAHA



[PK] I

VR82780 411BMCE3.3-03B0

M.D.G., EMI Division, © YAMAHA Corporation 1994, Printed in Japan