

SEGA[®]



Dreamcast[™]

USER MANUAL

© 1999 SEGA

Contents

HEALTH AND EPILEPSY WARNING	2	Managing Game Files	14
WARNING	2, 3	Selecting a memory card	14
CAUTION	4	Selecting a file	15
Usage Precautions	4	Initializing a memory card	16
Part Names/Connecting Peripheral Equipment	5	Copying files	18
Connecting To a Telephone Line	8	Deleting files	20
Connecting to a telephone line	8	Listening To Music	22
Telephone wall jack	9	Listening to music CDs	22
Phone cable	9	Changing Various Settings	24
Cable positioning	9	Error Messages	25
Before Using the Dreamcast	10	Troubleshooting	26
Setting the date and time	10	Ratings and Specifications	28
Rechargeable battery	10	Limited Warranty	30
Using the main menu	11	Obtaining Technical Help/Service	30
Screensaver function	11	Repairs After Expiration of Warranty	30
Playing a Game	12	Limitations On Warranty	30
How to start a game	12	User Information	31
Ending a game	13		
Resetting	13		

HEALTH AND EPILEPSY WARNING

Read before using the Dreamcast.

Some people are susceptible to epileptic seizures or loss of consciousness when exposed to certain flashing lights or light patterns that they encounter in everyday life, such as those in certain television images or video games. These seizures or loss of consciousness may occur even if the person has never had an epileptic seizure.

If you or anyone in your family has ever had symptoms related to epilepsy when exposed to flashing lights, consult your doctor prior to using the Dreamcast.

In all cases, parents should monitor the use of video games by their children. If any player experiences dizziness, blurred vision, eye or muscle twitches, loss of consciousness, disorientation, any involuntary movement or convulsion, **IMMEDIATELY DISCONTINUE USE AND CONSULT YOUR DOCTOR.**

To reduce the possibility of such symptoms, follow these safety precautions at all times when using the Dreamcast:

- Sit a minimum of 6.5 feet away from the television screen. This should be as far as the length of the Controller cable.
- Do not play if you are tired or have not had much sleep.
- Make sure that the room in which you are playing has all the lights on and is well lit.
- Stop playing video games at least ten minutes per hour. This will rest your eyes, neck, arms and fingers so that you can continue comfortably playing the game in the future.

WARNING

Failure to comply with all warnings associated with this symbol could result in serious bodily injury or death from electric shock.

- Do not block the fan vent or air holes. Make sure the fan vent, which is located on the right side (as seen from the front), and the air holes, which are located on the back side, are at least 4 inches away from any walls.

Do not set the Dreamcast in locations such as the following:

- Locations where the Dreamcast is in close contact with walls or furniture
- On top of a comforter or a cushion

Do not cover the Dreamcast with a cloth. If the fan vent and air holes are blocked, the Dreamcast could overheat, resulting in fire or electric shock.

Air holes (fan vent) Air holes

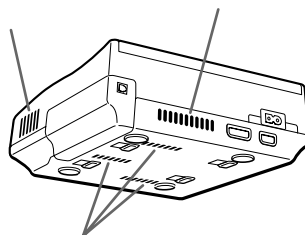

Air holes

WARNING

- **Do not expose the Dreamcast to water, rain or moisture, as this can result in electric shock or fire.**
To reduce the risk of fire or electric shock, do not expose the Dreamcast to rain or moisture.
- **Use the Dreamcast on a flat surface.**
If it is set at an angle when used, the temperature inside the Dreamcast will rise, which could cause a fire or malfunction.
- **Never take the Dreamcast apart or try to modify it.**
Doing so is very dangerous and could result in electric shock.
- **Never look directly at the lens inside the disc door.**
Doing so could impair your vision if the laser beam hits your eyes during the disc-screening process.
- **Do not use a power outlet other than a home-use power outlet.**
Never plug the Dreamcast into a power source other than AC 100 V to 120 V. Using a different source voltage could result in fire or electric shock.
- **Do not insert any objects into the air holes.**
Doing so could result in electric shock or cause a malfunction.
- **Do not plug the power cable into an outlet until you have finished connecting the Dreamcast and peripheral devices together.**
Do not plug the power cable into an outlet until you have finished connecting the other cables to the Dreamcast. Turn off the power switches of any connected television or audio equipment. Leaving these switches on could result in electric shock.
- **Avoid using or placing the Dreamcast in areas which are very humid or dusty.**
Doing so could result in fire, electric shock or malfunction.
- **Do not use the Dreamcast on top of an object that radiates heat.**
Using the Dreamcast on top of an object that radiates heat, such as a VCR, audio equipment, or a television, could cause the Dreamcast to overheat, possibly resulting in a fire or malfunction.
- **Do not use or store the Dreamcast near open flame.**
Do not use or store the Dreamcast near open flame or place lit or flammable items, such as candles, incense, etc., on it.
- **Do not place any containers filled with water or other liquids near the Dreamcast.**
Doing so could result in fire or electric shock if the liquid spills and enters the Dreamcast or gets it wet. If a liquid spills near the Dreamcast, unplug the Dreamcast immediately.
- **Do not remove or insert the power plug with wet hands.**
Doing so could result in electric shock.
- **Do not touch any terminals, connectors or ports with your fingers or allow other metal parts to touch them.**
Doing so could result in electric shock or could cause the Dreamcast to malfunction.
- **Do not use the power cable in any of the following ways. Doing so could result in fire or electric shock.**
 - Modifying or heating the power cable
 - Damaging the power cable
 - Bending or tugging on the power cable unnecessarily
 - Knotting or kinking the power cable
 - Setting heavy objects on the power cable

- **Hold the plug when removing the power cable from the outlet.**
Tugging on the power cable can damage it, possibly resulting in fire or electric shock.
- **When moving the Dreamcast, first unplug the power cable from the outlet. Do not tug the power cable or move the Dreamcast with the power cable plugged into the outlet.**
Doing so could damage the power cable, possibly resulting in fire or electric shock.
- **Only use authorized Dreamcast peripherals.**
Unauthorized peripherals have not been reviewed by Sega and could cause damage to your Dreamcast. Sega is not responsible for damage or injury caused by unauthorized peripherals.

The following marks appear on the underside of the Dreamcast unit.



This symbol (the lightning flash with arrow symbol, within an equilateral triangle) is intended to alert the user to the presence of uninsulated dangerous voltage within the product's enclosure that may be of sufficient magnitude to constitute a risk of electric shock to people.



This symbol (the exclamation point within an equilateral triangle) is intended to alert the user to the presence of important operating and maintenance (servicing) instructions in the literature accompanying the product.



To reduce the risk of electric shock, do not remove the cover.
No parts inside the console can be serviced by the user. If your console needs service, contact Sega's Technical Support at www.sega.com or 1-800-USA-SEGA.

Pour réduire les risques de choc électrique, ne pas retirer le couvercle. Aucune pièce à l'intérieur de la console ne peut être réparée par l'utilisateur. Si la console doit être réparée, contacter le revendeur Sega.

IMPORTANT FOR LASER PRODUCTS

- The Dreamcast is a **Class 1 Laser Product**
The F.D.A. Department of Health and Human Services defines Class 1 Lasers as devices which emit radiation levels "below which biological hazards have not been established."
- Caution - use of controls, adjustments or performance of procedures other than those specified herein may result in hazardous radiation exposure.

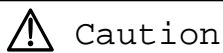

Caution

Failure to comply with all warnings associated with this symbol may result in personal injury or property damage from electric shock or other accidents.

- To prevent electric shock, match wide blade of plug to wide slot, fully insert.

Pour ne pas risquer une électrocution, engagez la fiche en faisant correspondre sa broche la plus large avec la fente la plus large et enfoncez-la à fond.

- Make sure the disc has completely stopped spinning before removing it. Touching the disc while it is spinning could result in injury or scratches on the disc.
- Do not try to play anything other than circular discs. Discs which are not circular will not stop spinning even when the disc door is opened, possibly resulting in injury.
- When you are not using the Dreamcast, be sure to remove the power cable from the power outlet. Leaving the power cable plugged in could result in fire or damage to the Dreamcast due to a lightning strike or power surge.

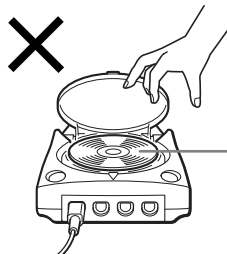

The disc is still spinning.

Usage Precautions Follow the precautions listed below when using the Dreamcast. Failure to follow these precautions could damage your television and the Dreamcast or cause them to malfunction.

Usage Environment

- Avoid using or storing the Dreamcast in areas such as those listed below. Doing so could damage the Dreamcast or cause it to malfunction.
 - Areas exposed to direct sunlight, areas close to heaters, on top of heating vents or other hot areas
 - Extremely cold areas
 - Areas directly exposed to smoke, such as areas close to cooking surfaces
 - Dusty areas
 - Humid areas and areas where water is used, such as bathrooms
 - Surfaces which are slanted or unstable
 - Areas subject to vibration or movement
- Condensation may accumulate on the Dreamcast if it is subjected to sudden changes in temperature. In this case, allow the Dreamcast to adjust to the new temperature (usually one hour) before use.

Handling the Dreamcast

- Do not drop or apply a strong force to the Dreamcast or any other included or connected parts.
- Do not apply unnecessary force to the disc door.
- Do not touch the lens inside the disc door.
- Do not spill liquids around or inside the disc door or drop flammable objects around or inside it.
- Be sure to close the disc door so that dust does not gather on the lens.
- When moving the Dreamcast, be sure to remove the disc first.
- Be careful not to get any of the terminals, connectors or ports dirty.
- Do not insert or remove controllers or peripheral equipment while a game is in progress.
- Only use software and peripheral equipment which are compatible with the Dreamcast and authorized by Sega.

Power cable

- Only use the supplied power cable which is designed specifically for the Dreamcast.
- Do not allow the plug to come into contact with metal or water.

Cleaning

- Follow the instructions listed below when cleaning the Dreamcast.
 - Clean the Dreamcast case using a soft cloth soaked in water or a diluted neutral detergent. Wring out the cloth thoroughly before wiping dirt from the case, then wipe the case dry with a soft cloth.
 - To clean the lens inside the disc door, please contact Sega's Technical Support at www.sega.com or 1-800-USA-SEGA.
 - To wipe dirt off of any of the terminals, connectors or ports, first remove the power cable and other cables, then wipe them with a dry, soft cloth.
 - Never use chemicals such as benzene or paint thinner to clean the Dreamcast.

Discs

Do not use discs other than Dreamcast compatible discs or music CDs. Also, do not use oddly shaped CDs (e.g., heart shaped or star shaped CDs).

Disposal

The Dreamcast and its peripheral equipment are made of metal and plastic, therefore do not burn them. Follow the instructions of your municipality if it is necessary to dispose of the Dreamcast or its peripheral equipment.

FCC Warning

This device complies with Part 15 of FCC Rules. Operation is subject to the following two conditions:

- (1) This device may not cause harmful interference
- (2) This device must accept any interference that may be received, including interference that may cause undesired operation.

Note to Owners of Projection Televisions

Still pictures or images may cause permanent picture-tube damage or mark the phosphor of the cathode-ray tube (CRT). Avoid repeated or extended use of video games on large-screen projection televisions. Consult your television owner's manual before playing video games on your projection television.

Part Names/Connecting Peripheral Equipment

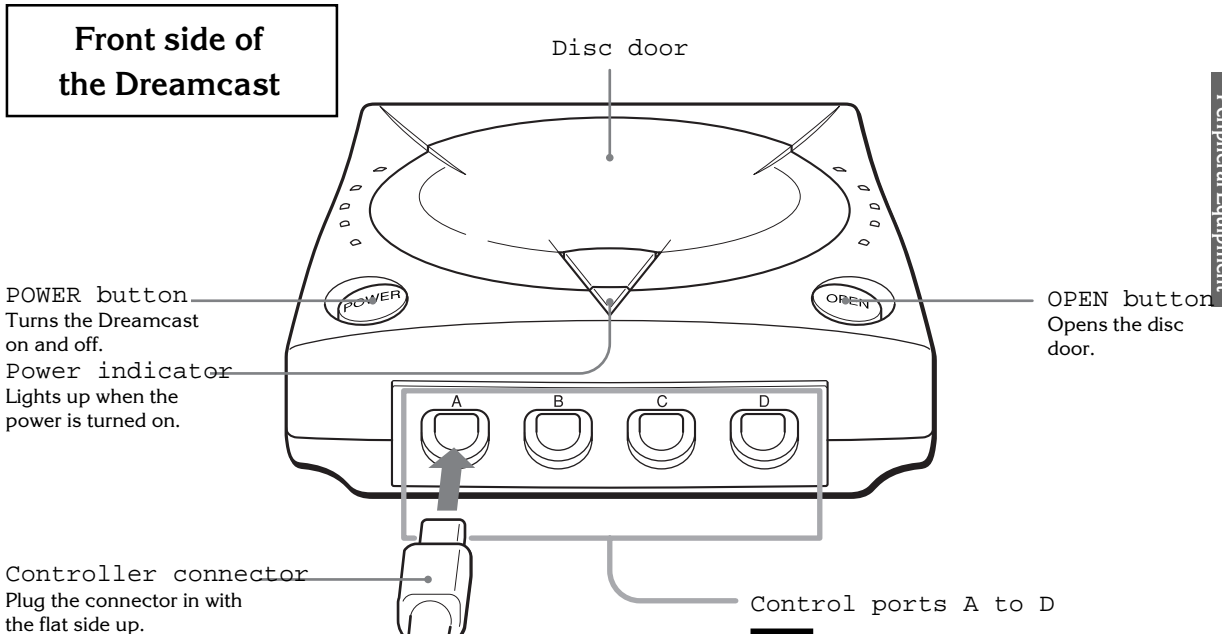

Note

Some software and settings will not work through some ports.

Controller cable

Controller

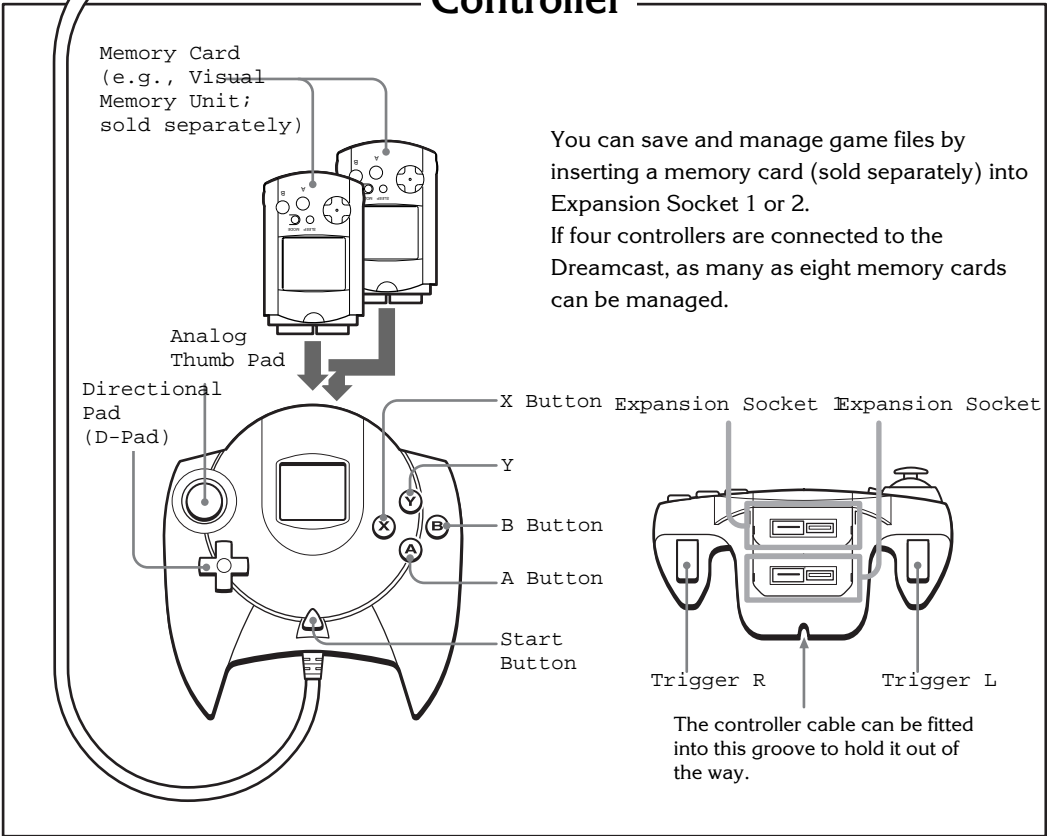

* "Visual Memory Unit" is one type of memory card. When this card is used, "VMU" is sometimes displayed on the screen; this is an abbreviation for "Visual Memory Unit."

Part Names/Connecting Peripheral Equipment

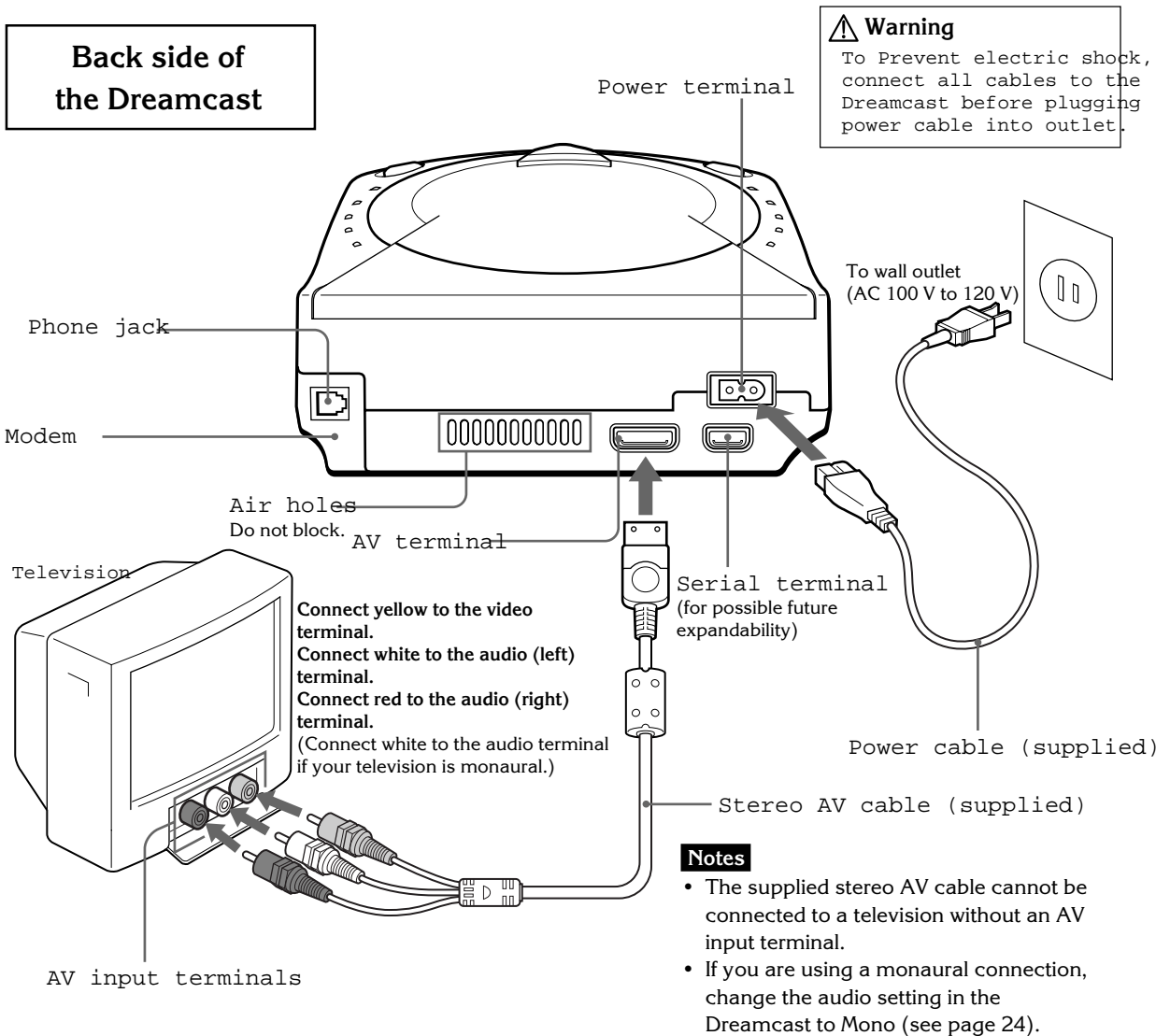

Connecting to a TV or VCR without Audio/Video Input Terminals

Connecting to a TV/Monitor and Antenna

If an antenna cable is plugged into your TV (or if you have cable TV), use a Dreamcast RF unit (sold separately).

- Unplug the antenna cable from the TV, and plug it into the RF unit -ANT IN- terminal.
- Plug the RF unit -TV OUT- cable into the TV.
- Plug the RF unit -A/V IN- cable into the AV terminal on the back of the Dreamcast.

Note

If your television is connected to a VCR, check to see if your VCR has audio/video input terminals to which you can connect the supplied stereo AV cable.

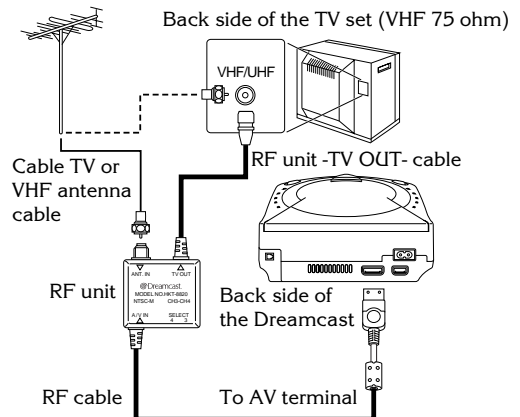

Connecting to a TV that is connected through a VCR

If a VCR is already connected between the antenna and your TV, you may still connect the Dreamcast by using a Dreamcast RF unit (sold separately).

1. Unplug the antenna cable from the TV and plug it into the RF unit -ANT/IN- terminal.
2. Plug the RF unit -TV OUT- cable into the TV.
3. Plug the RF unit -A/V IN- cable into the AV terminal on the back of the Dreamcast.

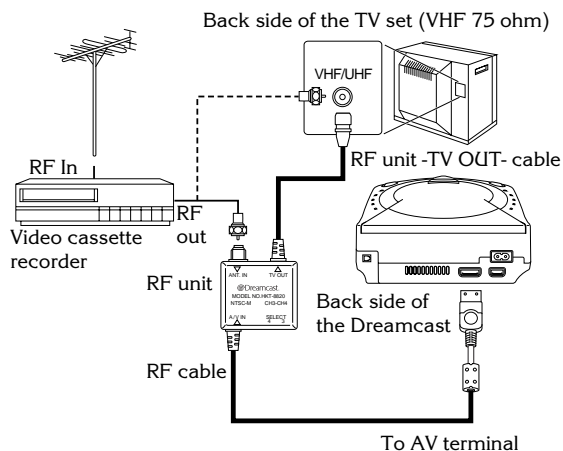

Setting the TV Channel

If you are using an RF unit, see below.

1. Set the channel switch on the RF unit to CH3.
2. Set your TV to channel 3.
3. If channel 3 is used for TV viewing, set your TV to channel 4. Then set the channel switch on the RF unit to CH4.

Note

If your TV has automatic fine-tuning control (AFC), turn it off and manually adjust the picture. However, if you have a color TV that turns black and white when the AFC is turned off, leave the AFC on.

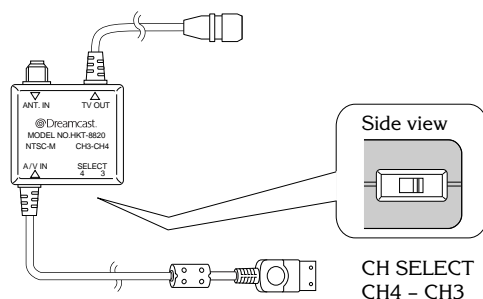

Warning

Where to place the Dreamcast

Place the Dreamcast in locations such as those described below. Failure to place the Dreamcast properly could result in fire or damage the Dreamcast.

- A flat location
- A location where none of the air holes are blocked
- A location which is a good distance from heat sources such as on top of a television, VCR, or close to a heater

Never place the Dreamcast inside a sealed container. Doing so could damage the Dreamcast.

Lens

Do not touch the lens inside the disc door. If the lens gets dirty, it will not be able to properly read discs, leading to malfunctions. Call Sega's Technical Support at www.sega.com or 1-800-USA-SEGA before attempting to clean the lens.

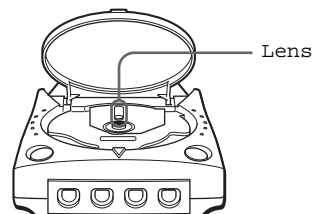

Connecting to a Telephone Line

Use the Dreamcast with an online software program to game with people all around the world and have fun on the Internet. Not all Dreamcast software supports online gameplay.

Please refer to the operating manual included with the software for information about online gaming options. It is not necessary to connect the Dreamcast to a telephone line when you are using it to play games offline (i.e., not connected to an online gaming service).

Connecting to a telephone line

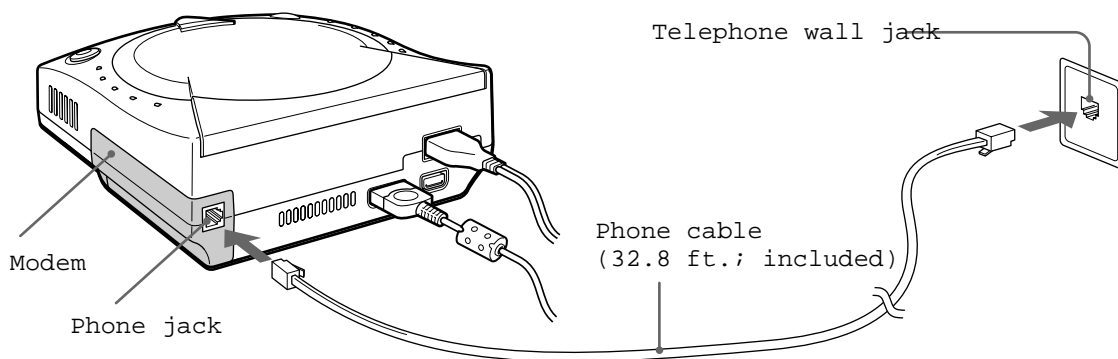

1 Make sure the Dreamcast power is off.

2 Connect one end of the included phone cable to the phone jack on the Dreamcast modem.

It does not matter which end of the phone cable is plugged into the Dreamcast or the wall. You may need to unplug your telephone from the wall jack before you can connect the phone cable from the Dreamcast.

3 Connect the other end of the phone cable to a telephone wall jack.

After Your Online Session

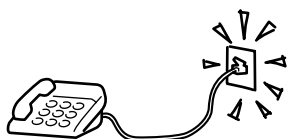

After you finish using the online software, reconnect your telephone to the telephone wall jack.

You will not be able to use your telephone if the telephone line is left connected to the Dreamcast.

Telephone wall jack

Make sure your telephone wall jack is a modular jack. If it is not a modular jack, you will need a modular conversion plug so that a modular plug can be connected to it. Contact your local telephone service provider for further information.

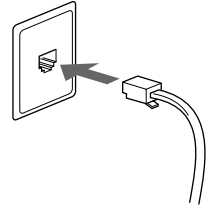

Modular plugs may vary from one area to another. Make sure to use the correct modular conversion plug for the modular jacks in your area.

Phone cable

- Do not touch the plugs on the ends of the phone cable.
- If the phone cable is not long enough, use a longer phone extension cable (sold separately).
- Do not use an overly long phone cable. The longer the phone cable you use, the weaker the phone signal becomes. If the modem does not seem to work correctly or you get frequently disconnected, please try a shorter phone cable before contacting Sega's Technical Support at www.sega.com or 1-800-USA-SEGA.
- Do not bend, knot or kink the phone cable. Take care when positioning the phone cable to ensure that it will not trip someone or become snagged in some way.

Cable positioning

- Position the phone cable as far away as possible from electrical devices such as computer displays, televisions and speakers. Communication errors may occur if it is too close to such devices.

Notes

If you have Call Waiting Service

- Please note that if you have Call Waiting service and someone calls you while the Dreamcast is online, your connection may be disconnected or the game may function abnormally and disconnect.
- If you want to ensure that the Dreamcast is not interrupted by incoming calls when you go online, we recommend disabling your Call Waiting service or adding a separate phone line dedicated to online use. Contact your local telephone service provider for further information.

Modems and Telephones

- **You cannot go online with the Dreamcast while you are using your telephone. (However, you can play games offline.)**
- **You cannot use your telephone while the Dreamcast is online.**

Connection Types that Cannot be Used for Online Gaming

- You cannot go online with any connection other than a telephone line for home use.
- You cannot go online using a modular jack connected to an extension phone. (Companies and government offices often use private branch exchanges (PBXs). An *extension phone* is a phone which is connected to a PBX and which requires you to dial 0 or some other number in order to place an outside call.)
- You need an analog connection. The Dreamcast will not function with a digital connection.

Before Using the Dreamcast

Setting the date and time

A screen for setting the date and time is displayed the first time you turn on the Dreamcast or when you turn it on after leaving it off for an extended period of time. The information will initially be displayed in English. You can select from 6 different languages (see page 24).

Regardless of the status of the date and time, or the rechargeable battery, the Dreamcast will retain your language selection.

1 Press the POWER button to turn on the power.

The date/time setting screen will be displayed automatically after the Dreamcast intro screen.

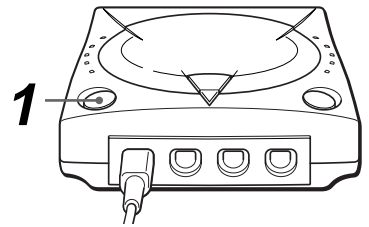

2 Set the date and time.

Move the Directional Pad (or the Analog Thumb Pad) to the left or right to switch between date and time, and move it up or down to adjust the setting. The date format is as follows: month (mm)/day (dd)/year (yy)

Move left or right to change between fields.
Move up or down to increase or decrease the numerical setting.

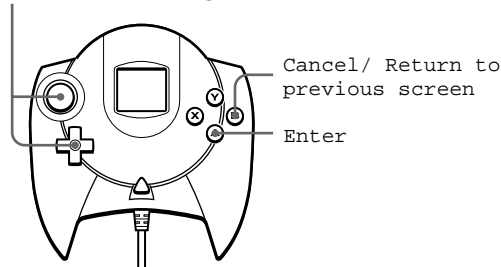

3 After setting the date and time, choose "Select" and press the A Button (Enter).

Notes

- The Dreamcast may not function correctly if the correct time is not set.
- Do not touch the Analog Thumb Pad, Trigger L, or Trigger R on the controller while turning on the power. Doing so could cause the Dreamcast to malfunction since the controller will not be properly initialized.

Rechargeable battery

The Dreamcast contains a rechargeable battery for saving information such as date and time settings.

It is recommended that you charge the Dreamcast for about two hours the first time you use it. The date and time settings can be maintained for about 20 days after the rechargeable battery has been charged for two hours.

Charging the rechargeable battery

- The rechargeable battery is charged when the Dreamcast is connected to a power source and turned on. Charging works properly even when you are playing games.
- If the battery is not retaining a charge, please contact Sega's Technical Support at www.sega.com or 1-800-USA-SEGA.

Using the main menu

The Play, File management, Music and Setting screens can be accessed from the main menu. It is not necessary to use the main menu for normal games or to play music CDs. When a disc is placed in the Dreamcast and the power is turned on, the game screen or music screen will be displayed automatically if auto start is set "ON" (see page 24).

- 1 Use the Directional Pad (or Analog Thumb Pad) to highlight an icon.**
- 2 Press the A Button to select the highlighted icon.**

Icon selection

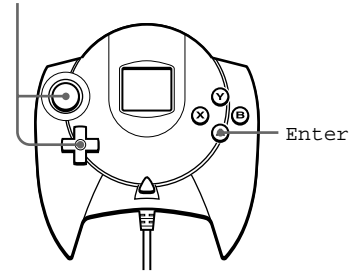

Before Using
the Dreamcast.

* Various settings can be changed by selecting the Settings icon (see page 24). The screen shots in this manual show the screens which appear when English is set as the display language.

Main menu

To display this screen, turn on the power without inserting a disc.

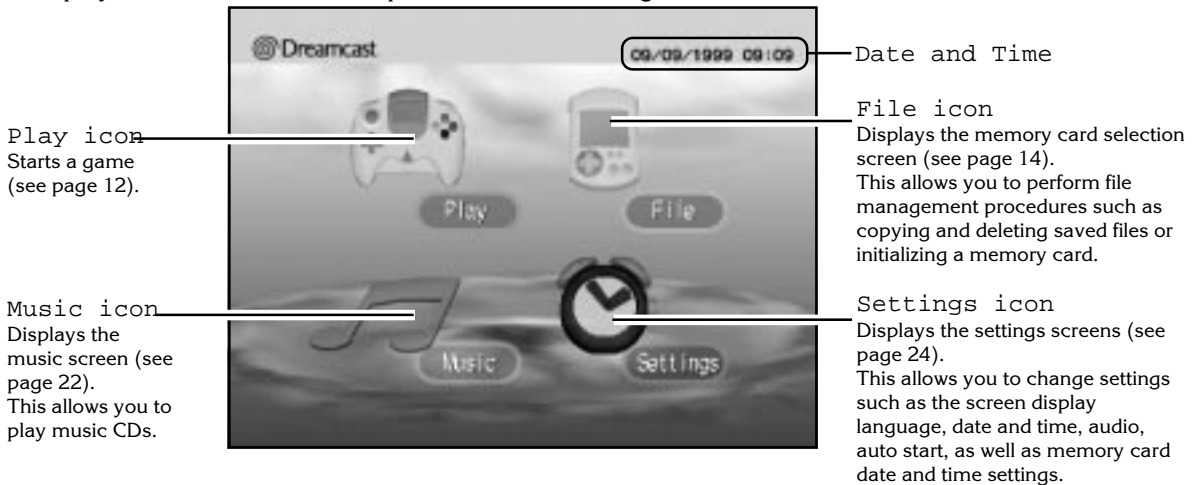

Screensaver function

If the Dreamcast is inactive for a set length of time, the screen brightness will automatically be reduced and a screensaver will start in order to prevent a ghost image from being burned onto the television screen.

- If the Dreamcast is inactive for approximately 10 minutes:
Screen brightness is reduced to approximately 50%.
- If the Dreamcast is inactive for approximately 20 minutes:
Screen brightness is reduced to approximately 20% and a screensaver starts.

The original screen is restored after any button or key is pressed.

Please note that while the screensaver function may help prevent possible screen damage to your television, there are many different makes and models with each having its own features and functions. Although we do not believe you will encounter any problems, Sega is not responsible for any damage to your television set. If you will be taking a break and desire to leave the Dreamcast on (unattended) for more than 60 minutes, we recommend that you turn off your television set.

Playing a Game

How to start a game

1 First turn on the television power, then change the television input mode to Video Input Mode.

See your television's operating manual for information on how to change to Video Input Mode (may also be called auxiliary input). If you are connecting your Dreamcast via RF adapter, see the RF adapter manual for directions.

2 Press the OPEN button to open the disc door.

3 Press the game disc down (label side up) as shown, until it clicks in place.

4 Manually press the disc door shut until it locks in place.

5 Press the POWER button to turn on the power.

The game will start automatically after the Dreamcast logo screen is displayed.

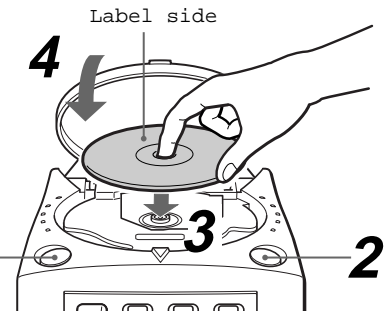

Notes

- Do not touch the Analog Thumb Pad, Trigger L, or Trigger R on the controller while turning on the power. Doing so could cause the Dreamcast to malfunction since the controller will not be properly initialized.
- Some games require a memory card for saving data (sold separately). See page 16 for information on how to initialize a memory card if initialization is necessary.

To display the game screen from the main menu (see page 11)
Select the Play icon and press the A Button.

Main Unit Memory

The Dreamcast contains a Main Unit Memory. The main unit memory contains: 1. Main Unit ID (identification number) which is set when the Dreamcast was manufactured and 2. Play History.

Ending a game

1 Press the OPEN button to open the disc door.

Make sure the disc has stopped spinning completely.

2 Remove the disc.

Put your index finger or middle finger in the center hole of the disc, then gently lift up the edge of the disc with your thumb.

3 Close the disc door and press the POWER button to turn off the power.

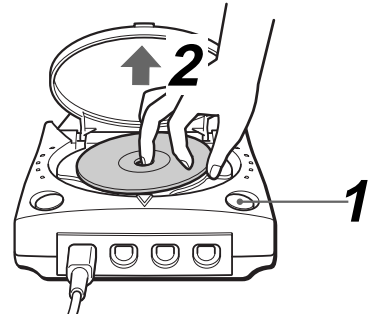

Changing discs

To change discs and continue playing games, shut the disc door without turning off the power after exchanging discs. Certain games may encompass more than one disc. Follow directions in the game to exchange discs during gameplay.

⚠ Caution

- Opening the disc door after the Dreamcast power is turned off is extremely dangerous, since the disc will continue spinning at high speed without the brake to slow it down.
- Be sure to follow the proper procedure when removing a disc.
- Do not press down forcefully on the disc drive hub. Doing so could result in injury or damage the Dreamcast.

Disc drive hub

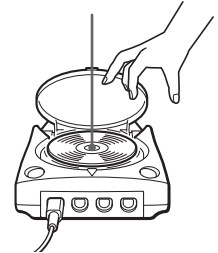

Resetting

If the A Button, B Button, X Button, Y Button and Start Button are all pressed at the same time, the game in progress will be stopped and the game title screen or the main menu will be displayed. The game data of the game in progress will NOT be saved.

If you are using a Sega authorized controller which does not have these buttons, see the operating manual which came with your software or peripheral equipment.

If a game is in progress

The game will stop and the game title screen will be displayed.

If the game title screen is displayed

The main menu (see page 11) will be displayed.

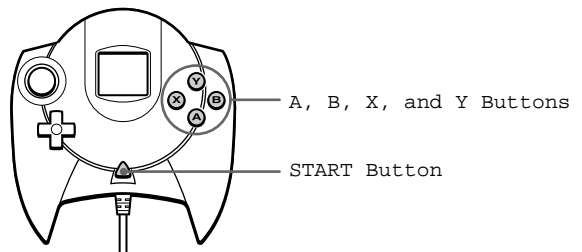

Note

You cannot reset the Dreamcast while game data is being saved or while the disc is being accessed.

Managing Game Files

You can save and manage game files (e.g., file copying or deleting) by inserting a Sega authorized memory card (sold separately) into Expansion Socket 1 or 2 on the controller.

Notes

- The first time you use a memory card (e.g., Visual Memory Unit; sold separately) after purchasing it, you will need to initialize the card. See “Initializing a memory card” (see page 16).
- Before connecting the Visual Memory Unit card to the controller, change the Visual Memory Unit to Clock or File mode. The memory card may malfunction in other modes. See the Visual Memory Unit operating manual for further details.
- Use only Sega authorized memory cards.

Selecting a memory card

Select the memory card you want to display on the screen from among the memory cards connected to the controller.

1 Insert the memory card.

2 Select the File icon from the main menu (see page 11), then press the A Button (Enter).

The memory card selection screen will be displayed.

3 Select the icon corresponding to the memory card whose file menu you want to display, then press the A Button (Enter).

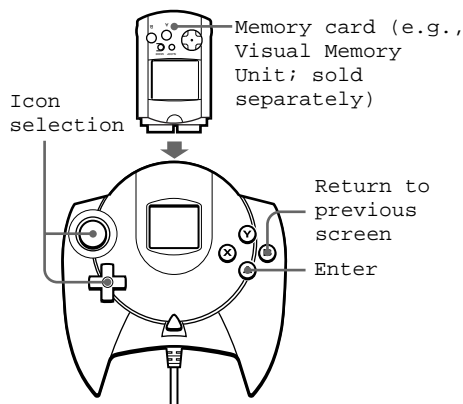

Memory card selection screen

Percentage of memory used

Number of free blocks

Controller

The display shows which of the control ports (A, B, C, or D) a controller is connected to.

BACK icon

When this is selected and the A Button is pressed, the previous screen (main menu) is displayed again.

Socket 2

Socket 1

Memory Card icon

The memory cards connected to Expansion Socket 1 or 2 on each controller are displayed.

When a memory card is selected and the A button (Enter) is pressed, the file menu screen (see page 15) is displayed, and files stored on the memory card can be accessed. If the hourglass icon is displayed, the Dreamcast is trying to read the contents of the memory card.

Selecting a file

Select files on the memory card for copying, deleting, etc.

- 1 On the memory card selection screen (see page 14), select a Memory Card icon and press the A Button (Enter).**

The file menu screen will be displayed.

- 2 Select the icon corresponding to the file to be copied, deleted, etc., then press the A Button (Enter).**

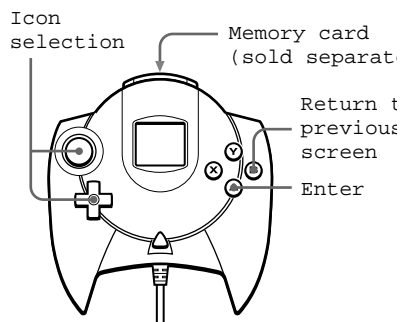

File menu screen

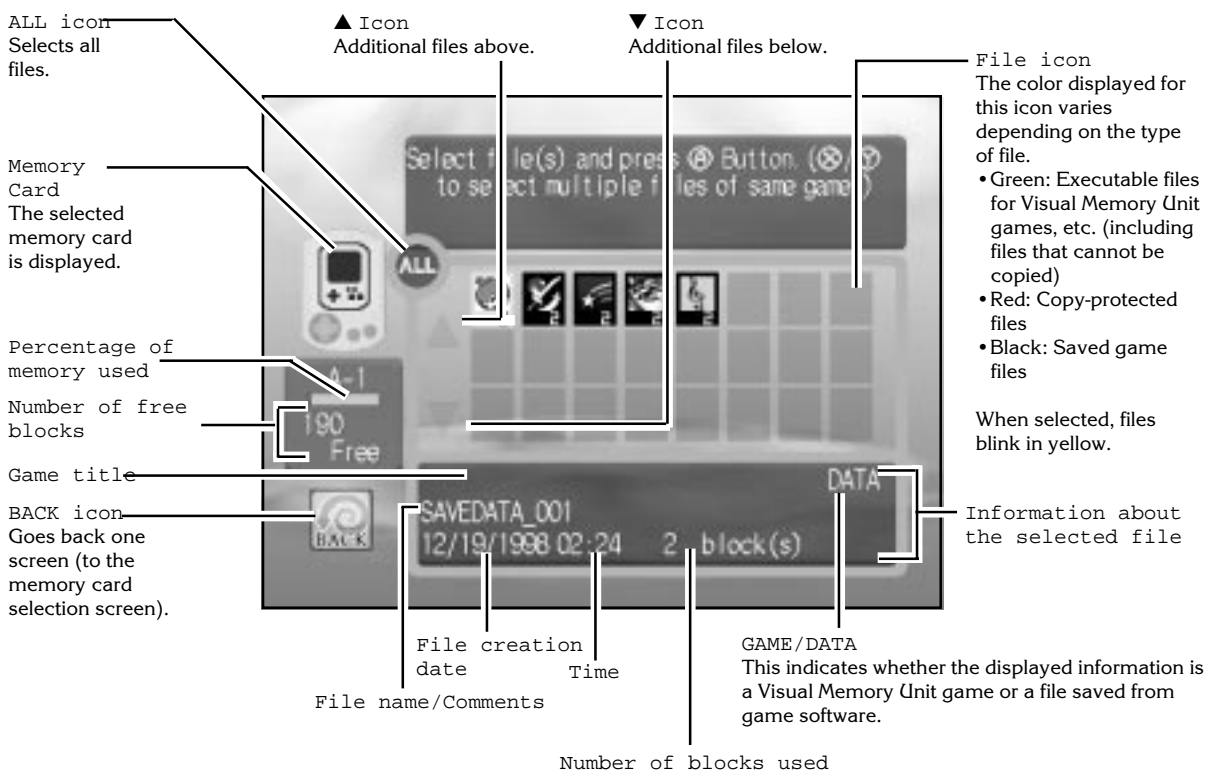

Note

The memory card selection screen will be displayed again if the memory card is removed while the file menu is displayed.

Visual Memory Unit game (VMU game)

A Visual Memory Unit game (VMU game) is a mini-game played on the Visual Memory Unit. The Visual Memory Unit has the ability to accept downloaded mini-games from certain software for stand-alone play. See the operation manual for your software to see if this feature is available.

Managing Game Files

Initializing a memory card

Initialization is the process of erasing all files using the ALL icon.

Initialization is necessary **the first time you use a memory card after purchase** or when you can no longer use a memory card for some reason. There are also some settings that can only be changed at initialization time: icon and color. These two settings can be used to help differentiate one memory card from another.

- 1 Select the ALL icon on the file menu screen and press the A Button (Enter).**

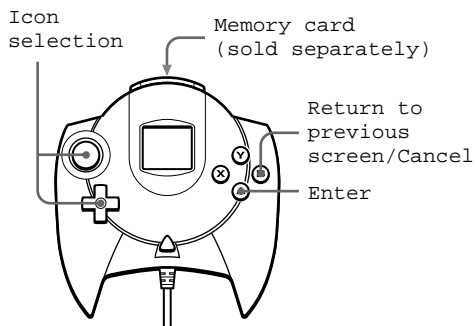

- 2 Select “Delete All (Memory Reset)” and press the A Button (Enter).**



- 3 Confirm that you want to delete all files by selecting “Yes” and pressing the A Button (Enter).**



- 4 Select an icon and press the A Button (Enter).**

Please review the icons displayed on the screen. Using the Directional Pad or the Analog Thumb Pad highlight the icon you like and press the A Button (Enter) to choose it. Choose “Select” to continue to the next display.



5 Select a color and press the A Button (Enter).

Please review the colors displayed on the screen. Using the Directional Pad or the Analog Thumb Pad highlight the color you like and press the A Button (Enter) to choose it. Choose “Select” to continue to the next display.



6 Confirm your choice of color and icon. Select “Yes” and press the A Button (Enter).

The memory card will be initialized. A completion message is displayed.

Press the A Button to go back to the file menu screen.



Notes

- To avoid any possible damage during the initialization process
 - Do not remove the controller connector from the Dreamcast.
 - Do not remove or connect peripheral equipment (e.g., memory cards) from the controller.
 - Do not power off or unplug the Dreamcast.
- The initialization process erases all of the files in a memory card. Be sure to thoroughly check the contents of the memory card before initializing it.
- If desired, copy selected files to another memory card before starting the initialization process. See page 18.

Managing Game Files

Copying files

You can copy files from a selected memory card to another memory card.

1 On the file menu screen, select the file to be copied and press the A Button (Enter).

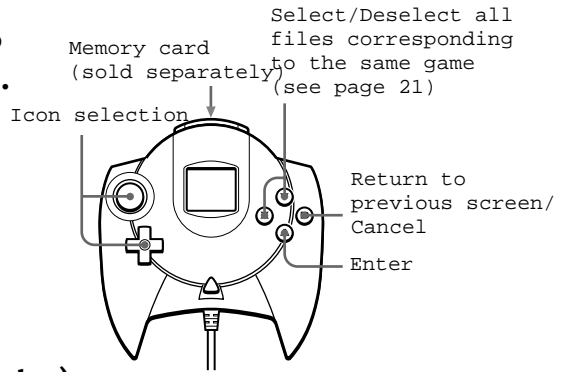

2 Select “Copy” and press the A Button (Enter).



3 Select the destination memory card and press the A Button (Enter).



4 Select “Start Copying” and press the A Button (Enter).

At this point, you may also select “View Contents” and press the A Button (Enter) to view the file information on a possible destination memory card.

Select “Cancel” and press the A or B Button to return to the previous screen.



A completion message is displayed.
Press the A Button to return to the file menu screen.

Notes

- To avoid any possible damage during the copying process
 - Do not remove the controller connector from the Dreamcast.
 - Do not remove or connect peripheral equipment (e.g., memory cards) from the controller.
 - Do not power off or unplug the Dreamcast.
- Copying is not possible in the following cases.
 - When the file is a copy-protected file.
 - When the file is a Visual Memory Unit game (VMU game) file which is copy-protected.
 - When there is not sufficient free space on the destination memory card.
 - A Visual Memory Unit game (VMU game) file cannot be copied to a destination memory card if there is already a Visual Memory Unit game (VMU game) file on the destination memory card.

Managing Game Files

Deleting files

You can delete selected files from a selected memory card.

- 1 On the file menu screen, select the file to be deleted and press the A Button (Enter).**

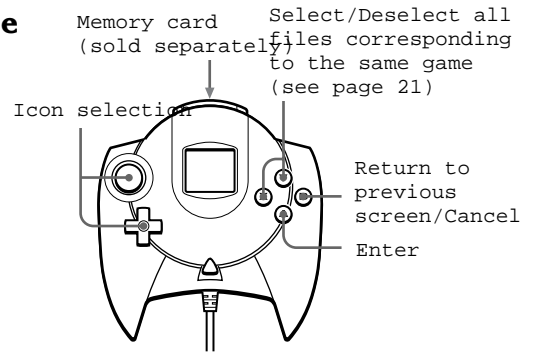

- 2 Select “Delete” and press the A Button (Enter).**



- 3 After confirming the file, select “Yes” and press the A Button (Enter).**

A completion message is displayed.
Press the A Button to return to the file menu screen.

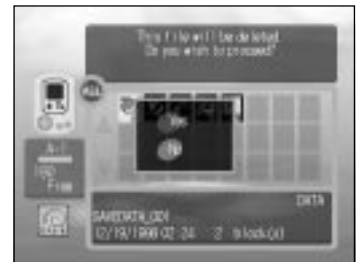

Notes

- Once deleted, a file cannot be retrieved.
- To avoid any possible damage during the deletion process
 - Do not remove the controller connector from the Dreamcast.
 - Do not remove or connect peripheral equipment (e.g., memory cards) from the controller.

Selecting a group of files

Selecting a group of files corresponding to the same game title

If you press the X or Y Button on the Controller, instead of the A Button, you can select all files corresponding to the same game title as the highlighted file. Note, however, that you cannot select executable files such as Visual Memory Unit game (VMU game) files.

Press the X or Y Button once more to cancel the selection.

Selecting all files

You can select all files in a memory card by selecting the ALL icon.

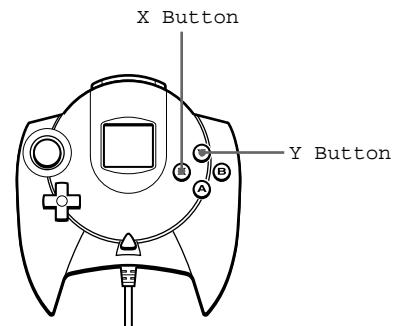

Listening to Music

Listening to music CDs

First turn on the television power, then change the television input mode to Video Input Mode. See your television's operating manual for information on how to change to Video Input Mode.

- 1 Press the OPEN button to open the disc door.**
- 2 Press the music CD down as shown until it clicks in place.**
- 3 Manually press the disc door shut.**
- 4 Press the POWER button to turn on the power.**
The music CD playing screen will be displayed automatically after the Dreamcast logo screen is displayed.

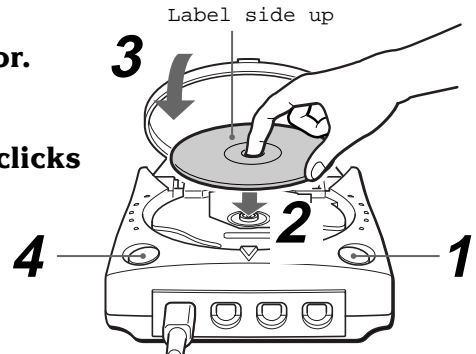

To display the music screen from the main menu (see page 11)
Select the Music icon and press the A Button.

⚠ Caution

- Do not touch the disc while it is spinning. Doing so could result in personal injury or damage to the disc or the Dreamcast.

Note

Do not touch the Analog Thumb Pad, Trigger L, or Trigger R on the controller while turning on the power. Doing so could cause the Dreamcast to malfunction since the controller will not be initialized properly.

Music screen

Icon selection

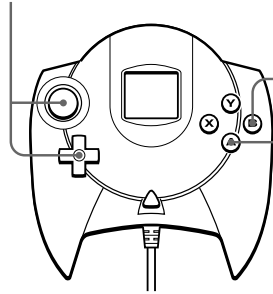

Return to previous screen

Enter

Number of tracks

The total number of tracks or the current track number is displayed.

Playing time

Displays the total playing time for all tracks or the playing time for the current track.

Repeat display

 : Repeat current track

 : Repeat all tracks

BACK icon

Returns to the previous screen (main menu).

Previous track

Goes back to the previous track. If a CD is playing, this button will go back to the beginning of the current track.

Stop

Stops playing.

Next track

Goes to the next track.

Play/Pause

Starts playing or pauses the track if the CD is playing.

Repeat (repeat play)

Repeats the current track or all tracks. The player cycles between the repeat modes each time this button is pressed as follows:

Repeat one track → Repeat all tracks → Clear



Changing Various Settings

1 On the main menu (see page 11), select the **Settings icon and press the A Button (Enter)**.

The settings screen will be displayed.

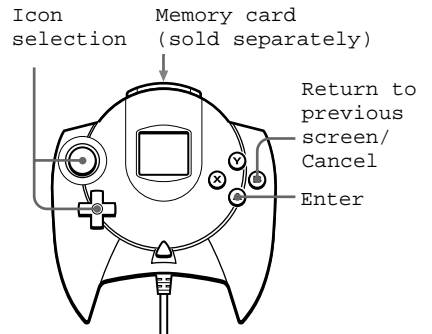

2 Select the parameter you want to change and press the A Button (Enter).

The screen for setting the selected parameter will be displayed.

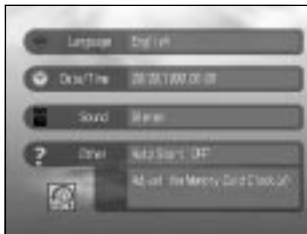

Language



Select the desired display language from the following: Japanese, English, Deutsch, Français, Español, Italiano.

Other

Setting auto start



Date/Time

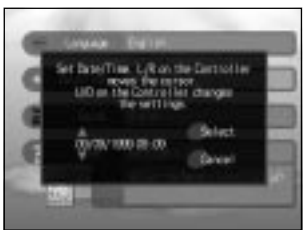

Change the Dreamcast date and time. The controller actions are the same as those described in Setting the Date and Time (see page 10).

Auto Start 'ON'

With this setting, the game screen is displayed automatically when a Dreamcast-only disc such as a game disc is inserted in Dreamcast.

Auto Start 'OFF'

With this setting, it is necessary to select the Play icon or Music icon on the main menu after inserting a disc by pressing the A Button.

Sound



Set the audio to Stereo or Monaural. Mono should be selected if the Dreamcast is connected to a monaural device (see page 6).

Synchronize the memory card clocks with the Dreamcast.

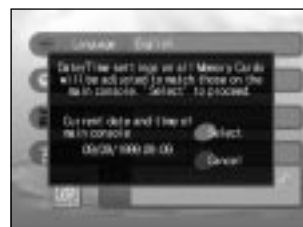

Synchronize the time between the Dreamcast and all connected memory cards.

Error Messages

File management

Error message	Meaning of message and what to do
No memory card found.	<ul style="list-style-type: none">• A memory card is not connected to the controller. Insert a memory card into a controller expansion socket.• A controller is not connected to the Dreamcast. Connect a controller properly to the Dreamcast.• You may be using an unauthorized memory card.
The destination Memory Card is full. Unable to copy.	<ul style="list-style-type: none">• Delete some files from the destination memory card to free up space and try copying again. Alternatively, replace the current destination memory card with one that has sufficient free space.
The destination Memory Card is not ready. Unable to copy.	<ul style="list-style-type: none">• The destination memory card is no longer usable for some reason. Initialize the memory card and try copying again (initializing the memory card will erase all of the files on it).
The memory card cannot be used until all files have been deleted.	<ul style="list-style-type: none">• The destination memory card cannot be used for some reason. Initialize the memory card and try copying again (initializing the memory card will erase all of the files on it).
The command was not completed due to a memory card being removed/inserted. Check card(s) and try again.	<ul style="list-style-type: none">• The memory card currently under command was removed, a memory card was inserted into the same Controller as the memory card currently under command or the Controller for the memory card currently under command was disconnected from the Dreamcast.
This file cannot be copied.	<ul style="list-style-type: none">• The file is copy-protected; it cannot be copied.
This game does not support the AV cable currently connected to the main console. Turn off the power and replace the cable.	<ul style="list-style-type: none">• The type of AV cable currently connected to the Dreamcast is not supported by the software. Please remove the AV cable currently connected and replace it with a type supported by the software.

Game Playing

Error message	Meaning of message and what to do
Please insert game disc.	<ul style="list-style-type: none">• This message is displayed if the Play icon is selected when a game disc is not inserted in the Dreamcast. Insert a game disc in the proper orientation.

If a message different from those presented above is displayed, contact Sega's Technical Support at www.sega.com or 1-800-USA-SEGA.

Troubleshooting

Your Dreamcast may not require repair service in cases such as those described below. Before contacting Sega's Technical Support, please go over the checks below.

Dreamcast

Problem	What to check	What to do	Reference page
The Dreamcast is so hot you cannot touch it.	<ul style="list-style-type: none"> • Are the air holes blocked? • Is the Dreamcast set at an angle? • Is it set close to anything that radiates heat? • Is air blowing out of the fan vent? 	<ul style="list-style-type: none"> • Set the Dreamcast in an approved location, then turn off the power and unplug the power cable from the outlet. Next, leave the Dreamcast idle until it cools down. If no air is coming out of the fan vent, do not use the Dreamcast. Contact Sega's Technical Support at www.sega.com or 1-800-USA-SEGA. 	p.2, 3

Power supply

Problem	What to check	What to do	Reference page
The date and time setting screen is displayed each time the power is turned on.	<ul style="list-style-type: none"> • Is this the first time you have used the Dreamcast since purchasing it, or the first time after an extended period of not using it? 	<ul style="list-style-type: none"> • The rechargeable battery has lost its charge. Connect the Dreamcast to an outlet and turn on the power. Charge the rechargeable battery for at least two hours. * If the date and time setting screen is still displayed after the rechargeable battery has been charged, contact Sega's Technical Support at www.sega.com or 1-800-USA-SEGA 	p.10
The Dreamcast does not turn on when the POWER button is pressed.	<ul style="list-style-type: none"> • Is the power cable properly connected? • Are you using a Sega authorized power cable? 	<ul style="list-style-type: none"> • Securely plug the power cable into the Dreamcast and the outlet. • Only use a Sega authorized power cable. 	p.6 —

Operation

Problem	What to check	What to do	Reference page
The game does not start when a disc is inserted.	<ul style="list-style-type: none"> • Is the disc properly seated? • Are there any fingerprints or dirt on the disc? • Is the lens inside the disc door dirty? • Is the type of disc suitable for your Dreamcast? • Is auto start set to OFF? • Does the same problem occur with other Dreamcast discs? • Is the disc scratched? 	<ul style="list-style-type: none"> • Securely seat the disc in place with the label side up. • Clean the underside of the disc with a store-bought CD cleaner or similar cleaner. • Contact Sega's Technical Support at www.sega.com or 1-800-USA-SEGA. • Use Dreamcast-only software discs that bear the NTSC-U mark. • Set auto start to ON. • Contact Sega's Technical Support at www.sega.com or 1-800-USA-SEGA. • Contact Sega's Technical Support at www.sega.com or 1-800-USA-SEGA. 	p.12 — p.7 — p.24 — —
The controller does not work.	<ul style="list-style-type: none"> • Is the controller properly connected to a control port on the Dreamcast? • If peripheral equipment is connected to a controller expansion socket on the controller, is it properly connected? • Are you touching the Analog Thumb Pad, Trigger L or Trigger R on the controller when you turn the power on? • Is the peripheral Sega authorized? 	<ul style="list-style-type: none"> • Properly connect the controller to a control port before turning on the power. • Properly connect the peripheral equipment after reading the operating manual for the peripheral equipment. • Turn off the power, then turn it back on without touching the Analog Thumb Pad, Trigger L or Trigger R. • Only use Sega authorized Dreamcast peripherals. 	p.5 p.5 p.10 (Note) —

Video and audio

Problem	What to check	What to do	Reference page
There is absolutely no video.	<ul style="list-style-type: none"> • Is the power cable properly connected? • Are the Dreamcast and the television on? • Are the Dreamcast and the television properly connected through the AV cable? • Is the television input (Television/ Video switch) set to Video? • Is there more than one AV input terminal on the television? • Are the power cable and/or video cable Sega authorized? 	<ul style="list-style-type: none"> • Securely plug the power cable into the Dreamcast and the outlet. • Turn on the Dreamcast and the television. • Securely plug the AV cable into the Dreamcast and the correct terminal on the television. • Set the television input to the correct setting. If there is more than one video input terminal on the television, read your television's operating manual for proper setting. • Refer to your television's operating manual to ensure you have made the proper settings. If necessary, try a different AV input terminal. • Only use Sega authorized cables. 	<p>p.6</p> <p>—</p> <p>p.6</p> <p>—</p> <p>p.6</p> <p>—</p>
There is no audio.	<ul style="list-style-type: none"> • Is the power cable properly connected? • Are the Dreamcast and the television on? • Are the Dreamcast and the television properly connected through the AV cable? • Is the television input (Television/ Video switch) set to Video? • Is the television volume set to a low level or mute? 	<ul style="list-style-type: none"> • Securely plug the power cable into Dreamcast and the outlet. • Turn on the Dreamcast and the television. • Securely plug the AV cable into the Dreamcast and the correct terminal on the television. • Set the television input to the correct setting. If there is more than one video input terminal on the television, read your television's operating manual for the proper setting. • Adjust the volume. 	<p>p.6</p> <p>—</p> <p>p.6</p> <p>—</p> <p>—</p>
Video and audio output are cut off while a game is in progress.	<ul style="list-style-type: none"> • Are there any scratches, fingerprints, or dirt on the disc? • Is the power cable properly connected? • Are the Dreamcast and the television properly connected through the AV cable? 	<ul style="list-style-type: none"> • Clean the underside of the disc with a store-bought CD cleaner or similar cleaner. • Securely plug the power cable into the Dreamcast and the outlet. • Securely plug the AV cable into the Dreamcast and the correct terminal on the television. 	<p>—</p> <p>p.6</p> <p>p.6</p>

If you experience other problems, unplug the power cable from the outlet and contact Sega's Technical Support at www.sega.com or 1-800-USA-SEGA for further information.

Ratings and Specifications

Model	HKT-3020 (main unit)
Used power supply	AC100 V to 120 V, 50/60 Hz
Wattage	Approximately 27 W
Usage environment	Temperature: 41 to 95°F Humidity: 20 to 90% RH (no condensation)
External dimensions	Approximately 7 1/2 x 7 3/4 x 3 inches (W x D x H)
Weight	Approximately 3 pounds

Sega of America, Inc.

P.O.Box 7639 San Francisco, CA 94120-7639

1-800-USA-SEGA & www.sega.com

- Please note that specifications and product exterior may change without notice.
- Unauthorized reproduction of the contents of this document is prohibited.
- SEGA, Dreamcast, the Dreamcast logo and Visual Memory are either registered trademarks or trademarks of Sega Enterprises, Ltd.
- Microsoft, Windows, and the WindowsCE logo are registered trademarks or trademarks of Microsoft Corporation in the US and other countries.
- Incorporated software uses fonts based on the fonts of Fontworks International Limited and have been customized for Dreamcast. The Fontworks company name and font names are trademarks or registered trademarks of Fontworks International Limited.

Export, use for profit, rental or leasing of this product is prohibited.

Further, Sega offers no warranty service or support outside of the US and Canada.

Product covered under one or more of the following U.S. Patent Nos: 5,460,374; 5,525,770; 5,627,895; 5,688,173; 4,442,486; 4,454,594; 4,462,076; and Re. 35,839; and Japanese Patent No. 2,870,538 (Patents pending in U.S. and other countries); Canada Patent No. 1,183,276.

*** THIS, LIMITED, WARRANTY IS VALID FOR U.S. AND CANADIAN SEGA DREAMCAST SYSTEMS MANUFACTURED FOR SALE IN AND PURCHASED AND OPERATED IN THE UNITED STATES AND CANADA, ONLY!**

Limited Warranty

Sega of America, Inc. warrants to the original consumer purchaser that the Sega Dreamcast System and all component parts shall be free from defects in material workmanship for a period of 90 days from the date of purchase. If a defect covered by this limited warranty occurs during this 90-day warranty period, Sega will repair or replace the defective system or component part, at its option, free of charge. This limited warranty does not apply if the Sega Dreamcast is used with products not distributed or licensed by Sega, or if the defects have been caused by negligence, accident, unreasonable use, modification, tampering or any other causes not related to defective materials or workmanship. Additionally, this warranty shall not be valid if the serial number of the Sega Dreamcast System unit has been altered, defaced or removed in any way. Please retain the original or a photocopy of your dated sales receipt to easily establish the date of purchase for in-warranty repairs.

Obtaining Technical Help/Service

To receive trouble shooting assistance, please contact Sega at:

- web site <http://www.sega.com>
- email address support@sega.com
- 800 number 1-800-USA-SEGA

If a representative is unable to solve your problem, you will be given instructions for obtaining exchange/repair service. The following options are available:

Rapid Exchange Program: You will be directed to the nearest Sega authorized service center. Upon receipt of your unit and verification of proof of purchase, the authorized service center will notify Sega to ship a “remanufactured” replacement (in like new condition) directly to you.

Repair Service: If you prefer to have your original unit repaired, you will need to return the defective merchandise, freight prepaid and insured against loss or damage, to Sega’s main service center. Sega reserves the right to replace items if repairs are not feasible.

To receive warranty service in the U.S. and Canada, contact Sega’s Service Department at: www.sega.com or 1-800-872-SEGA. PLEASE CALL FIRST FOR REPAIR INFORMATION.

The cost of returning the system to Sega’s Service Center shall be paid for by the purchaser.

Repairs After Expiration of Warranty

If your Sega Dreamcast System requires repairs after the termination of the 90-day limited warranty period, you may contact Sega at the web site, email address, or 800 number listed on this page for instructions on receiving technical support and repair service.

Limitations On Warranty

Any applicable implied warranties, including warranties of merchantability and fitness for a particular purpose, are hereby limited to 90 days from the date of Purchase and are subject to the conditions set forth herein. In no event shall Sega of America, Inc., be liable for consequential or incidental damages resulting from the breach of any express or implied warranties.

The provisions of this limited warranty are valid in the United States only. Some States do not allow limitations on how long an implied warranty lasts, or exclusion of consequential or incidental damages, so the above limitation or exclusion may not apply to you. This warranty provides you with specific legal rights. You may have other rights, which vary from state to state.

