

 **Roland®**

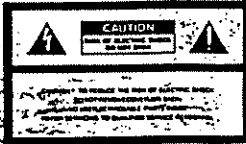

**Owner's Manual**



The lightning flash with arrowhead symbol, within an equilateral triangle, is intended to alert the user to the presence of un-insulated "dangerous voltage" within the product's enclosure that may be of sufficient magnitude to constitute a risk of electric shock to persons.



The exclamation point within an equilateral triangle is intended to alert the user to the presence of important operating and maintenance (servicing) instructions in the literature accompanying the product.

INSTRUCTIONS PERTAINING TO A RISK OF FIRE, ELECTRIC SHOCK OR INJURY TO PERSONS.

# IMPORTANT SAFETY INSTRUCTIONS

**WARNING:** When using electric products, basic precautions should always be followed, including the following:

1. Read all the instructions before using the product.
2. To reduce the risk of injury, close supervision is necessary when a product is used near children.
3. Do not use this product near water, for example, near a bathtub, washbowl, kitchen sink, in a wet basement, or near a swimming pool, or the like.
4. This product should be used only with a cart or stand that is recommended by the manufacturer.
5. This product, either alone or in combination with an amplifier and headphones or speakers, may be capable of producing sound levels that could cause permanent hearing loss. Do not operate for a long period of time at a high volume level or at level that is uncomfortable. If you experience any hearing loss or ringing in the ears, you should consult an audiologist.
6. The product should be located so that its location or position does not interfere with its proper ventilation.
7. The product should be located away from heat sources such as radiators, heat registers, or other products that produce heat.
8. The product should avoid using in where it may be affected by dust.
9. The product could be connected to a power supply only of the type described in the operating instructions or as marked on the product.

10. The power-supply cord of the product should be unplugged from the outlet when left unused for a long period of time.
11. Do not tread on the power-supply cord.
12. Do not pull the cord but hold the plug when unplugging.
12. When setting up with any other instruments, the procedure should be followed in accordance with instruction manual.
14. Care should be taken so that objects do not fall and liquids are not spilled into the enclosure through openings.
15. The product should be serviced by qualified service personnel when:
  - A: The power-supply cord or the plug has been damaged; or
  - B: Objects have fallen, or liquid has been spilled, into the product; or
  - C: The product has been exposed to rain; or
  - D: The product does not appear to operate normally or exhibits a marked change in performance; or
  - E: The product has been dropped, or the enclosure damaged.
16. Do not attempt to service the product beyond that described in the user-maintenance instructions. All other servicing should be referred to qualified service personnel.

## SAVE THESE INSTRUCTIONS

### ADVARSEL!

Lithumbatteri: Eksplosjonsfare.  
Utskiftning må kun foretages af en sagkyndig og som beskrevet i servicemanualen.

### VARNING!

Lithumbatteri: Eksplosjonsrisiko.  
Får endast bytas av behörig service tekniker.  
Se instruktioner i servicemanualen.

### ADVARSEL!

Lithumbatteri: Fare for eksplosion.  
Må bare skiftes av kvalifisert tekniker som beskrevet i servicemanualen.

### VAROITUS!

Lithiumparisto: Rajahdysvaara.  
Pariston saa vaihtaa ainoastaan alan ammattimies.

### WARNING

#### THIS APPARATUS MUST BE EARTH GROUNDED.

The three conductors of the mains lead attached to this apparatus are identified with color as shown in the table below, together with the matching terminal on the UK type power plug. When connecting the mains lead to a plug, be sure to connect each conductor to the correct terminal, as indicated. "This instruction applies to the product for United Kingdom."

MAINS LEADS		PLUG
Conductor	Color	Mark on the matching terminal
Live	Brown	Red or letter L
Neutral	Blue	Black or letter N
Grounding	Green-Yellow	Green, Green-Yellow, letter E or symbol

#### Beschreibung des Herstellers / Importeurs

Hiermit wird bescheinigt, daß der/die/das

**ROLAND MULTI TIMBRAL SOUND MODULE D-110**

Kenn. Typ Bescheinigung

in Übereinstimmung mit den Bestimmungen der

Amtsbl. Vfg. 1046 / 1984

(Hersteller/Importeur)

funktionsfähig ist.

Der Deutschen Bundespost wurde das Inverkehrbringen dieses Gerätes angezeigt und die Berechtigung zur Überprüfung der Serie auf Einhaltung der Bestimmungen eingeräumt.

Roland Corporation Osaka / Japan

Small text at the bottom of the German label.

#### RADIO AND TELEVISION INTERFERENCE

"Warning - This equipment has been tested and found to comply with the limits for a Class B emitting product, pursuant to Subpart J, of Part 15, of FCC rules. Operation with unshielded cables is intended to minimize the risk of radio frequency interference to other licensed operations in the vicinity.

The equipment described in this manual produces and uses radio frequency energy. If it is not installed and used properly, that is, in strict accordance with our instructions, it may cause interference with other licensed operations.

This equipment has been tested and found to comply with the limits for a Class B emitting product as prescribed in the regulations in Subpart J, of Part 15, of FCC rules. These rules are designed to provide reasonable protection against such interference in a residential installation. It has been determined that the maximum use of this equipment will not cause interference in a residential installation. This interference data does not apply to radio or television reception, which may be experienced by turning the equipment on and off, the user is encouraged to try to correct the interference by the following measures:

- Disconnect other devices and their interconnecting cables one at a time. If the interference stops, it is caused by either the other device or its lead cable.
- These devices usually require Radio Frequency Shielded (RFS) cables. For further details, see the manual. The dealer should refer you to the dealer for more details. For more details, contact the manufacturer or dealer for assistance.
- If your equipment does cause interference to radio or television reception, you can try to correct the interference by using one or more of the following measures:
  - Turn the TV or radio antenna and the interconnecting cable.
  - Move the equipment to one side of the room of the TV or radio.
  - Move the equipment further away from the TV or radio.
  - Plug the equipment into an outlet that is on a different circuit than the TV or radio. (That is, make certain the equipment and the radio or television set are on circuits controlled by different circuit breakers or fuses.)
  - Consider installing a radio frequency antenna with shielded cable lead-in between the antenna and TV.
- If necessary, you should consult your dealer or an experienced radio technician for additional suggestions. You may find helpful the following booklet prepared by the Federal Communications Commission: "How to Identify and Resolve Radio-TV Interference Problems". This booklet is available from the U.S. Government Printing Office, Washington, D.C. 20540. Stock No. 204-200-253-5.

Please read the separate volume "MIDI", before reading this owner's manual.

Copyright © 1988 by ROLAND CORPORATION

All rights reserved. No part of this publication may be reproduced in any form without the written permission of ROLAND CORPORATION.

MULTI-TIMBRAL  
SOUND MODULE

**0-110**

---

**OWNER'S MANUAL**

## ■ PANEL DESCRIPTION

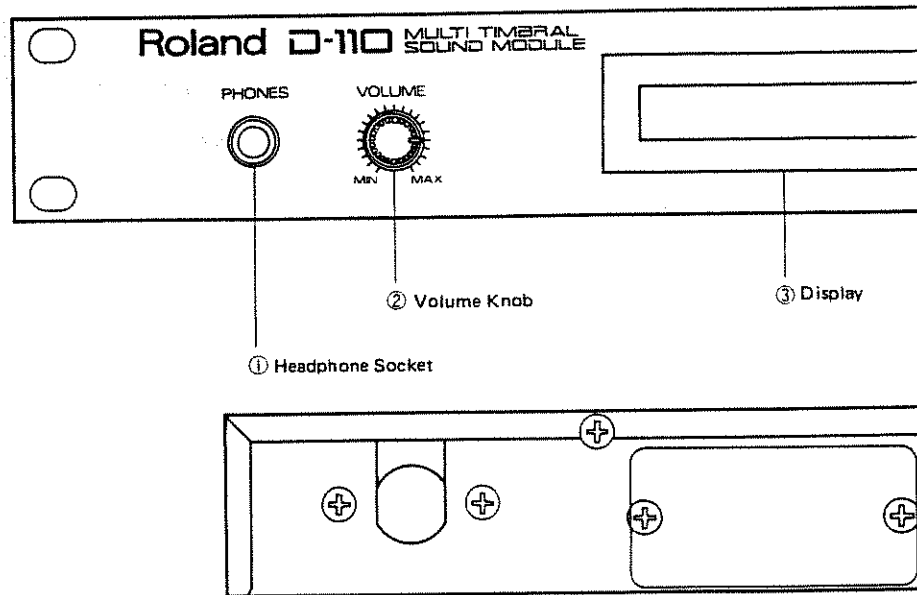

### ① Headphone Socket

Connect stereo headphones to this socket. The best possible headphones to be used should have an impedance from 8 to 150 ohms. Even when headphones are connected to this socket, the Output Socket still sends signals.

### ② Volume Knob

This controls the volume of the sound sent from the Output Socket and Headphone Socket.

### ③ Display

This shows the current condition of the D-110.

### ④ Exit Button

Use this button to return to the Play mode from another mode.

### ⑤ Patch Button See page 40.

Push this button to enter Patch selecting mode.

### ⑥ Timbre Button See page 42.

Push this button to enter Timbre selecting mode.

### ⑦ Edit Button See pages 40, 42 and 48

Push this button to enter editing mode for a Patch, Timbre or Tone, or Rhythm Setup mode.

### ⑧ Part Button See pages 34 and 68

Push this button to enter value setting mode for the Output Level of each Part, etc.

### ⑨ System Button See page 80.

Push this button to enter value setting mode for the Master Tuning, etc.

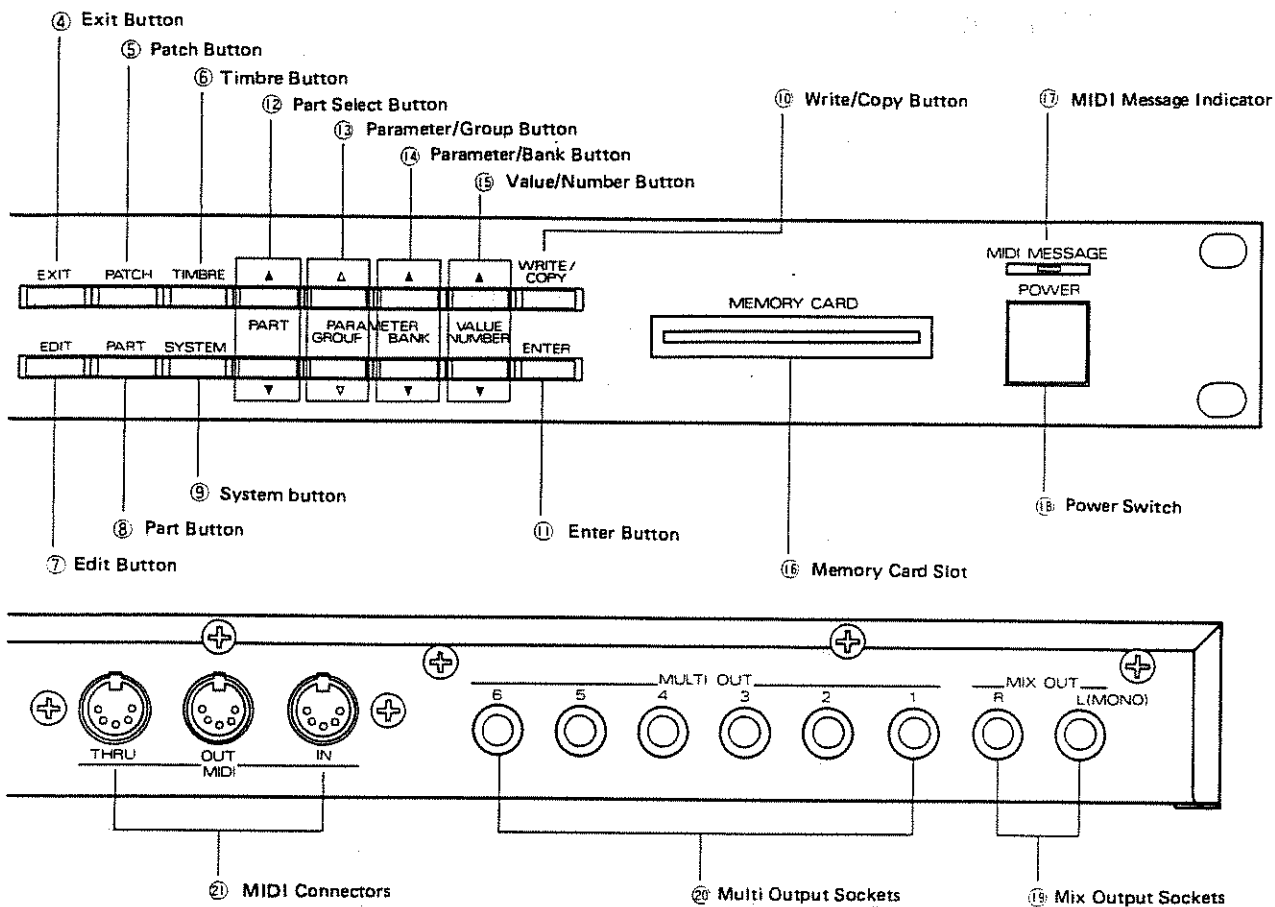

⑩ **Write/Copy Button** See pages 71 and 83.

⑪ **Enter Button** See page 84.  
 Push this button to execute a specific procedure.

⑫ **Part Select Buttons** See page 68.  
 Use these buttons for selecting a Part or Partial.

⑬ **Parameter/Group Buttons**  
 Use these buttons to select a Parameter or Tone Group.

⑭ **Parameter/Bank Buttons**  
 Use these buttons to select a Parameter or Tone Bank, or to change values drastically.

⑮ **Value/Number Buttons**  
 Use these buttons to change values or select Tone Number.

⑯ **Memory Card Slot**  
 Insert a memory card here.

⑰ **MIDI Message Indicator**  
 This is lit while MIDI messages are being received.

⑱ **Power switch**  
 This turns the unit on or off.

⑲ **Mix Output Sockets**  
 These are stereo output sockets.

⑳ **Multi Output Sockets**  
 These are independent output sockets.

㉑ **MIDI Connectors**  
 These sockets are used for connection MIDI devices.

## ■ IMPORTANT NOTES

### POWER

- The appropriate power supply for this unit is shown on its name plate. Please make sure that the line voltage in your country meets the requirement.
- Do not use the same socket used for any noise generating device (such as a motor or variable lighting system) or large power consuming device.
- When connecting a power cable to the socket, be sure that the unit is turned off.
- When disconnecting the power plug from the socket, do not pull the cord but hold the plug to avoid damaging the cord.
- Handle the power cord gently.
- If the unit is not to be used for a long period of time, unplug the power cord from the socket.
- It is normal for this unit to become hot while being operated.
- Before setting up this unit with other devices, turn this unit and all the other units off.
- This unit might not work properly if turned on immediately after being turned off. If this happens, simply turn it off and turn it on again after waiting a few seconds.

### LOCATION

- Do not place this unit in the following conditions:
  - In extreme heat (where it may be affected by direct sunlight, near a heater, etc.)
  - In extreme humidity where it may be affected by dust or vibration.
- Operating this device near a neon, fluorescent lamp, TV or CRT display may cause noise interference. If so, change the angle or the position of the device.
- If you operate this unit near a TV or radio which is turned on, noise or picture trouble may occur. If this happens, move the unit away from it.

- Do not place anything heavy on this unit or the power cord.

#### **CLEANING**

- Use a mild detergent for cleaning. Do not use solvents such as thinner.

#### **MEMORY BACKUP**

- This device features a memory back-up system that retains the data even when switched off. The battery that supports the back-up circuit should be replaced every five years. Call Roland for battery replacement. (The first replacement may be required.)
- To avoid accidental erasure or loss of data, please make a data memo or save data onto a memory card. If it happens to be erased while the device is being repaired, there is no way to restore the data.
- When the battery is low, the Display defaults as shown below, and the data in memory may be lost.

# CONTENTS

PANEL DESCRIPTION .....	4
IMPORTANT NOTES .....	6

## BASIC COURSE

<b>1</b> OUTLINE OF THE D-110 .....	10
1. Features .....	10
2. 8 Modes of the D-110 .....	11
3. Basic Concept of the D-110 .....	12
4. Partials and the Maximum Voices .....	14
<b>2</b> CONNECTIONS .....	15
<b>3</b> PLAYING THE D-110 .....	16
1. Power up .....	16
2. MIDI Channel Setting .....	16
3. Timbre Selection (Changing the sound in each Part) .....	18
4. Memory Card .....	20
5. Rhythm Part Play .....	22
6. Master Tuning .....	23
7. Level Adjustment .....	23
8. Pan Setting .....	24
9. Reverb Setting .....	25
<b>4</b> PATCHES .....	27
1. Patch Writing .....	28
2. Patch Selection .....	29

## ADVANCED COURSE

<b>1</b> BASIC PROCEDURES .....	34
1. Basic Procedure for Editing Parameters .....	34
2. Memory .....	36
<b>2</b> PATCH EDITING .....	40
1. Editing Procedure .....	40
2. Patch Parameters .....	41
<b>3</b> TIMBRE EDITING .....	42
1. Timbre Editing Procedure .....	42
2. Timbre Parameters .....	43
<b>4</b> TONE EDITING .....	45
1. The Basic Concept of a Tone .....	45
2. Editing Procedure .....	48
3. Copying a Tone or Partial .....	51
4. Tone Parameters .....	53
<b>5</b> PART SETTING .....	68
1. Editing Procedure .....	68
2. Part Parameters .....	69

<b>6</b> WRITING .....	71
1. Patch Writing .....	71
2. Timbre Writing .....	73
3. Tone Writing .....	75
<b>7</b> PHYTHM SETUP .....	77
1. Editing Procedure .....	77
2. Phythm Setup Parameters .....	78
<b>8</b> SYSTEM SETUP .....	80
1. Editing Procedure .....	80
2. System Setup Parameters .....	80
<b>9</b> DATA TRANSFER .....	83
1. Data Transfer Mode .....	83
2. Data Transfer Using a Memory Card .....	84
3. Data Transfer with MIDI (BULK) .....	86
4. Data Transfer via MIDI (INDIVIDUAL) .....	87
<b>10</b> ROM PALY .....	88

## REFERENCE

<b>1</b> LA SYNTHESIS .....	90
1. What is sound made of? .....	90
2. Key Point for Sound Creation .....	91
<b>2</b> TROUBLE-SHOOTING .....	95
1. Before Calling for Service .....	95
2. Error Messages .....	96
<b>3</b> APPENDIX TABLES .....	98
1. Parameter Table .....	98
2. Preset Tones Table .....	101
3. Initial Rhythm Setting .....	102
4. PCM Sounds Table .....	103
5. Blank Chart .....	105
<b>4</b> GUIDE FOR USING THE D-110 .....	108

MIDI IMPLEMENTATION .....	110
MAIN SPECIFICATION .....	121
INDEX .....	122



# BASIC COURSE

- 1 **OUTLINE OF THE D-110**
- 2 **CONNECTIONS**
- 3 **PLAYING THE-110**
- 4 **PATCHES**

# 1 OUTLINE OF THE D-110

The Roland D-110, a Multi Timbral Sound Module can be used as the sound source of a keyboard, sequencer, etc.

## 1. Features

- **LA Synthesis**

LA stands for Linear Arithmetic synthesis which is the heart of the new technology. LA synthesis involves a great many technological advances resulting not only in a superior sound quality but also an improved ease of programming, which has been proved in the D-50 or D-550. In this way, Roland has succeeded in maintaining a high degree of familiarity to the user despite the technical wizardry involved.
- **Multi Timbral Function**

The Multi Timbral function turns the D-110 into eight independent synthesizers, allowing you to enjoy ensemble style performance with only one D-110.
- **Multi Output**

The D-110 features 6 independent Multi outputs where 6 different sounds can be sent out separately. Consequently, different effects may be applied to the various sounds, improving the quality of the mixing possibilities.
- **Part**

The D-110 has 8 Parts which work like conventional synthesizers, and a Rhythm Part which behaves like the sounds of a rhythm machine. Each Part can be controlled by information on a different MIDI channel.
- **Tone**

A Tone is the basic unit of a sound. The D-110's memory capacity can retain 128 different Preset Tones, 64 user-programmed Tones, and 63 Preset Rhythm Tones.
- **Patch and Timbre**

A Timbre consists of Tones and Performance Controlling functions. The D-110 can store up to 128 Timbres, and any of these Timbres can be assigned to each Part. During live performance, you can use various sounds by changing these Timbres.

A Patch is a collection of Reverb and Part settings. The D-110 can store up to 64 Patches.
- **Built-in Digital Reverb**

The digital reverberation section of the D-110 can create reverb effects. You can set a desired reverb and write it into Patch.
- **Rhythm Part**

The Rhythm Part of the D-110 can use up to 85 Rhythm Tones, Preset Rhythm Tones and the Tones you have programmed yourself. Each Rhythm Tone can have a different Pan and Level setting, as desired.
- **Memory Card**

The optional memory card (M-256D or M-128D) can be used for saving your original sound data for future use.

## 2. 8 Modes of the D-110

Please study the following 8 Modes of the D-110.

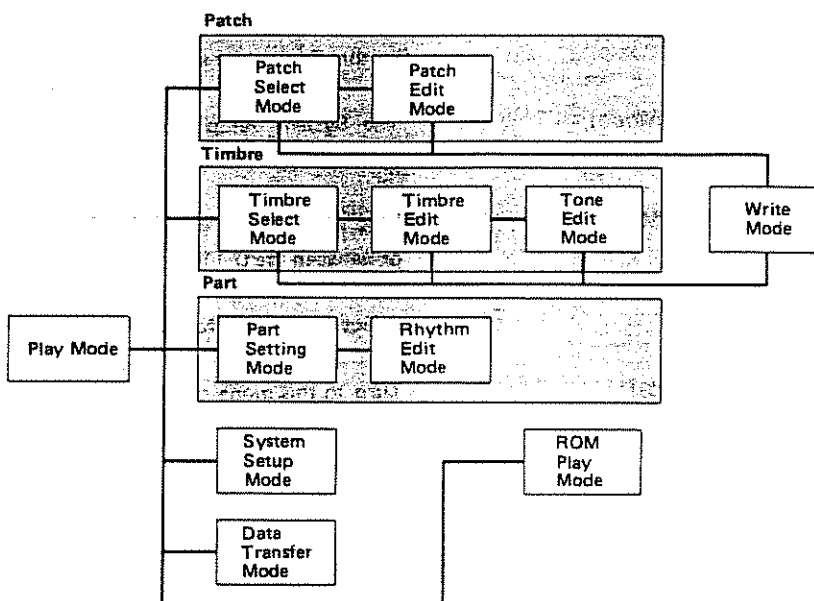

### [Play Mode]

This may be called the normal condition of the D-110. In this mode, you can monitor the Timbre assigned to each Part.

### [Patch Mode]

The Patch mode involves procedures related to the Patches, such as Reverb settings, etc.

- Patch Select mode
- Patch Edit mode

Turn to this mode for selecting a patch.

Use this mode for editing a Patch name or Reverb settings.

### [Timbre Mode]

The Timbre mode allows you to assign a new Timbre to a Part or edit a Timbre or Tone, etc.

- Timbre Select mode
- Timbre Edit mode
- Tone Edit mode

This mode allows you to change the Timbre assigned to each Part.

This mode allows you to edit a Timbre.

This mode allows you to edit a Tone.

[Part Mode]	The Part mode deals with the operations related to the 8 Parts and the Rhythm Part.
• Part Setting mode	In this mode, the volume or MIDI channel of each Part can be selected.
• Rhythm Setup mode	In this mode, the volume, output or Rhythm Tone assigned to Key number of the Rhythm Part can be selected.
[System Setup Mode]	The System Setup mode covers the procedures related to the D-110's overall condition, such as tuning of all the Parts.
[Data Transfer Mode]	This mode allows you to transfer data between the D-110 and a memory card, or between the D-110 and another device.
[Write Mode]	Select this mode for writing your edited version of a Tone, Timbre or Patch.
[ROM Play Mode]	Turn to this mode to play the preprogrammed performance data which effectively uses the Multi Timbral function.

### 3. Basic Concept of the D-110

The D-110 uses LA synthesis, which stands for Linear Arithmetic synthesis, which is the heart of the new technology. LA synthesis involves a great many technological advances resulting not only in a superior sound quality but also an improved ease of programming. In this way, Roland has succeeded in maintaining a high degree of familiarity to the user despite the technical wizardry involved. Another feature is the D-110's Multi Timbral function that allows you to enjoy ensemble style performance with only one D-110. In other words, the D-110 has 8 Parts which work like 8 independent synthesizers and a Rhythm Part which behaves like the sounds of a rhythm machine. The following explanation covers the basic knowledge required for the Multi Timbral function.

[Partial]	A Partial may be called the smallest unit of a sound. A Partial uses either a Synthesizer Sound Generator (= similar to a conventional analog synthesizer) or a PCM Sound Generator (= PCM sampling).
[Tone]	A Tone consists of a Partial block and a Common block. The Partials are combined in pairs, and two sets of pairs form a Tone. An important Common parameter called "Structure" decides how two of the four Partials should be combined, or which sound generator should be used.

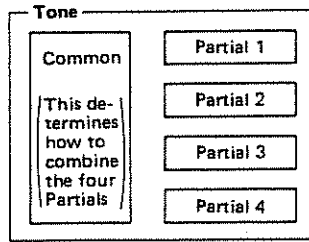

**[Timbre]**

A Timbre consists of Tones and Performance Controlling functions such as bender range and output system. Normally, in this manual, "sound" refers to Timbre.

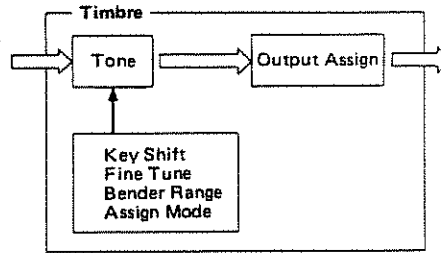

**[Part]**

The D-110 has 8 Parts which work like conventional synthesizer modules and a Rhythm Part which behaves like a rhythm module. The volume, MIDI channel and Pan of each Part can be set individually, and more, the volume and output of the Rhythm Part can be set to the desired values.

**[Patch]**

A Patch is a collection of Reverb and Part (Timbre assignment) settings which are related to the overall control of the D-110.

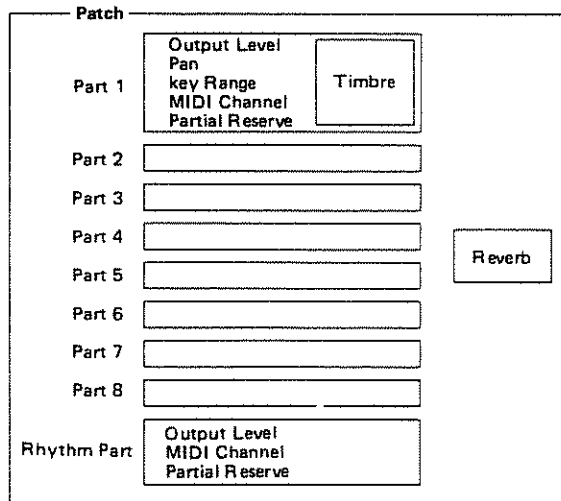

The D-110, therefore, may be considered to be structured as shown below.

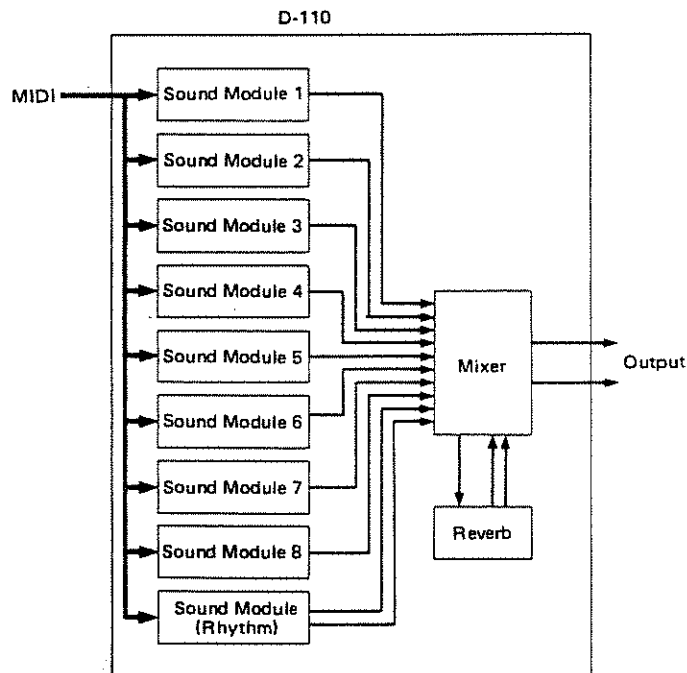

In brief, Parts works like conventional MIDI sound modules, and Timbres like Patches in a sound module.

#### 4. Partials and the maximum Voices

The D-110 can produce a maximum of 32 voices using 32 Partials at the same time. A Partial is the smallest unit of a sound within the D-110. A Tone consists one to four Partials for each voice. A Tone made of only one Partial can be played using 32 voices, but a Tone using two Partials has 16 voices, and a Tone using four Partials is 8 voice polyphonic. It is very important that you have a full understanding of this concept. This can be very tricky as several Tones are involved at the same time.

## 2 CONNECTIONS

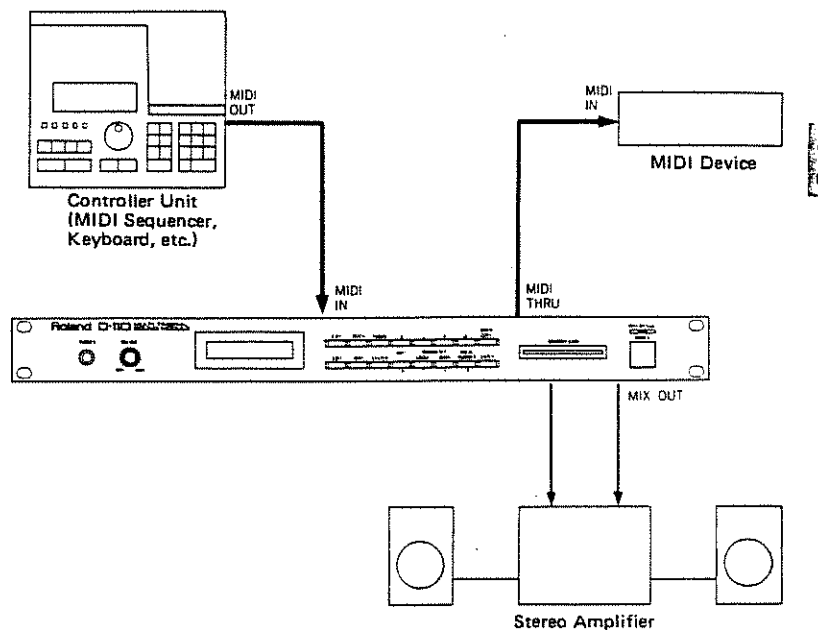

- \* Through the MIDI THRU connector, an exact copy of the messages fed through the MIDI IN is sent out. Using the MIDI THRU connector, more than one MIDI sound module can be controlled by one controller unit. Technically speaking, many MIDI devices can be connected, but in practice, connecting more than a few devices may cause problems. For connection of more than three units, use the optional MIDI Output Selector MPU-105.
- \* Usually, the MIDI messages fed into the MIDI IN are not sent through the MIDI OUT.
- \* Through the Mix Output Sockets, those Parts (= Timbre) whose Output Assign is set to MIX are sent in stereo. Each Multi Output Socket sends a specific signal, as set by each Timbre.

### 3 PLAYING THE D-110

The D-110 is played by MIDI messages sent from an external MIDI device.

#### 1. Power up

Step 1 Make sure that the D-110 is correctly set up with an external device, then turn the D-110 on.

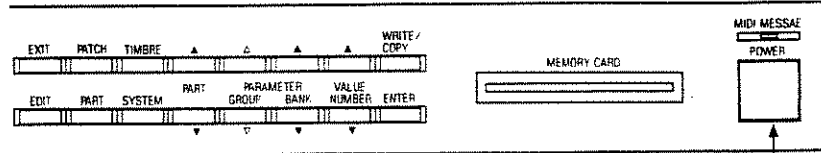

The Display will respond with:

```
12345678R Part1
I-B15:SlapBass 1
```

Play Mode Display

Step 2 Turn on the controller unit connected to the D-110.

#### 2. MIDI Channel Setting

The MIDI channels of the connected devices should be set to the same number. If the MIDI receive channel of the D-110 is not set correctly, MIDI messages sent from an external device cannot be received properly, therefore the D-110 cannot be played as it should be. The D-110 allows you to set a different MIDI channel for each Part.

If you wish to change them, do as follows.

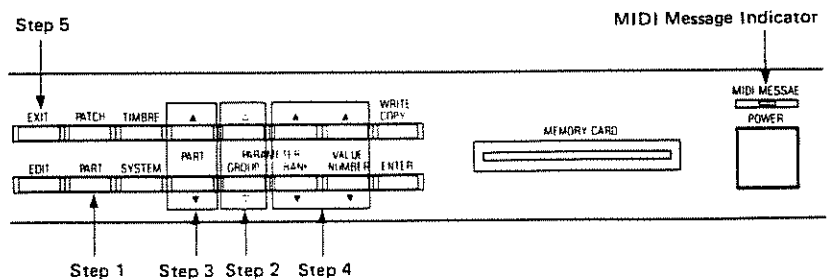

Step 1 Push PART.



Step 2 Using PARAMETER/GROUP (▽△), call the MIDI channel setting Display.

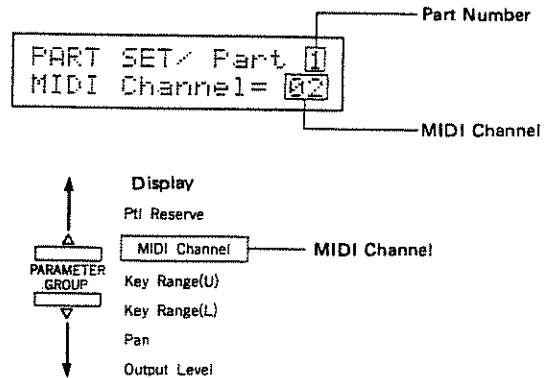

Step 3 Using PART (▲▼), select the Part whose MIDI channel you wish to change.

Pushing ▲ increases the number and ▼ decreases the number.

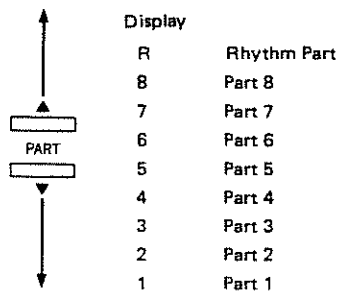

Step 4 Using PARAMETER/BANK (▲▼), VALUE/NUMBER (▲▼), set the MIDI channel for the Part.

Pushing ▲ increases the number, and ▼ decreases it.

The PARAMETER/BANK (▲▼) number will change in two steps.

- \* At OFF, MIDI messages are not received.
- \* When the D-110 receives MIDI messages from the controller unit, the MIDI Indicator will light up.

Step 5 Push EXIT to return to the Play mode.

- \* The MIDI channel you have set will be erased by selecting a different Patch. To retain the new channel you have set, take the appropriate Patch Writing procedure (see page 28).

### 3. Timbre Selection (Changing the sound in each Part)

A Timbre is represented as a Group (A or B), Bank (1 – 8) and Number (1 – 8). The internal memory of the D-110 can store up to 128 different Timbres, and another 128 Timbres can be stored on a memory card, allowing storage of 256 Timbres altogether.

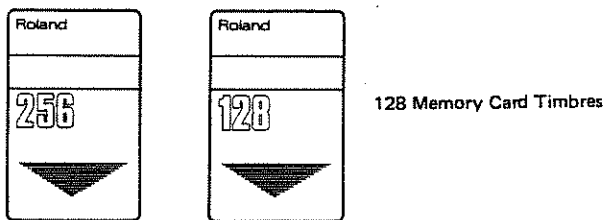
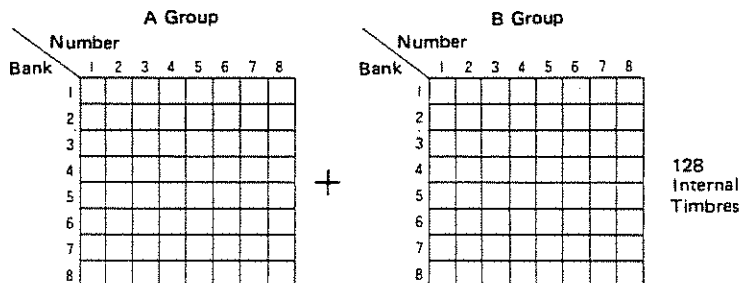

**[Monitoring a Timbre in each Part]**

You can monitor the Timbre assigned to each Part as follows. Call the Part Display you wish to monitor using the PART (▲▼) buttons.

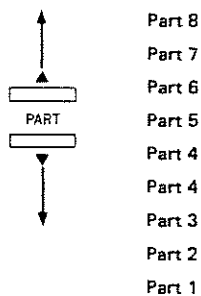
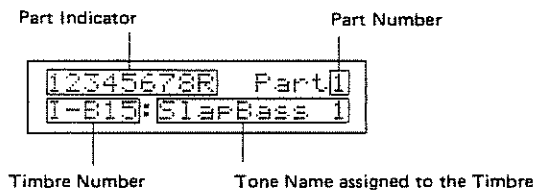

\* The corresponding Part Indicator flashes to the performance.

[Selecting a Timbre from the D-110]

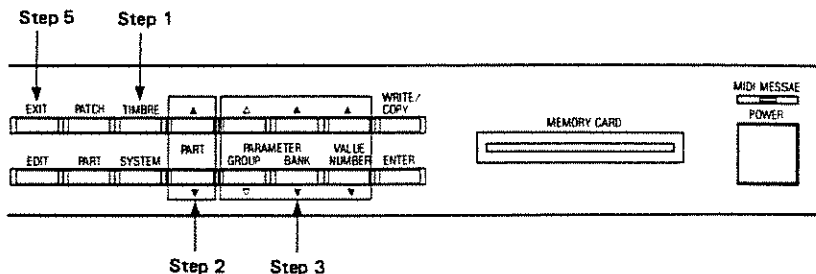

Step 1 Push TIMBRE.

The Display shows the Timbre Number (= Group, Bank and Number) of the Timbre assigned to the Part currently selected and the Tone name used for the timbre.

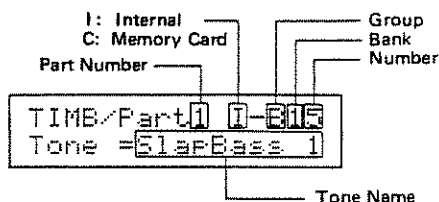

Step 2 Using PART (▲▼), select the Part where you wish to assign a different Timbre.

Step 3 Assign the Group with PARAMETER/GROUP (▽△), assign the Bank with the PARAMETER/BANK (▲▼), assign the Number with the VALUE/NUMBER (▲▼) for selecting the new Timbre to be used for the Part.

To select the Internal or Memory Card mode, use the PARAMETER/GROUP (▽△).

\* If a memory card is not connected to the Card Slot, or a memory card which contains data from another instrument (i.e., not a D-110, D-10 or D-20) is used, an Error Message will appear in the Display. (See page 20 "Memory Card".)

\* The D-110's maximum number of voices played simultaneously changes depending on how the selected Timbre is programmed.

Step 4 Repeat Steps 2 and 3.

Step 5 Push EXIT to return to the Play mode.

[Selecting a Timbre with Program Change messages]

The Timbre can be changed using the Program Change messages sent from the controller unit.

Turn the D-110 to the Play mode, and send Program Change messages on the MIDI channel of the relevant Part, and the Timbre of that Part will be changed.

Program Change numbers correspond with the Timbre Numbers of the D-110 as shown in the table below.

Group	Bank	Number							
		1	2	3	4	5	6	7	8
A	1	1	2	3	4	5	6	7	8
	2	9	10	11	12	13	14	15	16
	3	17	18	19	20	21	22	23	24
	4	25	26	27	28	29	30	31	32
	5	33	34	35	36	37	38	39	40
	6	41	42	43	44	45	46	47	48
	7	49	50	51	52	53	54	55	56
	8	57	58	59	60	61	62	63	64
B	1	65	66	67	68	69	70	71	72
	2	73	74	75	76	77	78	79	80
	3	81	82	83	84	85	86	87	88
	4	89	90	91	92	93	94	95	96
	5	97	98	99	100	101	102	103	104
	6	105	106	107	108	109	110	111	112
	7	113	114	115	116	117	118	119	120
	8	121	122	123	124	125	126	127	128

\* Number 0 to 127 are used as Program Change Messages in the actual MIDI Format.

\* When the Timbre in the Part currently in use is an internal Timbre, the received Program Change number will select the corresponding Timbre in the internal memory. If the Timbre comes from a memory Card, the same Program Change number will select the corresponding Timbre on the memory card.

The Display shows the new Timbre Number you have assigned to the Part and the Names of the Tones used for the Timbre.

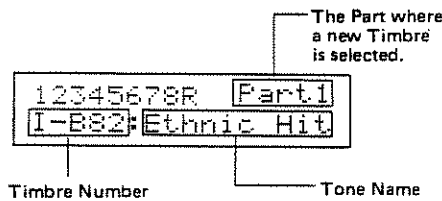

## 4. Memory Card

A memory card can be used for saving Patch/Timbre/Tone or Rhythm Setup data.

\* A brand new memory card (M-256D or M-128D) does not contain any data, and therefore cannot be used unless the entire data in the internal memory is first copied onto it (as explained on page 85 "Copying the internal data onto a memory card"). Also, when you are using a memory card which contains data other than the D-110's, take the same copying procedure.

Insert the memory card into the Card Slot in the correct direction.

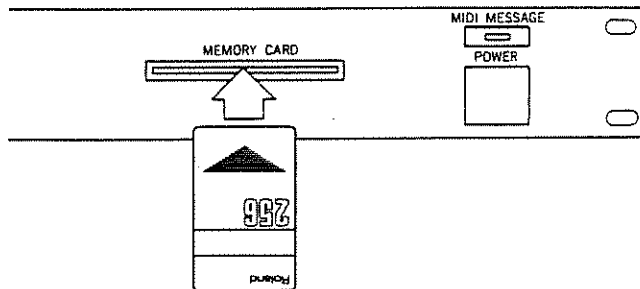

\* If you try to select a Tone or Timber on a memory card, with no memory card connected, or connected incorrectly, the following will appear in the Display for a while. If this happens, the Tone or Timbre is not changed.

Card Not Ready

\* If you use a memory card that contains data for other than a D-110, D-10 or D-20, the following Display is shown for a while. If this happens, the Tone or Timbre is not changed. (Only Timbre/Rhythm Setup data on a memory card for the D-10 and D-20 can be used.)

Illegal Card

There are two types of memory cards;

- ROM card
- RAM card

Data saved on a ROM card cannot be edited but preserved safely.

Data on a RAM card can be edited as many times as you like. To support the data, a backup system that protects data saved on a card even when the unit is turned off is built in. The optional memory cards (M-256D and M-128D) are RAM cards.

For saving the D-110's data, a memory card, M-256D or M-128D can be used. The memory capacity of the M-256D is larger than the M-128D, and the data which can be stored differs as shown below.

	M-256D	M-128D
Tone	64	32
Timbre	128	128
Patch	64	32
Rhythm Setup	1	1

\* When using the M-128D memory card, Tones c33 to c64 are exactly the same as c01 to c32, and Patches C-51 to C-88 are the same Patches as C-11 to C-48.

\* An M-128D memory card that contains data for the D-110 cannot be used for the D-10 or D-20. Only the data of Tone and Timbre of the M-256D in the same condition can be used with the D-10 or D-20.

## 5. Rhythm Part Play

A different Rhythm Tone can be assigned to each key in the Rhythm Part, and will therefore be played by MIDI key messages sent from an external controller unit.

Preset Rhythm Tones have been assigned to Key numbers by the manufacturer as shown below.

Initial Setting of Rhythm Tones

Note Name	Tone No.	Tone Name	No. of Partials
C1 (24)	r64	OFF	(0)
C#1(25)	r64	OFF	(0)
D1 (26)	r64	OFF	(0)
D#1(27)	r64	OFF	(0)
E1 (28)	r64	OFF	(0)
F1 (29)	r64	OFF	(0)
F#1(30)	r64	OFF	(0)
G1 (31)	r64	OFF	(0)
G#1(32)	r64	OFF	(0)
A1 (33)	r64	OFF	(0)
A#1(34)	r64	OFF	(0)
B1 (35)	r15	Bass Drum-1	2
C2 (36)	r16	Bass Drum-2	1
C#2(37)	r25	Rim Shot	1
D2 (38)	r19	Snare Drum-1	1
D#2(39)	r39	Hand Clap	1
E2 (40)	r20	Snare Drum-2	1
F2 (41)	r30	Low Tom Tom-1	1
F#2(42)	r01	Closed High Hat-1	1
G2 (43)	r33	Low Tom Tom-2	1
G#2(44)	r04	Open High Hat-2	2
A2 (45)	r29	Middle Tom Tom-1	1
A#2(46)	r03	Open High Hat-1	2
B2 (47)	r32	Middle Tom Tom-2	1
C3 (48)	r28	High Tom Tom-1	1
C#3(49)	r05	Crash Cymbal	2
D3 (50)	r31	High Tom Tom-2	1
D#3(51)	r08	Ride Cymbal	2
E3 (52)	r13	China Cymbal	2
F3 (53)	r11	Cup	2
F#3(54)	r40	Tambourine	1
G3 (55)	r14	Splash Cymbal	1
G#3(56)	r41	Cowbell	1
A3 (57)	r07	Crash Cymbal (Mute)	1
A#3(58)	r21	Snare Drum-3	1
B3 (59)	r10	Ride Cymbal (Mute)	1
C4 (60)	r42	High Bongo	1
C#4(61)	r43	Low Bongo	1
D4 (62)	r44	High Conga (Mute)	1
D#4(63)	r45	High Conga	1
E4 (64)	r46	Low Conga	1
F4 (65)	r47	High Timbale	1
F#4(66)	r48	Low Timbale	1
G4 (67)	r49	High Agogo	1
G#4(68)	r50	Low Agogo	1
A4 (69)	r51	Cabasa	1
A#4(70)	r52	Maracas	1
B4 (71)	r53	Short Whistle	2

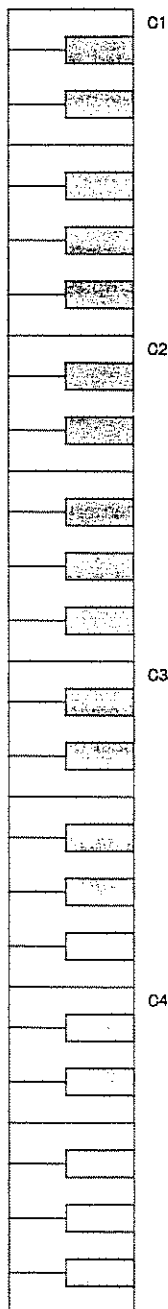

Note Name	Tone No.	Tone Name	No. of Partials
C5 (72)	r54	Long Whistle	2
C#5(73)	r55	Quijada	3
D5 (74)	r12	Cup (Mute)	1
D#5(75)	r56	Claves	1
E5 (76)	r26	Brush-1	2
F5 (77)	r27	Brush-2	2
F#5(78)	r57	Castanets	2
G5 (79)	r38	High Pitch Tom Tom-2	1
G#5(80)	r58	Triangle	2
A5 (81)	r37	High Pitch Tom Tom-1	1
A#5(82)	r59	Wood Block	1
B5 (83)	r60	Bell	2
C6 (84)	r17	Bass Drum-3	2
C#6(85)	r18	Bass Drum-4	1
D6 (86)	r22	Snare Drum-4	2
D#6(87)	r23	Snare Drum-5	1
E6 (88)	r24	Snare Drum-6	1
F6 (89)	r36	Low Tom Tom-3	2
F#6(90)	r02	Closed High Hat-2	1
G6 (91)	r35	Middle Tom Tom-3	2
G#6(92)	r06	Crash Cymbal (Short)	1
A6 (93)	r34	High Tom Tom-3	2
A#6(94)	r09	Ride Cymbal (Short)	1
B6 (95)	r61	Native Drum-1	1
C7 (96)	r62	Native Drum-2	1
C#7(97)	r63	Native Drum-3	1
D7 (98)	r64	OFF	(0)
D#7(99)	r64	OFF	(0)
E7 (100)	r64	OFF	(0)
F7 (101)	r64	OFF	(0)
F#7(102)	r64	OFF	(0)
G7 (103)	r64	OFF	(0)
G#7(104)	r64	OFF	(0)
A7 (105)	r64	OFF	(0)
A#7(106)	r64	OFF	(0)
B7 (107)	r64	OFF	(0)
C8 (108)	r64	OFF	(0)

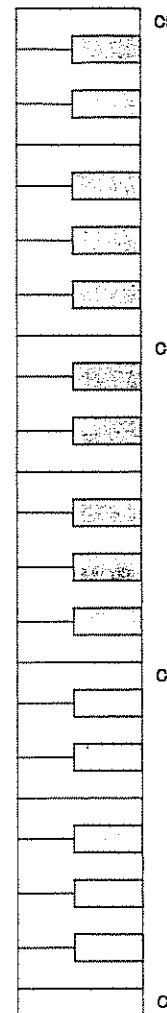

\* Rhythm sound is not available at r64.

## 6. Master Tuning

The Master Tuning function can be used for tuning the D-110 to another instrument.

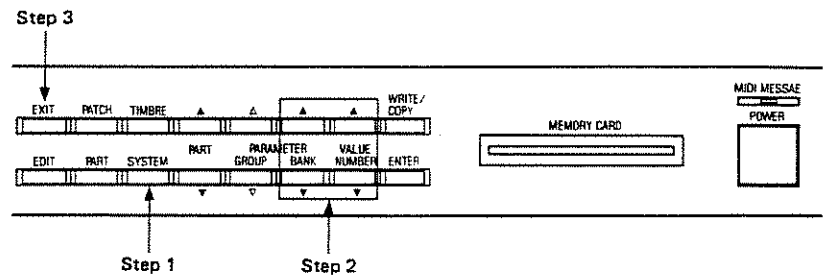

Step 1 Push SYSTEM.

The Display shows the current Master Tuning value.

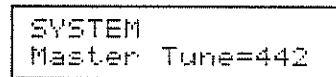

▲ : Indicate that tuning value is higher than the figure.  
▼ : Indicate that tuning value is lower than the figure.

Step 2 Turn the D-110 using PARAMETER/BANK (▲▼) and VALUE/NUMBER (▲▼).

Pushing PARAMETER/BANK (▲▼) changes values in approx. 2 Hz steps, and pushing VALUE/NUMBER (▲▼) changes the number continuously. ▲ button increases numbers, and ▼ button decreases, while holding the button down quickens the changes.

The number shown in the Display refers to the frequency of the standard pitch (A4).

Step 3 When finished, push EXIT to return to the Play mode.

\* The Master Tune you have set will be retained even after the unit is turned off.

## 7. Level Adjustment

The volume of each Part (1 to 8 and the Rhythm Part) can be set separately, by adjusting the volume balance of each Part. In the Rhythm Part, it is also possible to set a different volume for each Key number.

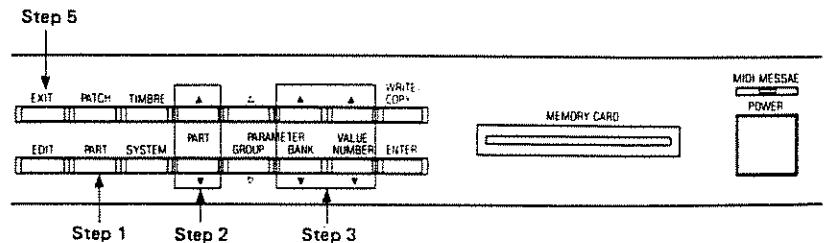

Step 1 Push PART.

The Display shows the level of the Part currently selected.



Step 2 Select the Part whose volume you wish to change with PART (▲▼).

Step 3 Set a desired level using PARAMETER/BANK (▲▼) and VALUE/NUMBER (▲▼) between 0 and 100.

Pushing PARAMETER/BANK (▲▼) changes the number in steps of 10. ▲ button increases the number, and ▼ button decreases.

Step 4 Repeat Steps 2 and 3.

Step 5 When finished, push EXIT to return to the Play mode.

## 8. Pan Setting

Pan is the positioning of a sound image of each Part output in stereo from the Mix Outputs. By setting the Pan value for each Part, the balance of the stereo output can be changed. In the Rhythm Part, a different Pan value can be set for each Key number. (page 79)

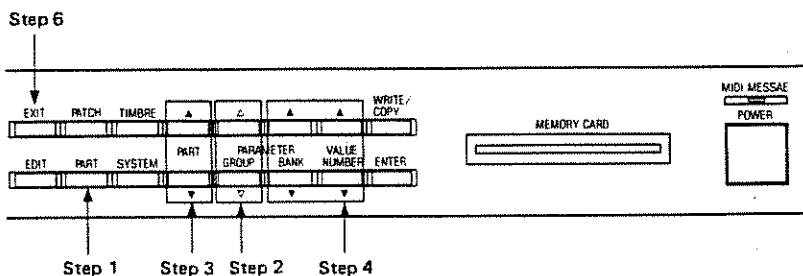

Step 1 Push PART.

Step 2 Using the PARAMETER/BANK (▲▼) and VALUE/NUMBER (▲▼), set the desired value.

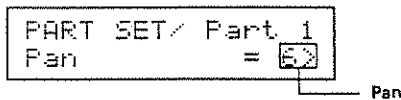

Step 3 Select a Part whose Pan setting is to be edited using the Part (▲▼) buttons.

Step 4 Using the PARAMETER/BANK (▲▼) and VALUE/NUMBER (▲▼) buttons, set the value for Pan.



A Pan value actually creates a sound image as shown below.

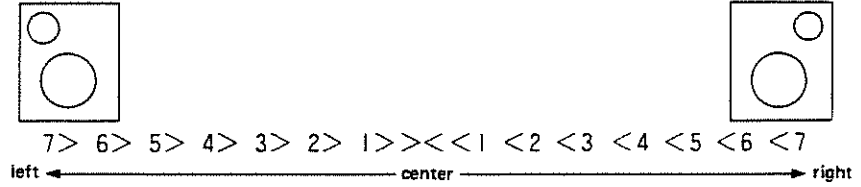

\* When the Structure of monaural output is used the actual changes of panning will be as shown below.

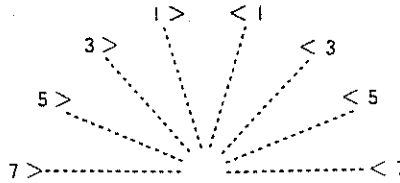

\* When Structure 8 or 9 is selected, the relation of the Pan values and the actual sound images created differs as shown below.

Value	Partial 1(3)	Partial 2(4)
<7	<7	<7
<6	<5	<7
<5	<3	<7
<4	<1	<7
<3	1>	<7
<2	3>	<7
<1	5>	<7
><	7>	<7
1>	7>	<5
2>	7>	<3
3>	7>	<1
4>	7>	1>
5>	7>	3>
6>	7>	5>
7>	7>	7>

Step 5 Repeat Steps 3 and 4.

Step 6 When finished, push EXIT to return to the Play mode.

## 9. Reverb Setting

The D-110 features a built-in digital reverb. By changing the values of the Reverb parameters, various reverb effects can be obtained.

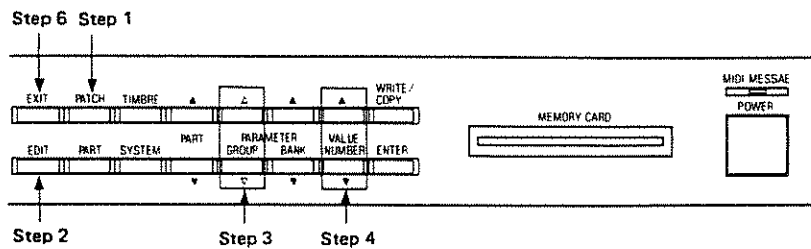

Step 1 Push PATCH.

Step 2 Push EDIT.

The Display shows all the Patch Parameters.

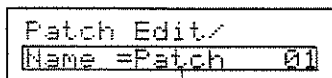

Patch Parameter

Step 3 Using PARAMETER/GROUP (▽△), select the parameter to be edited.

The Reverb parameters are Reverb Type, Reverb Time and Reverb Level.

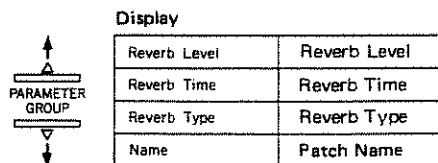

Step 4 Change the value using VALUE/NUMBER (▲▼).

Step 5 Repeat Steps 3 and 4.

Step 6 When finished, push EXIT twice to return to the Play mode.

### REVERB PARAMETERS

- **Reverb Type**

This selects one of the following Reverb Types.

Value	Reverb Type
1	Small Room
2	Medium Room
3	Medium Hall
4	Large Hall
5	Plate
6	Delay 1
7	Delay 2
8	Delay 3
OFF	No Reverb

- **Reverb Time**

This sets the reverberation time. 1 to 8 are valid, higher values making longer times.

\* When the Reverb Type is set to Delay, Delay Time can be controlled with the Reverb Time Parameter.

- **Reverb Level**

This sets the depth of reverb effect. 0 to 7 are valid, higher values deepening the effect.

\* When the Reverb Level parameter is set to 0, no reverb effect is obtained.

# 4 PATCHES

A Patch consists of Timbres assigned to 1 to 8 Parts, Level and Pan values for each Part, Reverb setting, etc. The D-110's internal memory can store up to 64 Patches and a memory card can store another 64 Patches, allowing 128 Patches altogether.

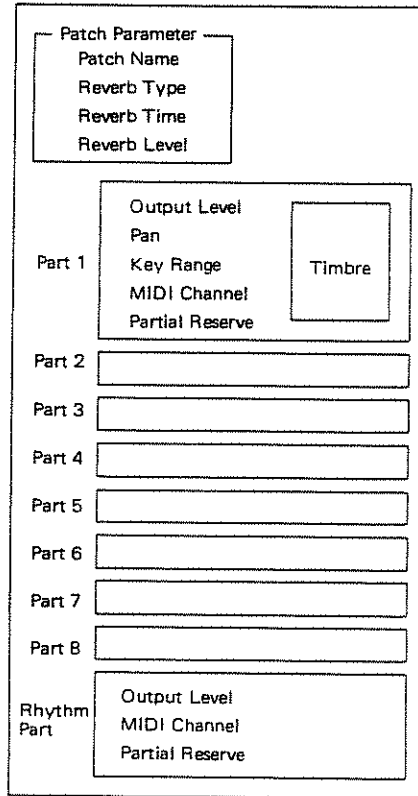

## [Patch Name]

A Patch can be named using up to 10 letters. A Patch Name is useful for finding a Patch quickly.

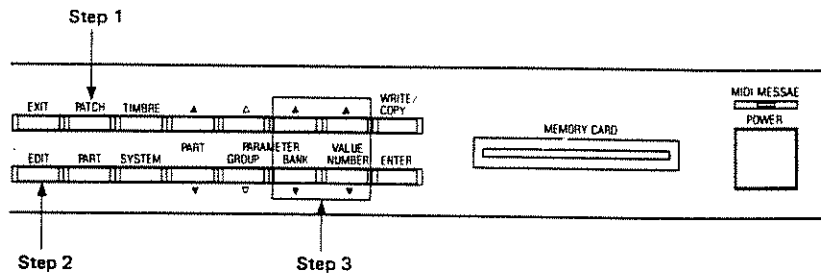

Step 1 Push PATCH.

Step 2 Push EDIT.

The Display shows the Patch Name with the cursor under the first letter.

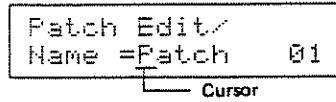

Step 3 Using the PARAMETER/BANK (▲▼), move the cursor under the letter which you wish to change, then rewrite the letter with VALUE/NUMBER (▲▼).

Set a desired value.

Pushing PARAMETER/BANK ▲ moves the cursor to the right and ▼ moves to the left.

The letters which can be written with VALUE/NUMBER (▲▼) are:

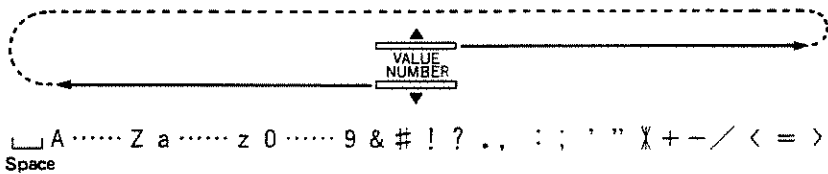

## 1. Patch Writing

A Patch you have made will be erased by selecting a different Patch. To retain the Patch, follow the Patch Writing procedure.

### [Patch Writing Procedure]

Turn the unit to the Patch Select or Patch Edit mode, then do as follows.

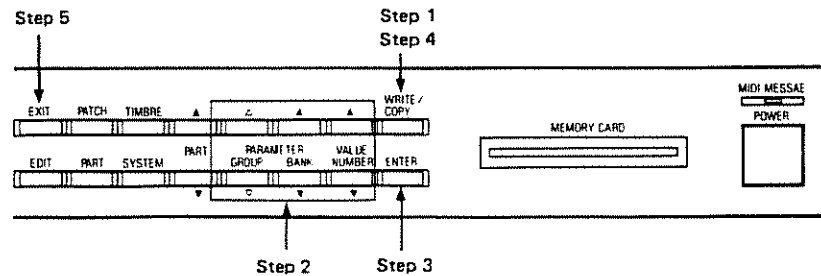

Step 1 Push WRITE/COPY button.

The Display shows the Patch Number currently selected.

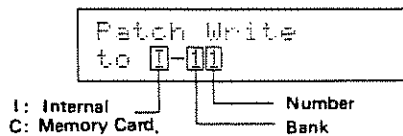

Step 2 Assign the destination Patch Number (= location) where you wish to write the source Patch. Assign a Internal/Memory Card with PARAMETER/GROUP (▲▼), a Bank with PARAMETER/BANK (▲▼) and a Number with VALUE/NUMBER (▲▼).

Step 3 Push ENTER.

The Display responds as below to confirm if the destination Patch Number is correct.

```

Patch Write
to I-11   Sure?
    
```

Step 4 If it is correct, push WRITE/COPY.

If the Memory Protect function is set to ON, the Display responds with:

```

Memory Protected
Turn off once ?
    
```

\* To leave the writing mode, push EXIT. The Display will return to its previous condition, before any writing procedure was taken.

When the Patch is written into memory, the Display shows as below for a while, then returns to its previous condition, before any writing procedure was taken.

```

Complete
    
```

Step 5 Push EXIT twice to return to the Play mode.

If you call a Patch you have written, the relevant Patch number will be shown at the position where a Timbre number is normally shown.

```

TIMB/Part1 P-I12
Tone =SlapBass 2
    
```

## 2. Patch Selection

[Patch Selection from the D-110]

Any of the 64 Patches in the internal memory, or another 64 on a memory card can be selected instantaneously.

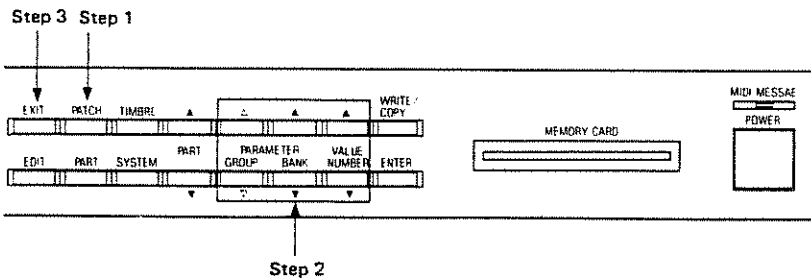

Step 1 Push PATCH.

The Display shows the Patch Number and Patch Name of the Patch currently selected. ...

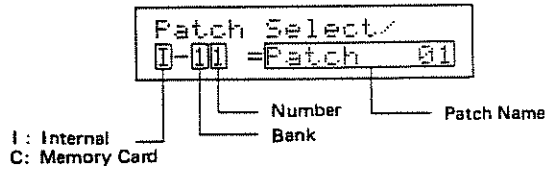

Step 2 Select the Internal or Memory Card mode with PARAMETER/GROUP (▽△), select a Bank with PARAMETER/BANK (▲▼), then select a Number with VALUE/NUMBER (▲▼).

Step 3 Push EXIT to return to the Play mode.

[Changing Patches with Program Change messages]

You can also change Patches with Program Change messages sent from an external controller unit. Program Change messages for Patch selection are received on the Control channel.

● Setting the Control Channel

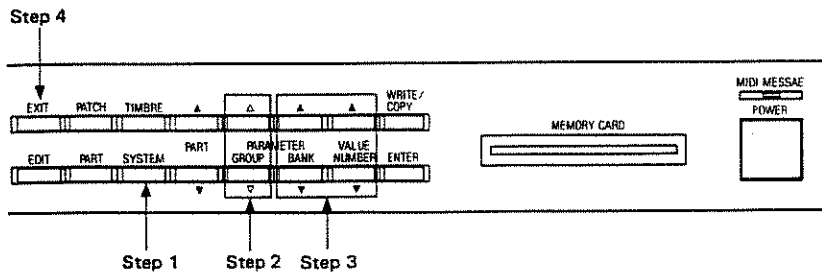

Step 1 Push SYSTEM.

Step 2 Select PARAMETER/GROUP (▽△) twice to call the Control Channel Display.

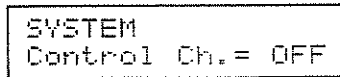

Step 3 Set the Control Channel with PARAMETER/BANK (▲▼) and VALUE/NUMBER (▲▼).

1 to 16, and OFF are valid for a Control Channel number. At OFF, Program Change messages for Patch selection are not received.

Step 4 Push EXIT to return to the Play mode.

\* The Control Channel you have set will be retained in memory even after unit is switched off.

Program Change numbers correspond to the Patch Numbers as shown below.

	Bank	Number							
		1	2	3	4	5	6	7	8
<b>Internal</b>	1	1	2	3	4	5	6	7	8
	2	9	10	11	12	13	14	15	16
	3	17	18	19	20	21	22	23	24
	4	25	26	27	28	29	30	31	32
	5	33	34	35	36	37	38	39	40
	6	41	42	43	44	45	46	47	48
	7	49	50	51	52	53	54	55	56
	8	57	58	59	60	61	62	63	64
<b>Memory Card</b>	1	65	66	67	68	69	70	71	72
	2	73	74	75	76	77	78	79	80
	3	81	82	83	84	85	86	87	88
	4	89	90	91	92	93	94	95	96
	5	97	98	99	100	101	102	103	104
	6	105	106	107	108	109	110	111	112
	7	113	114	115	116	117	118	119	120
	8	121	122	123	124	125	126	127	128

\* 0 to 127 Program Change messages are transmitted.

\* If a MIDI channel set in a Part (1 – 8) is same as the Control channel, a Patch will be changed after receiving Program Change message of the MIDI channel.





# ADVANCED COURSE

- 1 BASIC PROCEDURES
- 2 PATCH EDITING
- 3 TIMBRE EDITING
- 4 TONE EDITING
- 5 PART SETTING
- 6 WRITING
- 7 RHYTHM SETUP
- 8 SYSTEM SETUP
- 9 DATA TRANSFER
- 10 ROM PLAY

# 1 BASIC PROCEDURES

## 1. Basic Procedure for Editing Parameters

The D-110 has several modes and a great many parameters, offering sound synthesis and various effects using the Multi Timbral function. To edit a parameter, you should turn the unit to the appropriate mode for the each parameter.

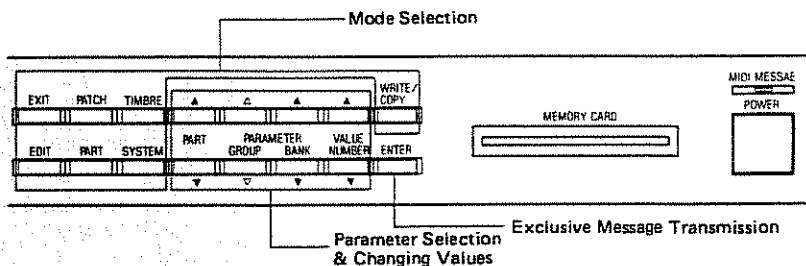

The following shows how the relevant buttons work in each mode.

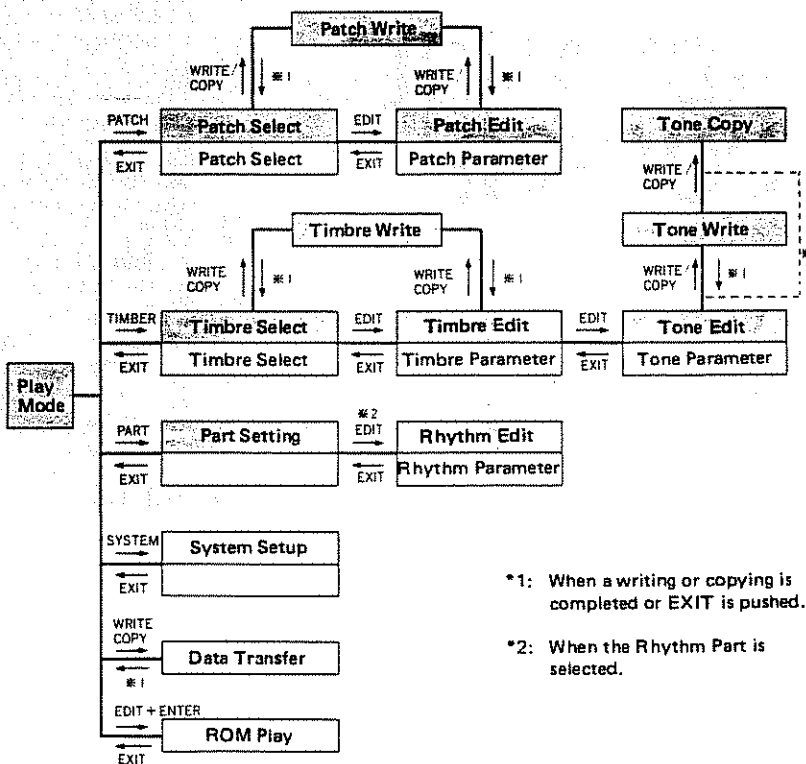

- \*1: When a writing or copying is completed or EXIT is pushed.
- \*2: When the Rhythm Part is selected.

\* If you cannot remember which mode you are in, push EXIT until the unit returns to the Play mode.

Depending on which mode is currently selected, the PART (▲▼), PARAMETER/ GROUP (▽△), PARAMETER/BANK (▲▼) and VALUE/NUMBER (▲▼) buttons function differently.

	PART ▲▼	PARAMETER		VALUE/ NUMBER ▲▼
		GROUP ▽△	BANK ▲▼	
Play Mode	Part Select			
Patch Select	-----	Group Select	Bank Select	Number Select
Patch Edit Patch Name Reverb	Part Select Part Select	Parameter Select Parameter Select	Cursor Movement Value Change (x2)	Value Change Value Change
Patch Write	-----	Group Select	Bank Select	Number Select
Timbre Select	Part Select	Group Select	Bank Select	Number Select
Timbre Edit Tone Key Shift Fine Tune Bender Range Assign Mode Output Assign	Part Select Part Select Part Select Part Select Part Select Part Select	Parameter Select Parameter Select Parameter Select Parameter Select Parameter Select	Tone Group Select Value Change (X12) Value Change (X10) Value Change (X12) Value Change (X 2) Value Change (X 2)	Tone Number Select Value Change Value Change Value Change Value Change Value Change
Timbre Write	-----	Group Select	Bank Select	Number Select
Tone Edit Common Name Structure Partial Mute Envelope Mode Partial Parameter	Parameter Block Select Parameter Block Select Parameter Block Select Parameter Block Select Parameter Block Select	Parameter Select Parameter Select Parameter Select Parameter Select Parameter Group Select	Cursor Movement Value Change (X10) Cursor Movement Value Change Parameter Select	Character Select Value Change Value Change Value Change Value Change
Tone Write	-----	-----	Tone Group Select	Tone Number Select
Copy Tone Copy Partial	Part Select Part Select	----- Partial Select	----- -----	----- -----
Part Setting Output Level Pan Key Range MIDI Channel Partial Reserve	Part Select Part Select Part Select Part Select Part Select	Parameter Select Parameter Select Parameter Select Parameter Select Parameter Select	Value Change (X10) Value Change (X 7) Value Change (X12) Value Change (X 2) Value Change (X 2)	Value Change Value Change Value Change Value Change Value Change
Rhythm Setup Tone Output Level Pan Output Assign	Note Name Select Note Name Select Note Name Select Note Name Select	Parameter Select Parameter Select Parameter Select Parameter Select	Tone Group Select Value Change (X10) Value Change (X 7) Value Change (X 2)	Tone Number Select Value Change Value Change Value Change
System Setup Master Tune Memory Protect Control Channel Exclusive Unit Number Overflow Assign Switch	----- ----- ----- ----- -----	Parameter Select Parameter Select Parameter Select Parameter Select Parameter Select	Value Change (X10) Value Change Value Change (X 2) Value Change (X 2) Value Change	Value Change Value Change Value Change Value Change Value Change
Data Transfer	-----	Function Select	Data Select	-----
ROM Play	-----	-----	-----	Song Select

1

## 2. Memory

There are several different types of data, such as Patch, Timbre, Tone, etc. Each data unit consists of different things.

[Data which can be written in the internal memory or on a memory card]

The D-110's internal memory and a memory card (M-256D or M-128D) can store the following data.

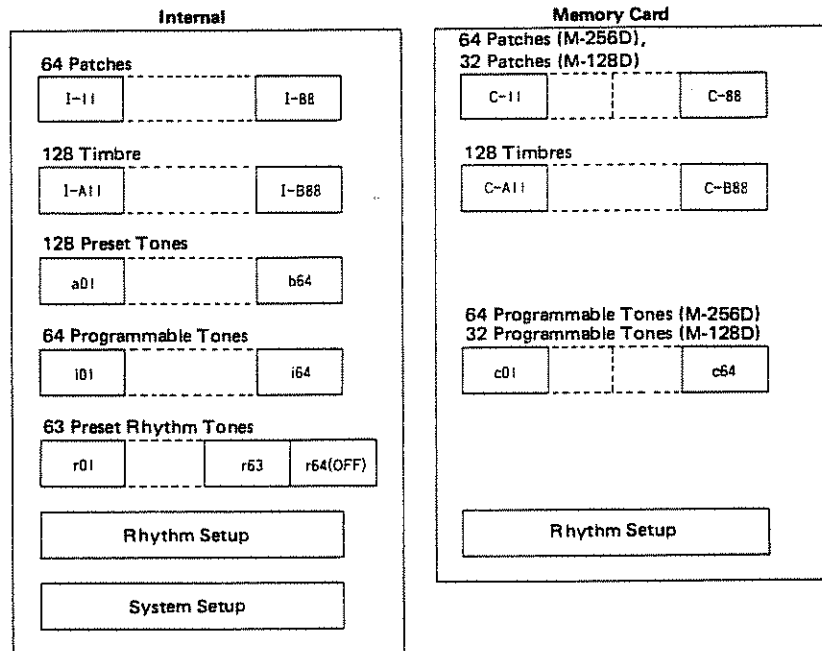

[What each unit consist of?]

- Tone
- Timbre

A Tone consists of Common and Partial blocks.

A Timbre consists of Timbre Parameters; Tone Select, Key Shift, Fine Tune, Bender Range, Assign Mode, Output Assign. In other words, a Timbre is made of Tones and performance controlling functions. A Timbre, however, does not contain a Tone itself.

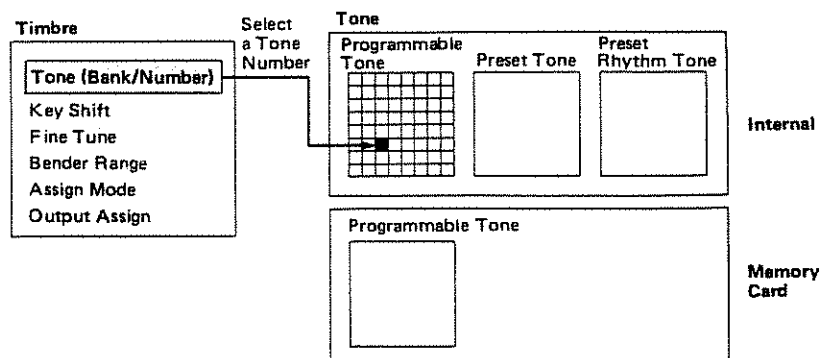

Tones which can be assigned to a Timbre are as follows:

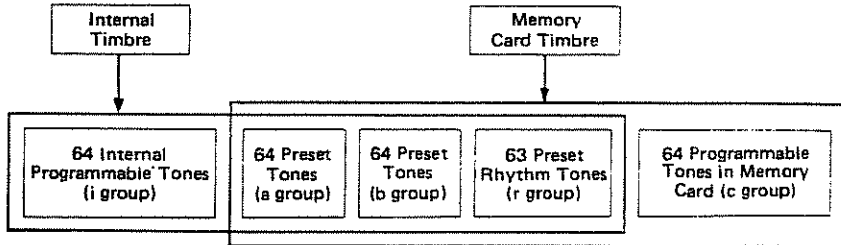

Preset Tones(a, b, or r group) can be assigned to the Timbres either the Internal or on a Memory Card, while Programmable Tones are assigned to the Timbres in the corresponding memory; a Programmable Tone in the Internal memory assigned to the Timbre in the Internal memory and that in a memory card to the Timbre in a memory card.

1

While you are writing a Timbre onto a memory card, if a Tone in the Internal memory(i group) is assigned to that Timbre, it will be automatically changed to a Tone in the Internal memory(c group).

• Patch

A patch consists of Patch Parameters;

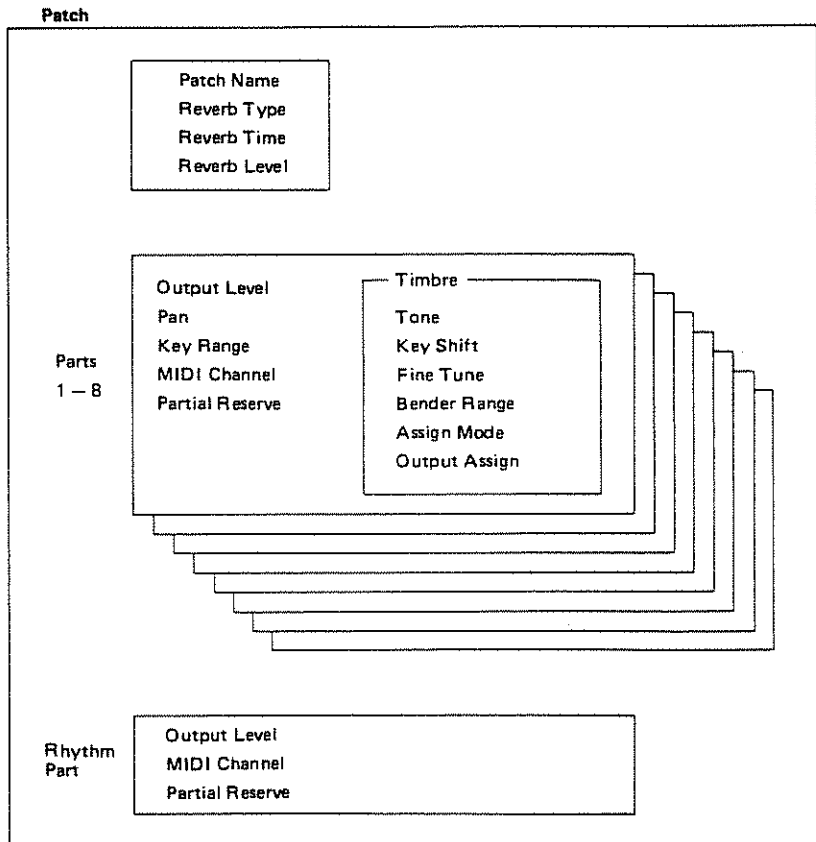

A Patch involves the contents of the Timbre assigned to each Part, but not number assignment. Therefore, if a different Timbre is selected with the Timbre Select parameter or Program Change messages, the data itself will be copied from the Timbre.

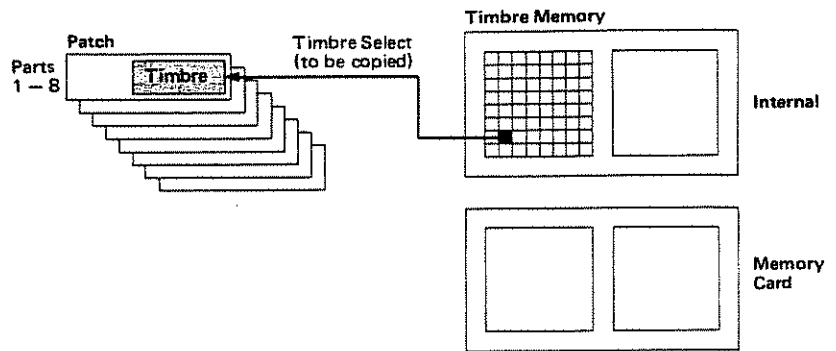

Therefore, the Patch Writing procedure can write the Timbre you have edited in a Patch, but not into a Timbre memory. To write it into a Timbre memory, you must take the Timbre Writing procedure.

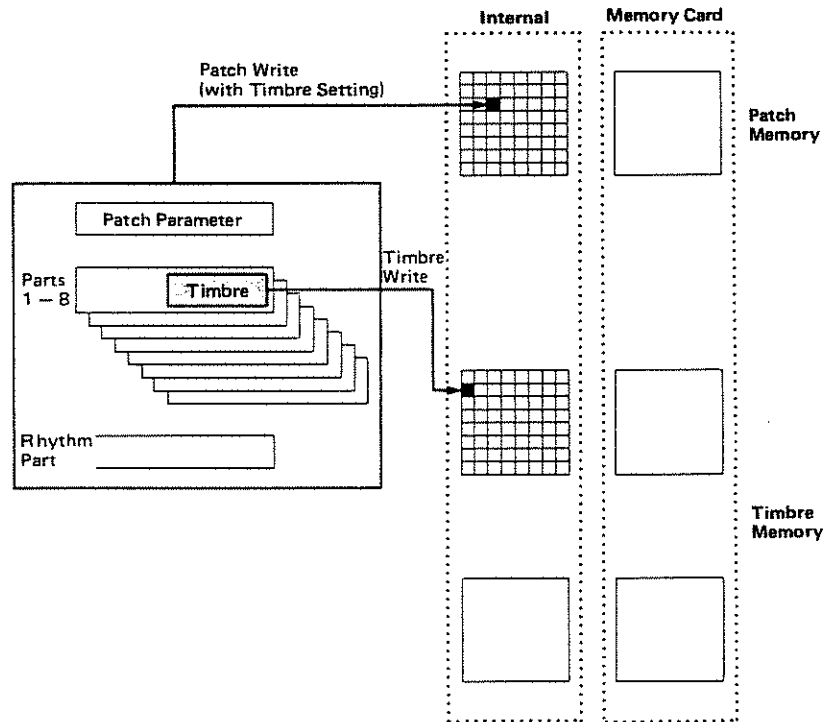

• Rhythm Setup

Each Key Number (24 – 108) of the Rhythm Part has parameters of Tone Select, Level, Pan and Output Assign. Each Key Number can use any of the 63 Preset Rhythm Tones or the user's programmable 64 Tones. Tone Numbers are written in the Rhythm Setup.

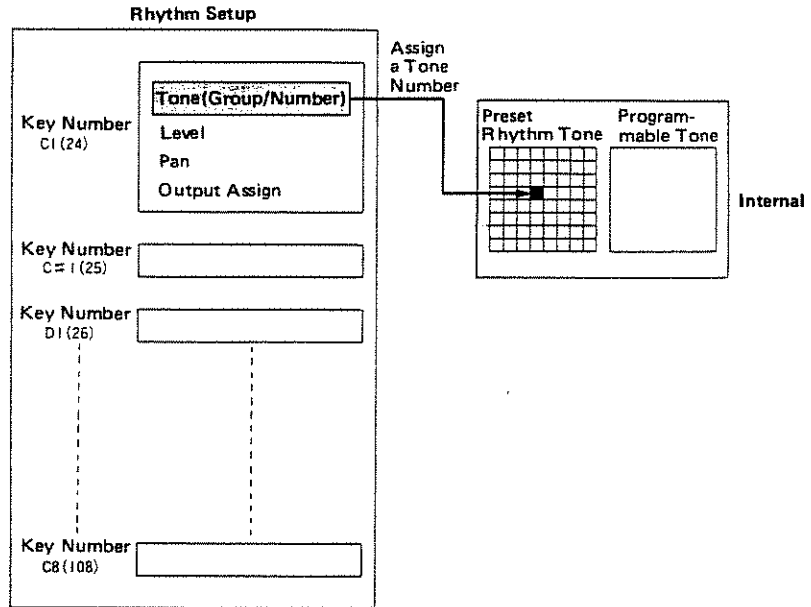

• System Setup

This consists of the Master Tune, Memory Protect, Control Channel, Exclusive Unit Number and Overflow Assign Switch parameters.

## 2 PATCH EDITING

Patch editing includes Patch name and Reverb settings.

Parameters for Patch Edit

Display	Parameter
Name	Patch Name
Reverb Type	Reverb Type
Reverb Time	Reverb Time
Reverb Level	Reverb Level

\* The editing procedure does not automatically rewrite the exiting data. The edited version will be erased by selecting a different Patch. If you wish to retain the data, take an appropriate Patch Writing procedure. (See page 71.)

### 1. Editing Procedure

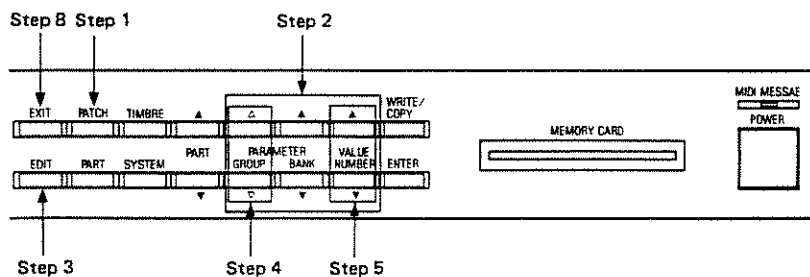

- Step 1 Push PATCH.
- Step 2 Select the Patch to be edited with PARAMETER/GROUP (  $\Delta \nabla$  ), PARAMETER/BANK (  $\blacktriangle \blacktriangledown$  ) and VALUE/NUMBER (  $\blacktriangle \blacktriangledown$  ).
- Step 3 Push EDIT.
- Step 4 Select the parameter to be changed with PARAMETER/GROUP (  $\Delta \nabla$  ).
- Step 5 Set the value of the parameter with VALUE/NUMBER (  $\blacktriangle \blacktriangledown$  ).
- Step 6 Repeat Steps 4 and 5.
- Step 7 If you wish to write your edited version, take the Patch Writing procedure (on page 71).
- Step 8 When finished, push EXIT twice to return to the Play mode.

\* Pushing EXIT once will retrieve the Patch Select Display.



## 2. Patch Parameters

- Patch Name

A Patch can be named using 10 letters. Call the Patch Name Display, and the Patch Name currently selected appears with the cursor under the first letter.

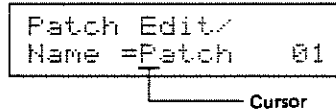

Move the cursor to the desired position with PARAMETER/BANK (▲▼), then rewrite the letter with VALUE/NUMBER (▲▼). The available letters for a Patch Name are shown below.

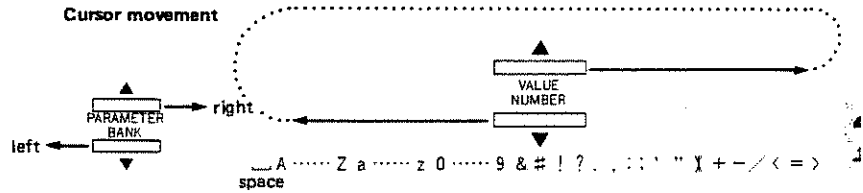

- Reverb Type

This selects one of the basic Reverb Types shown below.

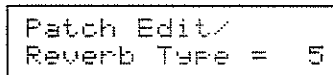

Number	Reverb Type
1	Small Room
2	Medium Room
3	Medium Hall
4	Large Hall
5	Plate
6	Delay 1
7	Delay 2
8	Delay 3
OFF	No Reverb

- Reverb Time

This sets the reverberation time. 1 to 8 are valid, higher values making longer reverb times.

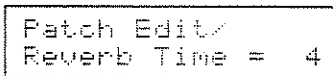

- Reverb Level

This sets the level of reverb sound. 0 to 7 are valid, higher values increasing the level.

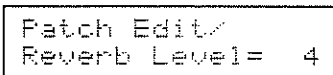

### 3 TIMBRE EDITING

The Timbre editing procedure sets Tones to be assigned to a Timbre, the Bender Range, Output Assign, etc.

Parameters for Timbre Edit

Display	Parameter
Tone	Tone (Group/Number)
Key Shift	Key Shift
Fine Tune	Fine Tune
Bender Range	Bender Range
Assign Mode	Assign Mode
Output Assign	Output Assign

\* The edited data will be erased by selecting a different Patch or Timbre. To retain it in memory, take the Patch Writing or Timbre Writing procedure. (See page 71, 73)

#### 1. Timbre Editing Procedure

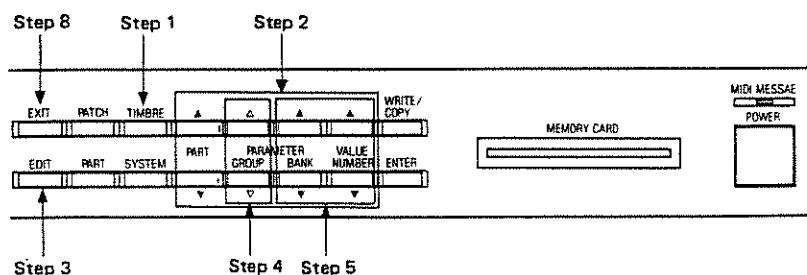

Step 1 Push TIMBRE.

Step 2 Call the Timbre to be edited.

To edit a Timbre currently assigned to a Part, select that Part using PART ( ▲▼ ).  
To edit a Timbre which is not assigned to any Part, use any Part.

Step 3 Push EDIT.

Step 4 Select the parameter you wish to edit with PARAMETER/GROUP ( ▼△ ).

Step 5 Change the value with PARAMETER/BANK ( ▲▼ ) and VALUE/NUMBER ( ▲▼ ).

\* Pushing PARAMETER/BANK ( ▲▼ ) changes the number in steps of 10.

Step 6 Repeat Steps 4 and 5.

- Step 7 To write you edited version, take the Timbre Writing or Patch Writing procedure.
- Step 8 When finished, push EDIT twice to return to the Play mode.
  - \* Pushing EXIT once will retrieve the Timbre Select Display.

## 2. Timbre Parameters

- **Tone Select**

This select Tones to be assigned to a Timbre. A Tone is represented with a Group, and Number. Assign a Group with PARAMETER/BANK (▲▼), and assign a Number with VALUE/NUMBER (▲▼).

Depending on the type of Timbre which is being edited now, the available Tones differ as shown below.

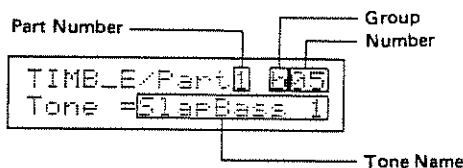

Internal Timbres		Memory Cord Timbres	
r	Preset Rhythm Tones	r	Preset Rhythm Tones
i	Programmable Tones	c	Memory Card Tones
b	Preset Tones b	b	Preset Tones b
a	Preset Tones a	a	Preset Tones a

\* Preset Rhythm Tones are 01 – 63 and OFF.  
At OFF, no sound is produced.

- **Key Shift**

The pitch of the Tone can be set from -24 to +24 (±2 octaves) in semi-tone steps.

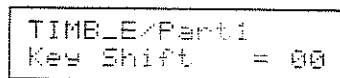

- **Fine Tune**

The pitch of a Tone can be finely changed from -50 to +50 (±50 cents).

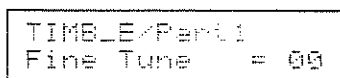

- **Bender Range**

This sets the variable range of the pitch change caused by moving the Bender Lever right and left, from 0 to 24 (2 octaves) in semi-tone steps.

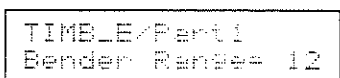

• **Assign Mode**

Assign Mode refers to how each Tone should be played by the Key messages received.

```

TIMBLE/Part1
Assign Mode = 1
    
```

- 1: Single Assign – Played with Last Note Priority
- 2: Single Assign – Played with First Note Priority
- 3: Multi Assign – Played with Last Note Priority
- 4: Multi Assign – Played with First Note Priority

[Single Assign and Multi Assign]

- **SINGLE ASSIGN**  
In this mode, when more than one Key ON message is received by the same Key Number on the same MIDI channel, the sound of that key is muted once, then played again.
- **MULTI ASSIGN**  
In this mode, when more than one Key ON message is received by the same Key Number on the same MIDI channel, the two sounds are mixed.

[Last Note Priority and First Note Priority]

- **LAST NOTE PRIORITY**  
In this mode, when the D-110 has received more Key ON message than the maximum of voices, the earlier messages are replaced by the later ones.
- **FIRST NOTE PRIORITY**  
In this mode, when the D-110 receives more Key ON messages than the maximum of voices, the later messages are ignored, retaining the currently playing sounds.

• **Output Assign**

This sets the Output Socket through which each Timber sound (output of each Part) should be sent. By using the Multi Output Sockets, it is possible to add effects to particular Timbres, or to achieve a higher grade of mixing using an external mixer.

```

TIMBLE/Part1
OutputAssign=MIX
    
```

- \* When the Reverb Type in Patch Parameters is set to other than OFF, Multi Outputs 5 and 6 cannot be used. (You can set the parameter, but the signal is not sent to the output.)
- \* The Timbres sent through the Direct Output Sockets do not take on reverb effects.

# 4 TONE EDITING

The general concept of synthesizers and sound synthesis are explained in "LA Synthesis" on page 90. Please read it together with this section.

## 1. The Basic Concept of a Tone

[Partial and Structure]

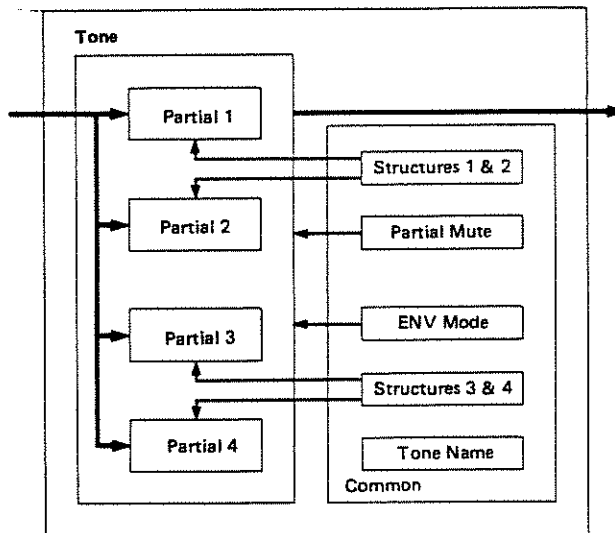

A Tone consists of a PARTIAL block and a common block. The Partials are combined in pairs, and two sets of pairs form a Tone. An important COMMON Parameter called "Structure" decides how two of the four Partials should be combined or which sound generator is used, a synthesizer voice or a PCM voice.

[Functions of the Structure]

1) Selects a sound generator to be used for each Partial

- Synthesizer Sound Generator
- PCM Sound Generator

The Structure selects which of the two sound generators, a synthesizer sound generator or a PCM sound generator should be used for each Partial.

This synthesizer behaves like a conventional analog synthesizer.

This behaves like a PCM sampled synthesizer.

2) Determines how to combine two Partials

There are four different ways to combine Partials:

Mixing two Partials

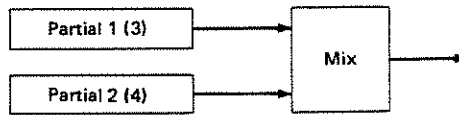

Sending two Partial sounds in stereo. However, if sending sounds through Multi Output Sockets or using this setting for Patches or via the monaural output, this will have exactly the same effect as above "Mixing two Partials".

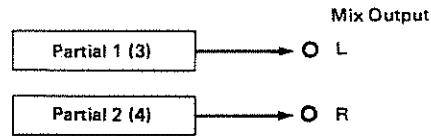

Partial 1 (or 3) is mixed with the ring modulated sound of two Partials (including Partial 1 or 3).

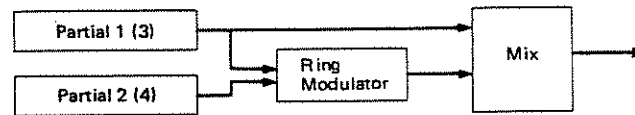

Two Partials are ring-modulated and sent out.

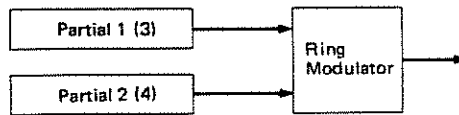

[Ring Modulator]

The Ring Modulator can be effectively used for creating metallic sounds, since it can increase harmonics by multiplying those of two Partials.

[Partials]

Depending on which generators are selected in the Partial Block, greatly different parameters will be used. Some parameters used for the synthesizer sound generators are irrelevant to the PCM generator.

See the diagram below.

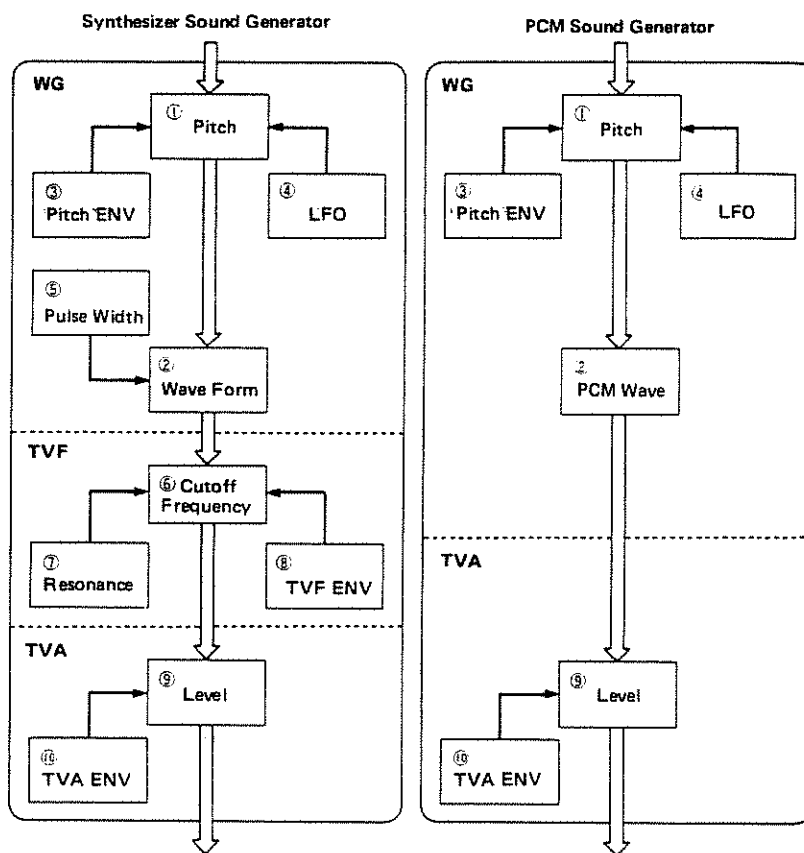

• **WG (Wave Generator)**

In the WG (Wave Generator), the pitch and waveform are controlled.

- ① **Pitch**  
The standard pitch of a Partial (sound generator) at C4 key (= middle C) can be set here.
- ② **Waveform/PCM Wave Number**  
This selects the waveform of the sound source.
- ③ **Pitch ENV**  
This controls an envelope curve of the pitch changes caused by Key On/Off.
- ④ **LFO (Low Frequency Oscillator)**  
LFO controls the vibrato.
- ⑤ **Pulse Width**  
This changes the waveform of the sound source.

● TVF (Time Variant Filter)

This filter passes lower frequency harmonics and cuts off the higher ones. By changing the cutoff point and the resonance, the waveform changes.

⑥ Cutoff Frequency

This sets the cutoff point.

⑦ Resonance

This emphasizes the cutoff point, making more unusual or electronic sounds.

⑧ TVF ENV

This controls an envelope curve affecting the cutoff point changes caused by Key On/Off.

● TVA (Time Variant Amplifier)

This controls the volume of the Partial.

⑨ Level

This determines the volume of the sound.

⑩ TVA ENV

This controls an envelope curve of the level changes caused by Key On/Off.

\* When a Partial is using a PCM sound generator, the Pulse Width and the parameters in the TVF have no effect.

## 2. Editing Procedure

\* The editing procedure does not automatically rewrite the existing Tone, and therefore will be erased by selecting a different Patch, Timber or Tone. To write the edited Tone in memory, take the Tone Writing procedure on page 75.

### [Selecting a Tone]

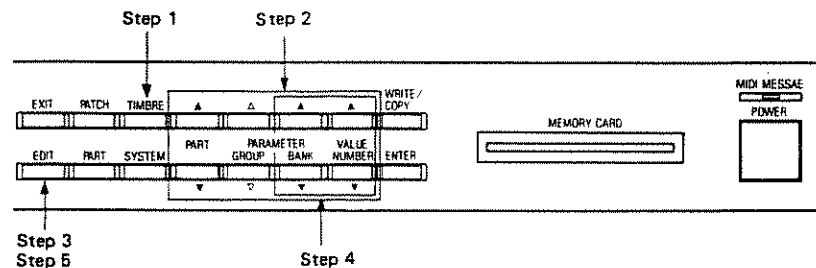

Step 1 Push TIMBRE.

Step 2 Select the Timbre that contains the Tone to be edited.

To select a Timbre which is assigned to any Part, assign that Part with the Part Select Button. To select a Timbre which is not assigned to any Part, you can use any Part.

Step 3 Push EDIT.



This calls the Tone Select Display in Timbre Edit.

```
TIMBLE/Part1 b05
Tone =SlapBass 1
```

Step 4 Select the Tone to be edited with PARAMETER/BANK (▲▼) and VALUE/NUMBER (▲▼).

Step 5 Push EDIT. This turns the unit to the Tone edit mode and selects the Tone Name Display.

```
Tone Edit/Common
Name =SlapBass 1
```

Go to the next section "Editing a Tone Parameter".

[Editing a Tone Parameter]

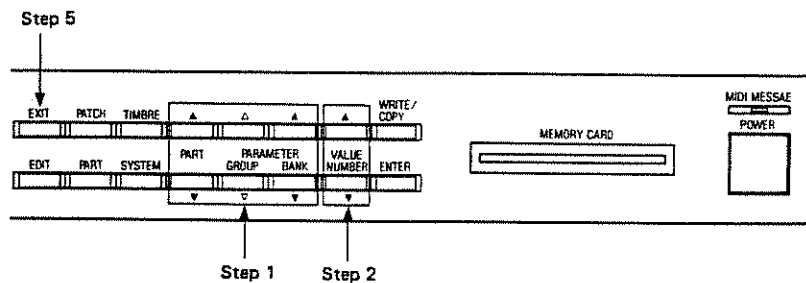

Step 1 A Tone is represented with a Block (COMMON, PARTIALS 1 to 4) and a Group and a Parameter. First, select the Block with PART (▲▼), then the Group with PARAMETER/GROUP (▽△), then a Parameter with PARAMETER/BANK (▲▼).

\* Common parameters have no Group division. So after selecting the Common Block, assign the Parameter Number with PARAMETER/GROUP (▽△).

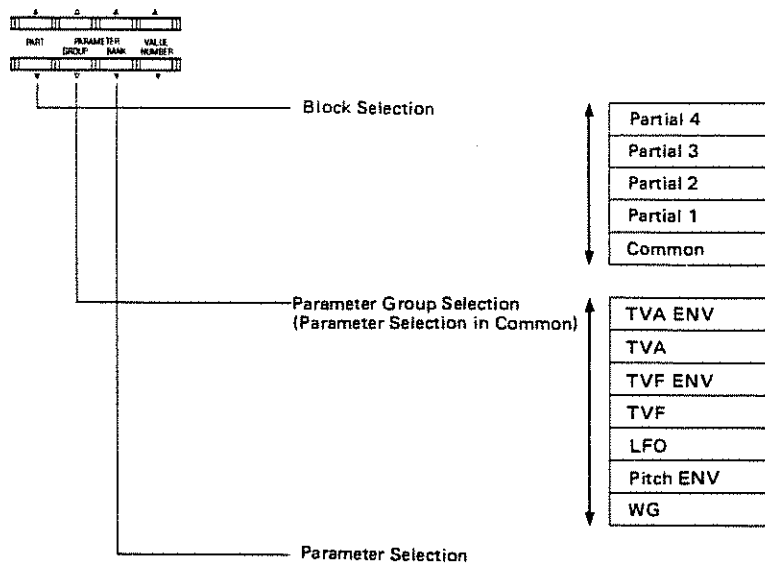

- Step 2 Change the value with VALUE/NUMBER ( ▲▼ ).
- Step 3 Repeat Steps 1 and 2.
- Step 4 If you wish to write the edited Tone, follow the Tone Writing procedure on page 75.
- Step 5 When finished, push EXIT three times to return to the Play mode.

\* Pushing EXIT twice will retrieve the Timbre Select Display.

Block	Parameter Group	Parameter	Display
Common	Common Group	Tone Name	Name
		Structures 1&2	Structure 1&2
		Structures 3&4	Structure 3&4
		Partial Mute	Partial Mute
		ENV Mode	ENV Mode
Partials 1, 2, 3, 4	WG Group	Pitch Coarse	WG Pitch Cars
		Pitch Fine	WG Pitch Fine
		Key Follow (Pitch)	WG Pitch KF
		Bender Switch	WG Bender SW
		Waveform	WG Waveform
		PCM Wave Bank	PCM Bank
		PCM Wave Number	PCM
		Pulse Width	WG Puls Width
		Velocity Sensitivity (Pulse Width)	WG PW Velo
		Pitch ENV Group	Pitch ENV Depth
	Velocity Sensitivity (Depth)		P-ENV Velo
	Key Follow (Time)		P-ENV Time KF
	Time 1/2/3/4		P-ENV T1(.4)
	Level 0/1/2		P-ENV LO(.2)
	Sustain Level		P-ENV Sus L
	End Level		P-ENV End L
	LFO Group	Rate	P-LFO Rate
		Depth	P-LFO Depth
		Moduration Sensitivity	P-LFO Mod
	TVF Group	Frequency	TVF Freq
		Resonance	TVF Reso
		Key Follow (Frequency)	TVF Freq KF
		Bias Point	TVF Bias P
		Bias Level	TVF Bias Lvl
	TVF ENV Group	ENV Depth	TVF-ENV Dept
		Velocity Sensitivity (Depth)	TVF-ENV Velo
		Key Follow (Depth)	TVF-ENV DKF
		Key Follow (Time)	TVF-ENV TKF
		Time 1/2/3/4/5	TVF-ENV T1(.5)
		Level 1/2/3	TVF-ENV L1(.3)
		Sustain Level	TVF-ENV Sus L
	TVA Group	Level	TVA Level
		Velocity Sensitivity	TVA Velocity
		Bias Point 1/2	TVA Bias P1(2)
		Bias Level 1/2	TVA Bias L1(2)
	TVA ENV Group	Key Follow (Time)	TVA-ENV TKF
		Velocity Follow (Time 1)	TVA-ENV T1VF
		Time 1/2/3/4/5	TVA-ENV T1(.5)
		Level 1/2/3	TVA-ENV L1(.3)
		Sustain Level	TVA-ENV Sus L

### 3. Copying a Tone or Partial

A Tone or Partial which is currently assigned to a Part (1 –8) can be copied, so that editing will be easier and quicker.

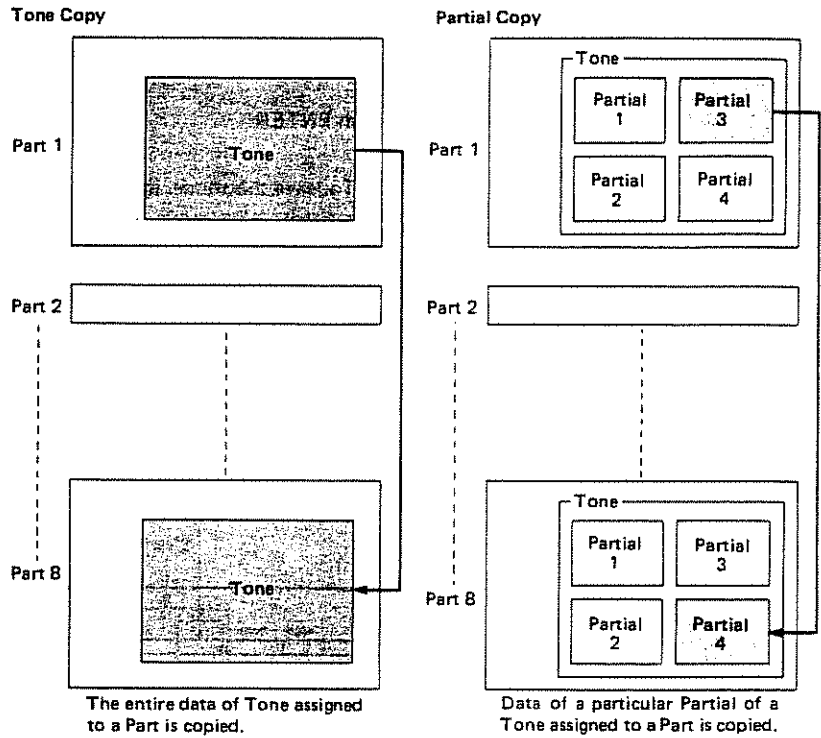

#### [Tone Copy]

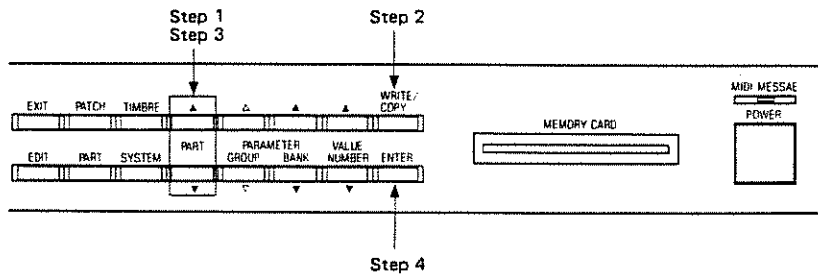

Step 1 With the unit turned to the Tone Edit mode, call the Common Display with PART (▲▼).

If the unit has not been in the Tone Edit mode, return to the Play mode, then enter the Tone Edit mode by pushing TIMBRE, EDIT, then EDIT.

Step 2 Push WRITE/COPY twice.

The Display responds with:

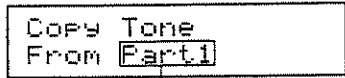

Part where the source Tone is assigned

Step 3 Using PART ( ▲▼ ), call the Part where the source Tone is assigned.

Step 4 Push ENTER.

\* To leave this mode, push EXIT. The unit will return to the Tone Edit mode.

When copying is completed, the following will be shown for a while then the screen returns to the previous Display, before any copying procedure was taken.

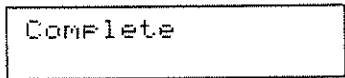

[Partial Copy]

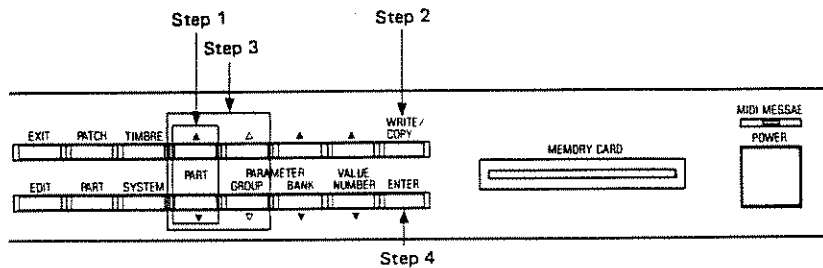

Step 1 With the unit turned to the Tone Edit mode, call the destination Partial with PART ( ▲▼ ).

If the unit has not been in the Tone Edit mode, return to the Play mode, then enter the Tone Edit mode by pushing TIMBRE, EDIT, then EDIT.

Step 2 Push WRITE/COPY twice.

The Display responds with:

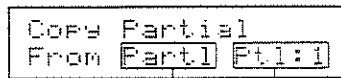

Partial to be copied  
Part where the source Tone is assigned

Step 3 Using PART ( ▲▼ ), call the Part where the source Tone is assigned, then call the Partial with PARAMETER/GROUP ( ▼△ ).

Step 4 Push ENTER.

\* To leave this mode, push EXIT. The unit will return to the Tone Edit mode.

When copying is completed, the following will be shown for a while then the screen returns to the previous Display, before any copying procedure was taken.

Complete

## 4. Tone Parameters

Some parameters included in a Partial that uses a PCM sound generator are invalid. The following mark is shown when the parameters apply even for PCM sounds.

PCM

### [Common Parameters]

- Tone Name PCM

A Tone can be named using up to 10 letters. Move the cursor to the letter to be changed with PARAMETER/BANK (▲▼), then change letters with VALUE NUMBER (▲▼). The available letters for naming are as shown below.

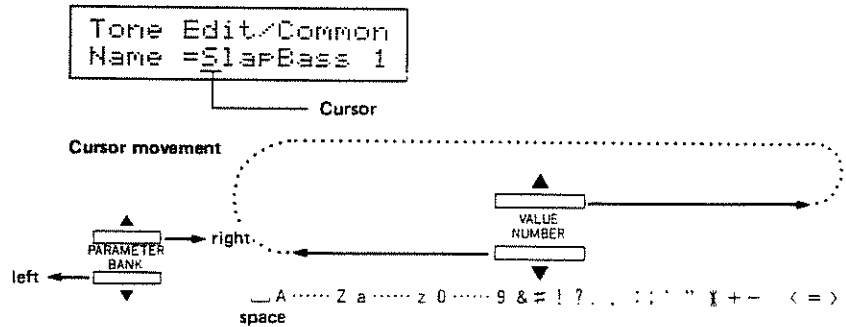

- Structure 1 & 2/3 & 4 **PCM**

Tone Edit/Common  
Structure 1&2=03

Tone Edit/Common  
Structure 3&4=05

Select one of the following 13 Structures to be used for Structure 1, 2 or 3, 4.

S = Synthesizer Sound Generator  
P = PCM Sound Generator  
**R** = Ring Modulator

Structure Number	Partial 1 (3)	Partial 2 (4)	Partial Combination	Block Diagram
1	S	S	Mixture of Partial 1 (or 3) and Partial 2 (or 4).	
2	S	S	Mixture of Partial 1 (or 3) and ring-modulation.	
3	P	S	Mixture of Partial 1 (or 3) and Partial 2 (or 4).	
4	P	S	Mixture of Partial 1 (or 3) and ring-modulation.	
5	S	P	Mixture of Partial 1 (or 3) and ring-modulation.	
6	P	P	Mixture of Partial 1 (or 3) and Partial 2 (or 4).	
7	P	P	Mixture of Partial 1 (or 3) and ring-modulation.	
8	S	S	Partial 1 (or 3) and Partial 2 (or 4) are output in stereo.	
9	P	P	Partial 1 (or 3) and Partial 2 (or 4) are output in stereo.	
10	S	S	Partial 1 (or 3) and Partial 2 (or 4) are ring-modulated then output.	
11	P	S	Partial 1 (or 3) and Partial 2 (or 4) are ring-modulated then Output.	
12	S	P	Partial 1 (or 3) and Partial 2 (or 4) are ring-modulated then output.	
13	P	P	Partial 1 (or 3) and Partial 2 (or 4) are ring-modulated then output.	

\* Structure 8 or 9 will output the sound of each Partial separately from the relevant Output Socket (this applies only to stereo output through the Mix Output Sockets).

- Partial Mute **PCM**

While editing a Partial parameter, any Partial sound can be muted, for you to listen to only the Partial you want. The Partial Mute, which is also one of the Tone parameters, can be written into memory.

Move the cursor with PARAMETER/BANK (▲▼) to select the Partial to be muted, then mute it with VALUE/NUMBER (▲▼). "1" means the partial will sound, and "0" is mute.

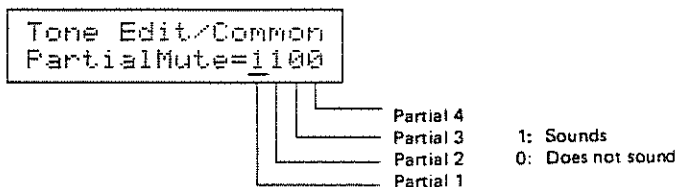

- \* Parameters of the Partial currently muted can be edited just the same.
- \* Partial Mute decreases the number of Partials which are to be used, and therefore increases the number of voices.

• ENV Mode **PCM**

This selects whether to receive or ignore the Key Off messages in the ENV of each Partial. Normally, this should be set to NORMAL, but set to NO SUSTAIN for programming a Rhythm Tone.

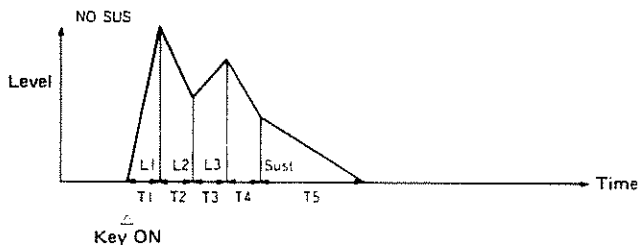
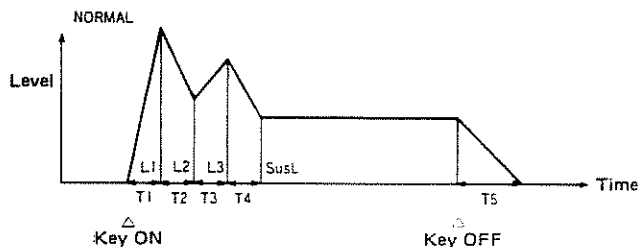
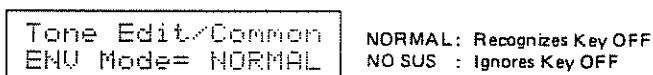

[WG Group]

• Pitch Coarse **PCM**

This sets the standard pitch of a Partial in semi-tone steps from C1 to C9.

- \* The standard pitch is the pitch played by receiving C4 (middle C) key messages.

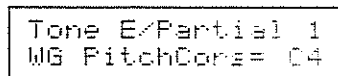

• Pitch Fine **PCM**

The standard pitch can be altered over about ±50 cents from -50 to +50.

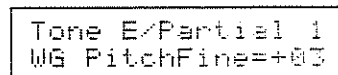

- \* When either of the Partial sound is muted while using the Ring Modulator, the other Partial sound is output directly (without the Ring Modulator).

• Key Follow (Pitch) **PCM**

This parameter can change the pitch ratio in semi-tone steps, corresponding to the chromatic scale used in conventional electronic musical instrument (e.g. synthesizer).

```
Tone E/Partial 1
WG Pitch KF= s2
```

A value represents how many octaves are changed over 12 keys.

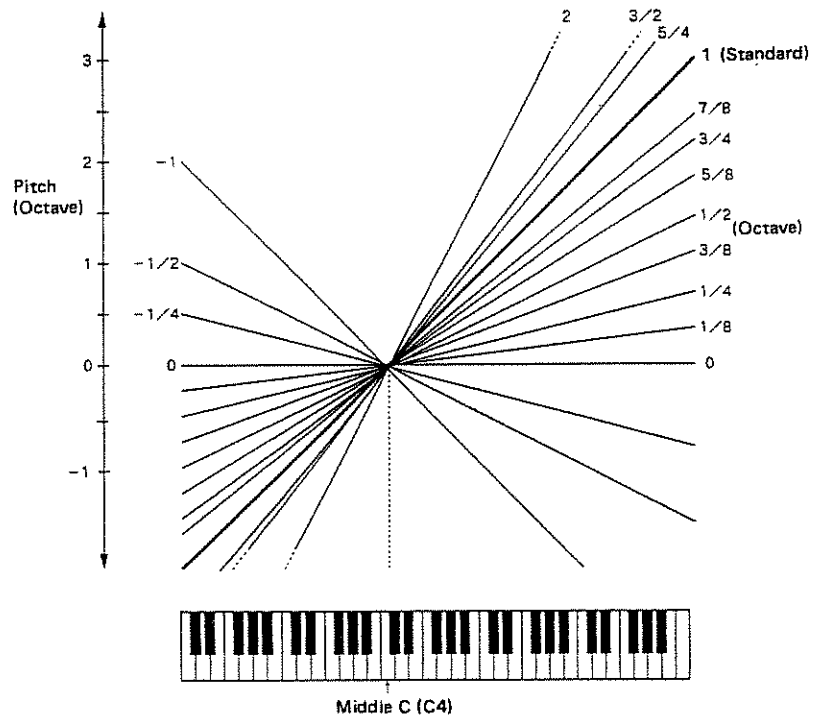

\* s1 or s2 may be selected for slightly stretching octaves.

s1: Pitch 1 cent higher than one octave.

s2: Pitch 5 cents higher than one octave.

• Bender Switch **PCM**

This selects whether to control the pitch by the bender lever (ON) or not (OFF).

```
Tone E/Partial 1
WG Bender SW= ON
```

• Waveform

This selects a waveform of the synthesizer sound generator.

```
Tone E/Partial 1
WG Waveform =SQU
```

Display	Waveform
SQU (Square)	
SAW (Sawtooth)	



\* A sawtooth waveform is produced by processing a square waveform at the TVF, consequently, even a sawtooth waveform can be controlled with the Pulse Width.

● PCM Wave Bank/Number **PCM**

This selects one of the 256 different sampled waves (128 waves in each Bank 1 or 2) of the PCM sound generator. Each sample is named (PCM name) as shown in the following table.

Tone E/Partial 1  
PCM Bank = 1

Tone E/Partial 1  
PCM=059:FullBass

[Bank 1]

No.	PCM Name	Remarks	No.	PCM Name	Remarks
001	Bass Drum-1	Rhythm Sound	065	Steel Guitar	Sustained Sound
002	Bass Drum-2		066	Dirty Guitar	
003	Bass Drum-3		067	Pizzicato	
004	Snare Drum-1		068	Harp	
005	Snare Drum-2		069	Contrabass	
006	Snare Drum-3		070	Cello	
007	Snare Drum-4		071	Violin-1	
008	Tom Tom-1		072	Violin-2	
009	Tom Tom-2		073	Koto	
010	High-Hat		074	Drawbars (Loop)	
011	High-Hat (Loop)		075	High Organ (Loop)	
012	Crash Cymbal-1		076	Low Organ (Loop)	
013	Crash Cymbal-2 (Loop)		077	Trumpet (Loop)	
014	Ride Cymbal-1		078	Trombone (Loop)	
015	Ride Cymbal-2 (Loop)		079	Sax-1 (Loop)	
016	Cup		080	Sax-2 (Loop)	
017	China Cymbal-1		081	Reed (Loop)	
018	China Cymbal-2 (Loop)		082	Slap Bass (Loop)	
019	Rm Shot		083	Acoustic Bass (Loop)	
020	Hand Clap		084	Electric Bass-1 (Loop)	
021	Mute High Gong	085	Electric Bass-2 (Loop)		
022	Conga	086	Gut Guitar (Loop)		
023	Bongo	087	Steel Guitar (Loop)		
024	Cowbell	088	Electric Guitar (Loop)		
025	Tambourne	089	Clav (Loop)		
026	Agogo	090	Cello (Loop)		
027	Claves	091	Violin (Loop)		
028	Timbale High	092	Electric Piano-1 (Loop)		
029	Timbale Low	093	Electric Piano-2 (Loop)		
030	Cbass	094	Harpischord-1 (Loop)		
031	Timpani Attack	095	Harpischord-2 (Loop)		
032	Timpani	096	Telephone Bell (Loop)		
033	Acoustic Piano High	097	Female Voice-1 (Loop)		
034	Acoustic Piano Low	098	Female Voice-2 (Loop)		
035	Piano Forte Thump	099	Male Voice-1 (Loop)		
036	Organ Percussion	100	Male Voice-2 (Loop)		
037	Trumpet	101	Spectrum-1 (Loop)		
038	Lips	102	Spectrum-2 (Loop)		
039	Trombone	103	Spectrum-3 (Loop)		
040	Clarinet	104	Spectrum-4 (Loop)		
041	Flute High	105	Spectrum-5 (Loop)		
042	Flute Low	106	Spectrum-6 (Loop)		
043	Steamer	107	Spectrum-7 (Loop)		
044	Indian Flute	108	Spectrum-8 (Loop)		
045	Breath	109	Spectrum-9 (Loop)		
046	Vibraphone High	110	Spectrum-10 (Loop)		
047	Vibraphone Low	111	Noise (Loop)		
048	Marmba	112	Shot-1	Decay Sound	
049	Xylophone High	113	Shot-2		
050	Xylophone Low	114	Shot-3		
051	Kalimba	115	Shot-4		
052	Wind Bell	116	Shot-5		
053	Chime Bar	117	Shot-6		
054	Hammer	118	Shot-7		
055	Guro	119	Shot-8		
056	Chrik	120	Shot-9		
057	Naks	121	Shot-10		
058	FreBass Bass	122	Shot-11		
059	Puf Bass	123	Shot-12		
060	Slap Bass	124	Shot-13		
061	Thump Bass	125	Shot-14		
062	Acoustic Bass	126	Shot-15		
063	Electric Bass	127	Shot-16		
064	Gut Guitar	128	Shot-17		

\* When a "Shot" of 112 to 128 in Bank 1 is selected, noise may be heard.

[Bank 2]

No.	PCM Name	Remarks	No.	PCM Name	Remarks
001	Bass Drum-1*	Rhythm Sound (The pitch is not affected by Master Tuning.)	065	Loop-35	Effect Sound (Repeats of combined sounds)
002	Bass Drum-2*		066	Loop-36	
003	Bass Drum-3*		067	Loop-37	
004	Snare Drum-1*		068	Loop-38	
005	Snare Drum-2*		069	Loop-39	
006	Snare Drum-3*		070	Loop-40	
007	Snare Drum-4*		071	Loop-41	
008	Tom Tom-1*		072	Loop-42	
009	Tom Tom-2*		073	Loop-43	
010	High-Hat*		074	Loop-44	
011	High-Hat*(Loop)		075	Loop-45	
012	Crash Cymbal-1*		076	Loop-46	
013	Crash Cymbal-2*(Loop)		077	Loop-47	
014	Ride Cymbal-1*		078	Loop-48	
015	Ride Cymbal-2*(Loop)		079	Loop-49	
016	Cup*		080	Loop-50	
017	China Cymbal-1*		081	Loop-51	
018	China Cymbal-2*(Loop)		082	Loop-52	
019	Rem Shot*		083	Loop-53	
020	Hand Clap*		084	Loop-54	
021	Mute High Conga*		085	Loop-55	
022	Conga*		086	Loop-56	
023	Bongo*		087	Loop-57	
024	Cowbell*		088	Loop-58	
025	Tambourne*		089	Loop-59	
026	Agogo*		090	Loop-60	
027	Cleaves*		091	Loop-61	
028	Timbale High*		092	Loop-62	
029	Timbale Low*		093	Loop-63	
030	Cabasa*		094	Loop-64	
031	Loop-1		095	Jam-1 (Loop)	
032	Loop-2	096	Jam-2 (Loop)		
033	Loop-3	097	Jam-3 (Loop)		
034	Loop-4	098	Jam-4 (Loop)		
035	Loop-5	099	Jam-5 (Loop)		
036	Loop-6	100	Jam-6 (Loop)		
037	Loop-7	101	Jam-7 (Loop)		
038	Loop-8	102	Jam-8 (Loop)		
039	Loop-9	103	Jam-9 (Loop)		
040	Loop-10	104	Jam-10 (Loop)		
041	Loop-11	105	Jam-11 (Loop)		
042	Loop-12	106	Jam-12 (Loop)		
043	Loop-13	107	Jam-13 (Loop)		
044	Loop-14	108	Jam-14 (Loop)		
045	Loop-15	109	Jam-15 (Loop)		
046	Loop-16	110	Jam-16 (Loop)		
047	Loop-17	111	Jam-17 (Loop)		
048	Loop-18	112	Jam-18 (Loop)		
049	Loop-19	113	Jam-19 (Loop)		
050	Loop-20	114	Jam-20 (Loop)		
051	Loop-21	115	Jam-21 (Loop)		
052	Loop-22	116	Jam-22 (Loop)		
053	Loop-23	117	Jam-23 (Loop)		
054	Loop-24	118	Jam-24 (Loop)		
055	Loop-25	119	Jam-25 (Loop)		
056	Loop-26	120	Jam-26 (Loop)		
057	Loop-27	121	Jam-27 (Loop)		
058	Loop-28	122	Jam-28 (Loop)		
059	Loop-29	123	Jam-29 (Loop)		
060	Loop-30	124	Jam-30 (Loop)		
061	Loop-31	125	Jam-31 (Loop)		
062	Loop-32	126	Jam-32 (Loop)		
063	Loop-33	127	Jam-33 (Loop)		
064	Loop-34	128	Jam-34 (Loop)		

● Pulse Width

A square waveform has exactly the same width, up and down, but a Pulse Width waveform has different widths. The ratio of upper width to lower is called pulse width. 0 to 100 are valid for setting the pulse width. Depending on the set pulse width value, the pitch may alter by one octave.

The harmonic content of the sound changes greatly.

```
Tone E/Partial 1
WG PulsWidth=000
```

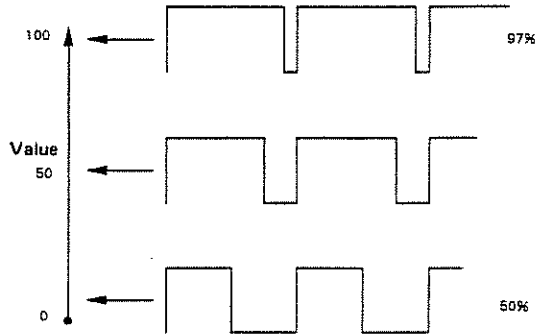

\* When a sawtooth is selected with the WG Waveform parameter, a pulse width of 50% raises the pitch by an octave.

● Pulse Width Velocity Sensitivity

This sets the sensitivity of the velocity that controls the pulse width from -7 to +7. With "-" values, the pulse width becomes smaller by playing the keyboard harder, and with "+" values, the pulse width becomes wider by playing the keyboard harder.

```
Tone E/Partial 1
WG PW Velo = 0
```

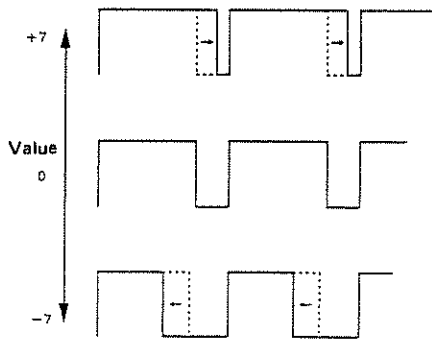

[Pitch ENV Group]

● Pitch ENV Depth **PCM**

This sets the depth of the Pitch ENV from 1 to 10. Higher values deepen the effect.

```
Tone E/Partial 1
P-ENV Depth =000
```

● Pitch ENV Velocity Sensitivity **PCM**

This sets the maximum effect of the velocity that controls the pitch of the Pitch ENV from 0 to 3. At higher values, the keyboard velocity has a greater effect on the envelope.

```
Tone E/Partial 1
P-ENV Velo =000
```

● Pitch ENV Key Follow (Time) **PCM**

This sets the time of the Pitch ENV depending on the key played, from 0 to 4. Higher values change the time more drastically.

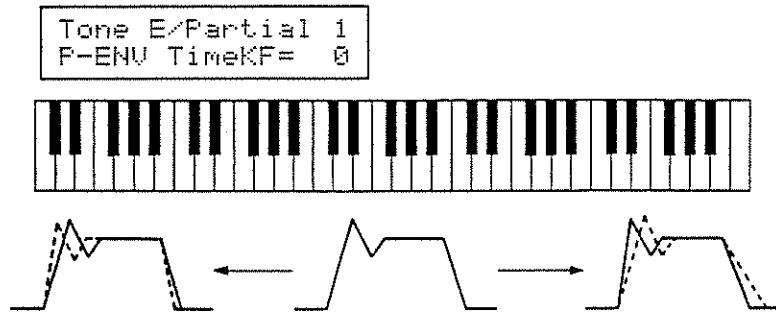

● Pitch ENV/Level **PCM**

These parameters are the time needed for a pitch curve to move from one point to another, and the pitch level of a certain point.

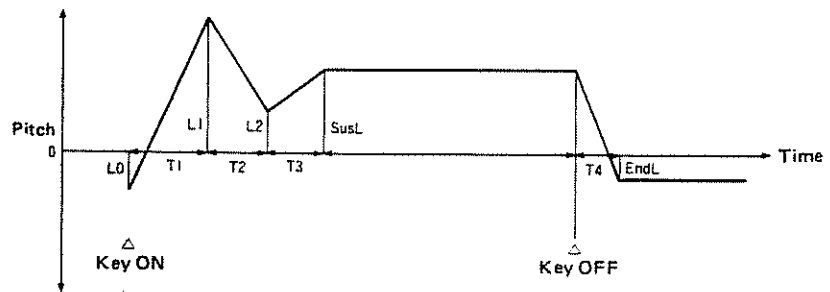

● Time 1 / Time 2 / Time 3 / Time 4 **PCM**

This sets the time needed from one point to another, from 0 to 100.

Tone E/Partial 1  
P-ENV T1 = 000

Tone E/Partial 1  
P-ENV T2 = 000

Tone E/Partial 1  
P-ENV T3 = 000

Tone E/Partial 1  
P-ENV T4 = 000

● Level 0 / Level 1 / Level 2 / Sustain Level / End Level **PCM**

This sets the pitch of a certain point from -50 to +50.

Tone E/Partial 1  
P-ENV L0 = 00

Tone E/Partial 1  
P-ENV L1 = 00

Tone E/Partial 1  
P-ENV L2 = 00

Tone E/Partial 1  
P-ENV Sus L = 00

Tone E/Partial 1  
P-ENV End L = 00

\* If the level of two adjacent points are set to similar values, the time between these two points may prove to be shorter than what is actually set, or even zero.

[LFO Group]

- LFO Rate **PCM**

This sets the rate (frequency) of the LFO from 0 to 100. Higher values quicken the rate.

```
Tone E/Partial 1
P-LFO Rate =000
```

- LFO Depth **PCM**

This sets the depth of the LFO from 0 to 100. Higher values deepen the effect.

```
Tone E/Partial 1
P-LFO Depth =000
```

• Vibrato effect can be obtained only from Point3 to key OFF of the Pitch ENV.

- Modulation Sensitivity **PCM**

This sets the sensitivity of the vibrato depth controlled by the modulation messages sent from the external controller unit. 0 to 100 are valid, higher values deepening the effect.

```
Tone E/Partial 1
P-LFO Mod =000
```

• Vibrato effect can be obtained only from Point3 to key OFF of the Pitch ENV.

[TVF Group]

- Cutoff Frequency

This sets the cutoff point of the TVF from 0 to 100. As you lower the value, higher frequencies are removed and the waveform gradually becomes an approximation of a sine wave, then the sound will finally fade out.

```
Tone E/Partial 1
TVF Freq =000
```

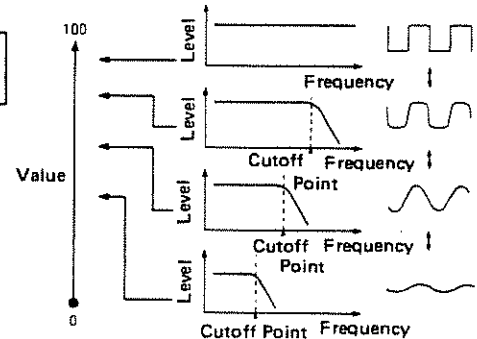

- Resonance

This boosts the cutoff point from 0 to 30. As you increase the value, specific harmonics are emphasized and the sound will become more unusual, more electronic in nature.

```
Tone E/Partial 1
TVF Reso = 00
```

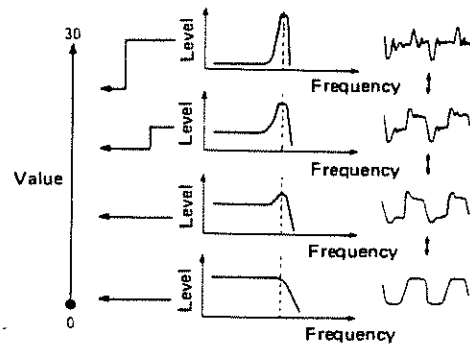

• Key Follow (Frequency)

This can change the cutoff point depending on the key played.

```
Tone E/Partial 1
TUF Freq KF= 0
```

Just like the Key Follow of WG Pitch, the value represents how many octaves change over 12 keys.

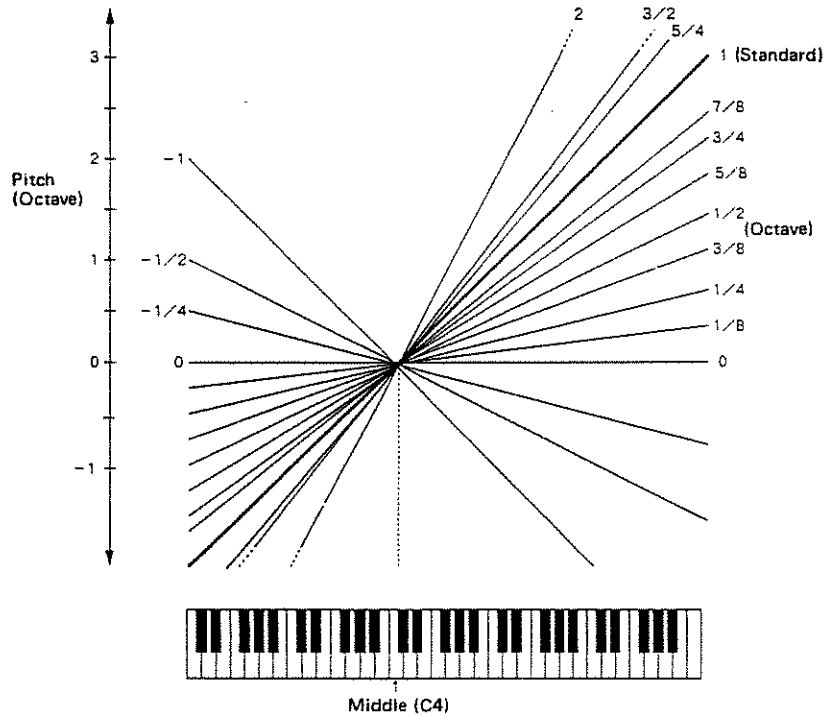

• Bias Point/Level

You can add a further change (= bias level) to the Key Follow curve from any point (key).

• Bias Point

This sets the range (point and direction) where the bias level is valid, from <A1 to <C7 and from >A1 to >C7 in semi-tone steps.

```
Tone E/Partial 1
TUF Bias P =< A1
```

[e.g.] >C4: The bias level is valid on the keyboard above the C4 key.

<C4: The bias level is valid on the keyboard below the C4 key.

• Bias Level

This bias level can be set from -7 to +7. "+" values raise the curve, and "-" values lower the curve.

```
Tone E/Partial 1
TUF Bias Lvl= 0
```

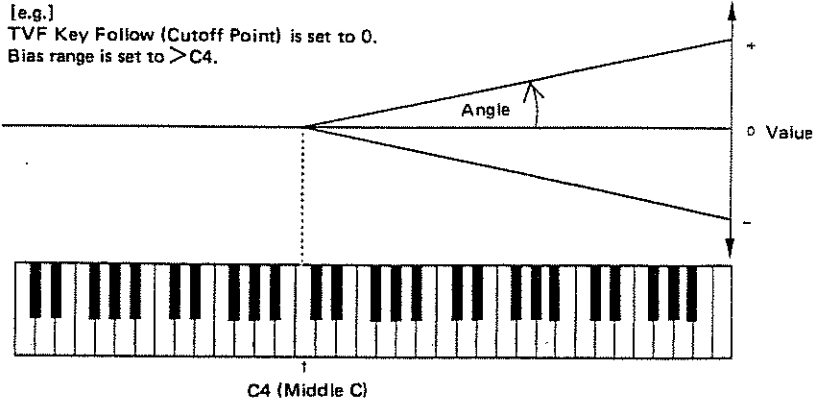

\* The curve shown in the picture represents the Key Follow value with the bias level added.

[TVF ENV Group]

- ENV Depth

This sets the depth of the TVF ENV modulation that changes the TVF Cutoff point. 0 to 100 are valid. At higher values, the effect is deeper.

```
Tone E/Partial 1
TVF-ENV Dept=000
```

- ENV Velocity Sensitivity

This sets the sensitivity of the velocity that controls the depth of the TVF ENV. 0 to 100 are valid. At higher values, the effect is deeper by playing the keyboard harder.

```
Tone E/Partial 1
TVF-ENV Velo=000
```

- Key Follow (Depth)

This can change the TVF ENV depth depending on the key played. 0 to 4 are valid, higher values changing the depth more drastically.

```
Tone E/Partial 1
TVF-ENV DKF = 0
```

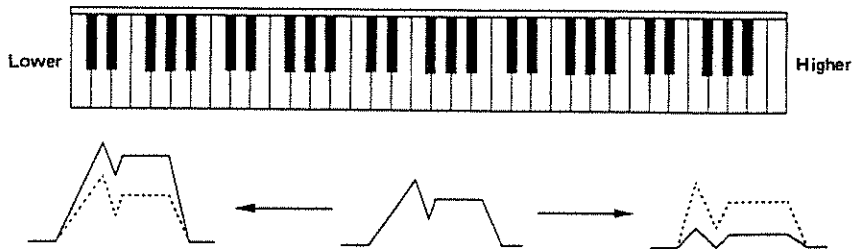

• ENV Key Follow (Time)

This can change the time of the TVF ENV depending on the key played. 0 to 4 are valid, higher values changing the time more drastically.

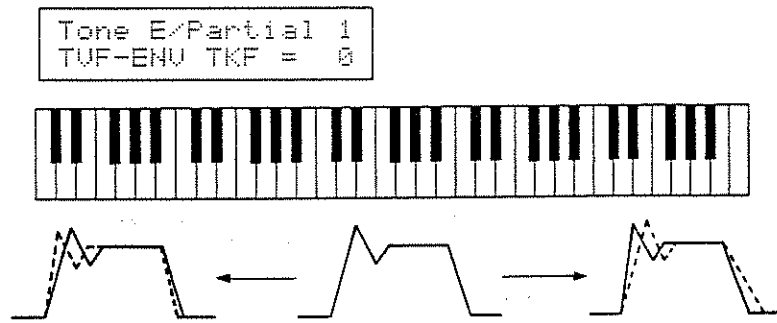

• ENV Time/Level

These parameters are the time needed for the envelope curve affecting the cutoff frequency to move from one point to another, and the level of the cutoff frequency at a certain point.

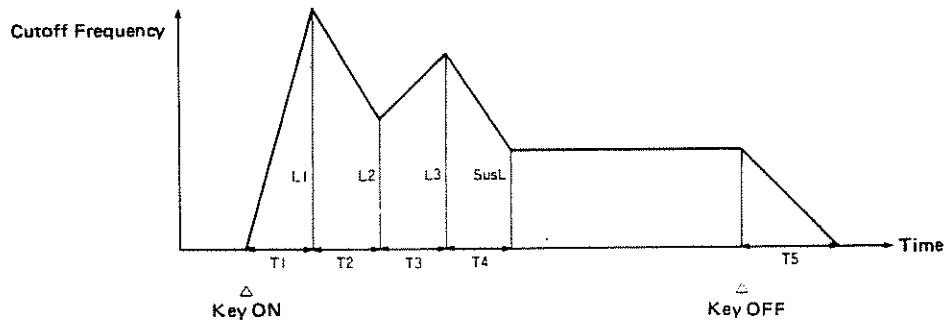

• Time 1 / Time 2 / Time 3 / Time 4 / Time 5

This sets the time needed from one point to another, from 0 to 100.

```
Tone E/Partial 1
TUF-ENV T1 =000

Tone E/Partial 1
TUF-ENV T2 =000

Tone E/Partial 1
TUF-ENV T3 =000

Tone E/Partial 1
TUF-ENV T4 =000

Tone E/Partial 1
TUF-ENV T5 =000
```

• Level 1 / Level 2 / Level 3 / Sustain Level

This sets the level of a certain point from 0 to 100.

```
Tone E/Partial 1
TUF-ENV L1 =000

Tone E/Partial 1
TUF-ENV L2 =000

Tone E/Partial 1
TUF-ENV L3 =000

Tone E/Partial 1
TUF-ENV SusL=000
```

\* If the level of two adjacent points are set to similar values, the time between these two points may prove to be shorter than what is actually set, or even zero.



[TVA Group]

- Level **PCM**

This sets the volume of a Partial from 0 to 100.

```
Tone E/Partial 1
TVA Level =100
```

- \* Higher values may cause sound distortion. If so, lower the value.
- \* Even when this is set to zero here, the sound may not be completely muted if the TVA ENV curve is high.

- Velocity Sensitivity **PCM**

This sets the sensitivity of the velocity that controls the volume of the sound from -50 to +50. "-" values lower the level by harder playing, and "+" values raise the level by harder playing.

```
Tone E/Partial 1
TVA Velocity=+40
```

< Bias Point/Level >

You can add a further change (= bias level) to the volume level from any point (key).

- Bias Points 1 and 2 **PCM**

This sets the range (point and direction) where the bias level is valid at two positions (keys), from <A1 to <C7 and from >A1 to >C7 in semi-tone steps.

```
Tone E/Partial 1
TVA Bias P1=>C#3
```

```
Tone E/Partial 1
TVA Bias P2=>C#3
```

- [e.g.] >C4: The bias level is valid on the keyboard above the C4 key.
- <C4: The bias level is valid on the keyboard below the C4 key.

- Bias Levels 1 and 2 **PCM**

This bias level can be set from 0 to -12. Lower values lower the curve.

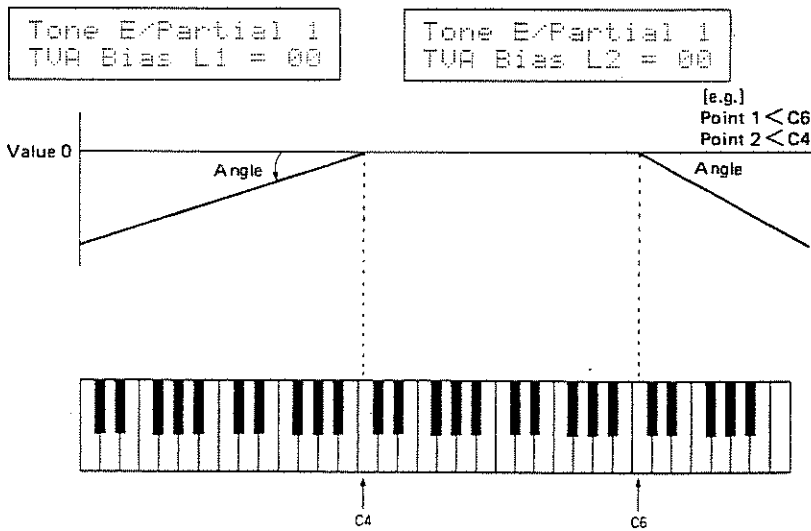

[TVA ENV Group]

- TVA ENV Key Follow (Time) **PCM**

This sets the time of the TVA ENV depending on the key played, from 0 to 4. Higher values change the time more drastically.

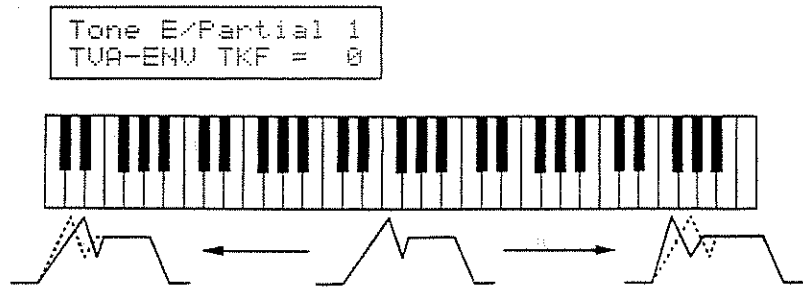

- TVA ENV Velocity Follow (Time 1) **PCM**

This sets the maximum effect of the velocity that controls the time of the TVA ENV from 0 to 4. At higher values, the Time 1 will be shortened by playing the keyboard harder.

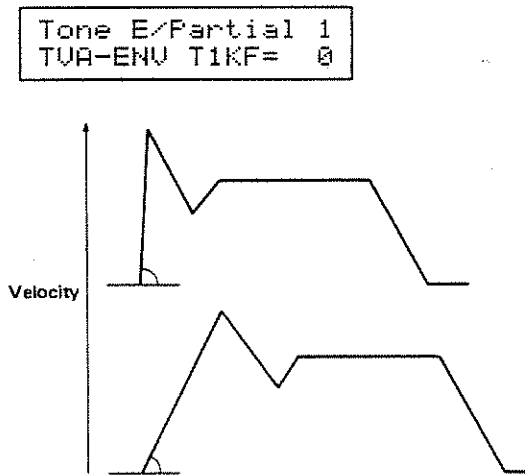

- TVA ENV Time/Level **PCM**

These parameters are the time needed for a volume curve to move from one point to another, and the volume of a certain point.

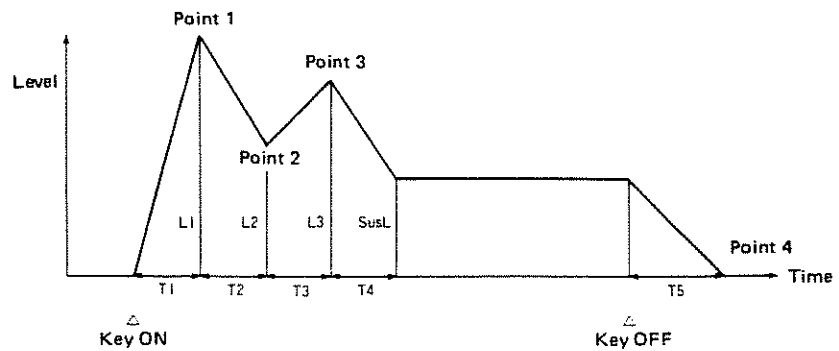

- Time 1 / Time 2 / Time 3 / Time 4 / Time 5 **PCM**

This sets the time needed for the curve to move from one point to another, from 0 to 100.

```
Tone E/Partial 1
TVA-ENV T1 =000

Tone E/Partial 1
TVA-ENV T3 =000

Tone E/Partial 1
TVA-ENV T5 =000
```

```
Tone E/Partial 1
TVA-ENV T2 =000

Tone E/Partial 1
TVA-ENV T4 =000
```

- Level 1 / Level 2 / Level 3 / Sustain Level **PCM**

This sets the volume of a certain point from 0 to 100.

```
Tone E/Partial 1
TVA-ENV L1 =100

Tone E/Partial 1
TVA-ENV L3 =100

Tone E/Partial 1
TVA-ENV SusL=000
```

```
Tone E/Partial 1
TVA-ENV L2 =100
```

\* If the level of two adjacent points are set to similar values, the time between these two points may prove to be shorter than what is actually set, or even zero.

# 5 PART SETTING

Part Setting involves editing the MIDI channel or volume in each PART.

Parameters for Part Setting

Display	Parameter
Output Level	Output Level
Pan	Pan
Key Range(L)	Key Range (Lower Limit)
Key Range(U)	Key Range (Upper Limit)
MIDI Channel	MIDI Channel
PtI Reserve	Partial Reserve

\* The Editing procedure does not rewrite the previous data, therefore the edited data will be erased by selecting a new Patch. To retain your edited version, take the Patch Writing procedure (see page 71.)

## 1. Editing Procedure

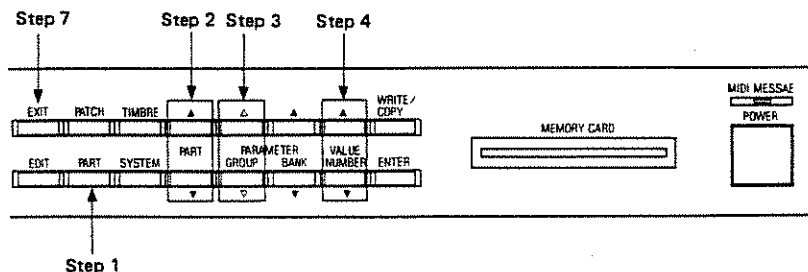

- Step 1 Push PART.
- Step 2 Using PART (▲▼), call the Part to be edited.
- Step 3 Using PARAMETER/GROUP (▽△), select the parameter to be edited.
- Step 4 Using VALUE/NUMBER (▲▼), change the value.  
PARAMETER/BANK (▲▼) can be used to change values drastically.
- Step 5 Repeat Steps 2, 3 and 4.
- Step 6 To write the edited data, take the Patch Writing procedure (page 71).
- Step 7 When finished, push EXIT to return to the Play mode.

## 2. Part Parameters

- Output Level

This sets the level of each Part (1 – 8 and Rhythm) from 0 to 100. Higher values increase the volume.

```

PART SET/ Part 1
Output Level=100
    
```

\* The actual output is the level set here multiplied by the TVA Level (Tone parameter) in Tone Parameters, MIDI Volume and the Expression.

- Pan

Pan is positioning of the sound image output in stereo through the Mix Outputs. 7> to <7 are valid as shown below.

```

PART SET/ Part 1
Pan = ><
    
```

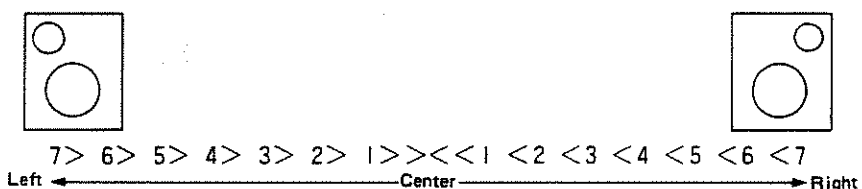

\* When the Structure of monaural output is used, the actual changes of panning will be as shown below.

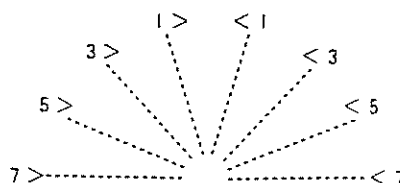

\* When the Structure of the Tone used in that Part is 8 or 9, the actual sound imaging of each Partial will be as shown below.

Value	Partial 1(3)	Partial 2(4)
<7	<7	<7
<6	<5	<7
<5	<3	<7
<4	<1	<7
<3	1>	<7
<2	3>	<7
<1	5>	<7
><	7>	<7
1>	7>	<5
2>	7>	<3
3>	7>	<1
4>	7>	1>
5>	7>	3>
6>	7>	5>
7>	7>	7>

\* In the Rhythm Part, the Pan can be set individually for each Key Number, therefore, the overall Pan setting for the Part cannot be performed.

< Key Range >

This sets the key range which can receive Key messages. The Key Range, however, cannot be set for the Rhythm Part.

• Lower Limit

This sets the lowest key of the key range, from C1 to C9. The right side of the keyboard from the set key is valid.

```
PART SET/ Part1
KeyRange(L)= G2
```

• Upper Limit

This sets the highest key of the key range, from C1 to C9. The left side keyboard from the set key is valid.

```
PART SET/ Part1
KeyRange(U)= C7
```

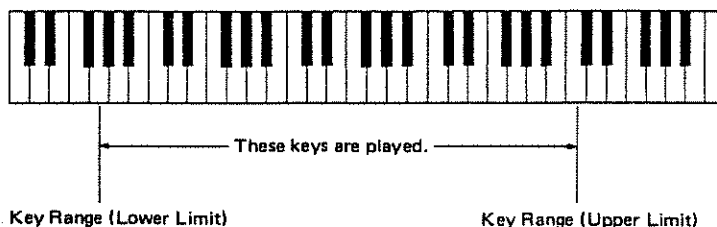

\* If you set the Lower Limit to the right of the Upper Limit, no key will sound over the entire keyboard range.

• MIDI Channel

The MIDI receive channel of each Part can be set from 1 to 16, or OFF.

```
PART SET/ Part 1
MIDI Channel= 02
```

\* If the MIDI channel of a Part is set to OFF, the Part does not function.

• Partial Reserve

This sets the number of Partials which can be used for a certain Part prior to other Parts. Even when more key messages than reserved are sent, if there are Partials which are not used in other Parts, they will be put to work in that Part. If another part requires partials from this part, they may not be used if they have been reserved for this part.

The Partial Reserve can be set from 0 to 32 without the total number of Partials exceeding 32.

```
PART SET/ Part 1
Pt1 Reserve = 03
```

# 6 WRITING

Your edited version of Patch Parameters, Timber/Tone Parameters or Part Settings will be erased by selecting a different Patch.

If you wish to retain the edited parameters, you are required to write it into the internal memory or onto a memory card.

Before you write data onto a memory card, set the Protect Switch to the OFF position, then return to ON when finished.

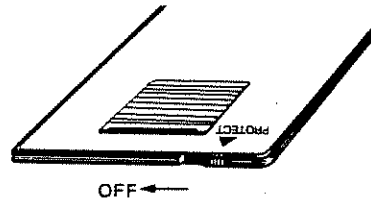

## 1. Patch Writing

Patch Writing includes all the Patch Parameters, Timbre assignment for each Part and Part settings.

The Data which can be written by the Patch Writing procedure are:

Data Written by Patch Writing

	Parameter	Mode
Patch	Patch Name Reverb Type Reverb Time Reverb Level	Patch Edit
Part 1 – 8	Output Level Pan Key Range (Lower Limit, Upper Limit) MIDI Channel Partial Reserve	Part Setting
	Tone (Group/Number) Key Shift Fine Tune Bender Range Assign Mode Output Assign	Timbre Edit
Rhythm Part	Output Level MIDI Channel Partial Reserve	Part Setting

- \* If you use the Patch Writing procedure to write data in the internal memory (or on a memory card) onto a memory card (or into the internal memory), and if a Tone of i (or c) group is assigned to the Timbre, the contents of the sound is automatically changed.

[Patch Writing Procedure]

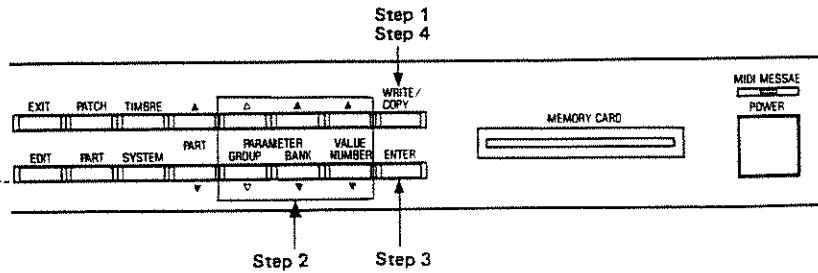

Step 1 With the unit turned to the Patch Select or Patch Edit mode, push WRITE/COPY.

The Display responds with:

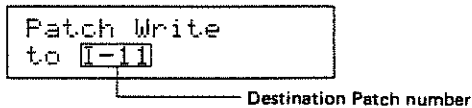

Step 2 Select a destination Patch Number (location for a new Patch). First select the internal or memory card mode with PARAMETER/GROUP (▽△), then a Bank with PARAMETER/BANK (▲▼), then a Number with VALUE/NUMBER (▲▼).

Step 3 Push ENTER.

The Display responds with "Sure? "

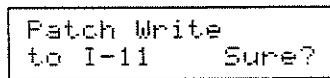

Step 4 Push WRITE/COPY to continue.

- \* To leave the mode, push EXIT, and the Display returns to the previous condition before any writing procedure was taken.

When the data is written properly, the Display responds as shown below for a while then returned to the previous condition.

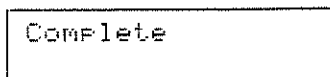



When writing data into the internal memory, and the Memory Protect is set to ON, the following Display is shown. At this stage, you can carry on writing by pushing ENTER or leave the writing mode by pushing EXIT.

```
Memory Protected
Turn off once ?
```

When writing data onto a memory card, and the Memory Protect is set to ON, the following Display is shown for a while then the previous condition. Set the Protect Switch on the memory card to the OFF position, then repeat the above Patch Writing procedure.

```
Card Protected
```

- \* The Patch Data can not be written at C-51 to 88 onto the M-128D Memory card.
- \* If an error message is shown in the Display, resolve it by following the instructions in "Error Messages Table" on page 96.

## 2. Timbre Writing

Timbre Writing includes all the Timbre Parameters.

The Data which can be written using the Timbre Writing procedure are:

Data Written by Timbre Writing

Parameter	Mode
Tone (Group/Number) Key Shift Fine Tune Bender Range Assign Mode Output Assign	Timbre Edit

- \* If you use the Timbre Writing procedure to write data in the internal memory (or on a memory card) onto a memory card (or into the internal memory), and if a Tone of i (or c) group is assigned to the Timbre, it will be automatically changed to c (or i) group.

### [Timbre Writing Procedure]

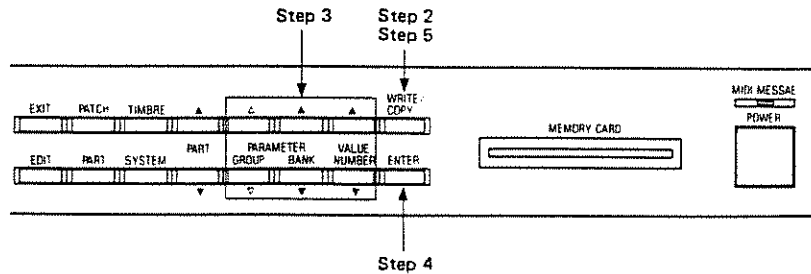

Step 1 Call the Patch or Part where the Timbre you wish to write is assigned.

Step 2 With the unit turned to the Timbre Select or Timbre Edit mode, push WRITE/COPY.

The Display responds with:

```

Timbre Write
to I-All
    
```

Destination Timbre number

Step 3 Select a destination Timbre Number (location for a new Timbre). First select a Group with PARAMETER/GROUP (▽△), then a Bank with PARAMETER/BANK (▲▼), then a Number with VALUE/NUMBER (▲▼).

Step 4 Push ENTER.

The Display responds with "Sure? "

```

Timbre Write
to I-All Sure?
    
```

Step 5 Push WRITE/COPY to continue.

- \* To leave the mode, push EXIT, and the Display returns to the previous condition which is before any writing procedure was taken.

When the data is written properly, the Display responds as shown below for a while then returned to the previous condition.

```

Complete
    
```

When writing data into the internal memory, and the Memory Protect is set to ON, the following Display is shown. At this stage, you can carry on writing by pushing ENTER or leave the writing mode by pushing EXIT.

```

Memory Protected
Turn off once ?
    
```

When writing data onto a memory card with the Memory Protect Switch set to the ON position, the following Display is shown for a while then the previous condition. Set the Protect Switch on the memory card to the OFF position, then repeat the procedure.

```

Card Protected
    
```

- \* If an error message is shown in the Display, resolve it by following the instructions in "Error Message Table" on page 96.

### 3. Tone Writing

Tone Writing includes all the Tone Parameters.

The Data which can be written by the Tone Writing procedure are:

Data Written by Tone Writing

Parameter	Mode
All the Common Parameters All the parameters of Partial 1 to 4	Tone Edit

\* The Tone Writing procedure will change all the Timbres that use the rewritten

[Tone Writing Procedure]

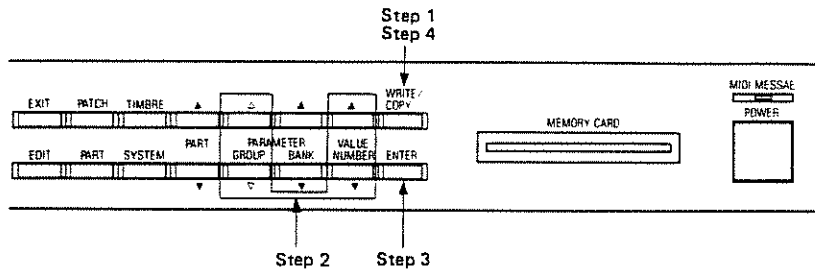

Step 1 With the unit turned to the Tone Edit mode, push WRITE/COPY.

The Display responds with:

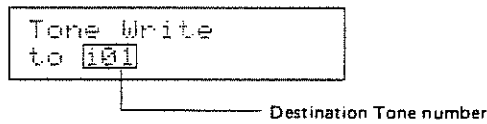

Step 2 Select a destination Tone Number (location for a new Tone). First select the internal or memory card mode with PARAMETER/GROUP (▽△), then a Number with VALUE/NUMBER (▲▼).

Step 3 Push ENTER.

The Display responds with "Sure? "

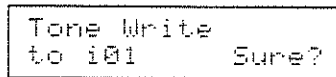

Step 4 Push WRITE/COPY to continue.

\* To leave the mode, push EXIT, and the Display returns to the previous condition which is before any writing procedure was taken.

When the data is written properly, the Display responds as shown below for a while then returned to the Tone Edit Display.

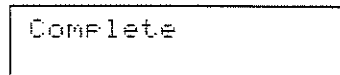

When writing data into the internal memory, and with the Memory Protect parameter set to ON, the following Display is shown. At this stage, you can carry on writing by pushing ENTER or leave the writing mode by pushing EXIT.

```
Memory Protected  
Turn off once ?
```

When writing data onto a memory card with the Memory Protect Switch set to the ON position, the following Display is shown for a while then the Tone Edit Display. Set the Protect Switch on the memory card to the OFF position, then repeat the above procedure.

```
Card Protected
```

\* If a error message is shown in the Display, resolve it by following the instructions in "Error Message Table" on page 96.

# 7 RHYTHM SETUP

The Rhythm Setup involves Tone, Volume, Pan, Output Mode, for each Key Number of the Rhythm Part. All these parameters are set for each pitch (Key) separately from C1 (24) to C8 (108).

Parameters for Rhythm Edit

Display	Parameter
Tone	Tone (Group/Number)
Output Level	Output Level
Pan	Pan
Output Assign	Output Assign

## 1. Editing Procedure

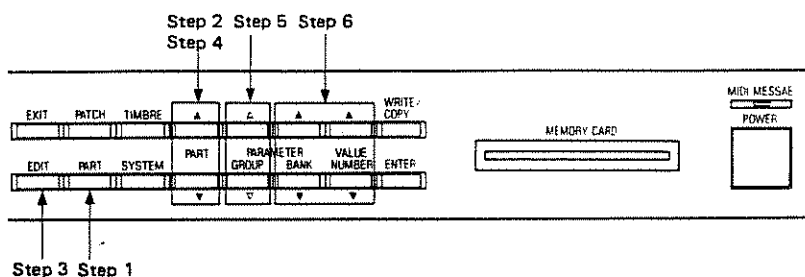

- Step 1 Push PART.
- Step 2 Using PART (▲▼), select the Rhythm Part.
- Step 3 Push EDIT to enter the Rhythm Setup mode.
  - \* If the Rhythm Part is not selected in Step 2, you cannot enter the Rhythm Setup mode.
- Step 4 Select the Key Number to be edited with PART (▲▼).
 

Key Number

RHY/Note: C2 r16  
Tone =BassDrum 2
- Step 5 Select the parameter to be edited with PARAMETER/GROUP (▼▲).
- Step 6 Change the value with PARAMETER/BANK (▲▼) and VALUE/NUMBER (▲▼).
  - \* Pressing PARAMETER/BANK (▲▼) will change values drastically (except selecting the Tone Group).
- Step 7 Repeat Steps 4, 5 and 6.
- Step 8 When finished, push EXIT twice to return to the Play mode.
  - \* Pushing EXIT once will select the Part Setting Display.

## 2. Rhythm Setup Parameters

- Tone

This selects a Rhythm Tone from 127 different Tones (= 63 Preset Rhythm Tones and 64 user-programmable Tones in the internal memory.) At OFF, no Rhythm Tone is assigned.

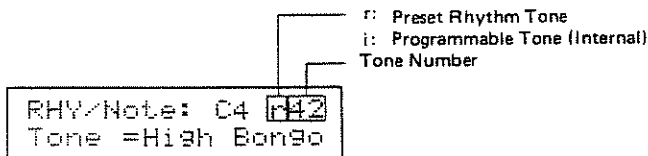

The following are 63 Preset Rhythm Tones.

- Preset Rhythm Tones

Number	Tone Name	Number	Tone Name
r01	Closed High Hat-1	r33	Low Tom Tom-2
r02	Closed High Hat-2	r34	High Tom Tom-3
r03	Open High Hat-1	r35	Middle Tom Tom-3
r04	Open High Hat-2	r36	Low Tom Tom-3
r05	Crash Cymbal	r37	High Pitch Tom Tom-1
r06	Crash Cymbal(Short)	r38	High Pitch Tom Tom-2
r07	Crash Cymbal(Mute)	r39	Hand Clap
r08	Ride Cymbal	r40	Tambourne
r09	Ride Cymbal(Short)	r41	Cowbell
r10	Ride Cymbal(Mute)	r42	High Bongo
r11	Cup	r43	Low Bongo
r12	Cup(Mute)	r44	High Conga(Mute)
r13	China Cymbal	r45	High Conga
r14	Splash Cymbal	r46	Low Conga
r15	Bass Drum-1	r47	High Timbale
r16	Bass Drum-2	r48	Low Timbale
r17	Bass Drum-3	r49	High Agogo
r18	Bass Drum-4	r50	Low Agogo
r19	Snare Drum-1	r51	Cabasa
r20	Snare Drum-2	r52	Maracas
r21	Snare Drum-3	r53	Short Whistle
r22	Snare Drum-4	r54	Long Whistle
r23	Snare Drum-5	r55	Oujada
r24	Snare Drum-6	r56	Claves
r25	Rim Shot	r57	Castanets
r26	Brush-1	r58	Triangle
r27	Brush-2	r59	Wood Block
r28	High Tom Tom-1	r60	Bell
r29	Middle Tom Tom-1	r61	Native Drum-1
r30	Low Tom Tom-1	r62	Native Drum-2
r31	High Tom Tom-2	r63	Native Drum-3
r32	Middle Tom Tom-2	r64	OFF

\* r64 represents OFF. The OFF setting may be used for muting unnecessary sound.

- Output Level

This sets the volume. 0 to 100 are valid, higher values increasing the volume.

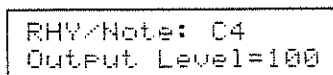

• **Pan**

This sets the positioning of the sound image output in stereo through the Mix Output Sockets. 7> to <7 are valid, creating the sound imaging as shown below.

```
RHY/Note: C1
Pan       = 2>
```

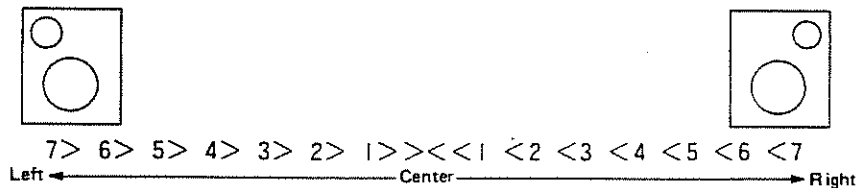

\* Unless the Output Assign mode is set to MIX, the pan value set here has no effect.

\* When the Structure of monaural output is used, actual changes of panning are as shown below.

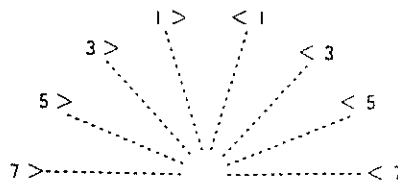

\* When the Structure of a Tone is 8 or 9, the actual sound imaging of each Partial will vary. (See page 69.)

• **Output Assign**

This determines from which of the 1 to 6 Output Sockets or Mix Output Sockets the Tone should be output.

```
RHY/Note: C4
OutputAssign=MIX
```

MIX: Sent in stereo through the MIX output Sockets  
1-6: Sent through the Multi Output Sockets

\* If the Reverb Type parameter is set to other than OFF, Multi Outputs 5 and 6 do not work.

# 8 SYSTEM SETUP

The System Setup section involves the parameters that are related with the overall setting of the D-110, e.g. Master Tuning, Memory Protect.

Parameters for System Setup

Display	Parameter
Mater Tune	Master Tuning
Mem Protect	Memory Protect
Control Ch.	Control Channel
Exclu Unit #	Exclusive Unit Number
Overflow	Overflow Assign Switch

## 1. Editing Procedure

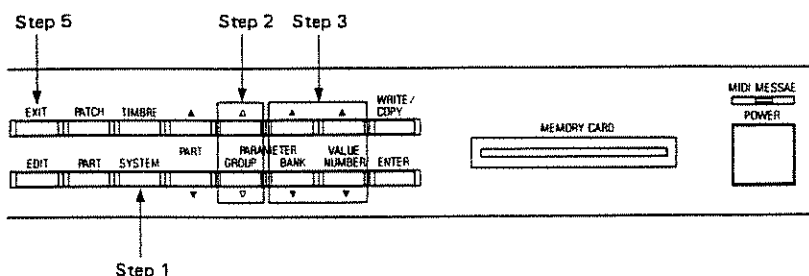

- Step 1 Push SYSTEM.
- Step 2 Using PARAMETER/GROUP (▽△), select the parameter to be edited.
- Step 3 Change the value with PARAMETER/BANK (▲▼) and VALUE/NUMBER (▲▼).
  - \* PARAMETER/BANK (▲▼) changes values drastically.
- Step 4 Repeat Steps 2 and 3.
- Step 5 Push EXIT to return to the Play mode.
  - \* The edited values of the System Setup section will be retained even after the unit is turned off (except Memory Protect).

## 2. System Setup Parameters

- Master Tuning

The Master Tuning sets the overall tuning of all the Parts from about 428 to 453 Hz (= frequencies of the Standard Pitch A4). In the Master Tuning Display, pushing PARAMETER/BANK (▲▼) changes values in approx. 2 Hz steps, and VALUE/NUMBER (▲▼) changes values continuously.

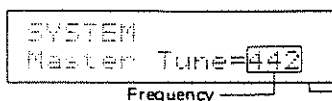

- ▲ : This means the actual frequency is higher than the value shown at the left.
- ▼ : This means the actual frequency is lower than the value shown at the left.



• Memory Protect

The Memory Protect function is provided for preventing data in the internal memory from accidental erasure. To write data into the internal memory you should set the Memory Protect to OFF. Even when you have forgotten to set the Memory Protect OFF, this can be temporarily changed as shown in the Writing Procedures previously explained.

```
SYSTEM
Mem Protect= ON
```

\* At power-up, the D-110 defaults to Memory Protect ON.

• Control Channel

This sets the MIDI channel on which Patch selecting (Program Change) messages are received. Usually, Program Change messages are received on a MIDI channel set in each Part, changing Timbres in the corresponding Part. However, Program Change messages may be used to change the entire Patch Data.

```
SYSTEM
Control Ch.= OFF
```

\* If the MIDI channel set for a Part is the same number as the Control Channel, receiving Program Change will change Patches.

Program Change numbers correspond with Patch numbers as shown below.

		Number							
		Bank	1	2	3	4	5	6	7
Internal	1	1	2	3	4	5	6	7	8
	2	9	10	11	12	13	14	15	16
	3	17	18	19	20	21	22	23	24
	4	25	26	27	28	29	30	31	32
	5	33	34	35	36	37	38	39	40
	6	41	42	43	44	45	46	47	48
	7	49	50	51	52	53	54	55	56
	8	57	58	59	60	61	62	63	64
Memory Card	1	65	66	67	68	69	70	71	72
	2	73	74	75	76	77	78	79	80
	3	81	82	83	84	85	86	87	88
	4	89	90	91	92	93	94	95	96
	5	97	98	99	100	101	102	103	104
	6	105	106	107	108	109	110	111	112
	7	113	114	115	116	117	118	119	120
	8	121	122	123	124	125	126	127	128

\* 0 to 127 Program Change messages are transmitted.

• Exclusive Unit Number

A Unit Number is used to identify an external MIDI device instead of the MIDI channel number, when data is received or transmitted via the Exclusive messages (only for Roland ID number). So, it is possible to send or receive the Exclusive messages by making sure the appropriate device number is used.

```
SYSTEM
Exclu Unit# = 17
```

• Overflow Assign Switch

The D-110 features an Overflow Assign function which sends out any Key messages which exceed the maximum number of voices played simultaneously on the D-110, via the MIDI OUT. The Overflow Assign Switch selects whether to turn this function on or not.

```
SYSTEM
Overflow = OFF
```

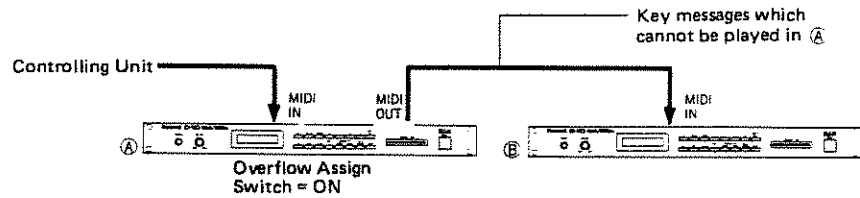

\* When more than one Part is set to the same MIDI channel number, Key messages played on the D-110 will also be output from the MIDI OUT.

## 9 DATA TRANSFER

The entire data in the internal memory can be copied onto a memory card, or the entire data on a memory card into the internal memory. Also, using Roland MIDI Exclusive messages, the data can be transferred from one D-110 to another D-110.

The Data Transfer mode includes the following functions. Using each function, a Block of data can be transferred. Copying the internal data onto a memory card is called saving, and copying data on a memory card into the internal memory is called loading.

Functions in the Data Transfer Mode

Display	Parameter
Save to Card	Save to Card
Load from Card	Load from Card
Dump One Way	Dump One Way
Dump Hand Shake	Dump Handshake

Pushing the Enter Button in the Edit mode will make it possible to send the values of various parameters separately via Exclusive messages.

### 1. Data Transfer Mode

The Data Transfer mode includes various functions. Connections, necessary preparation and cautions to be taken differ depending on the function. Before executing those functions, please read the following.

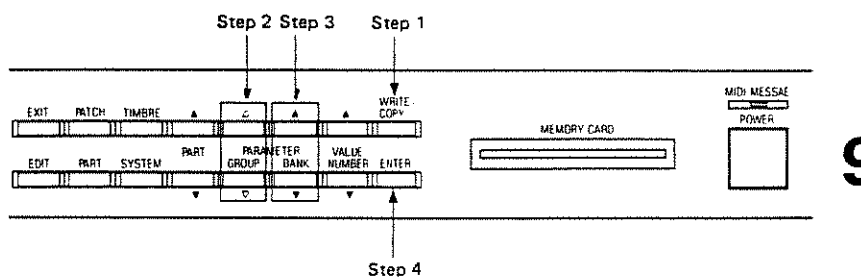

Step 1 With the unit turned to the Play mode, push WRITE/COPY.

\* If you push WRITE/COPY from the Patch Select, Patch Edit, Timbre Select, Timbre Edit or Tone Edit mode, the unit will enter a Writing mode.

Step 2 Using PARAMETER/GROUP (▽△), select the desired function.

Step 3 Using PARAMETER/BANK (▲▼), select the Data Block to be transferred.

(Sound)	(Rhythm Setup)	(All)
Tone	Rhythm Setup	Tone
Timbre		Timbre
Patch		Patch
		Rhythm Setup

	SOUND	RHYTHM SETUP	ALL
Save to Card	Save to Card Sound	Save to Card RhythmSetup	Save to Card All
Load from Card	Load from Card Sound	Load from Card RhythmSetup	Load from Card All
Dump One Way	Dump One Way Sound	Dump One Way RhythmSetup	Dump One Way All
Dump Handshake	Dump Hand Shake Sound	Dump Hand Shake RhythmSetup	Dump Hand Shake All

Step 4 Push ENTER.

Step 5 The Display shows "Sure?" To continue, push WRITE/COPY.

- \* If you wish to leave this mode, push EXIT, and then unit will return to the Play mode.

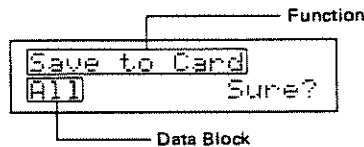

When data transfer has been completed, the following Display is shown for a while, then returned to the Play mode.

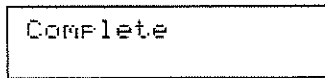

- \* If an Error Message is shown in the Display, resolve it by following the "Error Message Table" on page 96.

## 2. Data Transfer using a memory card

The Sound or Rhythm Setup data in the internal memory of the D-110 can be copied onto an optional memory card (M-256D or M-128D). Data which can be saved on the M-256D or M-128D differs as shown below.

	M-256D	M-128D
Tone	64	32
Timbre	128	128
Patch	64	32
Rhythm Setup	1	1

Insert a memory card into the Card Slot.

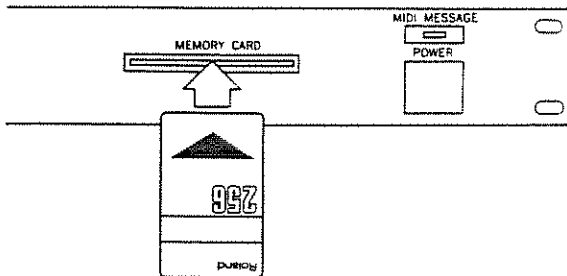

[Internal → Memory Card]  
(Save to Card)

Before saving data onto a memory card, set the Protect Switch on the memory card to OFF, and return it to ON when finished saving.

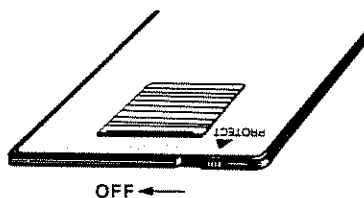

If you try to save with the Protect Switch set to ON, "Card Protected" is shown for a while then the screen returns to the previous Display. If this happens, repeat saving with the Protect Switch set to OFF this time.

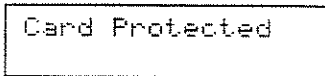

• When using a brand new card

If you are using a brand new card or a card that contains data for other than the D-110, be sure to save data in the "All" mode.

"Illegal Card" is shown in the Display when you use a brand new card or a card that contains data for other than the D-110. To continue, push ENTER, and to leave, push EXIT.

Set the Memory Protect Switch on the Memory Card to OFF.

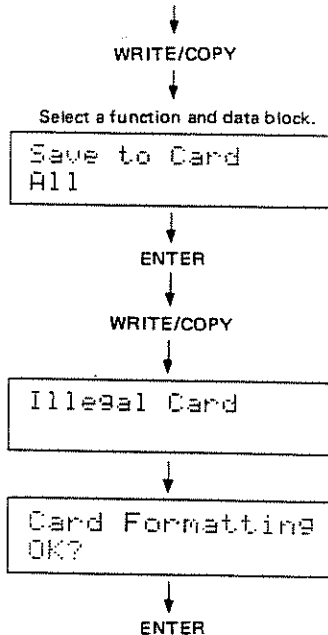

\* Select "All" when using a brand new memory card or a memory card that contains data for other than the D-110.

\* Push EXIT to leave the mode.

- \* If an Error Message is shown in the Display, resolve it by following the "Error Message Table" on page 96.

[Memory Card → Internal]

(Load from Card)

If the Memory Protect of the D-110 is set to ON, the Display responds as below. Pushing ENTER will cancel the Memory Protect making it possible to load, while pushing EXIT will leave the loading mode and return to the Play mode.



- \* If an Error Message is shown in the Display, resolve it by following the "Error Message Table" on page 96.

### 3. Data Transfer with MIDI (BULK)

Using Roland MIDI Exclusive messages, the data can be transferred from one D-110 to another D-110.

Data which can be transferred with the Exclusive messages are as shown below. It is also possible to transfer a block of data.

There are two methods of data transfer via MIDI; Handshake and One-way. Handshake allows you to verify whether the receiver is ready to receive the data. One-way transfers the data without confirming the condition of the receiver.

• Connections

One-way Connection



Handshake Connection

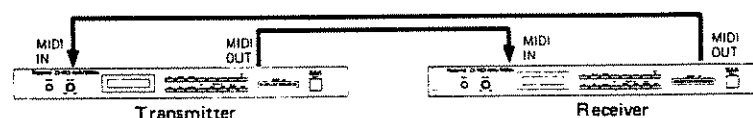

Set the Unit number of the receiver and transmitter to the same number. (Otherwise, data transfer is not possible.)

All the necessary procedures for data transfer (Dump one way, Dump handshake) should be performed on the transmitter unit.

When the data is properly copied, the Display responds as shown below for a while, then returns to the Play Mode Display.

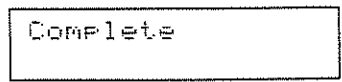

- \* If an Error Message is shown in the Display, resolve it by following the "Error Messages Table" on page 96.

## 4. Data Transfer via MIDI (INDIVIDUAL)

- Connections

Pushing the ENTER button in the Edit mode will transmit the value of the Parameter currently being edited through the MIDI OUT via One-way Exclusive messages. Using this function, it is made possible to record the Exclusive messages of Parameter values into a MIDI sequencer, and change the values during playback.

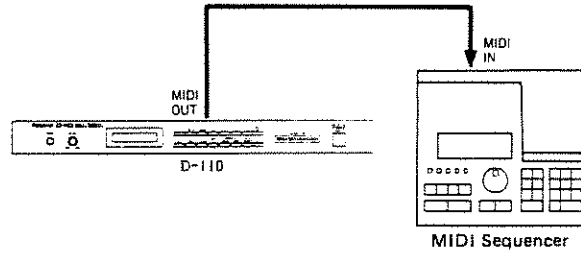

To record the Exclusive messages in a MIDI sequencer, select the appropriate parameter in the Edit mode, change the values, then push ENTER.

Exclusive messages which can be transmitted in each mode are as follows.

Mode	Exclusive Message
Patch Select	All data contained in a Patch
Timbre Select	Tone (Group/Number), Key Shift, Fine Tune, Bender Range, Assign Mode, Output Assign, Output Level, Pan, Key Range (U/L)
Timbre Edit (Tone Group/Number)	Tone Group/Number and Tone Parameter
Timbre Edit (except for Tone/Group Number) Part Setting (except for Partial Reserve) System (Master Tuning, Memory Protect, Control Channel) Rhythm Setup Tone Edit	Parameter data being edited
Part Setting (Partial Reserve)	Partial Reserve Data in 1 – 8 and the Rhythm Part
Patch Edit (except for Patch Name)	Reverb Parameter Values (Reverb Type, Reverb Time, Reverb Level)

3

# 10 ROM PLAY

8 different tunes are preprogrammed in the D-110 so that you can experience the excellent effect of the Multi Timbre function. Playing these tunes is called ROM play in this manual. To obtain the best effect of the Multi Timbre function, use a stereo amplifier, if possible.

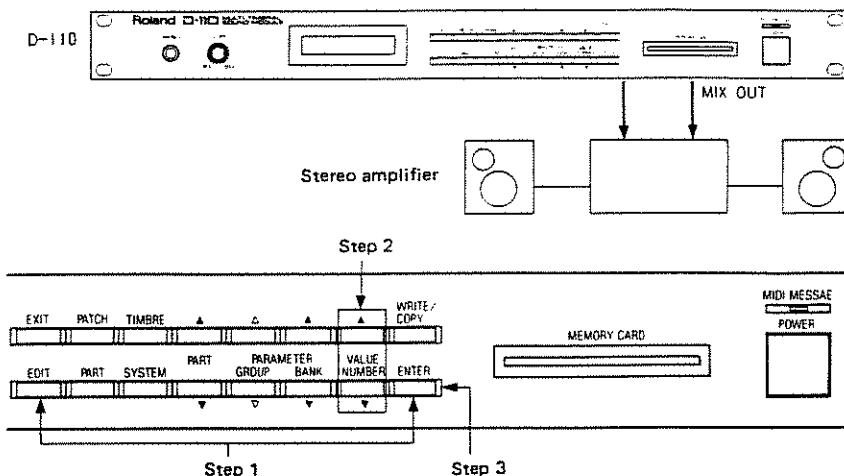

**Step 1** Turn the unit to the Play mode, then push the EDIT button while holding the ENTER button down. The Display responds with:

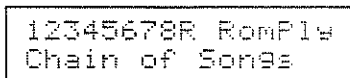

If you keep holding the ENTER button down, Songs 1 to 8 will be played in sequence.

**Step 2** Select the song to be played with the VALUE/NUMBER (▲▼) buttons.



Song number ———— Song name

**Step 3** Push the ENTER button to play the song you have selected.

- \* To stop playing, push the VALUE/NUMBER (▲▼) buttons, or EXIT.
- \* Pushing the EXIT button while no song is being played will return to the Play mode.

ROM Play Song Table

Song Number	Song Name	
1	Macho Memory	Music by Eric Persing (c) 1988 by Eric Persing
2	Jah May Kah!	Music by Amn Bhatia (c) 1988 by Amn Bhatia
3	Sugar Plum	Composed by Tchaikovski Arranged by Amn Bhatia
4	My Brother	Music by Adrian Scott (c) 1988 by Adrian Scott
5	Folk	Music by Amn Bhatia (c) 1988 by Amn Bhatia
6	Bumble Dee	Composed by Rymsky-Kovsakow Arranged by Amn Bhatia
7	Mergatroid	Music by Eric Persing (c) 1988 by Eric Persing
8	Dinner Set	Music by Adrian Scott (c) 1988 by Adrian Scott



# REFERENCE

- 1 **LA SYNTHESIS**
- 2 **TROUBLE-SHOOTING**
- 3 **APPENDIX TABLES**
- 4 **GUIDE FOR USING THE D-110**

# 1 LA SYNTHESIS

LA stands for Linear Arithmetic synthesis which is the heart of the new technology. LA synthesis involves a great many technological advances resulting not only in a superior sound quality but also an improved ease of programming. In this way, Roland has succeeded in maintaining a high degree of familiarity to the user despite the technical wizardry involved.

## 1. What is sound made of ?

### [Three Elements of a Sound]

Sounds are air vibrations reaching our ears. By transforming the vibration into digital signals, they can be stored as "waves".

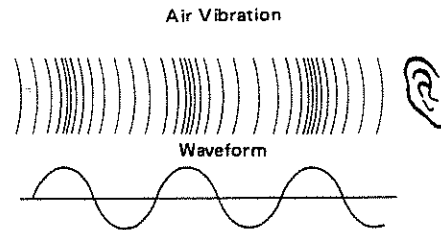

Basically, all sorts of sounds can be considered to consist of "pitch", "timbre" and "volume".

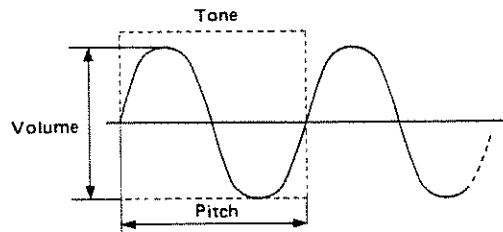

1) Pitch is determined by the number of waves ( = frequencies). Higher frequencies raise the pitch. Usually, pitch (frequency) is represented by Hz.

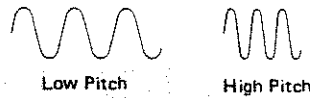

2) Timbre is determined by the shape of a wave. Generally speaking, round shapes wave make a soft sounds, and a sharp shapes make hard sounds.

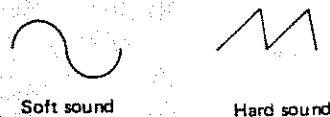

3) Volume is determined by the depth of a wave ( = amplitude). Larger waves have higher volumes.

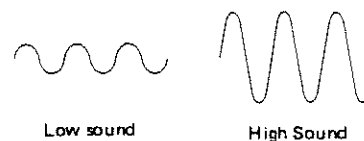

[Harmonics]

Timbre is determined by the shape of a wave. Then, how is the shape of a wave made? It is believed that a waveform consists of a great many sine waves. For example, a sawtooth is made by adding sine waves of all the multiples of the fundamental frequency.

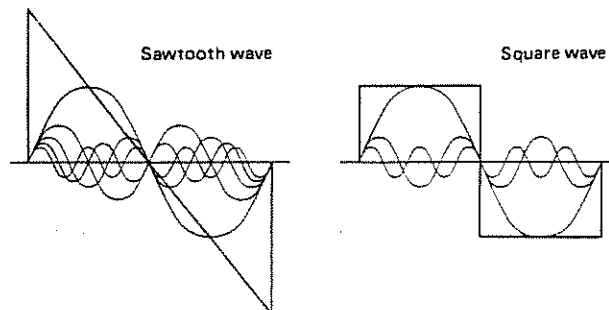

The waves added to the fundamental are called "harmonics"; even number multiple harmonics and odd number multiple harmonics. A timbre, in brief, is determined by the harmonic content of the wave.

[Envelope]

Each of the three elements, pitch, timbre and volume, has its own envelope curve. Each instrument sound has a different envelope.

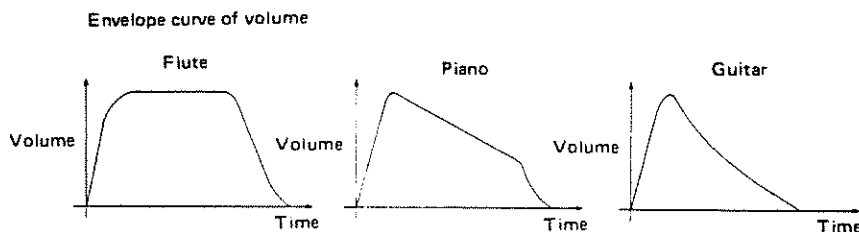

[Natural Sounds]

A natural sound consists of various different sounds. For example, a piano consists of a sharp attack sound then a decay sound. These two are completely different sounds. Also, the timbre of a piano decay sound varies depending on the pitch.

## 2. Key point for sound creation

The LA system allows you to combine various different sections of sounds for making a sound. In other words, each independent Partial makes its own sounds, then combined (synthesized).

The Structure may be the most important parameter of the D-110, as it decides how to combine the Partials.

1) Structure

[Structures that do not use Ring Modulators]

• Structure 1/3/6

Please study the following examples.

13 Structures may be divided into two groups, with the ring modulator, and without.

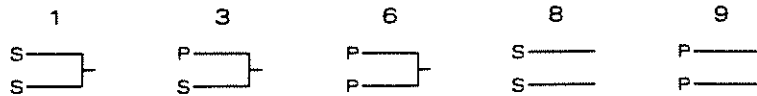

These can be combined as follows.

1) Set each Partial to the same, and detune slightly, and a fat sound can be created. Also, shifting the pitch by one octave or a 5th may be effective. This is suitable for strings or organ sounds.

2) To make a realistic sound, use the PCM sound generator for the attack sound. For example, to create a wind instrument sound, make a blowing sound with the PCM generator, then sustained the sound with a PCM loop or a synthesizer generator.

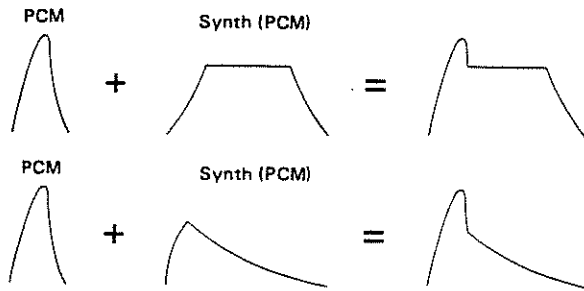

3) Make a bright and dark sound in each Partial separately, then reverse the polarity of the TVA Velocity. Then the tone can be altered by changing how you play the keyboard.

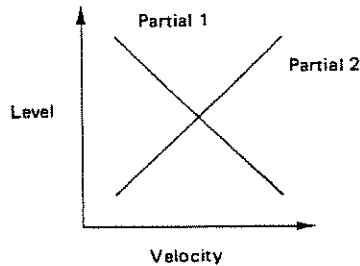

4) Make the upper and lower section sound in each Partial separately, then reverse the bias setting of the TVA. Then different tones can be heard by changing the sound range.

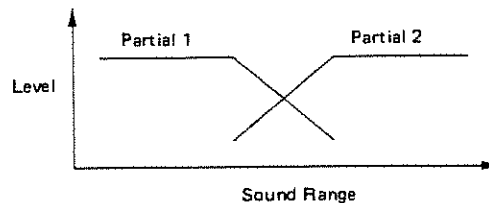

• Structure 8/9

This may be useful for creating stereo effects using one sound. However, the pan setting loses effect in this Structure, so the sound image cannot be changed.

[Using the Ring Modulator]

The Ring Modulator cross-modulates two Partial resulting in odd number multiple harmonics. Important points in using the Ring Modulator are as follows.

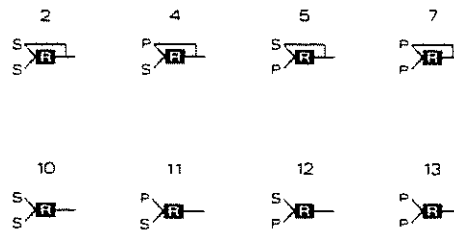

When the output of either Partial is zero (the TVA level is set to zero or the Partial is muted), the other Partial is automatically sent.

Partial 1 (3) always behaves as a fundamental and Partial 2 (4) as harmonic content.

Partial 1 (3) controls the overall volume.

Partial 2(4) controls the pitch and level of the harmonics.

When the pitch ratio of a Partial is a multiple of the fundamental, a clear sound is obtained. To create a transparent metallic sound, make as complete a sine wave as possible for Partial 1 (3).

PCM sounds normally include many odd number multiple harmonics, and therefore can become too "muddy" by using the Ring Modulator. Do not set the TVA level of Partial 2 (4) too high.

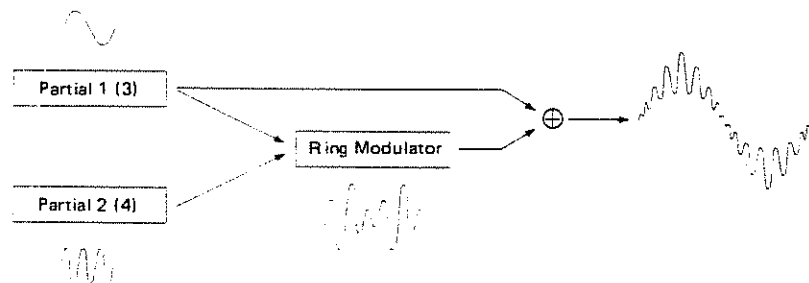

2) Editing

For easier and quicker editing, select a Tone which is similar to the sound you wish to make. Then set the D-110 to the Edit mode, and check the following points to study how the Partial are being used.

If you roughly understand how the sound is made, then changing the sound will be much easier.

- Check the Partial Mute

The Partial Mute is one of the parameters, and therefore is written in memory together with other parameters. The muted Partial is not being used.

1

- **Check how each Partial works**

Partial Mute

Using the Partial Mute function, listen to the sound of each Partial in use separately. You may pay attention to how sounds change depending on the sound range, or by the velocity. When using the Ring Modulator, muting one of the Partials will automatically send the other partial to the output.

- **Check the Structure**

Using the Structure number, you can check how each Partial functions and how the Partials are combined.

## 2 TROUBLE-SHOOTING

### 1. Before calling for Service

The D-110 features so many functions that it may not always react as you expect because of improper setup. For example, the cause may lie in the amplifier used. Before calling a service center, check the following points.

[No sound is heard or the volume is too low]

- Check if the volume is set too low.
- Check if you can hear sound through the headphones. If so, there is something wrong with the cords or external device.
- Check if the MIDI channels of the D-110 and the external MIDI device are set to the same number.
- Check if the volume of the relevant Part is set too low.
- Check if the Output Assign is correctly set. If the Reverb Type in Patch Edit is set to other than OFF, Multi Outputs 5 and 6 do not work.
- Check if the D-110 is not set to the ROM Play mode. In the ROM Play mode, the D-110 does not receive MIDI messages. Turn to the Play mode by pushing the EXIT button.

[Pitch is not normal]

- Check if the Master Tuning is properly set.
- Check if the Key Shift in Timbre Edit is properly set.
- \* If the pitch of a certain Timbre or Tone is strange, the cause will lie in the setting of that Timbre or Tone.

[A Patch/Timbre cannot be called]

- Check if the unit is not in the ROM Play mode. If so, push the EXIT button until the unit is returned to the Play mode.
- Check if the D-110 is not set to the Edit mode. If so, push the EXIT button to set to the Play mode.
- Check if the Control channel is set correctly.

[Editing cannot be performed with the Programmer / Data Transfer cannot be performed with Exclusive messages]

- Check if the MIDI Unit numbers of the relevant units are set to the same number.

## 2. Error Messages

When there is something wrong with the procedure you have taken or the D-110 itself, an Error Message will be shown in the Display. If so, resolve it as follows. If the same error message is shown repeatedly even though there seems to be no mistake in the operation, call a Roland service center.

```
Check
Internal Battery
```

- The battery for memory backup of the D-110 is low. Call your local Roland service center.

```
Check
Card's Battery
```

- The battery for memory backup in the optional memory card (M-256D or M-128D) is low. Replace with a new one (R2016) by following the instructions supplied with the memory card.

```
Memory Protected
Turn off once ?
```

- The Memory Protect in the D-110 is set to ON. Push the WRITE/COPY button to continue writing, and push the EXIT button to leave the mode.

```
Card Protected
```

- The Protect Switch on the memory card is set to the ON position. Set it to the OFF position.

```
Card Write Error
```

- Data is not correctly written on the memory card. Check if the memory card is correctly and securely connected to the D-110, then repeat saving.

```
Write Number Err
```

- This appears when you are using the M-128D memory card but you've tried to use Patches 51 to 88 or Tones 33 to 64 which do not exist on the M-128D. Check the Patch or Tone number, then repeat saving.

```
No Space
```

- This appears when you try to write Patches on a memory card that contains data for D-10/20.



No Data

- This appears when you try to load Patches from a memory card that contains data for the D-10.

Card Not Ready

- No memory card is connected or a memory card is not connected securely. Insert the card securely.

Read Only Card  
Couldn't Write

- You have tried to save data onto a ROM card. Data cannot be written onto a ROM card.

Illegal Card

- The memory card you use does not contain any data or data for other than the D-110. To write data onto a memory card for the D-110, take "Internal Memory Card" copying procedure on page 85.

Exclusive Buffer  
Full

- This appears when the D-110 receives excess Exclusive messages.

Exclusive Data  
Checksum Error

- This is Check-sum error of Exclusive messages.

Handshake Mode  
Timeout Occured

- When performing Handshake Dump, the D-110 is not connected to an external device which is to receive the D-110's Exclusive messages or the Unit number is not set to the same number.

Dump to MIDI  
Rejected

- In Handshake Dump mode, the external device rejects data transferred from the D-110, such as when the external device is playing.

### 3 APPENDIX TABLES

#### 1. Parameter Table

● Patch Parameters

Parameter	Display	Variable Range
Patch Name	Name	(spc)A.....Z, a.....z, 0.....9 & # ! ? . , : ; ' " * + - / <=>
Reverb Type	Reverb Type	1.....8, OFF
Reverb Time	Reverb Time	1.....8
Reverb Level	Reverb Level	0.....7

● Timbre Parameters

Parameters	Display	Variable Range
Tone	Tone	a01...a64, b01...b64, i01...i64/c01...c64, r01...r63, r64(OFF)
Key Shift	Key Shift	-24.....0.....+24
Fine Tune	Fine Tune	-50.....0.....+50
Bender Range	Bender Range	00.....24
Assign Mode	Assign Mode	1.....4
Output Assign	Output Assign	MIX, 1.....6

● Tone Parameters

[Common Parameters]

Parameter	Display	Variable Range
Tone Name	Name	(spc)A.....Z, a.....z, 0.....9 & # ! ? . , : ; ' " * + - / <=>
Structures 1&2	Structure 1 & 2	01.....13
Structures 3&4	Structure 3 & 4	01.....13
Partial Mute	Partial Mute	0, 1 (each Partial)
ENV Mode	ENV Mode	NORMAL, NO SUS

[Partial Parameters]

Parameter Group	Parameter	Display	PCM	Variable Range
WG Group	Pitch Coarse	WG Pitch Cors	○	C1, C <sup>♯</sup> 1.....B8, C9
	Pitch Fine	WG Pitch Fine	○	-50.....0.....+50
	Key Follow (Pitch)	WG Pitch KF	○	-1, -1/2, -1/4, 0, 1/8, 1/4, 3/8, 1/2, 5/8, 3/4 7/8, 1, 5/4, 3/2, 2, s1, s2
	Bender Switch	WG Bender SW	○	OFF, ON
	Wave Form	WG Waveform	×	SQU, SAW
	PCM Wave Bank	PCM Bank	○	1, 2
	PCM Wave Number	PCM	○	001.....128
	Pulse Width	WG Puls Width	×	000.....100
	Velocity Sensitivity (Pulse Width)	WG PW Velo	×	-7.....0.....+7
Pitch ENV Group	Pitch ENV Depth	P-ENV Depth	○	000.....010
	Velocity Sensitivity (Depth)	P-ENV Velo	○	0.....3
	Key Follow	P-ENV Time KF	○	0.....4
	Time 1/2/3/4	P-ENV T1(....4)	○	000.....100
	Level 0/1/2	P-ENV L0(....2)	○	-50.....00.....+50
	Sustain Level	P-ENV Sus L	○	-50.....00.....+50
	End Level	P-ENV End L	○	-50.....00.....+50
LFO Group	Rate	P-LFO Rate	○	000.....100
	Depth	P-LFO Depth	○	000.....100
	Modulation Sensitivity	P-LFO Mod	○	000.....100
TVF Group	Frequency	TVF Freq	×	000.....100
	Resonance	TVF Reso	×	00.....30
	Key Follow (Frequency)	TVF Freq KF	×	-1, -1/2, -1/4, 0, 1/8, 1/4, 3/8, 1/2, 5/8, 3/4 7/8, 1, 5/4, 3/2, 2
	Bias Point	TVF Bias P	×	<A1.....<C7, >A1.....>C7
	Bias Level	TVF Bias Lv1	×	-7.....0.....+7
TVF ENV Group	ENV Depth	TVF-ENV Dept	×	000.....100
	Velocity Sensitivity (Depth)	TVF-ENV Velo	×	000.....100
	Key Follow (Depth)	TVF-ENV DKF	×	0.....4
	Key Follow (Time)	TVF-ENV TKF	×	0.....4
	Time 1/2/3/4/5	TVF-ENV T1(....5)	×	000.....100
	Level 1/2/3	TVF-ENV L1(....3)	×	000.....100
	Sustain Level	TVF-ENV Sus L	×	000.....100
TVA Group	Level	TVA Level	○	000.....100
	Velocity Sensitivity	TVA Velocity	○	-50.....0.....+50
	Bias Point 1/2	TVA Bias P1(2)	○	<A1.....<C7, >A1.....>C7
	Bias Level 1/2	TVA Bias L1(2)	○	-12.....00
TVA ENV Group	Key Follow (Time)	TVA-ENV TKF	○	0.....4
	Velocity Follow (Time 1)	TVA-ENV T1VF	○	0.....4
	Time 1/2/3/4/5	TVA-ENV T1(....5)	○	000.....100
	Level 1/2/3	TVA-ENV L1(....3)	○	000.....100
	Sustain Level	TVA-ENV Sus L	○	000.....100

● Part Setting

Parameter	Display	Variable Range
Output Level	Output Level	000.....100
Pan	Pan	7>.....<.....<7
Key Range (Lower Limit)	Key Range(L)	C-1.....G10
Key Range (Upper Limit)	Key Range(U)	C-1.....G10
MIDI Channel	MIDI Channel	01.....16, OFF
Partial Reserve	Pll Reserve	00.....32 (Up to 32 through all the Parts)

● Rhythm Setup

Parameter	Display	Variable Range
Tone	Tone	r01.....r64, r01.....r63, r64(OFF)
Output Level	Output Level	000.....100
Pan	Pan	7>.....<.....<7
Output Assign	Output Assign	MIX, 1.....6

● System Setup

Parameter	Display	Variable Range
Master Tune	Master Tune	428▼.....453▼
Memory Protect	Mem Protect	OFF, ON
Control Channel	Control Ch.	01.....16, OFF
Exclusive Unit Number	Exclu Unit #	17.....32
Overflow Assign Switch	Overflow	OFF, ON

## 2. Preset Tones Table

Group a			Group b			Group r		
No.	Tone Name	Number of Partials	No.	Tone Name	Number of Partials	No.	Tone Name	Number of Partials
01	Acou Piano 1	3	01	Fantasy	4	r01	Closed High Hat-1	1
02	Acou Piano 2	2	02	Harmo Pan	4	r02	Closed High Hat-2	1
03	Acou Piano 3	2	03	Chorale	3	r03	Open High Hat-1	2
04	Honky-Tonk	3	04	Glasses	3	r04	Open High Hat-2	2
05	Elec Piano 1	3	05	Soundtrack	4	r05	Crash Cymbal	2
06	Elec Piano 2	3	06	Atmosphere	4	r06	Crash Cymbal (Short)	1
07	Elec Piano 3	2	07	Warm Bell	4	r07	Crash Cymbal (Mute)	1
08	Elec Piano 4	1	08	Space Horn	4	r08	Ride Cymbal	2
09	Elec Organ 1	4	09	Echo Bell	3	r09	Ride Cymbal (Short)	1
10	Elec Organ 2	2	10	Ice Rains	4	r10	Ride Cymbal (Mute)	1
11	Elec Organ 3	2	11	Oboe 2002	2	r11	Cup	2
12	Elec Organ 4	1	12	Echo Pan	2	r12	Cup (Mute)	1
13	Pipe Organ 1	3	13	Bell Swing	2	r13	China Cymbal	2
14	Pipe Organ 2	3	14	Reso Synth	2	r14	Splash Cymbal	1
15	Pipe Organ 3	2	15	Steam Pad	3	r15	Bass Drum-1	2
16	Accordion	2	16	Vibe String	4	r16	Bass Drum-2	1
17	Harpsi 1	3	17	Syn Lead 1	3	r17	Bass Drum-3	2
18	Harpsi 2	2	18	Syn Lead 2	2	r18	Bass Drum-4	1
19	Harpsi 3	1	19	Syn Lead 3	3	r19	Snare Drum-1	1
20	Clav 1	3	20	Syn Lead 4	2	r20	Snare Drum-2	1
21	Clav 2	2	21	Syn Bass 1	3	r21	Snare Drum-3	1
22	Clav 3	2	22	Syn Bass 2	2	r22	Snare Drum-4	2
23	Celesta 1	3	23	Syn Bass 3	2	r23	Snare Drum-5	1
24	Celesta 2	2	24	Syn Bass 4	3	r24	Snare Drum-6	1
25	Violin 1	3	25	Acou Bass 1	2	r25	Rim Shot	1
26	Violin 2	2	26	Acou Bass 2	1	r26	Brush-1	2
27	Cello 1	3	27	Elec Bass 1	3	r27	Brush-2	2
28	Cello 2	2	28	Elec Bass 2	2	r28	High Tom Tom-1	1
29	Contrabass	2	29	Slap Bass 1	2	r29	Middle Tom Tom-1	1
30	Pizzicato	3	30	Slap Bass 2	3	r30	Low Tom Tom-1	1
31	Harp 1	3	31	Fretless 1	4	r31	High Tom Tom-2	1
32	Harp 2	2	32	Fretless 2	2	r32	Middle Tom Tom-2	1
33	Strings 1	4	33	Vibe	2	r33	Low Tom Tom-2	1
34	Strings 2	3	34	Glock	3	r34	High Tom Tom-3	2
35	Strings 3	2	35	Marmba	3	r35	Middle Tom Tom-3	2
36	Strings 4	3	36	Xylophone	2	r36	Low Tom Tom-3	2
37	Brass 1	4	37	Guitar 1	3	r37	High Pitch Tom Tom-1	1
38	Brass 2	3	38	Guitar 2	3	r38	High Pitch Tom Tom-2	1
39	Brass 3	4	39	Elec Gtr 1	4	r39	Hand Clap	1
40	Brass 4	4	40	Elec Gtr 2	4	r40	Tambourine	1
41	Trumpet 1	3	41	Koto	2	r41	Cowbell	1
42	Trumpet 2	2	42	Shamisen	2	r42	High Bongo	1
43	Trombone 1	3	43	Jamisen	2	r43	Low Bongo	1
44	Trombone 2	2	44	Sho	4	r44	High Conga (Mute)	1
45	Horn	3	45	Shakuhachi	4	r45	High Conga	1
46	Fr Horn	2	46	Wadaiko Set	4	r46	Low Conga	1
47	Engl Horn	2	47	Sitar	4	r47	High Timbale	1
48	Tuba	2	48	Steel Drum	4	r48	Low Timbale	1
49	Flute 1	4	49	Tech Snare	4	r49	High Agogo	1
50	Flute 2	2	50	Elec Tom	4	r50	Low Agogo	1
51	Piccolo	3	51	Revrse Cym	2	r51	Oabasa	1
52	Recorder	2	52	Ethno Hit	4	r52	Maracas	1
53	Pan Pipes	3	53	Timpani	2	r53	Short Whistle	2
54	Bottleblow	4	54	Triangle	2	r54	Long Whistle	2
55	Breathpipe	4	55	Wind Bell	3	r55	Quijada	3
56	Whistle	2	56	Tube Bell	4	r56	Claves	1
57	Sax 1	2	57	Orche Hit	4	r57	Castanets	2
58	Sax 2	2	58	Bird Tweet	1	r58	Triangle	2
59	Sax 3	2	59	One Note Jam	4	r59	Wood Block	1
60	Clarnet 1	2	60	Telephone	1	r60	Bell	2
61	Clarnet 2	3	61	Typewriter	2	r61	Native Drum-1	1
62	Oboe	3	62	Insect	2	r62	Native Drum-2	1
63	Bassoon	2	63	Water Bells	3	r63	Native Drum-3	1
64	Harmonica	2	64	Jungle Tune	4	OFF		(0)

### 3. Initial Rhythm Setting

Initial Setting of Rhythm Tones

Note Name	Tone No.	Tone Name	No. of Partials
C1 (24)	r64	OFF	(0)
C <sup>#</sup> 1 (25)	r64	OFF	(0)
D1 (26)	r64	OFF	(0)
D <sup>#</sup> 1 (27)	r64	OFF	(0)
E1 (28)	r64	OFF	(0)
F1 (29)	r64	OFF	(0)
F <sup>#</sup> 1 (30)	r64	OFF	(0)
G1 (31)	r64	OFF	(0)
G <sup>#</sup> 1 (32)	r64	OFF	(0)
A1 (33)	r64	OFF	(0)
A <sup>#</sup> 1 (34)	r64	OFF	(0)
B1 (35)	r15	Bass Drum-1	2
C2 (36)	r16	Bass Drum-2	1
C <sup>#</sup> 2 (37)	r25	Rim Shot	1
D2 (38)	r19	Snare Drum-1	1
D <sup>#</sup> 2 (39)	r39	Hand Clap	1
E2 (40)	r20	Snare Drum-2	1
F2 (41)	r30	Low Tom Tom-1	1
F <sup>#</sup> 2 (42)	r01	Closed High Hat-1	1
G2 (43)	r33	Low Tom Tom-2	1
G <sup>#</sup> 2 (44)	r04	Open High Hat-2	2
A2 (45)	r29	Middle Tom Tom-1	1
A <sup>#</sup> 2 (46)	r03	Open High Hat-1	2
B2 (47)	r32	Middle Tom Tom-2	1
C3 (48)	r28	High Tom Tom-1	1
C <sup>#</sup> 3 (49)	r05	Crash Cymbal	2
D3 (50)	r31	High Tom Tom-2	1
D <sup>#</sup> 3 (51)	r08	Ride Cymbal	2
E3 (52)	r13	China Cymbal	2
F3 (53)	r11	Cup	2
F <sup>#</sup> 3 (54)	r40	Tambourine	1
G3 (55)	r14	Splash Cymbal	1
G <sup>#</sup> 3 (56)	r41	Cowbell	1
A3 (57)	r07	Crash Cymbal (Mute)	1
A <sup>#</sup> 3 (58)	r21	Snare Drum-3	1
B3 (59)	r10	Ride Cymbal (Mute)	1
C4 (60)	r42	High Bongo	1
C <sup>#</sup> 4 (61)	r43	Low Bongo	1
D4 (62)	r44	High Conga (Mute)	1
D <sup>#</sup> 4 (63)	r45	High Conga	1
E4 (64)	r46	Low Conga	1
F4 (65)	r47	High Timbale	1
F <sup>#</sup> 4 (66)	r48	Low Timbale	1
G4 (67)	r49	High Agogo	1
G <sup>#</sup> 4 (68)	r50	Low Agogo	1
A4 (69)	r51	Cabasa	1
A <sup>#</sup> 4 (70)	r52	Maracas	1
B4 (71)	r53	Short Whistle	2

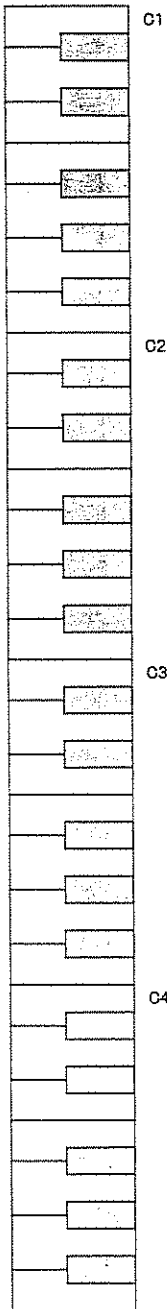

Note Name	Tone No.	Tone Name	No. of Partials
C5 (72)	r54	Long Whistle	2
C <sup>#</sup> 5 (73)	r55	Oujada	3
D5 (74)	r12	Cup (Mute)	1
D <sup>#</sup> 5 (75)	r56	Claves	1
E5 (76)	r26	Brush-1	2
F5 (77)	r27	Brush-2	2
F <sup>#</sup> 5 (78)	r57	Castanets	2
G5 (79)	r38	High Pitch Tom Tom-2	1
G <sup>#</sup> 5 (80)	r58	Triangle	2
A5 (81)	r37	High Pitch Tom Tom-1	1
A <sup>#</sup> 5 (82)	r59	Wood Block	1
B5 (83)	r60	Bell	2
C6 (84)	r17	Bass Drum-3	2
C <sup>#</sup> 6 (85)	r18	Bass Drum-4	1
D6 (86)	r22	Snare Drum-4	2
D <sup>#</sup> 6 (87)	r23	Snare Drum-5	1
E6 (88)	r24	Snare Drum-6	1
F6 (89)	r36	Low Tom Tom-3	2
F <sup>#</sup> 6 (90)	r02	Closed High Hat-2	1
G6 (91)	r35	Middle Tom Tom-3	2
G <sup>#</sup> 6 (92)	r06	Crash Cymbal (Short)	1
A6 (93)	r34	High Tom Tom-3	2
A <sup>#</sup> 6 (94)	r09	Ride Cymbal (Short)	1
B6 (95)	r61	Native Drum-1	1
C7 (96)	r62	Native Drum-2	1
C <sup>#</sup> 7 (97)	r63	Native Drum-3	1
D7 (98)	r64	OFF	(0)
D <sup>#</sup> 7 (99)	r64	OFF	(0)
E7 (100)	r64	OFF	(0)
F7 (101)	r64	OFF	(0)
F <sup>#</sup> 7 (102)	r64	OFF	(0)
G7 (103)	r64	OFF	(0)
G <sup>#</sup> 7 (104)	r64	OFF	(0)
A7 (105)	r64	OFF	(0)
A <sup>#</sup> 7 (106)	r64	OFF	(0)
B7 (107)	r64	OFF	(0)
C8 (108)	r64	OFF	(0)

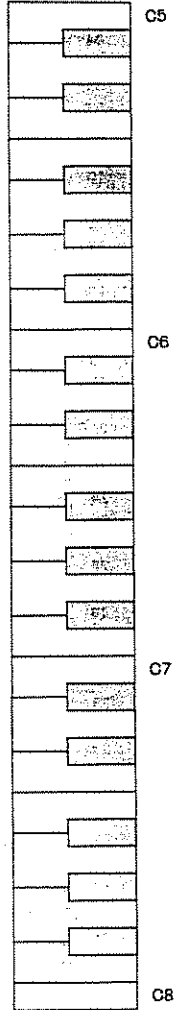

\* Rhythm sound is not available at r64.

### 4. PCM Sounds Table

[Bank 1]

No.	PCM Name	Remarks	No.	PCM Name	Remarks
001	Bass Drum-1	Rhythm Sound	065	Steel Guitar	Sustained Sound
002	Bass Drum-2				
003	Bass Drum-3				
004	Snare Drum-1				
005	Snare Drum-2				
006	Snare Drum-3				
007	Snare Drum-4				
008	Tom Tom-1				
009	Tom Tom-2				
010	High-Hat				
011	High-Hat (Loop)				
012	Crash Cymbal-1				
013	Crash Cymbal-2 (Loop)				
014	Ride Cymbal-1				
015	Ride Cymbal-2 (Loop)				
016	Cup				
017	China Cymbal-1				
018	China Cymbal-2 (Loop)				
019	Rim Shot				
020	Hand Clap				
021	Mute High Conga				
022	Conga				
023	Bongos				
024	Cowbell				
025	Tambourne				
026	Agogo				
027	Cleaves				
028	Timbale High				
029	Timbale Low				
030	Cabassa				
031	Timpani Attack	Attack Sound	066	Dirty Guitar	Decay Sound
032	Timpani				
033	Acoustic Piano High				
034	Acoustic Piano Low				
035	Piano Forte Thump				
036	Organ Percussion				
037	Trumpet				
038	Lips				
039	Trombone				
040	Clarinet				
041	Flute High				
042	Flute Low				
043	Steamer				
044	Indian Flute				
045	Breath				
046	Vibraphone High				
047	Vibraphone Low				
048	Maramba				
049	Xylophone High				
050	Xylophone Low				
051	Kalimba				
052	Wind Bell				
053	Chime Bar				
054	Hammer				
055	Guro				
056	Chnk				
057	Nats				
058	Fretless Bass				
059	Pull Bass				
060	Slap Bass				
061	Thump Bass				
062	Acoustic Bass				
063	Electric Bass				
064	Gut Guitar				
067	Pizzicato				
068	Harp				
069	Contrabass				
070	Cello				
071	Violin-1				
072	Violin-2				
073	Koto				
074	Drawbars (Loop)				
075	High Organ (Loop)				
076	Low Organ (Loop)				
077	Trumpet (Loop)				
078	Trombone (Loop)				
079	Sax-1 (Loop)				
080	Sax-2 (Loop)				
081	Reed (Loop)				
082	Slap Bass (Loop)				
083	Acoustic Bass (Loop)				
084	Electric Bass-1 (Loop)				
085	Electric Bass-2 (Loop)				
086	Gut Guitar (Loop)				
087	Steel Guitar (Loop)				
088	Electric Guitar (Loop)				
089	Clav (Loop)				
090	Cello (Loop)				
091	Violin (Loop)				
092	Electric Piano-1 (Loop)				
093	Electric Piano-2 (Loop)				
094	Harpisichord-1 (Loop)				
095	Harpisichord-2 (Loop)				
096	Telephone Bell (Loop)				
097	Female Voice-1 (Loop)				
098	Female Voice-2 (Loop)				
099	Male Voice-1 (Loop)				
100	Male Voice-2 (Loop)				
101	Spectrum-1 (Loop)				
102	Spectrum-2 (Loop)				
103	Spectrum-3 (Loop)				
104	Spectrum-4 (Loop)				
105	Spectrum-5 (Loop)				
106	Spectrum-6 (Loop)				
107	Spectrum-7 (Loop)				
108	Spectrum-8 (Loop)				
109	Spectrum-9 (Loop)				
110	Spectrum-10 (Loop)				
111	Noise (Loop)				
112	Shot-1				
113	Shot-2				
114	Shot-3				
115	Shot-4				
116	Shot-5				
117	Shot-6				
118	Shot-7				
119	Shot-8				
120	Shot-9				
121	Shot-10				
122	Shot-11				
123	Shot-12				
124	Shot-13				
125	Shot-14				
126	Shot-15				
127	Shot-16				
128	Shot-17				

\* When Sound Number is set between 112 and 128, click noise may be caused in some parameters of TVA ENV.

[Bank 2]

No.	PCM Name	Remarks	
001	Bass Drum-1*	Rhythm Sound (The pitch is not affected by Master Tuning.)	
002	Bass Drum-2*		
003	Bass Drum-3*		
004	Snare Drum-1*		
005	Snare Drum-2*		
006	Snare Drum-3*		
007	Snare Drum-4*		
008	Tom Tom-1*		
009	Tom Tom-2*		
010	High-Hat*		
011	High-Hat*(Loop)		
012	Crash Cymbal-1*		
013	Crash Cymbal-2*(Loop)		
014	Ride Cymbal-1*		
015	Ride Cymbal-2*(Loop)		
016	Cup*		
017	China Cymbal-1*		
018	China Cymbal-2*(Loop)		
019	Rm Sho!		
020	Hand Clap*		
021	Mute High Conga*		
022	Conga*		
023	Bongo*		
024	Cowbell*		
025	Tambourne*		
026	Agogo*		
027	Claves*		
028	Timbale High*		
029	Timbale Low*		
030	Cabasa*		
031	Loop-1		Effect Sound (Repeats of the same sound)
032	Loop-2		
033	Loop-3		
034	Loop-4		
035	Loop-5		
036	Loop-6		
037	Loop-7		
038	Loop-8		
039	Loop-9		
040	Loop-10		
041	Loop-11		
042	Loop-12		
043	Loop-13		
044	Loop-14		
045	Loop-15		
046	Loop-16		
047	Loop-17		
048	Loop-18		
049	Loop-19		
050	Loop-20		
051	Loop-21		
052	Loop-22		
053	Loop-23		
054	Loop-24		
055	Loop-25		
056	Loop-26		
057	Loop-27		
058	Loop-28		
059	Loop-29		
060	Loop-30		
061	Loop-31		
062	Loop-32		
063	Loop-33		
064	Loop-34		

No.	PCM Name	Remarks	
065	Loop-35		
066	Loop-36		
067	Loop-37		
068	Loop-38		
069	Loop-39		
070	Loop-40		
071	Loop-41		
072	Loop-42		
073	Loop-43		
074	Loop-44		
075	Loop-45		
076	Loop-46		
077	Loop-47		
078	Loop-48		
079	Loop-49		
080	Loop-50		
081	Loop-51		
082	Loop-52		
083	Loop-53		
084	Loop-54		
085	Loop-55		
086	Loop-56		
087	Loop-57		
088	Loop-58		
089	Loop-59		
090	Loop-60		
091	Loop-61		
092	Loop-62		
093	Loop-63		
094	Loop-64		
095	Jam-1 (Loop)		Effect Sound (Repeats of combined sounds)
096	Jam-2 (Loop)		
097	Jam-3 (Loop)		
098	Jam-4 (Loop)		
099	Jam-5 (Loop)		
100	Jam-6 (Loop)		
101	Jam-7 (Loop)		
102	Jam-8 (Loop)		
103	Jam-9 (Loop)		
104	Jam-10 (Loop)		
105	Jam-11 (Loop)		
106	Jam-12 (Loop)		
107	Jam-13 (Loop)		
108	Jam-14 (Loop)		
109	Jam-15 (Loop)		
110	Jam-16 (Loop)		
111	Jam-17 (Loop)		
112	Jam-18 (Loop)		
113	Jam-19 (Loop)		
114	Jam-20 (Loop)		
115	Jam-21 (Loop)		
116	Jam-22 (Loop)		
117	Jam-23 (Loop)		
118	Jam-24 (Loop)		
119	Jam-25 (Loop)		
120	Jam-26 (Loop)		
121	Jam-27 (Loop)		
122	Jam-28 (Loop)		
123	Jam-29 (Loop)		
124	Jam-30 (Loop)		
125	Jam-31 (Loop)		
126	Jam-32 (Loop)		
127	Jam-33 (Loop)		
128	Jam-34 (Loop)		



## 5. Blank Chart

- Patch

Patch No.	Patch Name								
Reverb Type	Reverb Time					Reverb Level			
	Part 1	Part 2	Part 3	Part 4	Part 5	Part 6	Part 7	Part 8	Part R
Output Level									
Pan									
Key Range (L)									
Key Range (U)									
MIDI Channel									
Partial Reserve									
Tone Select									
Key Shift									
Fine Tune									
Bender Range									
Assign Mode									
Output Assign									

Patch No.	Patch Name								
Reverb Type	Reverb Time					Reverb Level			
	Part 1	Part 2	Part 3	Part 4	Part 5	Part 6	Part 7	Part 8	Part R
Output Level									
Pan									
Key Range (L)									
Key Range (U)									
MIDI Channel									
Partial Reserve									
Tone Select									
Key Shift									
Fine Tune									
Bender Range									
Assign Mode									
Output Assign									

• Tone

[Common Parameters]

Tone No.	Tone Name							
Structure	1&2	3&4	Partial	1	2	3	4	ENV Mode
			Mute					

[Partial Parameters]

		Partial				Partial			
		1	2	3	4	1	2	3	4
WG	Pitch Cors								
	Pitch Fine								
	Pitch KF								
	Bender SW								
	Waveform								
	PCM Bank								
	PCM No								
	Pulse Width								
	PW Velocity								
	Pitch ENV	Depth							
Velocity									
KF (Time)									
T1									
T2									
T3									
T4									
L0									
L1									
L2									
LFO	Sus L								
	End L								
TVF	Rate								
	Depth								
	Modulation								
	Frequency								
	Resonance								
TVF ENV	KF (Freq)								
	Bias P								
	Bias L								
	Depth								
	Velocity								
	KF (Depth)								
	KF (Time)								
	T1								
	T2								
	T3								
TVA	T4								
	L1								
	L2								
	L3								
	Sus L								
	Level								
	Velocity								
	Bias P1								
	Bias L1								
	Bias P2								
Bias L2									
TVA ENV	KF (Time)								
	Velocity Follow(T1)								
	T1								
	T2								
	T3								
TVF	T4								
	T5								
	L1								
	L2								
	L3								
Sus L									

are the parameters unfit for PCM Sound Generator.

[Rhythm Setup]

Note Name	Tone	Level	Pan	Output
C1 (24)				
C#1 (25)				
D1 (26)				
D#1 (27)				
E1 (28)				
F1 (29)				
F#1 (30)				
G1 (31)				
G#1 (32)				
A1 (33)				
A#1 (34)				
B1 (35)				
C2 (36)				
C#2 (37)				
D2 (38)				
D#2 (39)				
E2 (40)				
F2 (41)				
F#2 (42)				
G2 (43)				
G#2 (44)				
A2 (45)				
A#2 (46)				
B2 (47)				
C3 (48)				
C#3 (49)				
D3 (50)				
D#3 (51)				
E3 (52)				
F3 (53)				
F#3 (54)				
G3 (55)				
G#3 (56)				
A3 (57)				
A#3 (58)				
B3 (59)				
C4 (60)				
C#4 (61)				
D4 (62)				
D#4 (63)				
E4 (64)				
F4 (65)				
F#4 (66)				
G4 (67)				
G#4 (68)				
A4 (69)				
A#4 (70)				
B4 (71)				

Note Name	Tone	Level	Pan	Output
C5 (72)				
C#5 (73)				
D5 (74)				
D#5 (75)				
E5 (76)				
F5 (77)				
F#5 (78)				
G5 (79)				
G#5 (80)				
A5 (81)				
A#5 (82)				
B5 (83)				
C6 (84)				
C#6 (85)				
D6 (86)				
D#6 (87)				
E6 (88)				
F6 (89)				
F#6 (90)				
G6 (91)				
G#6 (92)				
A6 (93)				
A#6 (94)				
B6 (95)				
C7 (96)				
C#7 (97)				
D7 (98)				
D#7 (99)				
E7 (100)				
F7 (101)				
F#7 (102)				
G7 (103)				
G#7 (104)				
A7 (105)				
A#7 (106)				
B7 (107)				
C8 (108)				

## 4 GUIDE FOR USING THE D-110

### [Changing Timbres in each Part]

Timbre selection in each Part can be performed in the Timbre Select mode. Timbre selection can also be done by receiving MIDI Program Change messages from an external controller unit.

See "Timbre Selection" on page 18.

### [MIDI Channel Setting for each Part]

MIDI Channel setting for each Part can be performed with the MIDI Channel parameter in Part Setting.

See "MIDI Channel" (Part Setting) on page 16.

### [Volume Balance of Parts]

The volume of each Part can be set with the Output Level parameter in Part Setting.

See "Output Level" (Part Setting) on page 23.

### [Adjusting the Volume Balance of the Timbres used within a Part]

If you wish to adjust the volumes of Timbres used in a Part, edit the TVA Levels of the Tones assigned to each Timbre.

See "Level" (Tone Edit) on page 65.

### [Adjusting the Volume Balance of each Tone used in the Rhythm Part]

The volume of each Tone of the Rhythm Part can be adjusted separately.

Use the Output Level parameter in Rhythm Edit.

See "Output Level" (Part Setting) on page 23.

### [Sending each Part separately through a Multi Output]

- Part 1 to Part 8

The Output Assign can be set for each Timbre with the Output Assign parameter in the Timbre Edit mode.

See "Output Assign" (Timbre Edit) on page 69.

\* If the Reverb Type in Patch Edit is set to other than OFF, Multi Outputs 5 and 6 do not work.

- Rhythm Part

The Output Assign can be set for each Key Number in the Rhythm Part with the Output Assign parameter in Rhythm Edit.

See "Output Assign" (Rhythm Edit) on page 79.

### [Pan Editing for each Part]

- Part 1 to Part 8

When using the Mix Output Sockets, the Pan setting can be edited for each Timbre with the Pan parameter in the Timbre Edit mode.

See "Pan" (Timbre Edit) on page 69.

\* If the Output Assign in Part Setting is set to other than MIX (when using the Multi Output Sockets), the Pan setting has no effect.

- **Rhythm Part**

The Pan setting can be edited for each Tone with the Pan parameter in Rhythm Edit.

See "Pan" (Rhythm Edit) on page 79.

- If the Output Assign in Rhythm Edit is set to other than MIX (when using the Multi Output Sockets), the Pan setting has no effect.

**[Using more than one D-110 to increase the maximum number of voices played at the same time]**

The D-110's Overflow Assign function makes it possible to use two or more D-110's as a sound module. For example, using two D-110's will increase the maximum number of voices to twice as much. The Overflow Assign function sends Key messages which exceed the maximum number of voices of the first D-110.

See "Overflow Assign Switch" on page 82.

**[Sound Data Communication with the D-10 or D-20]**

Sound data of the D-110 is compatible with the D-10 and D-20. The sound data (Timbres and Tones) programmed in the D-110 can be used for the D-10 or D-20, and the sound data programmed in the D-10 or D-20 can be used for the D-110. These data transfer actions are performed via memory cards or Exclusive messages.

- **Using a memory card**

A memory card which contains sound (Timbre and Tone) data can be used for any of the D-110, D-10 or D-20. However, the M-128D cannot be used for the D-10 or D-20.

See "Data Transfer" on page 84.

- **Using Exclusive messages**

See "Data Transfer" on page 86.

**[Editing with the Programmer PG-10]**

Patches, Timbres and Tones in the D-110 can be edited using the programmer PG-10. Read the PG-10's owner's manual.

# Roland Exclusive Messages

## 1. Data Format for Exclusive Messages

Roland's MIDI implementation uses the following data format for all exclusive messages (type IV):

Byte	Description
F0H	Exclusive status
41H	Manufactures ID (Roland)
DEV	Device ID
MDL	Model ID
CMD	Command ID
[BODY]	Maindata
F7H	End of exclusive

### # MIDI status: F0H, F7H

An exclusive message must be flanked by a pair of status codes, starting with a Manufactures-ID immediately after F0H (MIDI version 1.0).

### # Manufactures-ID: 41H

The Manufactures-ID identifies the manufacturer of a MIDI instrument that triggers an exclusive message. Value 41H represents Roland's Manufactures-ID.

### # Device ID: DEV

The Device-ID contains a unique value that identifies the individual device in the multiple implementation of MIDI instruments. It is usually set to 00H - 0FH, a value smaller by one than that of a basic channel, but value 00H - 1FH may be used for a device with multiple basic channels.

### # Model-ID: MDL

The Model-ID contains a value that uniquely identifies one model from another. Different models, however, may share an identical Model-ID if they handle similar data.

The Model-ID format may contain 00H in one or more places to provide an extended data field. The following are examples of valid Model-IDs, each representing a unique model:

01H  
02H  
03H  
00H, 01H  
00H, 02H  
00H, 00H, 01H

### # Command-ID: CMD

The Command-ID indicates the function of an exclusive message. The Command-ID format may contain 00H in one or more places to provide an extended data field. The following are examples of valid Command-IDs, each representing a unique function:

01H  
02H  
03H  
00H, 01H  
00H, 02H  
00H, 00H, 01H

### # Main data: BODY

This field contains a message to be exchanged across an interface. The exact data size and contents will vary with the Model-ID and Command-ID.

## 2. Address-mapped Data Transfer

Address mapping is a technique for transferring messages conforming to the data format given in Section 1. It assigns a series of memory-resident records - waveform and tone data, switch status, and parameters, for example - to specific locations in a machine-dependent address space, thereby allowing access to data residing at the address a message specifies.

Address-mapped data transfer is therefore independent of models and data categories. This technique allows use of two different transfer procedures: one-way transfer and handshake transfer.

### # One-way transfer procedure (See Section 3 for details.)

This procedure is suited for the transfer of a small amount of data. It sends out an exclusive message completely independent of a receiving device status.

#### Connection Diagram



Connection point 2 is essential for "Request data" procedures. (See Section 3.)

### # Handshake-transfer procedure (See Section 4 for details.)

This procedure initiates a predetermined transfer sequence (handshaking) across the interface before data transfer takes place. Handshaking ensures that reliability and transfer speed are high enough to handle a large amount of data.

#### Connection Diagram

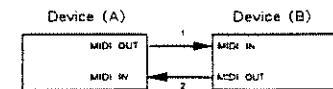

Connectional points 1 and 2 is essential.

### Notes on the above two procedures

- \* There are separate Command-IDs for different transfer procedures.
- \* Devices A and B cannot exchange data unless they use the same transfer procedure, share identical Device-ID and Model ID, and are ready for communication.

## 3. One-way Transfer Procedure

This procedure sends out data all the way until it stops when the messages are so short that answerbacks need not be checked.

For long messages, however, the receiving device must acquire each message in time with the transfer sequence, which inserts intervals of at least 20 milliseconds in between.

### Types of Messages

Message	Command ID
Request data 1	RQ1 (11H)
Data set 1	DT1 (12H)

### # Request data # 1: RQ1 (11H)

This message is sent out when there is a need to acquire data from a device at the other end of the interface. It contains data for the address and size that specify designation and length, respectively, of data required.

On receiving an RQ1 message, the remote device checks its memory for the data address and size that satisfy the request.

If it finds them and is ready for communication, the device will transmit a "Data set 1 (DT1)" message, which contains the requested data. Otherwise, the device will send out nothing.

Byte	Description
F0H	Exclusive status
41H	Manufactures ID (Roland)
DEV	Device ID
MDL	Model ID
11H	Command ID
aaH	Address MSB
⋮	⋮
	LSB
ssH	Size MSB
⋮	⋮
	LSB
sum	Check sum
F7H	End of exclusive

- \*The size of the requested data does not indicate the number of bytes that will make up a DTI message, but represents the address fields where the requested data resides.
- \*Some models are subject to limitations in data format used for a single transaction. Requested data, for example, may have a limit in length or must be divided into predetermined address fields before it is exchanged across the interface.
- \*The same number of bytes comprises address and size data, which, however, vary with the Model-ID.
- \*The error checking process uses a checksum that provides a bit pattern where the least significant 7 bits are zero when values for an address, size, and that checksum are summed.

#### # Data set 1 : DTI (12H)

This message corresponds to the actual data transfer process. Because every byte in the data is assigned a unique address, a DTI message can convey the starting address of one or more data as well as a series of data formatted in an address-dependent order.

The MIDI standards inhibit non-real time messages from interrupting an exclusive one. This fact is inconvenient for the devices that support a "soft-through" mechanism. To maintain compatibility with such devices, Roland has limited the DTI to 256 bytes so that an excessively long message is sent out in separate segments.

Byte	Description
F0H	Exclusive
41H	Manufactures ID (Roland)
DEV	Device ID
MDL	Model ID
12H	Command ID
aaH	Address MSB
⋮	⋮
	LSB
ddH	Data
⋮	⋮
sum	Check sum
F7H	End of exclusive

- \*A DTI message is capable of providing only the valid data among those specified by an RQI message.
- \*Some models are subject to limitations in data format used for a single transaction. Requested data, for example, may have a limit in length or must be divided into predetermined address fields before it is exchanged across the interface.
- \*The number of bytes comprising address data varies from one Model-ID to another.
- \*The error checking process uses a checksum that provides a bit pattern where the least significant 7 bits are zero when values for an address, size, and that checksum are summed.

#### # Example of Message Transactions

- Device A sending data to Device B  
Transfer of a DTI message is all that takes place.

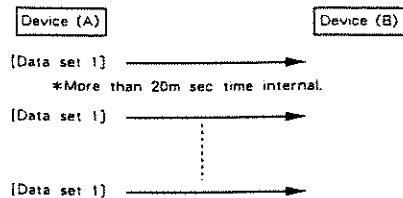

- Device B requesting data from Device A  
Device B sends an RQI message to Device A. Checking the message, Device A sends a DTI message back to Device B.

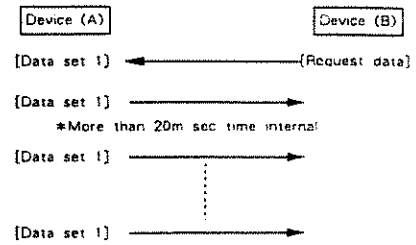

#### 4. Handshake- Transfer Procedure

Handshaking is an interactive process where two devices exchange error checking signals before a message transaction takes place, thereby increasing data reliability. Unlike one-way transfer that inserts a pause between message transactions, handshake transfer allows much speedier transactions because data transfer starts once the receiving device returns a ready signal.

When it comes to handling large amounts of data—sampler waveforms and synthesizer tones over the entire range, for example—across a MIDI interface, handshaking transfer is more efficient than one-way transfer.

#### Types of Messages

Message	Command ID
Want to send data	WSD (40H)
Request data	ROD (41H)
Data set	DAT (42H)
Acknowledge	ACK (43H)
End of data	EOD (45H)
Communication error	ERR (4EH)
Rejection	RJC (4FH)

#### # Want to send data : WSD (40H)

This message is sent out when data must be sent to a device at the other end of the interface. It contains data for the address and size that specify designation and length, respectively, of the data to be sent.

On receiving a WSD message, the remote device checks its memory for the specified data address and size which will satisfy the request. If it finds them and is ready for communication, the device will return an "Acknowledge (ACK)" message. Otherwise, it will return a "Rejection (RJC)" message.

Byte	Description
F0H	Exclusive status
41H	Manufactures ID (Roland)
DEV	Device ID
MDL	Model ID
40H	Command ID
aaH	Address MSB
⋮	⋮
	LSB
ssH	Size MSB
⋮	⋮
	LSB
sum	Check sum
F7H	End of exclusive

- \*The size of the data to be sent does not indicate the number of bytes that make up a "Data set (DAT)" message, but represents the address fields where the data should reside.
- \*Some models are subject to limitations in data format used for a single transaction. Requested data, for example, may have a limit in length or must be divided into predetermined address fields before it is exchanged across the interface.
- \*The same number of bytes comprises address and size data, which, however, vary with the Model-ID.
- \*The error checking process uses a checksum that provides a bit pattern where the least significant 7 bits are zero when values for an address, size, and that checksum are summed.

# Request data : RQD (41H)

This message is sent out when there is a need to acquire data from a device at the other end of the interface. It contains data for the address and size that specify designation and length, respectively, of data required.

On receiving an RQD message, the remote device checks its memory for the data address and size which satisfy the request. If it finds them and is ready for communication, the device will transmit a "Data set (DAT)" message, which contains the requested data. Otherwise, it will return a "Rejection (RJC)" message.

Byte	Description
F0H	Exclusive status
41H	Manufactures ID (Roland)
DEV	Device ID
MDL	Model ID
41H	Command ID
aaH	Address MSB
⋮	⋮
	LSB
ssH	Size MSB
⋮	⋮
	LSB
sum	Check sum
F7H	End of exclusive

- \*The size of the requested data does not indicate the number of bytes that make up a "Data set (DAT)" message, but represents the address fields where the requested data resides.
- \*Some models are subject to limitations in data format used for a single transaction. Requested data, for example, may have a limit in length or must be divided into predetermined address fields before it is exchanged across the interface.
- \*The same number of bytes comprises address and size data, which, however, vary with the Model-ID.
- \*The error checking process uses a checksum that provides a bit pattern where the least significant 7 bits are zero when values for an address, size, and that checksum are summed.

# Data set : DAT (42H)

This message corresponds to the actual data transfer process. Because every byte in the data is assigned a unique address, the message can convey the starting address of one or more data as well as a series of data formatted in an address-dependent order.

Although the MIDI standards inhibit non-real time messages from interrupting an exclusive one, some devices support a "soft-through" mechanism for such interrupts. To maintain compatibility with such devices, Roland has limited the DAT to 255bytes so that an excessively long message is sent out in separate segments.

Byte	Description
F0H	Exclusive status
41H	Manufactures ID (Roland)
DEV	Device ID
MDL	Model ID
42H	Command ID
aaH	Address MSB
⋮	⋮
	LSB
ddH	Data
⋮	⋮
sum	Check sum
F7H	End of exclusive

- \*A DAT message is capable of providing only the valid data among those specified by an RQD or WSD message.
- \*Some models are subject to limitations in data format used for a single transaction. Requested data, for example, may have a limit in length or must be divided into predetermined address fields before it is exchanged across the interface.
- \*The number of bytes comprising address data varies from one model ID to another.
- \*The error checking process uses a checksum that provides a bit pattern where the least significant 7 bits are zero when values for an address, size, and that checksum are summed.

# Acknowledge : ACK (43H)

This message is sent out when no error was detected on reception of a WSD, DAT, "End of data (EOD)", or some other message and a requested setup or action is complete. Until it receives an ACK message, the device at the other end will not proceed to the next operation.

Byte	Description
F0H	Exclusive status
41H	Manufactures ID (Roland)
DEV	Device ID
MDL	Model ID
43H	Command ID
F7H	End of exclusive

# End of data : EOD (45H)

This message is sent out to inform a remote device of the end of a message. Communication, however, will not come to a end unless the remote device returns an ACK message even though an EOD message was transmitted.

Byte	Description
F0H	Exclusive status
41H	Manufactures ID (Roland)
DEV	Device ID
MDL	Model ID
45H	Command ID
F7H	End of exclusive

# Communications error : ERR (4EH)

This message warns the remote device of a communication fault encountered during message transmission due, for example, to a checksum error. An ERR message may be replaced with a "Rejection (RJC)" one, which terminates the current message transaction in midstream.

When it receives an ERR message, the sending device may either attempt to send out the last message a second time or terminate communication by sending out an RJC message.

Byte	Description
F0H	Exclusive status
41H	Manufactures ID (Roland)
DEV	Device ID
MDL	Model ID
4EH	Command ID
F7H	End of exclusive



### # Rejection : RJC (4FH)

This message is sent out when there is a need to terminate communication by overriding the current message. An RJC message will be triggered when :

- a WSD or RQI message has specified an illegal data address or size,
- the device is not ready for communication,
- an illegal number of addresses or data has been detected,
- data transfer has been terminated by an operator,
- a communications error has occurred.

An ERR message may be sent out by a device on either side of the interface. Communication must be terminated immediately when either side triggers an ERR message.

Byte	Description
FDH	Exclusive status
41H	Manufactures ID (Roland)
DEV	Device ID
MDL	Model ID
4FH	Command ID
F7H	End of exclusive

### # Example of Message Transactions

- Data transfer from device (A) to device (B).

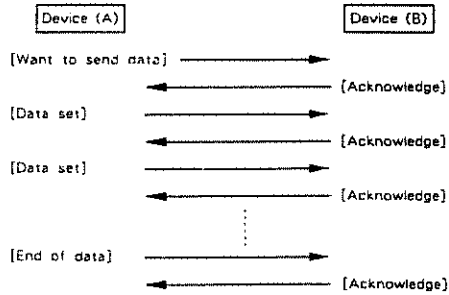

- Device (A) requests and receives data from device (B).

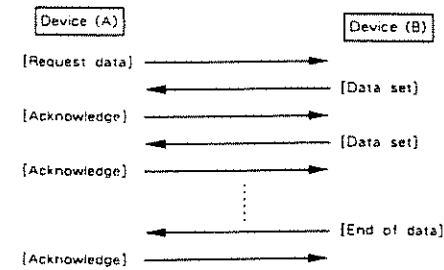

- Error occurs while device (A) is receiving data from device (B).

- 1) Data transfer from device (A) to device (B).

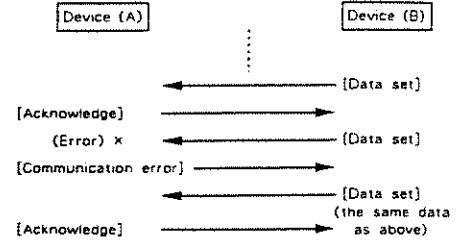

- 2) Device (B) rejects the data re-transmitted, and quits data transfer.

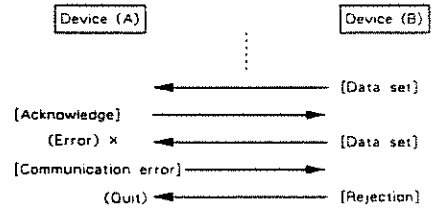

- 3) Device (A) immediately quits data transfer.

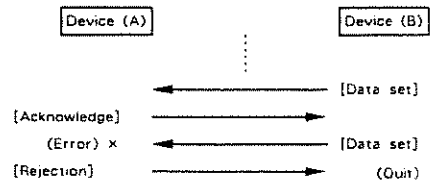

1. TRANSMITTED DATA

■ Bypassed Messages

In Overflow assign mode, retransmits the following MIDI IN messages from MIDI OUT.

- All channel voice messages except Note on.
- Note on message(s) to which D-110 cannot assign voice(s) because the number of received Note on messages exceeds D-110's simultaneously assignable voices.

■ Exclusive

Status

FDH : System exclusive  
 F7H : End of Exclusive

When in Patch Select or Timbre Select mode, a Patch (a set of parameters constituting a timbre) can be transmitted. Individual parameter can be sent while editing. Exclusive message can be used for bulk dumping. For details, see Sections 4 and 5, and Roland Exclusive Messages.

2. RECOGNIZED RECEIVE DATA (Parts 1-8)

■ Note event

Note off

Status	Second	Third
8nH	kkH	vvH
9nH	kkH	00H

kk = note number 00H - 7FH ( 0 - 127 )  
 vv = velocity ignored  
 n = MIDI Channel 0H - FH ( 1 - 16 )

A tone whose envelope mode is "NO SUS" ignores note off message.

Note on

Status	Second	Third
9nH	kkH	vvH

kk = note number 00H - 7FH ( 0 - 127 )  
 vv = Velocity 0H - 7FH ( 1 - 127 )  
 n = MIDI Channel 0H - FH ( 1 - 16 )

Note numbers outside of the range 12-108 are transposed to the nearest octave inside the range. (When key shift feature of D-110 is engaged, a note is first key shifted; if it still remains or becomes outside of the range, it is transposed by the octave.)

■ Control change

Modulation Depth

Status	Second	Third
BnH	01H	vvH

vv = Modulation depth 00H - 7FH ( 0 - 127 )  
 n = MIDI Channel 0H - FH ( 1 - 16 )

Data Entry

Status	Second	Third
BnH	06H	vvH

vv = Value of a parameter specified by RPC. (See description in RPC MSB.)  
 n = MIDI Channel 0H - FH ( 1 - 16 )

Main Volume

Status	Second	Third
8nH	07H	vvH

vv = Value Value 00H - 7FH ( 0 - 127 )  
 n = MIDI Channel 0H - FH ( 1 - 16 )

Controls the volume of a Part accessible through the received MIDI channel. The maximum volume is determined by OUTPUT LEVEL set on the D-110 panel and Expression message.

Panpot

Status	Second	Third
BnH	0AH	vvH

vv = Panpot Value 00H - 7FH ( 0 - 127 )  
 n = MIDI Channel 0H - FH ( 1 - 16 )

Orientation of sound is as follows.

0 = LEFT, 63 = CENTER, 127 = RIGHT

Expression

Status	Second	Third
BnH	0BH	vvH

vv = Expression 00H - 7FH ( 0 - 127 )  
 n = MIDI Channel 0H - FH ( 1 - 16 )

Controls the volume of a Part accessible through the received MIDI channel. The maximum volume is determined by OUTPUT LEVEL set on the D-110 panel and Expression message.

Hold-1

Status	Second	Third
BnH	40H	vvH

vv = 00H - 7FH : OFF  
 vv = 40H - 7FH : On  
 n = MIDI Channel 0H - FH ( 1 - 16 )

RPC LSB

Status	Second	Third
BnH	64H	vvH

vv = The lower byte of a parameter number controlled by RPC. (Refer to RPC MSB.)  
 n = MIDI Channel 0H - FH ( 1 - 16 )

RPC MSB

Status	Second	Third
BnH	65H	vvH

vv = The upper byte of a parameter number controlled by RPC.  
 n = MIDI Channel 0H - FH ( 1 - 16 )

Using MIDI RPC, D-110 parameters can be controlled by Control Change message. RPC MSB and LSB specify the parameter to be controlled, while Data Entry sets the parameter value. Effective RPC to D-110 is Bender range.

RPC MSB	LSB	Data Entry	Description
00H	00H	vvH	Bender Range vv = 0 - 24 Unit in semitone, 2 octaves maximum

Reset All Controllers

Status	Second	Third
BnH	79H	00H

Sets each of the following controls as follows.

Controller	setting
Modulation Depth	OFF ( 0 )
Main Volume	MAX ( 127 )
Expression	MAX ( 127 )
Hold-1	OFF ( 0 )
Pitch Bender Change	CENTER

■ Program change

Patch / Timbre Change

Status	Second
CnH	ppH

pp = Patch Number 0H - 7FH ( 0 - 127 )  
 n = MIDI Channel 0H - FH ( 1 - 16 )

Program change information on the control channel changes patches. If the card to accommodate program numbers 40H-7FH is not available, D-110 selects an internal patch.

pp	I/C	BANK	NUMBER
00H ( 00 )	I	I	I
3FH ( 63 )	I	B	B
40H ( 64 )	C	I	I
7FH ( 127 )	C	B	B

Program change information on a channel other than control channel is used to change Timbres. Switching of Timbre between internal and card cannot be done through MIDI.

pp	A/B	BANK	NUMBER
00H ( 00 )	A	I	I
3FH ( 63 )	A	B	B
40H ( 64 )	B	I	I
7FH ( 127 )	B	B	B

■ Pitch Bender change

Pitch Bender

Status	Second	Third
BnH	vvH	vvH

vv = Pitch Bender change Value  
 n = MIDI Channel 0H - FH ( 1 - 16 )

■ Mode message

All notes off

Status	Second	Third
-----	-----	-----
BnH	7BH	0BH

n = MIDI Channel      0H - FH ( 1 - 16 )

Turns off all notes that have been turned on by MIDI Note on.

OMNI OFF

Status	Second	Third
-----	-----	-----
BnH	7CH	00H

n = MIDI Channel      0H - FH ( 1 - 16 )

Recognized as only All notes off.  
D-110 remains in mode 3 (Omni off, Poly).

OMNI ON

Status	Second	Third
-----	-----	-----
BnH	7DH	00H

n = MIDI Channel      0H - FH ( 1 - 16 )

Recognized as only All notes off.  
D-110 remains in mode 3 (Omni off, Poly).

MONO

Status	Second	Third
-----	-----	-----
BnH	7EH	0BH

nn = MONO channel range ignored  
n = MIDI Channel      0H - FH ( 1 - 16 )

Recognized as only All notes off.  
D-110 remains in mode 3 (Omni off, Poly).

POLY

Status	Second	Third
-----	-----	-----
BnH	7FH	00H

n = MIDI Channel      0H - FH ( 1 - 16 )

Recognized as only All notes off.  
D-110 remains in mode 3 (Omni off, Poly).

■ Exclusive

Status	Second	Third
-----	-----	-----
F0H		: System Exclusive
F7H		: EOX (End of Exclusive)

Using exclusive message, a set of parameters for a patch (timbre) or individual parameters in a patch, (timbre or tone can be transferred to D-110. Exclusive message can also be used for bulk dump/load of internal memory. Refer to Roland Exclusive Messages and Sections 4 and 5.

■ Active Sensing

Status	Second	Third
-----	-----	-----
FEH		: Active Sensing

Having received this message, D-110 expects to receive information of any status or data every 300ms (max). If D-110 fails to sense message, it assumes that MIDI bus is disconnected for some reason. Then D-110 turns off all notes which have been turned on by MIDI and returns to normal operation (will not check interval of messages).

3. RECOGNIZED RECEIVE DATA (Rhythmic part)

Messages on MIDI channels not assigned to rhythmic part are ignored.

■ Note event

Note off

Status	Second	Third
-----	-----	-----
RnH	kkH	vBH
9nH	kkH	00H

kk = note number 1BH - 6CH ( 24 - 108 )  
v = velocity ignored  
n = MIDI Channel      0H - FH ( 1 - 16 )

A time share envelope mode is NO SUS ignores this message.

Note on

Status	Second	Third
-----	-----	-----
BnH	kkH	vBH

kk = note number 1BH - 6CH ( 24 - 108 )  
v = velocity 01H - 7FH ( 1 - 127 )  
n = MIDI Channel      0H - FH ( 1 - 16 )

kkH numbers outside the range 24-108 are ignored.

■ Control change

Modulation Depth

Status	Second	Third
-----	-----	-----
BnH	01H	vBH

v = Modulation Depth 00H - 7FH ( 0 - 127 )  
n = MIDI Channel      0H - FH ( 1 - 16 )

Data Entry

Status	Second	Third
-----	-----	-----
BnH	06H	vBH

v = Value of a parameter specified by RPC.  
(See description in RPC MSH.)  
n = MIDI Channel      0H - FH ( 1 - 16 )

Main Volume

Status	Second	Third
-----	-----	-----
BnH	07H	vBH

v = Volume Value 00H - 7FH ( 0 - 127 )  
n = MIDI Channel      0H - FH ( 1 - 16 )

Can control the volume of the rhythmic part.  
The maximum volume is determined by OUTPUT LEVEL set on the panel and Expression message.

Expression

Status	Second	Third
-----	-----	-----
BnH	08H	vBH

v = Expression 00H - 7FH ( 0 - 127 )  
n = MIDI Channel      0H - FH ( 1 - 16 )

Can control the volume of the rhythmic part.  
The maximum volume is determined by OUTPUT LEVEL set on the panel and Main volume message.

Hold-1

Status	Second	Third
-----	-----	-----
BnH	40H	vBH

v = 00H - 3FH : Off  
v = 40H - 7FH : On  
n = MIDI Channel      0H - FH ( 1 - 16 )

RPC LSB

Status	Second	Third
-----	-----	-----
BnH	64H	vBH

v = Lower byte of a parameter number controlled by RPC.  
(See description in RPC MSH.)  
n = MIDI Channel      0H - FH ( 1 - 16 )

RPC MSH

Status	Second	Third
-----	-----	-----
BnH	65H	vBH

v = Upper byte of a parameter number controlled by RPC.  
n = MIDI Channel      0H - FH ( 1 - 16 )

MSB and LSB RPC together specifies parameter to be controlled while Data entry determines the value.  
Effective RPC on D-110 is Bender range.

RPC	LSB	Data Entry	Description
00H	00H	vBH	Bender range v = 0 - 24 2 octaves max. in semitone steps

Reset All Controllers

Status	Second	Third
-----	-----	-----
BnH	79H	00H

n = MIDI Channel      0H - FH ( 1 - 16 )

Set controllers to the value as shown below.

Controller	Setting
Modulation Depth	OFF ( 0 )
Main Volume	MAX ( 127 )
Expression	MAX ( 127 )
Hold-1	OFF ( 0 )
Pitch Bender Coarse	CENTER

■ Pitch Bender change

Status	Second	Third
-----	-----	-----
BnH	vBH	vBH

v = Pitch Bender change value  
n = MIDI Channel      0H - FH ( 1 - 16 )

■ Exclusive

Status	Second	Third
-----	-----	-----
F0H		: System Exclusive
F7H		: EOX (End of Exclusive)

Using exclusive message, a set of parameters for a patch (timbre) or individual parameters in a patch (timbre or tone) can be transferred to D-110. Exclusive message can also be used for bulk dump/load of internal memory. Refer to Roland Exclusive Messages and Sections 4 and 5.

4. EXCLUSIVE COMMUNICATION

Parameters for patches, timbres or tones can be transferred to/from D-110 through Exclusive message. Model-IDs of D-110 is 16H. In a system where more than one MIDI channel is assigned to D-110, Unit # may be set to the D-110 instead of Device-ID's of a basic channel. The advantage of Unit # is that a specific part is made accessible independent of MIDI channel of that part. Whether to use MIDI channel or Unit # is depend on parameter address. D-110 recognizes MIDI channels 1 thru 16 and Unit # 17 thru 32 as Device-ID #. Note that the actual Device-ID # is the number 1 less MIDI channel number or Unit #.

■ One Way Communication

Request Data 1	RQ1	11H
Byte	Description	
FDH	Exclusive status	
41H	Manufactures ID (Roland)	
DEV	Device ID	
16H	Model ID	
11H	Command ID	
aaH	Address MSB # 4-1	
aaH	Address LSB	
aaH	Size MSB	
aaH	Size	
aaH	Size LSB	
sum	Check sum	
F7H	End of exclusive	

Data set 1	DT1	12H
Byte	Description	
FDH	Exclusive status	
41H	Manufactures ID (Roland)	
DEV	Device ID	
16H	Model ID	
12H	Command ID	
aaH	Address MSB # 4-1	
aaH	Address LSB	
ddH	Data # 4-2	
sum	Check sum	
F7H	End of exclusive	

Communication Sequence

A. Starting at transmitting unit

Upon occurring each of the following events, D-110 sends parameters using one way communication. (Device-ID's is Unit's less 1)

- One way bulk dump is executed in data transfer mode. (Transfers a set of parameters selected.)
- Enter button is pressed in patch select mode. (Transfers parameters in the patch.)
- Enter button is pressed in timbre select mode. (Transfers a parameter set in the timbre.)
- Enter button is pressed while editing. (Transfers a parameter being edited.)

The following is an example of one way communication between two D-110's.

Receiver(D-110)	Transmitter(D-110)
-----	-----
	-----[DT1]
If the address matches the parameter base address, stores the data into that location.	Transmits this message when one of the above operations is taken place.
;	-----[DT1]
;	Will repeat sending data set until all requested data are received by the receiver.

B. Starting at receiver

D-110 never request data of the other party. The following sequence applies to the other party that wants to get some parameters from D-110.

Receiver	Transmitter(D-110)
-----	-----
	-----[RQ1]-----
When a programmer or sequencer needs D-110 resident parameter.	When the received data request contains 1) address that matches a parameter base address and 2) address size is 1 or more, D-110 sends the data in that area.
;	-----[DT1]
If the address matches the parameter base address, stores the data into that location.	
;	-----[DT1]
;	Will repeat sending data set 1 until all requested data are received by the receiver.

■ Handshaking Communications

want to send data	WSD	40H
Byte	Description	
FDH	Exclusive status	
41H	Manufactures ID (Roland)	
DEV	Device ID	
16H	Model ID	
40H	Command ID	
aaH	Address MSB # 4-1	
aaH	Address	
aaH	Address LSB	
aaH	Size MSB	
aaH	Size	
aaH	Size LSB	
sum	Check sum	
F7H	End of exclusive	

Request data	RQD	41H
Byte	Description	
FDH	Exclusive status	
41H	Manufactures ID (Roland)	
DEV	Device ID	
16H	Model ID	
41H	Command ID	
aaH	Address MSB # 4-1	
aaH	Address	
aaH	Address LSB	
aaH	Size MSB	
aaH	Size	
aaH	Size LSB	
sum	Check sum	
F7H	End of exclusive	

Data set	DAT	42H
Byte	Description	
FDH	Exclusive status	
41H	Manufactures ID (Roland)	
DEV	Device ID	
16H	Model ID	
42H	Command ID	
aaH	Address MSB # 4-1	
aaH	Address	
aaH	Address LSB	
aaH	Size MSB	
aaH	Size	
aaH	Size LSB	
sum	Check sum	
F7H	End of exclusive	

Acknowledge	ACK	43H
Byte	Description	
FDH	Exclusive status	
41H	Manufactures ID (Roland)	
DEV	Device ID	
16H	Model ID	
43H	Command ID	
F7H	End of exclusive	

End of data	EOD	45H
Byte	Description	
FDH	Exclusive status	
41H	Manufactures ID (Roland)	
DEV	Device ID	
16H	Model ID	
45H	Command ID	
F7H	End of exclusive	

Communication error	ERR	4EH
Byte	Description	
FDH	Exclusive status	
41H	Manufactures ID (Roland)	
DEV	Device ID	
16H	Model ID	
4EH	Command ID	
F7H	End of exclusive	

Rejection	RJC	4FH
Byte	Description	
FDH	Exclusive status	
41H	Manufactures ID (Roland)	
DEV	Device ID	
16H	Model ID	
4FH	Command ID	
F7H	End of exclusive	

Communication Sequence

A. Starting at transmitter

The following an example of handshaking communication between two D-110's.

Receiver(D-110)	Transmitter(D-110)
-----	-----
	-----[WSD]
	Executing handshaking (VPC bulk dump in the data transfer mode causes D-110 to send this message and enter into the following handshaking communication.
;	-----[RJC]-----
Will send Rejection when receiving the request while it is reproducing any sound.	Stops communication upon receiving this message.
;	-----[ACK]-----
If not reproducing any sound, sends this message and waits transmission of data.	Upon receiving this message, sends the next data.

-----[DAT]  
 If the address matches the parameter base address, stores the data into that location; then sends Acknowledge.  
 [ACK]-----  
 -----[DAT]  
 [ACK]-----  
 [ERR]-----  
 (Should failure in data reception (occur e.g. disagreement of checksum), sends this message.)  
 -----[DAT]

-----[EUD]  
 Upon receipt of this message, sends acknowledge and ceases current handshaking communication.  
 [ACK]-----  
 Upon receiving this message in reply to End of data, ends current communication.

**B. Starting at receiver**

D-110 will never require any data of the other party. The following sequence can apply to the outside world where a unit wants to get D-110 resident parameters.

Receiver: Transmitter (D-110)  
 -----  
 [REQ]-----  
 Outside unit such as a computer can obtain D-110 parameters by following the steps below, starting with transmission of Data request.  
 -----[RJC]  
 (Ends current communication upon receipt of this message.)  
 -----[DAT]  
 Will send this message when Data request comes while it is reproducing sound.  
 -----[DAT]  
 When the Data request comes during no-sound period and contains address listed in the Parameter base address table followed by 1 or more address size, D-110 will send the data stored in that address area and subsequent.

If the address matches the parameter base address, stores the data into that location; then sends Acknowledge.  
 [ACK]-----  
 -----[DAT]  
 [ACK]-----  
 [ERR]-----  
 (Should failure in data reception (occur e.g. disagreement of checksum), sends this message.)  
 -----[DAT]

-----[EOD]  
 Sends Acknowledge in response to Data end and terminates handshaking communication.  
 [ACK]-----  
 Sends this data when completing required data transfer.  
 -----  
 When this message comes as an answer to the Data end, terminates communication.

- \*4-1 Address and Address size must cover the memory location where data exist.
- \*4-2 When coming data are for partial reserve of the system parameter, D-110 will make these reserves effective only after receiving all the data.

**3. PARAMETER ADDRESS MAP**

Addresses are represented in 7-bit hexadecimal.

Address	MSB	LSB
Binary	0aaa aaaa	0bbb bbbb / 0ccc cccc
7-bit Hexadecimal	AA	BB / CC

The actual address of a parameter is a sum of the start address of each block and one or more offset address.

Parameter marked by	Actual address
*5-1	Start address plus two offset addresses (in tables *5-1 and *5-1-1)
*5-2	Start address plus one offset address (in table *5-2)
*5-3	Start address plus two offset addresses (in tables *5-1 and *5-1-2)
*5-4	Start address plus one offset address (in table *5-4)
*5-5	Start address plus two offset addresses (in tables *5-5 and *5-5-1)
*5-6 - *5-8	Start address plus one offset address (in table *5-6 - *5-8)

**Parameter Base Address**

Temporary area (Accessed through each basic channel)

Start address	Description	
02 00 00	Tone Temporary Area (whole part)	*5-1

Whole part (Accessible on INITs)

Start address	Description	
03 00 00	Timbre Temporary Area (part 1)	45-2
03 00 10	Timbre Temporary Area (part 2)	
03 00 80	Timbre Temporary Area (part 7)	
03 00 70	Timbre Temporary Area (part 8)	
03 01 00	Timbre Temporary Area (Rhythmic part)	
03 01 10	Rhythmic Setup Temporary Area	45-3
04 00 00	Tone Temporary Area (part 1)	45-4
04 01 76	Tone Temporary Area (part 2)	
04 0B 44	Tone Temporary Area (part 7)	
04 0D 3A	Tone Temporary Area (part 8)	
05 00 00	Timbre Memory #1	45-4
05 00 08	Timbre Memory #2	
05 07 70	Timbre Memory #127	
05 07 78	Timbre Memory #128	
06 00 00	Patch Memory #1	45-5
06 01 00	Patch Memory #2	
06 3E 00	Patch Memory #63	
06 3F 00	Patch Memory #64	
08 00 00	Tone Memory #1	45-6
08 02 00	Tone Memory #2	
08 7C 00	Tone Memory #63	
08 7E 00	Tone Memory #64	
10 00 00	System Area	45-6
20 00 00	Display	45-7
40 00 00	Write Request	45-8

**Notes :**

\*5-1 Tone temporary area / Tone memory

Offset address	Description	
00 00 00	Common parameter	45-1-1
00 00 0E	Partial parameter (for Partial# 1)	45-1-2
00 00 48	Partial parameter (for Partial# 2)	
00 01 02	Partial parameter (for Partial# 3)	
00 01 3C	Partial parameter (for Partial# 4)	

\*5-1-1 Common parameter

Offset address	Description	
00	0aaa aaaa TONE NAME 1	32 - 127 (ASCII)
09	0aaa aaaa TONE NAME 10	
0A	0000 aaaa Structure of Partial# 1 & 2	0 - 12 (1 - 13)
0B	0000 aaaa Structure of Partial# 3 & 4	0 - 12 (1 - 13)
0C	0000 aaaa PARTIAL MUTE	0 - 15 (0000 - 1111)
0D	0000 000a ENV MODE	0 - 1 (Normal, No sustain)
Total size		00 00 0E

\*5-1-2 Partial parameter

Offset address	Description	
00 00	0aaa aaaa WG PITCH COARSE	0 - 96 (C1, C#1 - C9)
00 01	0aaa aaaa WG PITCH FINE	0 - 100 (-50 - +50)
00 02	0000 aaaa WG PITCH KEYFOLLOW	0 - 16 (-1, -1/2, -1/4, 0, 1/8, 1/4, 3/8, 1/2, 5/8, 3/4, 7/8, 1, 5/4, 3/2, 2, 5/2, 3)
00 03	0000 000a WG PITCH BENDER SW	0 - 1 (OFF, ON)
00 04	0000 000a WG WAVEFORM/PCM BANK	0 - 3 (SQU/1, SAW/1, SQ/2, SAW/2)
00 05	0aaa aaaa WG PCM WAVE #	0 - 127 (1 - 128)
00 06	0aaa aaaa WG PULSE WIDTH	0 - 100
00 07	0000 aaaa WG PW VELO SENS	0 - 14 (-7 - +7)
00 08	0000 aaaa P-ENV DEPTH	0 - 10
00 09	0aaa aaaa P-ENV VELO SENS	0 - 100
00 0A	0000 000a P-ENV TIME KEYF	0 - 4
00 0B	0aaa aaaa P-ENV TIME 1	0 - 100
00 0C	0aaa aaaa P-ENV TIME 2	0 - 100
00 0D	0aaa aaaa P-ENV TIME 3	0 - 100
00 0E	0aaa aaaa P-ENV TIME 4	0 - 100
00 0F	0aaa aaaa P-ENV LEVEL 0	0 - 100 (-50 - +50)
00 10	0aaa aaaa P-ENV LEVEL 1	0 - 100 (-50 - +50)
00 11	0aaa aaaa P-ENV LEVEL 2	0 - 100 (-50 - +50)
00 12	0xxx xxxx P-ENV SUSTAIN LEVEL	50 (always 0)
00 13	0aaa aaaa END LEVEL	0 - 100 (-50 - +50)

00 14	0aaa aaaa	P-LFO RATE	0 - 100
00 15	0aaa aaaa	P-LFO DEPTH	0 - 100
00 16	0aaa aaaa	P-LFO MOD SENS	0 - 100
00 17	0aaa aaaa	TVF CUTOFF FREQ	0 - 100
00 18	000a aaaa	TVF RESONANCE	0 - 30
00 19	0000 aaaa	TVF KEYFOLLOW	0 - 14
			(-1, -1/2, -1/4, 0, 1/4, 1/2, 3/4, 1, 5/4, 3/2, 2)
00 1A	0aaa aaaa	TVF BIAS POINT/DIV	0 - 127
		(1A - <7C> 1A - >7C)	
00 1B	0000 aaaa	TVF BIAS LEVEL	0 - 14
		(-7 - +7)	
00 1C	0aaa aaaa	TVF ENV DEPTH	0 - 100
00 1D	0aaa aaaa	TVF ENV VELO SENS	0 - 100
00 1E	0000 aaaa	TVF ENV DEPTH KEYF	0 - 4
00 1F	0000 0aaa	TVF ENV TIME KEYF	0 - 4
00 20	0aaa aaaa	TVF ENV TIME 1	0 - 100
00 21	0aaa aaaa	TVF ENV TIME 2	0 - 100
00 22	0aaa aaaa	TVF ENV TIME 3	0 - 100
00 23	0aaa aaaa	TVF ENV TIME 4	0 - 100
00 24	0aaa aaaa	TVF ENV TIME 5	0 - 100
00 25	0aaa aaaa	TVF ENV LEVEL 1	0 - 100
00 26	0aaa aaaa	TVF ENV LEVEL 2	0 - 100
00 27	0aaa aaaa	TVF ENV LEVEL 3	0 - 100
00 28	0aaa aaaa	TVF ENV SUSTAIN LEVEL	0 - 100
00 29	0000 aaaa	TVA LEVEL	0 - 100
00 2A	0aaa aaaa	TVA VELO SENS	0 - 100
		(-50 - +50)	
00 2B	0aaa aaaa	TVA BIAS POINT 1	0 - 127
		(1A - <7C> 1A - >7C)	
00 2C	0000 aaaa	TVA BIAS LEVEL 1	0 - 12
		(-12 - 0)	
00 2D	0aaa aaaa	TVA BIAS POINT 2	0 - 127
		(1A - <7C> 1A - >7C)	
00 2E	0000 aaaa	TVA BIAS LEVEL 2	0 - 12
		(-12 - 0)	
00 2F	0000 0aaa	TVA ENV TIME KEYF	0 - 4
00 30	0000 0aaa	TVA ENV TIME V.FOLLOW	0 - 4
00 31	0aaa aaaa	TVA ENV TIME 1	0 - 100
00 32	0aaa aaaa	TVA ENV TIME 2	0 - 100
00 33	0aaa aaaa	TVA ENV TIME 3	0 - 100
00 34	0aaa aaaa	TVA ENV TIME 4	0 - 100
00 35	0aaa aaaa	TVA ENV TIME 5	0 - 100
00 36	0aaa aaaa	TVA ENV LEVEL 1	0 - 100
00 37	0aaa aaaa	TVA ENV LEVEL 2	0 - 100
00 38	0aaa aaaa	TVA ENV LEVEL 3	0 - 100
00 39	0aaa aaaa	TVA ENV SUSTAIN LEVEL	0 - 100
Total size			00 00 3A

Example of R01 and DT1 application --- 1

Assuming that D-110 sets Unit 1 to 17, obtain Part 2 tone data from the temporary area by sending the following message.

FD 43 10 16 11 04 01 76 00 01 76 0E F7

#5-2 Timbre temporary area

Offset address	Description
00 00	0000 0aaa TONE GROUP 0 - 3 (a, b, 1/c, r)
00 01	00aa aaaa TONE NUMBER 0 - 63 (1 - 64)
00 02	00aa aaaa KEY SHIFT 0 - 48 (-24 - +24)
00 03	0aaa aaaa FINE TUNE 0 - 100 (-50 - +50)
00 04	000a aaaa BENDER RANGE 0 - 24
00 05	0000 0aaa ASSIGN MODE 0 - 3 (POLY 1, POLY 2, POLY 3, POLY 4)
00 06	0000 0aaa OUTPUT ASSIGN 0 - 7 (MIX, MIN, MULTI 1, 2, 3, 4, 5, 6)
00 07	0xxx xxxx dummy
00 08	0aaa aaaa OUTPUT LEVEL 0 - 100
00 09	0000 0aaa PANPOT 0 - 14 (L - R)
00 0A	0aaa aaaa KEY RANGE LOWER 0 - 127
00 0B	0aaa aaaa KEY RANGE UPPER 0 - 127
00 0C	0xxx xxxx dummy
00 0D	0xxx xxxx dummy
Total size	00 00 10

#5-3 Rhythm part setup area

Offset address	Description
00 00 00	Rhythm Setup (for keys 24)
00 00 04	Rhythm Setup (for keys 25)
00 00 08	Rhythm Setup (for keys 26)
00 00 0C	Rhythm Setup (for keys 27)
00 00 10	Rhythm Setup (for keys 28)
00 02 40	Rhythm Setup (for keys 103)
00 02 50	Rhythm Setup (for keys 104)

#5-3-1 Rhythm setup (for each key #)

Offset address	Description
00 00	0aaa aaaa TONE 0 - 127 (01-164, r01-r64)
00 01	0aaa aaaa OUTPUT LEVEL 0 - 100
00 02	0000 0aaa PANPOT 0 - 14 (L - R)
00 03	0000 0aaa OUTPUT ASSIGN 0 - 7 (MIX, MIN, MULTI 1, 2, 3, 4, 5, 6)
Total size	00 00 04

#5-4 Timbre memory

Offset address	Description
00 00	0000 0aaa TONE GROUP 0 - 3 (a, b, 1/c, r)
00 01	00aa aaaa TONE NUMBER 0 - 63 (1 - 64)
00 02	00aa aaaa KEY SHIFT 0 - 48 (-24 - +24)
00 03	0aaa aaaa FINE TUNE 0 - 100 (-50 - +50)
00 04	000a aaaa BENDER RANGE 0 - 24
00 05	0000 0aaa ASSIGN MODE 0 - 3 (POLY 1, POLY 2, POLY 3, POLY 4)
00 06	0000 0aaa OUTPUT ASSIGN 0 - 7 (MIX, MIN, MULTI 1, 2, 3, 4, 5, 6)
00 07	0xxx xxxx dummy
Total size	00 00 08

#5-5 Patch memory

The total number of Partial reserves for 9 parts must be 32 or 16. All Partial reserves must be sent as a package of 9 parts.

Offset address	Description
00 00	0aaa aaaa PATCH NAME 1 32 - 127 (ASCII)
00 01	0aaa aaaa PATCH NAME 1
00 0A	0000 00aa REVERB MODE 0 - 8 (Room/2, Hall/2, Plate, Tap delay, 1/2/3, OFF)
00 0B	0000 0aaa REVERB TIME 0 - 7 (1 - 8)
00 0C	0000 0aaa REVERB LEVEL 0 - 7
00 0D	00aa aaaa PARTIAL RESERVE (Part 1) 0 - 32
00 0E	00aa aaaa PARTIAL RESERVE (Part 2) 0 - 32
00 0F	00aa aaaa PARTIAL RESERVE (Part 3) 0 - 32
00 10	00aa aaaa PARTIAL RESERVE (Part 4) 0 - 32
00 11	00aa aaaa PARTIAL RESERVE (Part 5) 0 - 32
00 12	00aa aaaa PARTIAL RESERVE (Part 6) 0 - 32
00 13	00aa aaaa PARTIAL RESERVE (Part 7) 0 - 32
00 14	00aa aaaa PARTIAL RESERVE (Part 8) 0 - 32
00 15	00aa aaaa PARTIAL RESERVE (Part 9) 0 - 32
00 16	000a aaaa MIDI CHANNEL (Part 1) 0 - 16 (1 - 16, OFF)
00 17	000a aaaa MIDI CHANNEL (Part 2) 0 - 16
00 18	000a aaaa MIDI CHANNEL (Part 3) 0 - 16
00 19	000a aaaa MIDI CHANNEL (Part 4) 0 - 16
00 1A	000a aaaa MIDI CHANNEL (Part 5) 0 - 16
00 1B	000a aaaa MIDI CHANNEL (Part 6) 0 - 16
00 1C	000a aaaa MIDI CHANNEL (Part 7) 0 - 16
00 1D	000a aaaa MIDI CHANNEL (Part 8) 0 - 16
00 1E	000a aaaa MIDI CHANNEL (Part 9) 0 - 16
00 1F	00aa aaaa PATCH PARAMETERS (Part 1) #5-5-1
00 20	00aa aaaa PATCH PARAMETERS (Part 2)
00 21	00aa aaaa PATCH PARAMETERS (Part 3)
00 22	00aa aaaa PATCH PARAMETERS (Part 4)
00 23	00aa aaaa PATCH PARAMETERS (Part 5)
00 24	00aa aaaa PATCH PARAMETERS (Part 6)
00 25	00aa aaaa PATCH PARAMETERS (Part 7)
00 26	00aa aaaa PATCH PARAMETERS (Part 8)
00 27	00aa aaaa PATCH PARAMETERS (Part 9)
00 2F	0aaa aaaa OUTPUT LEVEL (Rhythm Part) 0 - 100
Total size	00 01 00

#5-5-1 Patch parameters (for each part)

Offset address	Description
00 00	0000 0aaa TONE GROUP 0 - 3 (a, b, 1/c, r)
00 01	00aa aaaa TONE NUMBER 0 - 63 (1 - 64)
00 02	00aa aaaa KEY SHIFT 0 - 48 (-24 - +24)
00 03	0aaa aaaa FINE TUNE 0 - 100 (-50 - +50)
00 04	000a aaaa BENDER RANGE 0 - 24
00 05	0000 0aaa ASSIGN MODE 0 - 3 (POLY 1, POLY 2, POLY 3, POLY 4)
00 06	0000 0aaa OUTPUT ASSIGN 0 - 7 (MIX, MIN, MULTI 1, 2, 3, 4, 5, 6)
00 07	0xxx xxxx dummy
00 08	0aaa aaaa OUTPUT LEVEL 0 - 100
00 09	0000 0aaa PANPOT 0 - 14 (L - R)
00 0A	0aaa aaaa KEY RANGE LOWER 0 - 127
00 0B	0aaa aaaa KEY RANGE UPPER 0 - 127
Total size	00 00 0C

#5-6 System area

The total number of Partial reserves for 9 parts must be 32 or 16. All Partial reserves must be sent as a package of 9 parts.

Offset address	Description
00 00	0aaa aaaa MASTER TUNE 0 - 127 (437.5Hz - 457.5Hz)
00 01	0000 00aa REVERB MODE 0 - 8 (Room/2, Hall/2, Plate, Tap delay, 1/2/3, OFF)
00 02	0000 0aaa REVERB TIME 0 - 7 (1 - 8)
00 03	0000 0aaa REVERB LEVEL 0 - 7
00 04	00aa aaaa PARTIAL RESERVE (Part 1) 0 - 32
00 05	00aa aaaa PARTIAL RESERVE (Part 2) 0 - 32
00 06	00aa aaaa PARTIAL RESERVE (Part 3) 0 - 32
00 07	00aa aaaa PARTIAL RESERVE (Part 4) 0 - 32
00 08	00aa aaaa PARTIAL RESERVE (Part 5) 0 - 32
00 09	00aa aaaa PARTIAL RESERVE (Part 6) 0 - 32
00 0A	00aa aaaa PARTIAL RESERVE (Part 7) 0 - 32
00 0B	00aa aaaa PARTIAL RESERVE (Part 8) 0 - 32
00 0C	00aa aaaa PARTIAL RESERVE (Part 9) 0 - 32

MIDI Implementation Chart

Function...		Transmitted	Recognized	Remarks
Basic Channel	Default	1-16	1-16	memorized
	Changed	1-16	1-16	
Mode	Default	X	3	
	Messages	X	X	
	Altered	*****		
Note Number	True Voice	X	0-127	
		*****	12-108	
Velocity	Note ON	X	O v=1-127	
	Note OFF	X	X	
After Touch	Key's	X	X	
	Ch's	X	X	
Pitch Bender		X	O	
Control Change	1	X	O	Modulation
	2-5	X	X	
	6	X	**	Data Entry
	7	X	O	Volume
	8-9	X	X	
	10	X	O	Pan
	11	X	O	Expression
	12-63	X	X	
	64	X	O	Hold1
	65-99	X	X	
	100, 101	X	** (0)	RPC LSB, MSB
	102-120	X	X	
121	X	O	Reset all Controllers	
Prog Change	True #	X	O 0-127	
		*****	0-127	
System Exclusive		*	*	
System Common	Song Pos	X	X	
	Song Sel	X	X	
	Tune	X	X	
System Real Time	Clock	X	X	
	Commands	X	X	
Aux Message	Local ON/OFF	X	X	
	All Notes OFF	X	O (123-127)	
	Active Sense	X	O	
	Reset	X	X	
Notes		* Can be set to O or X by manual operation. ** RPC=Registered Parameter Control Number RPC #0 : Pitch Bend Sensitivity The value of parameter is to be determined by entering data.		

Mode 1 : OMNI ON, POLY  
 Mode 3 : OMNI OFF, POLY

Mode 2 : OMNI ON, MONO  
 Mode 4 : OMNI OFF, MONO

O : Yes  
 X : No

00 00	000a 000a	MIDI CHANNEL(Part 1)	0 - 10 (1 - 16,OFF)
00 0E	000a 000a	MIDI CHANNEL(Part 2)	0 - 16 (1 - 16,OFF)
00 0F	000a 000a	MIDI CHANNEL(Part 3)	0 - 16 (1 - 16,OFF)
00 10	000a 000a	MIDI CHANNEL(Part 4)	0 - 16 (1 - 16,OFF)
00 11	000a 000a	MIDI CHANNEL(Part 5)	0 - 16 (1 - 16,OFF)
00 12	000a 000a	MIDI CHANNEL(Part 6)	0 - 16 (1 - 16,OFF)
00 13	000a 000a	MIDI CHANNEL(Part 7)	0 - 16 (1 - 16,OFF)
00 14	000a 000a	MIDI CHANNEL(Part 8)	0 - 16 (1 - 16,OFF)
00 15	000a 000a	MIDI CHANNEL(Part R)	0 - 16 (1 - 16,OFF)
00 16	0xxx 0xxx	dummy	
00 17	0aaa 0aaa	PATCH NAME 1	32 - 127 (ASCII)
00 20	0aaa 0aaa	PATCH NAME 10	
Total size		00	

Example of RQ1 and DT1 application --- 2

Assuming that D-110 sets Unit # to 17, set Partial reserve of each part as follows by sending the byte string listed below.  
 Part 1 ..... 8                    Parts 3 thru 8 ..... 0  
 Part 2 ..... 10                   Rhythm part ..... 8  
 FG 41 10 16 12 10 00 04 06 0A 00 00 00 00 00 00 00 66 F7

#5-7 Display

D-110 deciphers incoming data and sends them to the LCD as a string of ASCII code characters. (In play mode)  
 Fiddling D-110 panel switches or sending Display reset address data to D-110 returns the display to the normal reading.  
 No display data in this area can be brought outside world by the use of RQ1 and RQD.

Offset address	Description
00 00	0aaa 0aaa DISPLAY LETTER (32 - 127 (ASCII))
00 1F	0aaa 0aaa DISPLAY LETTER (ASCII)
01 00	0xxx 0xxx DISPLAY RESET
Total size 00 00 21	

#5-8 Write request

This message simulates write switch on D-110, that is, D-110 writes data of each part in the temporary area into internal memory or memory card. Memory must be specified by two bytes addresses. D-110 will inform back of the writing result. No data in the temporary area can be brought outside world through MIDI exclusive message such as RQ1 and RQD.

Offset address	Description
00 00	00aa 00aa Tone Write (part 1) 0 - 63 (01 - 64) 0, 1 (Internal,Card)
00 01	0000 000a
00 02	00aa 00aa Tone Write (part 2)
00 03	0000 000a
00 0E	00aa 00aa Tone Write (part 8)
00 0F	0000 000a
01 00	0aaa 0aaa Timbre Write (part 1) 0 - 127 (A11 - B88) 0, 1 (Internal,Card)
01 01	0000 000a
01 02	0aaa 0aaa Timbre Write (part 2)
01 03	0000 000a
01 0E	0aaa 0aaa Timbre Write (part 8)
01 0F	0000 000a
02 00	00aa 00aa Patch Write 0 - 63 (11 - 88) 0, 1 (Internal,Card)
02 01	0000 000a
10 00	0000 00aa Result 0 - 3 0 = Function Completed 1 = Card Not Ready 2 = Write Protected 3 = Incorrect Mode

Example of RQ2 and DT1 application --- 3

Assuming that D-110 sets Unit # to 17, direct D-110 to write data of Part 3 in the temporary area into 1-B24 by sending the byte string listed below.  
 FD 41 10 16 12 40 01 04 4B 00 70 F7

Address	Block	Sub Block	Memory
02 00 00	Tone Temp. (Basic Ch)	Common	5-1-1
		Partial 1	5-1-2
		Partial 2	
		Partial 3	
		Partial 4	
03 00 00	Timbre Temp. (Unit)	Part 1	5-2
		Part 2	
		Part 8	
		Part R	
03 01 10	Rhythm Setup Temp.(Unit)	Notes 24	5-3
		Notes 25	
		Notes 107	
		Notes 108	
04 00 00	Tone Temp. (Unit)	Part 1	5-4
		Part 2	
		Part 7	
		Part 8	
05 00 00	Timbre Memory	1-A11 (# 1)	5-4
		1-A12 (# 2)	
		1-BB7 (#127)	
		1-BB8 (#128)	
06 00 00	Patch Memory	1-A11 (# 1)	5-5
		1-A12 (# 2)	
		1-BB7 (# 63)	
		1-BB8 (# 64)	
08 00 00	Tone Memory	1-01	5-1
		1-02	
		1-63	
		1-64	
10 00 00	System A		5-6
20 00 00	Display		5-7
40 00 00	Write Req		5-8



## ■ SPECIFICATIONS

### D-110 : Multi Timbral Sound Module

#### •Sound source

LA System

Maximum Voices : 32 Voices

#### •Memory

Patches : 64

Timbres : 128

Preset Tones : 128

Programmable Tones : 64

Preset Rhythm Tones : 63

#### •Memory Card

[M-256D]

Patches : 64

Timbres : 128

Tones : 64

Rhythm Setups : One Set

[M-128D]

Patches : 32

Timbres : 128

Tones : 32

Rhythm Setups : One Set

[Front Panel]

Volume Knob

Exit Button

Patch Button

Timbre Button

Edit Button

Part Button

System Button

Write/Copy Button

Enter Button

Part Select Button x 2

Parameter/Group Button x 2

Parameter/Bank Button x 2

Value/Number Button x 2

Headphones Socket

Memory Card Slot

[Display]

2 lines, 16 letter (back—lit)

[Indicator]

MIDI Message Indicator

[Rear Panel]

Mix Output Socket x 2

Multi Output Socket x 6

MIDI Connectors (IN/OUT/THRU)

Dimensions : 482 (W) x 286 (D) x 44 (H) mm

19" x 11-¼" x 1-¾"

Weight : 3.7 kg / 8 lb 3 oz

Consumption : 12 W

Accessories :

Owner's Manual

Operation Mode/Preset Tone Table

Tone Parameter/PCM Sound Table

Guide Book for MIDI

MIDI Cable (1m) x 1

Connection Cable (LP-25) x2

[Options]

Memory Card (RAM) : M-256D, M-128D

Programmer : PG-10

Stereo Headphones : RH-100

MIDI/SYNC Cable : MSC-07/15/25/50/100

# INDEX

Bender Range	43	Partial Rsserve	70
Bender Switch	56	Patch	10, 37, 108
Bias Level	62, 65	Patch Edit	11, 40
Bias Point	62, 65	Patch Name	41
Common	53	Patch Select	11
Control Channel	30, 81	Patch Write	28, 71
Cutoff Frequency	61	PCM Sound Generator	43
Data Transfer	12, 83	Pitch Coarse	55
Depth (TVF)	63	Pitch ENV	55
ENV Depth (TVF)	63	Pitch ENV Depth	59
ENV Mode	55	Pitch ENV Time/Level	60
ENV Time/Level (TVA)	66	Pitch Fine	55
ENV Time/Level (TVF)	64	Preset Rhythm Tones	101
Exclusive Unit Number	82	Program Change	19, 30
Fine Tune	43	Protect Switch	71, 85
Handshake	86	Pulse Width	59
Key Follow (Frequency)	62	RAM Card	21
Key Follow (Pitch)	56	RCM Wave Bank/Number	57
Key Follow (Pitch ENV Time)	60	Resonance	61
Key Follow (Time TVA)	64	Reverb	10, 25
Key Follow (Time TVF)	64	Reverb Level	26, 41
Key Range	70	Reverb Time	26, 41
Key Shift	43	Reverb Type	26, 41
LA Synthesis	10, 90	Rhythm Part	10, 22, 102, 108, 109
Level	23, 60, 65	Rhythm Setup	12, 39, 77, 100
LFO Depth	61	Ring Modulator	46, 93
LFO Rate	61	ROM Card	21
Load from Card	86	ROM Play	88
Loading	83	Save to Card	85
Master Tuning	23, 80	Saving	83
Maximum Voices	14	Structure	54, 92, 94
Memory Card	11, 20, 85, 109	Synthesizer Sound Generator	45
Memory Protect	81	System Setup	39, 80, 100
MIDI Channel	16, 17	Timbre	10, 13, 36
Modulation Sensitivity	61	Timbre Edit	11, 42
Multi Output	10, 44, 108	Timbre Select	11, 18
Multi Timbre Function	10	Tone	10, 36, 78, 106
One-Way	86	Tone (Rhythm Edit)	78
Output Assign (Part Setting)	44	Tone Copy	51
Output Assign (Rhythm Setting)	79	Tone Edit	11, 45
Output Level (Part Setting)	23, 69	Tone Select	43
Output Level (Rhythm Setting)	78	TVA (Time Variant Amplifier)	48
Overflow Assign Switch	82	TVF (Time Variant Filter)	48
Pan	24, 69	Velocity Sensitivity (Pitch ENV)	59
Pan (Rhythm Edit)	79	Velocity Sensitivity (Pulse Width)	59
Part	10	Velocity Sensitivity (Time 1 TVA)	66
Part Setting	12, 68, 100, 108	Velocity Sensitivity (TVA)	65
Partial	12, 94	Velocity Sensitivity (TVF ENV)	63
Partial Copy	52	WG (Wave Generator)	47
Partial Mute	54, 93	Writing	71

# ROM PLAY

8 different tunes are preprogrammed in the D-110 so that you can experience the excellent effect of the Multi Timbre function. Playing these tunes is called ROM play in this manual. To obtain the best effect of the Multi Timbre function, use a stereo amplifier, if possible.

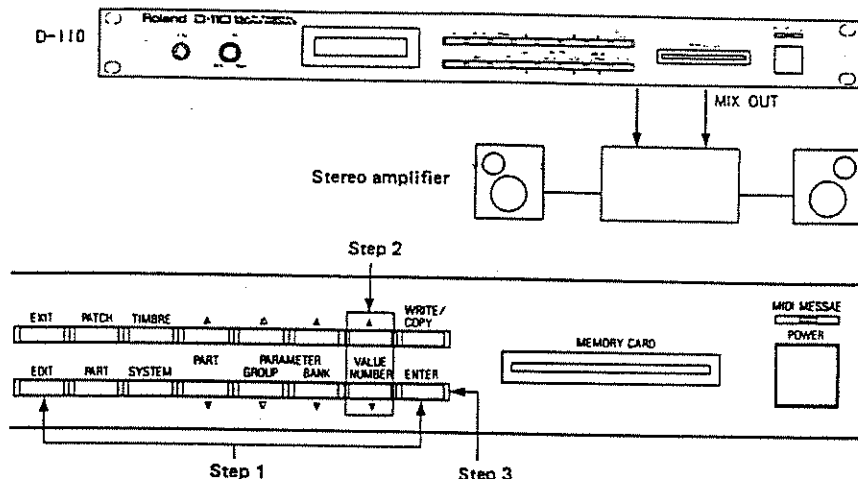

**Step 1** Turn the unit to the Play mode, then push the EDIT button while holding the ENTER button down. The Display responds with:

```
12345678R RomPlay
Chain of Songs
```

If you keep holding the ENTER button down, Songs 1 to 8 will be played in sequence.

**Step 2** Select the song to be played with the VALUE/NUMBER ( ▲▼ ) buttons.

```
12345678R RomPlay
01: Macho Memory
```

Song number ———— Song name

**Step 3** Push the ENTER button to play the song you have selected.

- To stop playing, push the VALUE/NUMBER ( ▲▼ ) buttons, or EXIT.
- Pushing the EXIT button while no song is being played will return to the Play mode.

ROM Play Song Table

Song Number	Song Name	
1	Macho Memory	Music by Eric Persing (c) 1988 by Eric Persing
2	Jah May Kah!	Music by Amn Bhatia (c) 1988 by Amn Bhatia
3	Sugar Plum	Composed by Tchaikovski Arranged by Amn Bhatia
4	My Brother	Music by Adrian Scott (c) 1988 by Adrian Scott
5	Folk	Music by Amn Bhatia (c) 1988 by Amn Bhatia
6	Bumble Dee	Composed by Rymnsky-Kovsakow Arranged by Amn Bhatia
7	Mergatroid	Music by Eric Persing (c) 1988 by Eric Persing
8	Dinner Set	Music by Adrian Scott (c) 1988 by Adrian Scott



# Roland

# D-110

## PATCH SETTING CHART

D-110には、リバーブや各パートの設定をパッチとして64種類記憶することができ、演奏曲や使い方に合ったセッティングに素早く切り換えることができます。

パッチの切り換えはパネル操作だけでなく、MIDIコントローラーからのプログラム・チェンジ情報で切り換えることができます。(オーナーズ・マニュアルP.29、P.80参照)

工場出荷時の64種類のパッチには、シーケンサーなどを使ってアンサンブル演奏を行なう場合のセッティングの他に、MIDIキーボードの拡張音源として使う場合のセッティングなどが用意されています。これらのセッティングを参考に、オリジナルのパッチを作ってください。

### →バンク1~4

シーケンサーなどを使ってアンサンブル演奏を行なう場合のセッティングが、各種用意されています。

### →バンク5

MIDIキーボードを使う場合のセッティングが用意されています。キー・レンジの設定で音域ごとにパートが割り振られていますので、複数の音色を同時に扱うことができます。

### →バンク6

MIDIキーボードを使う場合のセッティングが用意されています。ナンバー1~4は、キー・レンジとパンの設定で音域ごとに音の定位を変化させることができます。ナンバー5~8は、各パートにリズム音が割り当てられており、キー・レンジとパンの設定で広がりのあるリズム演奏が楽しめます。

### →バンク7

MIDIキーボードを使う場合のセッティングが用意されています。2つのパートを1組として、異なった音色をユニゾンで演奏することができます。

### →バンク8

モノ・モード対応のギター・コントローラーを使う場合のセッティングが用意されています。

D-110 is capable of memorizing 64 kinds of patch settings for revives and parts. The settings can be switched rapidly to suit the performance and usage.

The patches can be switched not only by panel operation but also by switching the program change information from the MIDI controller. (Refer to the Owner's Manual, p.29 and p.80.)

The 64 kinds of factory-set patches include settings such as those used for extending the sound source of the MIDI keyboard as well as the settings for ensemble performances using a sequencer. You can create your original patches referring to these settings.

### → Banks 1-4

All types of settings for ensemble performances using a sequencer have been readied.

### → Bank 5

The setting is for using the MIDI keyboard. The key range setting divides the key range for each part, so multiple notes can be handled at the same time.

### → Bank 6

This is set up for using the MIDI keyboard. With numbers 1 to 4, the set position of the key can be changed for each key range by setting the key range and pan. With numbers 5 to 8, the rhythm sounds are divided among the parts, so that you can enjoy performing over a wide rhythm range with the key range and pan settings.

### → Bank 7

This is set up for using the MIDI keyboard. Two parts can be combined, so that different notes can be played in unison.

### → Bank 8

This setting is for using a guitar controller in mono mode.

# BANK 1 Ensemble Play

アンサンブル演奏用 (MIDI Ch.2~10)

Tone Name  
Pan  
Key Range  
MIDI Ch.  
Partial Reserve

Part No.	1	2	3	4	5	6	7	8	R	Remarks
1	Acou Bass 1 3> C-1 ~ G 9 2 4	Acou Piano 2 <3 + 3 8	Guitar 1 1> + 4 +	Trumpet 2 <1 + 5 2	Trombone 1 5> + 6 +	Sax 1 <5 + 7 +	Sax 3 7> + 8 0	Strings 3 <7 + 9 + 10 6	----- ----- ----- ----- ----- -----	Jazz Band 1
2	Fretless 2 3> C-1 ~ G 9 2 4	Acou Piano 3 <3 + 3 8	Trumpet 1 1> + 4 +	Sax 3 <1 + 5 2	Trombone 1 5> + 6 +	Sax 1 <5 + 7 +	Flute 2 7> + 8 0	Strings 3 <7 + 9 + 10 6	----- ----- ----- ----- ----- -----	Jazz Band 2
3	Elec Bass 1 3> C-1 ~ G 9 2 4	Elec Piano 3 <3 + 3 8	Sax 1 1> + 4 +	Flute 2 <1 + 5 2	Brass 2 5> + 6 +	Strings 2 <5 + 7 +	Chorale 7> + 8 0	Steel Drum <7 + 9 + 10 6	----- ----- ----- ----- ----- -----	Fusion 1
4	Elec Bass 2 3> C-1 ~ G 9 2 4	Acou Piano 1 <3 + 3 8	Sax 3 1> + 4 +	Elec Gtr 1 <1 + 5 2	Trumpet 2 5> + 6 +	Clav 2 <5 + 7 +	Elec Organ 2 7> + 8 0	Harmonica <7 + 9 + 10 6	----- ----- ----- ----- ----- -----	Fusion 2
5	Acou Bass 2 3> C-1 ~ G 9 2 4	Acou Piano 2 <3 + 3 8	Elec Organ 3 1> + 4 +	Atmosphere <1 + 5 2	Harmonica 5> + 6 +	Strings 3 <5 + 7 +	Engl Horn 7> + 8 0	Tube Bell <7 + 9 + 10 6	----- ----- ----- ----- ----- -----	Fusion 3
6	Elec Bass 2 3> C-1 ~ G 9 2 4	Stream Pad <3 + 3 8	Brass 1 1> + 4 +	Syn Lead 2 <1 + 5 2	Trumpet 2 5> + 6 +	Strings 3 <5 + 7 +	Elec Gtr 1 7> + 8 0	Slap Bass 1 <7 + 9 + 10 6	----- ----- ----- ----- ----- -----	Electric Fusion 1
7	Slap Bass 1 3> C-1 ~ G 9 2 4	Reso Synth <3 + 3 8	Elec Gtr 2 1> + 4 +	Sax 3 <1 + 5 2	Elec Piano 4 5> + 6 +	Flute 2 <5 + 7 +	Steel Drum 7> + 8 0	Elec Bass 2 <7 + 9 + 10 6	----- ----- ----- ----- ----- -----	Electric Fusion 2
8	Syn Bass 1 3> C-1 ~ G 9 2 4	Acou Piano 1 <3 + 3 8	Elec Piano 4 1> + 4 +	Elec Gtr 2 <1 + 5 2	Flute 2 5> + 6 +	Brass 3 <5 + 7 +	Strings 3 7> + 8 0	Bottleblow <7 + 9 + 10 6	----- ----- ----- ----- ----- -----	Electric Fusion 3

# BANK 2 Ensemble Play

アンサンブル演奏用 (MIDI Ch.2~10)

Tone Name  
Pan  
Key Range  
MIDI Ch.  
Partial Reserve

Part No.	1	2	3	4	5	6	7	8	R	Remarks
1	Slap Bass 2 3> C-1 ~ G 9 2 4	Elec Gtr 1 <3 + 3 8	Guitar 1 1> + 4 +	Brass 3 <1 + 5 2	Brass 4 5> + 6 +	Syn Lead 2 <5 + 7 +	Marimba 7> + 8 0	Slap Bass 1 <7 + 9 + 10 6	----- ----- ----- ----- ----- -----	Funky Rock Ensemble 1
2	Slap Bass 1 3> C-1 ~ G 9 2 4	Clav 3 <3 + 3 8	Elec Gtr 1 1> + 4 +	Trumpet 2 <1 + 5 2	Sax 2 5> + 6 +	Elec Organ 4 <5 + 7 +	Fantasy 7> + 8 0	Orche Hit <7 + 9 + 10 6	----- ----- ----- ----- ----- -----	Funky Rock Ensemble 2
3	Syn Bass 2 3> C-1 ~ G 9 2 4	Elec Gtr 1 <3 + 3 8	Elec Organ 3 1> + 4 +	Acou Piano 2 <1 + 5 2	Marimba 5> + 6 +	Marimba <5 + 7 +	Syn Lead 1 7> + 8 0	Brass 1 <7 + 9 + 10 6	----- ----- ----- ----- ----- -----	Euro Rock Ensemble 1
4	Elec Bass 2 3> C-1 ~ G 9 2 4	Elec Organ 2 <3 + 3 8	Brass 2 1> + 4 +	Elec Piano 3 <1 + 5 2	Strings 3 5> + 6 +	Atmosphere <5 + 7 +	Elec Gtr 1 7> + 8 0	Glock <7 + 9 + 10 6	----- ----- ----- ----- ----- -----	Euro Rock Ensemble 2
5	Elec Bass 1 3> C-1 ~ G 9 2 4	Elec Organ 3 <3 + 3 8	Elec Gtr 1 1> + 4 +	Elec Gtr 2 <1 + 5 2	Brass 2 5> + 6 +	Syn Lead 1 <5 + 7 +	Strings 3 7> + 8 0	Reverse Cym <7 + 9 + 10 6	----- ----- ----- ----- ----- -----	Heavy Metal 1
6	Elec Bass 2 3> C-1 ~ G 9 2 4	Syn Lead 3 <3 + 3 8	Elec Gtr 2 1> + 4 +	Vibe String <1 + 5 2	Brass 3 5> + 6 +	Syn Lead 1 <5 + 7 +	Strings 3 7> + 8 0	Tech Snare <7 + 9 + 10 6	----- ----- ----- ----- ----- -----	Heavy Metal 2
7	Syn Bass 2 3> C-1 ~ G 9 2 4	Acou Piano 1 <3 + 3 8	Brass 1 1> + 4 +	Ice Rains <1 + 5 2	Chorale 5> + 6 +	Tube Bell <5 + 7 +	Elec Organ 2 7> + 8 0	Strings 3 <7 + 9 + 10 6	----- ----- ----- ----- ----- -----	Progressive Rock 1
8	Syn Bass 3 3> C-1 ~ G 9 2 4	Acou Piano 1 <3 + 3 8	Brass 4 1> + 4 +	Warm Bell <1 + 5 2	Glares 5> + 6 +	Bell Swing <5 + 7 +	Elec Organ 3 7> + 8 0	Glock <7 + 9 + 10 6	----- ----- ----- ----- ----- -----	Progressive Rock 2



# BANK 5 Multi Split

## マルチ・スプリット (MIDI Ch.1)

Tone Name  
Pan  
Key Range  
MIDI Ch.  
Partial Reserve

Part No.	1	2	3	4	5	6	7	8	R	Remarks
1	Slap Bass 2 >< C-1 ~ B3 1 8	Bass 1 + C4 ~ G9 24	Fretless 2 + C-1 ~ G9 OFF 0	Steam Pad + + +	Trumpet 2 + + +	Honky-Tonk + + +	Sitar + + +	One Note Jam + + +	=====	Split 1
2	Slap Bass 1 >< C-1 ~ B3 1 8	Syn Lead 1 + C4 ~ G9 24	Fretless 2 + C-1 ~ G9 OFF 0	Steam Pad + + +	Trumpet 2 + + +	Honky-Tonk + + +	Sitar + + +	One Note Jam + + +	=====	Split 2
3	Elec Piano 1 >< C-1 ~ B3 1 24	Flute 1 + C4 ~ G9 8	Fretless 2 + C-1 ~ G9 OFF 0	Steam Pad + + +	Trumpet 2 + + +	Honky-Tonk + + +	Sitar + + +	One Note Jam + + +	=====	Split 3
4	Elec Piano 1 >< C-1 ~ B3 1 20	Fantasy + C4 ~ G9 12	Fretless 2 + C-1 ~ G9 OFF 0	Steam Pad + + +	Trumpet 2 + + +	Honky-Tonk + + +	Sitar + + +	One Note Jam + + +	=====	Split 4
5	Strings 3 >< C-1 ~ B3 1 24	Flute 2 + C4 ~ G9 8	Fretless 2 + C-1 ~ G9 OFF 0	Steam Pad + + +	Trumpet 2 + + +	Honky-Tonk + + +	Sitar + + +	One Note Jam + + +	=====	Split 5
6	Koto >< C-1 ~ B3 1 24	Pan Pipes + C4 ~ G9 8	Fretless 2 + C-1 ~ G9 OFF 0	Steam Pad + + +	Trumpet 2 + + +	Honky-Tonk + + +	Sitar + + +	One Note Jam + + +	=====	Split 6
7	Bass Drum 1 >< C-1 ~ B2 1 4	Snare Drum 1 + C3 ~ B3 2	Slap Bass 1 + C-1 ~ B3 6	Hand Clap + C4 ~ D#4 2	Syn Lead 1 + E4 ~ B5 12	Fantasy + C6 ~ G9 8	Honky-Tonk + C-1 ~ G9 OFF 0	Pipe Organ 1 + + +	=====	Split Variation 1
8	Syn Bass 1 >< C-1 ~ C3 1 8	Syn Lead 3 + C-1 ~ B3 + +	Soundtrack + C-1 ~ G9 16	Fantasy + + OFF 0	Strings 4 + + +	Atmospher + + +	Honky-Tonk + + +	Pipe Organ 1 + + +	=====	Split Variation 2

# BANK 6 Multi Split

## マルチ・スプリット (MIDI Ch.1)

Tone Name  
Pan  
Key Range  
MIDI Ch.  
Partial Reserve

Part No.	1	2	3	4	5	6	7	8	R	Remarks
1	Acou Piano 1 7> C-1 ~ F2 1 4	+> F#2 ~ C#3 + +	+> D3 ~ A3 + +	+> A#3 ~ F4 + +	+< F#4 ~ C#5 + +	+< D5 ~ A5 + +	+< A#5 ~ F6 + +	+< F#6 ~ G9 + +	=====	Pan 1
2	Elec Piano 1 7> C-1 ~ F2 1 4	+> F#2 ~ C#3 + +	+> D3 ~ A3 + +	+> A#3 ~ F4 + +	+< F#4 ~ C#5 + +	+< D5 ~ A5 + +	+< A#5 ~ F6 + +	+< F#6 ~ G9 + +	=====	Pan 2
3	Strings 3 7> C-1 ~ F2 1 4	+> F#2 ~ C#3 + +	+> D3 ~ A3 + +	+> A#3 ~ F4 + +	+< F#4 ~ C#5 + +	+< D5 ~ A5 + +	+< A#5 ~ F6 + +	+< F#6 ~ G9 + +	=====	Pan 3
4	Syn Lead 1 7> C-1 ~ F2 1 4	+> F#2 ~ C#3 + +	+> D3 ~ A3 + +	+> A#3 ~ F4 + +	+< F#4 ~ C#5 + +	+< D5 ~ A5 + +	+< A#5 ~ F6 + +	+< F#6 ~ G9 + +	=====	Pan 4
5	Bass Drum 1 1> C-1 ~ B2 1 4	Snare Drum 1 <1 C3 ~ F3 + +	Cld Hi Hat 1 <3 F#3 ~ B3 + +	Hi Tom Tom 1 <5 C4 ~ F4 + 2	Mid Tom Tom 1 1> F#4 ~ B4 + +	Low Tom Tom 1 5> C5 ~ F5 + +	Crash Cym <5 F#5 ~ B5 4 +	China Cym 5> C6 ~ G9 + +	=====	Drum Set 1
6	Bass Drum 2 1> C-1 ~ B2 1 4	Snare Drum 3 <1 C3 ~ F3 + +	Cld Hi Hat 1 <3 F#3 ~ B3 + +	Hi Tom Tom 2 <5 C4 ~ F4 + 2	Mid Tom Tom 2 1> F#4 ~ B4 + +	Low Tom Tom 2 5> C5 ~ F5 + +	Crash Cym <5 F#5 ~ B5 4 +	Ride Cym 5> C6 ~ G9 + +	=====	Drum Set 2
7	Lo Timbale 7> C-1 ~ B2 1 4	Hi Timbale 3> C3 ~ F3 + +	Cowbell 5> F#3 ~ B3 + +	Hi Agogo 1> C4 ~ F4 + 2	Lo Agogo <1 F#4 ~ B4 + +	Hi Conga (Mute) <3 C5 ~ F5 + +	Hi Conga <5 F#5 ~ B5 + 4	Lo Conga <7 C6 ~ G9 + +	=====	Percussion Set 1
8	Cowbell 7> C-1 ~ B2 1 4	Tambourine 3> C3 ~ F3 + +	Cabasa 3> F#3 ~ B3 2 +	Maracas 1> C4 ~ F4 + +	Oui jada <1 F#4 ~ B4 6 +	Claves <3 C5 ~ F5 2 +	Cup (Mute) <5 F#5 ~ B5 4 +	Splash Cym <7 C6 ~ G9 + 2	=====	Percussion Set 2



# BANK 7 Unison Play ユニゾン演奏 (MIDI Ch.1)

Tone Name  
Pan  
Key Range  
MIDI Ch.  
Partial Reserve

Part No.	1	2	3	4	5	6	7	8	R	Remarks
1	Acou Piano 1 >> C-1 ~ G 9 1 16	Warm Bell ↑ ↑ ↑ ↑	Acou Piano 1 ↑ ↑ 2 0	Harp 1 ↑ ↑ ↑ ↑	Acou Piano 1 ↑ ↑ 3 ↑	Vibe ↑ ↑ ↑ ↑	Acou Piano 1 ↑ ↑ 4 ↑	Steel Drum ↑ ↑ ↑ ↑	↑ ↑ ↑ 10 ↑	Dual Part 1
2	Elec Piano 3 >> C-1 ~ G 9 1 16	Acou Piano 1 ↑ ↑ ↑ ↑	Elec Piano 3 ↑ ↑ 2 0	Fr Horn ↑ ↑ ↑ ↑	Elec Piano 3 ↑ ↑ 3 ↑	Fantasy ↑ ↑ ↑ ↑	Elec Piano 3 ↑ ↑ 4 ↑	Syn Lead 1 ↑ ↑ ↑ ↑	↑ ↑ ↑ 10 ↑	Dual Part 2
3	Harp 1 >> C-1 ~ G 9 1 16	Brass 1 ↑ ↑ ↑ ↑	Harp 1 ↑ ↑ 2 0	Clarinet 2 ↑ ↑ ↑ ↑	Harp 1 ↑ ↑ 3 ↑	Syn Lead 2 ↑ ↑ ↑ ↑	Harp 1 ↑ ↑ 4 ↑	Koto ↑ ↑ ↑ ↑	↑ ↑ ↑ 10 ↑	Dual Part 3
4	Harp 2 >> C-1 ~ G 9 1 16	Vibe ↑ ↑ ↑ ↑	Harp 2 ↑ ↑ 2 0	Warm Bell ↑ ↑ ↑ ↑	Harp 2 ↑ ↑ 3 ↑	Guitar 1 ↑ ↑ ↑ ↑	Harp 2 ↑ ↑ 4 ↑	Steel Drum ↑ ↑ ↑ ↑	↑ ↑ ↑ 10 ↑	Dual Part 4
5	Cello 1 >> C-1 ~ G 9 1 16	Elec Piano 3 ↑ ↑ ↑ ↑	Cello 1 ↑ ↑ 2 0	Sax 2 ↑ ↑ ↑ ↑	Cello 1 ↑ ↑ 3 ↑	Oboe ↑ ↑ ↑ ↑	Cello 1 ↑ ↑ 4 ↑	Fantasy ↑ ↑ ↑ ↑	↑ ↑ ↑ 10 ↑	Dual Part 5
6	Strings 1 > C-1 ~ G 9 1 16	Steam Pad ↑ ↑ ↑ ↑	Strings 1 ↑ ↑ 2 0	Elec Organ 4 ↑ ↑ ↑ ↑	Strings 1 ↑ ↑ 3 ↑	Clarinet 1 ↑ ↑ ↑ ↑	Strings 1 ↑ ↑ 4 ↑	Sho ↑ ↑ ↑ ↑	↑ ↑ ↑ 10 ↑	Dual Part 6
7	Flute 1 >> C-1 ~ G 9 1 16	Elec Organ 4 ↑ ↑ ↑ ↑	Flute 1 ↑ ↑ 2 0	Trombone 1 ↑ ↑ ↑ ↑	Flute 1 ↑ ↑ 3 ↑	Vibe ↑ ↑ ↑ ↑	Flute 1 ↑ ↑ 4 ↑	Elec Gtr 2 ↑ ↑ ↑ ↑	↑ ↑ ↑ 10 ↑	Dual Part 7
8	Brass 1 >> C-1 ~ G 9 1 16	Cello 1 ↑ ↑ ↑ ↑	Brass 2 ↑ ↑ 2 0	Flute 1 ↑ ↑ ↑ ↑	Brass 3 ↑ ↑ 3 ↑	Strings 2 ↑ ↑ ↑ ↑	Brass 4 ↑ ↑ 4 ↑	Flute 1 ↑ ↑ ↑ ↑	↑ ↑ ↑ 10 ↑	Dual Part 8

# BANK 8 For the Guitar Controller in mono mode モノ・モード対応のギター・コントローラー用 (MIDI Ch.1~6)

Tone Name  
Pan  
Key Range  
MIDI Ch.  
Partial Reserve

Part No.	1	2	3	4	5	6	7	8	R	Remarks
1	Acou Piano 1 >> C-1 ~ G 9 1 8	↑ ↑ 2 ↑	↑ ↑ 3 4	↑ ↑ 4 ↑	↑ ↑ 5 ↑	↑ ↑ 6 ↑	↑ ↑ 7 0	↑ ↑ 8 ↑	↑ ↑ ↑ 10 ↑	Guitar Controller 1
2	Pipe Organ 1 >> C-1 ~ G 9 1 8	↑ ↑ 2 ↑	↑ ↑ 3 4	↑ ↑ 4 ↑	↑ ↑ 5 ↑	↑ ↑ 6 ↑	↑ ↑ 7 0	↑ ↑ 8 ↑	↑ ↑ ↑ 10 ↑	Guitar Controller 2
3	Flute 1 >> C-1 ~ G 9 1 8	↑ ↑ 2 ↑	↑ ↑ 3 4	↑ ↑ 4 ↑	↑ ↑ 5 ↑	↑ ↑ 6 ↑	↑ ↑ 7 0	↑ ↑ 8 ↑	↑ ↑ ↑ 10 ↑	Guitar Controller 3
4	Strings 1 > C-1 ~ G 9 1 8	↑ ↑ 2 ↑	↑ ↑ 3 4	↑ ↑ 4 ↑	↑ ↑ 5 ↑	↑ ↑ 6 ↑	↑ ↑ 7 0	↑ ↑ 8 ↑	↑ ↑ ↑ 10 ↑	Guitar Controller 4
5	Brass 1 >> C-1 ~ G 9 1 8	↑ ↑ 2 ↑	↑ ↑ 3 4	↑ ↑ 4 ↑	↑ ↑ 5 ↑	↑ ↑ 6 ↑	↑ ↑ 7 0	↑ ↑ 8 ↑	↑ ↑ ↑ 10 ↑	Guitar Controller 5
6	Fantasy >> C-1 ~ G 9 1 8	↑ ↑ 2 ↑	↑ ↑ 3 4	↑ ↑ 4 ↑	↑ ↑ 5 ↑	↑ ↑ 6 ↑	↑ ↑ 7 0	↑ ↑ 8 ↑	↑ ↑ ↑ 10 ↑	Guitar Controller 6
7	Acou Piano 1 >> C-1 ~ G 9 1 8	↑ ↑ 2 ↑	↑ ↑ 3 4	↑ ↑ 4 ↑	Acou Bass 1 ↑ ↑ 5 ↑	↑ ↑ 6 ↑	↑ ↑ 7 0	↑ ↑ 8 ↑	↑ ↑ ↑ 10 ↑	Guitar Controller 7
8	Syn Lead 1 >> C-1 ~ G 9 1 8	↑ ↑ 2 ↑	↑ ↑ 3 4	↑ ↑ 4 ↑	Slop Bass 1 ↑ ↑ 5 ↑	↑ ↑ 6 ↑	↑ ↑ 7 0	↑ ↑ 8 ↑	↑ ↑ ↑ 10 ↑	Guitar Controller 8

## ■Internal Tone(Factory Preset)

### インターナル・トーン(工場出荷時)

i Group

No.	Tone Name	Number of Partial	No.	Tone Name	Number of Partial
01	Touch Piano	4	33	Light Bass	2
02	Syn Piano	4	34	Slide Bass	3
03	Fullout Org	4	35	Timbass	3
04	Moss Organ	4	36	Funk Bass	2
05	Deep Strngs	4	37	Bassynth	2
06	Xmod Strngs	4	38	Slappin'	4
07	Velo - Brass	2	39	Fall Leaves	4
08	Soft Brass	4	40	EG Mute	4
09	Native Loop	4	41	Drop Hit	4
10	Nightmare	4	42	Mild Bell	2
11	Rich Wood	4	43	Syn Mallet	1
12	Pick Guitar	3	44	Good Night	4
13	Inner Wood	4	45	Bell Tree	2
14	Poly Synth	3	46	Syn Chime	3
15	Blow Pipes	3	47	Revers Bell	1
16	Clavitroid	4	48	"Big Ben"	2
17	Warm Pad	4	49	Timbales	3
18	Power Synth	4	50	Conga Set	3
19	Hollow Pad	4	51	Metal Drum	2
20	Old Days	2	52	Native Perc	2
21	Reso Sweep	2	53	Snare Drum	4
22	Brass Pad	2	54	Rich Ride	4
23	Sawteeth	2	55	Splash Cym	2
24	Metallics	2	56	<Drum. Set >	4
25	Square Solo	2	57	Space War	3
26	Horn Lead	3	58	'Commando'	3
27	Overdrive	4	59	Very Busy I	3
28	Voxy Men	4	60	Thndr Storm	4
29	Harpsi - Vox	2	61	ironworks	4
30	Voxy Women	4	62	Bubble Gum	2
31	Breth Choir	4	63	Lonely Wolf	1
32	Whistler	2	64	Seashore.	4



# D-110 MULTI TIMBRAL SOUND MODULE

## ■Tone Parameters

[Common Parameter]

Parameter Group	Parameter	Display
Common	Tone Name	Name
	Structure 1&2	Structure 1&2
	Structure 3&4	Structure 3&4
	Partial Mute	Partial Mute
	ENV Mode	ENV Mode

[Partial Parameter]

Parameter Group	Parameter	Display	PCM
WG	Pitch Coarse	WG Pitch Cors	○
	Pitch Fine	WG Pitch Fine	○
	Keyfollow(Pitch)	WG Pitch KF	○
	Bender Switch	WG Bender SW	○
	Waveform	WG Waveform	×
	PCM Wave Bank	PCM Bank	○
	PCM Wave No.	PCM	○
	Pulse Width	WG Puls Width	×
	Velocity Sensivity(Pulse Width)	WG PW Velo	×
Pitch ENV	Pitch ENV Depth	P-ENV Depth	○
	Velocity Sensivity(Depth)	P-ENV Velo	○
	Key Follow(Time)	P-ENV Time KF	○
	Time 1/2/3/4	P-ENV T1 (.4)	○
	Level 0/1/2	P-ENV L0 (...2)	○
	Sustain Level	P-ENV Sus L	○
	End Level	P-ENV End L	○
LFO	Rate	P-LFO Rate	○
	Depth	P-LFO Depth	○
	Modulation Sensivity	P-LFO Mod	○
TVF	Frequency	TVF Freq	×
	Resonance	TVF Reso	×
	Keyfollow(Frequency)	TVF Freq KF	×
	Bias Point	TVF Bias P	×
	Bias Level	TVF Bias Lvl	×
TVF ENV	ENV Depth	TVF-ENV Dept	×
	Velocity Sensivity(Depth)	TVF-ENV Velo	×
	Keyfollow(Depth)	TVF-ENV DKF	×
	Keyfollow(Time)	TVF-ENV TKF	×
	Time 1/2/3/4/5	TVF-ENV T1 (.5)	×
	Level 1/2/3	TVF-ENV L1 (.3)	×
	Sustain Level	TVF-ENV Sus L	×
TVA	Level	TVA Level	○
	Velocity Sensivity	TVA Velocity	○
	Bias Point 1/2	TVA Bias P1 (2)	○
	Bias Level 1/2	TVA-Bias L1 (2)	○
TVA ENV	Keyfollow(Time)	TVA-ENV TKF	○
	Velocity Follow(Time 1)	TVA-ENV T1VF	○
	Time 1/2/3/4/5	TVA-ENV T1 (.5)	○
	Level 1/2/3	TVA-ENV L1 (.3)	○
	Sustain Level	TVA-ENV Sus L	○

2701039800 '90-10-A3-91

 Roland

# 0-110 MULTI TIMBRAL SOUND MODULE

## ■ Play Mode

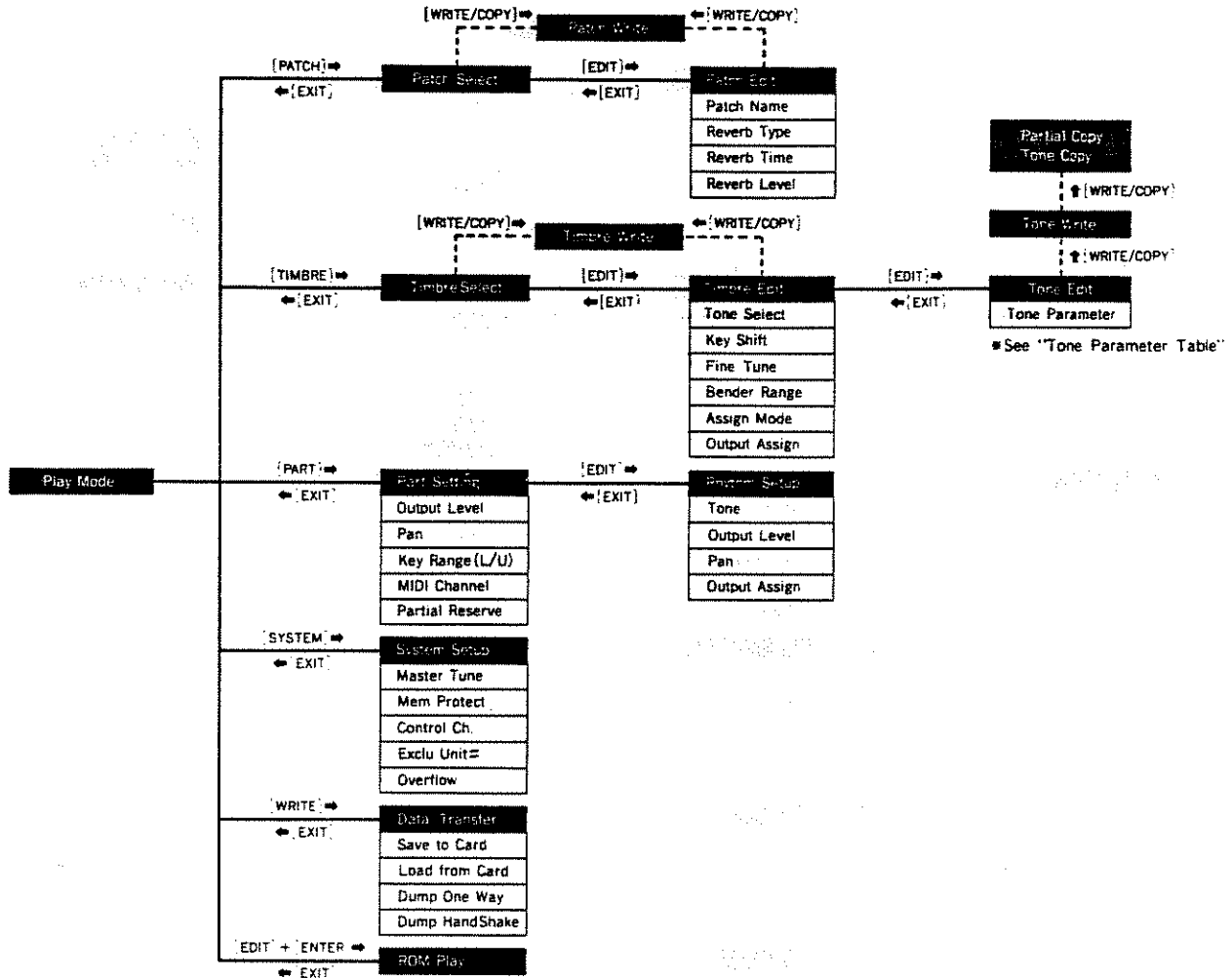

## ■ Structure

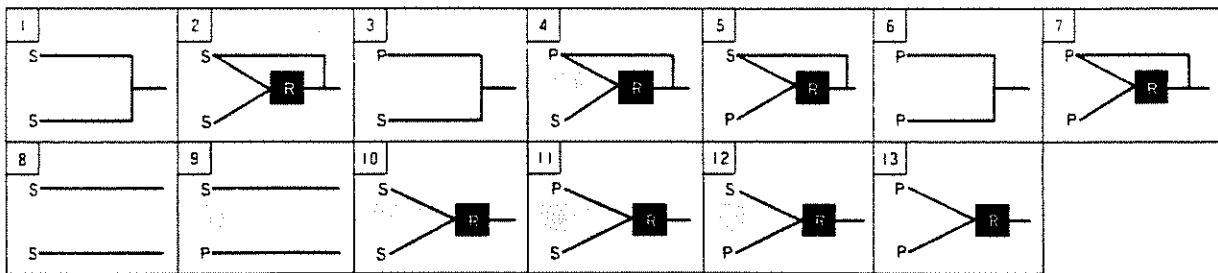

## ■ Reverb Type

1	Small Room	5	Plate
2	Medium Room	6	Delay 1
3	Medium Hall	7	Delay 2
4	Large Hall	8	Delay 3

# D-110 MULTI TIMBRAL SOUND MODULE

## ■ Play Mode

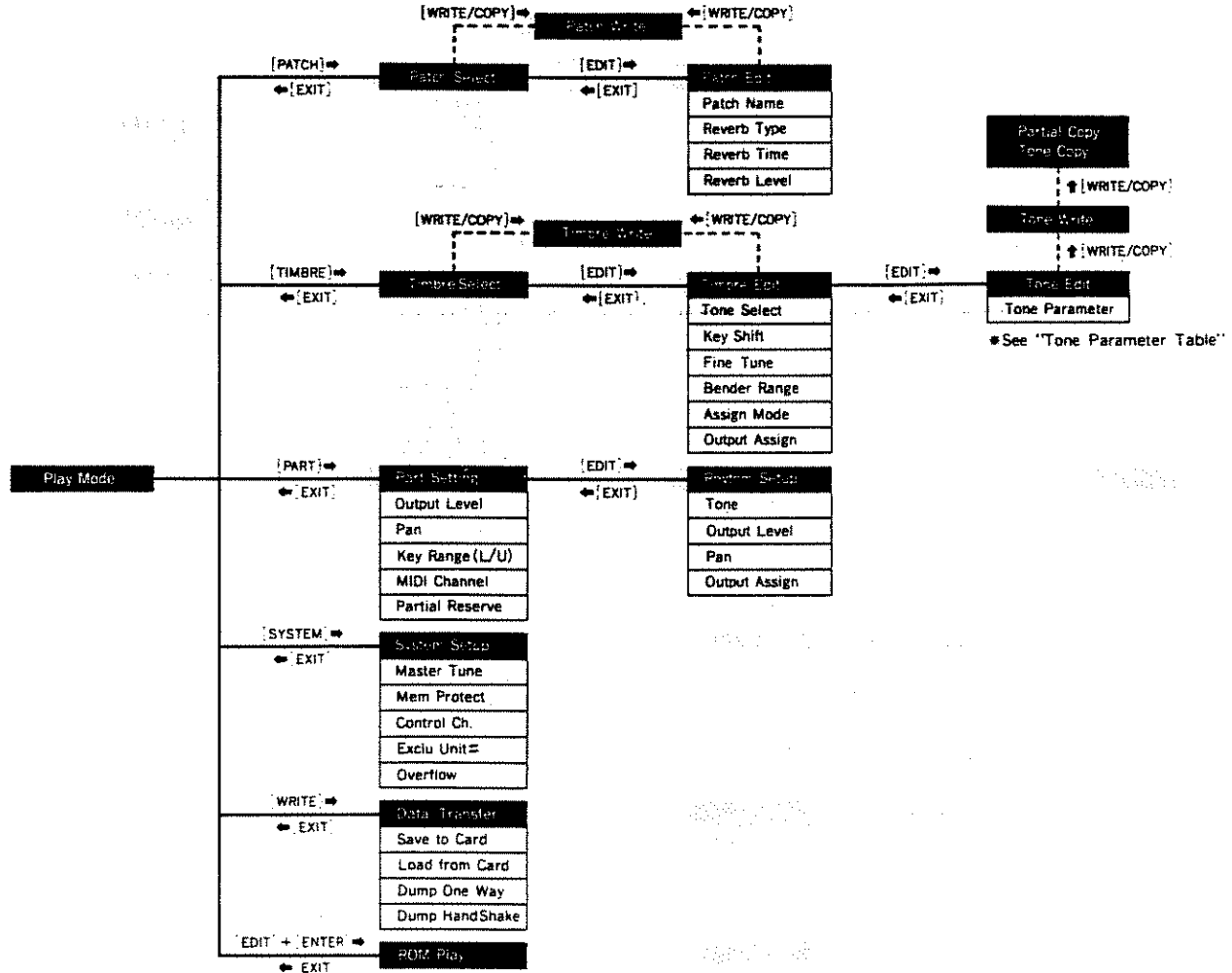

## ■ Structure

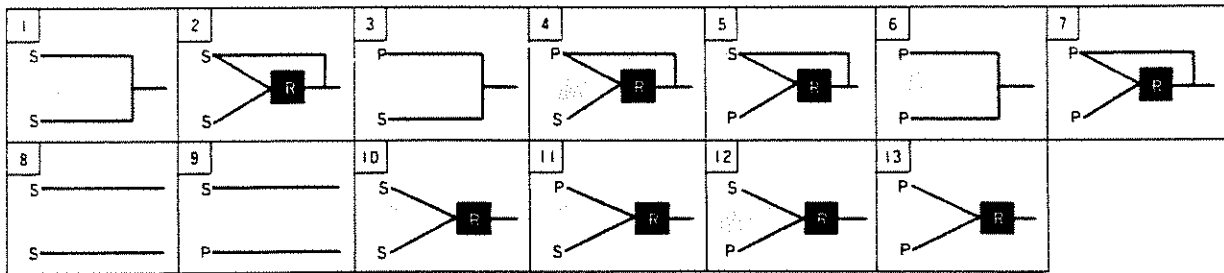

## ■ Reverb Type

1	Small Room	5	Plate
2	Medium Room	6	Delay 1
3	Medium Hall	7	Delay 2
4	Large Hall	8	Delay 3

2701040000'90-11-A3-131



 Roland®

10652

UPC

10652



10652

 Roland