

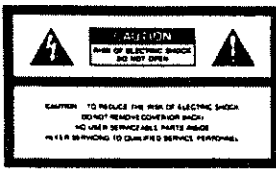

MIDI MULTI TIMBRAL LINEAR SYNTHESIZER

D-10

Owner's Manual *Vol.1* BASIC
Owner's Manual *Vol.2* ADVANCED
Timbre Sound Chart
Patch Sound Chart
Quick Operation Table (1)
Quick Operation Table (2)
ROM Play (*OPERATION*)
ROM Play (*CONNECTION*)



The lightning flash with arrowhead symbol, within an equilateral triangle, is intended to alert the user to the presence of un-insulated "dangerous voltage" within the product's enclosure that may be of sufficient magnitude to constitute a risk of electric shock to persons.



The exclamation point within an equilateral triangle is intended to alert the user to the presence of important operating and maintenance (servicing) instructions in the literature accompanying the product.

INSTRUCTIONS PERTAINING TO A RISK OF FIRE, ELECTRIC SHOCK OR INJURY TO PERSONS.

IMPORTANT SAFETY INSTRUCTIONS

WARNING When using electric products, basic precautions should always be followed, including the following:

1. Read all the instructions before using the product.
2. Do not use this product near water- for example, near a bathtub, washbowl, kitchen sink, in a wet basement, or near a swimming pool, or the like.
3. This product should be used only with a cart or stand that is recommended by the manufacturer.
4. This product, either alone or in combination with an amplifier and headphones or speakers, may be capable of producing sound levels that could cause permanent hearing loss. Do not operate for a long period of time at a high volume level or at level that is uncomfortable. If you experience any hearing loss or ringing in the ears, you should consult an audiologist.
5. The product should be located so that its location or position does not interfere with its proper ventilation.
6. The product should be located away from heat sources such as radiators, heat registers or other products that produce heat.
7. The product should avoid using in where it may be effected by dust.
8. The product should be connected to a power supply only of the type described in the operating instructions or as marked on the product.
9. The power-supply cord of the product should be unplugged from the outlet when left unused for a long period of time.
10. Do not tread on the power-supply cord.
11. Do not pull the cord but hold the plug when unplugging.
12. When setting up with any other instruments, the procedure should be followed in accordance with instruction manual.
13. Care should be taken so that objects do not fall and liquids are not spilled into the enclosure through openings.
14. The product should be serviced by qualified service personnel when:
 - A: The power-supply cord or the plug has been damaged; or
 - B: Objects have fallen, or liquid has been spilled into the product; or
 - C: The product has been exposed to rain; or
 - D: The product does not appear to operate normally or exhibits a marked change in performance; or
 - E: The product has been dropped, or the enclosure damaged.
15. Do not attempt to service the product beyond that described in the user-maintenance instructions. All other servicing should be referred to qualified service personnel.

SAVE THESE INSTRUCTIONS

ADVARSEL!

Lithiumbatteri. Eksplosionsfare.
Udskiftning må kun foretages af en sagkyndig,
og som beskrevet i servicemanual.

VARNING!

Lithiumbatteri. Explosionsrisk.
Får endast bytas av behörig servicetekniker.
Se instruktioner i servicemanualen.

ADVARSEL!

Lithiumbatteri. Fare for eksplosion.
Må bare skiftes av kvalifisert tekniker som
beskrevet i servicemanualen.

VAROITUS!

Lithiumparisto. Räjähdyksvaara.
Pariston saa vaihtaa ainoastaan
alan ammottimies.

WARNING

THIS APPARATUS MUST BE EARTH GROUNDED.

The three conductors of the mains lead attached to this apparatus are identified with color as shown in the table below, together with the matching terminal on the UK type power plug. When connecting the mains lead to a plug, be sure to connect each conductor to the correct terminal, as indicated. "This instruction applies to the product for United Kingdom."

MAINS LEADS		PLUG
Conductor	Color	Mark on the matching terminal
Live	Brown	Red or letter L
Neutral	Blue	Black or letter N
Grounding	Green-Yellow	Green, Green-Yellow, letter E or symbol

Bescheinigung des Herstellers / Importeurs

Hiermit wird bescheinigt, daß der/die/das

ROLAND MULTI TIMBRAL LINEAR SYNTHESIZER D-10

(Gerät, Typ, Bescheinigung)

in Übereinstimmung mit den Bestimmungen der

Amtsbl. Vfg 1046 / 1984

(Anmeldebestätigung)

funk-entstört ist.

Der Deutschen Bundespost wurde das Inverkehrbringen dieses Gerätes angezeigt und die Berechtigung zur Überprüfung der Serie auf Einhaltung der Bestimmungen eingeräumt.

Roland Corporation Osaka / Japan

Name des Herstellers/Importeurs

RADIO AND TELEVISION INTERFERENCE

*Warning - This equipment has been verified to comply with the limits for a Class B computing device, pursuant to Subpart J, of Part 15, of FCC rules. Operation with non-certified or non-verified equipment is likely to result in interference to radio and TV reception.

The equipment described in this manual generates and uses radio-frequency energy. If it is not installed and used properly, that is, in strict accordance with our instructions, it may cause interference with radio and television reception.

This equipment has been tested and found to comply with the limits for a Class B computing device in accordance with the specifications in Subpart J, of Part 15, of FCC Rules. These rules are designed to provide reasonable protection against such a interference in a residential installation. However, there is no guarantee that the interference will not occur in a particular installation. If this equipment does cause interference to radio or television reception, which can be determined by turning the equipment on and off, the user is encouraged to try to correct the interference by the following measures:

- Disconnect other devices and their interconnect cables one at a time. If the interference stops, it is caused by either the other device or its I/O cable.
- These devices usually require Roland designed shielded I/O cables. For Roland devices, you can obtain the proper shielded cable from your dealer. For non-Roland devices, contact the manufacturer or dealer for assistance.
- If your equipment does cause interference to radio or television reception, you can try to correct the interference by using one or more of the following measures:
 - Turn the TV or radio antenna until the interference stops.
 - Move the equipment to one side or the other of the TV or radio.
 - Move the equipment farther away from the TV or radio. (That is, make certain the equipment and the radio or television set are on circuits controlled by different circuit breakers or fuses.)
 - Consider installing a rooftop television antenna with coaxial cable lead-in between the antenna and TV.
- If necessary, you should consult your dealer or an experienced radio/television technician for additional suggestions. You may find helpful the following booklet prepared by the Federal Communications Commission: "How to Identify and Resolve Radio-TV Interference Problems". This booklet is available from the U.S. Government Printing Office, Washington, D.C., 20402. Stock No. GSA-900-022-5-6.

Please read the separate volume "MIDI", before reading this owner's manual.

Copyright © 1988 by ROLAND CORPORATION

All rights reserved. No part of this publication may be reproduced in any form without the written permission of ROLAND CORPORATION.

 **Roland**

MIDI MULTI TIMBRAL LINEAR SYNTHESIZER

D-10

Owner's Manual

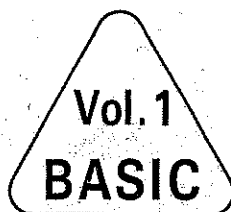

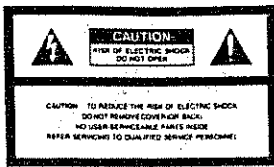

The lightning flash with arrowhead symbol, within an equilateral triangle, is intended to alert the user to the presence of un-insulated "dangerous voltage" within the product's enclosure that may be of sufficient magnitude to constitute a risk of electric shock to persons.

The exclamation point within an equilateral triangle is intended to alert the user to the presence of important operating and maintenance (servicing) instructions in the literature accompanying the product.

INSTRUCTIONS PERTAINING TO A RISK OF FIRE, ELECTRIC SHOCK OR INJURY TO PERSONS.

IMPORTANT SAFETY INSTRUCTIONS

WARNING When using electric products, basic precautions should always be followed, including the following:

1. Read all the instructions before using the product.
2. Do not use this product near water- for example, near a bathtub, washbowl, kitchen sink, in a wet basement, or near a swimming pool, or the like.
3. This product should be used only with a cart or stand that is recommended by the manufacturer.
4. This product, either alone or in combination with an amplifier and headphones or speakers, may be capable of producing sound levels that could cause permanent hearing loss. Do not operate for a long period of time at a high volume level or at level that is uncomfortable. If you experience any hearing loss or ringing in the ears, you should consult an audiologist.
5. The product should be located so that its location or position does not interfere with its proper ventilation.
6. The product should be located away from heat sources such as radiators, heat registers or other products that produce heat.
7. The product should avoid using in where it may be affected by dust.
8. The product should be connected to a power supply only of the type described in the operating instructions or as marked on the product.
9. The power-supply cord of the product should be unplugged from the outlet when left unused for a long period of time.
10. Do not tread on the power-supply cord.
11. Do not pull the cord but hold the plug when unplugging.
12. When setting up with any other instruments, the procedure should be followed in accordance with instruction manual.
13. Care should be taken so that objects do not fall and liquids are not spilled into the enclosure through openings.
14. The product should be serviced by qualified service personnel when:
 - A: The power-supply cord or the plug has been damaged; or
 - B: Objects have fallen, or liquid has been spilled into the product; or
 - C: The product has been exposed to rain; or
 - D: The product does not appear to operate normally or exhibits a marked change in performance; or
 - E: The product has been dropped, or the enclosure damaged.
15. Do not attempt to service the product beyond that described in the user-maintenance instructions. All other servicing should be referred to qualified service personnel.

SAVE THESE INSTRUCTIONS

ADVARSEL!

Lithiumbatteri. Eksplosionsfare.
Udskiftning må kun foretages af en sagkyndig,
og som beskrevet i servicemanual.

VARNING!

Lithiumbatteri. Explosionsrisk.
Får endast bytas av behörig servicetekniker.
Se instruktioner i servicemanualen.

ADVARSEL!

Lithiumbatteri. Fare for eksplotion.
Må bare skiftes av kvalifisert tekniker som
beskrevet i servicemanualen.

VAROITUS!

Lithiumparisto. Räjähdyksvaara.
Pariston saa vaihtaa ainoastaan
alan ammottimies.

WARNING

THIS APPARATUS MUST BE EARTH GROUNDED.

The three conductors of the mains lead attached to this apparatus are identified with color as shown in the table below, together with the matching terminal on the UK type power plug. When connecting the mains lead to a plug, be sure to connect each conductor to the correct terminal, as indicated.

"This instruction applies to the product for United Kingdom."

MAINS LEADS		PLUG
Conductor	Color	Mark on the matching terminal
Live	Brown	Red or letter L
Neutral	Blue	Black or letter N
Grounding	Green-Yellow	Green, Green-Yellow, letter E or symbol

Bescheinigung des Herstellers / Importeurs

Hiermit wird bescheinigt, daß der/die/das

ROLAND MULTI TIMBRAL LINEAR SYNTHESIZER D-10

(Gerät, Typ, Bezeichnung)

in Übereinstimmung mit den Bestimmungen der

Amtsbl. Vfg 1046 / 1984

(Anmeldebestätigung)

funk-entstört ist:

Der Deutschen Bundespost wurde das Inverkehrbringen dieses Gerätes angezeigt und die Berechtigung zur Überprüfung der Serie auf Einhaltung der Bestimmungen eingeräumt.

Roland Corporation Osaka / Japan

Name des Herstellers/Importeurs

RADIO AND TELEVISION INTERFERENCE

"Warning - This equipment has been verified to comply with the limits for a Class B computing device, pursuant to Subpart J of Part 15 of FCC rules. Operation with non-certified or non-verified equipment is likely to result in interference to radio and TV reception."

The equipment described in this manual generates and uses radio-frequency energy. If it is not installed and used properly, that is, in strict accordance with our instructions, it may cause interference with radio and television reception.

This equipment has been tested and found to comply with the limits for a Class B computing device in accordance with the specifications in Subpart J of Part 15 of FCC Rules. These limits are designed to provide reasonable protection against such interference in a residential installation.

However, there is no guarantee that interference will not occur in a particular installation. If this equipment does cause interference to radio or television reception, which can be determined by turning the equipment on and off, the user is encouraged to try to correct the interference by the following measures:

- Disconnect other devices and their input/output cables one at a time. If the interference stops, it is caused by either the other device or its I/O cables.
- These devices usually require Roland designated shielded I/O cables. For Roland devices, you can obtain the proper shielded cable from your dealer. For non-Roland devices, contact the manufacturer for the proper shielded cable from your dealer.

If your equipment does cause interference to radio or television reception, you can try to correct the interference by using one or more of the following measures:

- Turn the TV or radio antenna until the interference stops.
- Move the equipment to one side or the other of the TV or radio.
- Move the equipment further away from the TV or radio.
- Plug the equipment into an outlet that is on a different circuit than the TV or radio. (That is, make certain the equipment and the radio or television set are on circuits controlled by different circuit breakers or fuses.)
- Consider installing a rooftop television antenna with coaxial cable lead-in between the antenna and TV.

If necessary, you should consult your dealer or an experienced radio/television technician for additional suggestions. You may find helpful the following booklet prepared by the Federal Communications Commission:

"How to Identify and Resolve Radio-TV Interference Problems"

This booklet is available from the U.S. Government Printing Office, Washington, D.C. 20462. Stock No. 004-000-00346-4.

Please read the separate volume "MIDI", before reading this owner's manual.

Copyright © 1988 by ROLAND CORPORATION

All rights reserved. No part of this publication may be reproduced in any form without the written permission of ROLAND CORPORATION.

CONTENTS

Please read the owner's manual thoroughly to make the best use of the Roland D-10.

Basic Course (Volume 1)

① Panel Description	3
② Outline of the D-10	7
1. Features	7
2. Modes	9
3. Partials and the maximum number of voices	12
③ Connections	13
④ Performance Mode	14
1. Power-up	14
2. Patch Selection	15
3. Performance Controlling Functions ..	20
a. Bender Lever	20
b. Velocity	20
c. Hold	20
4. Rhythm Play	21
a. Track Play	21
b. Rhythm Mode	23
5. Metronome	29
6. Master Tuning	32
7. Key Transpose	33
⑤ ROM Play Mode	34
⑥ Specifications	36

For Canada

CLASS B

NOTICE

This digital apparatus does not exceed the Class B limits for radio noise emissions set out in the Radio Interference Regulations of the Canadian Department of Communications.

CLASSE B

AVIS

Cet appareil numérique ne dépasse pas les limites de la classe B au niveau des émissions de bruits radioélectriques fixés dans le Règlement des signaux parasites par le ministère canadien des Communications.

IMPORTANT NOTES

POWER

The appropriate power supply for this unit is shown on its name plate. Please make sure that the line voltage in your country meets the requirement.

Do not use the same socket used for any noise generating device (such as a motor or variable lighting system) or large power consuming device.

When connecting the power cable to the socket, be sure that the unit is turned off.

When disconnecting the power plug from the socket, do not pull the cord but hold the plug to avoid damaging the cord.

Handle the power cord gently.

If the unit is not to be used for a long period of time, unplug the power cord from the socket.

It is normal for this unit to become hot during operation.

Before setting up this unit with other devices, turn this unit and all the other units off.

This unit might not work properly if turned on immediately after being turned off. If this happens, simply turn it off and turn it on again after waiting a few seconds.

CLEANING

Use a mild detergent for cleaning. Do not use solvents such as thinner.

LOCATION

Do not place this unit in the following conditions :

In extreme heat (where it may be affected by direct sunlight, near a heater, etc) In extreme humidity where it may be affected by dust or vibration

Operating this device near a neon, fluorescent lamp, TV or CRT display may cause noise interference. If so, change the angle or the position of the device.

If you operate this unit near a TV or radio which is turned on, noise or picture trouble may occur. If this happens, move the unit away from it.

Do not place anything heavy on this unit or the power cord.

MEMORY BACK-UP

This device features a memory back-up system that retains the data even when switched off. The battery that supports the back-up circuit should be replaced every five years. Call Roland for battery replacement. (The first replacement may be required before five years, depending on how much time had passed before you purchased the device.)

To avoid accidental erasure or loss of data, please make a data memo or save the data onto a memory card. If it happens to be erased while the device is being repaired, there is no way to restore the data.

When the battery is low, the Display defaults as shown below, and the data in memory may be lost.

1 PANEL DESCRIPTION

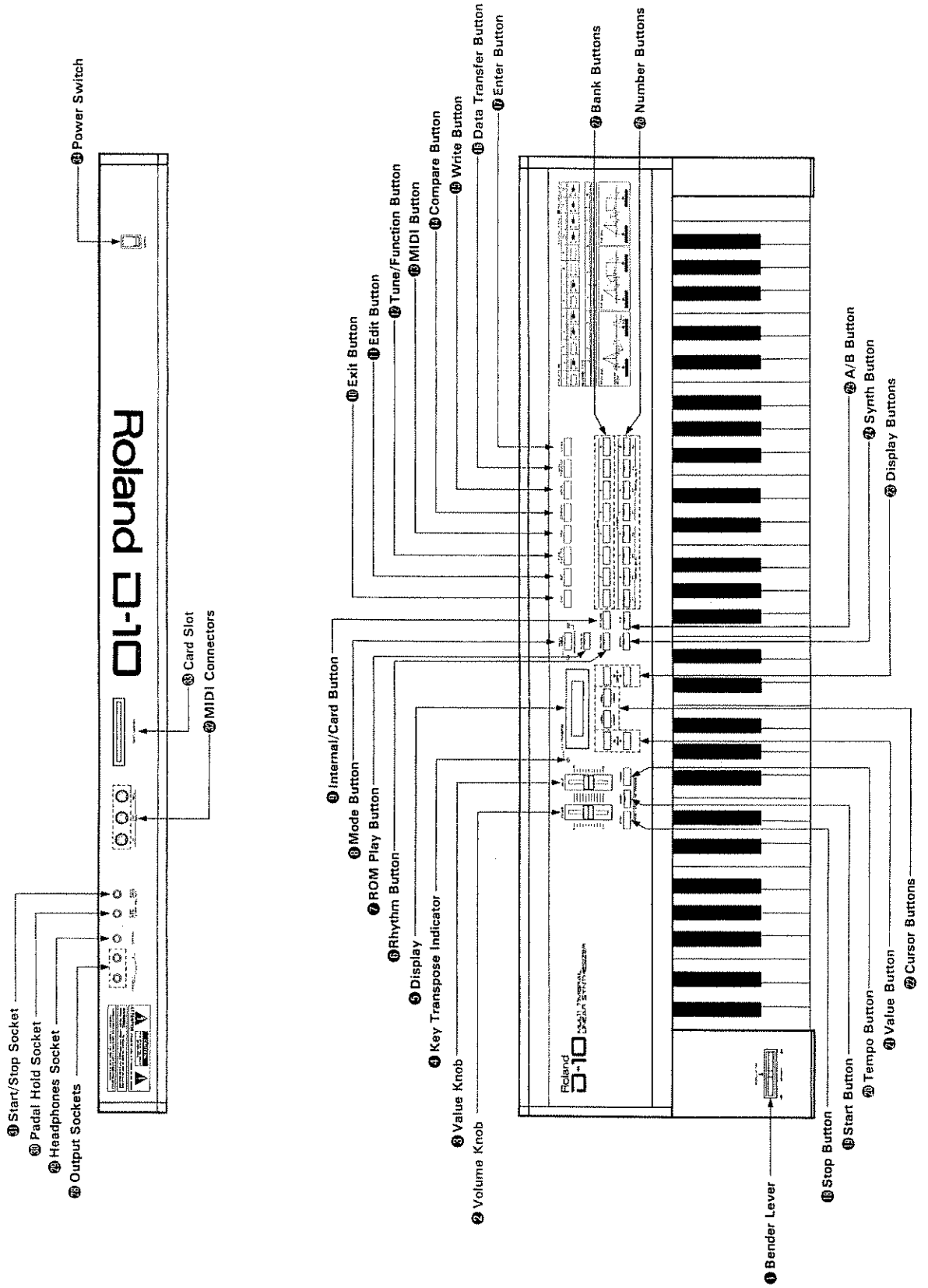

① Bender Lever

Using the Bender Lever, you can change the pitch, or create a vibrato effects.

② Volume Knob

This controls the volume of the sound sent from the Output Sockets and Headphones Socket.

③ Value Knob

Use this knob to change values. During playback, this is used for tempo control.

④ Key Transpose Indicator

This is lit while the Key Transpose function is turned on.

⑤ Display Window

This shows the current condition of the D-10.

⑥ Rhythm Button

Push this button to switch the D-10 to rhythm machine mode. When the indicator of the button is lit, the D-10 works as a rhythm machine and the rhythm patterns can be changed by using the Bank and Number Buttons.

⑦ ROM PLAY Button

Push this button for ROM PLAY performance. When the indicator of the button is lit, the D-10 is ready to play any demonstration song you select using the Number Button.

⑧ Mode Button

This button selects the Performance or Multi Timbral mode. The indicator (on either side of the button) of the corresponding mode will light up.

⑨ Internal/Card Button

This selects the internal memory or memory card where the sound to be used is stored.

⑩ Exit Button

Use this button to return to the Play mode from another mode.

⑪ Edit Button

Push this button to enter the Edit mode.

⑫ Tune/Function Button

Push this button for changing the values of parameters related to tuning, such as the Master Tuning.

⑬ MIDI Button

Push this button for editing MIDI functions.

⑭ Compare Button

Using this button, you can call the original Tone, to compare it with your edited version.

⑮ Write Button

Push this button to begin the writing process.

⑯ Data Transfer Button

Push this button to perform Data Transfer functions.

⑰ Enter Button

Push this button to execute a specific procedure.

⑱ Stop Button

Push this button to stop playing a Rhythm pattern or song.

⑲ Start Button

Push this button to start playing a Rhythm pattern or song.

⑳ Tempo Button

Push this button to see the tempo value currently set, or to change metronome values.

㉑ Value Buttons

These buttons can be used for fine value control. Pushing the ▲ button increases the value and the ▼ button decreases it. During data playback this can be used for tempo control.

㉒ Cursor Buttons

Use these buttons for moving a cursor or selecting a parameter in the Display.

22 Display Buttons

These buttons are used for changing displays. Pushing the ▲ button advances the display, and the ▼ button goes back to the previous display.

23 Synth Button

Push this button to return to the Play mode from the Rhythm or ROM Play mode. When the indicator of this button is lit, you can change Patches (Timbres) with the Bank and Number Buttons.

24 A/B Button

This selects a Group, A or B, of a Patch (Timbre).

25 Number Buttons

In the Play mode, these buttons are used for changing sounds, but they function differently in other modes.

27 Bank Buttons

In the Play mode, these buttons are used for changing sounds, but they function differently in other modes.

28 Output Sockets

These output sockets operate in stereo output during rhythm play or in the Multi Timbral mode.

29 Headphones Socket

Connect stereo headphones to this socket. (The best possible headphones to be used should have an impedance from 8 to 150 ohms.) Even when headphones are connected to this socket, the Output Sockets still send signals.

30 Pedal Hold Socket

By connecting the optional pedal switch (DP-2, DP-6), the Hold effect can be controlled with the pedal.

31 Start/Stop Socket

By connecting the optional pedal switch (DP-2, DP-6), the Rhythm can be controlled with the pedal.

32 MIDI Connectors

These are used to connect other MIDI devices.

33 Card Slot

Insert a memory card here.

34 Power Switch

This turns the unit on or off.

2 OUTLINE OF THE D-10

The Roland D-10 is a multi timbral, linear synthesizer with a built-in rhythm machine, designed for both keyboardists and multi-track recording. The following will explain the features and the modes of the D-10.

1. Features of the D-10

● LA Sound Source

The D-10's LA sound source allows warm analog type sounds as well as sharp attack digital-type sounds.

● Performance Mode and Multi Timbral Mode

The Performance mode may be selected for playing the D-10 using its own keyboard, and the Multi Timbral mode is suitable for ensemble performance using a MIDI sequencer.

● Tone

The D-10's internal memory stores 128 different preset Tones, 64 programmable Tones and 63 preset Rhythm Tones.

● Patch and Timbre

A sound consists of a Tone or a pair of Tones and performance controlling functions. In the Performance Mode, two Tones are assigned to a sound (=Patch), and in the Multi Timbral Mode, only one Tone is assigned to a sound (=Timbre).

● Reverb

The digital reverberation section of the D-10 can create reverb effects. In the Performance mode, a different reverb effect can be set for each Patch.

● Rhythm Tone

When using the D-10 as a rhythm machine, you can use Tones you have programmed as well as the 63 Preset Rhythm Tones (altogether 85 tones).

Also, it is possible to set the Pan and Level parameters for each Rhythm Tone, and therefore obtain the desired volume balance in the stereo outputs.

● **Rhythm Machine and Metronome**

The built-in rhythm machine stores 32 different preset rhythm patterns and another 32 user programmable patterns. You can make a song (or tune) in a rhythm track by using those rhythm patterns. The metronome can be used not only for practicing the keyboard but for making a rhythm pattern or rhythm track.

● **Memory Card**

Using an optional memory card (M-256D, M-256E), your original sound data and rhythm data can be saved for future use.

2. Modes

The D-10 features various modes which should be selected depending on what you wish to achieve.

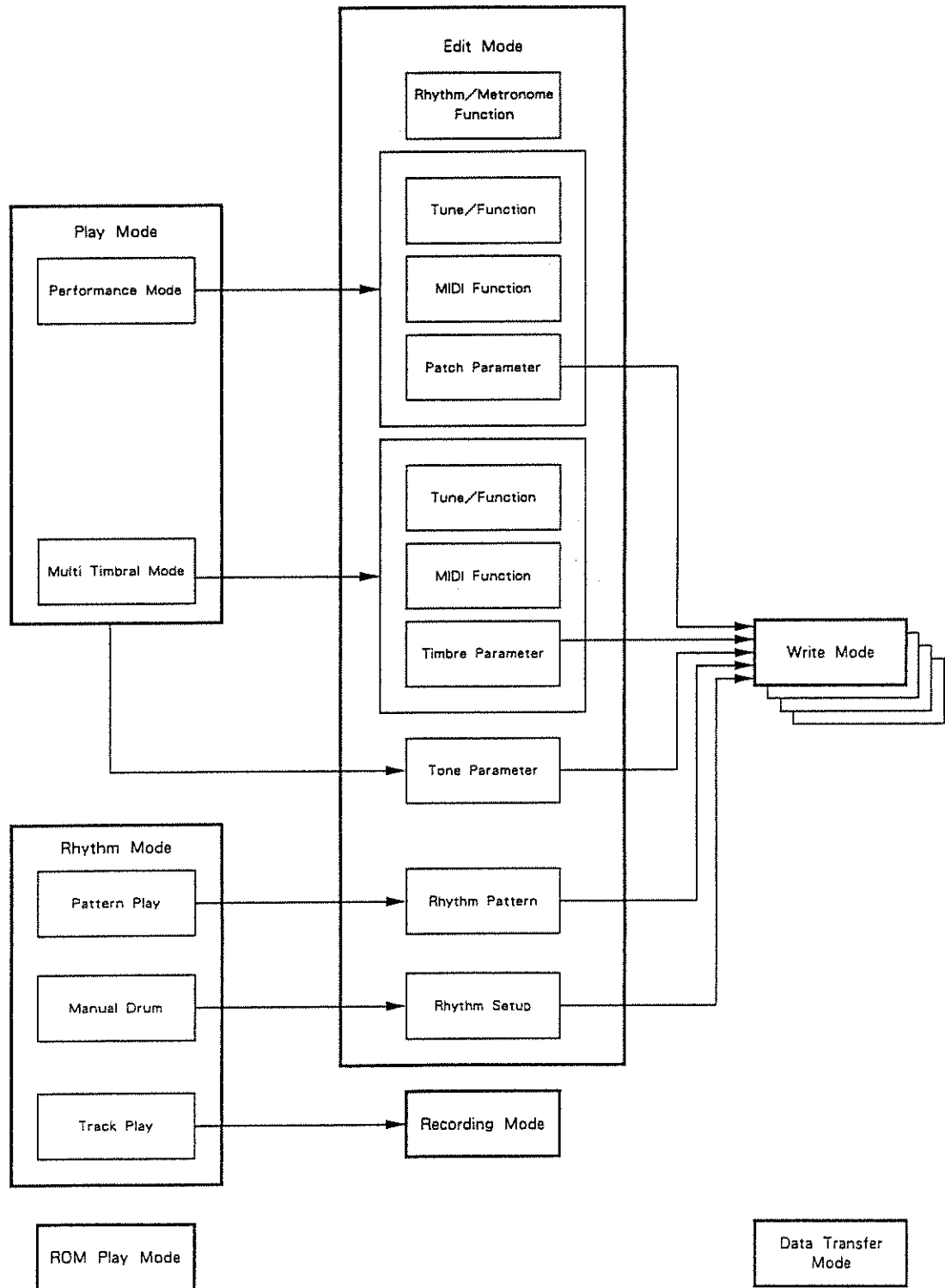

[Play Mode]

There are two different Play modes, Performance and Multi Timbral modes, and each mode allows you to select the Patch or Timbre you prefer.

● **Performance Mode**

The Performance mode may be selected for playing the D-10 using its own keyboard. You can play the keyboard to the rhythm played in the Rhythm section.

● **Multi Timbral Mode**

In the Multi Timbral mode, the D-10 works as a rhythm machine and 8 independent synthesizers. You can play an ensemble style performance using a MIDI sequencer.

[Rhythm Mode]

This mode turns the D-10 into a rhythm machine. You can select a rhythm pattern or play the keyboard using the Rhythm Tones.

[Edit Mode]

This mode allows you to edit various parameters. Normally, the edited version does not rewrite the previous data unless the appropriate writing procedure is taken.

[Recording Mode]

The Recording mode allows you to record performance data into a rhythm track.

[Write Mode]

The Write mode allows you to write an edited version into the internal memory of the D-10 or onto a memory card.

[Data Transfer Mode]

The Data Transfer mode allows you to copy the entire data written in the D-10's internal memory onto a memory card or into the internal memory of another D-10, and also copy the data on the memory card or in the D-10 into another D-10.

[ROM Play Mode]

In this mode, you can play any of the 8 songs which are preprogrammed in the D-10 to demonstrate the effects of the Multi Timbral function.

3. Partial and Maximum Voices

The D-10 can produce a maximum of 32 voices using 32 Partials at the same time. A Partial is the smallest unit of sound within the D-10. A Tone consists of one to four Partials. A Tone made of only one Partial can be played 32 voice polyphonically, but a Tone of two Partials has 16 voices, and a Tone of four Partials is 8 voice polyphonic. It is very important that you fully understand this concept. Specially in the Multi Timbral mode, this can be very tricky as several Tones are involved at the same time.

3 CONNECTIONS

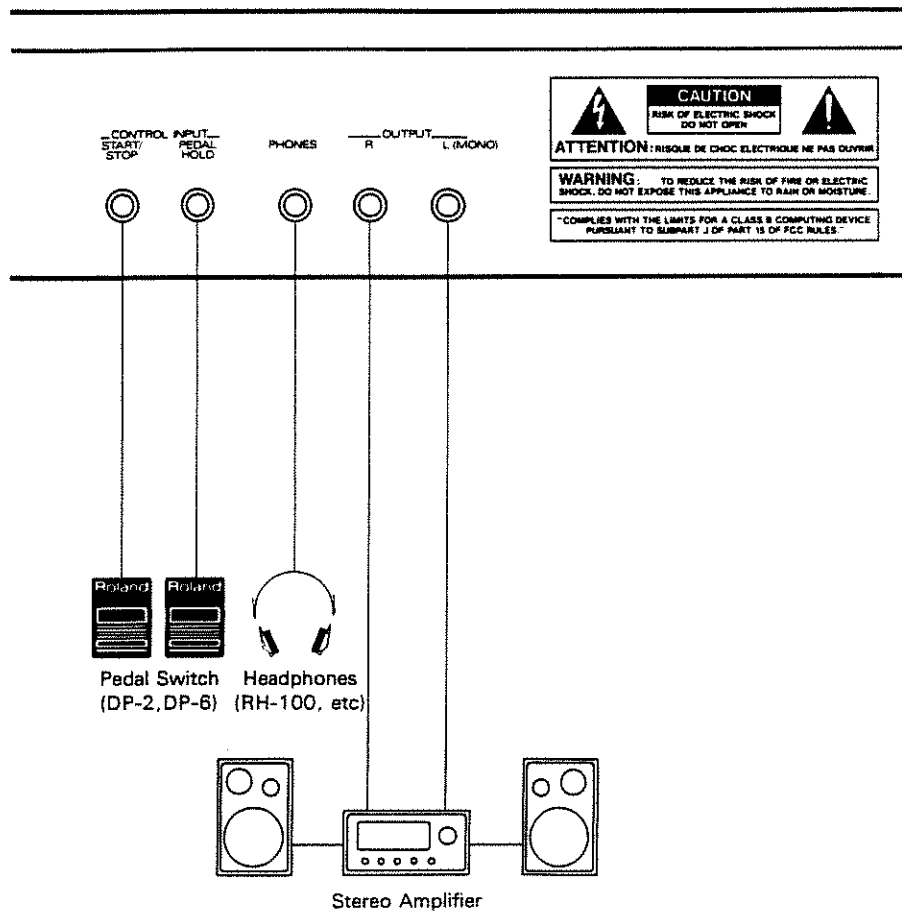

2. Patch Selection

A Patch is represented by a Group (A or B), Bank (1 to 8) and Number (1 to 8). The internal memory of the D-10 can store up to 128 Patches and a memory card can also store 128 Patches, allowing you to select from 256 Patches, just by pressing the relevant buttons.

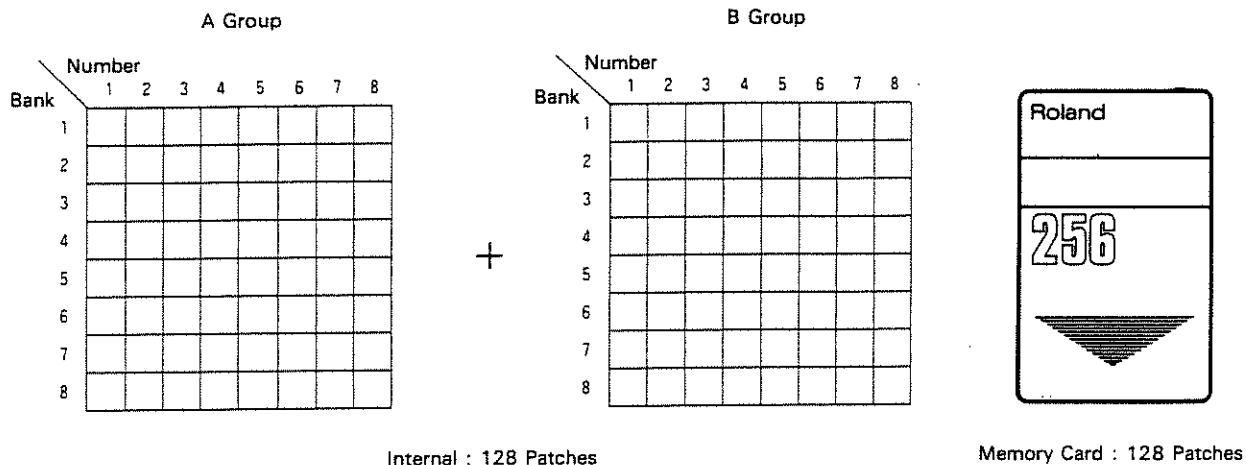

For selecting a Patch, the following buttons are involved. Patch selection is not executed unless the Number Button is pressed. If you wish to change only the Number of a Patch, simply press the relevant Number Button.

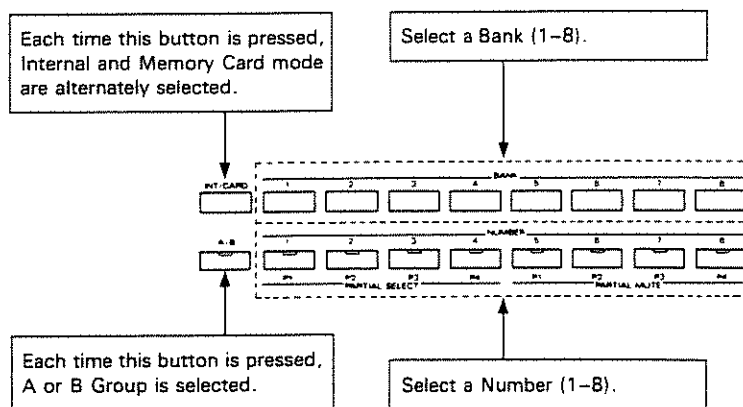

<Display>

When the Internal mode is selected, "I" is shown, and when the Memory Card is selected "C" is shown.

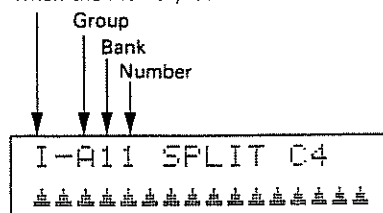

[e.g.]

Changing from Patch I-A11 to I-B31

① Push the A/B Button.

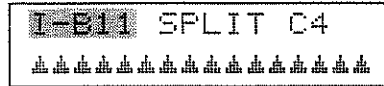

② Push the Bank Button 3.

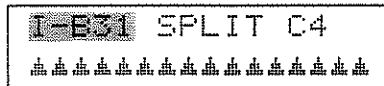

③ Push the Number Button 1.

Now, Patch I-B31 is selected.

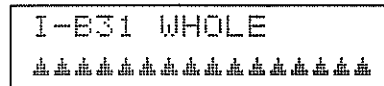

[Display]

The Display shows some of the data related to the selected Patch.

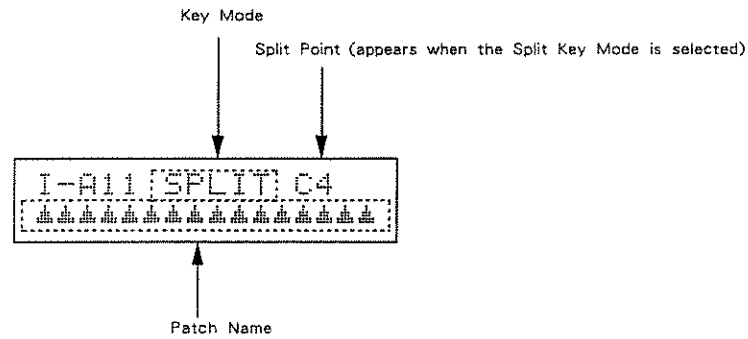

[Key Mode]

A pair of Tone are assigned to a Patch.
The Key Mode determines how to play these Tones.

- WHOLE : Only the Upper Tone is played.
- DUAL : Upper and Lower Tones are mixed.
- SPLIT : The Keyboard is divided into two sections at a Split point. Upper and Lower Tones are played in different sections.

*The maximum number of voices which can be played simultaneously changes depending on the setting of the Patch, or whether the Rhythm section is playing or not.

If you wish to check what Tones are assigned to the Patch, press either of the Display Buttons. Each time the button is pressed, the Display changes.

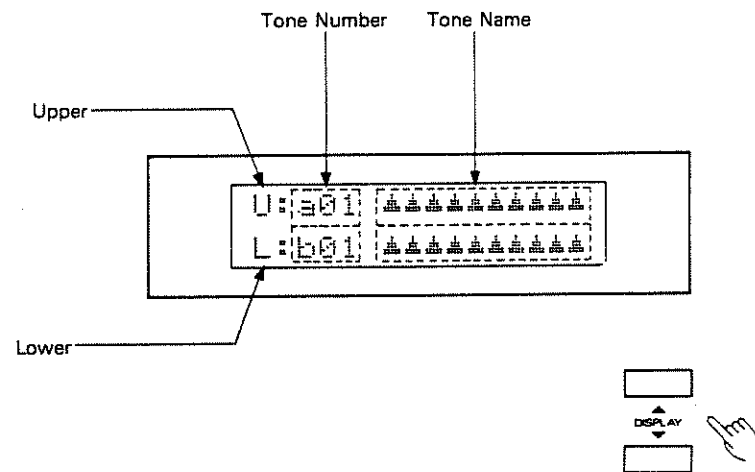

[Memory Card]

A memory card can store Rhythm data as well as the Sound data of Patches (Timbres) and Tones.

*A brand new memory card (M-256D, M-256E) does not contain any data at all, so it cannot be used unless an appropriate Saving procedure (see page 127 in the Advanced Course.) is taken for copying the entire data in the internal memory onto the memory card. This also applies to a memory card that contains data other than the D-10's.

Step 1 To use a Patch on a memory card, insert the memory card into the Card Slot in the correct direction.

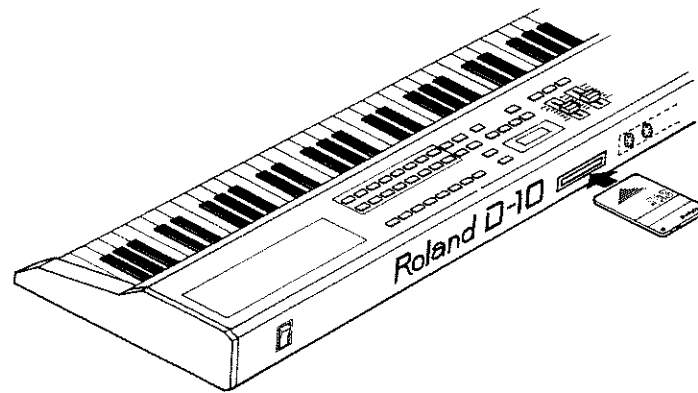

Step 2 Using the Internal/Card Button, select CARD.

*If a memory card is not connected properly or not connected at all, the Display will show as below, and the CARD cannot be selected.

Card Not Ready

*If you use a memory card that contains data other than that of the D-10, D-20 or D-110, the Display will show as below for a while, and the CARD cannot be selected. (Regarding the D-110, only the Key assignment for Timbres/Tones/Rhythm Setup is compatible with the D-10 in the Multi Timbral mode.)

Illegal Card

There are two types of memory cards :

ROM Card

Data on a ROM card cannot be edited as it is not erasable. The optional sound libraries are ROM cards.

RAM Card

Data on a RAM card can be edited. This type features a memory back-up system supported by a battery. The optional memory card (M-256D, M-256E) is a RAM card. Use this for saving the sound data you have programmed.

3. Performance Controlling Functions

During live performance, you can control the sound using the following performance controlling functions.

a. Bender Lever

Using the Bender Lever, you can change the pitch, or create vibrato effects.

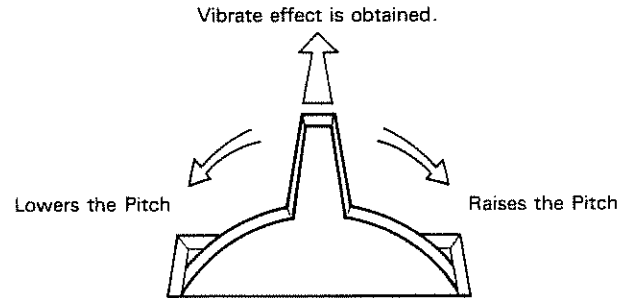

*The depth of the bender has been set differently for each Patch so that it will match the sound, therefore, the effect varies depending on the Patch you select.

b. Velocity

Velocity refers to dynamics, controlling volume, pitch and timbre. This allows piano-like performance.

*The depth of the velocity has been set differently for each Patch so that it will match the sound, therefore, the effect varies depending on the Patch you select.

c. Hold

"Hold" is the function that allows the sound to be held even after the key is released. This function can be controlled by the pedal switch connected to the Pedal Hold Socket.

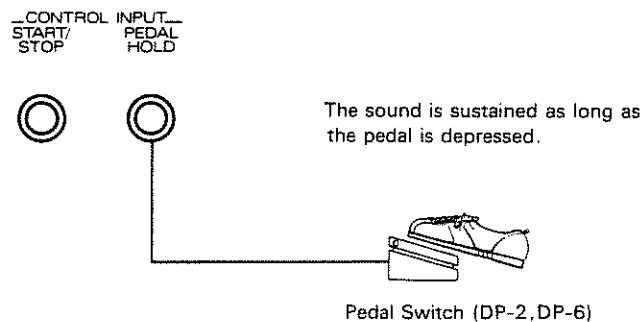

4. Rhythm Play

You can play rhythm patterns or rhythm tracks on the built-in rhythm machine and play the keyboard to the rhythm. Also, it is possible to play rhythms from the keyboard.

*The above function is also attainable in the Multi Timbral mode.

a. Track Play

At power-up, the Rhythm Machine defaults to the Rhythm Track playing mode.

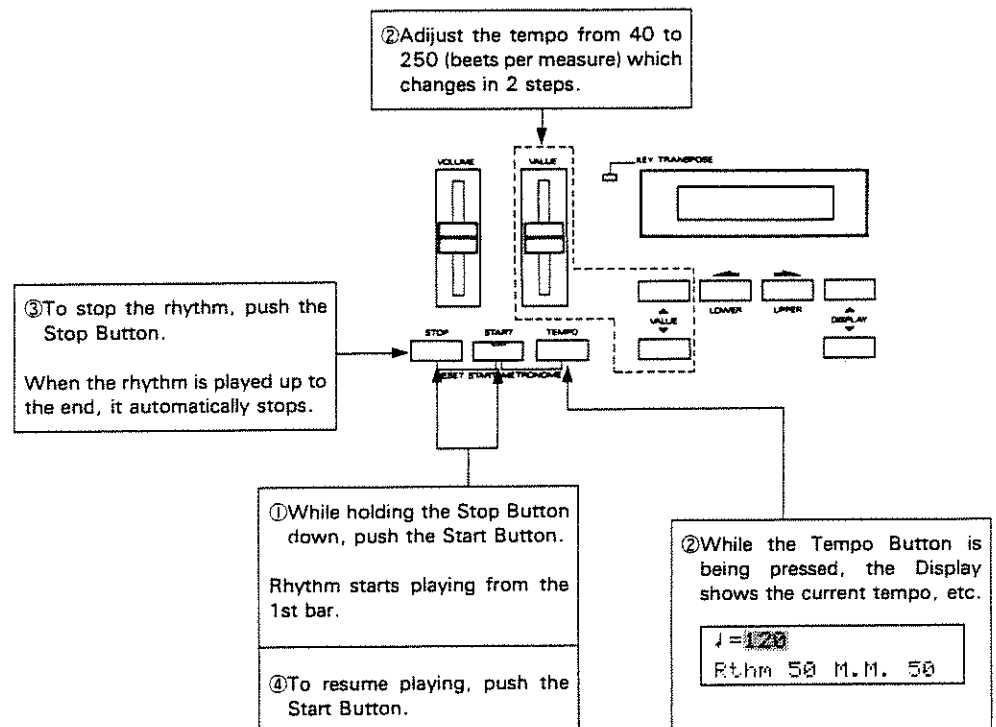

Starting (or stopping) the rhythm can also be controlled by a pedal switch connected to the Start/Stop Socket.

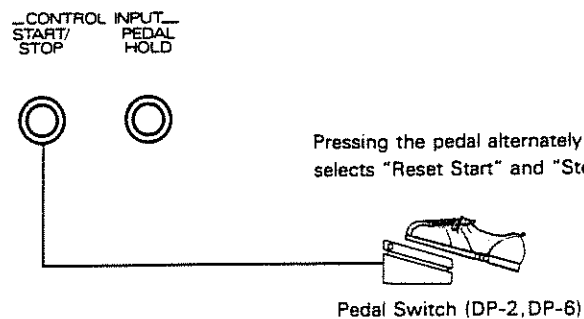

[Level Adjustment]

The volume of the rhythm can be changed as follows.

*The volume you have set is retained even after the unit is turned off.

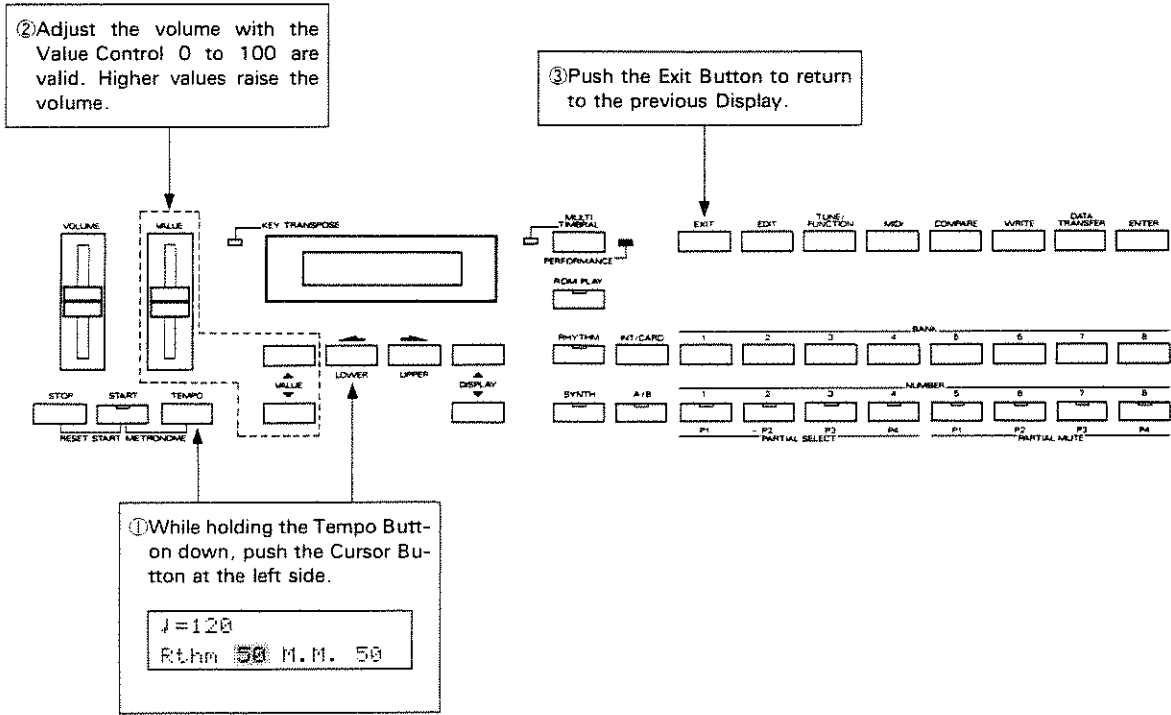

b. Rhythm Mode

The Rhythm mode turns the D-10 into a rhythm machine, allowing you to change rhythm patterns or play a rhythm from the keyboard.

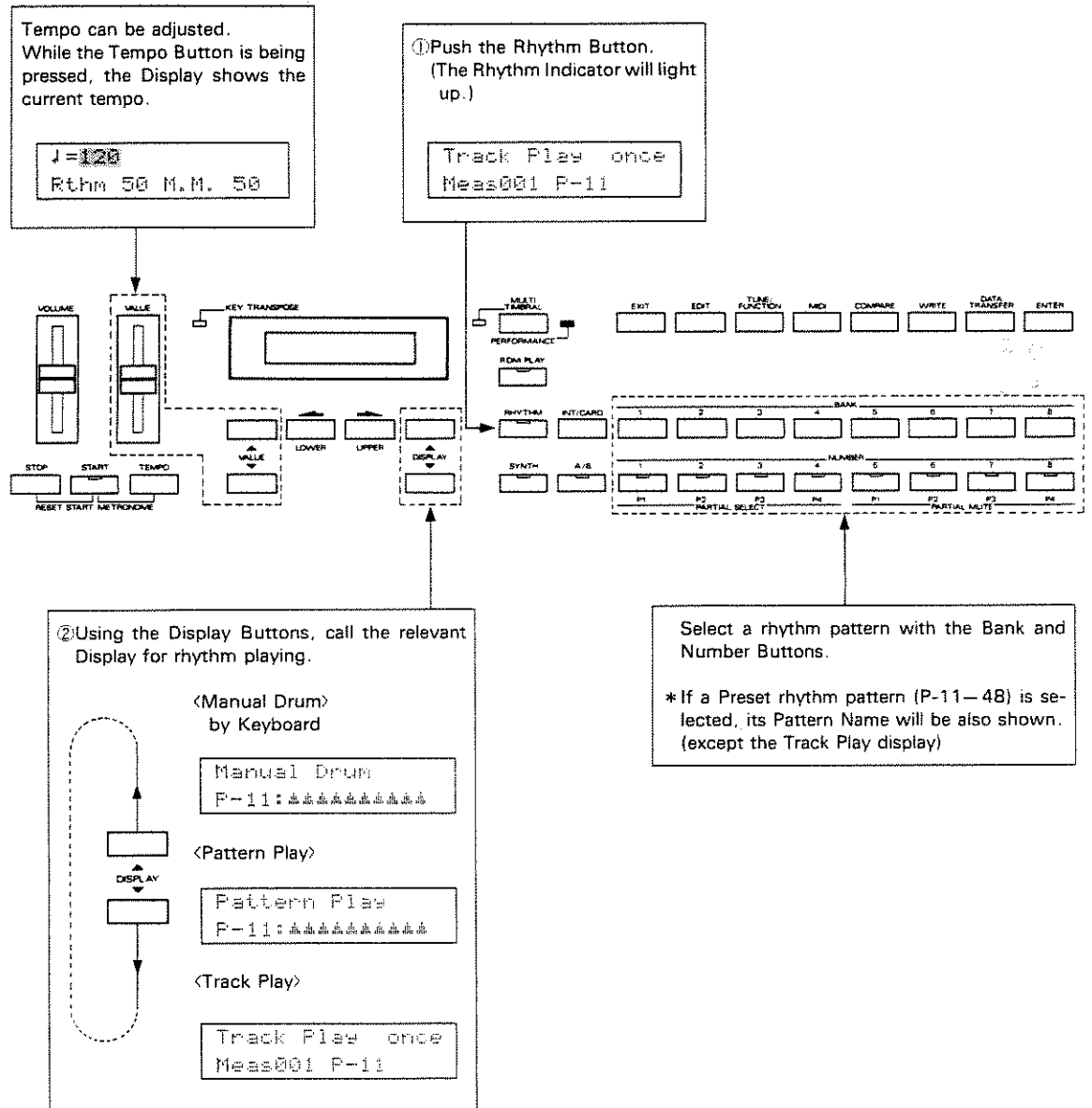

Preset Rhythm Pattern

Number Bank	1	2	3	4	5	6	7	8
1	8Beat 1	8Beat 2	8Beat 3	8Beat 4	8Beat 5	8Beat 6	Ballad	Reggae
2	16Beat 1	16Beat 2	16Beat 3	16Beat 4	16Beat 5	16Beat 6	Shuffle 1	Shuffle 2
3	Disco 1	Disco 2	Electric Pop 1	Electric Pop 2	Jazz 1	Jazz 2	Jazz 3	Jazz Waiz
4	Samba 1	Samba 2	Samba 3	Bossanova 1	Bossanova 2	Mambo	Merengue	Rumba

In the Track Play or Pattern Play mode, you can play the keyboard using the Patch or Timbre previously selected (before pressing the Rhythm Button).

To leave the Rhythm mode and return to the Play mode, push the Synth Button. Depending on which Display (Track Play, Pattern Play or Manual Drum Display) of the Rhythm mode you are in, the rhythm which will be performed in the Play mode differs as shown below. If, however, the unit is turned off once then turned on, a Rhythm Track will be played.

- If the Synth Button is pressed in the Track Play Display, a Rhythm track will be played when the unit is returned to the Play mode.
- If the Synth Button is pressed in the Pattern Play or Manual Drum Display, a Rhythm pattern (previously selected before the Synth Button was pressed) will be played when the unit is returned to the Play mode.

[Track Play]

The Track Play mode allows you to monitor how the Rhythm Track performance is progressing.

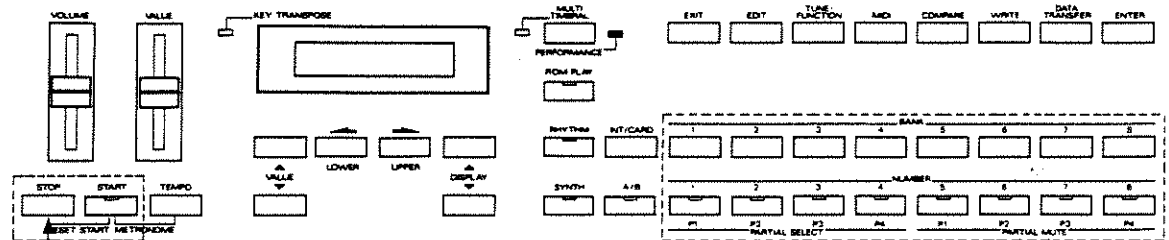

③ To stop playing, push the Stop Button.
When the rhythm is played up to the end, it automatically stops.

① For "Reset start", push the Start Button while holding the Stop Button.
The Display shows the bar number and the Pattern number currently being played.

Track Play once
Mess001 P-11

↑ ↑
Bar Number Pattern Number

④ To resume the rhythm, push the Start Button.

② Select a rhythm pattern with the Bank and Number Buttons, and you can change the rhythm pattern of the next bar temporarily.

● Repeat Play

To repeat play a Rhythm Track, stop the rhythm, then do as shown below.

*The Repeat Play mode you have set will be retained even when the unit is turned on.

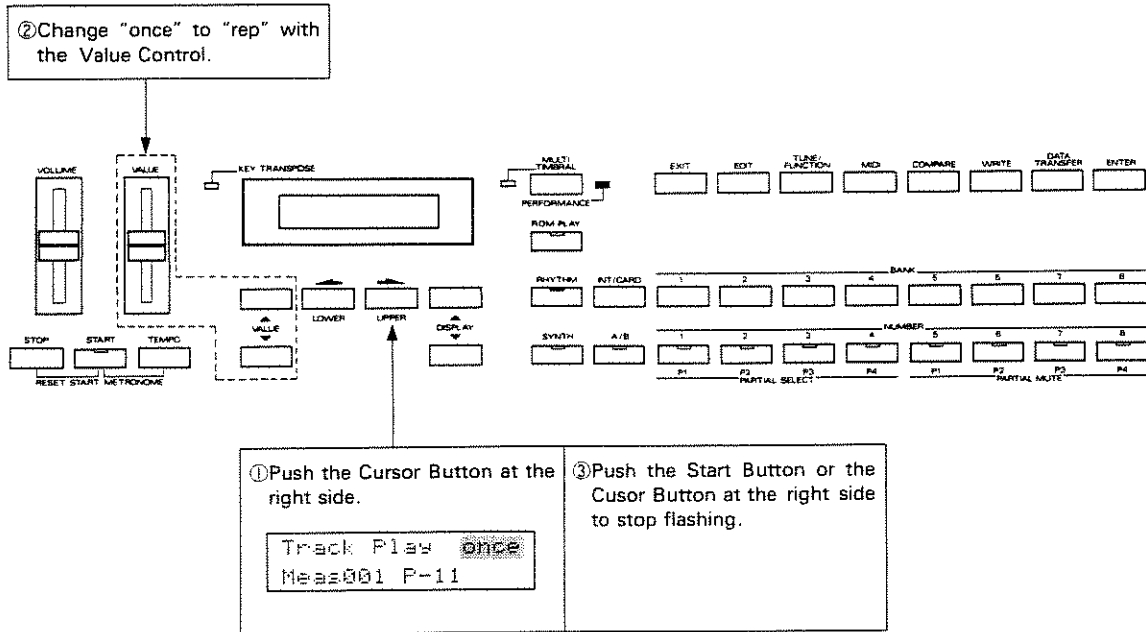

● Playing from the middle of a bar

To start playing from the middle of a bar, do as follows.

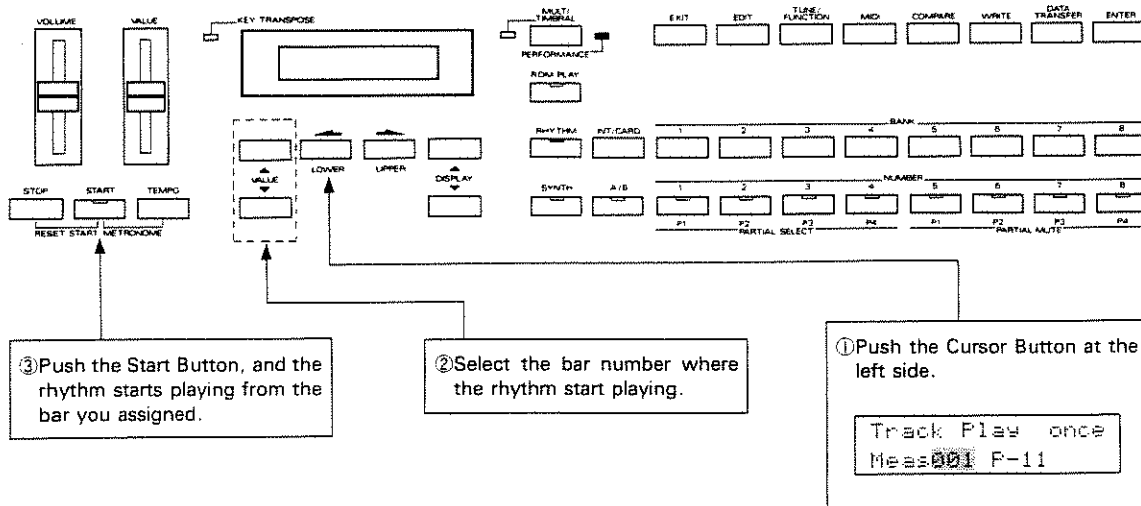

*You cannot assign a bar with the Value Knob.

[Pattern Play]

The Pattern Play mode allows you to play the keyboard while a certain Rhythm pattern is being played.

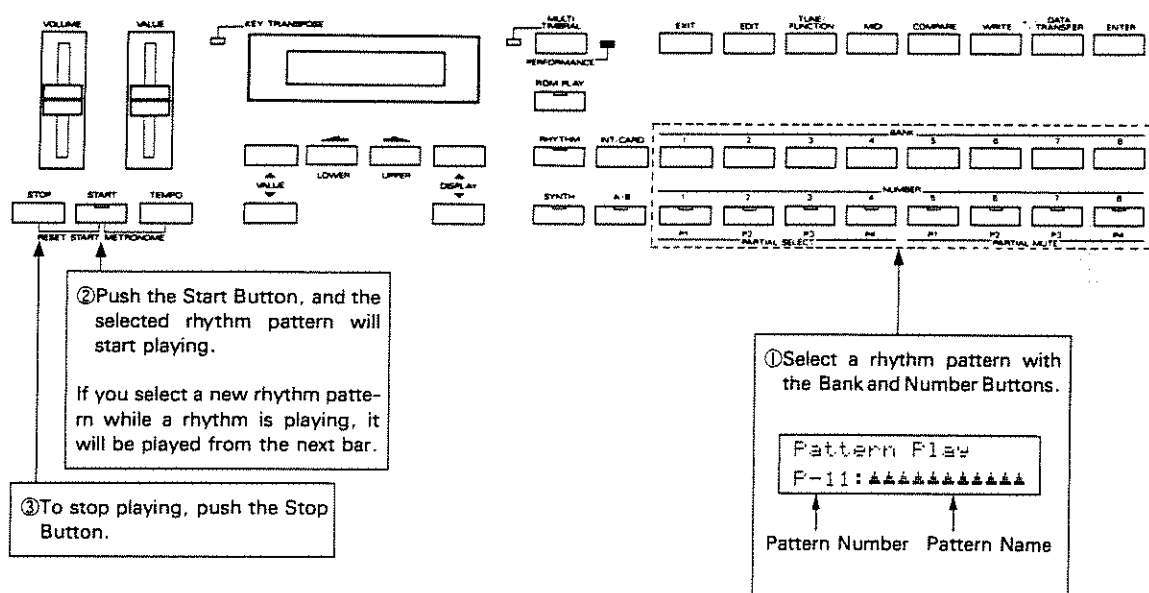

[Manual Drum]

In the Manual Drum mode, a rhythm can be played with the D-10's keyboard. Pressing the Start Button will play the rhythm pattern currently shown in the Display, so that you can play the keyboard to the rhythm.

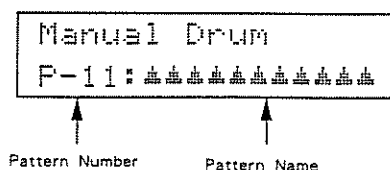

PERFORMANCE MODE

r63	Native Drum-3	C7
r62	Native Drum-2	
r61	Native Drum-1	
r09	Ride Cymbal (short)	
r34	High Tom Tom-3	
r06	Crash Cymbal (short)	
r35	Middle Tom Tom-3	
r02	Closed High Hat-2	
r36	Low Tom Tom-3	
r24	Snare Drum-6	
r23	Snare Drum-5	C6
r22	Snare Drum-4	
r18	Bass Drum-4	
r17	Bass Drum-3	
r60	Bell	
r59	Wood Block	
r37	High Pitch Tom Tom-1	
r58	Triangle	
r38	High Pitch Tom Tom-2	
r57	Castanets	
r27	Brush-2	C5
r26	Brush-1	
r56	Claves	
r12	Cup (mute)	
r55	Quijada	
r54	Long Whistle	
r53	Short Whistle	
r52	Maracas	
r51	Cabasa	
r50	Low Agogo	
r49	High Agogo	C4 (Middle C)
r48	Low Timbale	
r47	High Timbale	
r46	Low Conga	
r45	High Conga	
r44	High Conga (mute)	
r43	Low Bongo	
r42	High Bongo	
r10	Ride Cymbal (mute)	
r21	Snare Drum-3	
r07	Crash Cymbal (mute)	C3
r41	Cowbell	
r14	Splash Cymbal	
r40	Tambourine	
r11	Cup	
r13	China Cymbal	
r08	Ride Cymbal	
r31	High Tom Tom-2	
r05	Crash Cymbal	
r28	High Tom Tom-1	
r32	Middle Tom Tom-2	C2
r03	Open High Hat-1	
r29	Middle Tom Tom-1	
r04	Open High Hat-2	
r33	Low Tom Tom-2	
r01	Closed High Hat-1	
r30	Low Tom Tom-2	
r20	Snare Drum-2	
r39	Hand Clap	
r19	Snare Drum-1	
r25	Rim Shot	
r16	Bass Drum-2	
r15	Bass Drum-1	

Rhythm Tones have been assigned to the keyboard by the manufacturer as shown below. Playing a key will play the corresponding Rhythm Tone.

*The Key assignment or the volume of the Rhythm Tones can be altered, if you like. See page 25 in the Advanced Course "Rhythm Setup".

*To move the Keyboard sound range, take an appropriate transposing procedure (page 33).

5. Metronome

The D-10 features a metronome which can be used for practicing the keyboard or for programming rhythm data.

If you wish to turn on only the metronome, push the Start Button while holding the Tempo Button down.

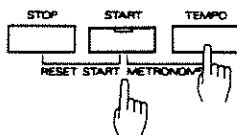

[Volume Adjustment]

The volume of the metronome can be adjusted as shown below.

*The volume you have set here will be retained even after the unit is turned off.

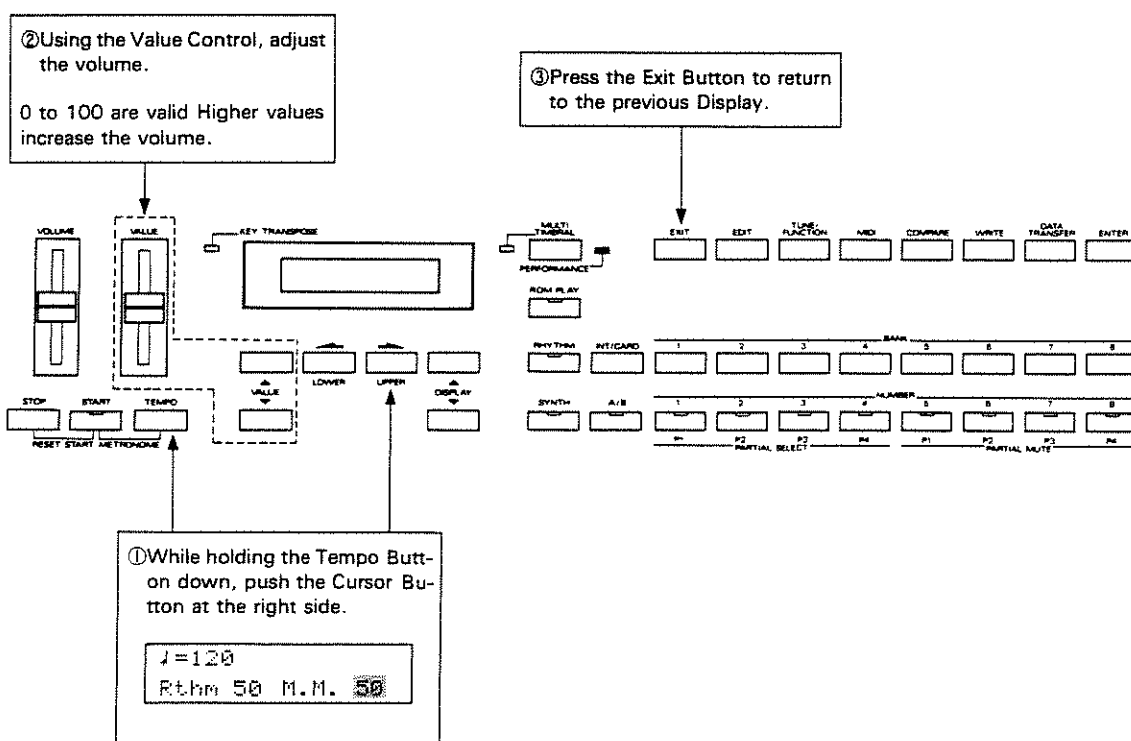

[Beat Setting]

You can change the beat of the metronome which is used on its own, as shown below. While in recording, the metronome will play to the beat of the rhythm regardless of the beat you have set.

*The beat you have set will be retained even after the unit is turned off.

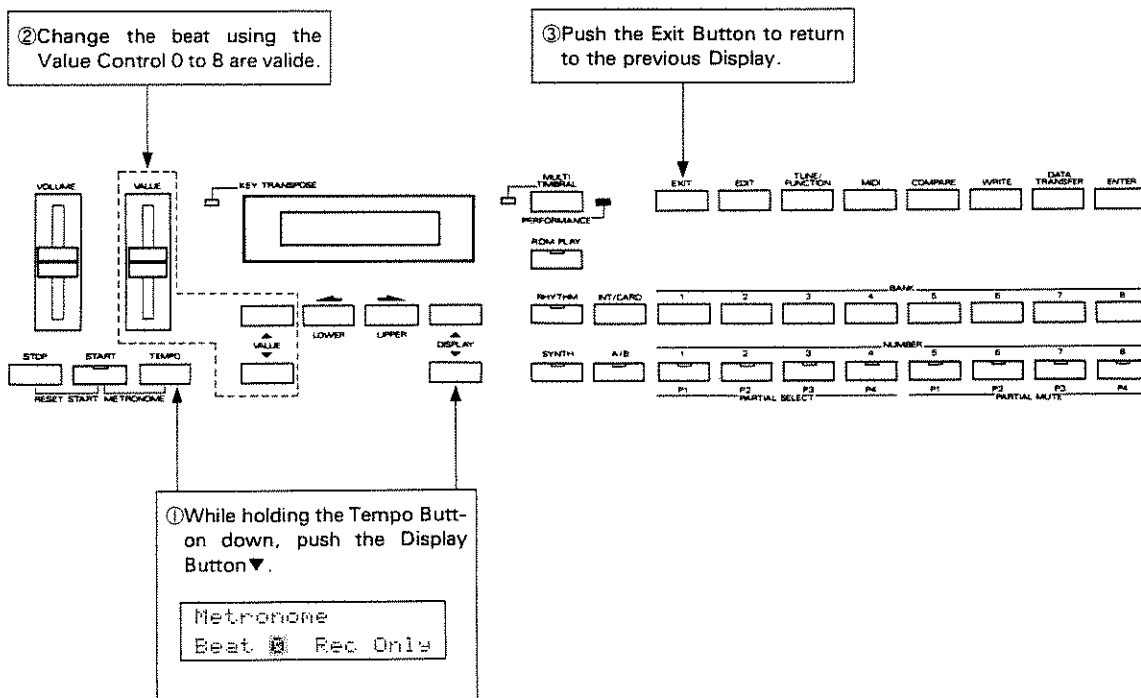

[Playing the Metronome with the rhythm performance]

To play the metronome with the rhythm performance, change the Metronome modes as shown below.

*The Metronome mode you have set here will be retained even after the unit is turned off.

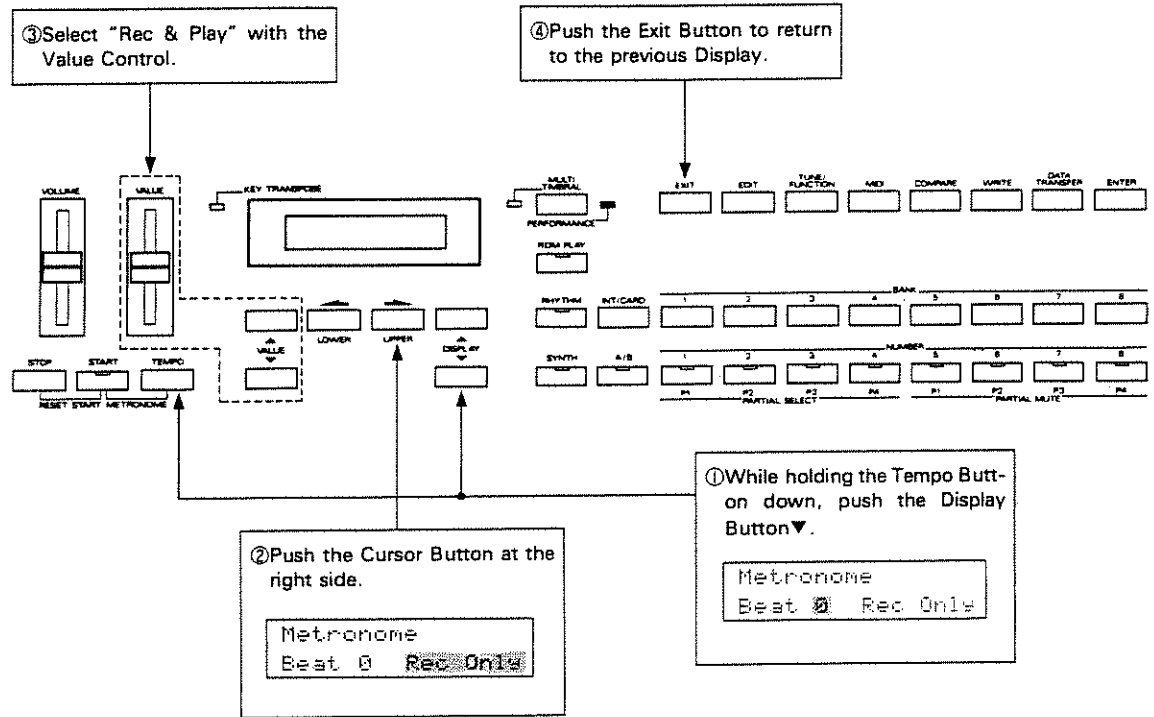

6. Master Tuning

Master Tuning adjusts the pitch of the D-10 to that of other musical instruments.

*The Master Tuning value you have set will be retained even after the unit is turned off.

*A Tone which uses a PCM sound may not be correctly tuned by the Master Tuning function.

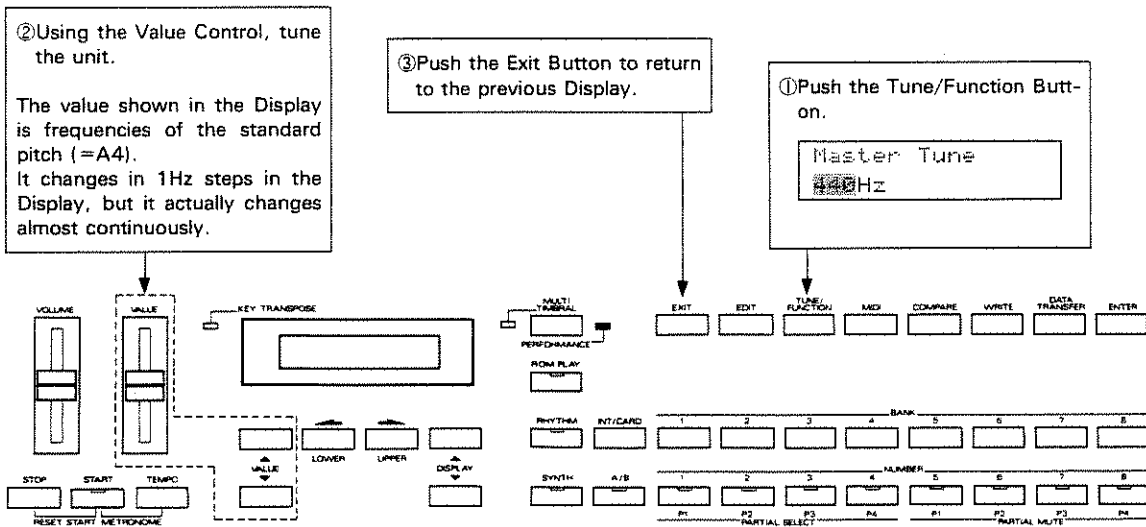

7. Key Transpose

The Key Transpose function transposes the entire keyboard in semi-tone steps, allowing you to play the same keyboard in different keys.

*The Key Transpose value you have set will be retained even after the unit is turned off.

*The Key Transpose function does not work in the Rhythm Setup or Rhythm Pattern programming mode.

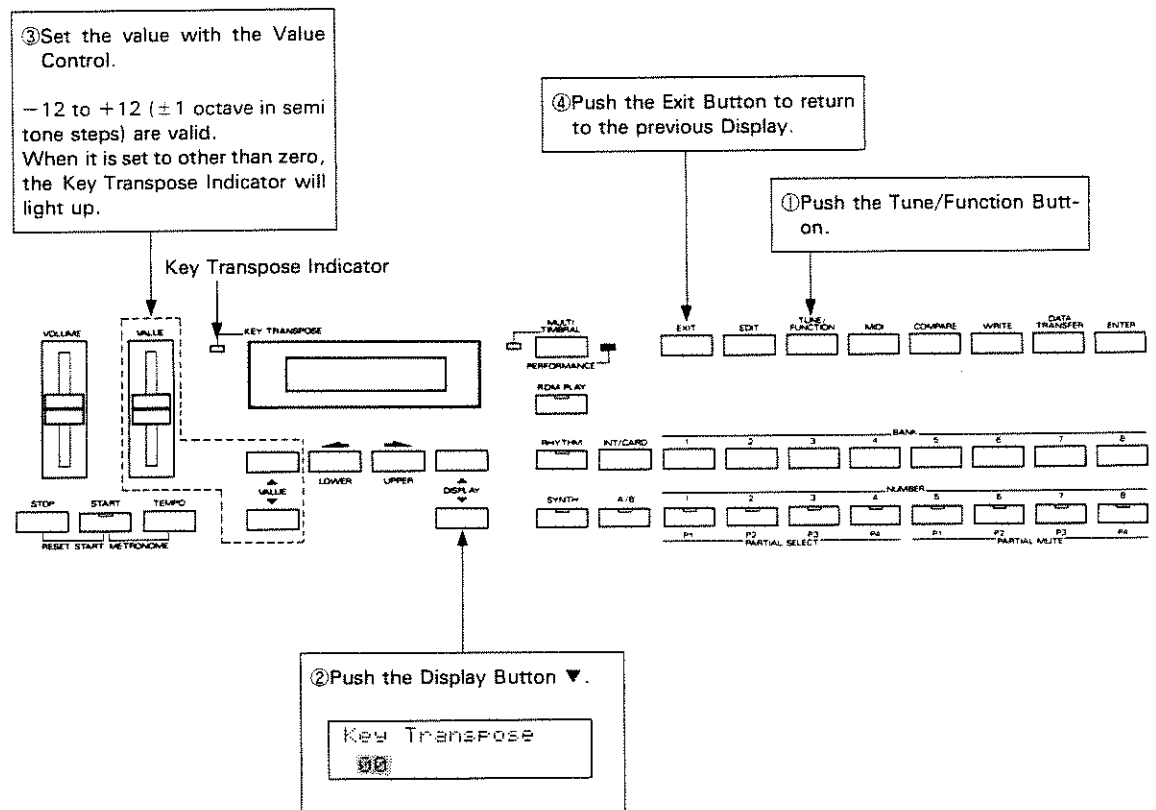

5 ROM Play

Eight different songs are programmed in the D-10 in order to demonstrate the effects of the Multi Timbral function. Playing these preprogrammed songs is called ROM Play. When playing these songs, please use a stereo amplifier if possible, to obtain the best effect of the Multi Timbral functions.

[Procedure]

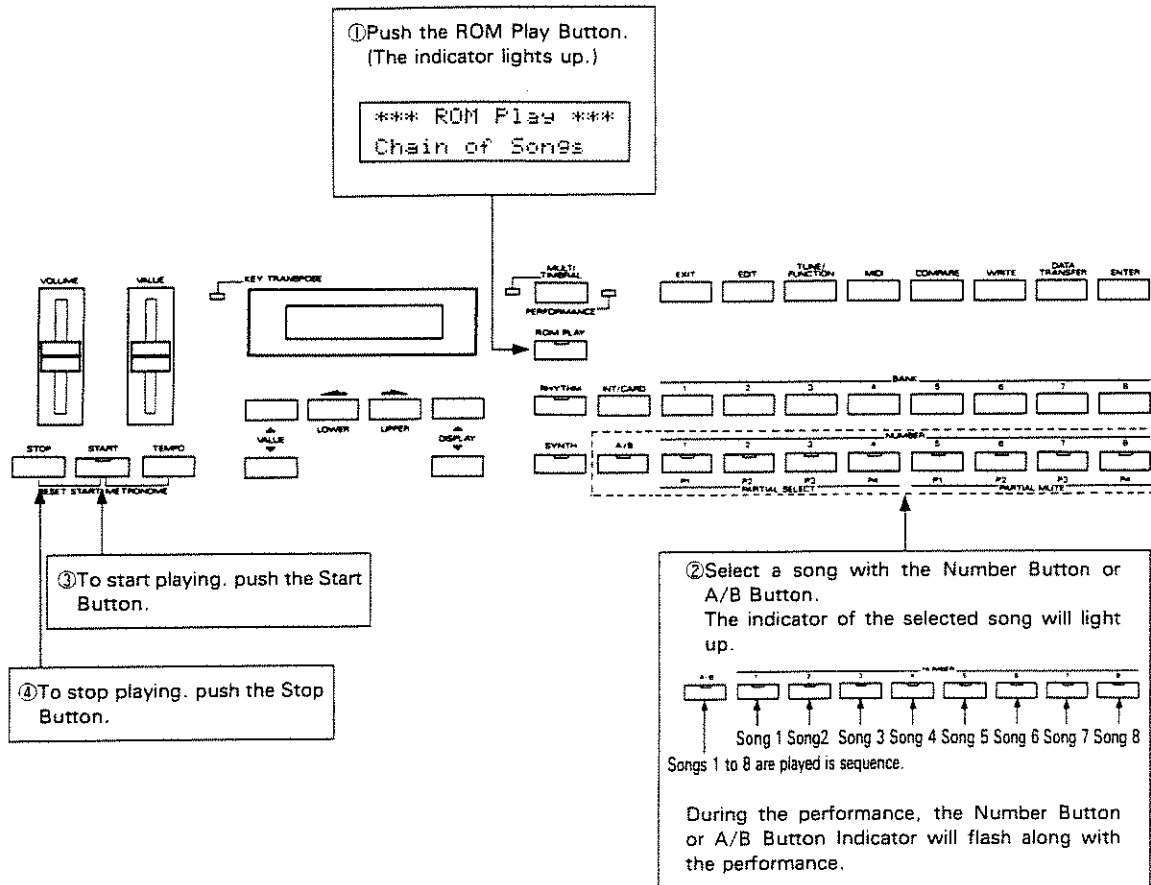

Song Number	Song Name	
1	Macho Memory	Music by Eric Persing ©1988 by Eric Persing
2	Jah May Kah !	Music by Amin Bhatia ©1988 by Amin Bhatia
3	Sugar Plum	Composed by Tchaikovski Arranged by Amin Bhatia
4	My Brother	Music by Adrian Scott ©1988 by Adrian Scott
5	Folk	Music by Amin Bhatia ©1988 by Amin Bhatia
6	Bumble Dee	Composed by Rymsky-Korsakow Arranged by Amin Bhatia
7	Mergatroid	Music by Eric Persing ©1988 by Eric Persing
8	Dinner Set	Music by Adrian Scott ©1988 by Adrian Scott

***During ROM Play, you cannot play the keyboard or use the controls such as a bender.**

***The performance data of the ROM Play is not sent through the MIDI OUT Connector.**

6 SPECIFICATIONS

D-10 : Multi Timbral Linear Synthesizer with
a built-in Rhythm Machine

Keyboard

61 Keys (with Velocity)

Sound Source

LA System

Maximum Voices : 32 Voices

Synthesizer Section

Patches : 128

Timbres : 128

Preset Tones : 128

Programmable Tones : 64

Preset Rhythm Tones : 63

Rhythm Section

Setups : 85 types (C1 to C8)

Preset Rhythm Patterns : 32

Programmable Rhythm Patterns : 32

Rhythm Pattern

Maximum number of notes to be
simultaneously recorded : 8

Rhythm Pattern

Maximum number of notes to be recorded
(in each Rhythm Pattern) : 96 notes

Rhythm Track

Maximum number of bars to be recorded
: 500

Memory Card (M-256D, M-256E)

Patches : 128

Timbres : 128

Tones : 64

Rhythm Patterns : 32

Rhythm Track : One Song

Rhythm Setups : One Set

[Front Panel]

Volume Knob

Value Knob

Stop Button

Start Button

Tempo Button

Value Button ×2

Cursor Button ×2

Display Button ×2

Mode Button

ROM Play Button

Rhythm Button

Synth Button

Internal/Card Button

A/B Button

Bank Button ×8

Number Button ×8

Exit Button

Edit Button

Tune/Function Button

MIDI Button

Compare Button

Write Button

Data Transfer Button

Enter Button

Bender Lever

[Display]

2 lines, 16 letter (back-lit)

[Indicators]

Start Indicator

Key Transpose Indicator

Multi Timbral Indicator

Performance Indicator

ROM Play Indicator

Synth Indicator

Rhythm Indicator

A/B Indicator

Number Indicator ×8

[Rear Panel]

Output Socket ×2

Headphones Socket

Start/Stop Socket

Pedal Hold Socket

MIDI Connectors (IN, OUT, THRU)

Dimensions : 974 (W) × 301 (D) × 98 (H) mm
38-3/8" × 11-7/8" × 3-7/8"

Weight : 19 lb 7 oz

Consumption : 20W

Accessories :

Owner's Manual (Basic/Advanced)

Quick Operation Table

Sound Chart

Guide Book for MIDI

Connection Cable (LP-25)

[Options]

Memory Card (RAM) M-256D, M-256E

Carrying Case SHC-1

Programmer PG-10

Stereo Headphones RH-100

Pedal Switch DP-2/DP-6

MIDI/SYNC Cable MSC-07/15/25/50/100

1
2
3
4
5



MIDI MULTI TIMBRAL LINEAR SYNTHESIZER

D-10

Owner's Manual



CONTENTS

Advanced Course (Volume 2)

1 Multi Timbral Mode	2	4) Pitch ENV	99
1. Concept of		5) TVF Frequency/ENV	101
the Multi Timbral Mode	2	6) TVF ENV	105
2. Effective Use of		7) TVA Level	107
the Multi Timbral Mode	6	8) TVA ENV	110
a. Examples	6	d. Writing Procedure	112
b. Sync	9	1) Writing into	
3. Multi Timbral Play	11	the internal memory	112
a. Power-up	11	2) Writing onto a memory card	114
b. Changing Displays	12		
c. Timbre Selection	14		
4. Function Setting	17	3 MIDI in the Performance Mode	116
a. MIDI Function Setting	17	1. Performance Mode	116
b. Tune/Function Setting	20	2. Effective Use of	
		the Performance Mode	117
		a. Examples	117
		b. Sync	119
		3. MIDI Function Setting	121
2 Edit	25		
1. Rhythm	25	4 Data Transfer	126
a. Rhythm Setup	25	1. Copying with a memory card	126
1) Editing Procedure	25	a. Saving	127
2) Writing Procedure	30	b. Loading	130
b. Rhythm Pattern Programming	31	2. Data Transfer via MIDI	133
1) Editing Procedure [I]	31		
2) Editing Procedure [II]	38		
3) Writing Procedure	41		
c. Rhythm Track Recording	45	5 LA System	138
1) Recording	45	1. Outline	138
2) Erasing	51	2. Understanding of Sound Synthesis	142
2. Patch and Timbre	52	a. Structure	142
a. Patch	52	b. The Editing Procedure	146
1) Editing Procedure	52		
2) Patch Parameters	54		
b. Timbre	62		
1) Editing Procedure	62	6 Trouble Information	147
2) Timbre Parameters	64	1. Before Calling for Service	147
c. Writing Procedure	67	2. Error Messages	150
1) Writing into			
the internal memory	67		
2) Writing onto a memory card	71		
3. Tone	73	7 Appendix	153
a. Tone and Partial	73	1. Tables	153
1) Partial and Structure	73	a. Performance Mode	153
2) Partial	77	b. Multi Timbral Mode	154
b. Editing Procedure	80	c. Tone Parameters	155
1) Editing Procedure	80	d. PCM Sounds	156
2) Editing Functions	85	e. Preset Rhythm Tones	158
c. Tone Parameters	88	f. Preprogrammed Rhythm Setup	158
1) Common	88	g. Preset Tones	159
2) WG Pitch/Modulation	91	h. Others	160
3) WG Form/Pitch ENV	94	2. Sample Notes	161
		a. Patch/Timbre	161
		b. Tone	162
		c. Rhythm Setup	163

1 MULTI TIMBRAL MODE

When using the D-10 in the Multi Timbral mode, please read the supplied "MIDI Guidebook" before this owner's manual.

1. Multi Timbral Mode

Multi Timbral mode turns the D-10 into a sound module that consists of a sound block of 8 independent parts and a rhythm machine. So, when playing the D-10 with a MIDI device such as a MIDI sequencer, you can easily create an ensemble style of performance.

The following picture shows how the performance messages move in the Multi Timbral mode.

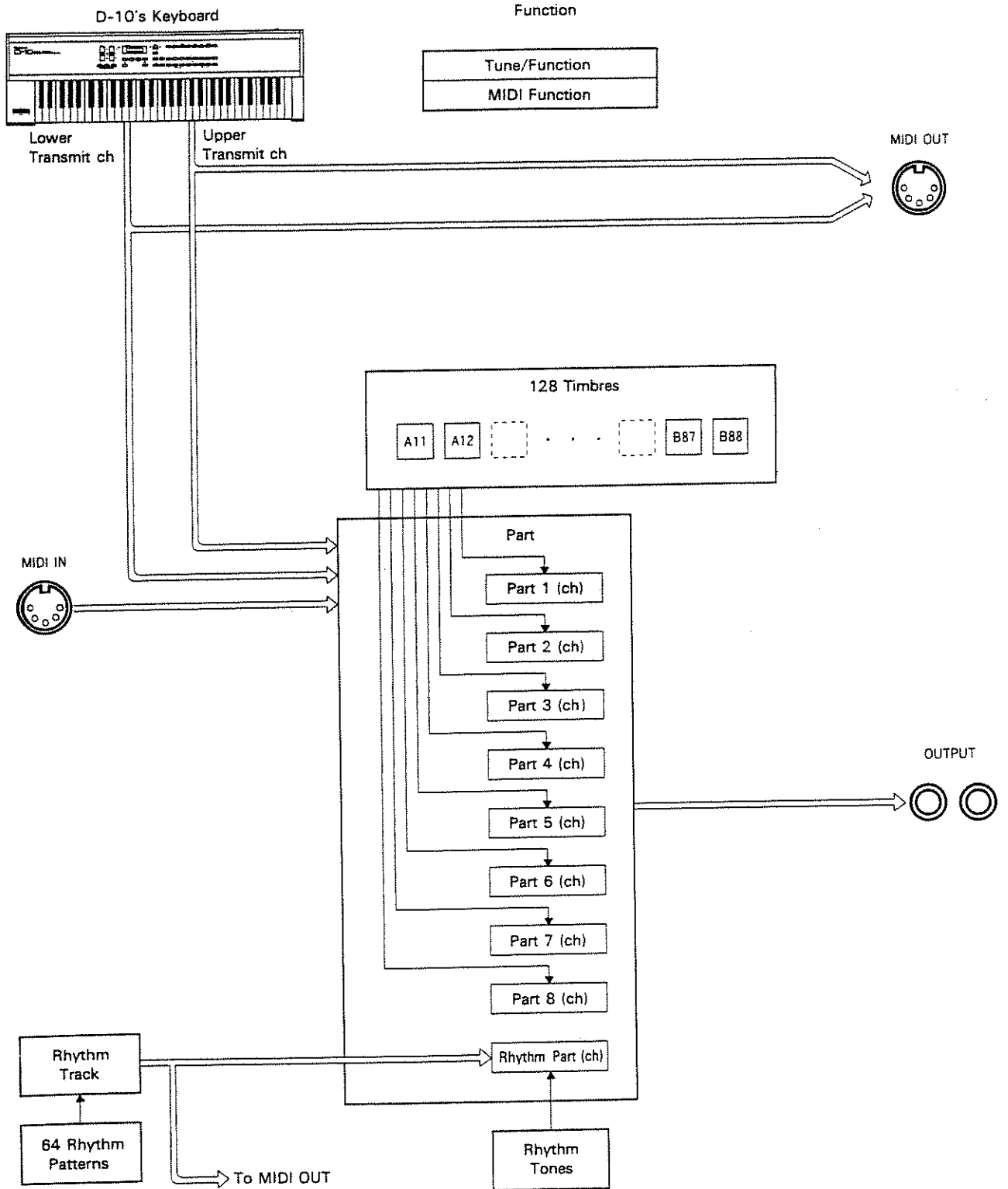

● Part

Each of the 9 Parts has an independent MIDI channel, and therefore can be considered as 9 separate MIDI sound modules. Any of the 128 Timbres can be assigned to each Part. Also, up to 85 Rhythm Tones can be assigned to the Rhythm Part. Timbre assignment for each Part can be changed using the buttons on the D-10's panel or Program Change messages sent from an external device.

● Keyboard

The keyboard of the D-10 is an independent section. The keyboard can be divided into two sections at any key (=Split Point), and each section has a different MIDI transmit channel. This fact enables you to play a different Part in a different keyboard range. Keyboard performance information is transmitted through the MIDI Output on a Keyboard Transmit channel for each keyboard section.

● Function

Functions involve parameters which determine how the system works, e.g. how each Part is played by MIDI messages, etc.

The followings will explain how the MIDI messages actually affect each Part.

- Keyboard performance messages are sent to each keyboard section (divided at the Split Point) on the respective MIDI channel. Performance messages can play the Part which has the same channel number. For instance, if the MIDI Transmit channel of the Lower keyboard is 1 and the MIDI channel of Part 1 is 1, the performance messages of the lower range of the keyboard can play the Timbre assigned to Part 1.
- Pitch Bender, Modulation or Hold Control messages of the D-10 are sent out on the MIDI Transmit channel of each keyboard. In other words, these messages add variety to the Part played from the keyboard.
- Performance messages received through MIDI IN will play the Part that has the same MIDI channel. In other words, performance messages recorded in a sequencer on a certain MIDI channel can independently play the Part that has the same MIDI channel.
- The Rhythm Part can play a Rhythm Tone not only with the Rhythm Pattern or Rhythm Track performance, but also with performance messages received on the MIDI channel assigned to the Rhythm Part.
- Through MIDI OUT, keyboard performance messages and performance data of the Rhythm Part are sent out on the respective MIDI Transmit channel. That is, the sound source of an external MIDI device can be played by keyboard performance messages or Rhythm performance data.

2. Effective Use of the Multi Timbral Mode

a. Examples

The following are examples for using the Multi Timbral mode effectively.

[Using a MIDI sequencer]

Play the keyboard using a Part you like, play the Rhythm Part in the rhythm track on the D-10, and play other Parts with a MIDI sequencer.

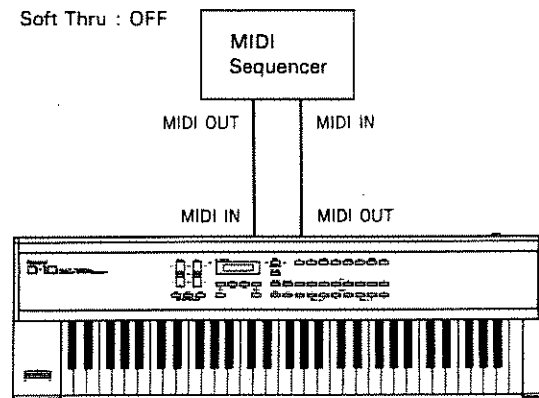

○ For playing two different Timbres, such as bass and melody, from the keyboard at the same time, you should set each keyboard transmit channel to the MIDI channel of the Part to be used.

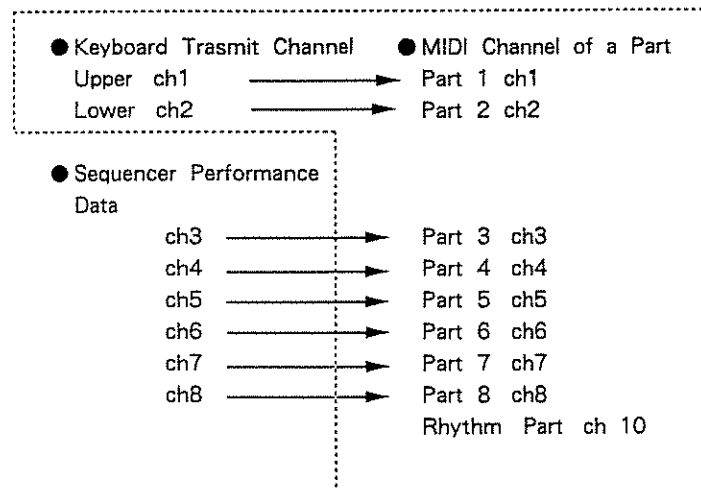

- For playing only one Timbre from the keyboard, set the keyboard transmit channels of the upper and lower sections to the same number as the MIDI channel of the Part to be used.

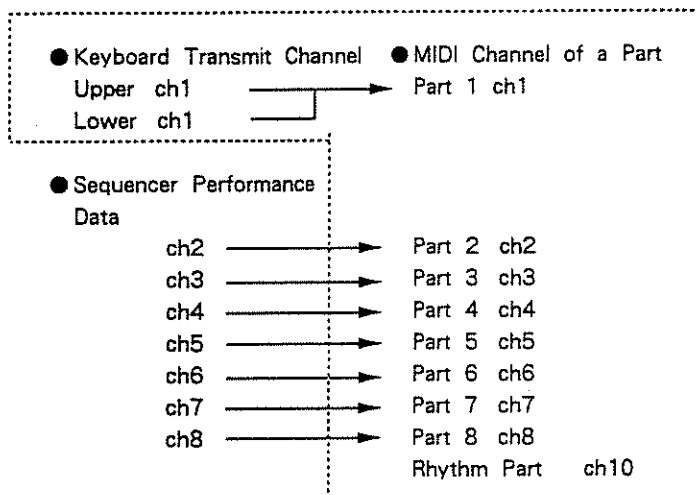

- To play rhythms with the sequencer, set the MIDI channel of the sequencer's rhythm data and the MIDI channel assigned to the Rhythm Part of the D-10 to the same number.

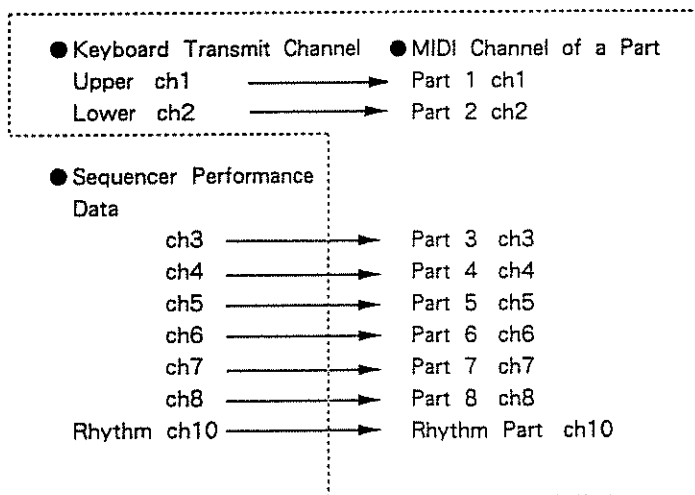

[Using a MIDI sequencer and MIDI sound module]

For playing an external MIDI sound module from the keyboard of the D-10, set the keyboard transmit channel to the MIDI channel of the external sound module.

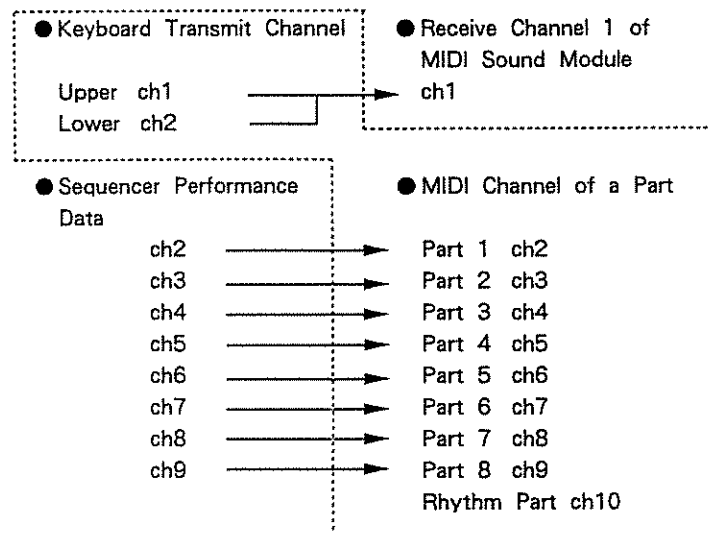
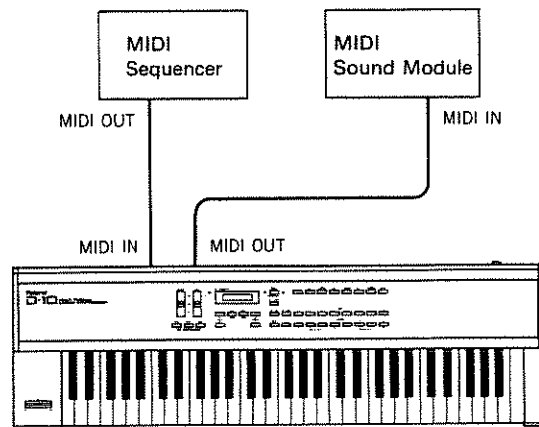

b. Sync

When performing using a MIDI sequencer's data and the D-10's Rhythm data, the tempo of the two devices should be at the same speed. That is, one of the two devices should become a slave device to synchronize to the other (=master device).

***Sync signals can be transmitted or received regardless of the MIDI channel setting.**

[Using the D-10 as a Master]

Set the external device (=slave) so that it can receive the sync signal sent from the D-10 (=master).

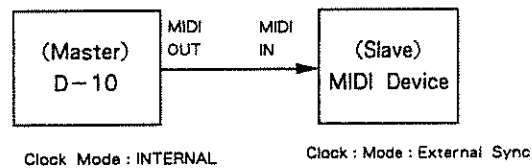

***The D-10 is normally set to the Internal mode.**

[Using the D-10 as a Slave]

Set the D-10 (=slave) so that it can receive the sync signal sent from the external device (=master).

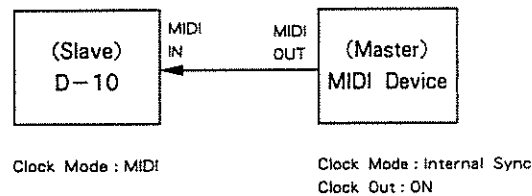

When the D-10 is set to the MIDI mode, [tempo] will be shown as below, and the D-10 can no longer control the tempo.

```
J=MIDI
Rthm 50 M.M. 50
```

[Clock Mode Setting]

To enter the Clock mode, do as follows.

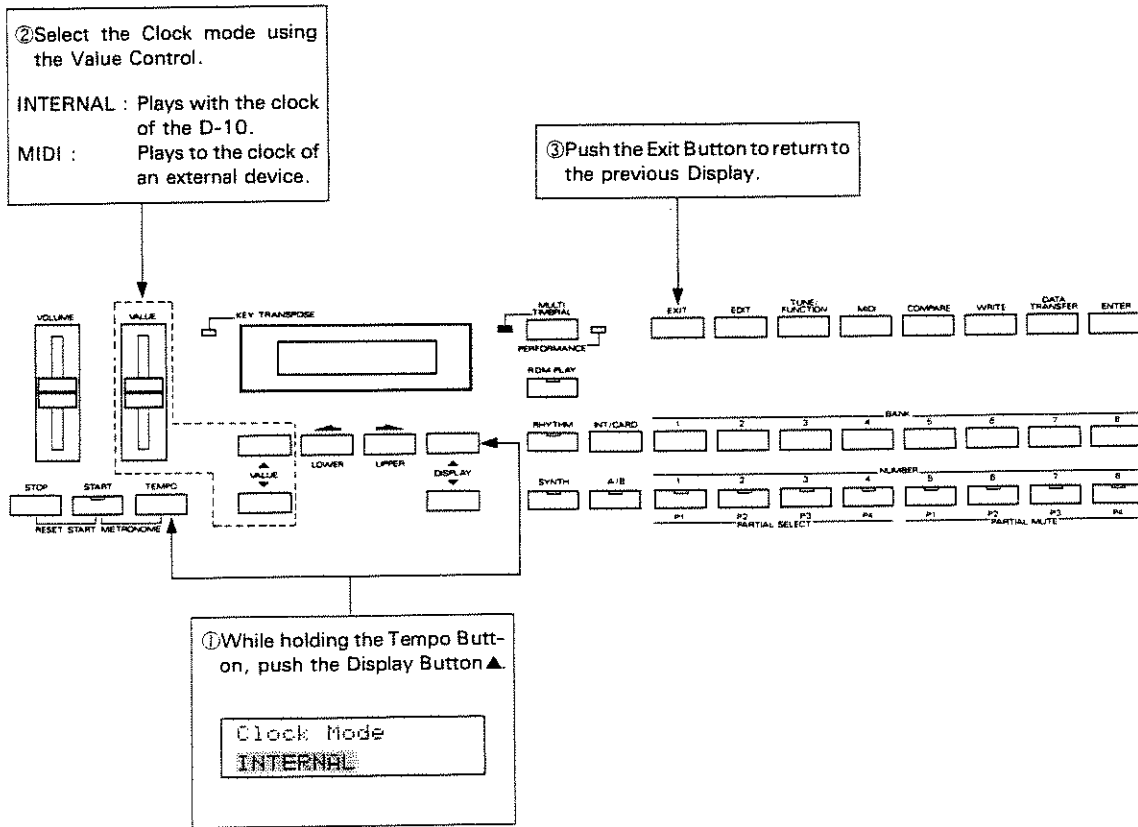

*The Clock mode you have set will be retained even when the unit is turned off.

*If you do not wish to use the Rhythm section of the D-10 but use the Rhythm Part as a MIDI sound module, be sure to set the D-10 to the Internal mode. This is to prevent the Rhythm section from playing in sync with the signal from the external device.

*When the Stop message is received while setting the Clock mode to MIDI, a performance will stop at the end of the bar receiving the Stop message.

3. Multi Timbral Play

a. Power-up

First of all, make sure that the D-10 is correctly connected to the external device.

- Step 1 Turn the D-10 on.
- Step 2 Turn the MIDI sequencer on.
- Step 3 Push the Mode Button to select the Multi Timbral mode.

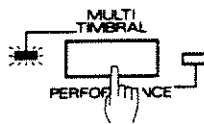

b. Changing Displays

In the Multi Timbral mode, you can check the setting of each Part or keyboard by changing the Displays.

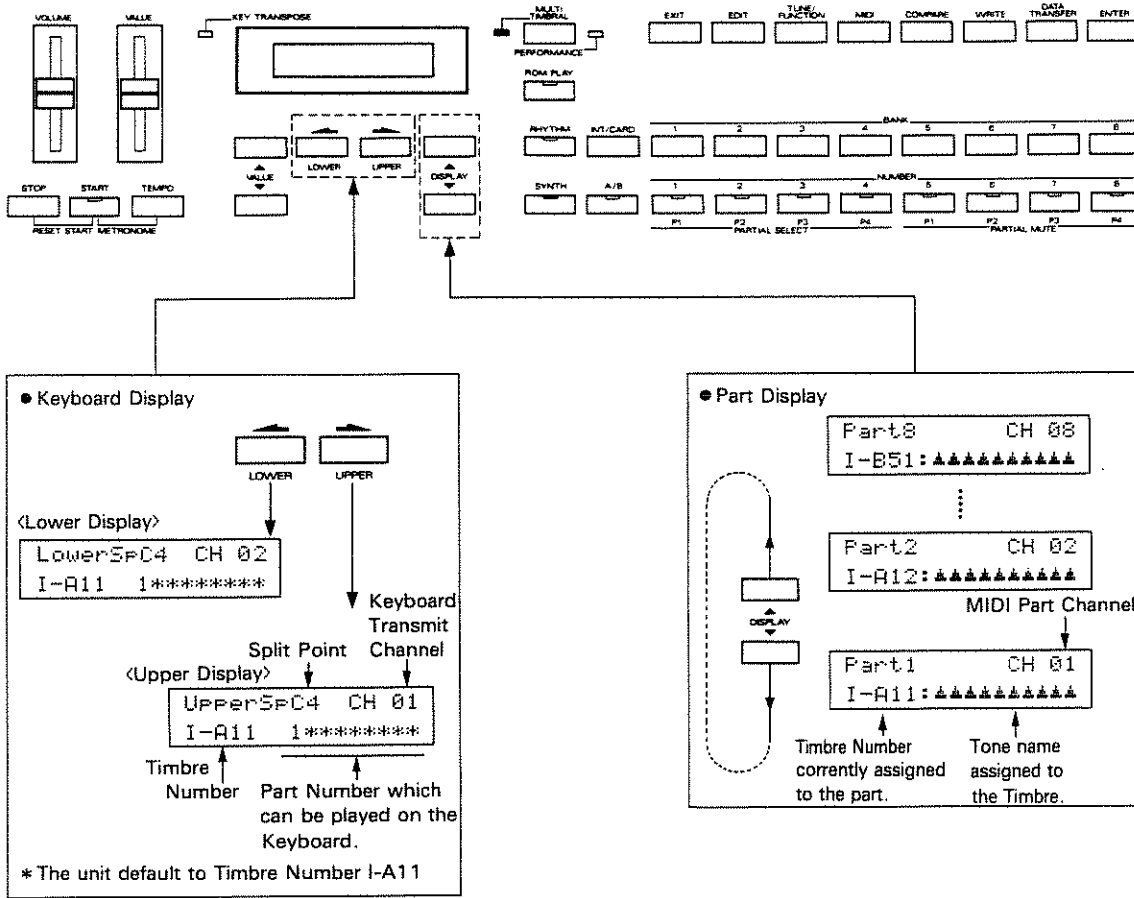

*Just like a Patch in the Performance mode, a Timbre can be called by assigning a Group (A/B), Bank (1-8) and Number (1-8).

Channels and the Split Point on the keyboard are preprogrammed by the manufacturer as shown below. So, playing the upper sound range will produce the sound of Part 1 and playing the lower range will produce Part 2.

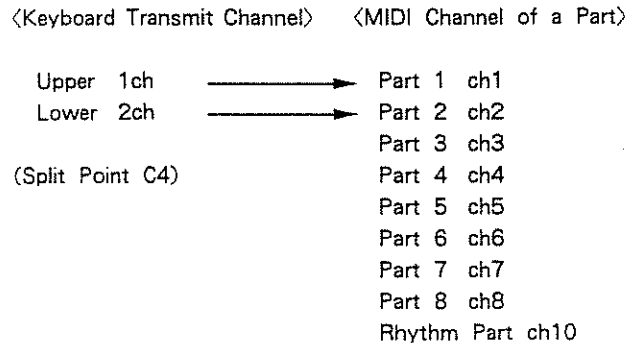

*To change the MIDI channel assigned to each Part or keyboard transmit channel, see page 17 "MIDI Function Setting".

*To change the Split Point on the keyboard, see page 20 "Tune/Function Setting".

How each Part is being played can be seen by the A/B and Number Indicators. (The indicators that correspond to the Part currently being played are lit.)

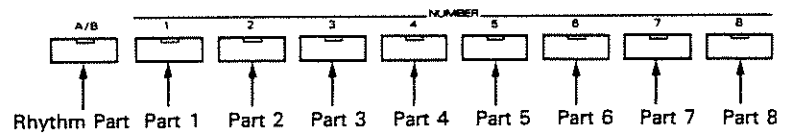

c. Timbre Selection

You can change the Timbre assigned to each Part to another one as shown below.

[Timbre Selection on the D-10]

<Timbre Selection in each Part>

Changing the Timbre assigned to each Part do as follows.

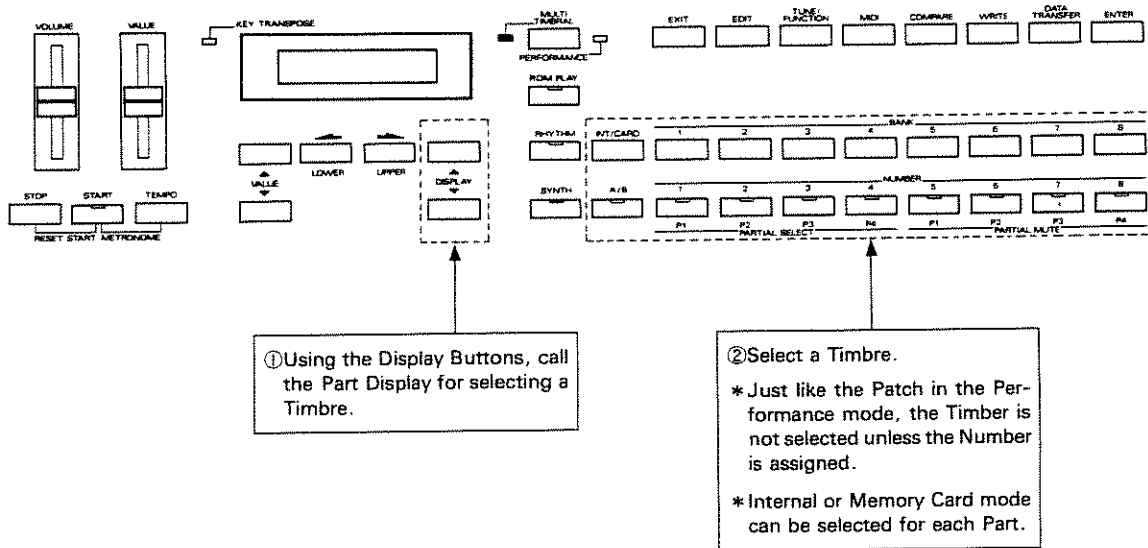

*When the unit is turned off, the Timbres assigned to all the Parts are returned to the Internal.

*The above Timbre selecting procedure does not cause corresponding Program Change messages to be transmitted from MIDI OUT.

● Timbre Selection for the Keyboard

The following procedure will allow you to change the Timbre assigned to the Part you are playing from the keyboard and to transmit the corresponding Program Change messages to the connected device.

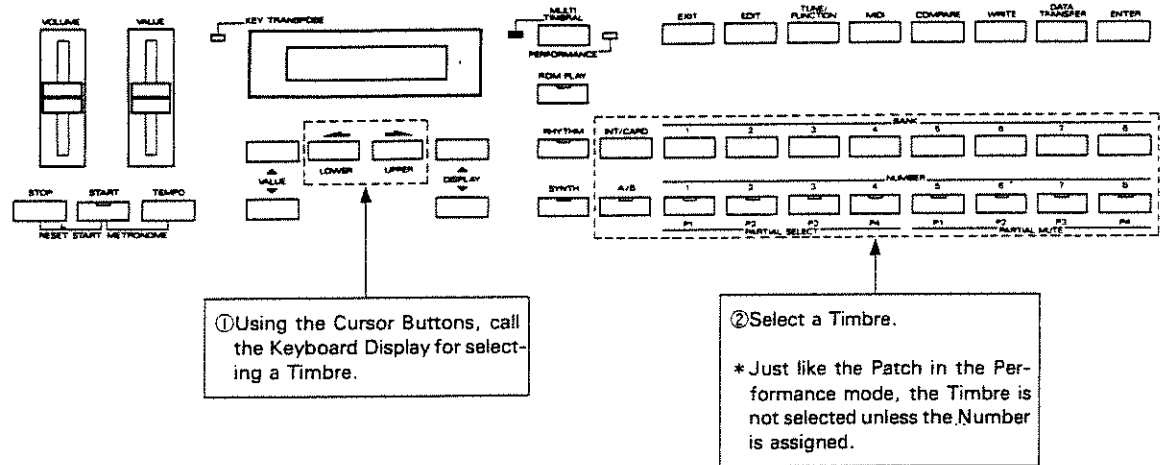

The Timbre numbers correspond to Program Change numbers as shown below. A Program Change number selects the corresponding Tone in the Internal or on the Memory Card.

Group	Number		1	2	3	4	5	6	7	8
	Bank									
A	1		1	2	3	4	5	6	7	8
	2		9	10	11	12	13	14	15	16
	3		17	18	19	20	21	22	23	24
	4		25	26	27	28	29	30	31	32
	5		33	34	35	36	37	38	39	40
	6		41	42	43	44	45	46	47	48
	7		49	50	51	52	53	54	55	56
	8		57	58	59	60	61	62	63	64
B	1		65	66	67	68	69	70	71	72
	2		73	74	75	76	77	78	79	80
	3		81	82	83	84	85	86	87	88
	4		89	90	91	92	93	94	95	96
	5		97	98	99	100	101	102	103	104
	6		105	106	107	108	109	110	111	112
	7		113	114	115	116	117	118	119	120
	8		121	122	123	124	125	126	127	128

*Number 0 to 127 are used as Program Change Messages in the actual MIDI Format.

*The number shown in the Keyboard Display is not the Timbre number used in the Part you have assigned. It is the Timbre number corresponding to the Program Change number. Therefore, changing the Timbre in the Part Display does not change the number (=Program Change number) of the Keyboard Display.

***When the unit is turned off, the Timbres assigned to all the Parts are returned to the Internal.**

[Timbre Selection from an External Device]

The Timbres on the D-10 can also be changed by Program Change messages sent from an external device (as explained on the previous page), but the Program Change messages cannot switch between the Internal and Memory Card modes. Therefore, if the Part that uses a Timbre of a memory card receives Program Change messages, the Timbre of the memory card will be changed in that Part.

4. Function Setting

a. MIDI Function Setting

Switch the unit to the Multi Timbral mode (the Multi Timbral Indicator is lit) before taking the following MIDI function setting procedures.

*The changes you have made will be retained in memory even after the unit is turned off, except in a few cases.

[Editing Procedure]

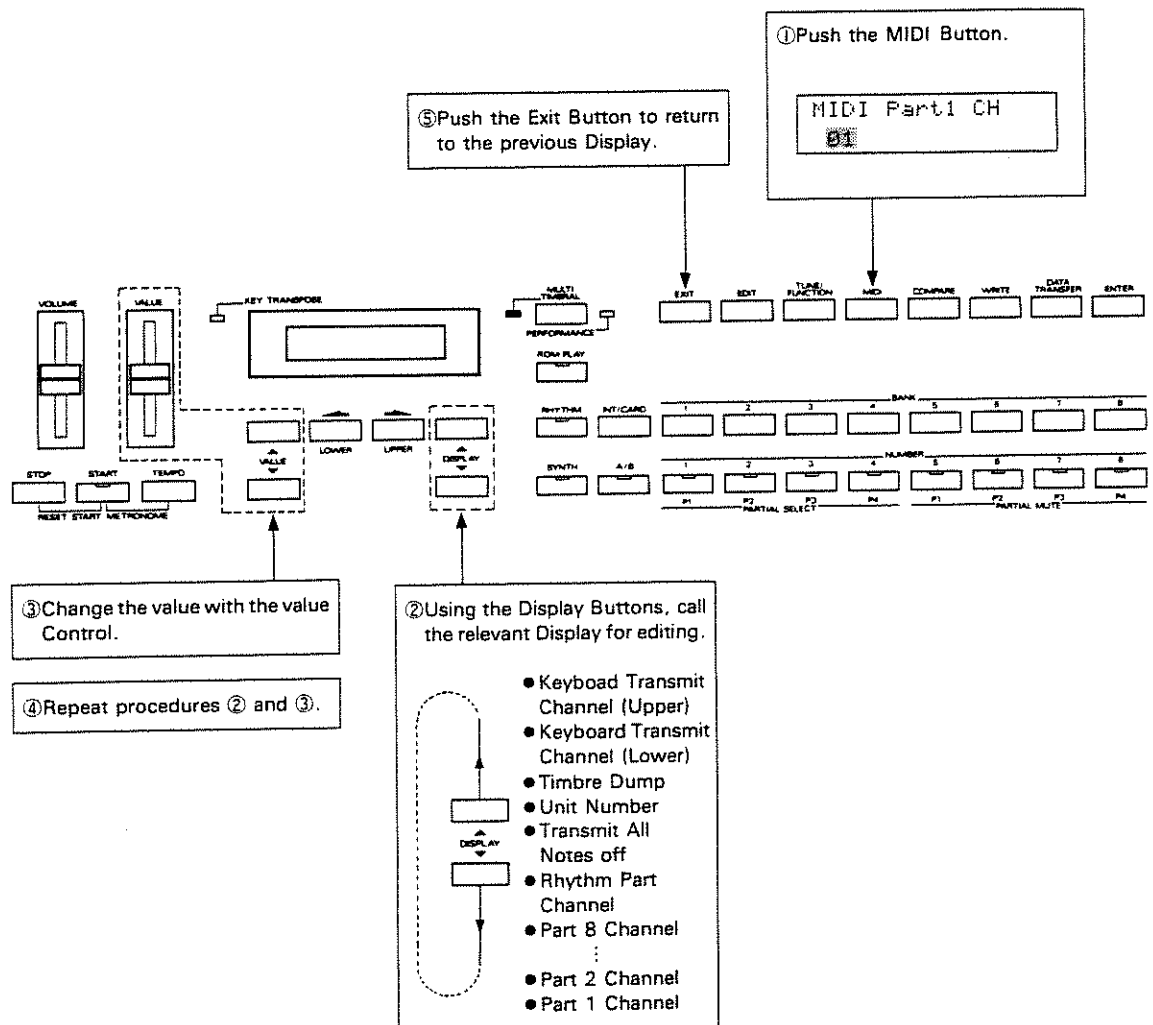

[MIDI Functions]

● Part Channel

```
MIDI Part1 CH
01
```

The Display of other Part is the same.

The MIDI channel of each Part can be set from 1 to 16.

*If you change the MIDI channel of the Rhythm Part, the Rhythm channel in the Performance mode (See page 122) will be automatically changed.

● Keyboard Transmit Channel

Lower

```
MIDI Lower TxCH
02
```

Upper

```
MIDI Upper TxCH
01
```

The MIDI transmit channel of each keyboard section (upper or lower) can be set from 1 to 16.

● Transmit All Notes OFF

```
MIDI TxAll N-Off
ON
```

If you do not want to transmit All Notes OFF messages, set this to OFF.

*The Transmit All Notes OFF setting is retained even in the Performance mode.

*The Transmit All Notes OFF setting will return to ON when the unit is turned off.

● Unit Number

MIDI Exclu Unit# 17

A Unit Number is a number used to identify an external device instead of the MIDI channel number, when data is received or transmitted using Exclusive messages (only for Roland ID number). So, it is possible to send or receive Exclusive messages by matching the Unit numbers of two devices. OFF and 17 to 32 are valid, and at OFF, the Exclusive messages cannot be communicated. When using a programmer, be sure not to select OFF.

*Even when sending or receiving Exclusive messages on a MIDI channel, do not set this to OFF but any number from 17 to 32.

*The Unit Number you have set is retained even in the Performance mode.

*The Unit Number you have set will be automatically returned to 17 when the unit is turned off.

● Timbre Dump

MIDI Timbre DUMP OFF

The Timbre Dump function transmit the sound data of a certain Timbre using Exclusive messages. Using this function, sound data can be recorded in a sequencer together with performance data. In this way, the original Timbre will always be retrieved even after it is edited on the D-10. Depending on the Display, how the data is transmitted varies. That is, changing the Timber in the Keyboard Display will transmit data on the keyboard transmit channel, and doing the same thing in the Part Display will transmit the data with the Unit number.

*If you change the value of the Timbre Dump, the Patch Dump setting (see page 125) in the Performance mode also will be changed automatically.

*The Timbre Dump you have set will automatically return to OFF when the unit is turned off.

b. Tune/Function Setting

This involves Master Tuning, Reverb, output balance of each Part, etc. Before taking the following procedures, set the unit to the Multi Timbral mode (the Multi Timbral Indicator is lit).

*The changes you have made will be retained in memory even after the unit is turned off, except in a few cases.

[Editing Procedure]

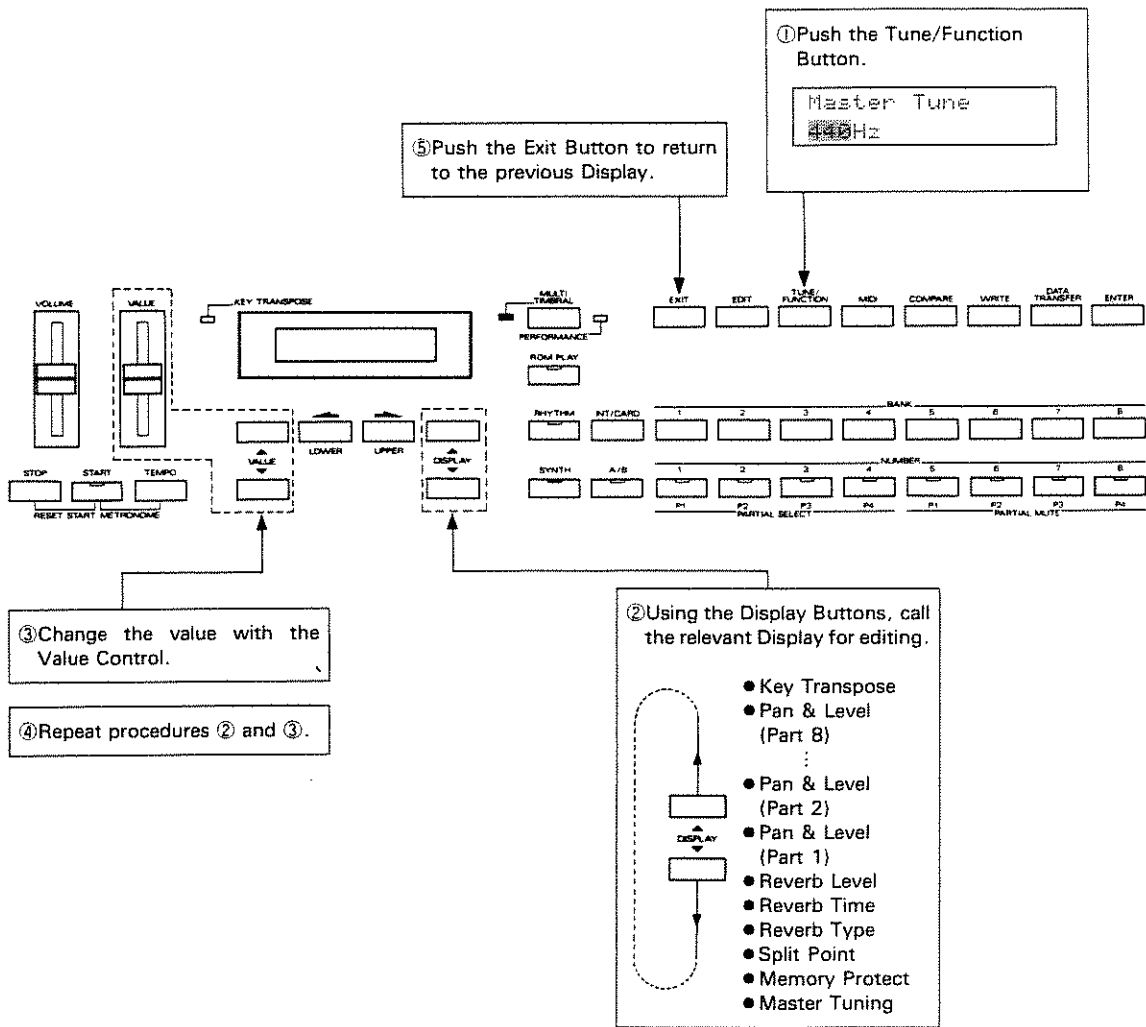

[Tune/Functions]

● Master Tuning

```
Master Tune
440Hz
```

The pitch of all the Parts can be set within the range of about 428 to 453Hz (frequency of the standart pitch "A4). The value in the Display changes in 1Hz steps, but it actually changes almost continuously.

*The Master Tune value you have set is retained even in the Performance mode.

*The pitch of a Tone that uses a PCM sound may not be changed by the Master Tuning function.

● Memory Protect

```
Memory Protect
ON
```

The Memory Protect function prevents data written in the internal memory of the unit from being erased accidentally. This should be set to OFF for writing or data transfer procedures that write data into the internal memory. Otherwise, set it to ON.

*The Memory Protect setting is retained even in the Performance mode.

*The Memory Protect setting will be automatically returned to ON when the unit is turned off.

● Split Point

```
Split Point
C4
```

This determines the key where the keyboard is divided into two sections, upper and lower. C2 to C#7 are valid.

*Middle C is C4.

● Reverb Type

```

Reverb Type
  1
    
```

This selects one of the 8 Reverb Types or OFF. At OFF, no reverb effect is obtained.

Number	Reverb Type
1	Small Room
2	Medium Room
3	Medium Room
4	Large Hall
5	Plate
6	Delay 1
7	Delay 2
8	Delay 3
OFF	No Reverb

*Reverb ON or OFF can be selected for each Timbre or each Key Number of Rhythm Tone. (See page 64 "Timbre" and page 25 "Rhythm Setup".)

● Reverb Time

```

Reverb Time
  01
    
```

This sets the reverberation time. 1 to 8 are valid, and higher values refer to longer reverb times. When a Delay is selected, higher values refer to longer delay time.

● Reverb Level

```

Reverb Level
  04
    
```

This sets the level of reverb sound. 0 to 7 are valid, and higher values increase the level.

● Pan and Level

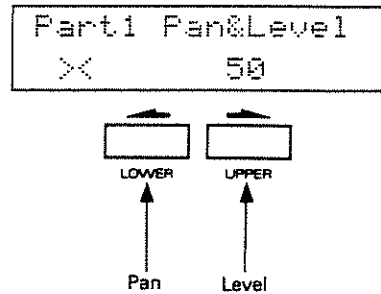

This sets the pan and level of Parts 1 to 8. Pan is positioning of the sound image output in stereo. Pan and Level adjust the output balance of each Part.

To set the Level, push the Cursor Button on the right (the value will flash). 0 to 100 are valid, higher values increase the volume.

To set the Pan, push the Cursor Button on the left (the value will flash). 7> to <7 are valid. At "><", center positioning is obtained. <7 is right and 7> is left placement.

*For adjusting the overall volume of the Rhythm, see page 22 "Track Play" in Basic Course. In the Rhythm section, the Pan and Level can be set individually for each Rhythm Tone. (See page 25 "Rhythm Setup".)

*Changing the Pan value may not affect the sound quite the way you expect in some Tones because of the Structure setting.

*When using a Tone made using only one Partial, there are only 8 possible panning positions.

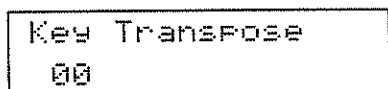
● Key Transpose

Key Transpose
00

This function transposes the entire keyboard in semi-tone steps, allowing you to play the same keyboard in different keys. -12 to +12 (semi-tone steps, ± 1 octave) are valid. If the value is set to other than zero, the indicator of the Key Transpose will light up.

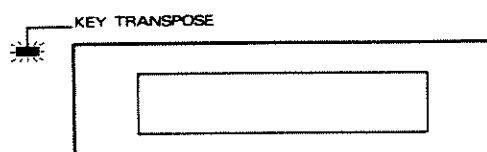

***The Key Transpose value you have set is retained even in the Performance mode.**

***The Key Transpose function does not work in Rhythm Setup or Making Rhythm Patterns.**

2 EDIT

1. Rhythm

The following will explain how to set the values of a Rhythm Tone, program rhythm patterns and record into a rhythm track.

a. Rhythm Setup

Rhythm Tones are assigned to the Key Numbers C1 to C8. When Key messages are received by the Rhythm Part, the Rhythm Tone assigned to that Key Number is played, resulting in rhythm performance.

Each Key Number can have an independent Pan and Level, allowing rhythm performance in a desired balance. As well as the Preset Rhythm Tones (63 kinds), original Tones you have programmed can be used as Rhythm Tones.

1) Editing Procedure

*The Editing procedure does not automatically rewrite old data. Therefore, the edited data will be erased if the unit is turned off. If you wish to retain the edited version even after the unit is turned off, take the appropriate writing procedure for each Key Number.

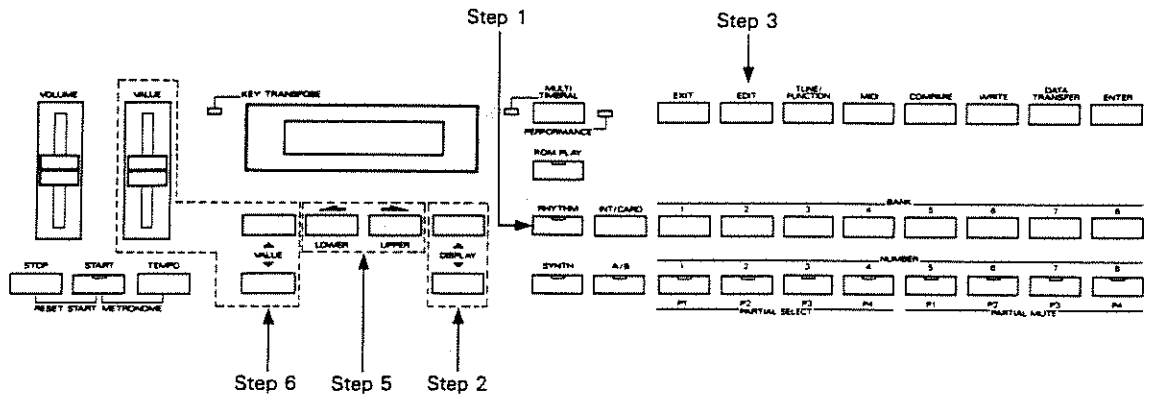

Step 1 Push the Rhythm Button (the indicator lights up).

Step 2 Using the Display Buttons, change to the Manual Drum Display.

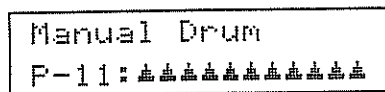

Step 3 Push the Edit Button.

Now, the keyboard is ready for manual rhythm performance.

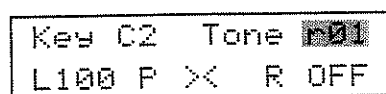

Step 4 Push the key to be edited.

If you wish to select a key that exceeds the maximum range of the keyboard, transpose the pitch of the keyboard using the Display Buttons before assigning the key. When the keyboard is transposed, the Key Transpose Indicator lights up.

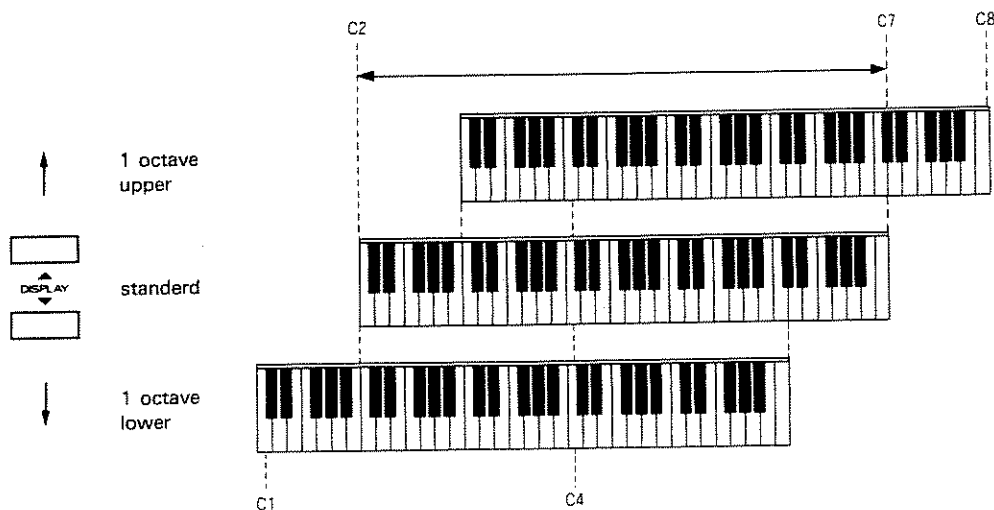

Step 5 Using the Cursor Buttons, call the parameter to be edited.

The value of the selected parameter flashes.

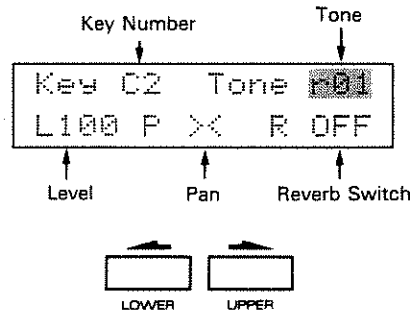

Step 6 Change the value using the Value Control Knob.

Tone : A Rhythm Tone (from the Preset Rhythm Tones r1 to r63, and Internal Tones i1 to i64) can be selected. At OFF, no Rhythm Tone is assigned.

Level : 1 to 100 are valid, higher values increase the volume.

Pan : The positioning of the sound image in the stereo output can be set from 7> to <7. At ><, the position is in the center, <7 the far right, >7 far left.

Reverb Switch : Turn this ON to obtain the reverb effect.

*The rhythm patterns are programmed using the Rhythm Tones which have been assigned to specific Key Numbers, and therefore may be changed after the assignment is edited.

*When a Rhythm Tone from the internal memory is used, the pitch may be changed depending on the key assigned to the Tone.

*Changing the Pan value may not affect the sound as expected in some Tones because of the Structure setting.

*When using a Tone made by using only one Partial, only 8 panning positions are available.

*When an Internal Tone (i1 to 64) is used as a Rhythm Tone, the ENV mode (see page 90) of the Tone parameter is automatically set to NO SUSTAIN (therefore it may sound different). But, when playing by MIDI information of the external devices, the ENV mode is set to NORMAL.

- Step 7 To write the edited parameter, take the appropriate writing procedure (as explained in the following chart).

- Step 8 Push the Exit Button to retrieve the Manual Drum Display.

[Preset Rhythm Tones]

No.	Tone Name	Number of Partial
r01	Closed High Hat-1	1
r02	Closed High Hat-2	1
r03	Open High Hat-1	2
r04	Open High Hat-2	2
r05	Crash Cymbal	2
r06	Crash Cymbal (short)	1
r07	Crash Cymbal (mute)	1
r08	Ride Cymbal	2
r09	Ride Cymbal (short)	1
r10	Ride Cymbal (mute)	1
r11	Cup	2
r12	Cup (mute)	1
r13	China Cymbal	2
r14	Splash Cymbal	1
r15	Bass Drum-1	2
r16	Bass Drum-2	1
r17	Bass Drum-3	2
r18	Bass Drum-4	1
r19	Snare Drum-1	1
r20	Snare Drum-2	1
r21	Snare Drum-3	1
r22	Snare Drum-4	2
r23	Snare Drum-5	1
r24	Snare Drum-6	1
r25	Rim Shot	1
r26	Brush-1	2
r27	Brush-2	2
r28	High Tom Tom-1	1
r29	Middle Tom Tom-1	1
r30	Low Tom Tom-1	1
r31	High Tom Tom-2	1
r32	Middle Tom Tom-2	1
r33	Low Tom Tom-2	1
r34	High Tom Tom-3	2
r35	Middle Tom Tom-3	2
r36	Low Tom Tom-3	2
r37	High Pitch Tom Tom-1	1
r38	High Pitch Tom Tom-2	1
r39	Hand Clap	1
r40	Tambourine	1
r41	Cowbell	1
r42	High Bongo	1
r43	Low Bongo	1
r44	High Conga (mute)	1
r45	High Conga	1
r46	Low Conga	1
r47	High Timbale	1
r48	Low Timbale	1
r49	High Agogo	1
r50	Low Agogo	1
r51	Cabasa	1
r52	Maracas	1
r53	Short Whistle	2
r54	Long Whistle	2
r55	Quijada	3
r56	Claves	1
r57	Castanets	2
r58	Triangle	2
r59	Wood Block	1
r60	Bell	2
r61	Native Drum-1	1
r62	Native Drum-2	1
r63	Native Drum-3	1
OFF		0

[Preprogrammed Rhythm Setup]

r63	Native Drum-3	C7
r62	Native Drum-2	
r61	Native Drum-1	
r09	Ride Cymbal (short)	
r34	High Tom Tom-3	
r06	Crash Cymbal (short)	
r35	Middle Tom Tom-3	
r02	Closed High Hat-2	
r36	Low Tom Tom-3	
r24	Snare Drum-6	
r23	Snare Drum-5	
r22	Snare Drum-4	
r18	Bass Drum-4	C6
r17	Bass Drum-3	
r60	Bell	
r59	Wood Block	
r37	High Pitch Tom Tom-1	
r58	Triangle	
r38	High Pitch Tom Tom-2	
r57	Castanets	
r27	Brush-2	
r26	Brush-1	
r56	Claves	
r12	Cup (mute)	
r55	Quijada	C5
r54	Long Whistle	
r53	Short Whistle	
r52	Maracas	
r51	Cabasa	
r50	Low Agogo	
r49	High Agogo	
r48	Low Timbale	
r47	High Timbale	
r46	Low Conga	
r45	High Conga	
r44	High Conga (mute)	
r43	Low Bongo	C4 (Middle C)
r42	High Bongo	
r10	Ride Cymbal (mute)	
r21	Snare Drum-3	
r07	Crash Cymbal (mute)	
r41	Cowbell	
r14	Splash Cymbal	
r40	Tambourine	
r11	Cup	
r13	China Cymbal	
r08	Ride Cymbal	
r31	High Tom Tom-2	
r05	Crash Cymbal	C3
r28	High Tom Tom-1	
r32	Middle Tom Tom-2	
r03	Open High Hat-1	
r29	Middle Tom Tom-1	
r04	Open High Hat-2	
r33	Low Tom Tom-2	
r01	Closed High Hat-1	
r30	Low Tom Tom-2	
r20	Snare Drum-2	
r39	Hand Clap	
r19	Snare Drum-1	
r25	Rim Shot	C2
r16	Bass Drum-2	
r15	Bass Drum-1	

2) Writing Procedure

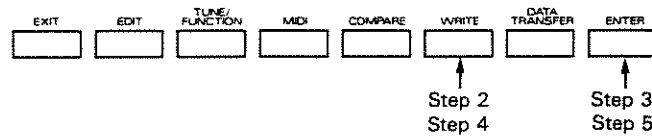

Step 1 Push the key to be edited.

Step 2 Push the Write Button.

```
Write C4  Setup
Sure?      Enter
```

Step 3 Push the Enter Button.

```
Turn Protect off
once? Write/Exit
```

Step 4 Push the Write Button.

The Memory Protect function is cancelled temporarily and the Display is returned as in Step 2.

Step 5 Push the Enter Button.

If the writing procedure is completed, the Display responds as shown below, then returns to the Edit Display.

```
Complete
```

b. Making Rhythm Patterns

Preprogrammed Rhythm Patterns P-51 to 88 can be edited to make your original rhythm patterns. Before going to the rhythm track recording procedure, make your own rhythm patterns, if necessary.

There are two methods for making rhythm patterns: by using the keyboard of the D-10 (Editing Procedure I), and by using performance data sent from an external device such as a rhythm machine (Editing Procedure II).

1) Editing Procedure [I]

Rhythm patterns can be made by playing the keyboard of the D-10.

*The rhythm pattern you have made will be erased when a different rhythm pattern is selected or the unit is turned off. To retain the edited data, take the appropriate writing procedure as shown on page 41 "Writing Procedure".

*If you do not want the metronome beep while programming a rhythm pattern, set the Metronome Mode to OFF. (See page 31 in Basic Course.)

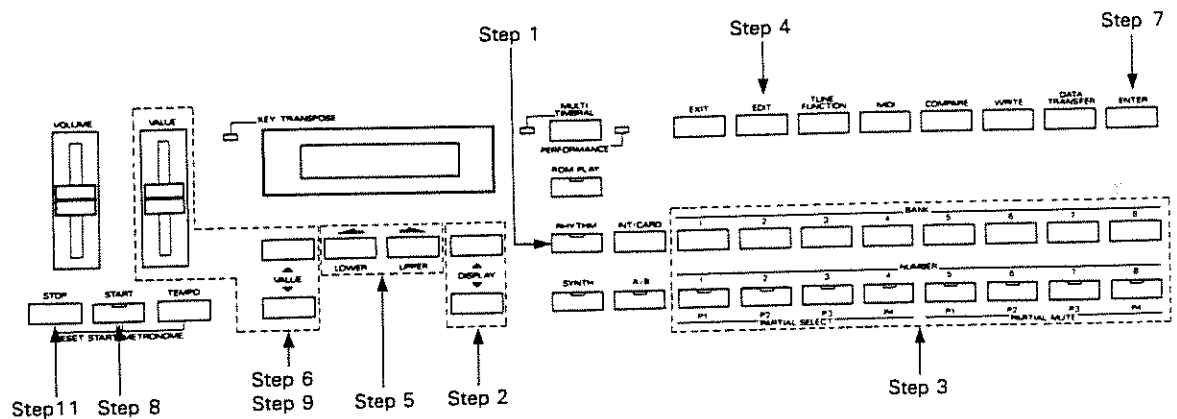

Step 1 Push the Rhythm Button. (The indicator lights up.)

Step 2 Call the Pattern Play Display using the Display Buttons.

```

Pattern Play
P-56:UserPattern
    
```

Step 3 **Select a rhythm pattern number using the Bank and Number Buttons.**

If you wish to make a rhythm pattern from scratch, select a rhythm pattern from 51 to 88. (Note that the selected rhythm pattern will be replaced with new data.)

If you wish to make a rhythm pattern by editing an existing one, select a source pattern.

*To hear the rhythm pattern you have selected, simply press the Start Button. (Before going to the next procedure, be sure to stop the rhythm by pushing the Stop Button.)

Step 4 **Push the Edit Button.**

```

Edit P-56 Clear?
Yes      No
  
```

Step 5 **If you wish to clear the entire rhythm pattern data, push the Cursor Button on the left. If not, push the Cursor Button on the right.**

```

Edit P-56 Clear?
Yes      No
  
```

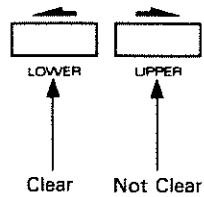

If you pushed the right Cursor Button, go to Step 8.

Step 6 **Using the Value Control Knob, set the time signature of the rhythm pattern (from 1/4 to 8/4).**

```

Edit P-56
Time 4/4 Enter
  
```

Step 7 Push the Enter Button.

```
Edit P-56 4/4
Qua OFF EraseOFF
```

Step 8 Push the Start Button.

Rhythm Tones are assigned to the keyboard as set in the SETUP.

*Rhythm Tone assignment by the manufacturer is shown on page 29 "Rhythm Setup".

Step 9 Adjust the tempo with the Value Control Knob.

Step 10 Make a rhythm pattern by playing the keyboard. By changing how hard you play the keyboard, velocity can be added.

If you wish to select a key that exceeds the maximum range of the keyboard, transpose the pitch of the keyboard using the Display Buttons before assigning the key. When the keyboard is transposed, the Key Transpose Indicator lights up.

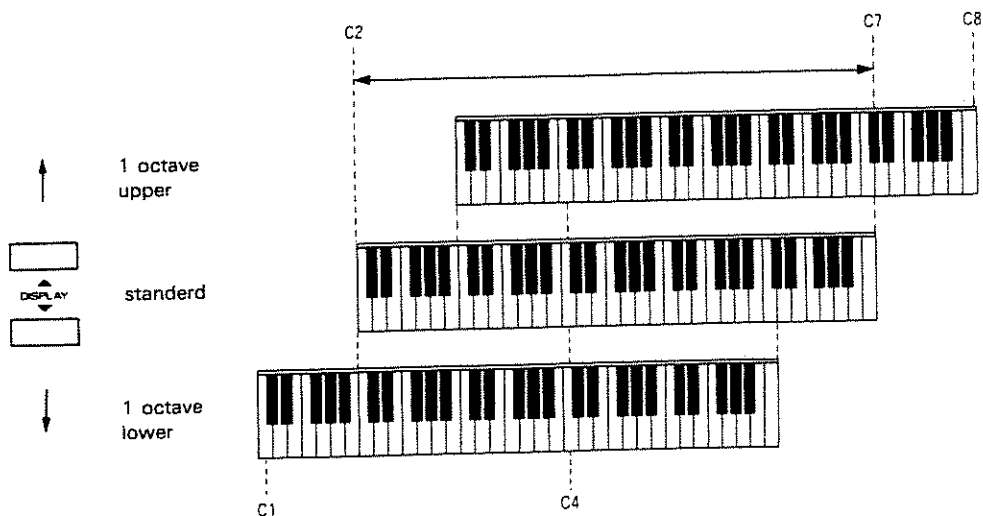

*If you wish to play the keyboard in the exact timing as a score, take the Quantize procedure.

*If you wish to correct the rhythm pattern you have made, erase it.

*The maximum number of voices played simultaneously is 8, so the 9th note will be ignored.

*When an Internal Tone (i1 to 64) is used as a Rhythm Tone and played by the rhythm pattern, the ENV mode (see page 90) of the Tone parameter is automatically set to NO SUSTAIN (therefore it may sound different).

Step 11

To write the rhythm pattern you have made, first, stop the rhythm by pressing the Stop Button, then take the appropriate writing procedure (page 41).

*If you do not want to write the rhythm pattern you have made, push the Exit Button.

[Quantize]

The Quantize function corrects the timing of the rhythm pattern so that it will become as accurate as a score. This is achieved by setting the number of steps which can be entered in a rhythm pattern. Quantizing can be done during the rhythm pattern editing mode, therefore it is possible to set a different value (the shortest note) for each Rhythm Tone.

Quantizing can be set in the Step 7s' Display even while a rhythm is running.

Step 1 Push the **Cursor Button** on the left.

The Quantize value flashes in the Display.

```

Edit P-56  4/4
Qua OFF EraseOFF

```

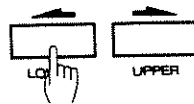

Step 2 Using the **Value Control Knob** select the timing value you like.

OFF : No correction

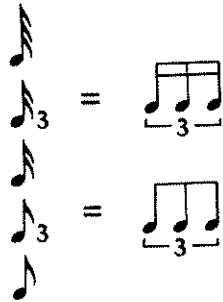

Depending on the time signature, the number of steps will vary.

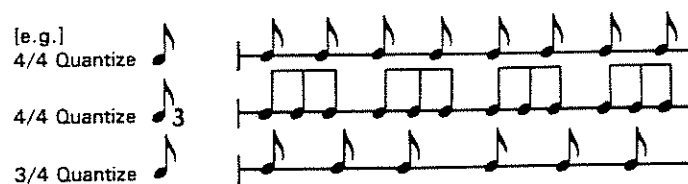

*To change the tempo during the quantizing procedure, move the Value Control Knob while holding the Tempo Button down.

Step 3 Tap the key on the keyboard.

The rhythm will be played with the timing automatically corrected.

Step 4 To enter a different value for quantization, repeat Steps 2 and 3.

Step 5 To return to the previous mode which allows you to change the tempo with the Value Control Knob, push the Cursor on the left. (The flashing will stop.)

[Erase]

The Erase function is useful for correcting any mistake you have made in a rhythm pattern. The Rhythm Tone used for the rhythm pattern is erased, and therefore new data can be entered. The Erase function can be set in the Step 7's Display even while a rhythm is being played.

Step 1 Push the Cursor Button on the right.

The Erase value flashes in the Display.

```

Edit P-56      4/4
Qua OFF Erase OFF

```

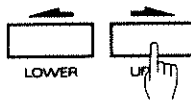

Step 2 Select "ON" with the Value Control Knob.

Step 3 Press the key where the Rhythm Tone to be erased is assigned.

Holding the key down will continue to erase the relevant Rhythm Tone.

Step 4 Return to "Erase OFF" with the Value Control Knob.

Step 5 Play the keyboard to correct the mistake.

Step 6 Push the Cursor Button on the right, and "Erase" will stop flashing, and the Display will return to the previous condition which allows you to change the tempo with the Value Control Knob.

2) Editing Procedure [II]

This is making a rhythm pattern using the performance data of a MIDI device such as a rhythm machine.

*The rhythm pattern you have made will be erased when a different rhythm pattern is selected or the unit is turned off. To retain the edited data, take the appropriate writing procedure as shown on page 41 "Writing Procedure".

【Preparation】

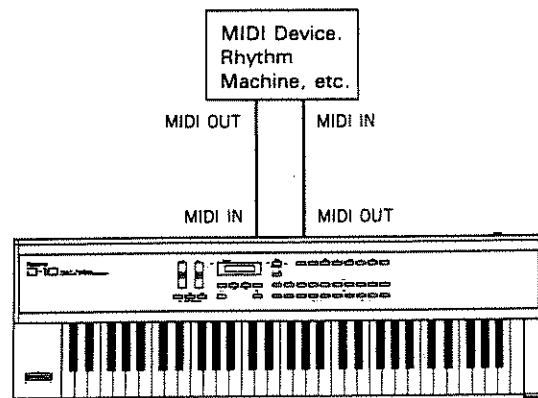

① Set the MIDI channels of the D-10's Rhythm section and the external device to the same number.

*In the Performance mode, see page 121 "MIDI Function Setting", and in the Multi Timbral mode, see page 17 "MIDI Function Setting".

② Match the Key Number—Rhythm Tone assignment of the external device to the D-10's Rhythm section.

*The Key Number—Rhythm Tone assignment of the D-10's Rhythm section is shown on page 29 "Rhythm Setup".

③ Set the Sync mode of the external device so that it can receive the sync signal from the D-10.

[Procedure]

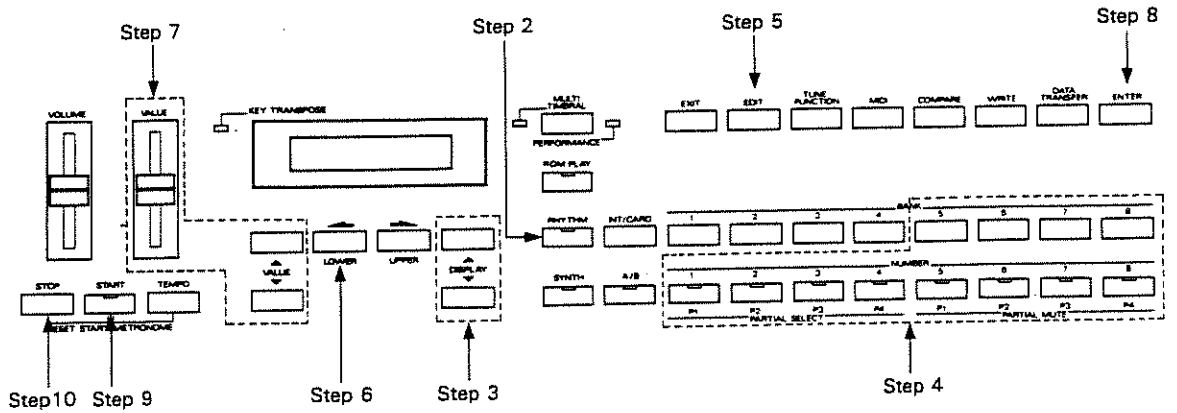

- Step 1 Set the external device to the rhythm pattern play mode.
- Step 2 Push the Rhythm Button on the D-10 (The indicator lights up).
- Step 3 Select the Pattern Play Display using the Display Buttons.

```

Pattern Play
P-56:UserPattern
    
```

- Step 4 Using the Bank and Number Buttons, select a rhythm pattern (destination pattern number), from P-51 to P-88, which is to be replaced with the new data.
- Step 5 Push the Edit Button.

```

Edit P-56 Clear?
Yes      No
    
```

- Step 6 Push the Cursor Button on the left to clear the entire data of the selected rhythm pattern.
- Step 7 Using the Value Control Knob, set the time value (1/4 to 8/4) of the rhythm pattern.

```

Edit P-56
Time 4/4 Enter
    
```

Step 8 Push the Enter Button.

Edit P-56	4/4
Qwa OFF	EraseOFF

Step 9 Push the Start Button.

*The maximum number of notes which can be entered simultaneously is 8, so the 9th note will be ignored.

*The maximum number of notes which can be entered into a rhythm pattern is 96.

Step 10 Push the Stop Button to stop the rhythm, then take the appropriate writing procedure shown in the following section.

*If you do not wish to write the rhythm pattern you have made, push the Exit Button.

3) Writing Procedure

The rhythm pattern you have made can be written into the internal memory (to a destination pattern number, P-51-P-88), or onto a memory card (optional M-256D, M-256E).

[Writing into the internal memory]

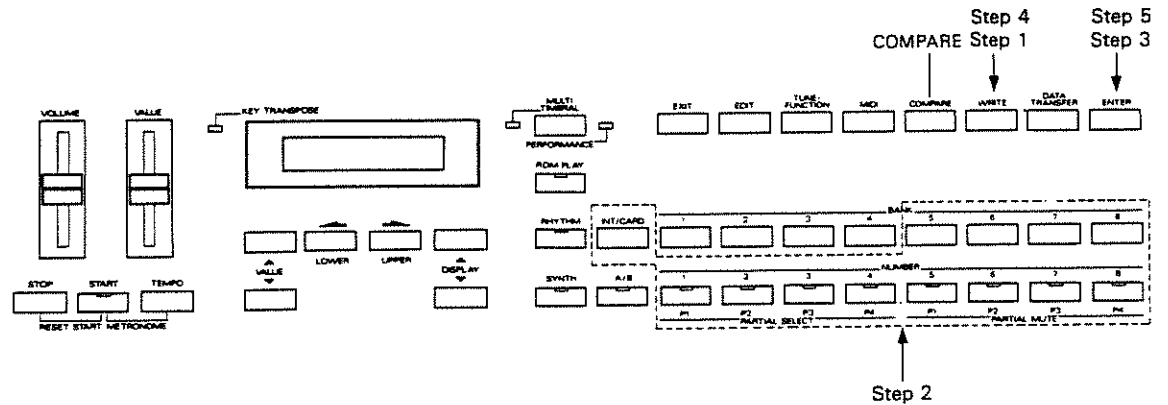

Step 1 Push the Write Button.

"I" is shown when the internal memory is selected, and "C" is shown when Memory card is Selected.

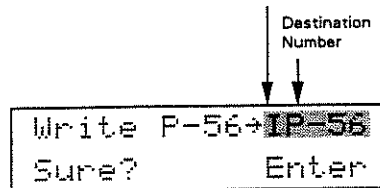

*If the source rhythm pattern which you have edited was a Preset Rhythm Pattern, P-11-P-48, a destination pattern number does not appear in the Display.

Step 2 If you wish to change the destination pattern number, use the Bank (5-8) and Number Buttons.

Before rewriting the destination rhythm pattern with your edited version, you may wish to listen to the destination rhythm pattern. If so, do as follows.

① Push the Compare Button.

```
Compare to IP-56
```

② Using the Bank (5–8) and Number Buttons, assign the destination rhythm pattern.

③ Push the Start Button to play the rhythm.

④ Push the stop Button to stop the rhythm.

⑤ Push the Compare Button to return to the previous Display.

Step 3 Push the Enter Button.

```
Turn Protect off
once? Write/Exit
```

Step 4 Push the Write Button.

The Memory Protect function is cancelled temporarily, and the Step 2 Display is called.

Step 5 Push the Enter Button.

When the writing is completed, the Display shows as below for a while and then returns to the Pattern Play Display.

```
Complete
```

*If the writing procedure is not properly completed, an error message will appear instead. See page 150 "Error Messages" to resolve this.

[Writing onto a memory card]

*When using a brand new memory card, take the "Saving" procedure (see page 127) to copy the entire data onto the memory card, before writing the rhythm pattern.

*Rhythm pattern data written on a memory card cannot be used unless copied into the internal memory, and therefore will be preserved quite safely.

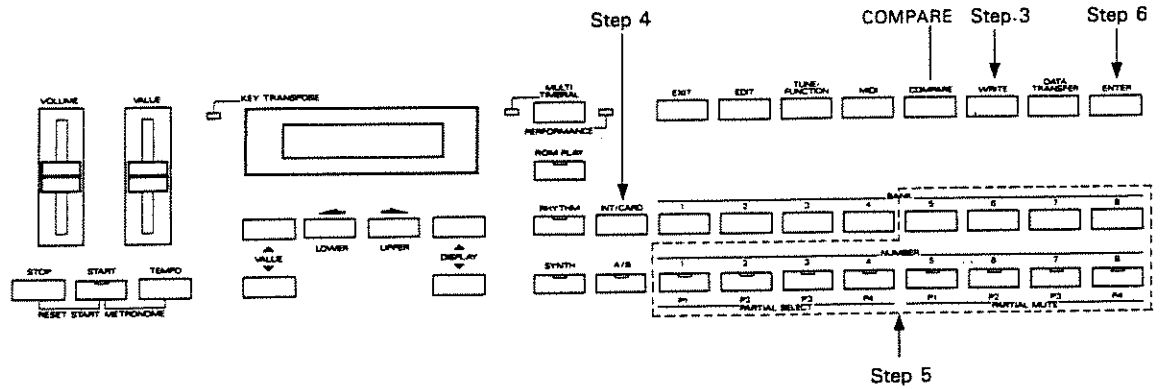

- Step 1 Insert a memory card into the Card Slot.
- Step 2 Set the Protect Switch on the memory card to the OFF position.
- Step 3 Push the Write Button.

"I" is shown when the Internal memory is selected, and "C" is shown when Memory card is Selected.

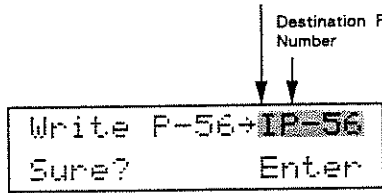

*If the source rhythm pattern which you have edited was a Preset Rhythm Pattern, P-11-P-48, a destination pattern number does not appear in the Display.

- Step 4 Select "C" by pushing the Internal/Card Button.

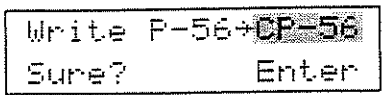

Step 5 If you wish to change the destination pattern number, use the **Bank (5-8)** and **Number Buttons**.

Before rewriting the destination rhythm pattern with your edited version, you may wish to listen to the destination rhythm pattern. If so, do as follows.

① Push the **Compare Button**.

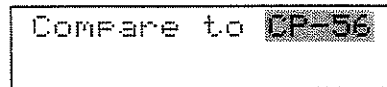

Compare to CP-56

② Using the **Bank (5-8)** and **Number Buttons**, call the destination rhythm pattern.

③ Push the **Start Button** to play the rhythm.

④ Push the **Stop Button** to stop the rhythm.

⑤ Push the **Compare Button** to return to the previous Display.

Step 6 Push the **Enter Button**.

When completed, the Display shows as below for a while and then returns to the Pattern Play Display.

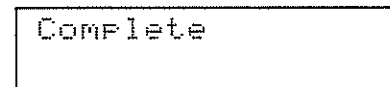

Complete

*If the writing procedure is not properly completed, an error message will appear instead. See page 150 "Error Messages" to resolve this.

Step 7 Return the **Protect Switch** on the memory card to the **ON** position.

c. Rhythm Track Recording

The D-10's Rhythm unit allows you to program a rhythm track or tune (up to 500 bars) from the 64 rhythm patterns. We call this "rhythm track recording".

1) Recording

*The performance data recorded in a rhythm track is retained even after the unit is turned off.

*If you do not want the metronome while recording, set the Metronome mode to OFF. (See page 31 in Basic Course.)

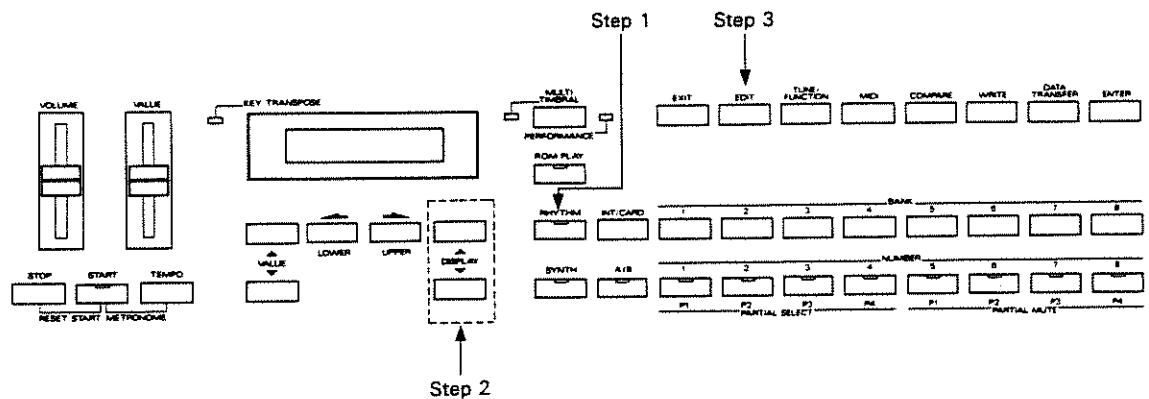

Step 1 Push the Rhythm Button. (The indicator lights up.)

Step 2 Using the Display Buttons, call the Track Play Display.

```
Track Play once
Meas010 P-11
```

Step 3 Push the Edit Button.

The unit is now switched to the rhythm track recording mode.

```
Track Rec
Meas010 P-11
```

In the rhythm track recording mode, the Value Buttons assign a bar number. (The Value Control Knob cannot set a bar number.) To adjust the tempo while in the recording mode, use the Value Buttons while holding the Tempo Button.

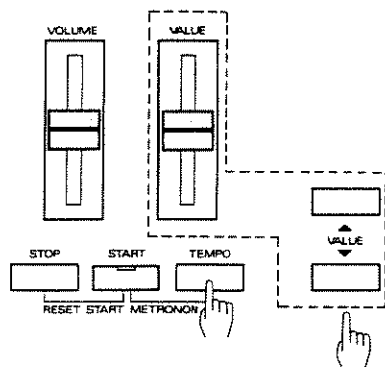

There are two methods for rhythm track recording ; one is playing rhythm patterns in sequence (Recording 1), and the other is assigning a rhythm pattern to each bar (Recording 2).

***Recording rhythm data in a rhythm track will automatically rewrite any previous data. However, if you wish to erase the entire existing data, or a bar of data, use the "Erase" procedure explained on page 51.**

[Recording 1]

This method programs a rhythm track by playing rhythm patterns in sequence, and therefore, is quicker than Recording 2.

<Recording from the first bar>

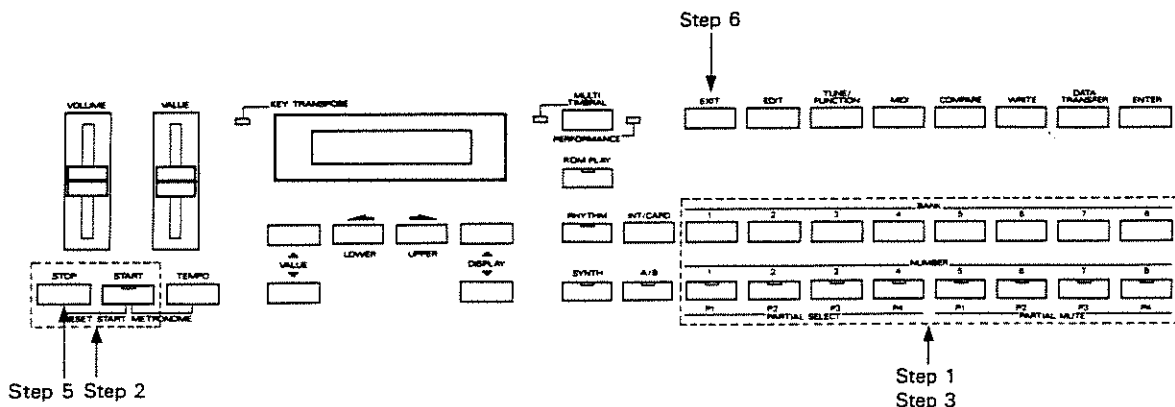

Step 1 Select a rhythm pattern for the first bar using the Bank and Number Buttons. (If you want the pattern number shown in the Display for the first bar, skip this step.)

When a rhythm pattern is selected, the number flashes.

*The bar number shown in the Display is irrelevant.

Step 2 While holding the Stop Button down, press the Start Button.

The Display shows bar number 001.

Step 3 While the rhythm pattern of the first bar is being played, assign a rhythm pattern for the second bar.

*If you want the same rhythm pattern for the second bar, skip Step 3.

Step 4 Repeat Step 3 for the following bars.

Step 5 When you finish the rhythm track recording, push the Stop Button.

Step 6 Push the Exit Button to return to the Track Play Display.

At this stage, you can check if you have recorded a rhythm track correctly. If you wish to correct it, repeat the above procedure.

<Recording from a middle bar>

It is possible to start recording from any bar you like.

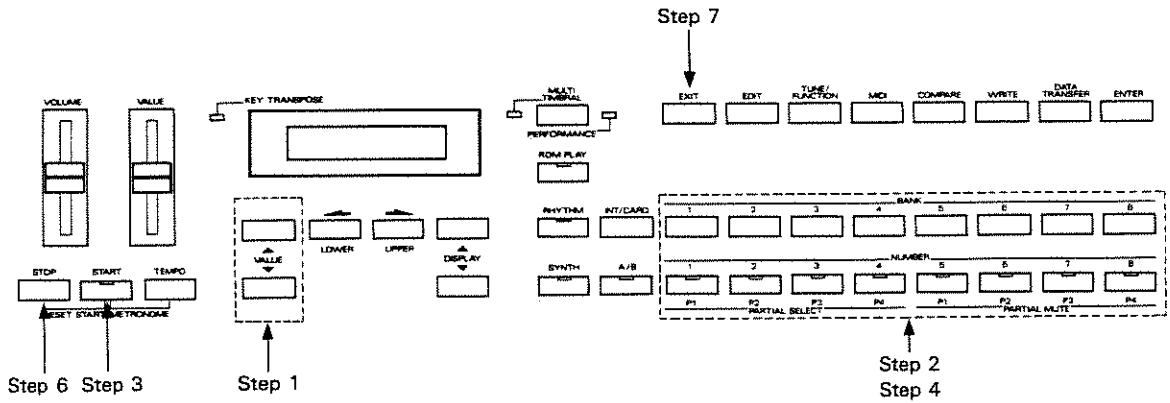

Step 1 Select the bar where you wish to start recording with the Value Buttons.

Step 2 Select a rhythm pattern to be assigned to the bar using the Bank and Number Buttons. (If you want to assign the pattern number shown in the Display, skip this step.)

When the rhythm pattern is selected, the number flashes.

Step 3 Press the Start Button.

The rhythm pattern you have selected will be played.

Step 4 To select a different rhythm pattern for the next bar, assign it while the rhythm is still playing, using the Bank and Number Buttons.

*If you want the same rhythm pattern for the next bar, skip Step 4.

Step 5 Repeat Step 4 for the following bars.

Step 6 **When you finish the rhythm track recording, push the Stop Button.**

Step 7 **Push the Exit Button to return to the Track Play Display.**

At this stage, you can check if you have recorded a rhythm track correctly. If you wish to correct it, repeat the above procedure.

[Recording 2]

This method is achieved by assigning a rhythm pattern to each bar in sequence.

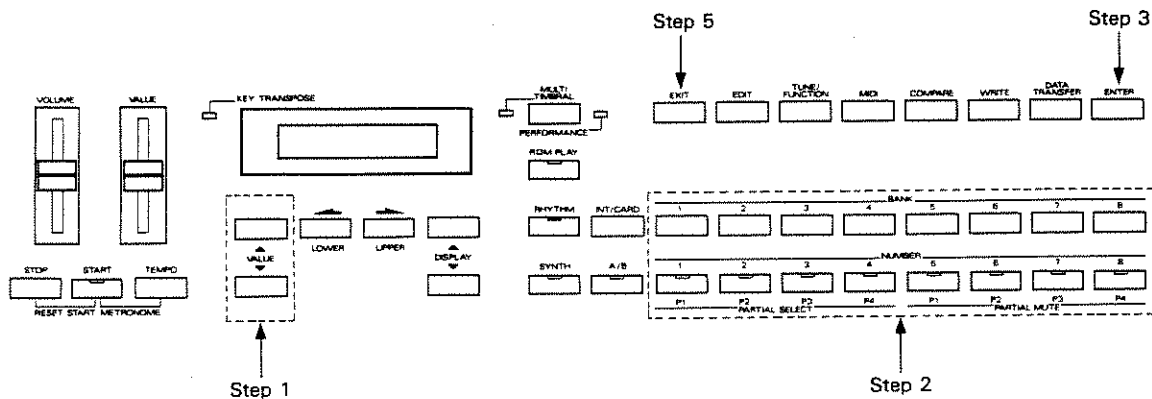

Step 1 Select the bar where you wish to start recording with the Value Buttons.

Step 2 Select a rhythm pattern to be assigned to the bar using the Bank and Number Buttons.(If you want to assign the pattern number shown in the Display, skip this step.)

When the rhythm pattern is selected, the number flashes.

Step 3 Push the Enter Button.

The designated rhythm pattern is recorded into the bar.
The bar changes to next.

Step 4 Repeat Steps 2 and 3 as many times as necessary for the following bars.

Step 5 When you finish the rhythm track recording, Push the Exit Button to return to the Track Play Display.

At this stage, you can check if you have recorded a rhythm track correctly. If you wish to correct it, repeat the above procedure.

2) Erase

The Erase function allows you to erase rhythm track data from any bar you assign to the end. If you wish to use this function, do as follows in the Recording mode.

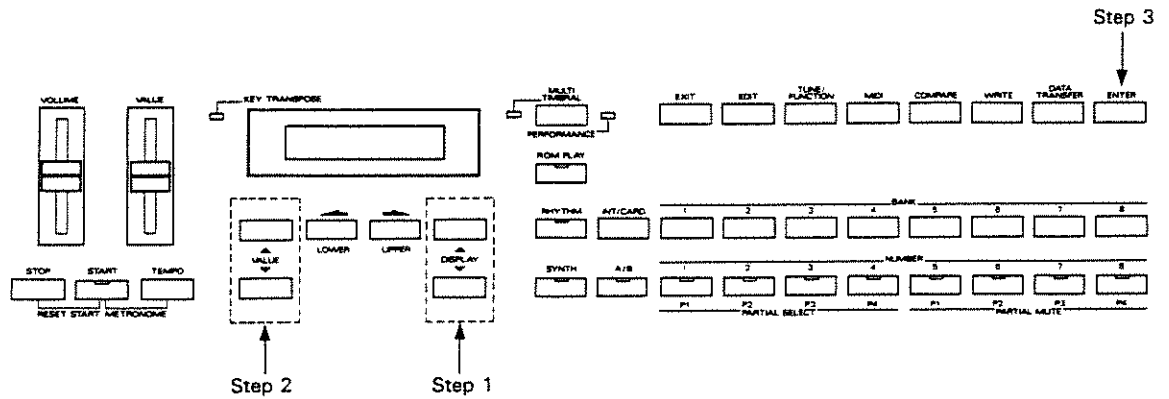

Step 1 Push either of the Display Buttons.

```

TrackErase Sure?
Meas001 Enter
    
```

Step 2 Select the bar from which you wish to erase with the Value Buttons.

Step 3 Push the Enter Button.

When the data is erased, the Display responds as below for a while, then returns to the previous Display (=before the above procedure is performed).

```

Complete
    
```

2. Patch and Timbre

A Patch (in the Performance mode) and Timbre (in the Multi Timbral mode) consists of various parameters. How the Tones are played will be changed by editing parameter values.

a. Patch

1) Editing Procedure

Turn to the Performance Play mode (the Performance and Synth Indicators light up), then take the following procedure.

*Your edited version does not automatically rewrite existing data, and therefore will be erased when a different Patch is selected or the unit is turned off. To retain the edited data, take the appropriate writing procedure (see page 67).

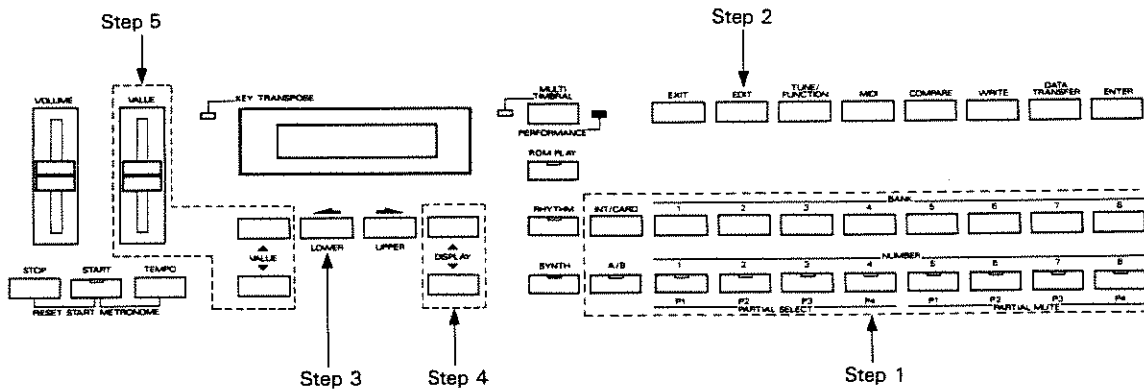

Step 1 Call the Patch to be edited.

Step 2 Push the Edit Button.

```

Edit Select
Patch Tone
    
```

Step 3 Push the Cursor Button on the left.

```

Key Mode
SPLIT
    
```

Step 4 **Select the parameter to be edited using the Display Buttons.**

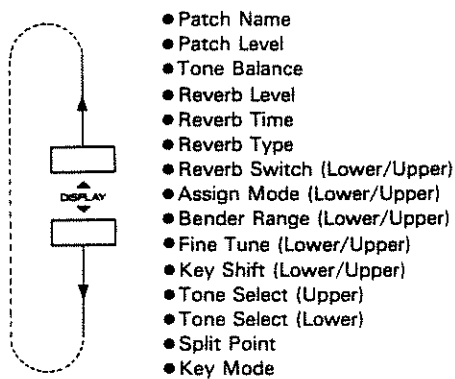

*If more than two values are shown in the Display, select one of those using the Cursor Buttons. The selected value will flash showing it is ready to be edited.

Step 5 **Change the value with the Value Control Knob.**

Step 6 **Repeat Steps 4 and 5 as many times as necessary.**

Step 7 **To write the value you have set, go to the writing procedure (page 67).**

*To leave the Patch editing mode, push the Exit Button.

2) Patch Parameters

A Patch is made of the following parameters.

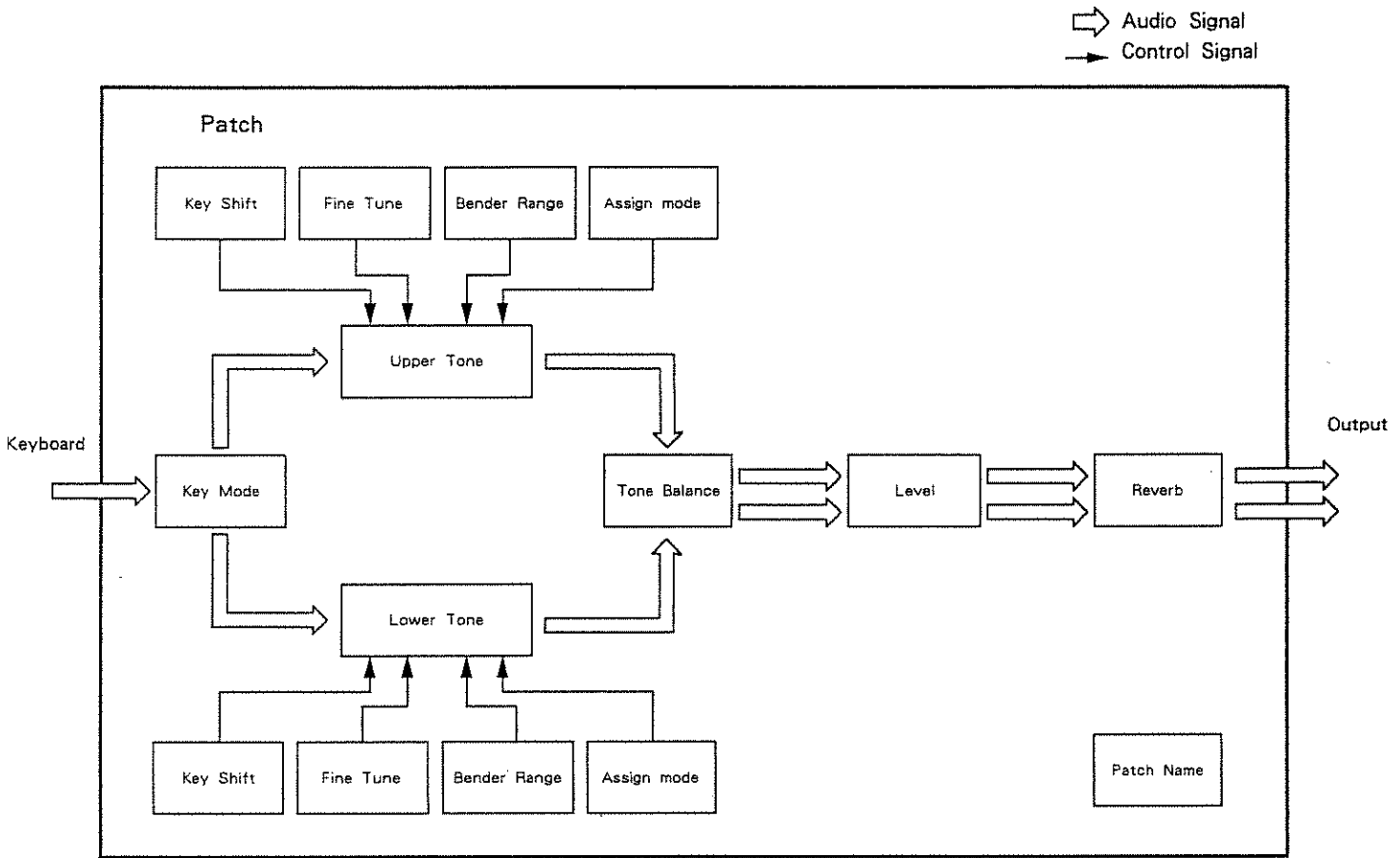

● Key Mode

Key Mode SPLIT

Key Mode refers to how the Upper and Lower Tones are played on the keyboard.

WHOLE : Only the Upper Tone is played. Use this mode for playing a piano type sound which requires many voices (notes).

DUAL : Both the Upper and Lower Tones are played simultaneously. This is ideal for strings or organ type sounds.

SPLIT : The Split mode divides the keyboard into the upper and lower sections, where two different Tones can be played simultaneously.

● Split Point

Split Point C4

In the Split Key mode, the key where the keyboard is divided into two sections, upper and lower sections, is called the Split Point. The Split Point can be set in the range of C2 to C#7 in semi-tone steps.

● Tone Select

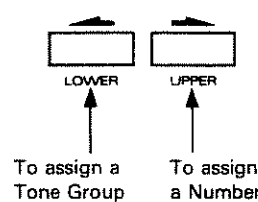
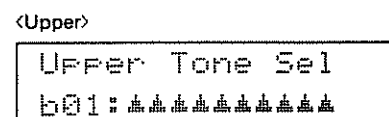
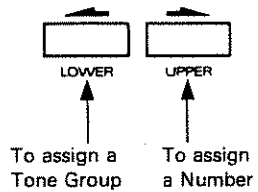
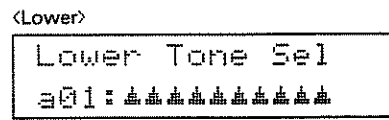

This selects the Tones which are to be assigned to the upper and lower sections of the keyboard. Depending on which memory, internal memory or memory card the Patch belongs to, the available Tones will differ.

Tone Group	Internal		Memory Card	
	a, b, i	r	a, b, c	r
Number	1-64	1-63, OFF	1-64	1-63, OFF

- a : Preset Tone (Internal)
- b : Preset Tone (Internal)
- r : Preset Rhythm Tone (Internal)
- i : Programmable Tone (Internal)
- c : Tone a memory card

● Key Shift

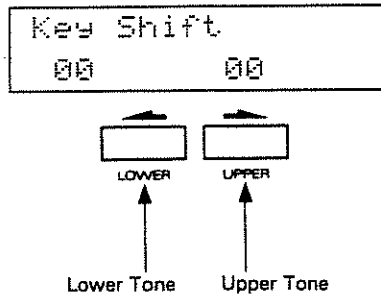

The Key shifting for the Upper and Lower Tones can be separately set from -24 to +24 (2 octaves) in semi-tone steps.

● Fine Tune

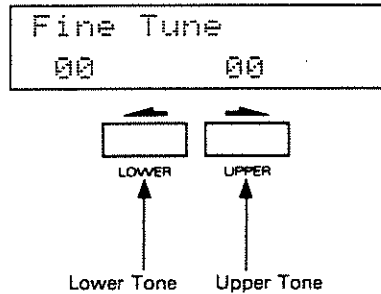

The pitch of each Tone can be finely changed from -50 to +50 (about ±50 cents).

● Bender Range

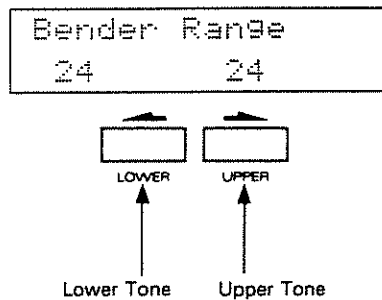

This sets the variable range of the pitch change caused by moving the Bender Lever right and left from 0 to 24 (2 octaves) in semi-tone steps.

● Assign Mode

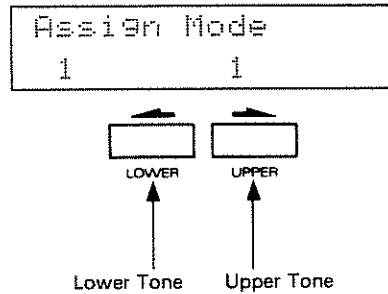

Assign mode refers to how each Tone should be played by Key messages received.

- 1 : Single Assign --- Played with Last Note Priority
- 2 : Single Assign --- Played with First Note Priority
- 3 : Multi Assign --- Played with Last Note Priority
- 4 : Multi Assign --- Played with First Note Priority

SINGLE ASSIGN

In this mode, when more than one Key ON message is received by the same Key Number, the sound of that key is muted once, then played again.

MULTI ASSIGN

In this mode, when more than one Key ON message is received by the same Key Number, two sounds are mixed.

LAST NOTE PRIORITY

In this mode, when the D-10 has received more than 32 Key On messages, the previously received ones are replaced by the later received ones.

FIRST NOTE PRIORITY

In this mode, when the D-10 has received more than 32 Key On messages, the later received ones are ignored, retaining the currently playing sounds.

● Reverb Swich

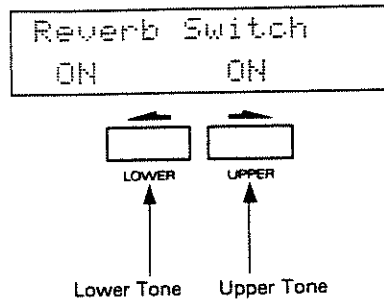

This selects whether to use the Reverb effect or not individually for each Tone. ON turns the effect on.

● Reverb Type

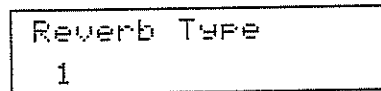

One of the 8 Reverb Types can be selected. At OFF, no reverb effect is obtained.

Number	Reverb Type
1	Small Room
2	Medium Room
3	Medium Room
4	Large Hall
5	Plate
6	Delay 1
7	Delay 2
8	Delay 3
OFF	No Reverb

● Reverb Time

```

Reverb Time
  01

```

Reverberation time can be set from 1 to 8. Higher values refer to longer reverb times. When a Delay is selected, higher values refer to longer delay time.

● Reverb Level

```

Reverb Level
  04

```

This sets the volume of the reverb sound from 0 to 7. Higher values increase the volume.

● Tone Balance

```

Tone Balance
  30      70
  ↑      ↑
Volume of Lower Tone  Volume of Upper Tone

```

The volume balance of the Upper and Lower Tones can be changed. The total amount of the two Tones is always 100. At 50, both levels are equal.

● Patch Level

```

Patch Level
  80

```

The volume of a Patch can be set from 0 to 100. Using this parameter, volume balance between two different Patches can be adjusted.

● Patch Name

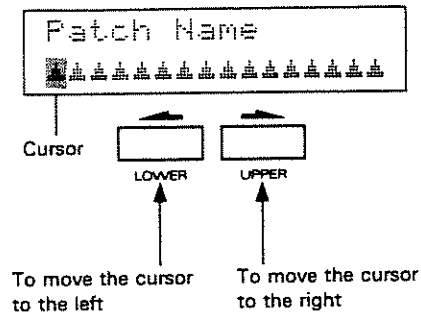

A Patch can be named using 16 letters. Move the cursor to the letter you wish to change by using the Cursor Buttons, then change the letter with the Value Control Knob. The letters available for naming a Patch are shown below.

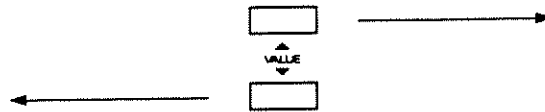

A...Z, a...z, 0...9, &# ! ? . , : ; ' " * + - / < = >
 (Space)

b. Timbre

1) Editing Procedure

Turn to the Multi Timbral mode (the Multi Timbral and Synth Indicators light up), then take the following procedure.

*Your edited version does not automatically rewrite existing data, and therefore will be erased when a different Timbre is selected or the unit is turned off. To retain the edited data, take the appropriate writing procedure (see page 67).

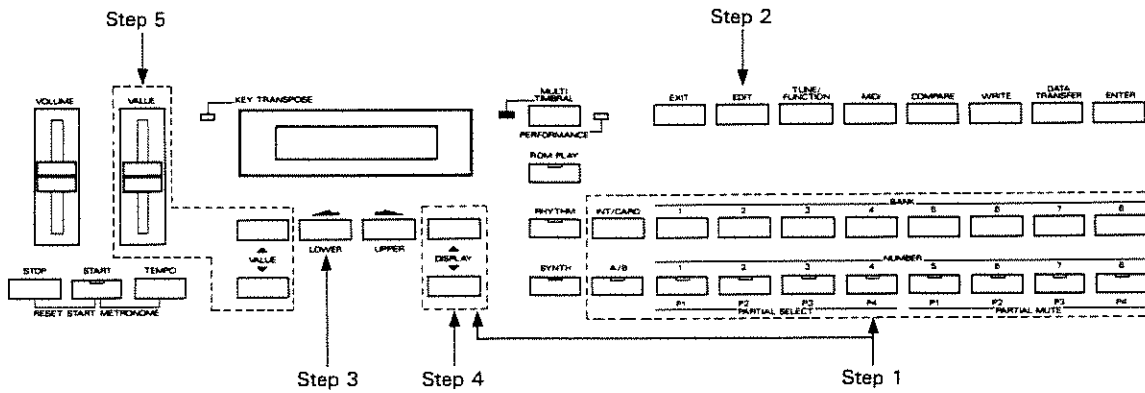

Step 1 Call the Timbre to be edited.

To edit a Timbre assigned to any Part, call the relevant Part Display using the Display Buttons.

To edit a Timbre which is not assigned to any Part, you can use any Part Display.

Step 2 Push the Edit Button.

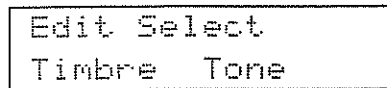

Step 3 Push the Cursor Button on the left.

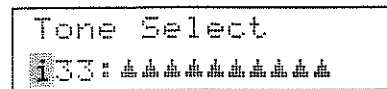

Step 4 **Select the parameter to be edited using the Display Buttons.**

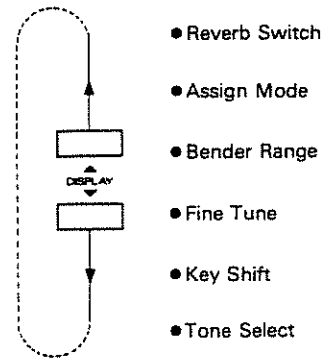

Step 5 **Change the value with the Value Control Knob.**

Step 6 **Repeat Steps 4 and 5 as many times as necessary.**

Step 7 **To write the value you have set, go to the writing procedure (page 67).**

***To leave the Timbre editing mode, push the Exit Button.**

2) Timbre Parameters

A Timbre is made of the following parameters.

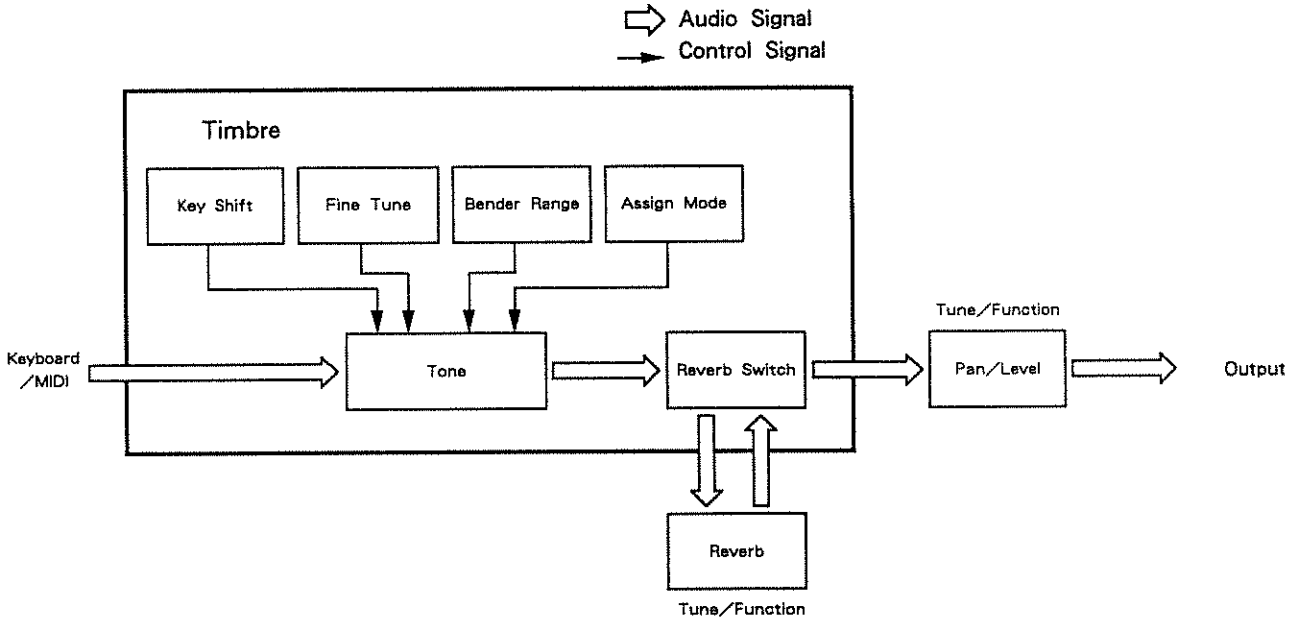

● Tone Select

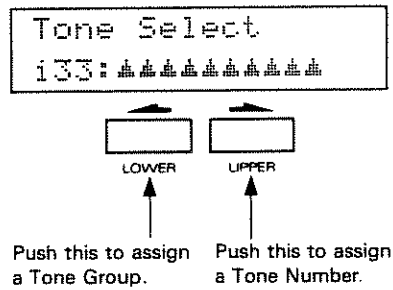

This selects a Tone which is to be assigned to a Timbre. Depending on which memory, the internal memory or memory card the Timbre belongs to, the available Tones will differ.

Tone Group	Internal		Memory Card	
	a, b, i	r	a, b, c	r
Number	1-64	1-63, OFF	1-64	1-63, OFF

- a : Preset Tone (Internal)
- b : Preset Tone (Internal)
- r : Preset Rhythm Tone (Internal)
- i : Programmable Tone (Internal)
- c : Tone a memory card

● Key Shift

```
Key Shift
  00
```

The pitch of the Tone can be set from -24 to +24 (2 octaves) in semi-tone steps.

● Fine Tune

```
Fine Tune
  00
```

The pitch of a Tone can be finely changed from -50 to +50 (about ± 50 cents).

● Bender Range

```
Bender Range
  24
```

This sets the variable range of the pitch change caused by moving the Bender Lever right and left from 0 to 24 (2 octaves) in semi-tone steps.

● Assign Mode

```

Assign Mode
1

```

The Assign mode refers to how each Tone should be played by Key messages received.

- 1 : Single Assign --- Played with Last Note Priority
- 2 : Single Assign --- Played with First Note Priority
- 3 : Multi Assign --- Played with Last Note Priority
- 4 : Multi Assign --- Played with First Note Priority

SINGLE ASSIGN

In this mode, when more than one Key ON message is received by the same Key Number on the same MIDI channel, the sound of that key is muted once, then played again.

MULTI ASSIGN

In this mode, when more than one Key ON message is received by the same Key Number on the same MIDI channel, two sounds are mixed.

LAST NOTE PRIORITY

In this mode, when the D-10 has received more than 32 Key On messages, the previously received ones are replaced by the later received ones.

FIRST NOTE PRIORITY

In this mode, when the D-10 has received more than 32 Key On messages, the later received ones are ignored, retaining the currently playing sounds.

● Reverb Swich

```

Reverb Switch
OFF

```

This selects whether to use the Reverb effect or not individually for each Tone. ON turns the effect on.

c. Writing Procedure

If you wish to retain your edited Patch or Timbre, write it into the internal memory or onto an optional memory card (M-256D, M-256E).

1) Writing into the internal memory

To write the edited data into the internal memory, do as follows.

*If you write the Patch or Timbre on a memory card into the D-10's internal memory, a Tone of c group will be automatically replaced with a Tone of i group. Therefore, the contents of a Patch or Timbre will be changed. To avoid this, first write the Tone on the memory card into the internal memory. (See page 112.)

[Memory Protect]

The Memory Protect function is provided for preventing data in memory from accidental erasure. To write data into the internal memory, you should turn off the Memory Protect of the D-10.

There are two types of Memory Protect OFF as follows :

<Temporary Type Memory Protect OFF during Writing>

This turns the Memory Protect function OFF just for one action of writing, then automatically returns to Protect ON right after. If you need to turn off the Memory Protect just once, such as when writing edited data, this type of Protect OFF will be sufficient.

<Normal Type Memory Protect OFF>

This type of Memory Protect OFF is retained until it is returned to ON, and therefore may be required when you need to write repeatedly.

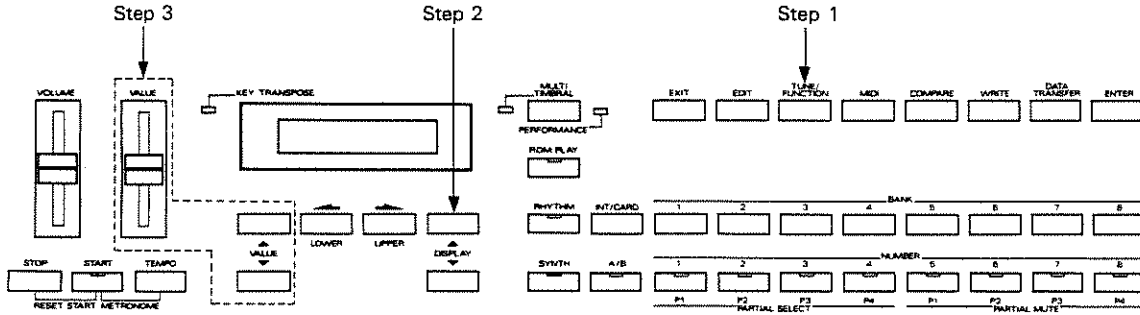

Step 1 Push the Tune/Function Button.

Step 2 Push the Display Button ▲.

The Memory Protect Display will appear.

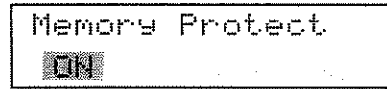

Step 3 Set the Memory Protect to OFF using the Value Control Knob.

*Be sure to return the Memory Protect to ON whenever you have finished writing.

*The D-10 defaults to Memory Protect ON.

[Writing Procedure]

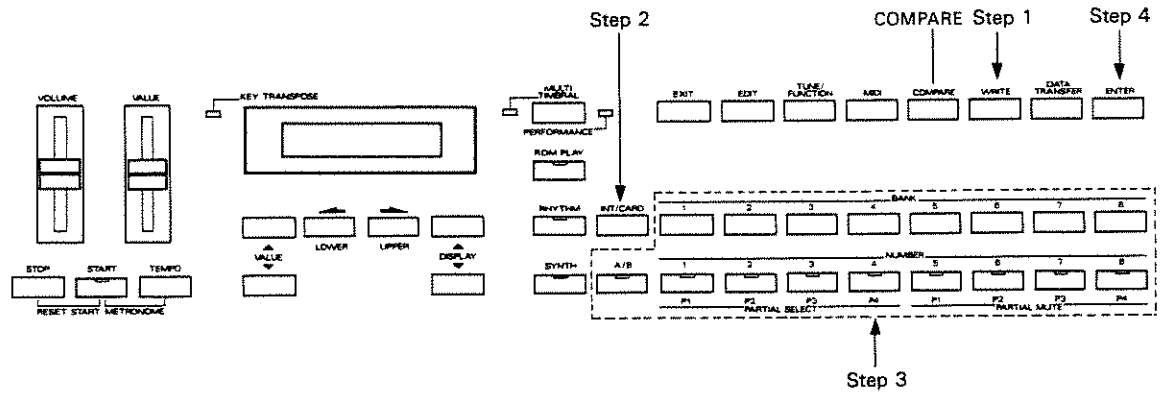

Step 1 Push the Write Button.

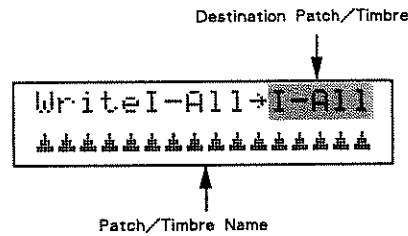

Step 2 If you have edited a source Patch or Timbre on a memory card, select "I" by pushing the Internal/Card Button.

Step 3 To change the destination Patch or Timbre number, use the A/B, Bank and Number Buttons.

If you wish to listen to the destination Patch or Timbre, do as follows.

① Push the Compare Button.

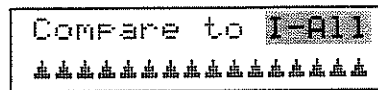

② Using the A/B, Bank and Number Buttons, assign the destination Patch or Timbre number.

Now, the relevant sound will be heard by playing any key on the keyboard.

③ Push the Compare Button to return to the previous Display.

Step 4 Push the Enter Button.

When the Memory Protect function has been turned OFF, the Display responds as shown below for a while, then returns to the Play Mode Display.

```
Complete
```

If the Memory Protect has been set to ON, the Display shows as below.

```
Turn Protect off  
once? Write/Exit
```

If you wish to turn the Memory Protect OFF (=Temporary Memory Protect OFF during writing) here, push the Write Button then the Enter Button.

*If the writing procedure is not completed properly, an Error Message will appear instead. See page 150 "Error Messages" to resolve this.

2) Writing onto a memory card

*When using a brand new memory card, take the "Saving" procedure (see page 127) to copy the entire data onto the memory card, before writing the Patch or Timbre data.

*If you write the Patch or Timbre in the D-10's internal memory onto a memory card, a Tone of i group will be automatically replaced with a Tone of c group. Therefore, the contents of a Patch or Timbre will be changed. To avoid this, first write the Tone in the internal memory onto the card. (See page 112.)

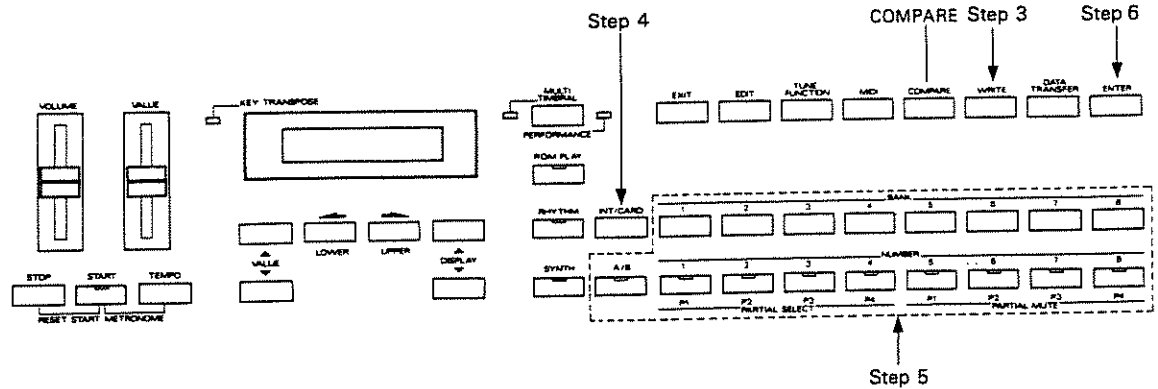

- Step 1 Insert a memory card into the Card Slot.
- Step 2 Set the Protect Switch on the memory card to the OFF position.

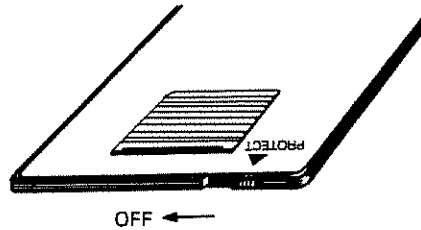

- Step 3 Push the Write Button.

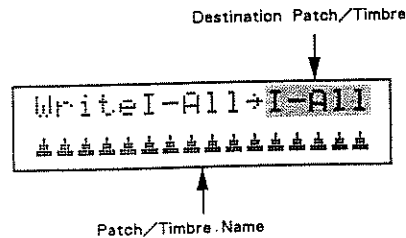

Step 4 If you have edited a source Patch or Timbre in the internal memory, select "C" by pushing the Internal/Card Button.

Step 5 To change the destination Patch or Timbre number, use the A/B, Bank and Number Buttons.

If you wish to listen to the destination Patch or Timbre, do as follows.

① Push the Compare Button.

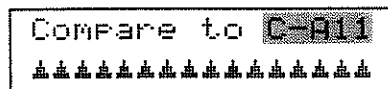

② Using the A/B, Bank and Number Buttons, assign the destination Patch or Timbre number.

Now, the relevant sound will be heard by playing any key on the keyboard.

③ Push the Compare Button to return to the previous Display.

Step 6 Push the Enter Button.

When completed, the Display shows as below for a while and then returns to the Play Mode Display.

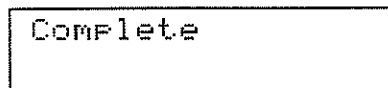

*If the writing procedure is not properly completed, an Error Message will appear instead. See page 150 "Error Messages" to resolve this.

Step 7 Return the Protect Switch on the memory card to the ON position.

3. Tone

Please read "LA System" on page 138 together with this chapter.

a. The Basic Concept of a Tone

1) Partial and Structure

The basic concept of a Tone as shown below.

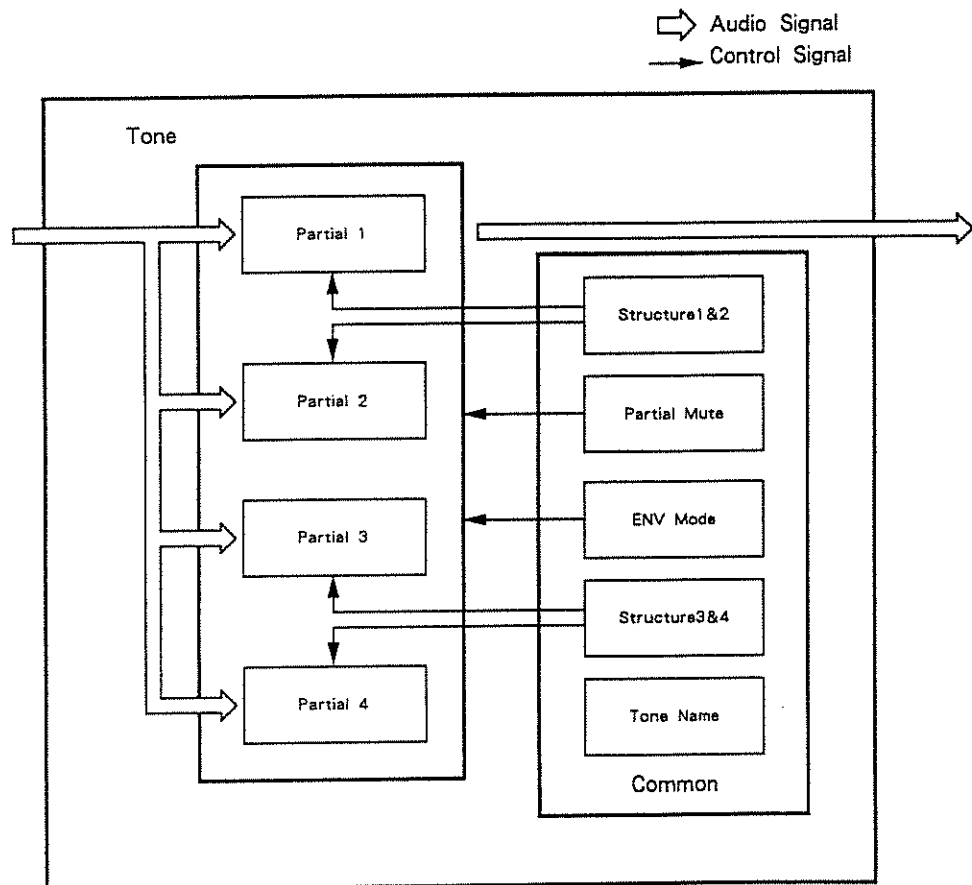

A Tone consists of four Partials and a Common block. The Partials are combined in pairs, and two pairs of partials form a Tone. An important parameter called "Structure" decides how each pair of Partials should be combined, or which sound generator should be used for each Partial. COMMON parameters are common to four Partials.

[Functions of the Structure]

(1) Selects a sound generator to be used for each Partial

The Structure selects which of the two sound generators, a synthesizer sound generator or a PCM sound generator.

Synthesizer Sound Generator

→ This synthesizer behaves like a conventional analog synthesizer.

PCM Sound Generator

→ This behaves like a PCM sampled synthesizer.

(2) Selects how to combine Partials

There are four different ways to combine Partials :

○ Mixing two Partials

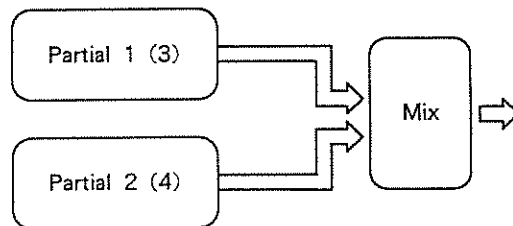

○ Sending two Partial sounds in stereo. This combination is effective for Timbres or Rhythm Tones in stereo. However, if using this setting in monaural output, this will have exactly the same effect as above "Mixing two Partials".

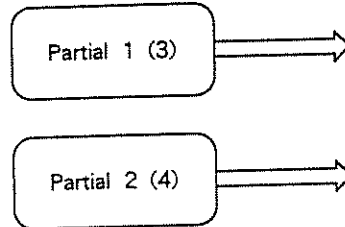

*When this Structure is selected, the condition of each Partial is automatically set as follows depending on the pan setting.

Value of Pan	Actual Value	
	Partial 1 (3)	Partial 2 (4)
<7	<7	<7
<6	<5	<7
<5	<3	<7
<4	<1	<7
<3	1>	<7
<2	3>	<7
<1	5>	<7
><	7>	<7
1>	7>	<5
2>	7>	<3
3>	7>	<1
4>	7>	1>
5>	7>	3>
6>	7>	5>
7>	7>	7>

○ Partial 1 (or 3) is mixed with the ring modulated sound of two Partials (including Partial 1).

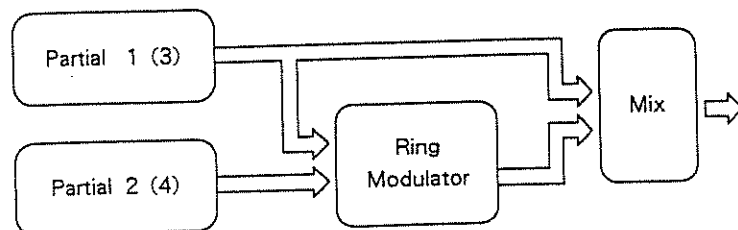

○ **Two Partial**s are ring-modulated and sent out.

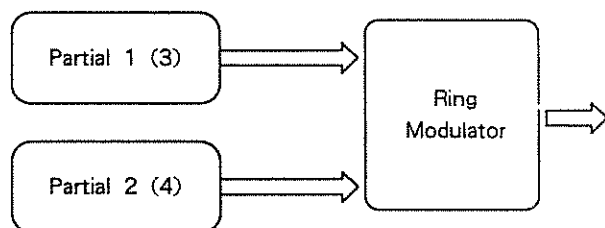

The Ring Modulator can be effectively used for creating metallic sounds, since it can increase harmonics by multiplying two Partial

s.

2) Partial

Depending on which generators are selected in the Partial Block, greatly different parameters will be used. Some parameters used for the synthesizer sound generators are irrelevant to the PCM generator. See the diagram below.

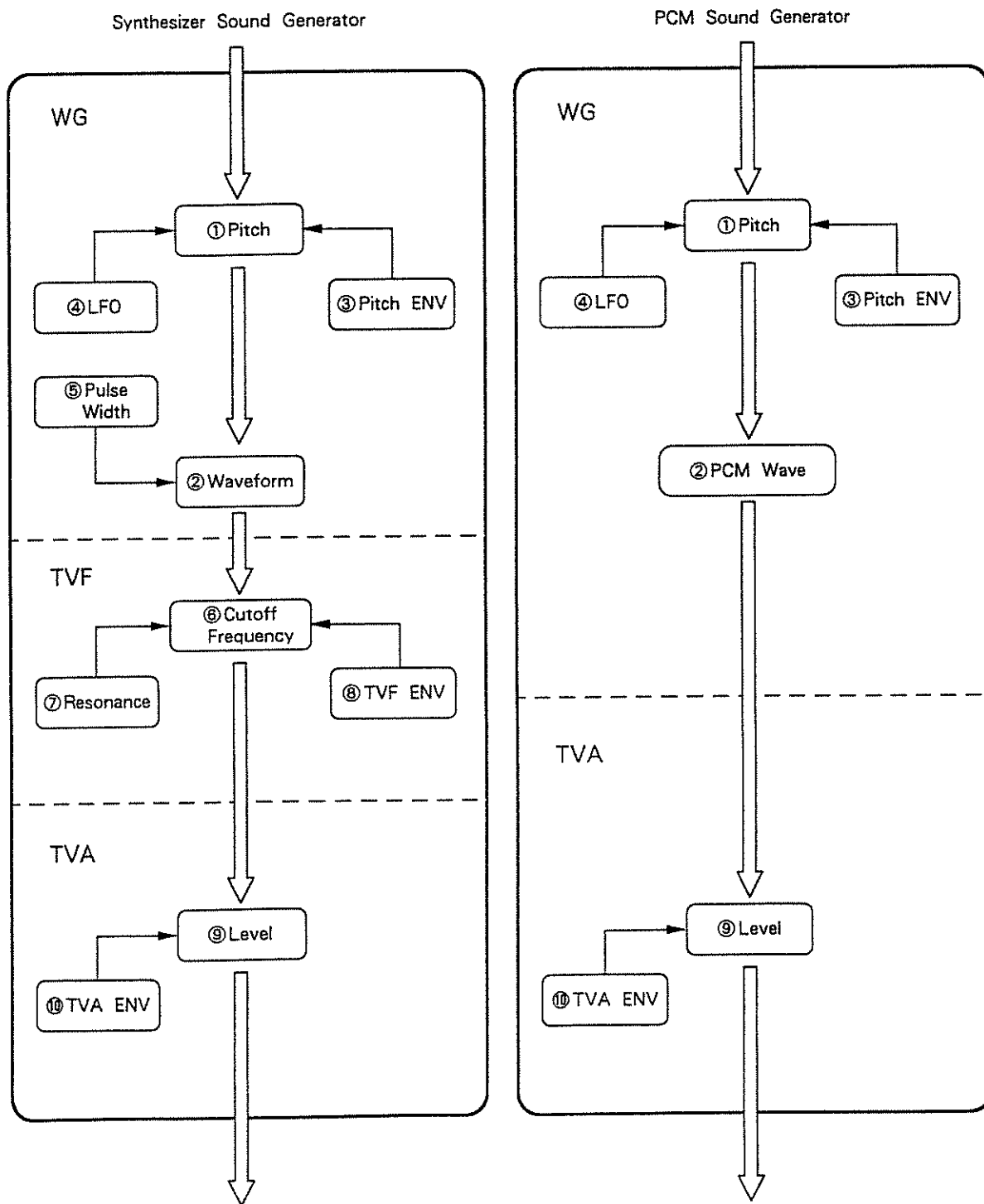

● WG (Wave Generator)

In the WG (Wave Generator), the pitch and waveform are controlled.

① Pitch

The basic pitch of a Partial (sound generator) at C4 key (=middle C) can be set here.

② Waveform/PCM Wave Number

This selects the waveform of the sound source.

③ Pitch ENV

This controls an envelope curve of the pitch changes caused by Key On/Off.

④ LFO (Low Frequency Oscillator)

LFO controls the vibrato.

⑤ Pulse Width

This changes the waveform of the sound source.

● TVF (Time Variant Filter)

This filter passes lower frequency harmonics and cuts off the higher ones. By changing the cutoff point and the resonance, the waveform changes.

⑥ Cutoff Frequency

This sets the cutoff point.

⑦ Resonance

This emphasizes the cutoff point, making more unusual or electronic sounds.

⑧ TVF ENV

This controls an envelope curve which changes cutoff point, caused by Key On/Off.

● **TVA (Time Variant Amplifier)**

This controls the volume of the Partial.

⑨ **Level**

This determines the volume of the sound.

⑩ **TVA ENV**

This controls an envelope curve of the level changes caused by Key On/Off.

b. Editing Procedure

☐ For quicker and easier editing or synthesizing from scratch, the optional programmer PG-10 may be essential.

There are various groups of Tones. The Tones available for a Timbre or Patch differ depending on which memory, the internal memory or memory card, it belongs to.

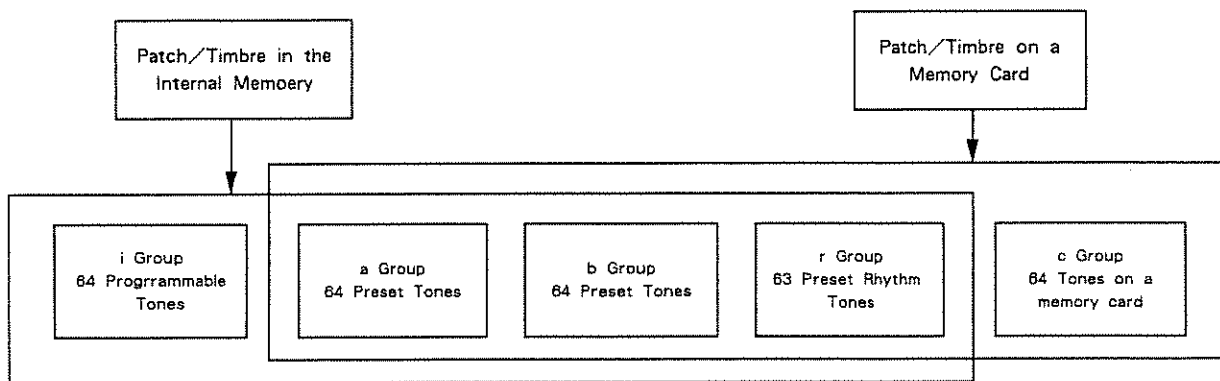

1) Editing Procedure

*The editing procedure does not automatically rewrite the existing data, the appropriate writing procedure on page 112 must be taken.

[Tone Selection]

Select a Tone which is similar to the sound you wish to make. The procedure for selecting a Tone differs in the Performance mode or Multi Timbral mode.

=Performance Mode=

Enter the Performance Play mode (the Performance and Synth Indicators light up), then do as follows.

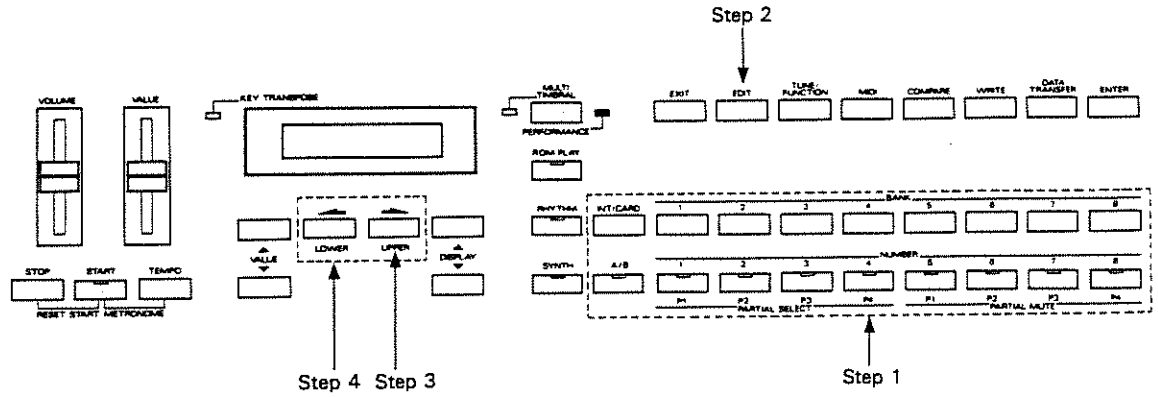

Step 1 **Select a Patch that contains the Tone you want.**

Step 2 **Push the Edit Button.**

```

Edit Select
Patch  Tone
    
```

Step 3 **Push the Cursor Button on the right.**

```

Edit Select
Lower  Upper
    
```

Step 4 **To edit the Lower Tone, push the Cursor Button on the left, and to edit the Upper Tone, the Cursor button on the right.**

```

Common
Select Parameter
    
```

Go to the following "Editing Tone Parameters".

=Multi Timbral Mode=

Take the following procedure in the Multi Timbral Play mode (=the Multi Timbral and Synth Indicators are lit.)

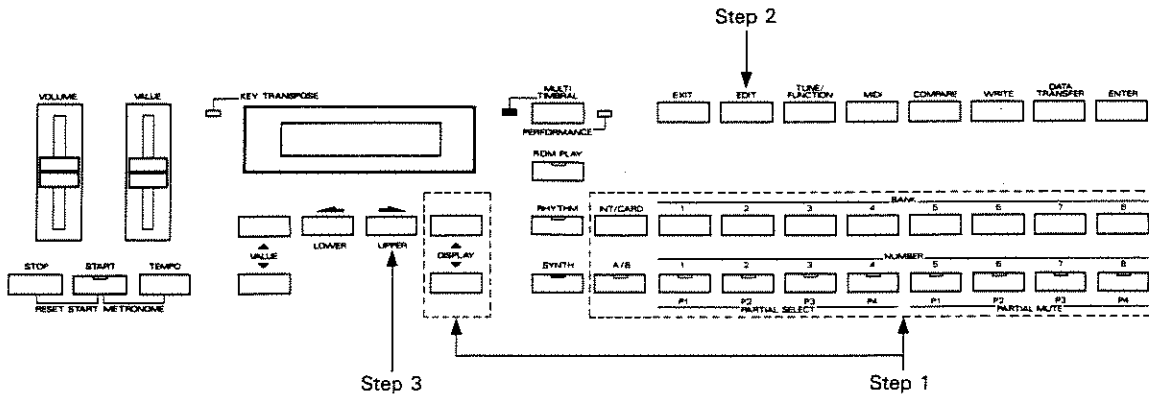

Step 1 **Select a Timbre that contains the Tone you want.**

To select a Timbre already assigned to any Part, use the relevant Part Display.

To select a Timbre which is not assigned to any Part, you can use any Part Display.

Step 2 **Push the Edit Button.**

```

Edit Select
Timbre Tone
    
```

Step 3 **Push the Cursor Button on the right.**

```

Common
Select Parameter
    
```

Go to the following "Editing Tone Parameters".

[Editing Tone Parameters]

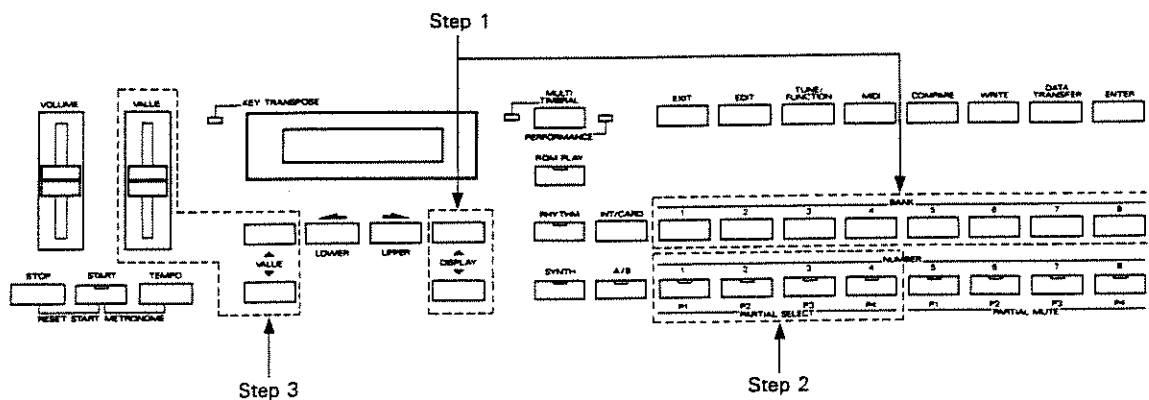

Step 1 Call the group that contains the parameter to be edited using the Display Buttons, then select the parameter with the Bank Button. (See the table below.)

Group	BANK							
	1	2	3	4	5	6	7	8
TVA ENV	Key Follow (Time)	Time 1	Time 2	Time 3	Time 4	Level 1	Level 2	Sustain Level
TVA Level	Level	Velocity	Bias Point 1	Bias Level 1	Bias Point 2	Bias Level 2	ENV Velocity Follow (Time)	
TVF ENV	Key Follow (Time)	Tim 1	Time 2	Time 3	Time 4	Level 1	Level 2	Sustain Level
TVF Frequency	Cutoff Frequency	Resonance	Key Follow	Bias Point	Bias Level	ENV Depth	ENV Velocity	ENV Key Follow (Depth)
WG Pitch ENV	Time 1	Time 2	Time 3	Time 4	Level 0	Level 1	Level 2	End Level
WG Form/ Pitch ENV	Waveform	PCM Wave Bank	PCM Wave No.	Pulse Width	PW Velocity	ENV Depth	ENV Velocity	ENV Key Follow (Time)
WG Pitch/ Modulation	Pitch Coarse	Pitch Fine	Key Follow (Pitch)	LFO Rate	LFO Depth	LFO Modulation Sensitivity	Bender Switch	
Common	Tone Name	Structure 1 & 2	Structure 3 & 4	ENV Mode				

Step 2 The Partial's Display shows the values of four Partials at the same time. Select the value to be edited using the Number Button (1-4).

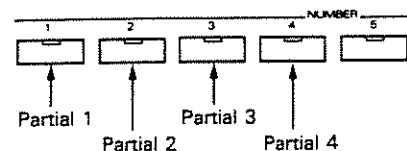
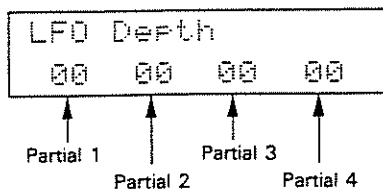

The corresponding Number Indicator will light up and the value you have selected (=flashing) can be now edited. It is possible to edit more than one Partial simultaneously by pressing different Number Buttons.

Step 3 Change the value with the Value Control Knob.

Step 4 If you wish to write the edited value, take the appropriate writing procedure (page 112) immediately.

*If you do not wish to write the edited value, push the Exit Button.

2) Editing Functions

Various useful functions for editing are provided as follows.

[Partial Mute]

While editing a Partial parameter, any Partial sound can be muted, for you to listen to only the Partial you need.

The Partial Mute, which is also one of the Tone parameters, can be written into memory.

Simply push the relevant Number Buttons (5-8). The button indicator is muted when the corresponding Partial is muted.

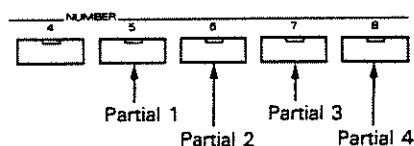

*Parameters of the Partial currently muted can be edited just the same.

*Muting one of the Partials used in the Ring Modulator will automatically output the other Partial which is not muted.

*Partial Mute decreases the number of Partials which are to be used, and therefore increases the number of voices.

[Previous Value]

"Previous Value" is the function that returns the current value of the parameter to the original value before being edited in the same Display.

< e. g. >

① Change to the LFO Display.

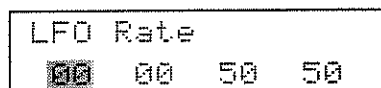

② Change the value of Partial 1 from 00 to 30.

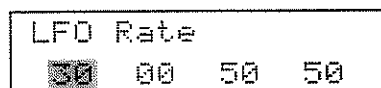

③ Push the Compare Button.

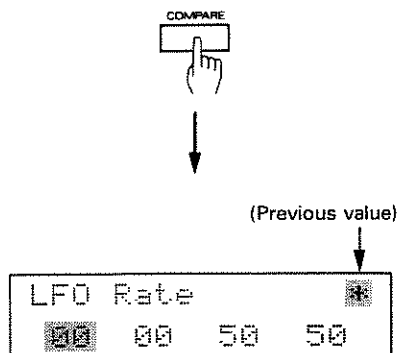

Now, the value before being edited (=00) is retrieved and played from the keyboard.

④ Push the Compare Button to return to the edited value (sound).

*If you change the value or the setting of the Partial Select in the Previous Value Display, the * mark will disappear and the Previous Value mode is cancelled. This means that pressing the Compare Button does not retrieve the edited value (=30).

[Compare]

While editing a parameter, you may wish to hear the original sound before it was edited. The Compare function allows you to call the original Tone without erasing the edited sound.

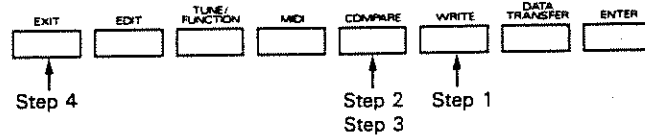

Step 1 Push the Write Button.

Step 2 Push the Compare Button.

The original sound can be heard by playing the keyboard.

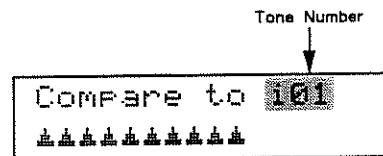

*If the source Tone you have been using is a Preset Tone, the Display does not show the Tone Number or Tone Name.

Step 3 Push the Compare Button to return the edited Tone.

Step 4 Push the Exit Button.

Now, the unit is returned to the Tone Editing mode.

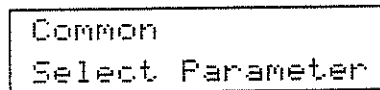

c. Tone Parameters

Some parameters included in a Partial that uses PCM sound generators are invalid. The following mark is shown when the parameters apply even for PCM sounds.

PCM

1) Common Parameters

● Tone Name **PCM**

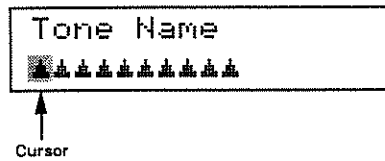

A Tone can be named using up to 10 letters. Move the cursor to the letter to be changed, then change letters with the Value Control Knob. The available letters for naming are as shown below.

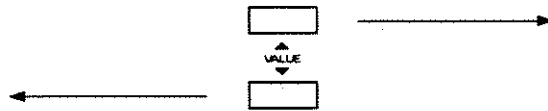

⌋ A...Z, a...z, 0...9, & # ! ? . , : ; ' " * + - / < = >
(Space)

● Structure 1&2/3&4 **PCM**

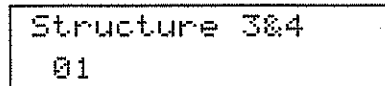
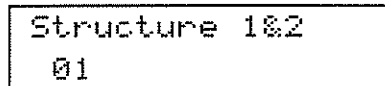

Select one of the following 13 Structures.

S (Synthesizer Sound Generator)
P (PCM Sound Generator)

Structure Number	Partial 1	Partial 2	Combination of two Partials	Block Diagram
1	S	S	Mixtrue of Partial 1 (or 3) and Partial 2 (or 4).	
2	S	S	Mixtrue of Partial 1 (or 3) and ring-modulation.	
3	P	S	Mixtrue of Partial 1 (or 3) and Partial 2 (or 4).	
4	P	S	Mixtrue of Partial 1 (or 3) and ring-modulation.	
5	S	P	Mixtrue of Partial 1 (or 3) and ring-modulation.	
6	P	P	Mixtrue of Partial 1 (or 3) and Partial 2 (or 4).	
7	P	P	Mixtrue of Partial 1 (or 3) and ring-modulation.	
8	S	S	Partial 1 (or 3) and Partial 2 (or 4) are output in stereo.	
9	P	P	Partial 1 (or 3) and Partial 2 (or 4) are output in stereo.	
10	S	S	Partial 1 (or 3) and Partial 2 (or 4) are ring-modulated then output.	
11	P	S	Partial 1 (or 3) and Partial 2 (or 4) are ring-modulated then output.	
12	S	P	Partial 1 (or 3) and Partial 2 (or 4) are ring-modulated then output.	
13	P	P	Partial 1 (or 3) and Partial 2 (or 4) are ring-modulated then output.	

● ENV Mode

PCM

ENV Mode NORMAL

This selects whether to receive or ignore the Key Off messages in the ENV of each Partial. Normally, this should be set to NORMAL, but set to NO SUSTAIN for programming a Rhythm Tone.

[e.g.] TVF ENV/TVA ENV

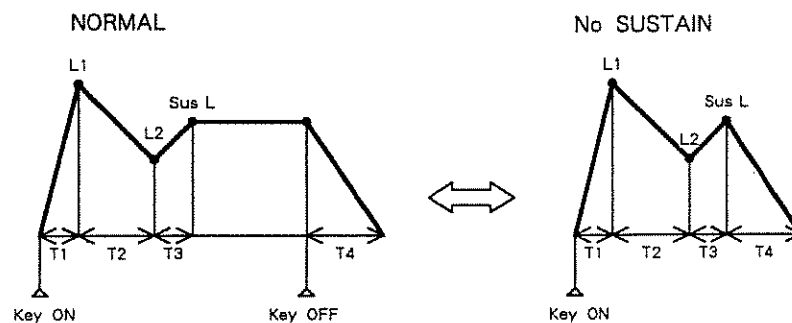

*When the ENV mode is NO SUSTAIN, the End Level of the Pitch ENV is played at the Point 3 Level.

*When using a non-Rhythm Tone (Internal Tone) as a Rhythm Tone and being played by the rhythm pattern, the ENV mode always changes to NO SUSTAIN no matter how it is set.

2) WG Pitch/Modulation

● Pitch Coarse **PCM**

WG Pitch Coarse
C4 C4 C4 C4

This sets the standard pitch of a Partial in semi-tone steps from C1 to C9.

*The standard pitch is the pitch at C4 (middle C) key.

● Pitch Fine **PCM**

WG Pitch Fine
00 00 00 00

The standard pitch can be altered over about ± 50 cents from -50 to $+50$.

● Key Follow (Pitch) **PCM**

WG Pitch KF
1 1 1 1

Usually, the keyboard of a synthesizer assigns a semi-tone to each key. This Parameter can change the pitch ratio as shown below.

A value represents how many octaves are changed over 12 keys.

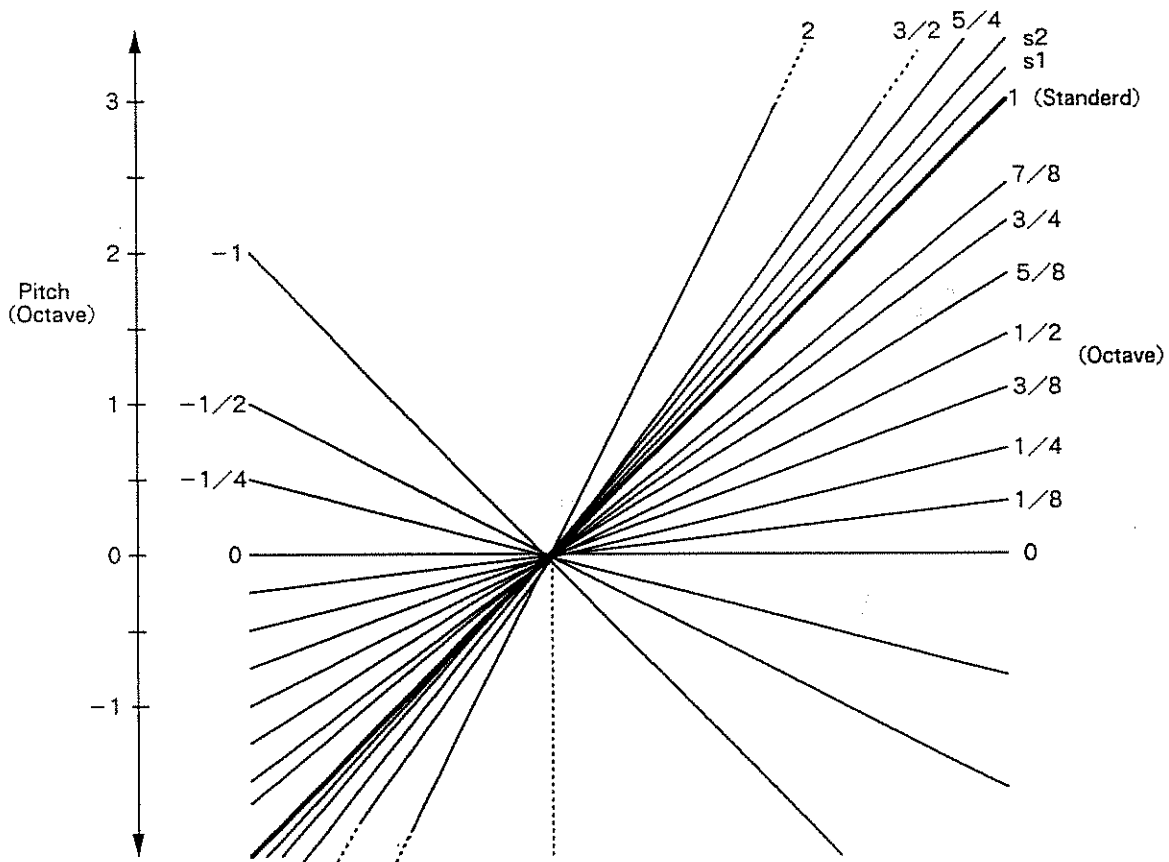

Middle C (C4)

s1 or s2 may be selected for slightly stretching octaves. The "s" standing for special tuning.

- s1: Pitch 1 cent higher than one octave
- s2: Pitch 5 cents higher than one octave.

● LFO Rate **PCM**

```
LFO Rate
 00 00 00 00
```

This sets the rate (frequency) of the LFO from 0 to 100. Higher values quicken the rate.

● LFO Depth **PCM**

```
LFO Depth
 00 00 00 00
```

This sets the depth of the LFO from 0 to 100. Higher values deepen the depth.

*Vibrate effect can be obtained only from Point 3 to Key Off of the Pitch ENV.

● Modulation Sensitivity **PCM**

```
WG Modulation
 00 00 00 00
```

This sets the sensitivity of the vibrato depth controlled by the bender lever from 0 to 100. Higher values deepen the effect.

*Vibrate effect can be obtained only from Point 3 to Key Off of the Pitch ENV.

● Bender Switch **PCM**

```
WG Bender Switch
ON ON ON ON
```

This selects whether to control the pitch by the bender lever or not.



3) WG Form/Pitch ENV

● Waveform

```

WG Waveform
SQU SQU SQU SQU
    
```

This selects a waveform of the synthesizer sound generator.

Display	Waveform
SQU (Square)	
SAW (Sawtooth)	

*A sawtooth waveform is produced by processing a square waveform at the TVF, that is, even a sawtooth waveform can be controlled by Pulse Width.

● PCM Wave Bank/Number

PCM

PCM Wave Bank

```

WG PCM Wave Bank
1 1 1 1
    
```

PCM Wave Number

```

WG PCM Wave No.
01 01 01 01
    
```

This selects one of the 256 different sampled waves (128 waves in each Bank 1 or 2) of the PCM sound generator. Each sample is named (PCM name) as shown in the following table. A PCM name is shown in the PCM Wave Number Display when only one Partial is selected with the Partial Select parameter.

```

WG PCM Wave No.
1- 01:#####
    
```

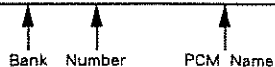

*When PCM Sound No. 112-128 in Bank 1 are selected, noise may be occurred according to the setting of TVA ENV.

Bank 1

No.	PCM Name	Remarks
1	Bass Drum-1	Rhythm Sound
2	Bass Drum-2	
3	Bass Drum-3	
4	Snare Drum-1	
5	Snare Drum-2	
6	Snare Drum-3	
7	Snare Drum-4	
8	Tom Tom-1	
9	Tom Tom-2	
10	High-Hat	
11	High-Hat (Loop)	
12	Crash Cymbal-1	
13	Crash Cymbal-2 (Loop)	
14	Ride Cymbal-1	
15	Ride Cymbal-2 (Loop)	
16	Cup	
17	China Cymbal-1	
18	China Cymbal-2 (Loop)	
19	Rim Shot	
20	Hand Clap	
21	Mute High Conga	
22	Conga	
23	Bongo	
24	Cowbell	
25	Tambourine	
26	Agogo	
27	Claves	
28	Timbale High	
29	Timbale Low	
30	Cabasa	
31	Timpani Attack	Attack Sound
32	Timpani	
33	Acoustic Piano High	
34	Acoustic Piano Low	
35	Piano Forte Thump	
36	Organ Percussion	
37	Trumpet	
38	Lips	
39	Trombone	
40	Clarinet	
41	Flute High	
42	Flute Low	
43	Steamer	
44	Indian Flute	
45	Breath	
46	Vibraphone High	
47	Vibraphone Low	
48	Marimba	
49	Xylophone High	
50	Xylophone Low	
51	Kalimba	
52	Wind Bell	
53	Chime Bar	
54	Hammer	
55	Guiro	
56	Chink	
57	Nails	
58	Fretless Bass	
59	Pull Bass	
60	Slap Bass	
61	Thump Bass	
62	Acoustic Bass	
63	Electric Bass	
64	Gut Guitar	

No.	PCM Name	Remarks	
65	Steel Guitar		
66	Dirty Guitar		
67	Pizzicato		
68	Harp		
69	Contrabass		
70	Cello		
71	Violin-1		
72	Violin-2		
73	Koto		
74	Draw bars (Loop)		Sustained Sound
75	High Organ (Loop)		
76	Low Organ (Loop)		
77	Trumpet (Loop)		
78	Trombone (Loop)		
79	Sax-1 (Loop)		
80	Sax-2 (Loop)		
81	Reed (Loop)		
82	Slap Bass (Loop)		
83	Acoustic Bass (Loop)		
84	Electric Bass-1 (Loop)		
85	Electric Bass-2 (Loop)		
86	Gut Guitar (Loop)		
87	Steel Guitar (Loop)		
88	Electric Guitar (Loop)		
89	Clav (Loop)		
90	Cello (Loop)		
91	Violin (Loop)		
92	Electric Piano-1 (Loop)		
93	Electric Piano-2 (Loop)		
94	Harpsichord-1 (Loop)		
95	Harpsichord-2 (Loop)		
96	Telephone Bell (Loop)		
97	Female Voice-1 (Loop)		
98	Female Voice-2 (Loop)		
99	Male Voice-1 (Loop)		
100	Male Voice-2 (Loop)		
101	Spectrum-1 (Loop)		
102	Spectrum-2 (Loop)		
103	Spectrum-3 (Loop)		
104	Spectrum-4 (Loop)		
105	Spectrum-5 (Loop)		
106	Spectrum-6 (Loop)		
107	Spectrum-7 (Loop)		
108	Spectrum-8 (Loop)		
109	Spectrum-9 (Loop)		
110	Spectrum-10 (Loop)		
111	Noise (Loop)		
112	Shot-1	Decay Sound	
113	Shot-2		
114	Shot-3		
115	Shot-4		
116	Shot-5		
117	Shot-6		
118	Shot-7		
119	Shot-8		
120	Shot-9		
121	Shot-10		
122	Shot-11		
123	Shot-12		
124	Shot-13		
125	Shot-14		
126	Shot-15		
127	Shot-16		
128	Shot-17		

Bank 2

No.	PCM Name	Remarks
1	Bass Drum-1*	Rhythm Sound (The pitch is not affected by Master Tuning.)
2	Bass Drum-2*	
3	Bass Drum-3*	
4	Snare Drum-1*	
5	Snare Drum-2*	
6	Snare Drum-3*	
7	Snare Drum-4*	
8	Tom Tom-1*	
9	Tom Tom-2*	
10	High-Hat*	
11	High-Hat* (Loop)	
12	Crash Cymbal-1*	
13	Crash Cymbal-2* (Loop)	
14	Ride Cymbal-1*	
15	Ride Cymbal-2* (Loop)	
16	Cup*	
17	China Cymbal-1*	
18	China Cymbal-2* (Loop)	
19	Rim Shot*	
20	Hand Clap*	
21	Mute High Conga*	
22	Conga*	
23	Bongo*	
24	Cowbell*	
25	Tambourine*	
26	Agogo*	
27	Claves*	
28	Timbale High*	
29	Timbale Low*	
30	Cabasa*	
31	Loop-1	Effect Sound (Repeats of the same sound.)
32	Loop-2	
33	Loop-3	
34	Loop-4	
35	Loop-5	
36	Loop-6	
37	Loop-7	
38	Loop-8	
39	Loop-9	
40	Loop-10	
41	Loop-11	
42	Loop-12	
43	Loop-13	
44	Loop-14	
45	Loop-15	
46	Loop-16	
47	Loop-17	
48	Loop-18	
49	Loop-19	
50	Loop-20	
51	Loop-21	
52	Loop-22	
53	Loop-23	
54	Loop-24	
55	Loop-25	
56	Loop-26	
57	Loop-27	
58	Loop-28	
59	Loop-29	
60	Loop-30	
61	Loop-31	
62	Loop-32	
63	Loop-33	
64	Loop-34	

No.	PCM Name	Remarks
65	Loop-35	
66	Loop-36	
67	Loop-37	
68	Loop-38	
69	Loop-39	
70	Loop-40	
71	Loop-41	
72	Loop-42	
73	Loop-43	
74	Loop-44	
75	Loop-45	
76	Loop-46	
77	Loop-47	
78	Loop-48	
79	Loop-49	
80	Loop-50	
81	Loop-51	
82	Loop-52	
83	Loop-53	
84	Loop-54	
85	Loop-55	
86	Loop-56	
87	Loop-57	
88	Loop-58	
89	Loop-59	
90	Loop-60	
91	Loop-61	
92	Loop-62	
93	Loop-63	
94	Loop-64	
95	Jam-1 (Loop)	Effect Sound (Repeats of combined sound.)
96	Jam-2 (Loop)	
97	Jam-3 (Loop)	
98	Jam-4 (Loop)	
99	Jam-5 (Loop)	
100	Jam-6 (Loop)	
101	Jam-7 (Loop)	
102	Jam-8 (Loop)	
103	Jam-9 (Loop)	
104	Jam-10 (Loop)	
105	Jam-11 (Loop)	
106	Jam-12 (Loop)	
107	Jam-13 (Loop)	
108	Jam-14 (Loop)	
109	Jam-15 (Loop)	
110	Jam-16 (Loop)	
111	Jam-17 (Loop)	
112	Jam-18 (Loop)	
113	Jam-19 (Loop)	
114	Jam-20 (Loop)	
115	Jam-21 (Loop)	
116	Jam-22 (Loop)	
117	Jam-23 (Loop)	
118	Jam-24 (Loop)	
119	Jam-25 (Loop)	
120	Jam-26 (Loop)	
121	Jam-27 (Loop)	
122	Jam-28 (Loop)	
123	Jam-29 (Loop)	
124	Jam-30 (Loop)	
125	Jam-31 (Loop)	
126	Jam-32 (Loop)	
127	Jam-33 (Loop)	
128	Jam-34 (Loop)	

● Pulse Width

```

WG Pulse Width
50 50 50 50
    
```

A square waveform has exactly the same width, vertically and horizontally, but a Pulse Width waveform has different widths. The ratio of upper width to lower is called pulse width. 0 to 100 are valid for setting the pulse width. Depending on the set pulse width value, the harmonic content of the sound changes greatly.

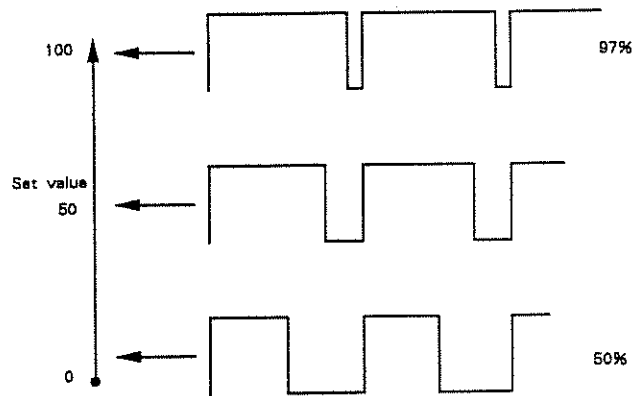

*When a sawtooth is selected with the WG Waveform parameter, pulse width 50% raises the pitch by an octave.

● Pulse Width Velocity Sensitivity

```

WG PW Velocity
00 00 00 00
    
```

This sets the sensitivity of the velocity that controls the pulse width from -7 to +7. With "-" values, the pulse width becomes smaller by playing the keyboard harder, and with "+" values, the pulse width becomes wider by playing the keyboard harder.

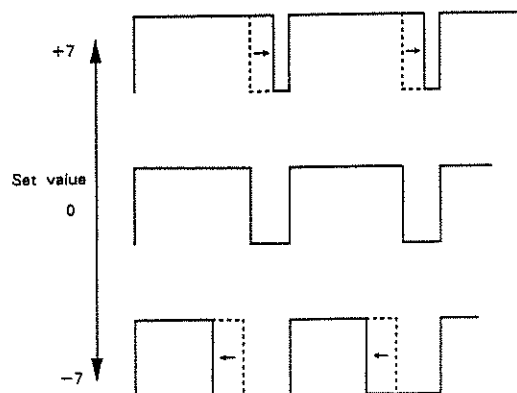

● Pitch ENV Depth **PCM**

```

P-ENV Depth
05 05 05 05

```

This sets the depth of the Pitch ENV from 1 to 10. Higher values deepen the effect.

● Pitch ENV Velocity Sensitivity **PCM**

```

P-ENV Velocity
02 02 02 02

```

This sets the maximum effect of the velocity that controls the pitch of the Pitch ENV from 0 to 3. At higher values, the keyboard velocity has a greater effect on the envelope.

● Pitch ENV Key Follow (Time) **PCM**

```

P-ENV Time KF
00 00 00 00

```

This sets the time of the Pitch ENV depending on the key played, from 0 to 4. Higher values change the time more drastically.

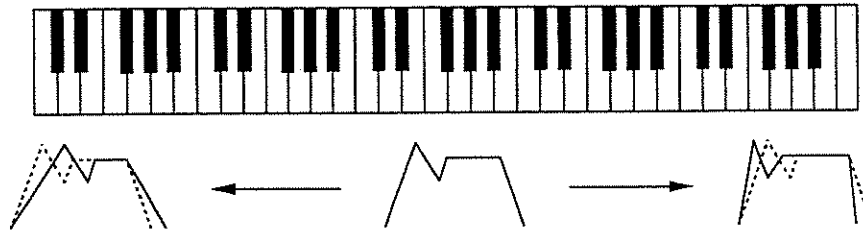

4) Pitch ENV

● Pitch ENV Time/Level **PCM**

These parameters are the time needed for a pitch curve to move from one point to another, and the pitch level of a certain point.

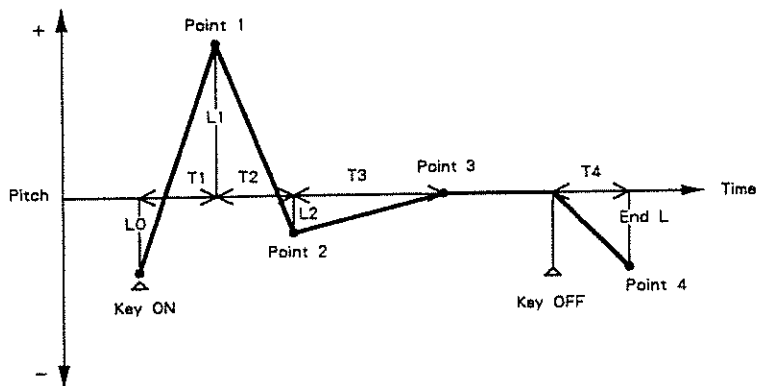

Time 1/Time 2/Time 3/ Time 4

P-ENV Time 1
50 50 50 50

P-ENV Time 2
50 50 50 50

P-ENV Time 3
50 50 50 50

P-ENV Time 4
50 50 50 50

This sets the time needed from one point to another, from 0 to 100.

Level 0/Level 1/Level 2/End Level

```
P-ENV Level 0  
00 00 00 00
```

```
P-ENV Level 1  
00 00 00 00
```

```
P-ENV Level 2  
00 00 00 00
```

```
P-ENV End Level  
00 00 00 00
```

*When the ENV mode is NO SUSTAIN, the End Level of the Pitch ENV is played at the Point 3 Level.

This sets the pitch of a certain point from -50 to +50.

*If the level of two adjacent points are set to similar values, the time between these two points may prove to be shorter than what is actually set, or even zero.

5) TVF Frequency/ENV

● Cutoff Frequency

```

TVF Cutoff Freq
100 100 100 100

```

This sets the cutoff point of the TVF from 0 to 100. As you lower the value, higher frequencies are removed and the waveform gradually become an approximation of a sine wave, then the sound will finally fade out.

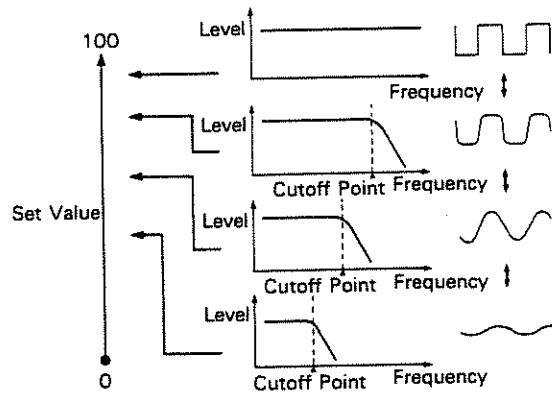

● Resonance

```

TVF Resonance
00 00 00 00

```

This boosts the cutoff point from 0 to 30. As you increase the value, specific harmonics are emphasized and the sound will become more unusual, more electronic in nature.

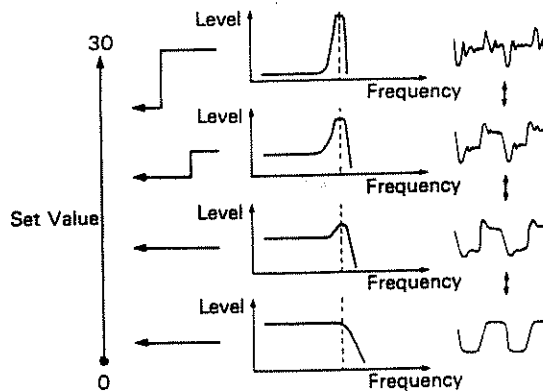

● Key Follow (Frequency)

```
TUF Freq KF
1/2 1/2 1/2 1/2
```

This can change the cutoff point depending on the key played.

Just like the Key Follow of WG Pitch, the value represents how many octaves change over 12 keys.

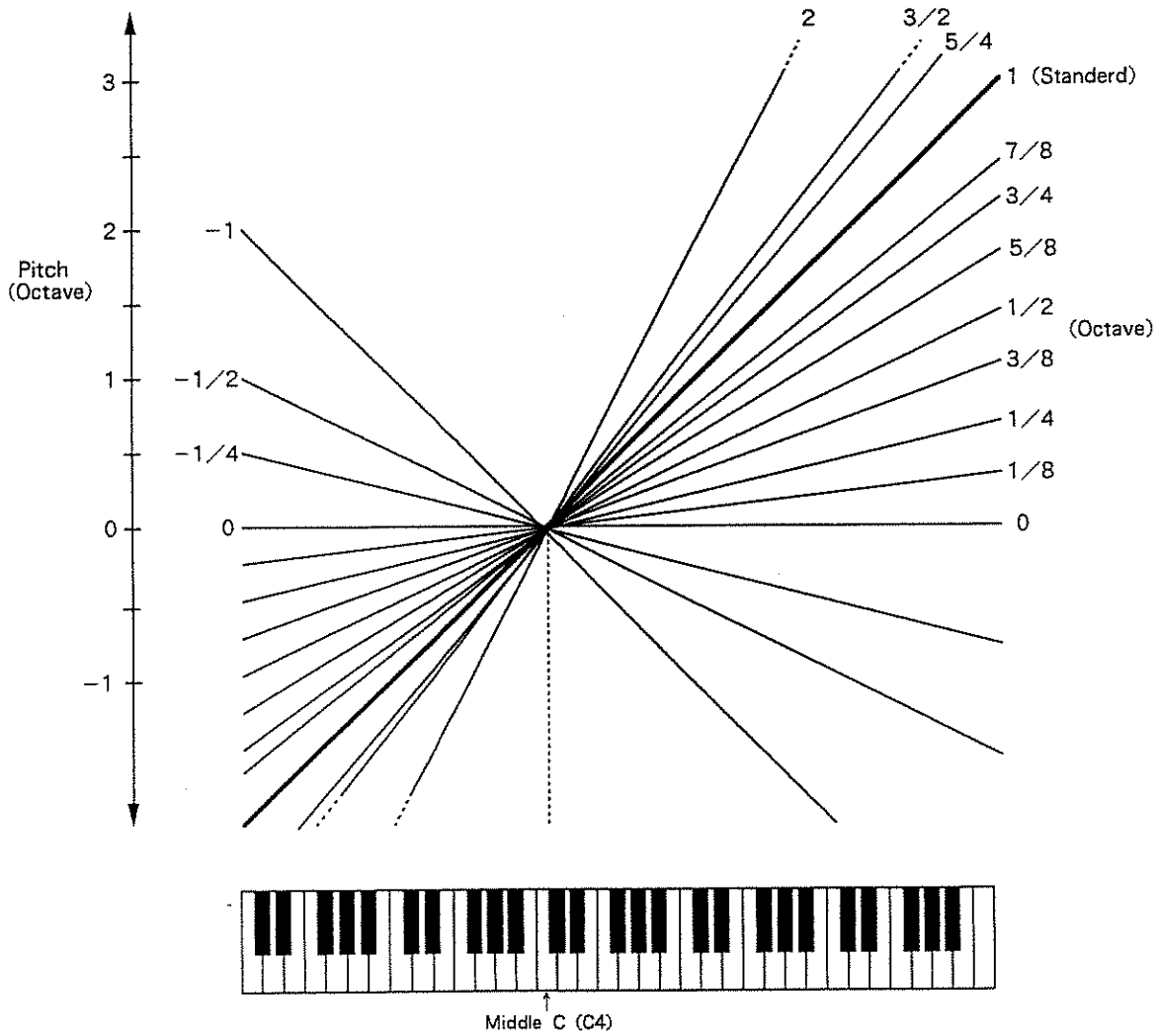

● Bias Point/Level

You can add a further change (=bias level) to the Key Follow curve from any point (key).

Bias Point

```
TVF Bias Point
<C4 <C4 <C4 <C4
```

This sets the range (point and direction) where the bias level is valid, from <A1 to <C7 and from >A1 to >C7 in semi-tone steps.

[e.g.] >C4: The bias level is valid on the keyboard above the C4 key.
<C4: The bias level is valid on the keyboard below the C4 key.

Bias Level

```
TVF Bias Level
00 00 00 00
```

This bias level can be set from -7 to +7/ "+" values raise the curve, and "-" values lower the curve.

[Example]

When set to TVF Key Follow (Cutoff Point) "0" and Bias Point "> C4".

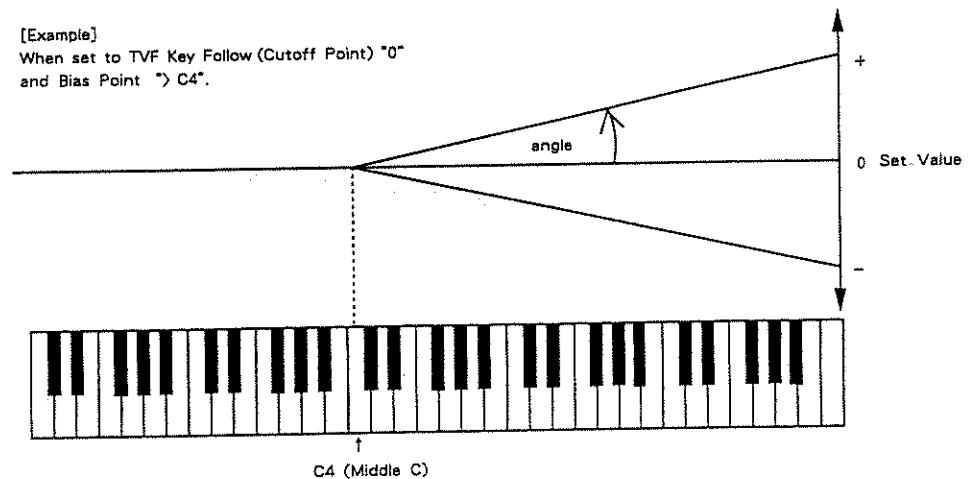

*The curve shown in the picture represents the Key Follow value with the Bias Level added.

● ENV Depth

```
TVF ENV Depth
50 50 50 50
```

This sets the depth of the TVF ENV modulation that changes the TVF Cutoff point. 0 to 100 are valid. At higher values the effect is deeper.

● ENV Velocity Sensitivity

```
TVF ENV Velocity
50 50 50 50
```

This sets the sensitivity of the velocity that controls the depth of the TVF ENV. 0 to 100 are valid. At higher values, the effect is deeper by playing the keyboard harder.

● ENV Key Follow (Depth)

```
TVF ENV Depth KF
00 00 00 00
```

This can change the TVF ENV depth depending on the key played. 0 to 4 are valid, higher values change the depth more drastically.

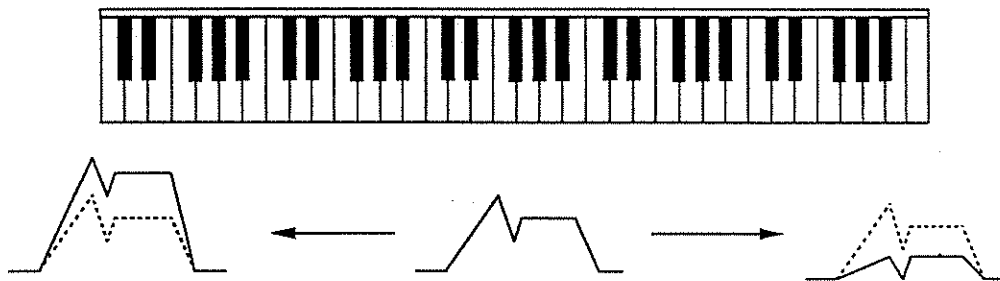

6) TVF ENV

● ENV Key Follow (Time)

TVF	ENV	Time	KF
00	00	00	00

This can change the time of the TVF ENV depending on the key played. 0 to 4 are valid, higher values changing the time more drastically.

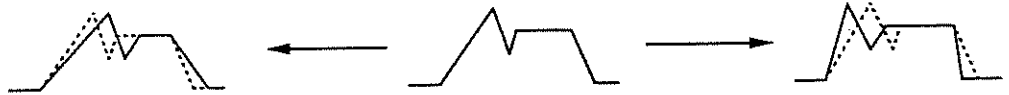

● ENV Time/Level

These parameters are the time needed for the envelope curve of cutoff frequencies to move from one point to another, and the level of the cutoff frequencies at a certain point.

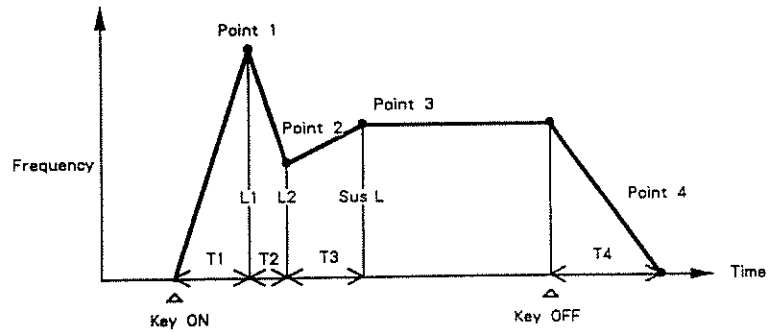

Time 1/Time 2/Time 3/ Time 4

TUF	ENV	Time 1	
50	50	50	50

TUF	ENV	Time 2	
50	50	50	50

TUF	ENV	Time 3	
50	50	50	50

TUF	ENV	Time 4	
50	50	50	50

This sets the time needed from one point to another, from 0 to 100.

Level 1/Level 2/Sustain Level

TUF	ENV	Level 1	
50	50	50	50

TUF	ENV	Level 2	
50	50	50	50

TUF	ENV	Sus Level	
50	50	50	50

This sets the level of a certain point from 0 to 100.

*If the level of two adjacent points are set to similar values, the time between these two points may prove to be shorter than what is actually set, or even zero.

7) TVA Level

● Level **PCM**

```
TVA Level
50 50 50 50
```

This sets the volume of a Partial from 0 to 100.

*Higher values may cause sound distortion. If so, lower the value.

*Even when this is set to zero here, the sound may not be completely muted if the TVA ENV curve is high.

● Velocity Sensitivity **PCM**

```
TVA Velocity
00 00 00 00
```

This sets the sensitivity of the velocity that controls the volume of the sound from -50 to +50. "-" values lower the level by harder playing, and "+" values raise the level by harder playing.

● Bias Point/Level **PCM**

You can add a further change (=bias level) to the volume level from any point (key).

Bias Point

```
TVA Bias Point 1
<C4 <C4 <C4 <C4
```

```
TVA Bias Point 2
<C4 <C4 <C4 <C4
```

This sets the range (point and direction) where the bias level is valid at two positions (keys), from <A1 to <C7 and from >A1 to >C7 in semi-tone steps.

[e.g.] >C4: The bias level is valid on the keyboard above the C4 key.

<C4: The bias level is valid on the keyboard below the C4 key.

Bias Level

```
TVA Bias Level 1
 00 00 00 00
```

```
TVA Bias Level 2
 00 00 00 00
```

This bias level can be set from 0 to -12. Lower values lower the curve.

8 [Example]
 When set the Bias Point 1 to "<C3" and
 the Bias Point 2 to "<C6".

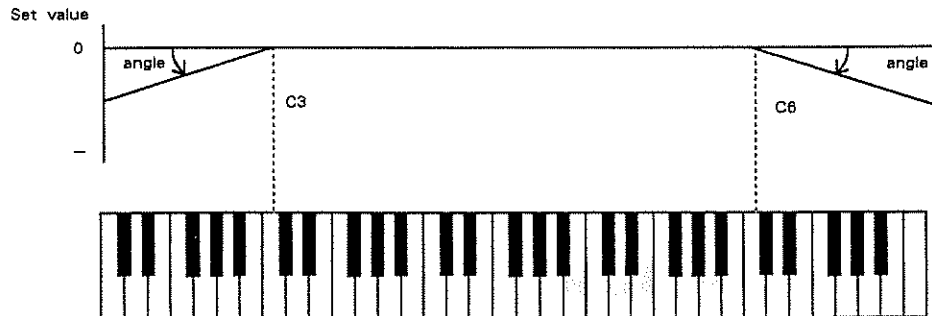

● ENV Velocity Follow (Time 1)

PCM

TVA	ENV	T1	Uelo
00	00	00	00

This sets the maximum effect of the velocity that controls the time of the TVA ENV from 0 to 4. At higher values, Time 1 will be shortened by playing the keyboard harder.

8) TVA ENV

● ENV Key Follow (Time)

PCM

```
TVA ENV Time KF
 00 00 00 00
```

This sets the time of the TVA ENV depending on the key played, from 0 to 4. Higher values change the time more drastically.



● ENV Time/Level

PCM

These parameters are the time needed for a volume curve to move from one point to another, and the volume of a certain point.

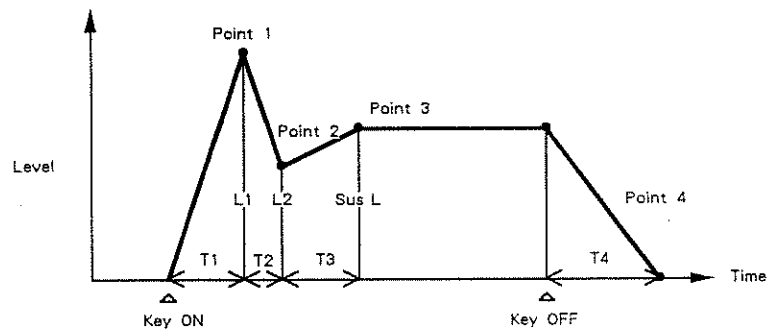

Time 1/Time 2/Time 3/ Time 4

TVA	ENU	Time	1
50	50	50	50

TVA	ENU	Time	2
50	50	50	50

TVA	ENU	Time	3
50	50	50	50

TVA	ENU	Time	4
50	50	50	50

This sets the time needed for the curve to move from one point to another, from 0 to 100.

Level 1/Level 2/Sustain Level

TVA	ENU	Level	1
50	50	50	50

TVA	ENU	Level	2
50	50	50	50

TVA	ENU	Sus	Levl
50	50	50	50

This sets the volume of a certain point from 0 to 100.

*If the level of two adjacent points are set to similar values, the time between these two points may prove to be shorter than what is actually set, or even zero.

d. Writing Procedure

The edited data does not rewrite the previous data, and therefore will be erased when a different Tone is selected or the unit is turned off. To retain the edited data, take the following writing procedure, either into the internal memory or onto a memory card (M-256D, M-256E).

***Writing a new Tone will replace the corresponding Tone in each Patch and Timbre, therefore, the sound will change.**

1) Writing into the internal memory

To write the edited Tone into a location in the internal memory, do as follows.

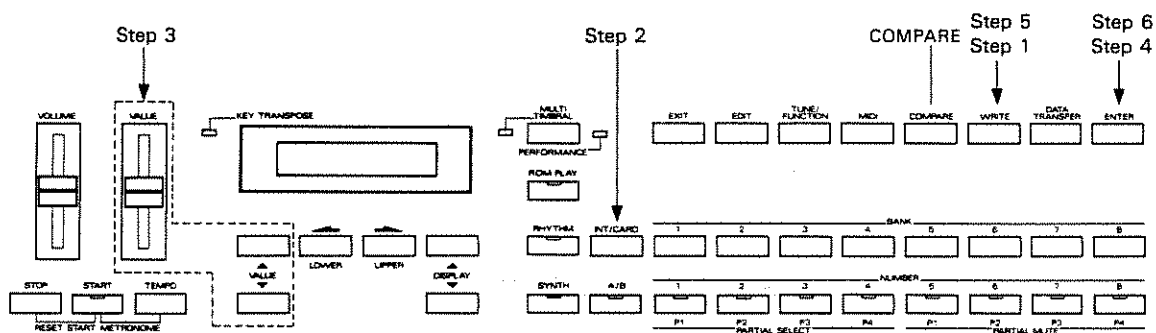

Step 1 Push the Write Button.

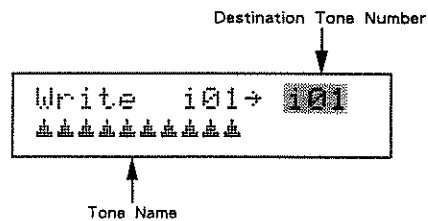

***When you have edited a Preset Tone, the destination Tone number is not indicated.**

Step 2 Select "i" by pushing the Internal/Card Button.

Step 3

To change the destination Tone number, use the Value Control Knob.

If you wish to listen to the destination Tone before rewriting it, do as follows.

① Push the Compare Button.

```
Compare to 161
▲▲▲▲▲▲▲▲▲▲▲▲▲▲▲▲
```

② Select the destination Tone using the Value Control Knob.

Now, the destination Tone can be heard by playing the keyboard.

③ Push the Compare Button to return to the previous Display.

Step 4

Push the Enter Button.

```
Turn Protect off
once? Write/Exit
```

Step 5

Push the Write Button.

The Memory Protect is released, and the Display returns to that of Step 3.

Step 6

Push the Enter Button.

When writing is completed, the Display responds as shown below, then returns to the Play Mode Display.

```
Complete
```

*If the writing procedure is not properly completed, the Display shows an Error Message. If this happens, resolve it as explained on page 150 "Error Messages".

2) Writing onto a memory card

*When using a brand new memory card, be sure to copy the entire data in the internal memory onto the card as explained on page 127 "Saving".

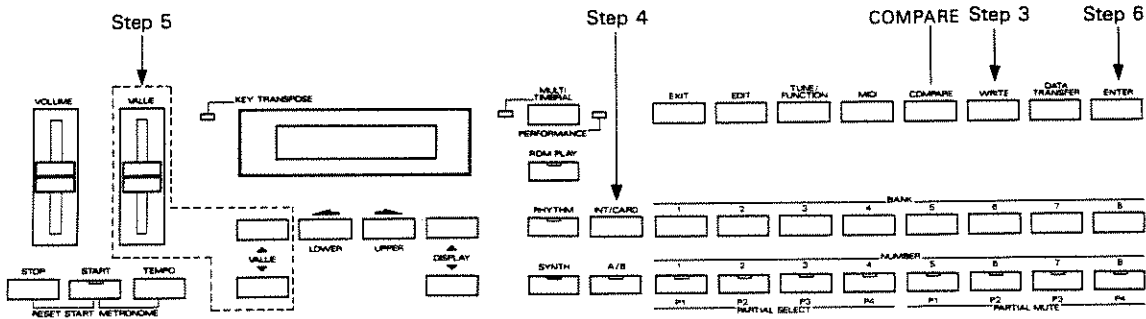

- Step 1 Insert a memory card into the Card Slot.
- Step 2 Set the Protect Switch on the memory card to OFF.

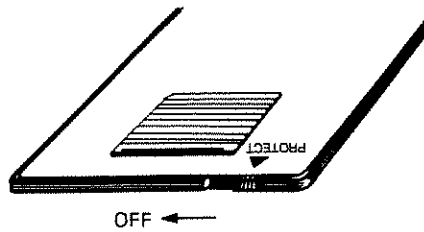

- Step 3 Push the Write Button.

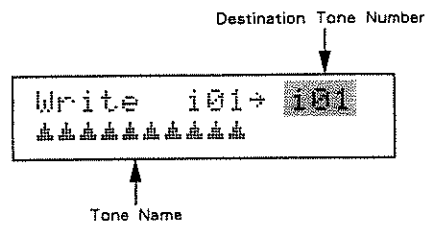

*When you have edited a Preset Tone, the destination Tone number is not indicated.

Step 4 Select "c" by pushing the Internal/Card Button.

Step 3 To change the destination Tone number, use the Value Control Knob.

If you wish to listen to the destination Tone before rewriting it, do as follows.

① Push the Compare Button.

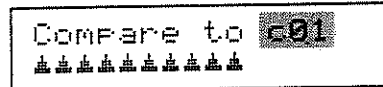

② Select the destination Tone using the Value Control Knob.

Now, the destination Tone can be heard by playing the keyboard.

③ Push the Compare Button to return to the previous Display.

Step 6 Push the Enter Button.

When writing is completed, the Display responds as shown below, then returns to the Play Mode Display.

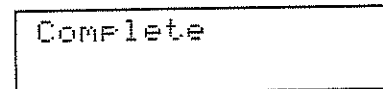

*If the writing procedure is not properly completed, the Display shows an Error Message. If this happens, resolve it as explained on page 150 "Error Messages".

Step 7 Set the Protect Switch on the memory card back to the ON position.

3 MIDI IN THE PERFORMANCE MODE

This sections describes how to use MIDI devices in the Performance mode and how to set the MIDI Functions.

1. Performance Mode

The following diagram shows how performance messages run in the Performance mode.

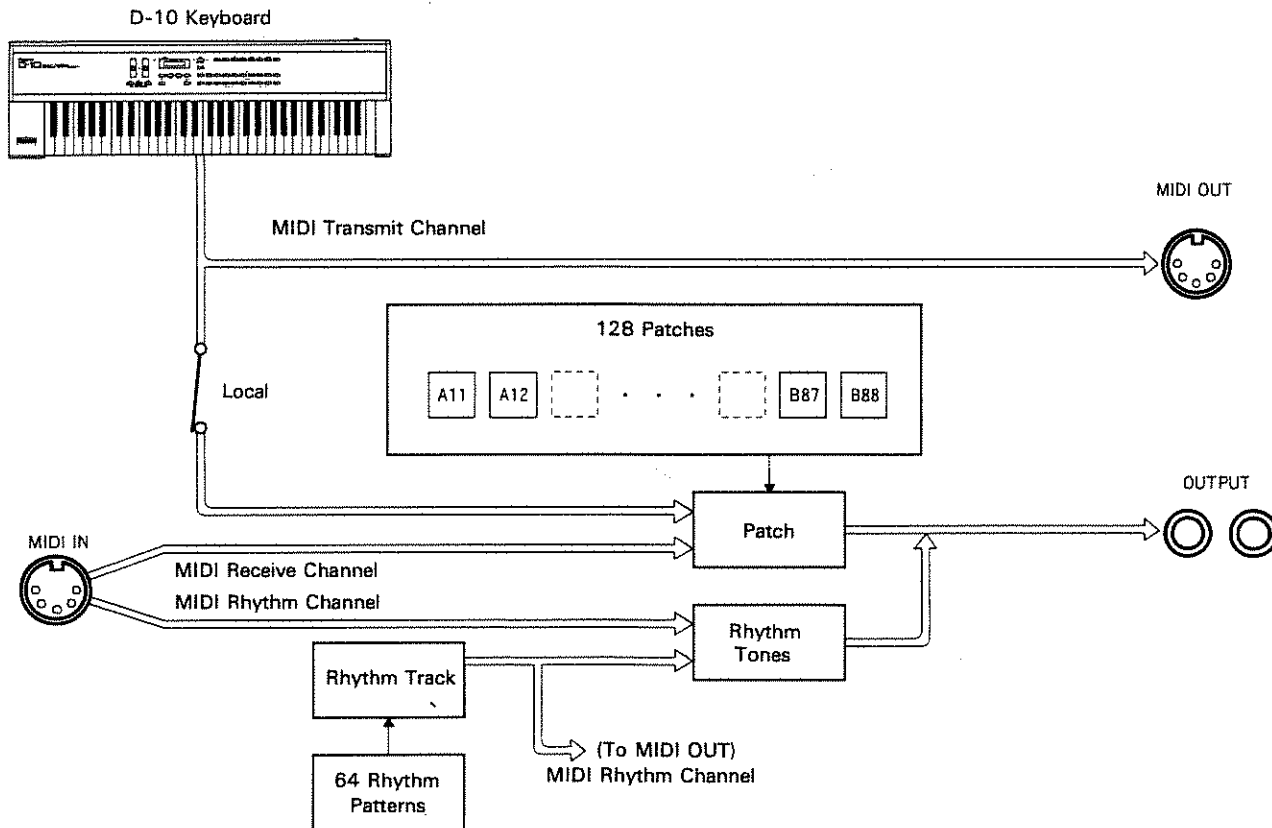

- Performance messages are sent through MIDI OUT on the set MIDI transmit channel.
- Performance messages of a Rhythm Track or Rhythm Pattern are sent through MIDI OUT on the MIDI Rhythm channel.
- Performance messages received at MIDI IN play the relevant sound source. Performance messages received on a MIDI receive channel play the synthesizer sound module, and those received on the MIDI Rhythm channel play Rhythm sounds.

2. Applications

This section explains how to use MIDI devices in the Performance mode with some examples.

a. Examples

The following are examples for using the Performance mode effectively.

[Using a MIDI sound module with the D-10]

○To play the D-10 and an external MIDI sound module from the D-10's keyboard.

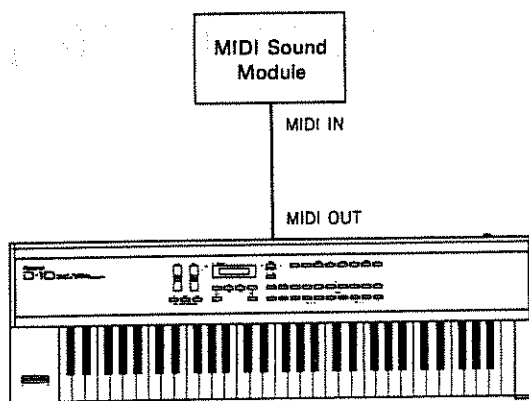

(e.g.)
D-10 Transmit Channel MIDI Sound Module
ch 1 → ch 1

[Using the D-10 as a MIDI sound module]

○The Rhythm sound module of the D-10 playing by an external rhythm machine.

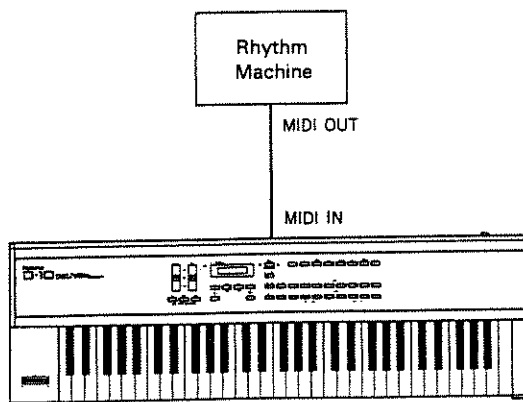

(e.g.)
D-10 Transmit Channel Rhythm Machine
ch10 ← ch10

- The Synthesizer sound module of the D-10 playing by an external MIDI sequencer.

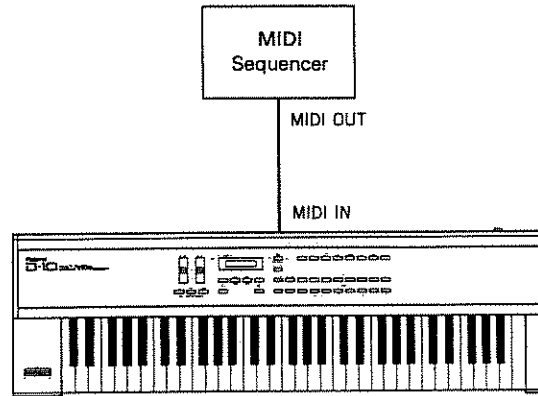

(e.g.)
Sequencer Data D-10 Receive Channel
ch 1 → ch 1

b. Sync

When performing ensemble pieces using a MIDI sequencer's data and the D-10's Rhythm data, the tempo of the two devices should be the same speed. That is, one of the two devices should become a slave device to synchronize to the other (=master device).

*Sync signals can be received or transmitted regardless of the MIDI channel setting.

[Using the D-10 as a Master]

Set the external device (=slave) so that it can receive the sync signals sent from the D-10 (=master).

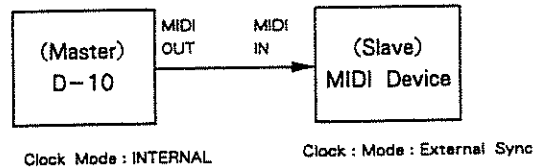

*The D-10 is normally set to the internal mode.

[Using the D-10 as a Slave]

Set the D-10 (=slave) so that it can receive the sync signal sent from the external device (=master).

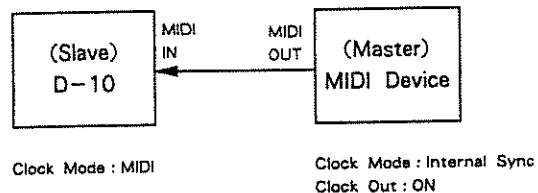

When the D-10 is set to the MIDI mode, [tempo] will be shown as below, and the D-10 can no longer control the tempo.

```

↓=MIDI
Rthm 50 M.M. 50
  
```

[Clock Mode Setting]

To enter the Clock mode, do as follows.

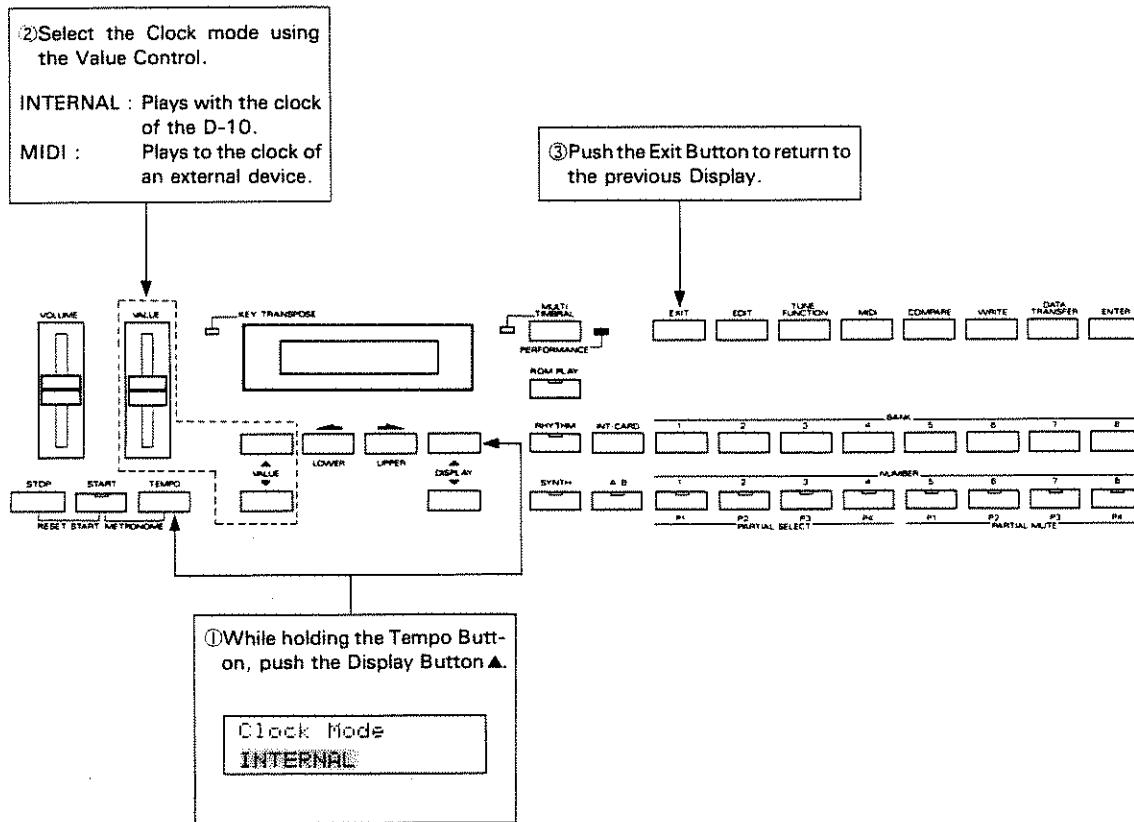

*The Clock mode you have set will be retained even when the unit is turned off.

*If you do not wish to use the Rhythm section of the D-10 but use the Rhythm Part as a MIDI sound module, be sure to set the D-10 to the Internal mode. This is to prevent the Rhythm section from playing in sync with the signal from the external device.

*When the Stop message is received while setting the Clock mode to MIDI, a performance will stop at the end of the bar receiving the Stop message.

2. MIDI Function Setting

This section describes how to set the MIDI functions in the Performance mode.

First, make sure that the Performance Indicator is lit, then do as follows.

*The edited value will be retained in memory except for a few functions.

[Editing Procedure]

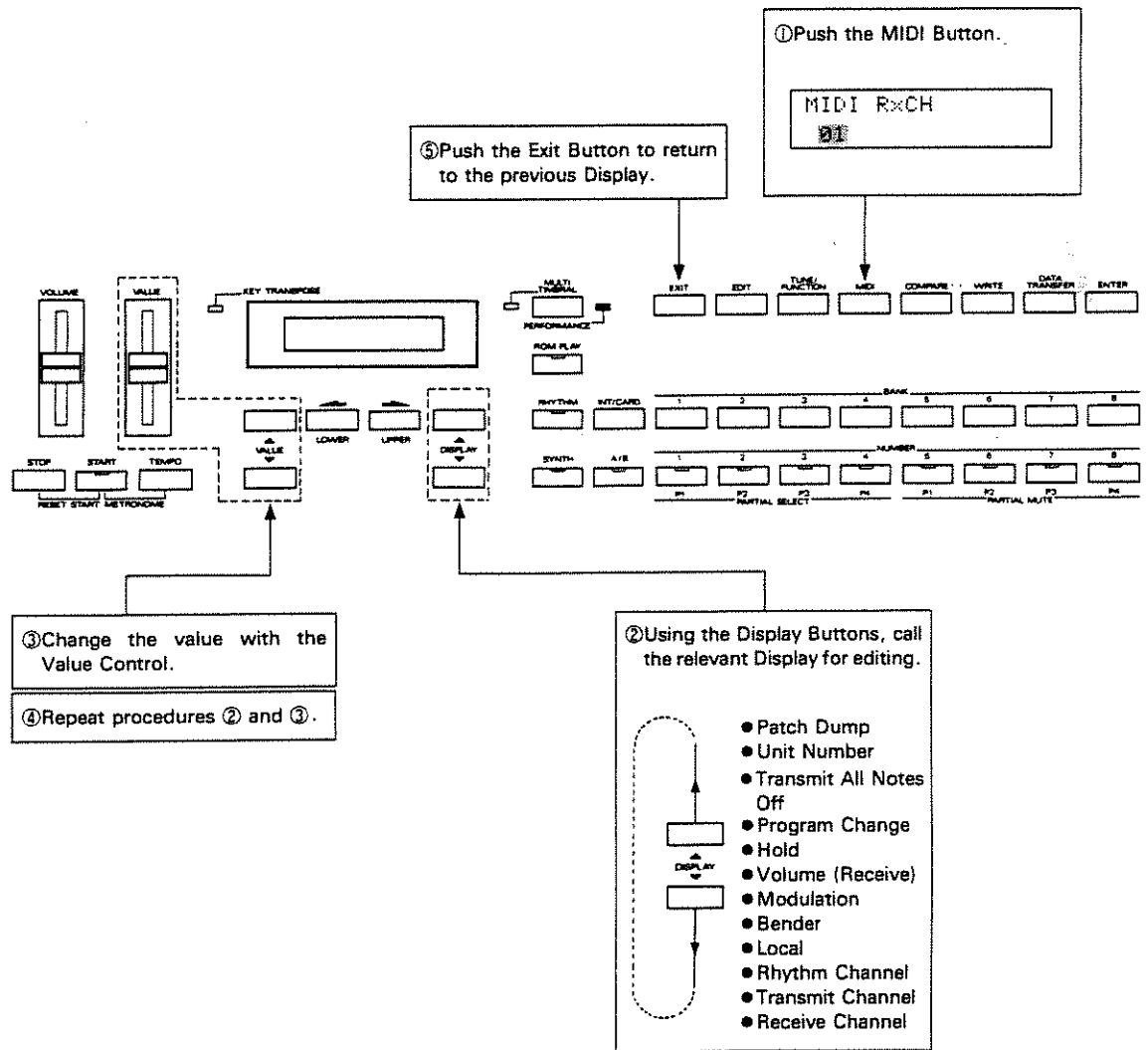

[MIDI Functions]● **MIDI Receive Channel**

MIDI R×CH 01

This is the MIDI channel on which the performance messages for the synthesizer sound source are received. 1 to 16 are valid.

● **MIDI Transmit Channel**

MIDI T×CH 01

This sets the the MIDI channel on which the keyboard performance messages are sent. 1 to 16 are valid.

● **MIDI Rhythm Channel**

MIDI Rhythm CH 10

This sets the MIDI channel on which the rhythm performance messages are transmitted or received. 1 to 16 are valid.

***Changing Rhythm channels here will automatically change the Rhythm Part channel in the Multi Timbral mode.**

***Rhythm performance data cannot be transmitted unless the Clock Mode is set to Internal.**

● **Local**

MIDI Local ON

This selects whether to divide the keyboard (or panel controls) and sound module sections or not. When OFF, the messages such as keyboard performance messages are sent through MIDI OUT, muting the synthesizer sound source in the D-10 completely. However, this does not prevent the performance messages received through MIDI IN from controlling the D-10's synthesizer section.

***Local ON is always selected at power-up.**

● **Bender**

```
MIDI Bender
ON
```

Set this to ON to receive or transmit Bender messages.

● **Modulation**

```
MIDI Modulation
ON
```

To receive or transmit Modulation messages, set this to ON.

● **Volume (Receive)**

```
MIDI Rx Volume
ON
```

Set this to ON to receive Volume messages.

● **Hold**

```
MIDI Hold
ON
```

Set this to ON to receive or transmit Hold messages.

● **Program Change**

```
MIDI Prog. Change
ON
```

Set this to ON to receive or transmit Program Change messages.

Program Change numbers correspond to the D-10's Tones as shown below. A Program Change number select the corresponding Tone in the Internal or on the Memory Card.

Group	Number	1	2	3	4	5	6	7	8
	Bank								
A	1	1	2	3	4	5	6	7	8
	2	9	10	11	12	13	14	15	16
	3	17	18	19	20	21	22	23	24
	4	25	26	27	28	29	30	31	32
	5	33	34	35	36	37	38	39	40
	6	41	42	43	44	45	46	47	48
	7	49	50	51	52	53	54	55	56
	8	57	58	59	60	61	62	63	64
B	1	65	66	67	68	69	70	71	72
	2	73	74	75	76	77	78	79	80
	3	81	82	83	84	85	86	87	88
	4	89	90	91	92	93	94	95	96
	5	97	98	99	100	101	102	103	104
	6	105	106	107	108	109	110	111	112
	7	113	114	115	116	117	118	119	120
	8	121	122	123	124	125	126	127	128

*Number 0 to 127 are used as Program Change Messages in the actual MIDI Format.

*The Program Change messages cannot switch the Internal and Memory Card modes.

● Transmit All Notes Off

MIDI TX All N-Off
ON

Set this to OFF if you do not wish to transmit All Notes Off messages.

*The Transmit All Notes Off setting is retained in the Multi Timbral Mode.

*The Transmit All Notes Off setting will be automatically set to ON when the unit is turned off.

● Unit Number

MIDI Exclu Unit# 17

A Unit Number is a number used to identify an external device instead of the MIDI channel number, when data is received or transmitted using Exclusive messages (only for Roland ID number). So, it is possible to send or receive Exclusive messages by matching the Unit numbers of two devices. OFF and 17 to 32 are valid, and at OFF, the Exclusive messages cannot be communicated. When using a programmer, be sure not to select OFF.

*Even when sending or receiving Exclusive messages on a MIDI channel, do not set this to OFF but any number from 17 to 32.

*The Unit Number you have set is retained even in the the Multi Timbral mode.

*The Unit Number you have set will be automatically returned to 17 when the unit is turned off.

● Patch Dump

MIDI Patch Dump OFF

The Patch Dump function transmits the sound data of a certain Patch using Exclusive messages. Using this function, sound data can be recorded in a sequencer together with performance data. In this way, the original Patch will always be retrieved even after it is edited on the D-10. In the Patch Dump function, the Exclusive messages is transmitted with the Unit number.

*If you change the value of the Patch Dump, the Timbre Dump setting (see page 19) in the Multi Timbral mode will be also changed automatically.

*The Patch Dump you have set will be automatically returned to OFF when the unit is turned off.

4 DATA TRANSFER

The entire data in the internal memory can be copied onto a memory card, or the entire data on a memory card into the internal memory. Also, using Roland MIDI Exclusive messages, the data can be transferred from one D-10 to another D-10.

*If an **Error Message** is shown in the Display, resolve it by following the "Error Message" on page 150.

1. Data Transfer using a memory card

The entire data in the internal memory of the D-10 can be copied on a memory card. This is called saving. Copying data on a memory card into the internal memory is called loading.

[Data which can be saved]

The optional memory card (M-256D, M-256E) can store the following data.

All	Sound	Patches : 128 (A11-88, B11-88)
		Timbres : 128 (A11-88, B11-88)
		Tones : 64 (c1-64)
	Rhythm	Rhythm Patterns : 32 (P-51-88)
		Rhythm Track : 1
		Rhythm Setup

The Data Transfer function of the D-10 allows you to divide the above data into two blocks, Sound data and Rhythm data, copying them separately. Normally, use the All mode.

a. Saving

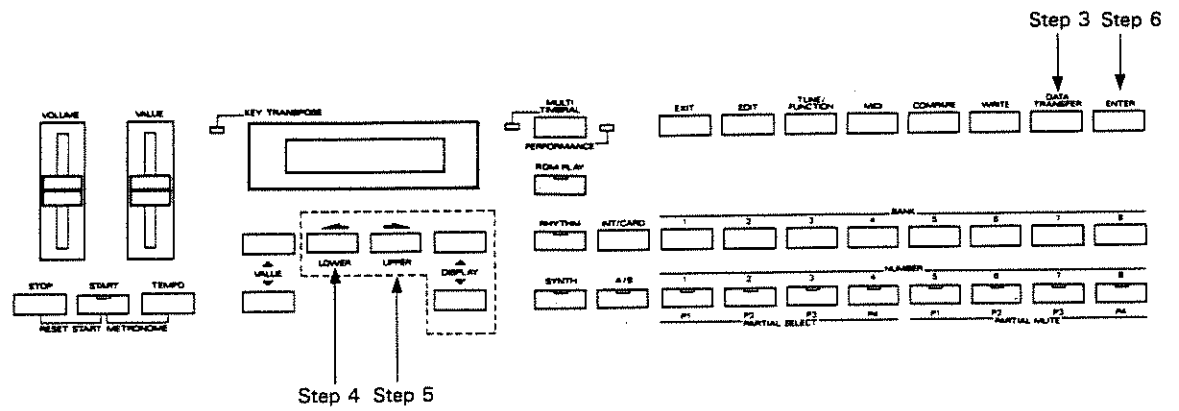

- Step 1 Insert a memory card into the Card Slot.
- Step 2 Set the Protect Switch on the memory card to OFF.

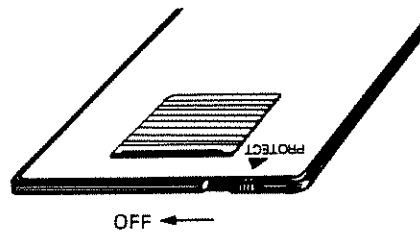

- Step 3 Push the Data Transfer Button.

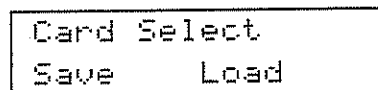

- Step 4 Push the Cursor Button on the left.

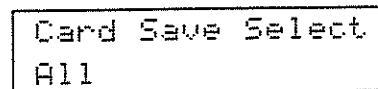

Step 5 Select the data to be saved.

○To save the entire data in memory, push either of the Cursor Buttons.

```

Card Save Select
All
    
```

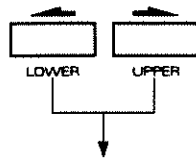

```

Card Save      All
Sure?          Enter
    
```

○To save either of the data blocks, Sound data or Rhythm data, push either of the Display Buttons, and assign the data block using the Cursor Buttons.

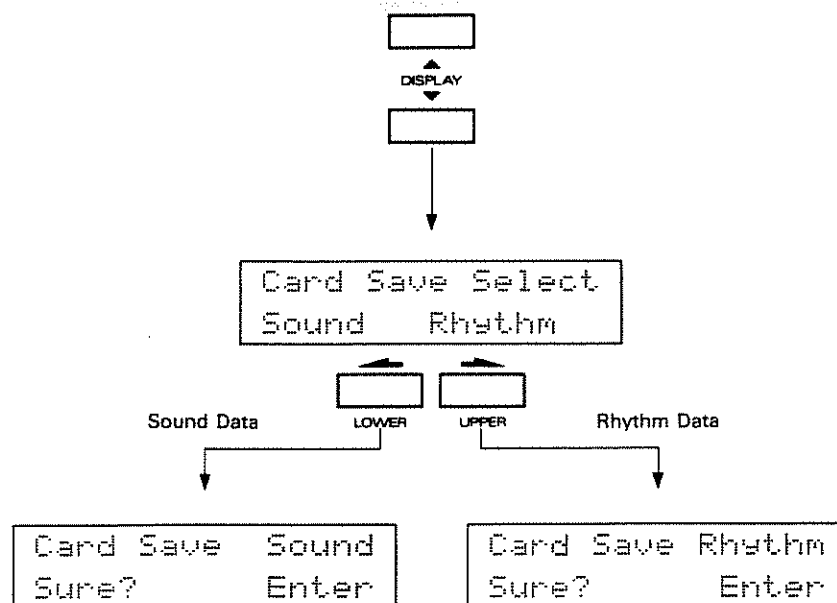

*If you are using a memory card which has never been used for writing data, "All" is the only alternative.

Step 6 Push the Enter Button.

When data is properly saved, the Display responds as below for a while and returns to the previous Display (before the data transfer procedure was used).

Complete

If you are using a memory card which has never been used for writing data, the following is shown in the Display. If so, push the Enter Button again.

Illegal Card
Enter

*If an Error Message is shown in the Display, resolve it by following the "Error Messages" on page 150.

Step 7 Return the Protect Switch on the memory card to ON.

b. Loading

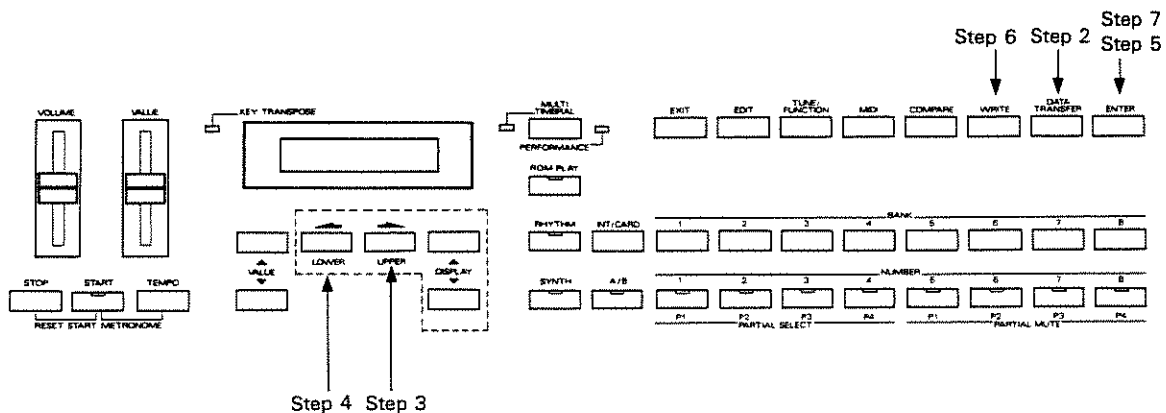

Step 1 Insert a memory card into the Card Slot.

Step 2 Push the Data Transfer Button.

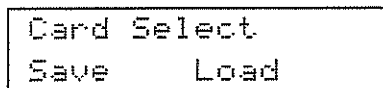

Step 3 Push the Cursor Button on the right.

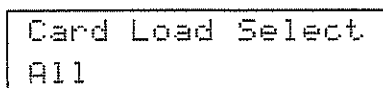

Step 4 Select the data to be loaded.

○To copy the entire data, push either of the Cursor Buttons.

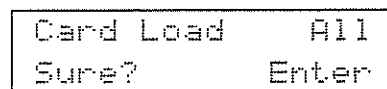
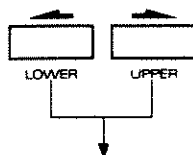
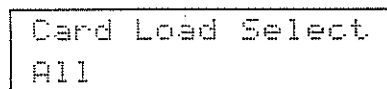

○To copy Rhythm or Sound block, push either of the Display Buttons, then assign the block using the Cursor Buttons.

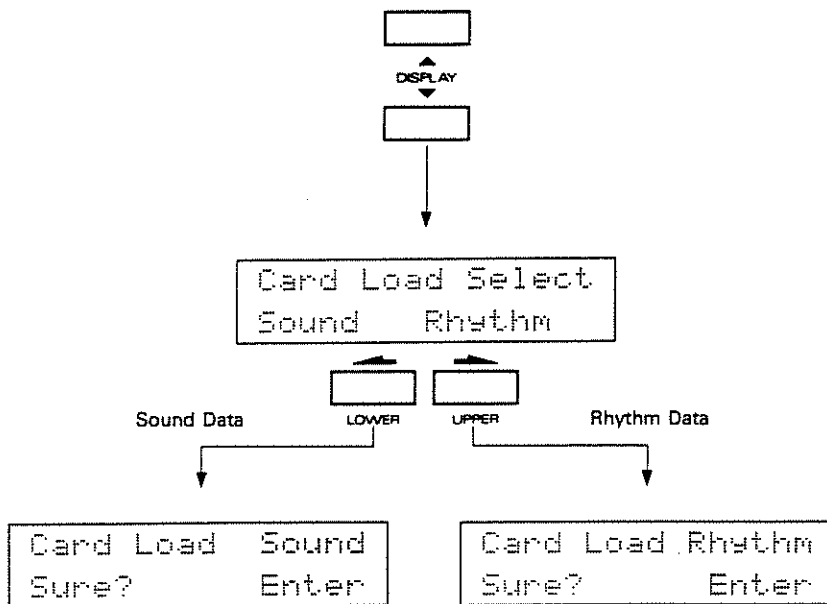

Step 5 Push the Enter Button.

```

  Turn Protect off
  once? Write/Exit
  
```

Step 6 Push the Write Button.

The Memory Protect is released, and the Display returns to that of Step 4.

Step 7 Push the Enter Button.

When the data is properly loaded, the Display responds as shown below for a while, then returns to the previous Display (before the loading procedure was taken).

```

  Complete
  
```

***If an Error Message is shown in the Display, resolve it by following the "Error Messages" on page 150.**

2. Data Transfer with MIDI

Using Roland MIDI Exclusive messages, the data can be transferred from one D-10 to another D-10.

[Data which can be transferred]

The Data Transfer function of the D-10 allows you to divide the entire data into two blocks separately, Sound data and Rhythm data.

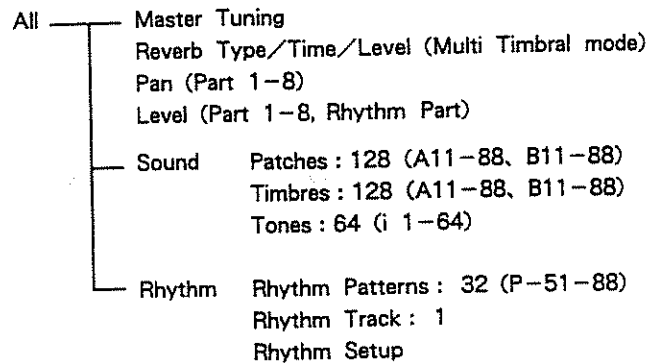

[How to transfer data]

There are two methods of data transfer via MIDI; Handshake and One-way.

- Handshake allows you to verify whether the receiver is ready to receive the data.

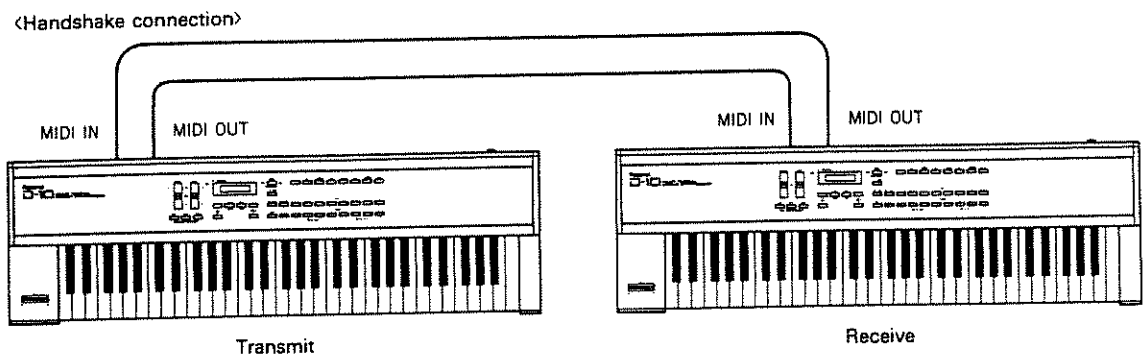

○One-way transfers the data without confirming the condition of the receiver. The D-10 allows you to select either of the two methods.

<One-way Connection>

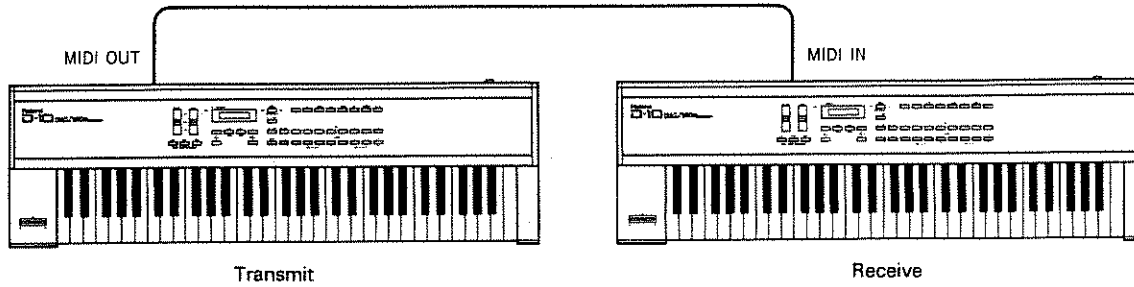

[Procedure]

Step 1 Set the Unit number of the receiver and transmitter to the same number.

- ① Push the MIDI Button.
- ② Push the Display Button until the Display responds as below.

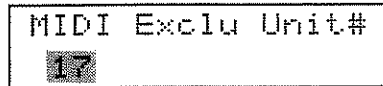

③ Set the Unit number using the Value Control Knob.

Step 2 Push the Data Transfer Buttons on both the receiver and transmitter.

Step 3 Push the Display Buttons on both the receiver and transmitter until the Display responds as shown below.

<One-way>

```

One-way Bulk
DUMP      Load
    
```

<Handshake>

```

Handshake Bulk
DUMP      Load
    
```

(The following procedure is common for both One-way and Handshake.)

Step 4 Push the Cursor Button on the left on the transmitter and the right on the receiver.

<Transmit>

```

H-shake DUMP Sel
All
    
```

<Receive>

```

H-shake Load Sel
All
    
```

Step 5 Match the data group of the receiver and transmitter.

○ To transfer the entire data, push either of the Cursor Buttons.

<Transmit, Receive>

```

H-shake ▲▲▲▲ Sel
All
    
```

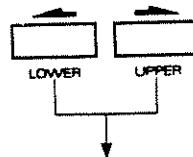

```

H-shake ▲▲▲▲ All
Sure?      Enter
    
```

○To transfer Rhythm or Sound block, push either of the Display Buttons, then assign the block using the Cursor Buttons.

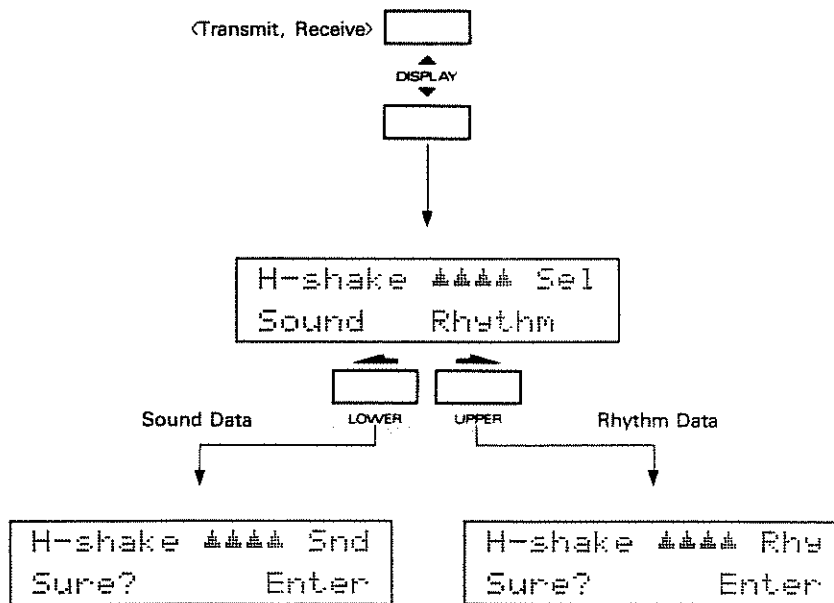

Step 6 Push the Enter Button on the receiver.

```

  Turn Protect off
  once? Write/Exit
  
```

Step 7 Push the Write Button on the receiver.

The Memory Protect function is cancelled, and the Display returns to that of Step 5.

Step 8 Push the Enter Button on the receiver.

Now, the receiver unit is ready.

```

  H-shake Load ▲▲▲
  Waiting
  
```

Step 9 Push the Enter Button on the transmitter.

When the data is properly copied, the Display responds as shown below for a while, then returns to the previous Display (before the data transfer procedure was taken).

Complete

*if an Error Message is shown in the Display, resolve it by following the "Error Messages" on page 150.

5 LA Synthesis

LA stands for Linear Arithmetic synthesis which is the heart of the new technology. LA synthesis involves a great many technological advances resulting not only in a superior sound quality but also an improved ease of programming. In this way, Roland has succeeded in maintaining a high degree of familiarity to the user despite the technical wizardry involved.

1. What is sound made of ?

[Three elements of a sound]

Sounds are air vibrations reaching our ears. By transforming the vibration into digital signals, it would become visible as a "wave".

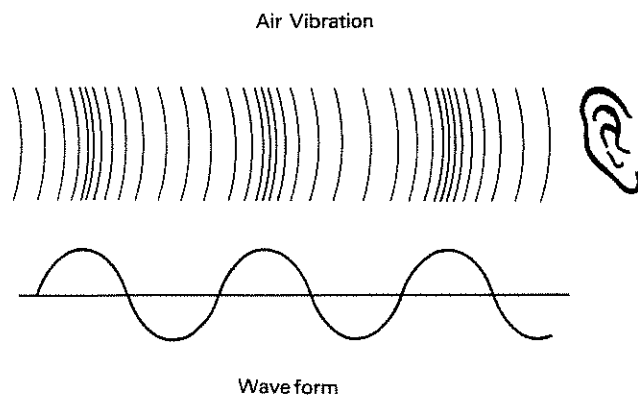

Basically, all sorts of sounds can be considered to consist of "pitch", "timbre" and "volume".

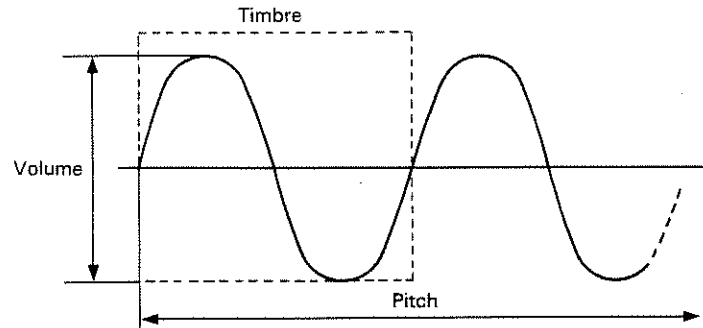

- (1) Pitch is determined by the number of waves (=frequencies). Higher frequencies raise the pitch. Usually, pitch (frequency) is represented by Hz.



Low pitch



High pitch

- (2) Timbre is determined by the shape of a wave. Generally speaking, round shaped waves make soft sounds, and sharp shapes make hard sounds.



Soft tone



Hard tone

- (3) Volume is determined by the depth of a wave (=amplitude). Larger waves produce higher volumes.



Low volume

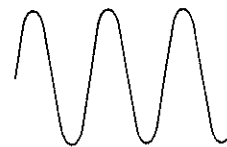

High volume

[Harmonics]

Timbre is determined by the shape of a wave. Then, how is the shape of a wave made ? It is believed that a waveform is made by a great many sine waves. For example, a sawtooth is made by adding sine waves of all the possible multiples to the fundamental sine wave. A square wave is made by odd number multiples added to the fundamental.

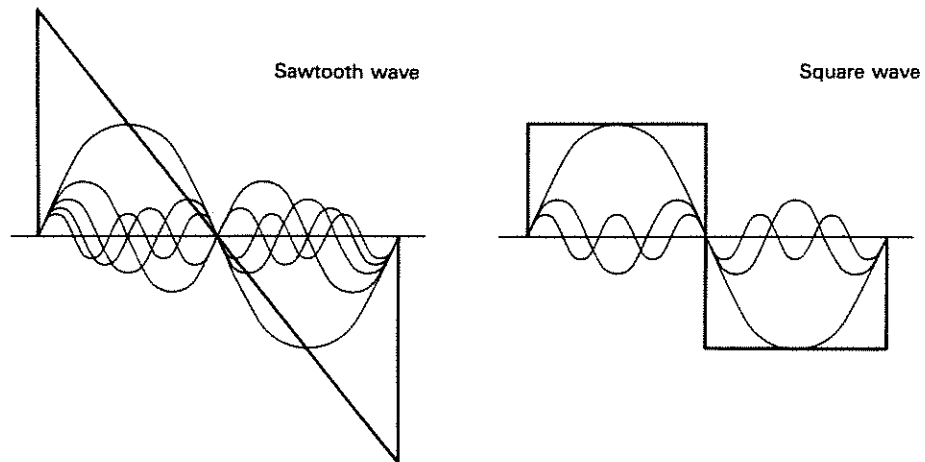

The waves added to the fundamental are called "harmonics"; even number multiple harmonics and odd number multiple harmonics. A timbre, in brief, is determined by the harmonic content.

[Envelope]

Each of the three elements, pitch, timbre and volume, has its own envelope curve. Each instrument sound has a different envelope.

Envelope of an instrument volume

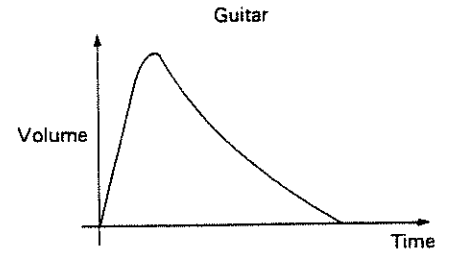
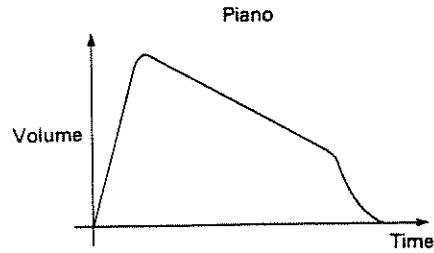
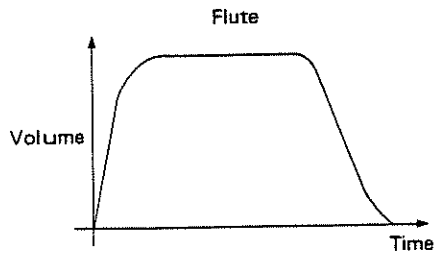
**[Natural Sounds]**

A natural sound consists of various different sounds. For example, a piano consists of a sharp attack sound then a decay sound. These two are completely different sounds. Also, the timbre of a piano decay sound varies depending on the pitch.

2. Understanding LA Synthesis

The LA system allows you to combine various different sections when making a sound. In other words, each independent Partial makes its own sound, and are then combined (synthesized).

The Structure may be the most important parameter of the D-10, as it decides how to combine the Partials.

a. Structure

Please study the following examples.

13 Structures may be divided into two groups, with the ring modulator, and without.

[Structures that do not use Ring Modulators]

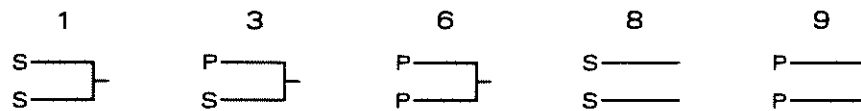

Structure 1/3/6

These can be combined as follows.

- (1) By setting each Partial the same, and detuning slightly, a fat sound can be created. Also, shifting the pitch by one octave or a 5th may be effective. This is suitable for strings or organ sounds.

- (2) To make a realistic sound, use the PCM sound generators for attack sounds. For example, to create a wind instrument sound, make a blowing sound with the PCM generator, then the sustained sound with a PCM loop or synthesizer generator.

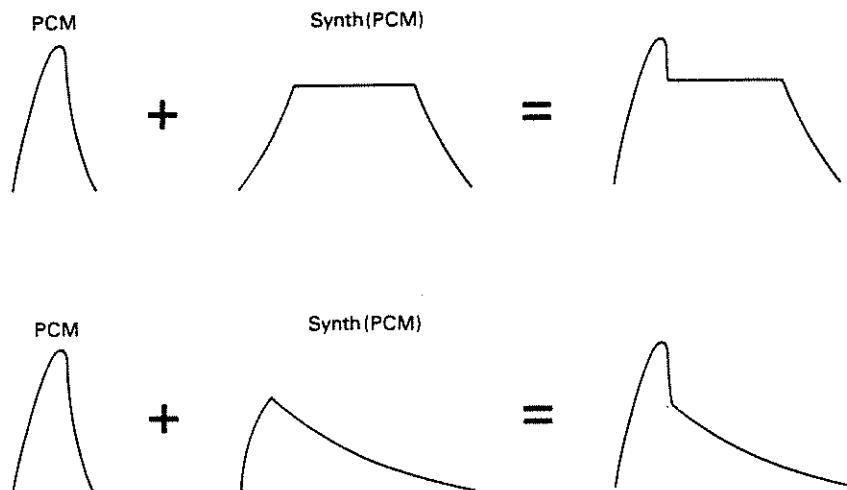

- (3) Make a bright and dark sound in each Partial separately, then reverse the polarity of the TVA Velocity. Then the tone can be altered by changing how you play the keyboard.

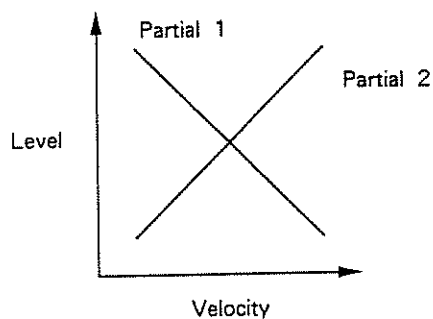

- (4) Make the upper and lower section sounds in each Partial separately, then reverse the bias setting of the TVA. Then different tones can be heard by changing the sound range.

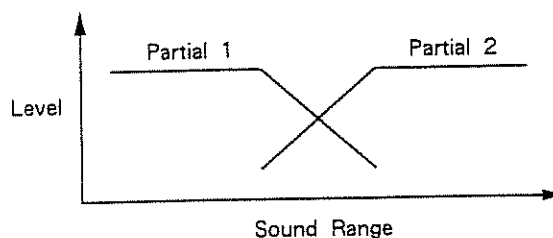

Structure 8/9

These are useful for creating stereo effects. However, the pan setting loses effect in this Structure, so the sound image cannot be changed. (See page 75.)

[Using the Ring Modulator]

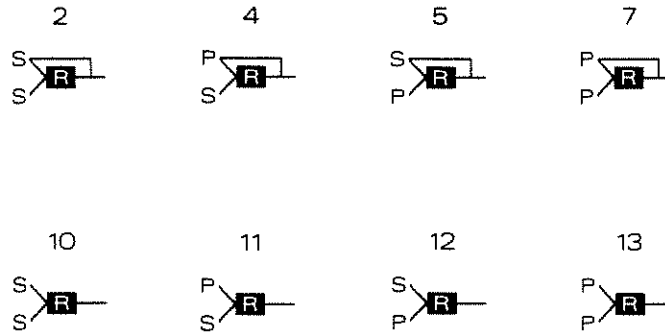

The Ring Modulator cross-modulates two Partial resulting harmonics that are fractional multiples of the fundamental. The key points to using Ring Modulation are as follows.

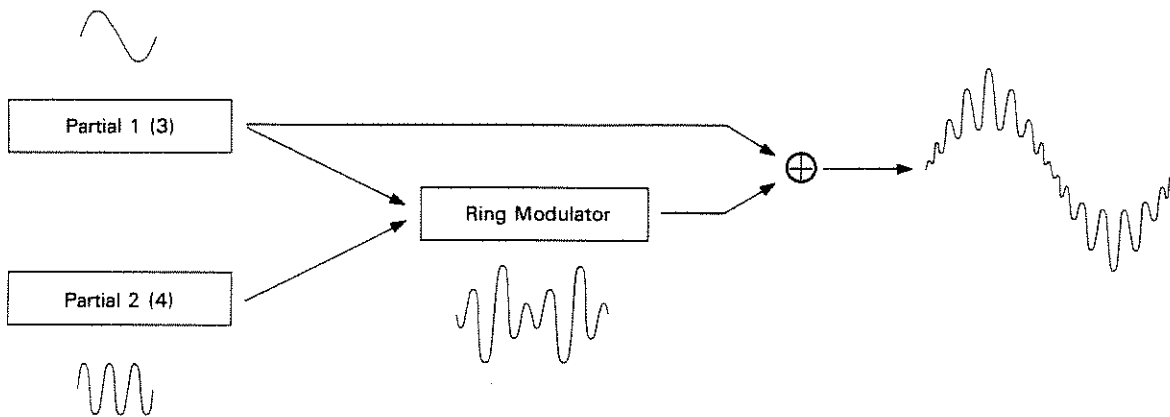

- When the output of either Partial is muted, the other Partial is automatically sent.
- Partial 1 (3) always behaves as a fundamental and Partial 2 (4) as harmonic content.
- Partial 1 (3) controls the overall volume.
- When the pitch ratio of Partial 2 (4) is a multiple of the fundamental, a clear sound is obtained. To create a transparent metallic sound, make Partial 1 (3) as near to a sine wave as possible.

PCM sounds normally include many odd multiple harmonics, and therefore can become too "muddy" when using the Ring Modulator. Do not set the TVA level of Partial 2 (4) too high.

b. The Editing Procedure

For easier and quicker editing, select a Tone which is similar to the sound you wish to make. Then set the D-10 to the Edit mode, and check the following points to study how the Partials are being used. If you roughly understand the structure of the Partials, you can tell which Partials should be edited.

☐ Check the Partial Mute

The Partial Mute is one of the parameters, therefore is written in memory together with other parameters. The muted Partial is not being used.

☐ Check how each Partial works

Using the Partial Mute function, listen to the sound of each Partial in use. You may pay attention to how sounds change depending on the sound range, or by the velocity. When using the Ring Modulator, muting one of the Partials will automatically output the other Partial.

☐ Check the Structure

Using the Structure number, you can check how each Partial functions and how the Partials are combined.

6 TROUBLE INFORMATION

1. Before calling for Service

The D-10 features so many functions that it may not always react as you expect. The cause may lie in the amplifier used, or something equally as simple. Before calling for service, please check the following.

No sound is heard or the volume is too low :

- Check if the volume is set too low.
- Check if you can hear sound through the headphones. If not, there is something wrong with the cords or external device.
- Check if the LOCAL (MIDI function) is set to OFF (in the Performance mode).
[See page 122.]
- Check if the keyboard transmit channel is set to the same number as the MIDI channel of the relevant Part (in the Multi Timbral mode).
[See page 18.]
- Check if the volume of the relevant Part is set too low (in the Multi Timbral mode).
[See page 23.]
- Check if the MIDI Volume messages sent from the external MIDI device to the D-10 are not too low.
If so, push the Mode Button twice to return the MIDI Volume to the maximum once.

Rhythm sound is not heard/Rhythm is not start :

- Check if the volume of the rhythm is set too low.
[See page 22 in Basic Course.]
- Check if the Clock mode is set to MIDI.
[See page 120 if in the Performance mode.]
[See page 10 if in the Multi Timbral mode.]

No metronome sound is heard :

- Check if the volume of the metronome is set too low.
[See page 29 in Basic Course.]
- Check if the Metronome mode is correctly set.
[See page 31 in Basic Course.]

Pitch is not normal :

○Check if the Key Transpose has been altered.
[See page 33 in Basic Course, if in the Performance mode.]
[See page 24 if in the Multi Timbral mode.]

○Check if the Master Tuning is correct.
[See page 32 in Basic Course, if in the Performance mode.]
[See page 21 if in the Multi Timbral mode.]

***If the pitch of a certain Patch/Timbre is strange, the cause will lie in the setting of that Patch/Timbre or Tone.**

A Patch/Timbre cannot be selected :

○Check if the ROM Play or Rhythm indicator is lit.
If so, push the Synth Button.

○Check if the D-10 is set to the Play mode. If it is set to any other mode such as to the Edit mode, push the Exit Button.

The effect of the Pan setting does not appear to be correct :

○Check if you are using a Tone made by one Partial. A Tone made by only one Partial has only 8 Pan levels.

○Check if the Structure of the Tone Parameters is set to 8 or 9.
When the Structure is set to 8 or 9, each Partial has a different pan setting.
[See page 75.]

MIDI Messages are not correctly communicated :

○Check if the MIDI Functions on the receiver and transmitter are set correctly.

[See page 121 if in the Performance mode.]

[See page 17 if in the Multi Timbral mode.]

The Programmer does not seem to work properly :

○Check if the Unit numbers of the Programmer and the D-10 are set to the same number.

[See page 125 if in the Performance mode.]

[See page 19 if in the Multi Timbral mode.]

2. Error Messages

When there is something wrong with the procedure you have taken or the D-10 itself, an Error Message will be shown in the Display. If so, resolve it as follows.

***If the same error message is shown repeatedly even though there is no mistake in your operation, call your local Roland service center.**

Error Messages about the battery back-up

Check
Internal Battery

○The battery for memory backup of the D-10 is low. Call your local Roland service center.

Check
Card's Battery

○The battery for memory backup in the memory card (M-256D, M-256E) is low. Replace with a new one (CR2016) by following the instructions supplied with the memory card.

Error Messages shown during the Play mode

Card Not Ready

○The memory card is not connected to the D-10 correctly. Insert the memory card into the Card Slot securely and correctly.

Illegal Card

○You are using a brand new memory card or a memory card for other than the D-10, D-20 or D-110. Take the "Saving" procedure explained on page 127. (The D-110's memory card cannot be used in the Performance mode.)

MIDI Buffer Full

○You have tried to process data exceeding the internal memory capacity and the D-10 will return to the same condition when turn unit on.

Error Messages shown during Rhythm Track Recording

Memory Full

- You are recording more than 500 bars.

Error Messages shown during Writing or Data Transfer

Turn Protect off
once? Write/Exit

- The Memory Protect function on the D-10 is set to ON. To release the Protect function here, push the Write Button, then the Enter Button.
To leave this mode, push the Exit Button.

Insert Card

- The memory card is not securely connected to the D-10. Insert the memory card securely into the Card Slot, then push the Enter Button.
To leave this mode, push the Exit Button.

Card Protected

- The Protect Switch of the memory card is set to ON. Set it to OFF, then push the Enter Button.
To leave this mode, push the Exit Button.

Illegal Card

- You are using a brand new memory card or a memory card for other than the D-10 or D-20. Replace the card with a proper one, then push the Enter Button. If you wish to leave this mode, push the Exit Button.

Illegal Card
Enter

- You are using a brand new memory card or a memory card for other than the D-10 or D-20. Pushing the Enter Button will execute saving.
If you wish to leave the saving mode, push the Exit Button.

Card Error
Exit

- The data is not properly written. Push the Exit Button, then repeat the procedure.

No Data

- The Memory card doesn't contain the designated data (e.g. you are loading the patch data from the card for the D-110). Replace the card with a proper one, repeat the procedure.

MIDI Communicat
Error Exit

- Data Transfer has not been correctly done. Push the Exit Button, check the connections, then repeat the Data Transfer procedure.

Data Mismatch
Exit

- Data setting on the receiver does not match the transmitter's. Push the Exit Button, then repeat the Data Transfer procedure.

No Space

- You are saving the unfit data for that card (e.g. the patch data or the rhythm pattern/track data for the D-110's card). Replace the card with a proper one, repeat the procedure.

7 APPENDIX TABLES

1. Tables

a. Performance Mode

Tune/Function	Value
Master Tune *1	428 ... 453Hz
Memory Protect *1*2	ON, OFF
Key Transpose *1	-12 ... 0 ... +12

MIDI Function	Value
MIDI RxCH	1 ... 16
MIDI TxCH	1 ... 16
MIDI Rhythm CH *1	1 ... 16
MIDI Local *2	ON, OFF
MIDI Bender	ON, OFF
MIDI Modulation	ON, OFF
MIDI Rx Volume	ON, OFF
MIDI Hold	ON, OFF
MIDI Program Change	ON, OFF
MIDI Tx All Notes Off *1*2	ON, OFF
MIDI Unit No. *1*2	OFF, 17 ... 32
MIDI Patch Dump *1*2	ON, OFF

*1 These parameters are available in the Multi Timbral Mode.

*2 Switching the unit on always defaults to preprogrammed values.

Memory Protect ON
MIDI Local ON
MIDI Tx All Notes OFF .. ON
MIDI Unit No. 17
MIDI Patch Dump OFF

Patch Parameter	Value
Key Mode	WHOLE, DUAL, SPLIT
Split Point	C2 ... C#7
Tone Select (Lower/Upper)	a1 ... 64, b1 ... 64 i (c) 1 ... 64, r1 ... 63, OFF
Key Shift (Lower/Upper)	-24 ... 0 ... +24
Fine Tune (Lower/Upper)	-50 ... 0 ... +50
Bender Range (Lower/Upper)	0 ... 24
Assign Mode (Lower/Upper)	1, 2, 3, 4
Reverb Switch (Lower/Upper)	ON, OFF
Reverb Type	1 : SMALL ROOM 2 : MEDIUM ROOM 3 : MEDIUM HALL 4 : LARGE HALL 5 : PLATE 6 : DELAY 1 7 : DELAY 2 8 : DELAY 3 OFF
Reverb Time	1 ... 8
Reverb Level	0 ... 7
Tone Balance (Lower/Upper)	0 ... 100
Patch Level	0 ... 100
Patch Name (16 Letters)	Space, A ... Z, a ... z, 0 ... 9, & # ! ? . , ; ' " * + - / < = >

b. Multi Timbral Mode

Tune/Function	Value
Master Tune *1	428 ... 453Hz
Memory Protect *1*2	ON, OFF
Split Point	C2 ... C#7
Reverb Type	1: SMALL ROOM 2: MEDIUM ROOM 3: MEDIUM HALL 4: LARGE HALL 5: PLATE 6: DELAY 1 7: DELAY 2 8: DELAY 3 OFF
Reverb Time	1 ... 8
Reverb Level	0 ... 7
Part 1 ... 8 Pan Level	7> ... >< ... <7 0 ... 100
Key Transpose *1	-12 ... 0 ... +12

MIDI Function	Value
MIDI Part RxCH (Part 1 ... 8)	1 ... 16
MIDI Rhythm Part CH *1	1 ... 16
MIDI Keyboard TxCH (Lower/Upper)	1 ... 16
MIDI Tx All Notes Off *1*2	ON, OFF
MIDI Unit No. *1*2	OFF, 17 ... 32
MIDI Timbre Dump *1*2	ON, OFF

Timbre Parameter	Value
Tone Select	a1 ... 64, b1 ... 64, i (c) 1 ... 64, r1 ... 63, OFF
Key Shift	-24 ... 0 ... +24
Fine Tune	-50 ... 0 ... +50
Bender Range	0 ... 24
Assign Mode	1, 2, 3, 4
Reverb Switch	ON, OFF

- :1 These parameters are available in the Performance Mode.
- :2 These parameters are always set to the default values when the unit is turned on.
Memory Protect ON
MIDI Tx All Notes Off .. ON
MIDI Unit No. 17
MIDI Patch Dump OFF

c. Tone Parameter

Parameter Group	PCM	Parameter	Value
Common	○	Tone Name (10 Letters)	SPACE, A ... Z, a ... z, 0 ... 9, & # ! ? . , : ; ' " * + - / < = >
		Structure 1&2	1 ... 13
		Structure 3&4	1 ... 13
		ENV Mode	NORMAL, NO SUSTAIN
WG Pitch/Mod (Partial 1/2/3/4)	○	Pitch Coarse	C1, C#1 ... C9
		Pitch Fine	-50 ... 0 ... +50
		Keyfollow (Pitch)	-1, -1/2, -1/4, 0, 1/8, 1/4, 3/8, 1/2, 5/8, 3/4, 7/8, 1, 5/4, 3/2, 2, sl, s2
		LFO Rate	0 ... 100
		LFO Depth	0 ... 100
		Modulation Sensitivity	0 ... 100
		Bender Switch	ON, OFF
WG Form (Partial 1/2/3/4)	×	Waveform	SQUARE, SAWTOOTH
	○	PCM Wave Bank	1, 2
		PCM Wave No.	1 ... 128
	×	Pulse Width	0 ... 100
		PW Velocity Sensitivity	-7 ... 0 ... +7
Pitch ENV (Partial 1/2/3/4)	○	ENV Depth	0 ... 10
		ENV Velocity Sensitivity	0 ... 3
		ENV Keyfollow (Time)	0 ... 4
Pitch ENV (Partial 1/2/3/4)	○	Time 1/2/3/4	0 ... 100
		Level 0/1/2/End	-50 ... 0 ... +50
TVF Frequency (Partial 1/2/3/4)	×	Cutoff Frequency	0 ... 100
		Resonance	0 ... 30
		Keyfollow (Frequency)	-1, -1/2, -1/4, 0, 1/8, 1/4, 3/8, 1/2, 5/8, 3/4, 7/8, 1, 5/4, 3/2, 2
		Bias Point	<A1 ... <C7, >A1 ... >C7
		Bias Level	-7 ... 0 ... +7
TVF ENV (Partial 1/2/3/4)	×	ENV Depth	0 ... 100
		ENV Depth Velocity Sensitivity	0 ... 100
		ENV Keyfollow (Depth)	0 ... 4
TVF ENV (Partial 1/2/3/4)	×	ENV Keyfollow (Time)	0 ... 4
		Time 1/2/3/4	0 ... 100
		Level 1/2/Sustain	0 ... 100
TVA Level (Partial 1/2/3/4)	○	Level	0 ... 100
		Velocity Sencitivity	-50 ... 0 ... +50
		Bias Point 1	<A1 ... <C7, >A1 ... >C7
		Bias Level 1	-12 ... 0
		Bias Point 2	<A1 ... <C7, >A1 ... >C7
		Bias Level 2	-12 ... 0
		ENV Velocity Follow (T1)	0 ... 4
TVA ENV (Partial 1/2/3/4)	○	ENV Keyfollow (Time)	0 ... 4
		Time 1/2/3/4	0 ... 100
		Level 1/2/Sustain	0 ... 100

*The Partial Mute status is shown in the Number (5-8) Button's Indicator.

d. PCM Sounds

Bank 1

No.	PCM Name	Remarks
1	Bass Drum-1	Rhythm Sound
2	Bass Drum-2	
3	Bass Drum-3	
4	Snare Drum-1	
5	Snare Drum-2	
6	Snare Drum-3	
7	Snare Drum-4	
8	Tom Tom-1	
9	Tom Tom-2	
10	High-Hat	
11	High-Hat (Loop)	
12	Crash Cymbal-1	
13	Crash Cymbal-2 (Loop)	
14	Ride Cymbal-1	
15	Ride Cymbal-2 (Loop)	
16	Cup	
17	China Cymbal-1	
18	China Cymbal-2 (Loop)	
19	Rim Shot	
20	Hand Clap	
21	Mute High Conga	
22	Conga	
23	Bongo	
24	Cowbell	
25	Tambourine	
26	Agogo	
27	Claves	
28	Timbale High	
29	Timbale Low	
30	Cabasa	
31	Timpani Attack	Attack Sound
32	Timpani	
33	Acoustic Piano High	
34	Acoustic Piano Low	
35	Piano Forte Thump	
36	Organ Percussion	
37	Trumpet	
38	Lips	
39	Trombone	
40	Clarinet	
41	Flute High	
42	Flute Low	
43	Steamer	
44	Indian Flute	
45	Breath	
46	Vibraphone High	
47	Vibraphone Low	
48	Marimba	
49	Xylophone High	
50	Xylophone Low	
51	Kalimba	
52	Wind Bell	
53	Chime Bar	
54	Hammer	
55	Guero	
56	Chink	
57	Nails	
58	Fretless Bass	
59	Pull Bass	
60	Slap Bass	
61	Thump Bass	
62	Acoustic Bass	
63	Electric Bass	
64	Gut Guitar	

No.	PCM Name	Remarks
65	Steel Guitar	
66	Dirty Guitar	
67	Pizzicato	
68	Harp	
69	Contrabass	
70	Cello	
71	Violin-1	
72	Violin-2	
73	Koto	
74	Draw bars (Loop)	Sustained Sound
75	High Organ (Loop)	
76	Low Organ (Loop)	
77	Trumpet (Loop)	
78	Trombone (Loop)	
79	Sax-1 (Loop)	
80	Sax-2 (Loop)	
81	Reed (Loop)	
82	Slap Bass (Loop)	
83	Acoustic Bass (Loop)	
84	Electric Bass-1 (Loop)	
85	Electric Bass-2 (Loop)	
86	Gut Guitar (Loop)	
87	Steel Guitar (Loop)	
88	Electric Guitar (Loop)	
89	Clav (Loop)	
90	Cello (Loop)	
91	Violin (Loop)	
92	Electric Piano-1 (Loop)	
93	Electric Piano-2 (Loop)	
94	Harpsichord-1 (Loop)	
95	Harpsichord-2 (Loop)	
96	Telephone Bell (Loop)	
97	Female Voice-1 (Loop)	
98	Female Voice-2 (Loop)	
99	Male Voice-1 (Loop)	
100	Male Voice-2 (Loop)	
101	Spectrum-1 (Loop)	
102	Spectrum-2 (Loop)	
103	Spectrum-3 (Loop)	
104	Spectrum-4 (Loop)	
105	Spectrum-5 (Loop)	
106	Spectrum-6 (Loop)	
107	Spectrum-7 (Loop)	
108	Spectrum-8 (Loop)	
109	Spectrum-9 (Loop)	
110	Spectrum-10 (Loop)	
111	Noise (Loop)	
112	Shot-1	Decay Sound
113	Shot-2	
114	Shot-3	
115	Shot-4	
116	Shot-5	
117	Shot-6	
118	Shot-7	
119	Shot-8	
120	Shot-9	
121	Shot-10	
122	Shot-11	
123	Shot-12	
124	Shot-13	
125	Shot-14	
126	Shot-15	
127	Shot-16	
128	Shot-17	

Bank 2

No.	PCM Name	Remarks	No.	PCM Name	Remarks
1	Bass Drum-1*	Rhythm Sound (The pitch is not affected by Master Tuning.)	65	Loop-35	
2	Bass Drum-2*		66	Loop-36	
3	Bass Drum-3*		67	Loop-37	
4	Snare Drum-1*		68	Loop-38	
5	Snare Drum-2*		69	Loop-39	
6	Snare Drum-3*		70	Loop-40	
7	Snare Drum-4*		71	Loop-41	
8	Tom Tom-1*		72	Loop-42	
9	Tom Tom-2*		73	Loop-43	
10	High-Hat*		74	Loop-44	
11	High-Hat* (Loop)		75	Loop-45	
12	Crash Cymbal-1*		76	Loop-46	
13	Crash Cymbal-2* (Loop)		77	Loop-47	
14	Ride Cymbal-1*		78	Loop-48	
15	Ride Cymbal-2* (Loop)		79	Loop-49	
16	Cup*		80	Loop-50	
17	China Cymbal-1*		81	Loop-51	
18	China Cymbal-2* (Loop)		82	Loop-52	
19	Rim Shot*		83	Loop-53	
20	Hand Clap*		84	Loop-54	
21	Mute High Conga*		85	Loop-55	
22	Conga*		86	Loop-56	
23	Bongo*		87	Loop-57	
24	Cowbell*		88	Loop-58	
25	Tambourine*		89	Loop-59	
26	Agogo*		90	Loop-60	
27	Claves*		91	Loop-61	
28	Timbale High*		92	Loop-62	
29	Timbale Low*		93	Loop-63	
30	Cabasa*		94	Loop-64	
31	Loop-1	Effect Sound (Repeats of the same sound.)	95	Jam-1 (Loop)	Effect Sound (Repeats of combined sounds)
32	Loop-2		96	Jam-2 (Loop)	
33	Loop-3		97	Jam-3 (Loop)	
34	Loop-4		98	Jam-4 (Loop)	
35	Loop-5		99	Jam-5 (Loop)	
36	Loop-6		100	Jam-6 (Loop)	
37	Loop-7		101	Jam-7 (Loop)	
38	Loop-8		102	Jam-8 (Loop)	
39	Loop-9		103	Jam-9 (Loop)	
40	Loop-10		104	Jam-10 (Loop)	
41	Loop-11		105	Jam-11 (Loop)	
42	Loop-12		106	Jam-12 (Loop)	
43	Loop-13		107	Jam-13 (Loop)	
44	Loop-14		108	Jam-14 (Loop)	
45	Loop-15		109	Jam-15 (Loop)	
46	Loop-16		110	Jam-16 (Loop)	
47	Loop-17		111	Jam-17 (Loop)	
48	Loop-18		112	Jam-18 (Loop)	
49	Loop-19		113	Jam-19 (Loop)	
50	Loop-20		114	Jam-20 (Loop)	
51	Loop-21		115	Jam-21 (Loop)	
52	Loop-22		116	Jam-22 (Loop)	
53	Loop-23		117	Jam-23 (Loop)	
54	Loop-24		118	Jam-24 (Loop)	
55	Loop-25		119	Jam-25 (Loop)	
56	Loop-26		120	Jam-26 (Loop)	
57	Loop-27		121	Jam-27 (Loop)	
58	Loop-28		122	Jam-28 (Loop)	
59	Loop-29		123	Jam-29 (Loop)	
60	Loop-30		124	Jam-30 (Loop)	
61	Loop-31		125	Jam-31 (Loop)	
62	Loop-32		126	Jam-32 (Loop)	
63	Loop-33		127	Jam-33 (Loop)	
64	Loop-34		128	Jam-34 (Loop)	

e. Preset Rhythm Tones

No.	Tone Name	Number of Partials
r01	Closed High Hat-1	1
r02	Closed High Hat-2	1
r03	Open High Hat-1	2
r04	Open High Hat-2	2
r05	Crash Cymbal	2
r06	Crash Cymbal (short)	1
r07	Crash Cymbal (mute)	1
r08	Ride Cymbal	2
r09	Ride Cymbal (short)	1
r10	Ride Cymbal (mute)	1
r11	Cup	2
r12	Cup (mute)	1
r13	China Cymbal	2
r14	Splash Cymbal	1
r15	Bass Drum-1	2
r16	Bass Drum-2	1
r17	Bass Drum-3	2
r18	Bass Drum-4	1
r19	Snare Drum-1	1
r20	Snare Drum-2	1
r21	Snare Drum-3	1
r22	Snare Drum-4	2
r23	Snare Drum-5	1
r24	Snare Drum-6	1
r25	Rim Shot	1
r26	Brush-1	2
r27	Brush-2	2
r28	High Tom Tom-1	1
r29	Middle Tom Tom-1	1
r30	Low Tom Tom-1	1
r31	High Tom Tom-2	1
r32	Middle Tom Tom-2	1
r33	Low Tom Tom-2	1
r34	High Tom Tom-3	2
r35	Middle Tom Tom-3	2
r36	Low Tom Tom-3	2
r37	High Pitch Tom Tom-1	1
r38	High Pitch Tom Tom-2	1
r39	Hand Clap	1
r40	Tambourine	1
r41	Cowbell	1
r42	High Bongo	1
r43	Low Bongo	1
r44	High Conga (mute)	1
r45	High Conga	1
r46	Low Conga	1
r47	High Timbale	1
r48	Low Timbale	1
r49	High Agogo	1
r50	Low Agogo	1
r51	Cabasa	1
r52	Maracas	1
r53	Short Whistle	2
r54	Long Whistle	2
r55	Quijada	3
r56	Claves	1
r57	Castanets	2
r58	Triangle	2
r59	Wood Block	1
r60	Bell	2
r61	Native Drum-1	1
r62	Native Drum-2	1
r63	Native Drum-3	1
OFF		0

f. Preprogrammed Rhythm Setup

r63	Native Drum-3	
r62	Native Drum-2	C7
r61	Native Drum-1	
r09	Ride Cymbal (short)	
r34	High Tom Tom-3	
r06	Crash Cymbal (short)	
r35	Middle Tom Tom-3	
r02	Closed High Hat-2	
r36	Low Tom Tom-3	
r24	Snare Drum-6	
r23	Snare Drum-5	
r22	Snare Drum-4	
r18	Bass Drum-4	
r17	Bass Drum-3	C6
r60	Bell	
r59	Wood Block	
r37	High Pitch Tom Tom-1	
r58	Triangle	
r38	High Pitch Tom Tom-2	
r57	Castanets	
r27	Brush-2	
r26	Brush-1	
r56	Claves	
r12	Cup (mute)	
r55	Quijada	
r54	Long Whistle	C5
r53	Short Whistle	
r52	Maracas	
r51	Cabasa	
r50	Low Agogo	
r49	High Agogo	
r48	Low Timbale	
r47	High Timbale	
r46	Low Conga	
r45	High Conga	
r44	High Conga (mute)	
r43	Low Bongo	C4 (Middle C)
r42	High Bongo	
r10	Ride Cymbal (mute)	
r21	Snare Drum-3	
r07	Crash Cymbal (mute)	
r41	Cowbell	
r14	Splash Cymbal	
r40	Tambourine	
r11	Cup	
r13	China Cymbal	
r08	Ride Cymbal	
r31	High Tom Tom-2	
r05	Crash Cymbal	C3
r28	High Tom Tom-1	
r32	Middle Tom Tom-2	
r03	Open High Hat-1	
r29	Middle Tom Tom-1	
r04	Open High Hat-2	
r33	Low Tom Tom-2	
r01	Closed High Hat-1	
r30	Low Tom Tom-2	
r20	Snare Drum-2	
r39	Hand Clap	
r19	Snare Drum-1	
r25	Rim Shot	
r16	Bass Drum-2	C2
r15	Bass Drum-1	

g. Preset Tones

a Group		
No.	Tone Name	Number of Partials
01	AcouPiano1	3
02	AcouPiano2	2
03	AcouPiano3	2
04	Honky - Tonk	3
05	ElecPiano1	3
06	ElecPiano2	3
07	ElecPiano3	2
08	ElecPiano4	1
09	ElecOrgan1	4
10	ElecOrgan2	2
11	ElecOrgan3	2
12	ElecOrgan4	1
13	PipeOrgan1	3
14	PipeOrgan2	3
15	PipeOrgan3	2
16	Accordion	2
17	Harpsi 1	3
18	Harpsi 2	2
19	Harpsi 3	1
20	Clav 1	3
21	Clav 2	2
22	Clav 3	2
23	Celesta 1	3
24	Celesta 2	2
25	Violin 1	3
26	Violin 2	2
27	Cello 1	3
28	Cello 2	2
29	Contrabass	2
30	Pizzicato	3
31	Harp 1	3
32	Harp 2	2
33	Strings 1	4
34	Strings 2	3
35	Strings 3	2
36	Strings 4	3
37	Brass 1	4
38	Brass 2	3
39	Brass 3	4
40	Brass 4	4
41	Trumpet 1	3
42	Trumpet 2	2
43	Trombone 1	3
44	Trombone 2	2
45	Horn	3
46	Fr Horn	2
47	Engl Horn	2
48	Tuba	2
49	Flute 1	4
50	Flute 2	2
51	Piccolo	3
52	Recorder	2
53	Pan Pipes	3
54	Bottleblow	4
55	Breathpipe	4
56	Whistle	2
57	Sax 1	2
58	Sax 2	2
59	Sax 3	2
60	Clarinet 1	2
61	Clarinet 2	3
62	Oboe	3
63	Bassoon	2
64	Harmonica	2

b Group		
No.	Tone Name	Number of Partials
01	Fantasy	4
02	Harmo Pan	4
03	Chorale	3
04	Glasses	3
05	Soundtrack	4
06	Atmosphere	4
07	Warm Bell	4
08	Space Horn	4
09	Echo Bell	3
10	Ice Rains	4
11	Oboe 2002	2
12	Echo Pan	2
13	Bell Swing	3
14	Reso Synth	2
15	Steam Pad	3
16	VibeString	4
17	Syn Lead 1	4
18	Syn Lead 2	2
19	Syn Lead 3	3
20	Syn Lead 4	2
21	Syn Bass 1	3
22	Syn Bass 2	2
23	Syn Bass 3	2
24	Syn Bass 4	3
25	AcouBass 1	2
26	AcouBass 2	1
27	ElecBass 1	2
28	ElecBass 2	2
29	SlapBass 1	2
30	SlapBass 2	3
31	Fretless 1	4
32	Fretless 2	2
33	Vibe	2
34	Glock	3
35	Marimba	3
36	Xylophone	2
37	Guitar 1	3
38	Guitar 2	3
39	Elec Gtr 1	4
40	Elec Gtr 2	4
41	Koto	2
42	Shamisen	2
43	Jamisen	2
44	Sho	4
45	Shakuhachi	4
46	WadaikoSet	4
47	Sitar	4
48	Steel Drum	4
49	Tech Snare	4
50	Elec Tom	4
51	Revrs Cym	2
52	Ethno Hit	4
53	Timpani	2
54	Triangle	2
55	Wind Bell	3
56	Tube Bell	4
57	Orche Hit	4
58	Bird Tweet	1
59	OneNoteJam	4
60	Telephone	1
61	Typewriter	2
62	Insect	2
63	WaterBells	3
64	JungleTune	4

h. Others

Rhythm/Metronome Function

Function	Value
Tempo	40 ... 250 (in two steps)
Rhythm Level	0 ... 100
Metronome Level	0 ... 100
Metronome Beat	0 ... 8
Metronome Mode	OFF, Rec Only, Rec&Play
Clock Mode	INTERNAL, MIDI

Rhythm Setup Key Number (C1 ... C8)

Parameter	Value
Tone Select	r1 ... 63, OFF, i1 ... 64
Level	0 ... 100
Pan	7> ... >< ... <7
Reverb Switch	ON, OFF

2. Sample Notes

a. Patches/Timbres

Patch No. _____

Patch No. _____

Patch No. _____

Patch Name _____

Patch Name _____

Patch Name _____

Key Mode	
Split Point	
Reverb Type	
Reverb Time	
Reverb Level	
Tone Balance	
Patch Level	

Key Mode	
Split Point	
Reverb Type	
Reverb Time	
Reverb Level	
Tone Balance	
Patch Level	

Key Mode	
Split Point	
Reverb Type	
Reverb Time	
Reverb Level	
Tone Balance	
Patch Level	

	Lower	Upper
Tone Select		
Key Shift		
Fine Tune		
Bender Range		
Assign Mode		
Reverb Switch		

	Lower	Upper
Tone Select		
Key Shift		
Fine Tune		
Bender Range		
Assign Mode		
Reverb Switch		

	Lower	Upper
Tone Select		
Key Shift		
Fine Tune		
Bender Range		
Assign Mode		
Reverb Switch		

Timbre No. _____

Timbre No. _____

Timbre No. _____

Tone Select	
Key Shift	
Fine Tune	
Bender Range	
Assign Mode	
Reverb Switch	

Tone Select	
Key Shift	
Fine Tune	
Bender Range	
Assign Mode	
Reverb Switch	

Tone Select	
Key Shift	
Fine Tune	
Bender Range	
Assign Mode	
Reverb Switch	

Timbre No. _____

Timbre No. _____

Timbre No. _____

Tone Select	
Key Shift	
Fine Tune	
Bender Range	
Assign Mode	
Reverb Switch	

Tone Select	
Key Shift	
Fine Tune	
Bender Range	
Assign Mode	
Reverb Switch	

Tone Select	
Key Shift	
Fine Tune	
Bender Range	
Assign Mode	
Reverb Switch	

b. Tones

Tone No. _____

Tone Name _____

Used Patch No. _____ Used Timbre No. _____

Structure 1&2		Structure 3&4		ENV Mode	
---------------	--	---------------	--	----------	--

WG		1	2	3	4
Pitch	Coarse				
	Fine				
	KF				
LFO	Rate				
	Depth				
	Mod				
	Bend				
Waveform	Form				
	PCM B				
	PCM No				
PW	PW				
	Velo				
Pitch ENV	Depth				
	Velo				
	TKF				
	T 1				
	T 2				
	T 3				
	T 4				
	L 0				
	L 1				
	L 2				
End L					

TVF		1	2	3	4
TVF Frequency	Freq				
	Reso				
	KF				
	BP				
	BL				
TVF ENV	Depth				
	DVelo				
	DKF				
	TKF				
	T 1				
	T 2				
	T 3				
	T 4				
	L 1				
	L 2				
Sus L					

TVA		1	2	3	4
TVA Level	Level				
	Velo				
	BP 1				
	BL 1				
	BP 2				
TVA ENV	BL 2				
	Velo T 1				
	TKF				
	T 1				
	T 2				
	T 3				
	T 4				
	L 1				
	L 2				
	Sus L				

c. Rhythm Setup

Key	Hand	Level	Tempo	Measure
C 1 (24)				
C#1 (25)				
D 1 (26)				
D#1 (27)				
E 1 (28)				
F 1 (29)				
F#1 (30)				
G 1 (31)				
G#1 (32)				
A 1 (33)				
A#1 (34)				
B 1 (35)				
C 2 (36)				
C#2 (37)				
D 2 (38)				
D#2 (39)				
E 2 (40)				
F 2 (41)				
F#2 (42)				
G 2 (43)				
G#2 (44)				
A 2 (45)				
A#2 (46)				
B 2 (47)				
C 3 (48)				
C#3 (49)				
D 3 (50)				
D#3 (51)				
E 3 (52)				
F 3 (53)				
F#3 (54)				
G 3 (55)				
G#3 (56)				
A 3 (57)				
A#3 (58)				
B 3 (59)				
C 4 (60)				
C#4 (61)				
D 4 (62)				
D#4 (63)				
E 4 (64)				
F 4 (65)				
F#4 (66)				
G 4 (67)				
G#4 (68)				
A 4 (69)				
A#4 (70)				
B 4 (71)				

Key	Hand	Level	Tempo	Measure
C 5 (72)				
C#5 (73)				
D 5 (74)				
D#5 (75)				
E 5 (76)				
F 5 (77)				
F#5 (78)				
G 5 (79)				
G#5 (80)				
A 5 (81)				
A#5 (82)				
B 5 (83)				
C 6 (84)				
C#6 (85)				
D 6 (86)				
D#6 (87)				
E 6 (88)				
F 6 (89)				
F#6 (90)				
G 6 (91)				
G#6 (92)				
A 6 (93)				
A#6 (94)				
B 6 (95)				
C 7 (96)				
C#7 (97)				
D 7 (98)				
D#7 (99)				
E 7 (100)				
F 7 (101)				
F#7 (102)				
G 7 (103)				
G#7 (104)				
A 7 (105)				
A#7 (106)				
B 7 (107)				
C 8 (108)				

Roland Exclusive Messages

1 Data Format for Exclusive Messages

Roland's MIDI implementation uses the following data format for all exclusive messages (type IV):

Byte	Description
FOH	Exclusive status
41H	Manufacturer ID (Roland)
DEV	Device ID
MDL	Model ID
CMD	Command ID
[BODY]	Main data
F7H	End of exclusive

MIDI status: FOH, F7H

An exclusive message must be flanked by a pair of status codes, starting with a Manufacturer-ID immediately after FOH (MIDI version 1.0).

Manufacturer-ID: 41H

The Manufacturer-ID identifies the manufacturer of a MIDI instrument that triggers an exclusive message. Value 41H represents Roland's Manufacturer-ID.

Device-ID: DEV

The Device-ID contains a unique value that identifies the individual device in the multiple implementation of MIDI instruments. It is usually set to 00H - 0FH, a value smaller by one than that of a basic channel, but value 00H - 1FH may be used for a device with multiple basic channels.

Model-ID: MDL

The Model-ID contains a value that uniquely identifies one model from another. Different models, however, may share an identical Model-ID if they handle similar data.

The Model-ID format may contain 00H in one or more places to provide an extended data field. The following are examples of valid Model-IDs, each representing a unique model:

01H
02H
03H
00H, 01H
00H, 02H
00H, 00H, 01H

Command-ID: CMD

The Command-ID indicates the function of an exclusive message. The Command-ID format may contain 00H in one or more places to provide an extended data field. The following are examples of valid Command-IDs, each representing a unique function:

01H
02H
03H
00H, 01H
00H, 02H
00H, 00H, 01H

Main data: BODY

This field contains a message to be exchanged across an interface. The exact data size and contents will vary with the Model-ID and Command-ID.

2 Address-mapped Data Transfer

Address mapping is a technique for transferring messages conforming to the data format given in Section 1. It assigns a series of memory-resident records—waveform and tone data, switch status, and parameters, for example—to specific locations in a machine-dependent address space, thereby allowing access to data residing at the address a message specifies.

Address-mapped data transfer is therefore independent of models and data categories. This technique allows use of two different transfer procedures: one-way transfer and handshake transfer.

One-way transfer procedure (See Section 3 for details.)

This procedure is suited for the transfer of a small amount of data. It sends out an exclusive message completely independent of a receiving device status.

Connection Diagram

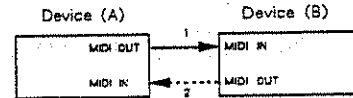

Connectional point 2 is essential for "Request data" procedures. (See Section 3.)

Handshake-transfer procedure (See Section 4 for details.)

This procedure initiates a predetermined transfer sequence (handshaking) across the interface before data transfer takes place. Handshaking ensures that reliability and transfer speed are high enough to handle a large amount of data.

Connection Diagram

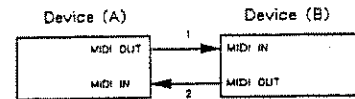

Connectional points 1 and 2 is essential.

Notes on the above two procedures

- * There are separate Command-IDs for different transfer procedures.
- * Devices A and B cannot exchange data unless they use the same transfer procedure, share identical Device-ID and Model ID, and are ready for communication.

3 One-way Transfer Procedure

This procedure sends out data all the way until it stops when the messages are so short that answerbacks need not be checked.

For long messages, however, the receiving device must acquire each message in time with the transfer sequence, which inserts intervals of at least 20 milliseconds in between.

Types of Messages

Message	Command ID
Request data 1	RQ1 (11H)
Data set 1	DT1 (12H)

Request data # 1: RQ1 (11H)

This message is sent out when there is a need to acquire data from a device at the other end of the interface. It contains data for the address and size that specify designation and length, respectively, of data required.

On receiving an RQ1 message, the remote device checks its memory for the data address and size that satisfy the request.

If it finds them and is ready for communication, the device will transmit a "Data set 1 (DT1)" message, which contains the requested data. Otherwise, the device will send out nothing.

Byte	Description
FOH	Exclusive status
41H	Manufacturer ID (Roland)
DEV	Device ID
MDL	Model ID
11H	Command ID
aaH	Address MSB
⋮	⋮
⋮	⋮
⋮	LSB
ssH	Size MSB
⋮	⋮
⋮	⋮
⋮	LSB
sum	Check sum
F7H	End of exclusive

- *The size of the requested data does not indicate the number of bytes that will make up a DT1 message, but represents the address fields where the requested data resides.
- *Some models are subject to limitations in data format used for a single transaction. Requested data, for example, may have a limit in length or must be divided into predetermined address fields before it is exchanged across the interface.
- *The same number of bytes comprises address and size data, which, however, vary with the Model-ID.
- *The error checking process uses a checksum that provides a bit pattern where the least significant 7 bits are zero when values for an address, size, and that checksum are summed.

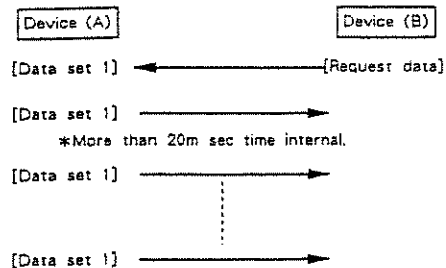

Data set 1 : DT1 (12H)

This message corresponds to the actual data transfer process. Because every byte in the data is assigned a unique address, a DT1 message can convey the starting address of one or more data as well as a series of data formatted in an address - dependent order.

The MIDI standards inhibit non-real time messages from interrupting an exclusive one. This fact is inconvenient for the devices that support a "soft-through" mechanism. To maintain compatibility with such devices, Roland has limited the DT1 to 256 bytes so that an excessively long message is sent out in separate segments.

Byte	Description
F0H	Exclusive
41H	Manufacturer ID (Roland)
DEV	Device ID
MDL	Model ID
12H	Command ID
aaH	Address MSB
...	...
ddH	LSB
...	...
ddH	Data
...	...
sum	Check sum
F7H	End of exclusive

- *A DT1 message is capable of providing only the valid data among those specified by an RQ1 message.
- *Some models are subject to limitations in data format used for a single transaction. Requested data, for example, may have a limit in length or must be divided into predetermined address fields before it is exchanged across the interface.
- *The number of bytes comprising address data varies from one Model-ID to another.
- *The error checking process uses a checksum that provides a bit pattern where the least significant 7 bits are zero when values for an address, size, and that checksum are summed.

Example of Message Transactions

- Device A sending data to Device B
Transfer of a DT1 message is all that takes place.

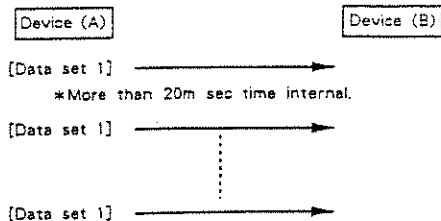

- Device B requesting data from Device A
Device B sends an RQ1 message to Device A. Checking the message, Device A sends a DT1 message back to Device B.

4 Handshake- Transfer Procedure

Handshaking is an interactive process where two devices exchange error checking signals before a message transaction takes place, thereby increasing data reliability. Unlike one-way transfer that inserts a pause between message transactions, handshake transfer allows much speedier transactions because data transfer starts once the receiving device returns a ready signal.

When it comes to handling large amounts of data—sampler waveforms and synthesizer tones over the entire range, for example—across a MIDI interface, handshaking transfer is more efficient than one-way transfer.

Types of Messages

Message	Command ID
Want to send data	WSD (40H)
Request data	RQD (41H)
Data set	DAT (42H)
Acknowledge	ACK (43H)
End of data	EOD (45H)
Communication error	ERR (4EH)
Rejection	RJC (4FH)

= Want to send data : WSD (40H)

This message is sent out when data must be sent to a device at the other end of the interface. It contains data for the address and size that specify designation and length, respectively, of the data to be sent.

On receiving a WSD message, the remote device checks its memory for the specified data address and size which will satisfy the request. If it finds them and is ready for communication, the device will return an "Acknowledge (ACK)" message. Otherwise, it will return a "Rejection (RJC)" message.

Byte	Description
F0H	Exclusive status
41H	Manufacturer ID (Roland)
DEV	Device ID
MDL	Model ID
40H	Command ID
aaH	Address MSB
...	...
ssH	LSB
...	...
ssH	Size MSB
...	...
...	LSB
sum	Check sum
F7H	End of exclusive

- *The size of the data to be sent does not indicate the number of bytes that make up a "Data set (DAT)" message, but represents the address fields where the data should reside.
- *Some models are subject to limitations in data format used for a single transaction. Requested data, for example, may have a limit in length or must be divided into predetermined address fields before it is exchanged across the interface.
- *The same number of bytes comprises address and size data, which, however, vary with the Model-ID.
- *The error checking process uses a checksum that provides a bit pattern where the least significant 7 bits are zero when values for an address, size, and that checksum are summed.

Request data : RQD (41H)

This message is sent out when there is a need to acquire data from a device at the other end of the interface. It contains data for the address and size that specify designation and length, respectively, of data required.

On receiving an RQD message, the remote device checks its memory for the data address and size which satisfy the request. If it finds them and is ready for communication, the device will transmit a "Data set (DAT)" message, which contains the requested data. Otherwise, it will return a "Rejection (RJC)" message.

Byte	Description
FOH	Exclusive status
41H	Manufacturer ID (Roland)
DEV	Device ID
MDL	Model ID
41H	Command ID
aaH	Address MSB
⋮	⋮
	LSB
ssH	Size MSB
⋮	⋮
	LSB
sum	Check sum
F7H	End of exclusive

- *The size of the requested data does not indicate the number of bytes that make up a "Data set (DAT)" message, but represents the address fields where the requested data resides.
- *Some models are subject to limitations in data format used for a single transaction. Requested data, for example, may have a limit in length or must be divided into predetermined address fields before it is exchanged across the interface.
- *The same number of bytes comprises address and size data, which, however, vary with the Model-ID.
- *The error checking process uses a checksum that provides a bit pattern where the least significant 7 bits are zero when values for an address, size, and that checksum are summed.

Data set : DAT (42H)

This message corresponds to the actual data transfer process. Because every byte in the data is assigned a unique address, the message can convey the starting address of one or more data as well as a series of data formatted in an address-dependent order.

Although the MIDI standards inhibit non-real time messages from interrupting an exclusive one, some devices support a "soft-through" mechanism for such interrupts. To maintain compatibility with such devices, Roland has limited the DAT to 256bytes so that an excessively long message is sent out in separate segments.

Byte	Description
FOH	Exclusive status
41H	Manufacturer ID (Roland)
DEV	Device ID
MDL	Model ID
42H	Command ID
aaH	Address MSB
⋮	⋮
	LSB
ddH	Data
⋮	⋮
sum	Check sum
F7H	End of exclusive

- *A DAT message is capable of providing only the valid data among those specified by an RQD or WSD message.
- *Some models are subject to limitations in data format used for a single transaction. Requested data, for example, may have a limit in length or must be divided into predetermined address fields before it is exchanged across the interface.
- *The number of bytes comprising address data varies from one model ID to another.
- *The error checking process uses a checksum that provides a bit pattern where the least significant 7 bits are zero when values for an address, size, and that checksum are summed.

Acknowledge : ACK (43H)

This message is sent out when no error was detected on reception of a WSD, DAT, "End of data (EOD)", or some other message and a requested setup or action is complete. Unless it receives an ACK message, the device at the other end will not proceed to the next operation.

Byte	Description
FOH	Exclusive status
41H	Manufacturer ID (Roland)
DEV	Device ID
MDL	Model ID
43H	Command ID
F7H	End of exclusive

End of data : EOD (45H)

This message is sent out to inform a remote device of the end of a message. Communication, however, will not come to an end unless the remote device returns an ACK message even though an EOD message was transmitted.

Byte	Description
FOH	Exclusive status
41H	Manufacturer ID (Roland)
DEV	Device ID
MDL	Model ID
45H	Command ID
F7H	End of exclusive

Communications error : ERR (4EH)

This message warns the remote device of a communications fault encountered during message transmission due, for example, to a checksum error. An ERR message may be replaced with a "Rejection (RJC)" one, which terminates the current message transaction in midstream.

When it receives an ERR message, the sending device may either attempt to send out the last message a second time or terminate communication by sending out an RJC message.

Byte	Description
FOH	Exclusive status
41H	Manufacturer ID (Roland)
DEV	Device ID
MDL	Model ID
4EH	Command ID
F7H	End of exclusive

‡ Rejection : RJC (4FH)

This message is sent out when there is a need to terminate communication by overriding the current message. An RJC message will be triggered when :

- a WSD or RQD message has specified an illegal data address or size,
- the device is not ready for communication,
- an illegal number of addresses or data has been detected,
- data transfer has been terminated by an operator,
- a communications error has occurred.

An ERR message may be sent out by a device on either side of the interface. Communication must be terminated immediately when either side triggers an ERR message.

Byte	Description
F0H	Exclusive status
41H	Manufacturer ID (Roland)
DEV	Device ID
MDL	Model ID
4FH	Command ID
F7H	End of exclusive

‡ Example of Message Transactions

● Data transfer from device (A) to device (B).

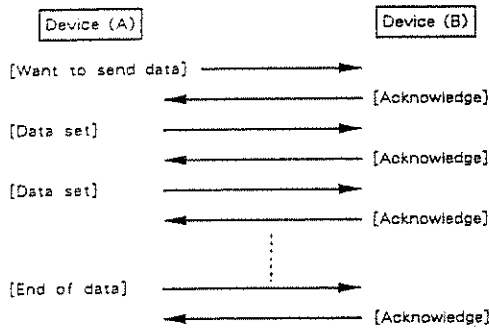

● Device (A) requests and receives data from device (B).

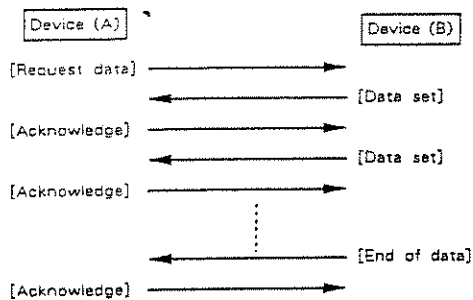

● Error occurs while device (A) is receiving data from device (B).

1) Data transfer from device (A) to device (B).

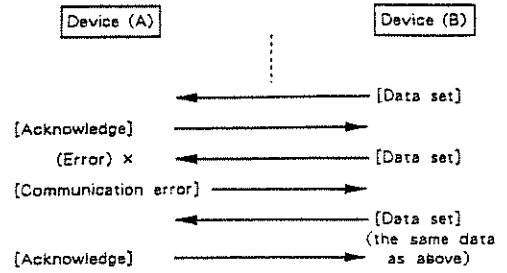

2) Device (B) rejects the data re-transmitted, and quits data transfer.

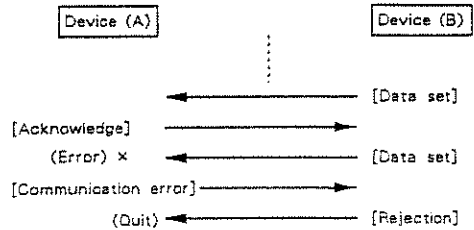

3) Device (A) immediately quits data transfer.

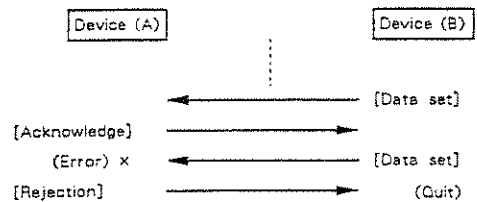

1. TRANSMITTED DATA (Synthesizer Section)

■ Note event

Note off

Status	Second	Third
9nH	kkH	00H
kk = note number		18H-6CH (24-108)
n = MIDI Channel		0H-FH (1-16)

Note on

Status	Second	Third
9nH	kkH	vvH
kk = Note number		18H-6CH (24-108)
vv = Velocity		01H-7FH (1-127)
n = MIDI channel		0H-FH (1-16)

■ Control change

Modulation Depth

Status	Second	Third
BnH	01H	vvH
vv = Modulation depth		00H-7F (0-127)
n = MIDI Channel		0H-F (1-16)

In Performance mode, transmitted when MIDI Modulation function is on.
In Multi Timbral mode, transmitted on both upper and lower MIDI TX channels of the keyboard.
D-10 does not transmit this message repeatedly if both channels are the same.

Hold-1

Status	Second	Third
BnH	40H	vvH
vv = 00H : Off		
vv = 7FH : On		
n = MIDI Channel		0H-FH (1-16)

In Performance mode, transmitted when MIDI Hold function is on.
In Multi Timbral mode, transmitted on the MIDI TX channel of upper and lower sides of the keyboard.
D-10 does not transmit this message repeatedly if both channels are the same.

Reset All Controllers

Status	Second	Third
BnH	79H	00H

Transmitted upon changing modes (Performance ↔ Multi timbral) or MIDI channels (on the previous channel).

■ Program change

Patch/Timbre Change

Status	Second	Third
CnH	ppH	
pp = Patch Number		0H-7FH (0-127)
n = MIDI Channel		0H-FH (1-16)

In Performance mode, transmitted when MIDI Prog. Change function is on.
In Multi Timbral mode and when the LCD is showing the status of either of upper or lower keyboard, transmitted on the MIDI TX channel assigned to the keyboard.

pp	A/B	BANK	NUMBER
00H (00)	A	1	1
:	:	:	:
3FH (63)	A	8	8
40H (64)	B	1	1
7FH (127)	B	8	8

■ Pitch bender change

Pitch Bender

Status	Second	Third
EnH	vvH	vvH
vv = Pitch Bender change Value		
n = MIDI Channel		0H-FH (1-16)

In Performance mode, transmitted when MIDI Bender function is on.
In Multi Timbral mode, transmitted on the MIDI TX channel of both upper and lower sides of keyboard.
Transmitted only once if both TX channels are the same.

■ Mode message

All Notes Off

Status	Second	Third
BnH	7BH	00H
n = MIDI Channel		0H-FH (1-16)

When MIDI All notes off function is on, will be transmitted upon releasing of all the keys after pressing a key (s).

OMNI OFF

Status	Second	Third
BnH	7CH	00H
n = MIDI Channel		0H-FH (1-16)

Transmitted upon power-up or when MIDI TX channel is changed to the new channel (always accompanied by "POLY").
In Multi Timbral mode, transmitted on the MIDI TX channel of both upper side and lower side of keyboard.
Transmitted only once if both channels are the same.

POLY

Status	Second	Third
BnH	7FH	00H
n = MIDI Channel		0H-FH (1-16)

Transmitted upon power-up or when MIDI TX channel is changed to the new channel. (Always accompanied by "OMNI OFF").
In Multi Timbral mode, transmitted on the MIDI TX channel of both upper side and lower side of keyboard.
Transmitted only once if both channels are the same.

■ Exclusive

Status
F0H : System Exclusive
F7H : EOX (End of Exclusive)

A set of Patch/Timbre parameters is transmitted when MIDI Patch dump function is on.
The contents in Device-ID is either of the following two: unit number and MIDI channel number. The type of the information in the Device-ID can be determined from the display mode:
When display is showing, (in Multi timbre mode)
Part --- unit number less 1
Keyboard status ---- MIDI channel less 1
(in Performance mode) unit number less 1 (only)

Also used for Bulk dump/load operation. Refer to Section 5 for details.

■ Active Sensing

Status
FEH : Active Sensing

Transmitted for checking MIDI connection between D-10 and external equipment.

2. TRANSMITTED DATA (Rhythm Section)

■ Note event

Will be transmitted when a rhythm track or rhythm pattern is played in internal clock mode. Note events are transmitted on the MIDI channel assigned to rhythm part.

Note off

Status	Second	Third
9nH	kkH	00H

kk=note number 18H-6CH (24-108)

Note on

Status	Second	Third
9nH	kkH	vvH

kk=note number 18H-6CH (24-108)
vv=Velocity 01H-7FH (1-127)

■ Exclusive

Status
F0H : System Exclusive
F7H : EOX (End of Exclusive)

Used for Bulk dump/load operation. Refer to Section 5 for details.

■ Timing Clock

Status
F8H

Transmitted only when Clock Mode is Internal.

■ Start

Status
FAH

Transmitted only when in Internal clock mode.
Panel operation : Press Start button while holding Stop button.

■ Continue

Status
FBH

Transmitted only when in Internal clock mode.
Panel operation : Press Start button.

■ Stop

Status
FCH

Transmitted only when in Internal clock mode.
Panel operation : Press Stop button.

3. RECOGNIZED RECEIVE DATA (SYNTHESIZER SECTION)

■ Note event

Note off

Status	Second	Third
8nH	kkH	vvH
9nH	kkH	00H

kk=note number 00H-7FH (0-127)
vv=velocity ignored
n=MIDI Channel 0H-FH (1-16)

Note on

Status	Second	Third
9nH	kkH	vvH

kk=note number 00H-7FH (0-127)
vv=Velocity 01H-7FH (1-127)
n=MIDI Channel 0H-FH (1-16)

Note numbers outside of the range 12-108 are transposed to the nearest octave inside the range.

■ Control change

Modulation Depth

Status	Second	Third
BnH	01H	vvH

vv=Modulation depth 00H-7FH (0-127)
n=MIDI Channel 0H-FH (1-16)

In Performance mode, recognized when MIDI Modulation function is on.
In Multi Timbral mode, always recognized.

Data Entry

Status	Second	Third
BnH	06H	vvH

vv=Value of RPC 00H-18H (0-24)
n=MIDI Channel 0H-FH (1-16)

Recognized as a value corresponding to the parameter specified by RPC.
See RPC MSB section.

Main Volume

Status	Second	Third
BnH	07H	vvH

vv=Volume Value 00H-7FH (0-127)
n=MIDI Channel 0H-FH (1-16)

In Performance mode, recognized when MIDI Volume function is on.
In Multi Timbral mode, always recognized.

Can control the volume of the Part played through the same MIDI channel. The maximum volume is determined by the Volume knob and Expression message.

Panpot

Status	Second	Third
BnH	0AH	vvH

vv=Panpot Value 00H-7FH (0-127)
n=MIDI Channel 0H-FH (1-16)

Ignored when in Performance mode.
Orientation of sound is as follows.

0=LEFT, 63=CENTER, 127=RIGHT

Expression

Status	Second	Third
BnH	0BH	vvH

vv=Expression 00H-7FH (0-127)
n=MIDI Channel 0H-FH (1-16)

Can control the Volume of the Parts played through the same MIDI channel. The maximum volume is determined by the Volume knob and Main volume message.

Hold - 1

Status	Second	Third
BnH	40H	vvH

vv=00H-3FH : Off
vv=40H-7FH : On
n=MIDI Channel 0H-FH (1-16)

In Performance mode, recognized when MIDI Modulation function is on.
In Multi Timbral mode, always recognized.

RPC LSB

Status	Second	Third
BnH	64H	vvH

vv=LSB of the parameter number controlled by RPC
00H-7FH (0-127)
n=MIDI Channel 0H-FH (1-16)

RPC MSB

Status	Second	Third
BnH	65H	vvH

vv=MSB of the parameter number controlled by RPC
00H-7FH (0-127)
n=MIDI Channel 0H-FH (1-16)

Using MIDI RPC, parameters can be changed by Control change messages. RPC MSB and LSB specify the parameter to be controlled, while Data entry shows the parameter value.

RPC MSB LSB	Data Entry	Description
00H 00H	vvH	Bender Range vv=0-24 (semitone step, max two octaves)

Reset All Controllers

Status	Second	Third
BnH	79H	00H

When Reset all controllers is recognized, each of the controllers is set as follows.

Controller	setting
Modulation Depth	OFF (0)
Main Volume	MAX (127)
Expression	MAX (127)
Hold-1	OFF (0)
Pitch Bender Change	CENTER

Program change

Patch / Timbre Change

Status	Second
CnH	ppH

pp=Patch Number 0H-7FH (0-127)
n=MIDI Channel 0H-FH (1-16)

In Performance mode, recognized when MIDI Prog. Change function is on and the Patch is changed.
In Multi Timbral mode, always recognized and the Timbre is changed. Cannot switch between Internal and Card through MIDI Program change message.

pp	A/B	BANK	NUMBER
00H (00)	A	1	1
:	:	:	:
3FH (63)	A	8	8
40H (64)	B	1	1
7FH (127)	B	8	8

Pitch Bender change

Pitch Bender

Status	Second	Third
EnH	vvH	vvH

vv vv=Pitch Bender change Value
n=MIDI Channel 0H-FH (1-16)

In Performance mode, recognized when MIDI Bender function is on.
In Multi Timbral mode, always recognized.

Mode message

Local Control

Status	Second	Third
BnH	7AH	vvH

vv=00H: Off
vv=7FH: On
n=MIDI Channel 0H-FH (1-16)

Recognized in performance mode only.

All notes off

Status	Second	Third
BnH	7BH	00H

n=MIDI Channel 0H-FH (1-16)

When All notes off is recognized, all the notes which have been turned on by Note on message are turned off.

OMNI OFF

Status	Second	Third
BnH	7CH	00H

n=MIDI Channel 0H-FH (1-16)

Recognized as All Notes Off only.
The D-10 stays in MODE 3.

OMNI ON

Status	Second	Third
BnH	7DH	00H

n=MIDI Channel 0H-FH (1-16)

Recognized as All Notes Off only.
The D-10 stays in MODE 3.

MONO

Status	Second	Third
BnH	7EH	mmH

mm=MONO channel range ignored
n=MIDI Channel 0H-FH (1-16)

Recognized as All notes off only.
The D-10 stays in MODE 3.

POLY

Status	Second	Third
BnH	7FH	00H

n=MIDI Channel 0H-FH (1-16)

Recognized as All notes off only.
The D-10 stays in MODE 3.

Exclusive

Status
FOH: System Exclusive
F7H: EOX (End of Exclusive)

A set of Patch/Timbre parameters will be received when MIDI Exclusive function is on.

When in Multi timbral mode and if Device-ID contains "MIDI Channel number less 1", the timbre parameters enter into the parts of the same MIDI channel; if Device-ID contains "Unit number less 1", into the parts specified by address in the exclusive message.

In performance mode "Unit number less 1" is effective.

Also used for Bulk dump/load operation. Refer to Section 5 for details.

Active Sensing

Status
FEH: Active Sensing

Once receiving this message, the D-10 expects to accept status or data in sequence, at least within 300ms intervals. If the unit fails to receive a message 300ms after the previous one, it judges there is a problem somewhere in MIDI path, muting the current sound and stopping 300ms-interval monitoring of incoming signal.

4. RECOGNIZED RECEIVE DATA (RHYTHM SECTION)

■ Note event

Note off

Status	Second	Third
8nH	kkH	vvH
9nH	kkH	00H

kk=note number 18H-6CH (24-108)
 vv=velocity ignored
 n=MIDI Channel 0H-FH (1-16)

Note on

Status	Second	Third
9nH	kkH	vvH

kk=note number 18H-6CH (24-108)
 vv=Velocity 01H-7FH (1-127)
 n=MIDI Channel 0H-FH (1-16)

Note numbers outside of the range 24-108 are ignored.

■ Control change

Data Entry

Status	Second	Third
BnH	06H	vvH

vv=Value of RPC 00H-18H (0-24)
 n=MIDI Channel 0H-FH (1-16)

Recognized as a value corresponding to the parameter specified by RPC.

Main Volume

Status	Second	Third
BnH	07H	vvH

vv=Volume Value 00H-7FH (0-127)
 n=MIDI Channel 0H-FH (1-16)

Can control the volume of the Rhythm section.
 The maximum volume is determined by the Volume knob setting and Expression message.

Expression

Status	Second	Third
BnH	08H	vvH

vv=Expression 00H-7FH (0-127)
 n=MIDI Channel 0H-FH (1-16)

Can control the volume of the Rhythm section.
 The maximum volume is determined by the volume knob setting and Main volume message.

RPC LSB

Status	Second	Third
BnH	64H	vvH

vv=LSB of parameter number controlled by RPC
 00H-7FH (0-127)
 n=MIDI Channel 0H-FH (1-16)

RPC MSB

Status	Second	Third
BnH	65H	vvH

vv=MSB of parameter number controlled by RPC
 00H-7FH (0-127)
 n=MIDI Channel 0H-FH (1-16)

Using MIDI RPC, parameters can be changed by Control change messages. RPC MSB and LSB specify the parameter to be controlled, and Data entry shows the parameter value.

RPC	Data Entry	Description
MSB LSB		
00H 00H	vvH	Bender Range vv=0-24 (semitone step, max two octaves)

Reset All Controllers

Status	Second	Third
BnH	79H	00H

When Reset All Controllers is recognized, each of the following controllers is set as follows.

Controller	setting
Main Volume	MAX (127)
Expression	MAX (127)
Pitch Bender Change	CENTER

■ Pitch Bender change

Pitch Bender

Status	Second	Third
EnH	vvH	vvH

vv vv=Pitch Bender change Value
 n=MIDI Channel 0H-FH (1-16)

■ Exclusive

Status
 F0H : System Exclusive
 F7H : EOX (End of Exclusive)

Used for Bulk dump/load operation. Refer to Section 5 for details.

■ Timing Clock

Status
 F8H

Recognized only when Clock mode is MIDI.

■ Start

Status
 FAH

Recognized only when Clock mode is MIDI.

■ Continue

Status
 FBH

Recognized only when Clock mode is MIDI.

■ Stop

Status
 FCH

Recognized only when Clock mode is MIDI.

5. EXCLUSIVE COMMUNICATION

The MODEL-ID # of the D-10 is 16H.
 Device-ID # is the basic channel number of each part or unit number of D-10.
 Unit # can be set through MIDI function. Device ID numbers, 16-31 are represented on the display as 17-32, respectively.

■ ONE-WAY COMMUNICATION

Request Data RQ1 11H

When the RQ1 received contains start address listed in the Parameter base address table; and address size is 1 or more, D-10 sends the data stored in that address location and the subsequent locations, if any.

Byte	Description
F0H	Exclusive status
41H	Manufactures ID (Roland)
DEV	Device ID
16H	Model ID
11H	Command ID
aaH	Address MSB *3-1
aaH	Address
aaH	Address LSB
ssH	Size MSB
ssH	Size
ssH	Size LSB
sum	Check sum
F7H	End of exclusive

Data set 1 DT1 12H

When the DT1 contains a start address listed in the Parameter base address table, D-10 stores the data into that memory location and the subsequent locations, if any. D-10 transmits this message on condition that :

- *One way bulk dump is executed in Data transfer mode. (Unit # less 1 is put in Device ID # field.)
- *Timbre change is activated while Patch dump (performance mode) or Timbre dump (Multi timbral mode) is turned on through MIDI.

Program change message is sent before timbre data with the Device ID # Set as follows :

- a) IN Performance mode ----- Unit # less 1
- b) In multi timbral mode --
- Unit # less 1 if the LCD is displaying part status
- MIDI TX channel # less 1 if the LCD is displaying keyboard status

Byte	Description
F0H	Exclusive status
41H	Manufactures ID (Roland)
DEV	Device ID
16H	Model ID
12H	Command ID
aaH	Address MSB *3-1
aaH	Address
aaH	Address LSB
ddH	Data *3-2
:	:
sum	Check sum
F7H	End of exclusive

■ HANDSHAKE COMMUNICATION

Bulk dump/load to and from D-10 through handshaking communication in Data transfer mode starts with the following message.

Want to send data WSD 40H

D-10 sends acknowledge upon receiving this message and waits for coming data.

Byte	Description
F0H	Exclusive status
41H	Manufactures ID (Roland)
DEV	Device ID
16H	Model ID
40H	Command ID
aaH	Address MSB *3-1
aaH	Address
aaH	Address LSB
ssH	Size MSB
ssH	Size
ssH	Size LSB
sum	Check sum
F7H	End of exclusive

Request data RQD 41H

When the RQD received contains start address listed in the Parameter base address table; and the address size is 1 or more, D-10 sends the data stored in that address location and the subsequent locations, if any.

Byte	Description
F0H	Exclusive status
41H	Manufactures ID (Roland)
DEV	Device ID
16H	Model ID
41H	Command ID
aaH	Address MSB *3-1
aaH	Address
aaH	Address LSB
ssH	Size MSB
ssH	Size
ssH	Size LSB
sum	Check sum
F7H	End of exclusive

Data set DAT 42H

When the DAT received contains address listed in the Parameter base address table, D-10 stores the data in that address location.

Byte	Description
F0H	Exclusive status
41H	Manufactures ID (Roland)
DEV	Device ID
16H	Model ID
42H	Command ID
aaH	Address MSB *3-1
aaH	Address
aaH	Address LSB
ddH	Data *3-2
:	:
sum	Check sum
F7H	End of exclusive

Acknowledge ACK 43H

When receives this message in reply to DAT, D-10 sends the next data; when receives in reply to EOD, ceases current handshaking communication. D-10 sends this message upon receipt of WSD or DAT.

Byte	Description
F0H	Exclusive status
41H	Manufactures ID (Roland)
DEV	Device ID
16H	Model ID
43H	Command ID
F7H	End of exclusive

End of data EOD 45H

Upon receipt of this message, D-10 sends acknowledge and terminates the current handshaking communication.

Byte	Description
F0H	Exclusive status
41H	Manufactures ID (Roland)
DEV	Device ID
16H	Model ID
45H	Command ID
F7H	End of exclusive

Communication error ERR 4EH

Should failure in data reception occur (e.g. disagreement of checksum), D-10 sends this message.

If D-10 receives this message, it sends the last message again.

Byte	Description
F0H	Exclusive status
41H	Manufactures ID (Roland)
DEV	Device ID
16H	Model ID
4EH	Command ID
F7H	End of exclusive

Rejection RJC 4FH

D-10 ends communication upon receipt of this message.

Byte	Description
F0H	Exclusive status
41H	Manufactures ID (Roland)
DEV	Device ID
16H	Model ID
4FH	Command ID
F7H	End of exclusive

*3-1 Address and size must specify the address where data exist.
*3-2 If the receiving data are system partial parameters, D-10 recognizes these data only after it has received all the partial reserve parameters. (See *6-8 System area.)

6. PARAMETER ADDRESS MAP

Addresses are shown in 7-bit hexadecimal.

Address	MSB	LSB
Binary	0aaa aaaa	0bbb bbbb
7-bit hex.	AA	BB
	0ccc cccc	CC

The actual address of a parameter in a block is the sum of the start address of each block and one or more offset address.
Parameters marked by *6-1 have two offset addresses: one in the table in *6-1 and the other one in the Common parameter table or in the Partial parameter table.

Parameter base address

Temporary area (Accessed on each basic channel)

Start address	Description
00 00 00	Timbre Temporary Area (synth part) *6-3
01 00 00	Setup Temporary Area (rhythm part) *6-2
02 00 00	Tone Temporary Area (synth part) *6-1

Whole part (Accessible on UNIT#)

Start address	Description
03 00 00	Timbre Temporary Area (part 1) *6-3
03 00 10	Timbre Temporary Area (part 2)
:	:
03 00 60	Timbre Temporary Area (part 7)
03 00 70	Timbre Temporary Area (part 8)
03 01 00	Timbre Temporary Area (rhythm part)
03 01 10	Rhythm Setup Temporary Area *6-2
03 04 00	Patch Temporary Area *6-4
:	:
04 00 00	Tone Temporary Area (part 1/upper) *6-1
04 01 76	Tone Temporary Area (part 2/lower)
:	:
04 0B 44	Tone Temporary Area (part 7)
04 0D 3A	Tone Temporary Area (part 8)
:	:
05 00 00	Timbre Memory #1 *6-5
05 00 08	Timbre Memory #2
:	:
05 07 70	Timbre Memory #127
05 07 78	Timbre Memory #128
:	:
07 00 00	Patch Memory #1 *6-4
07 00 26	Patch Memory #2
:	:
07 25 34	Patch Memory #127
07 25 5A	Patch Memory #128
:	:
08 00 00	Tone Memory #1 *6-1
08 02 00	Tone Memory #2
:	:
08 7C 00	Tone Memory #63
08 7E 00	Tone Memory #64
:	:
09 00 00	Rhythm Setup #1 *6-2
09 00 04	Rhythm Setup #2
:	:
09 02 4C	Rhythm Setup #84
09 02 50	Rhythm Setup #85
:	:
0A 00 00	Rhythm Pattern P-51 *6-6
0A 04 4C	Rhythm Pattern P-52
:	:
0B 09 68	Rhythm Pattern P-87
0B 0E 34	Rhythm Pattern P-88
:	:
0C 00 00	Rhythm Track *6-7
10 00 00	System Area *6-8
:	:
20 00 00	Display *6-9
:	:
40 00 00	Write Request *6-10

Notes :

*6-1 Tone Temporary area / Tone Memory

Offset address	Description
00 00 00	Common parameter *6-1-1
00 00 0E	Partial parameter (for Partial# 1) *6-1-2

00 00 48	Partial parameter (for Partial# 2)
00 01 02	Partial parameter (for Partial# 3)
00 01 3C	Partial parameter (for Partial# 4)

Total size 00 01 7611

*6-1-1 Common parameter

Offset address	Description	
00H 0aaa aaaa	TONE NAME 1	32-127 (ASCII)
:	:	:
09H 0aaa aaaa	TONE NAME 10	
:	:	:
0AH 0000 aaaa	Structure of Partial# 1&2	0-12 (1-13)
0BH 0000 aaaa	Structure of Partial# 3&4	0-12 (1-13)
:	:	:
0CH 0000 aaaa	PARTIAL MUTE	0-15 (0000-1111)
:	:	:
0DH 0000 000a	ENV MODE	0-1 (Normal, No sustain)

Total size 00 00 0E11

*6-1-2 Partial parameter

Offset address	Description	
00 00H 0aaa aaaa	WG PITCH COARSE	0-96 (C1,C#1, -C9)
00 01H 0aaa aaaa	WG PITCH FINE	0-100 (-50-+50)
:	:	:
00 02H 000a aaaa	WG PITCH KEYFOLLOW	0-16 (-1,-1/2,-1/4,0, 1/8,1/4,3/8,1/2, 5/8,3/4,7/8,1, 5/4,3/2,2,1,2)
00 03H 0000 000a	WG PITCH BENDER SW	0-1 (OFF, ON)
00 04H 0000 00aa	WG WAVEFORM/PCM BANK	0-3 (SQU/1, SAW/1, SQU/2, SAW/2)
00 05H 0aaa aaaa	WG PCM WAVE #	0-127 (1-128)
00 06H 0aaa aaaa	WG PULSE WIDTH	0-100
00 07H 0000 aaaa	WG PW VELO SENS	0-14 (-7-+7)
:	:	:
00 08H 0000 aaaa	P-ENV DEPTH	0-10
00 09H 0aaa aaaa	P-ENV VELO SENS	0-3
00 0AH 0000 0aaa	P-ENV TIME KEYF	0-4
00 0BH 0aaa aaaa	P-ENV TIME 1	0-100
00 0CH 0aaa aaaa	P-ENV TIME 2	0-100
00 0DH 0aaa aaaa	P-ENV TIME 3	0-100
00 0EH 0aaa aaaa	P-ENV TIME 4	0-100
00 0FH 0aaa aaaa	P-ENV LEVEL 0	0-100 (-50-+50)
00 10H 0aaa aaaa	P-ENV LEVEL 1	0-100 (-50-+50)
00 11H 0aaa aaaa	P-ENV LEVEL 2	0-100 (-50-+50)
00 12H 0aaa aaaa	dummy	(for MT-32)
00 13H 0aaa aaaa	END LEVEL	0-100 (-50-+50)
:	:	:
00 14H 0aaa aaaa	P-LFO RATE	0-100
00 15H 0aaa aaaa	P-LFO DEPTH	0-100
00 16H 0aaa aaaa	P-LFO MOD SENS	0-100
00 17H 0aaa aaaa	TVF CUTOFF FREQ	0-100
00 18H 000a aaaa	TVF RESONANCE	0-30
00 19H 0000 aaaa	TVF KEYFOLLOW	0-14 (-1,-1/2,-1/4,0, 1/8,1/4,3/8,1/2, 5/8,3/4,7/8,1, 5/4,3/2,2)
00 1AH 0aaa aaaa	TVF BIAS POINT/DIR	0-127 (<1A-<7C>1A->7C)
00 1BH 0000 aaaa	TVF BIAS LEVEL	0-14 (-7-+7)
:	:	:
00 1CH 0aaa aaaa	TVF ENV DEPTH	0-100
00 1DH 0aaa aaaa	TVF ENV VELO SENS	0-100
00 1EH 0000 0aaa	TVF ENV DEPTH KEYF	0-4
00 1FH 0000 0aaa	TVF ENV TIME KEYF	0-4
00 20H 0aaa aaaa	TVF ENV TIME 1	0-100
00 21H 0aaa aaaa	TVF ENV TIME 2	0-100
00 22H 0aaa aaaa	TVF ENV TIME 3	0-100

00 23H	0aaa aaaa	dummy (for MT-32)	
00 24H	0aaa aaaa	TVF ENV TIME 4	0-100
00 25H	0aaa aaaa	TVF ENV LEVEL 1	0-100
00 26H	0aaa aaaa	TVF ENV LEVEL 2	0-100
00 27H	0aaa aaaa	dummy (for MT-32)	
00 28H	0aaa aaaa	TVF ENV SUSTAIN LEVEL	0-100
00 29H	0aaa aaaa	TVA LEVEL	0-100
00 2AH	0aaa aaaa	TVA VELO SENS	0-100 (-50-+50)
00 2BH	0aaa aaaa	TVA BIAS POINT 1	0-127 (<1A-<7C>1A->7C)
00 2CH	0000 aaaa	TVA BIAS LEVEL 1	0-12 (-12-0)
00 2DH	0aaa aaaa	TVA BIAS POINT 2	0-127 (<1A-<7C>1A->7C)
00 2EH	0000 aaaa	TVA BIAS LEVEL 2	0-12 (-12-0)
00 2FH	0000 0aaa	TVA ENV TIME KEYF	0-4
00 30H	0000 0aaa	TVA ENV TIME V_FOLLOW	0-4
00 31H	0aaa aaaa	TVA ENV TIME 1	0-100
00 32H	0aaa aaaa	TVA ENV TIME 2	0-100
00 33H	0aaa aaaa	TVA ENV TIME 3	0-100
00 34H	0aaa aaaa	dummy (for MT-32)	
00 35H	0aaa aaaa	TVA ENV TIME 5	0-100
00 36H	0aaa aaaa	TVA ENV LEVEL 1	0-100
00 37H	0aaa aaaa	TVA ENV LEVEL 2	0-100
00 38H	0aaa aaaa	dummy (for MT-32)	
00 39H	0aaa aaaa	TVA ENV SUSTAIN LEVEL	0-100

Total size = 00 00 3AH

Example of RQ1 and DT1 application... 1

*This example sets Unit number to 17.

Sending the following data string lets D-10 send Part 2/Lower tone data from the temporary area.

FO 41 10 16 11 04 01 76 00 01 76 0E F7

*6-2 Rhythm Setup

Offset address	Description
00 00H	0aaa aaaa TONE 0-127 (i01-i64, r01-r63, OFF)
00 01H	0aaa aaaa OUTPUT LEVEL 0-100
00 02H	0000 aaaa PANPOT 0-14 (L-R)
00 03H	0000 000a REVERB SWITCH 0-1 (OFF, ON)
Total size	00 00 04H

*6-3 Timbre temporary area

D-10 accepts the data for the area below only in Multi mode.

Offset address	Description
00 00H	0000 00aa TONE GROUP 0-3 (a, b, i, r)
00 01H	00aa aaaa TONE NUMBER 0-63 (1-64)
00 02H	00aa aaaa KEY SHIFT 0-48 (-24 - +24)
00 03H	0aaa aaaa FINE TUNE 0-100 (-50-+50)
00 04H	000a aaaa BENDER RANGE 0-24
00 05H	0000 00aa ASSIGN MODE 0-3 (POLY 1, POLY 2, POLY 3, POLY 4)
00 06H	0000 000a REVERB SWITCH 0-1 (OFF, ON)
00 07H	0000 0000 dummy (ignored if received)
00 08H	0aaa aaaa OUTPUT LEVEL 0-100
00 09H	0000 aaaa PANPOT 0-14 (L-R)
00 0AH	0000 0000 dummy (ignored if received)
:	:
00 0FH	0000 0000 dummy
Total size	00 00 16H

*6-4 Patch Temporary area / Patch Memory

D-10 accepts the data for Patch temporary area only in Performance mode.

Offset address	Description
00 00H	0000 00aa KEY MODE 0-2 (whole, dual, split)
00 01H	00aa aaaa SPLJT POINT 0-61 (C2-C#7)
00 02H	0000 00aa LOWER TONE GROUP 0-3 (a, b, i, r)
00 03H	00aa aaaa LOWER TONE NUMBER 0-63 (1-64)
00 04H	0000 00aa UPPER TONE GROUP 0-3 (a, b, i, r)
00 05H	00aa aaaa UPPER TONE NUMBER 0-63 (1-64)
00 06H	00aa aaaa LOWER KEY SHIFT 0-48 (-24 - +24)

00 07H	00aa aaaa	UPPER KEY SHIFT	0-48 (-24 - +24)
00 08H	0aaa aaaa	LOWER FINE TUNE	0-100 (-50-+50)
00 09H	0aaa aaaa	UPPER FINE TUNE	0-100 (-50-+50)
00 0AH	000a aaaa	LOWER BENDER RANGE	0-24
00 0BH	000a aaaa	UPPER BENDER RANGE	0-24
00 0CH	0000 00aa	LOWER ASSIGN MODE	0-3 (POLY 1, POLY 2, POLY 3, POLY 4)
00 0DH	0000 00aa	UPPER ASSIGN MODE	0-3 (POLY 1, POLY 2, POLY 3, POLY 4)
00 0EH	0000 000a	LOWER REVERB SWITCH	0-1 (OFF, ON)
00 0FH	0000 000a	UPPER REVERB SWITCH	0-1 (OFF, ON)
00 10H	0000 aaaa	REVERB MODE	0-8 (Room1/2, Hall1/2, Plate, Tap delay 1/2/3, OFF)
00 11H	0000 0aaa	REVERB TIME	0-7 (1-8)
00 12H	0000 0aaa	REVERB LEVEL	0-7
00 13H	0aaa aaaa	U/L BALANCE	0-100 (L max--U max)
00 14H	0aaa aaaa	PATCH LEVEL	0-100
00 15H	0aaa aaaa	PATCH NAME CHAR.1	32-127 (ASCII CODE)
:	:	:	:
00 24H	0aaa aaaa	PATCH NAME CHAR.16	
00 25H	0000 0000	dummy (ignored if received)	

Total size = 00 00 26H

Example of RQ1 and DT1 application 2

*This example sets Unit # to 17.

When D-10 receives the following message in Performance mode, it sends Patch data in the temporary area.

FO 41 10 16 11 03 04 00 00 00 26 53 F7

*6-5 Timbre memory

Offset address	Description
00 00H	0000 00aa TONE GROUP 0-3 (a, b, i, r)
00 01H	00aa aaaa TONE NUMBER 0-63 (1-64)
00 02H	00aa aaaa KEY SHIFT 0-48 (-24 - +24)
00 03H	0aaa aaaa FINE TUNE 0-100 (-50-+50)
00 04H	000a aaaa BENDER RANGE 0-24
00 05H	0000 00aa ASSIGN MODE 0-3 (POLY 1, POLY 2, POLY 3, POLY 4)
00 06H	0000 000a REVERB SWITCH 0-1 (OFF, ON)
00 07H	0000 0000 dummy (ignored if received)
Total size	00 00 08H

*6-6 Rhythm pattern

The data listed below are divided-by-two 8-bit data and sent/received as two 4-bit data. (bbbbaaaa -> 0000aaaa, 0000bbbb)
Events are listed in an ascending order.

Offset address	Description
00 00H	0000 0aaa TIME 0-7
00 01H	0000 0000 (1/4, 2/4, 3/4, 4/4, 5/4, 6/4, 7/4, 8/4)
00 02H	0000 aaaa TOTAL # OF NOTES 0-96
00 03H	0000 0bbb
00 04H	0000 0000 dummy (ignored if received)
00 05H	0000 0000 dummy
00 06H	EVENT # 1 *6-6-1
00 0CH	EVENT # 2
:	:
04 3AH	EVENT #95
04 40H	EVENT #96
04 46H	0000 1111 END MARK
04 47H	0000 1111
04 48H	0000 0000 dummy (ignored if received)
04 49H	0000 0000 dummy
04 4AH	0000 0000 dummy (ignored if received)
04 4BH	0000 0000 dummy

Total size = 00 04 4CH

*6-6-1 Event

Offset address	Description
00 00H	0000 aaaa STEP 0-191
00 01H	0000 bbbb
00 02H	0000 aaaa NOTE NUMBER 24-108
00 03H	0000 0bbb
00 04H	0000 aaaa VELOCITY 1-127
00 05H	0000 0bbb

*6-7 Rhythm track

Offset address	Description
00 00H	0aaa aaaa TRACK LENGTH LSB 0-500
00 01H	0000 00aa TRACK LENGTH MSB
00 02H	0aaa aaaa Pattern 1 0-63, 64-71 : : : (P-11-P-88, Blank 1-8)
03 75H	0aaa aaaa Pattern 500

Total size = 00 03 76H

*6-8 System area

If "All" is selected for data type in Bulk Dump/Load, D-10 transmits data including this system area. Partial reserve must be sent as a package of 9 parts, which in total, should contain no more than 32 partials.

Offset address	Description
00 00H	0aaa aaaa MASTER TUNE 0-127 (432.1Hz-457.6Hz)
00 01H	0000 aaaa REVERB MODE 0-8 (Room1/2, Hall1/2, Plate, Tap delay, 1/2/3, OFF)
00 02H	0000 0aaa REVERB TIME 0-7 (1-8)
00 03H	0000 0aaa REVERB LEVEL 0-7
00 04H	00aa aaaa PARTIAL RESERVE (Part 1) 0-32
00 05H	00aa aaaa PARTIAL RESERVE (Part 2) 0-32
00 06H	00aa aaaa PARTIAL RESERVE (Part 3) 0-32
00 07H	00aa aaaa PARTIAL RESERVE (Part 4) 0-32
00 08H	00aa aaaa PARTIAL RESERVE (Part 5) 0-32
00 09H	00aa aaaa PARTIAL RESERVE (Part 6) 0-32
00 0AH	00aa aaaa PARTIAL RESERVE (Part 7) 0-32
00 0BH	00aa aaaa PARTIAL RESERVE (Part 8) 0-32
00 0CH	00aa aaaa PARTIAL RESERVE (Part R) 0-32
00 0DH	0000 0000 dummy (for D-110)
:	:
00 20H	0000 0000
00 21H	0aaa aaaa OUTPUT LEVEL (Part 1) 0-100
00 22H	0aaa aaaa OUTPUT LEVEL (Part 2) 0-100
00 23H	0aaa aaaa OUTPUT LEVEL (Part 3) 0-100
00 24H	0aaa aaaa OUTPUT LEVEL (Part 4) 0-100
00 25H	0aaa aaaa OUTPUT LEVEL (Part 5) 0-100
00 26H	0aaa aaaa OUTPUT LEVEL (Part 6) 0-100
00 27H	0aaa aaaa OUTPUT LEVEL (Part 7) 0-100
00 28H	0aaa aaaa OUTPUT LEVEL (Part 8) 0-100
00 29H	0aaa aaaa OUTPUT LEVEL (Part R) 0-100
00 2AH	0000 aaaa PANPOT (Part 1) 0-14
00 2BH	0000 aaaa PANPOT (Part 2) 0-14
00 2CH	0000 aaaa PANPOT (Part 3) 0-14
00 2DH	0000 aaaa PANPOT (Part 4) 0-14
00 2EH	0000 aaaa PANPOT (Part 5) 0-14
00 2FH	0000 aaaa PANPOT (Part 6) 0-14
00 30H	0000 aaaa PANPOT (Part 7) 0-14
00 31H	0000 aaaa PANPOT (Part 8) 0-14

Total size = 00 00 32H

Example of RQ1 and DT1 application ... 3

*This example sets Unit # to 17.

The byte arrangement below will set Partial reserve of each part as follows:

Part 1 8 Part 3 thru 8 0
Part 2 10 Rhythm part 8

FD 41 10 16 12 10 00 04 00 08 0A 00 00 00 00 00 08 52 F7

*6-9 DISPLAY

D-10 deciphers incoming data and sends them to the LCD as a string of ASCII code characters. The display data in this area cannot be brought outside D-10 through MIDI message, such as RQ1 and DT1.

Offset address	Description
00H	0aaa aaaa DISPLAYED LETTER 32-127
:	:
1FH	0aaa aaaa DISPLAYED LETTER (ASCII)

Total size = 00 00 20H

*6-10 Write Request

This message simulates write switch: D-10 stores the data of each part in the temporary area into individual memory locations specified by two byte data. Timbre write is effective only in Multi timbral mode; Patch write only in Performance mode. The data in this area cannot be brought outside D-10 through MIDI message, such as RQ1 and DT1. D-10 returns the Result.

Offset address	Description
00 00H	00aa aaaa Tone Write 0-63 (part 1/upper) (01-64)
00 01H	0000 000a 0, 1 (Internal,Card)
00 02H	00aa aaaa Tone Write
00 03H	0000 000a (part 2/lower)
:	:
00 0EH	00aa aaaa Tone Write
00 0FH	0000 000a (part 8)
01 00H	0aaa aaaa Timbre Write 0-127 (A11-B88)
01 01H	0000 000a 0, 1 (Internal,Card)
01 02H	0aaa aaaa Timbre Write
01 03H	0000 000a (part 2)
:	:
01 0EH	0aaa aaaa Timbre Write
01 0FH	0000 000a (part 8)
03 00H	0aaa aaaa Patch Write 0-127 (A11-B88)
03 01H	0000 000a 0, 1 (Internal,Card)
10 00H	0000 00aa Result 0-3
	0=Function Completed
	1=Card Not Ready
	2=Write Protected
	3=Incorrect Mode

Example of RQ1 and DT1 application ... 4

*This example sets Unit # to 17.

Sending the following byte strings will enable D-10 to write data in Part 3 in temporary data into I-B24.

FD 41 10 16 12 40 01 04 4B 00 7D F7

Address Map

Address	Block	Sub Block	Reference
00-00-00	Timbre Temp (Basic Ch)		6-3
01-00-00	Rhythm Setup Temp (Basic Ch)	Note# 24 Note# 25 : Note# 107 Note# 108	6-2
02-00-00	Tone Temp (Basic Ch)	Common Partial 1 Partial 2 Partial 3 Partial 4	6-1-1 6-1-2
03-00-00	Timbre Temp (Unit#)	Part 1 Part 2 : Ppart 8 Part R	6-3
04-00-00	Tone Temp (Unit#)	Part 1 Part 2 : Part 7 Part 8	6-1
05-00-00	Timbre Memory	I-A11 (# 1) I-A12 (# 2) : I-B87 (#127) I-B88 (#128)	6-5
07-00-00	Patch Memory	I-A11 (# 1) I-A12 (# 2) : I-B87 (#127) I-B88 (#128)	6-4
08-00-00	Tone Memory	i-01 i-02 : i-63 i-64	6-1
09-00-00	Rhythm Setup	# 1 # 2 : # 84 # 85	6-2
0A-00-00	Rhythm Pattern	p-51 P-52 : P-87 P-88	6-6
0C-00-00	Rhythm Track		6-7
10-00-00	System Area		6-8
20-00-00	Display		6-9
40-00-00	Write Request		6-10

MIDI Implimentation Chart

Function...		Transmitted	Recognized	Remarks
Basic Channel	Default Changed	1-16 1-16	1-16 1-16	Memorized
Mode	Default Messages Altered	Mode 3 POLY, OMNI OFF *****	Mode 3 ×	
Note Number	True voice	24-108 *****	0-127 12-108	
Velocity	Note ON Note OFF	○ v= 1-127 × 9n v= 0	○ v= 1-127 ×	
After Touch	Key's Ch's	×	×	
Pitch Bender		*	* 0-24 semi	9 bit resolution
Control Change		1 * 6 × 7 × 11 × 64 * 100, 101 × 121 ○	* *** * ○ * *** (0) ○	Modulation Data entry Volume Expression Hold 1 RPC LSB, MSB Reset all controllers
Prog Change	True #	* 0-127 *****	* 0-127 0-127	
System	Exclusive	**	**	Tone Parameter
System Common	Song Pos Song Sel Tune	×	×	
System Real Time	Clock Commands	×	×	
Aux Messages	Local ON/OFF All Notes OFF Active Sense Reset	×	○ ○ (123-127) ○ ×	
Notes		* Can be set to ○ or × manually, and memorized. ** Can be set to ○ or × manually *** RPC = Registered parameter control number. RPC #0 : Pitch bend sensitivity Parameter values are given by Data Entry.		

Mode 1 : OMNI ON, POLY
Mode 3 : OMNI OFF, POLY

Mode 2 : OMNI ON, MONO
Mode 4 : OMNI OFF, MONO

○ : YES
× : NO

MIDI Implimentation Chart

Function...		Transmitted	Recognized	Remarks
Basic Channel	Default Changed	× ×	1-16 1-16	Memorized
Mode	Default Messages Altered	× × *****	Mode 3 ×	
Note Number	True voice	× *****	0-127 12-108	
Velocity	Note ON Note OFF	× ×	○ v= 1-127 ×	
After Touch	Key's Ch's	× ×	× ×	
Pitch Bender		×	○ 0-24 semi	9 bit resolution
Control Change	1 6 7 10 11 64 100, 101 121	× × × × × × × ×	○ ** ○ ○ ○ ○ ** (0) ○	Modulation Data entry Volume Panpot Expression Hold 1 RPC LSB, MSB Reset all controllers
Prog Change	True #	× *****	○ 0-127 0-127	
System	Exclusive	*	*	Tone Parameter
System Common	Song Pos Song Sel Tune	× × ×	× × ×	
System Real Time	Clock Commands	× ×	× ×	
Aux Messages	Local ON/OFF All Notes OFF Active Sense Reset	× × × ×	× ○ (123-127) ○ ×	
Notes	* Can be set ○ or × manually. ** RPC = Registered parameter control number. RPC #0 : Pitch bend sensitivity Parameter values are given by Data Entry.			

MIDI Implimentation Chart

Function		Transmitted	Recognized	Remarks
Basic Channel	Default Changed	1-16 1-16	× ×	Memorized (upper/lower)
Mode	Default Messages Altered	Mode 3 POLY, OMNI OFF *****	× ×	
Note Number	True voice	24-108 *****	× ×	
Velocity	Note ON Note OFF	○ v= 1-127 × 9n v= 0	× ×	
After Touch	Key's Ch's	× ×	× ×	
Pitch Bender		**	×	
Control Change	1 64 121	** ** **	× × ×	Modulation Hold 1 Reset all controllers
Prog Change	True #	○ 0-127 *****	×	
System	Exclusive	×	×	
System Common	Song Pos Song Sel Tune	× × ×	× × ×	
System Real Time	Clock Commands	× ×	× ×	
Aux Messages	Local ON/OFF All Notes OFF Active Sense Reset	× * (123) ○ ×	× × × ×	
Notes		* Can be set to ○ or × manually. ** Transmitted to both upper/lower MIDI TX channels.		

Mode 1 : OMNI ON, POLY
Mode 3 : OMNI OFF, POLY

Mode 2 : OMNI ON, MONO
Mode 4 : OMNI OFF, MONO

○ : YES
× : NO

MIDI Implimentation Chart

Function...		Transmitted	Recognized	Remarks
Basic Channel	Default Changed	1-16 1-16	1-16 1-16	Memorized
Mode	Default Messages Altered	× × *****	Mode 3 ×	
Note Number	True voice	24-108 *****	24-108 24-108	
Velocity	Note ON Note OFF	○ v= 1-127 × 9n v= 0	○ v= 1-127 ×	
After Touch	Key's Ch's	× ×	× ×	
Pitch Bender		×	* 0-24 semi	9 bit resolution
Control Change	6 7 11 100, 101 121	× × × × ×	** * ○ ** (0) ○	Data entry Volume Expression RPC LSB, MSB Reset all controllers
Prog Change	True #	× *****	×	
System	Exclusive	○	***	Setup & Seq data
System Common	Song Pos Song Sel Tune	× × ×	× × ×	
System Real Time	Clock Commands	○ (Clock mode = INT) ○ (Clock mode = INT)	○ (Clock mode = MIDI) ○ (Clock mode = MIDI)	
Aux Messages	Local ON/OFF All Notes OFF Active Sense Reset	× × × ×	× ○ ○ ×	
Notes		* Performance mode - Can be set to ○ or × manually and memorized. Multi Timbral mode - Always received. ** RPC = Registered parameter control number. RPC #0 : Pitch bend sensitivity *** Can be set to ○ or × manually.		

Mode 1 : OMNI ON, POLY
Mode 3 : OMNI OFF, POLY

Mode 2 : OMNI ON, MONO
Mode 4 : OMNI OFF, MONO

○ : YES
× : NO

ROM PLAY

[OPERATION]

② Set the volume to an appropriate level with the Volume Knob.

*When using a home stereo set, do not set the volume too high to avoid damaging the speakers.

③ Push the ROM Play Button.
(The indicator lights up)

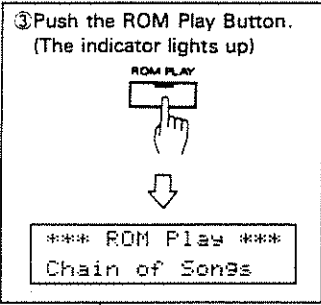

① Turn the unit on.

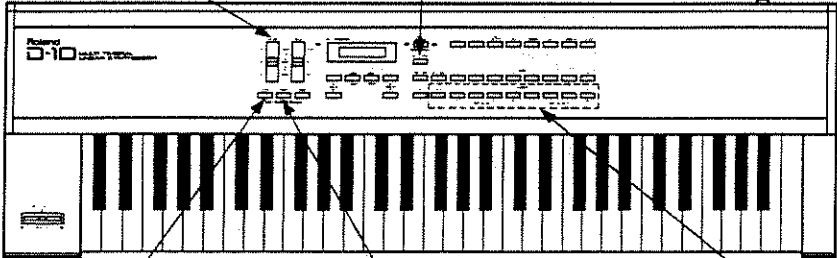

⑥ To stop playing, push the Stop Button.

⑤ Push the Start Button to start Playing.

④ To select a song, use the Number Button or A/B Button.
The corresponding indicator will light up.

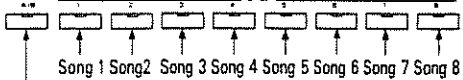

Songs 1 to 8 are played in sequence.

During the performance, the Number Button or A/B Button indicator will flash along with the performance.

Song Number	Song Name	
1	Macho Memory	Music by Eric Persing ©1988 by Eric Persing
2	Jah May Kah !	Music by Amin Bhatia ©1988 by Amin Bhatia
3	Sugar Plum	Composed by Tchaikovski Arranged by Amin Bhatia
4	My Brother	Music by Adrian Scott ©1988 by Adrian Scott
5	Folk	Music by Amin Bhatia ©1988 by Amin Bhatia
6	Bumble Dee	Composed by Rymsky-Korsakow Arranged by Amin Bhatia
7	Mergatroid	Music by Eric Persing ©1988 by Eric Persing
8	Dinner Set	Music by Adrian Scott ©1988 by Adrian Scott

*During ROM Play, you cannot play the keyboard or use the controls such as a Bender.

*The performance data of the ROM Play data is not sent through the MIDI OUT Connector.

ROM PLAY

8 different tunes are preprogrammed in the D-10 so that you can immediately experience the excellent possibilities of the Multi Timbral function. These tunes are referred to in this manual as "ROM Play".

For the best effect, use a stereo amplifier, if possible.

[CONNECTION]

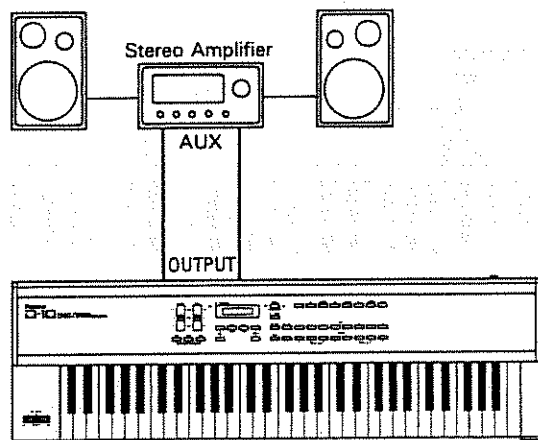

D-10 Quick Operation Table (1)



Editing Tune/Function	Patch/Timber	Tone	Volume level of rhythm	Volume level of metronome
<p>Editing Tune/Function</p> <p>START/STOP → Selection of a Function (DATA) → Editing (VALUE) → EXIT</p>	<p>Patch/Timber</p> <p>START/STOP → [Editing] → Selection of a Parameter (DATA) → Editing (VALUE) → [Writing] (INT/CARD A/B BANK 1-8 NUMBER 1-8, ENTER, COMPARE)</p>	<p>Tone</p> <p>START/STOP → [Editing] → Selection of a Tone (Performance Mode) (DATA) → Selection of a Parameter group (DATA) → Selection of a Parameter BANK 1-8 (DATA) → Editing (VALUE) → [Writing] (INT/CARD, VALUE, COMPARE, ENTER)</p> <p>Partial Select: 1, 2, 3, 4</p> <p>Partial Mute: 5, 6, 7, 8</p>	<p>Volume level of rhythm</p> <p>TEMPO → Adjustment (VALUE) → EXIT</p>	<p>Volume level of metronome</p> <p>TEMPO → Adjustment (VALUE) → EXIT</p>
<p>Editing MIDI Function</p> <p>START/STOP → Selection of a Function (DATA) → Editing (VALUE) → EXIT</p>	<p>Beat of metronome</p> <p>TEMPO → Setting (VALUE) → EXIT</p>	<p>Metronome Mode</p> <p>TEMPO → Setting (VALUE) → EXIT</p>	<p>Volume level of rhythm</p> <p>TEMPO → Adjustment (VALUE) → EXIT</p>	<p>Volume level of metronome</p> <p>TEMPO → Adjustment (VALUE) → EXIT</p>

D-10 Quick Operation Table (2)

Setup of rhythm

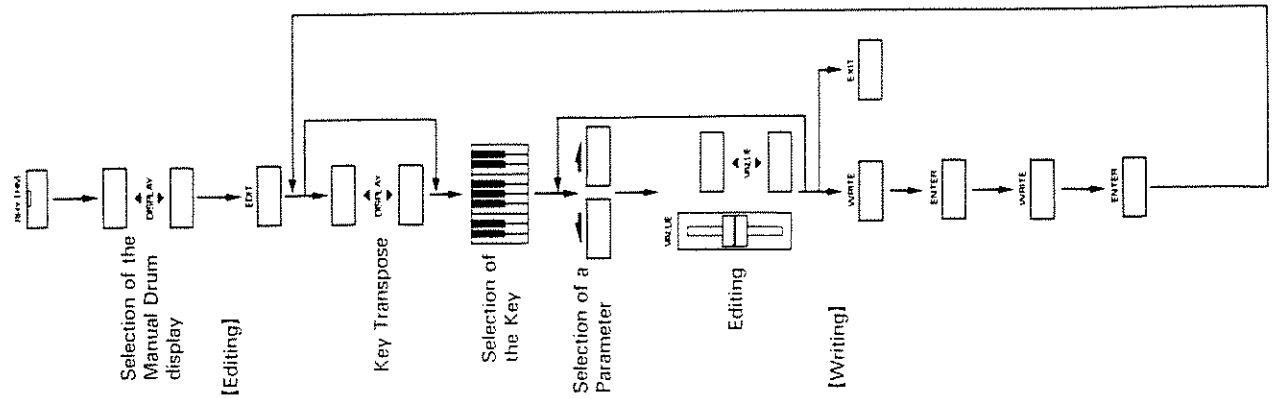

Rhythm Pattern

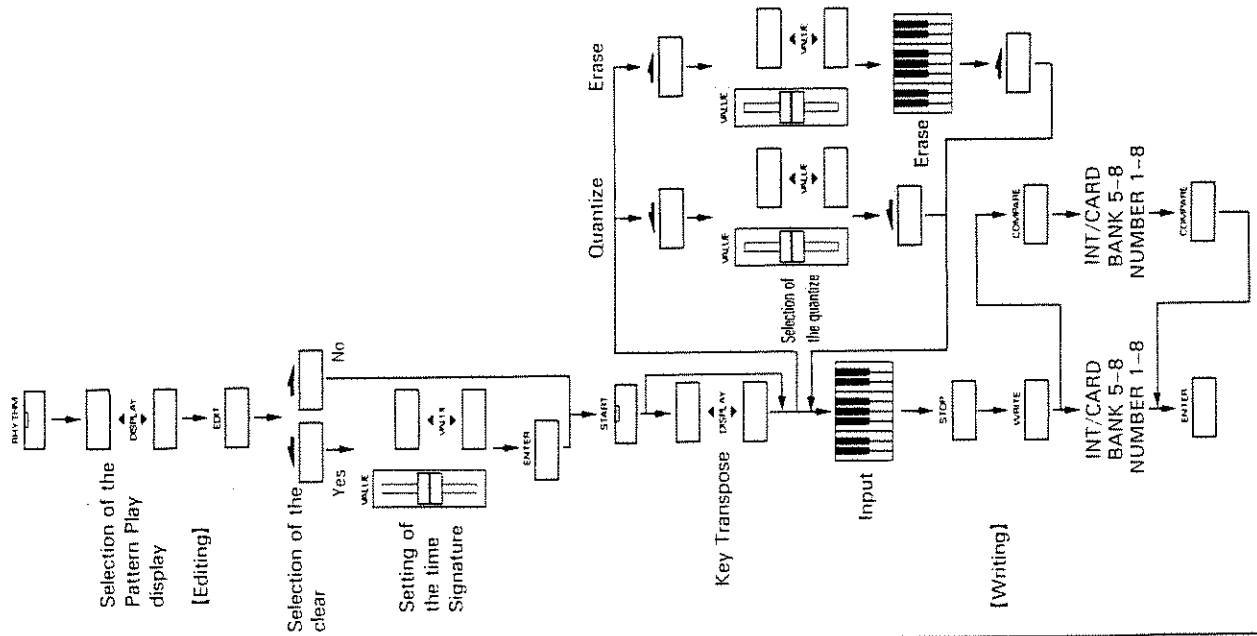

Recording onto the rhythm track

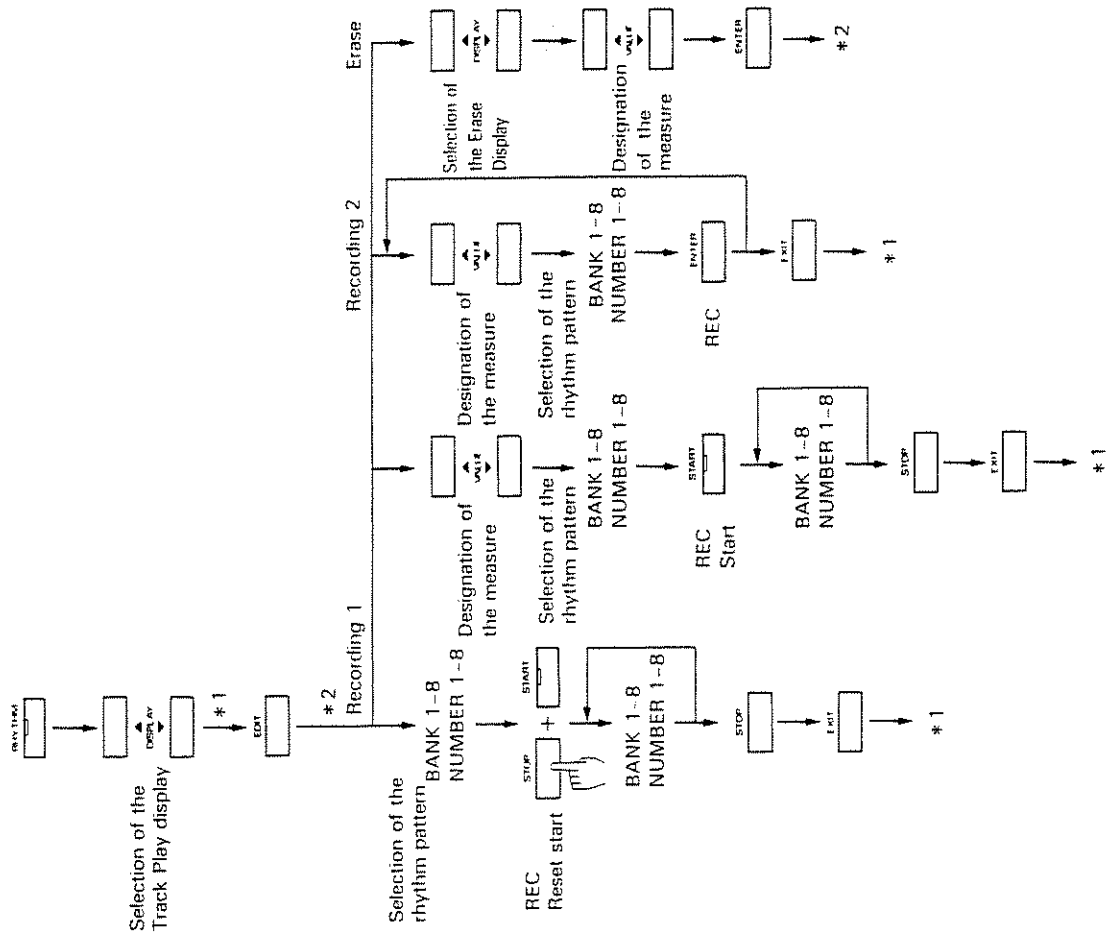

D-10/D-20 TIMBRE SOUND CHART (MULTI TIMBRAL MODE)

Program Change No.
Tone No. / Name
(Number of Partials)

プログラム・チェンジ・ナンバー
トーン・ナンバー / ネーム
(パーシャル数)

A Group

No. BANK	1	2	3	4	5	6	7	8
1	001 a01:AcouPiano1 (3)	002 a02:AcouPiano2 (2)	003 a03:AcouPiano3 (2)	004 a04:Honky-Tonk (3)	005 a05:ElecPiano1 (3)	006 a06:ElecPiano2 (3)	007 a07:ElecPiano3 (2)	008 a08:ElecPiano4 (1)
2	009 a09:ElecOrgan1 (4)	010 a10:ElecOrgan2 (2)	011 a11:ElecOrgan3 (2)	012 a12:ElecOrgan4 (1)	013 a13:PipeOrgan1 (3)	014 a14:PipeOrgan2 (3)	015 a15:PipeOrgan3 (2)	016 a16:Accordion (2)
3	017 a17:Harpsi 1 (3)	018 a18:Harpsi 2 (2)	019 a19:Harpsi 3 (1)	020 a20:Clav 1 (3)	021 a21:Clav 2 (2)	022 a22:Clav 3 (2)	023 a23:Celesta 1 (3)	024 a24:Celesta 2 (2)
4	025 a25:Violin 1 (3)	026 a26:Violin 2 (2)	027 a27:Cello 1 (3)	028 a28:Cello 2 (2)	029 a29:Contrabass (2)	030 a30:Pizzicato (3)	031 a31:Harp 1 (3)	032 a32:Harp 2 (2)
5	033 a33:Strings 1 (4)	034 a34:Strings 2 (3)	035 a35:Strings 3 (2)	036 a36:Strings 4 (3)	037 a37:Brass 1 (4)	038 a38:Brass 2 (3)	039 a39:Brass 3 (4)	040 a40:Brass 4 (4)
6	041 a41:Trumpet 1 (3)	042 a42:Trumpet 2 (2)	043 a43:Trombone 1 (3)	044 a44:Trombone 2 (2)	045 a45:Horn (3)	046 a46:Fr Horn (2)	047 a47:Engl Horn (2)	048 a48:Tuba (2)
7	049 a49:Flute 1 (4)	050 a50:Flute 2 (2)	051 a51:Piccolo (3)	052 a52:Recorder (2)	053 a53:Pan Pipes (3)	054 a54:Bottleblow (4)	055 a55:Breathpipe (4)	056 a56:Whistle (2)
8	057 a57:Sax 1 (2)	058 a58:Sax 2 (2)	059 a59:Sax 3 (2)	060 a60:Clarinet 1 (2)	061 a61:Clarinet 2 (3)	062 a62:Oboe (3)	063 a63:Bassoon (2)	064 a64:Harmonica (2)

B Group

No. BANK	1	2	3	4	5	6	7	8
1	065 b01:Fantasy (4)	066 b02:Harmo Pan (4)	067 b03:Chorale (3)	068 b04:Glasses (3)	069 b05:Soundtrack (4)	070 b06:Atmosphere (4)	071 b07:Warm Bell (4)	072 b08:Space Horn (4)
2	073 b09:Echo Bell (3)	074 b10:Ice Rains (4)	075 b11:Oboe 2002 (2)	076 b12:Echo Pan (2)	077 b13:Bell Swing (3)	078 b14:Reso Synth (2)	079 b15:Steam Pad (3)	080 b16:VibeString (4)
3	081 b17:Syn Lead 1 (4)	082 b18:Syn Lead 2 (2)	083 b19:Syn Lead 3 (3)	084 b20:Syn Lead 4 (2)	085 b21:Syn Bass 1 (3)	086 b22:Syn Bass 2 (2)	087 b23:Syn Bass 3 (2)	088 b24:Syn Bass 4 (3)
4	089 b25:AcouBass 1 (2)	090 b26:AcouBass 2 (1)	091 b27:ElecBass 1 (2)	092 b28:ElecBass 2 (2)	093 b29:SlapBass 1 (2)	094 b30:SlapBass 2 (3)	095 b31:Fretless 1 (4)	096 b32:Fretless 2 (2)
5	097 b33:Vibe (2)	098 b34:Glock (3)	099 b35:Marimba (3)	100 b36:Xylophone (2)	101 b37:Guitar 1 (3)	102 b38:Guitar 2 (3)	103 b39:Elec Gtr 1 (4)	104 b40:Elec Gtr 2 (4)
6	105 b41:Koto (2)	106 b42:Shamisen (2)	107 b43:Jamisen (2)	108 b44:Sho (4)	109 b45:Shakuhachi (4)	110 b46:WadaikoSet (4)	111 b47:Sitar (4)	112 b48:Steel Drum (4)
7	113 b49:Tech Snare (4)	114 b50:Elec Tom (4)	115 b51:Revrsr Cym (2)	116 b52:Ethno Hit (4)	117 b53:Timpani (2)	118 b54:Triangle (2)	119 b55:Wind Bell (3)	120 b56:Tube Bell (4)
8	121 b57:Orche Hit (4)	122 b58:Bird Tweet (1)	123 b59:OneNoteJam (4)	124 b60:Telephone (1)	125 b61:Typewriter (2)	126 b62:Insect (2)	127 b63:WaterBells (3)	128 b64:JungleTune (4)

D-10/D-20 PATCH SOUND CHART

(PERFORMANCE MODE)

Program Change No. Key Mode
Patch Name
Tone No. (Number of Partials)

プログラム・チェンジ・ナンバー キー・モード
パッチ・ネーム
トーン・ナンバー (パーシャル数)

A Group

No. BANK	1	2	3	4	5	6	7	8
1	001 WHOLE Warm Pad Fade U:i17(4)	002 WHOLE Steam Pad U:b15(3)	003 DUAL Sigh in Big City L:i32(2)U:a56(2)	004 DUAL Warm Ensemble L:a46(2)U:a34(3)	005 WHOLE Inner Wood U:i13(4)	006 DUAL Hollow Koto L:b41(2)U:i19(4)	007 DUAL Brassy Vox L:i29(2)U:i22(2)	008 DUAL Ensemble Series L:i05(4)U:i20(2)
2	009 WHOLE Rich Piano U:a01(3)	010 DUAL Elec Piano L:a03(2)U:a07(2)	011 WHOLE Touch Piano U:i01(4)	012 WHOLE Synth Piano U:i02(4)	013 WHOLE Honky-Tonk Piano U:a04(3)	014 DUAL Funky Clav L:a22(2)U:a22(2)	015 DUAL Rich Harpsichord L:a18(2)U:a19(1)	016 WHOLE Pick Guitar U:i12(3)
3	017 DUAL Bright Brass L:a57(2)U:a40(4)	018 WHOLE Soft Brass U:i08(4)	019 DUAL Big ol' Brass L:i22(2)U:i22(2)	020 WHOLE Fighting Brass U:a39(4)	021 SPLIT Trumpet Section L:a41(3)U:a42(2)	022 DUAL Trombone Section L:a44(2)U:a43(3)	023 DUAL Low Brass L:a45(3)U:a38(3)	024 DUAL Velo-Brass L:b23(2)U:i07(2)
4	025 DUAL Joyful Times L:b07(4)U:b33(2)	026 DUAL Vibe Strings L:b16(4)U:a35(2)	027 WHOLE Fantasy Bell U:b01(4)	028 WHOLE Harmonicity U:b02(4)	029 WHOLE Chatter Glasses U:b04(3)	030 WHOLE Ice Rains ... U:b10(4)	031 WHOLE Rich Wood U:i11(4)	032 WHOLE Echo Bell U:b09(3)
5	033 WHOLE Fat Lead U:b17(4)	034 DUAL Square-Wave Lead L:i25(2)U:b20(2)	035 WHOLE Brassy Lead U:b18(2)	036 WHOLE Bright Power U:i18(4)	037 DUAL Bend me 5ths L:i14(3)U:i14(3)	038 DUAL Clav+Organ Lead L:a21(2)U:a11(2)	039 DUAL Metalized Dist L:i24(2)U:i27(4)	040 DUAL Neat Lead L:i39(4)U:i23(2)
6	041 WHOLE Native Dance Pt2 U:i09(4)	042 WHOLE Nightmare U:i10(4)	043 DUAL Velo-Oct Synth L:b14(2)U:b14(2)	044 DUAL Resonance Sweep L:i21(2)U:i21(2)	045 DUAL Fat Synth Bass L:i37(2)U:i36(2)	046 DUAL Fretless Bassoio L:b32(2)U:i34(3)	047 SPLIT Vari Chopper! L:b29(2)U:i38(4)	048 WHOLE Timbass U:i35(3)
7	049 DUAL Balinese Hit! L:b55(3)U:b52(4)	050 WHOLE Shiny Steel Drum U:b48(4)	051 DUAL Ethnic Session L:b47(4)U:b41(2)	052 SPLIT Japanese Duo L:b43(2)U:b45(4)	053 WHOLE Wadaiko U:b46(4)	054 WHOLE Sho U:b44(4)	055 DUAL Koto L:b41(2)U:b41(2)	056 DUAL Shamisen L:b42(2)U:b42(2)
8	057 WHOLE Bubble Perc U:i62(2)	058 WHOLE Drop Hit! U:i41(4)	059 WHOLE Timbales U:i49(3)	060 WHOLE Conga Set U:i50(3)	061 WHOLE Metal Drum U:i51(2)	062 SPLIT < Cave'n Drum > L:b50(4)U:b49(4)	063 SPLIT Cymbal Special? L:i55(2)U:i54(4)	064 WHOLE < Drums Set > U:i56(4)

B Group

No. BANK	1	2	3	4	5	6	7	8
1	065 WHOLE Tenor Voices U:i28(4)	066 WHOLE Voxy Women Sing U:i30(4)	067 WHOLE Breath Choir U:i31(4)	068 DUAL Chorale Strings L:b03(3)U:a36(3)	069 WHOLE Atmosphere U:b06(4)	070 WHOLE Good Night ... U:i44(4)	071 DUAL New Age Harp L:i43(1)U:i42(2)	072 WHOLE Panning Echo U:b12(2)
2	073 DUAL Crystal Celesta L:a24(2)U:a32(2)	074 DUAL Xylocken Mallet L:b34(3)U:b36(2)	075 DUAL Southern Wind L:i45(2)U:b54(2)	076 WHOLE Tropical Mallet U:b35(3)	077 WHOLE Native Perc U:i52(2)	078 DUAL Hammer Bells L:b56(4)U:i45(2)	079 DUAL Bell Celesta L:i43(1)U:a23(3)	080 DUAL Tiny Hammer L:i43(1)U:i46(3)
3	081 DUAL Bowed Strings L:a25(3)U:a35(2)	082 DUAL Violin-Strings L:a26(2)U:a33(4)	083 WHOLE Cellist U:a27(3)	084 SPLIT ContraBass-Cello L:a29(2)U:a28(2)	085 WHOLE Rain Harp U:a31(3)	086 WHOLE Pizzicato U:a30(3)	087 WHOLE X-mod Strings U:i06(4)	088 WHOLE Deep Ana-Strings U:i05(4)
4	089 WHOLE Elec Organ U:a09(4)	090 WHOLE Rotor Organ U:i03(4)	091 SPLIT Hall Organ L:a15(2)U:a13(3)	092 DUAL Pfgorgan L:a08(1)U:a12(1)	093 WHOLE Moss Organ U:i04(4)	094 DUAL Str-organ L:a35(2)U:a10(2)	095 DUAL Rock'n'Roll EG L:i40(4)U:b40(4)	096 WHOLE Harmonica U:a64(2)
5	097 WHOLE Concert Flute U:a49(4)	098 SPLIT Flute-Piccolo L:a50(2)U:a51(3)	099 WHOLE Pan Pipes U:a53(3)	100 SPLIT Breath Ensemble L:a55(4)U:a54(4)	101 SPLIT Sax Duo L:a59(2)U:a58(2)	102 SPLIT Master Clarinet L:a60(2)U:a61(3)	103 SPLIT Bassoon-Oboe L:a63(2)U:a62(3)	104 WHOLE Blow Pipes U:i15(3)
6	105 SPLIT Brass Combo L:b22(2)U:a37(4)	106 SPLIT Ac-Bass & Vibe L:b25(2)U:b33(2)	107 SPLIT Synth Combo L:b24(3)U:i16(4)	108 SPLIT Acoustic Club L:b37(3)U:a52(2)	109 SPLIT Funky Slapping L:b29(2)U:i40(4)	110 SPLIT SpSax + FrisBass L:b31(4)U:a57(2)	111 SPLIT Tango Passion L:a16(2)U:b37(3)	112 SPLIT Hoppin' Poppin! L:b21(3)U:i26(3)
7	113 DUAL Orchestra Hit! L:b53(2)U:b57(4)	114 SPLIT Go Against! L:i47(1)U:b51(2)	115 DUAL Resound Big"B" L:i45(2)U:i48(2)	116 WHOLE Water Bells U:b63(3)	117 WHOLE Jungle Tune U:b64(4)	118 WHOLE Lonely Wolf U:i63(1)	119 WHOLE Tweeting Bird U:b58(1)	120 WHOLE Insects Sing U:b62(2)
8	121 WHOLE Attack! Attack! U:i57(3)	122 SPLIT Office Operator L:b60(1)U:b61(2)	123 WHOLE Scene of Battle U:i58(3)	124 WHOLE Very Busy ...! U:i59(3)	125 WHOLE One Note Jam! U:b59(4)	126 WHOLE Stormy Sunday U:i60(4)	127 WHOLE Ironworks U:i61(4)	128 WHOLE Seashore ... U:i64(4)

Roland®

10680

UPC 10680



10901

Roland®