

SEGA™

GENESIS™

32X

INSTRUCTION MANUAL

WARNING

This unit operates only with NTSC televisions purchased in North and South America (except Argentina, Paraguay and Uruguay). It will not operate with any other televisions.

EPILEPSY WARNING

WARNING: READ BEFORE USING YOUR SEGA VIDEO GAME SYSTEM

A very small percentage of individuals may experience epileptic seizures when exposed to certain light patterns or flashing lights. Exposure to certain patterns or backgrounds on a television screen or while playing video games may induce an epileptic seizure in these individuals. Certain conditions may induce undetected epileptic symptoms even in persons who have no history of prior seizures or epilepsy. If you, or anyone in your family, has an epileptic condition; consult your physician prior to playing.

If you experience any of the following symptoms while playing a video game: dizziness, altered vision, eye or muscle twitches, loss of awareness, disorientation, any involuntary movement, or

convulsion, IMMEDIATELY discontinue use and consult your physician before resuming play.

WARNING TO OWNERS OF PROJECTION TELEVISIONS

Still pictures or images may cause permanent picture-tube damage or mark the phosphor of the CRT. Avoid repeated or extended use a video games on large-screen projection televisions. Consult your owner's manual before playing video games on your projection television.

GAME PLAY ASSISTANCE AND INFORMATION

For expert game play assistance or information on other Sega products, call the Sega experts at: **1-415-591-PLAY**.

IF YOU NEED HELP

Read this manual thoroughly before connecting your Genesis 32X. you have difficulties, first consult the Troubleshooting chart. For service, call the Sega Consumer Service Department at: **1-800-USA-SEGA**

Introduction

The Genesis 32X™ is a compact 32-bit power adaptor that brings you graphics that have never before been seen at home. More on-screen action, incredible 3-D graphics and views from amazing perspectives!
The following types of software can be used with the Genesis 32X:

- Genesis 32X cartridges
- Sega CD 32X™ discs (With the Sega CD™ connected to your Genesis™)
- Genesis cartridges
- Sega CD discs, music CDs, CD+G discs (with the Sega CD connected to your Genesis)

You can connect your Genesis 32X to the following hardware:

- Genesis, original or new model
- Sega CD, original or new model (when connected to your Genesis)
- Genesis CDX (optional Spacer for Genesis CDX is required)

For information on connecting the Genesis 32X to other compatible models, please contact the respective manufacturer.

Unpacking your Genesis 32X

Use the checklist below to make sure you have all the components of your Genesis 32X.

- Genesis 32X Unit
- Connector Cable
- Conversion Cable
- Sega Audio/Video Cable (mono)
- Spacer for New Genesis Model
- AC Adaptor
- Electromagnetic Shield Plates (front and rear)
- Instruction Manual (this booklet)
- Consumer Reply Card
- Discount Coupons (6 \$10 coupons)

Caution

The Spacer for New Genesis Model is specifically designed for the new Genesis model. Using the spacer with other models will damage your unit.

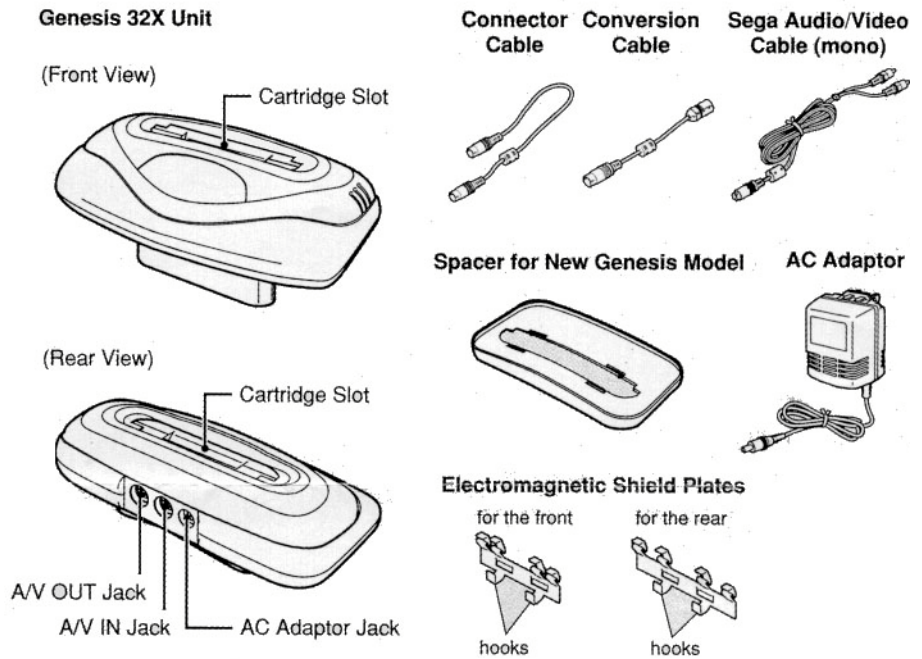

Connecting the Electromagnetic Shield plates

If you own the original Genesis model or the new Genesis model, you need to connect the supplied electromagnetic shield plates to both sides of the cartridge slot before inserting the Genesis 32X.

Note: Take care not to injure yourself when handling the electromagnetic shield plates.

1. Take the longer electromagnetic shield plate (for the rear) as shown in the diagram.
2. Pass the hooks of the electromagnetic shield plate through the flap of the cartridge slot.
3. Affix the electromagnetic shield plate to the flap of the cartridge slot.
4. Follow the same procedure for the shorter electromagnetic shield plate (for the front).

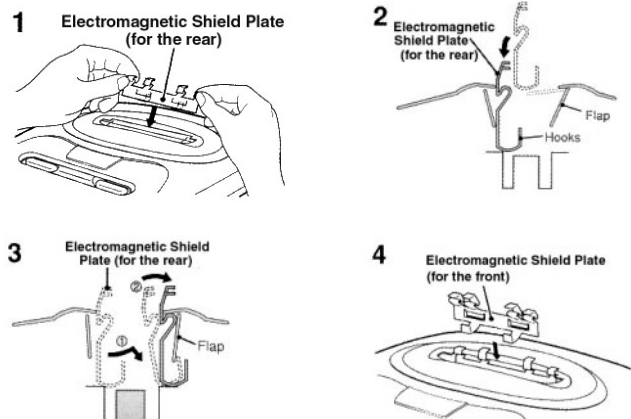

Connecting the Genesis 32X

If your Genesis set-up appears to the right, see "Connecting to the Original Genesis Model."

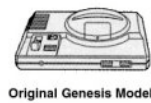

Original Genesis Model



Original Genesis Model and Original Sega CD Model

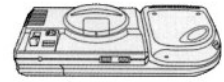

Original Genesis Model and New Sega CD Model

If your Genesis set-up appears to the right, see "Connecting to the New Genesis Model."



New Genesis Model

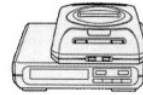

New Genesis Model and Original Sega CD Model

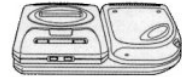

New Genesis Model and New Sega CD Model

If you own a Genesis CDX, see "Connecting to the Genesis CDX."



Genesis CDX

Notes:

1. Take care to insert the Genesis 32X between the front and rear electromagnetic shield plates.
2. The most recent version of the new Genesis model cannot be connected to the original Sega CD model. For further details, refer to your new Genesis model instruction manual.

Connecting to the Original Genesis Model

Please check the following before you connect your Genesis 32X to your original Genesis model: -

- Is your Genesis properly connected to your TV?
- When using your Sega CD, is your Genesis connected properly to your Sega CD?

If you answered "Yes" to both of the questions, turn the Power Button OFF, and unplug the AC Adaptors from the electrical outlets.

1. Disconnect the Sega Auto RF Switch Box (or Sega Video Monitor Cable) from the Genesis and TV.
2. **Firmly** insert the Genesis 32X into the cartridge slot on the Genesis.
3. Connect the supplied Conversion Cable to the supplied Connector Cable.
4. Connect the free end of the Conversion Cable to the AN OUT Jack on the Genesis. Connect the free end of the Connector Cable to the AN IN Jack on the Genesis 32X. **Take care not to plug the Connector Cable into the A/V OUT Jack on the Genesis 32X.**

5. To continue, see "Connecting Your TV".

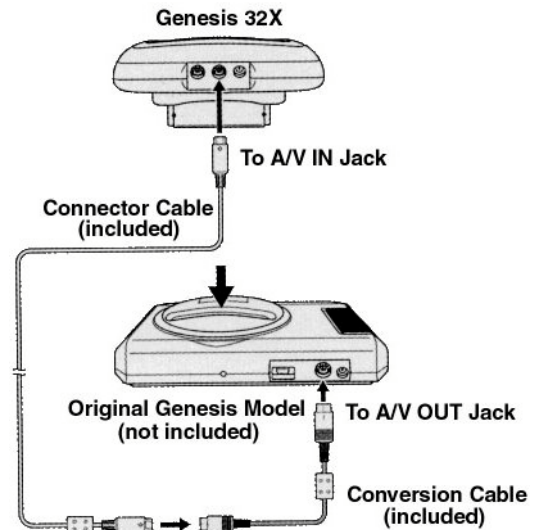

Connecting to the New Genesis Model

Please check the following before you connect your Genesis 32X to your new Genesis model:

- Is your Genesis properly connected to your TV?
- When using your Sega CD, is your Genesis connected properly to your Sega CD?

If you answered "Yes" to both of the questions, turn the Power Button OFF, and unplug the AC Adaptors from the electrical outlets.

1. Disconnect the Sega RF Unit (or Sega Audio/Video Cable) from the Genesis and TV.
2. Connect the supplied Spacer for New Genesis Model to the Genesis 32X.
3. **Firmly** insert the Genesis 32X into the cartridge slot on the Genesis.
4. Plug one end of the supplied Connector Cable into the A/V OUT Jack on the Genesis and plug the other end into the A/V IN Jack on the Genesis 32X. **Take care not to plug the Connector Cable Into the A/V OUT Jack on the Genesis 32X.**
5. To continue, see "Connecting Your TV."

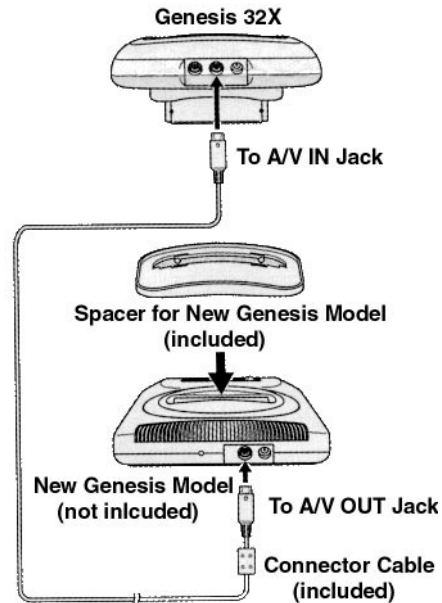

Connecting to the Genesis CDX

Please check the following before you connect your Genesis 32X to your Genesis CDX:

- Is your Genesis properly connected to your TV?

If you answered "Yes," turn the Power Button OFF, and unplug the AC Adaptors from the electrical outlets.

- Disconnect the Sega Stereo Audio/Video Cable (or Sega RF Unit) from the Genesis CDX and your TV
- Connect the optional Spacer for Genesis CDX to the Genesis 32X
- **Firmly** insert the Genesis 32X in the cartridge slot on the Genesis
- Plug one end of the supplied Connector Cable into the A/V OUT Jack on the Genesis CDX and the other end into the A/V IN Jack on the Genesis 32X. Take care not to plug the Connector Cable into the A/V OUT Jack on the Genesis 32X.
- To continue, see "Connecting Your TV."

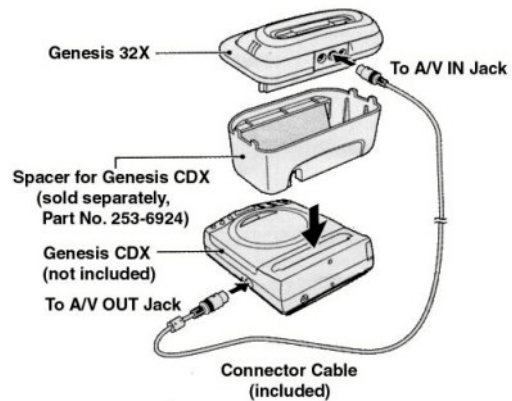

Note: Information for the Spacer for Genesis CDX is available by calling 1-800-USA SEGA.

Connecting Your TV

There are various types of TV sets and antenna terminals. Compare your TV to the illustrations below to decide which procedure is necessary.

TV (or VCR) with Video and Mono Audio Input Jacks

If your TV has Video and Mono Audio Input Jacks (usually on the back of recent models), you can use the supplied Sega Audio/Video Cable.

1. Insert the single-plug end of the Audio/Video Cable in the AV OUT Jack on the Genesis 32X.
2. Insert the **yellow** plug of the Audio/Video Cable into the composite TV or monitor's Video IN Jack (or into the VCR Video IN Jack). Insert the **white** plug into the TV or monitor's Audio IN Jack (or into the VCR Audio IN Jack).
3. Select the Audio/Video Input setting on your TV (or VCR) when playing the Genesis 32X.
4. To continue, see "Powering Up the System."

3. Plug the RF Cable into the AV OUT Jack on the back of the Genesis 32X.
4. To set the channel on your TV, see "Setting the TV Channel" in your Genesis or RF Unit instruction manual.
5. To continue, see "Powering Up the System."

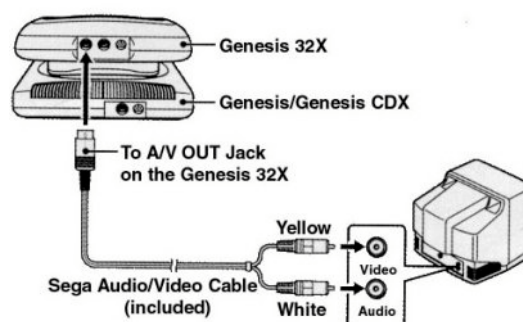

TV without Audio/Video Inputs

If a single-plug Antenna Cable is plugged into your TV (or if you have Cable TV), use the Sega RF Unit which is included in your Genesis package.

Note: The RF Unit comes with the **new Genesis model only**. The Sega Auto RF Switch Box for the original Genesis model CANNOT be used. To purchase a Sega RF Unit (Model No. 1632), contact your Sega dealer.

1. Unplug the Antenna Cable from the TV, and plug it into the RF Unit.
2. Plug the RF Unit Antenna Cable into the TV.

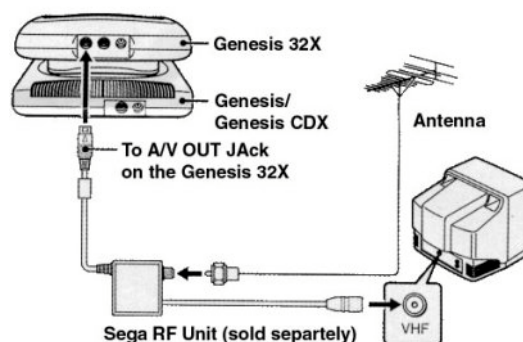

Note: Connecting the Genesis 32X to the TV is the same as connecting the Genesis to the TV. If your TV isn't mentioned above, see your Genesis instruction manual.

Powering Up the System

1. Connect the AC Adaptor Plug to the Adaptor Jack on the back of the Genesis (or Genesis CDX) and Genesis 32X unit.
2. Plug the AC Adaptors into the electrical outlet or the Sega Power Strip. When you are using the Sega CD, plug its AC Adaptor into the electrical outlet also.

Caution: When using the Sega CD, there are three types of AC Adaptors, so take considerable care when connecting.

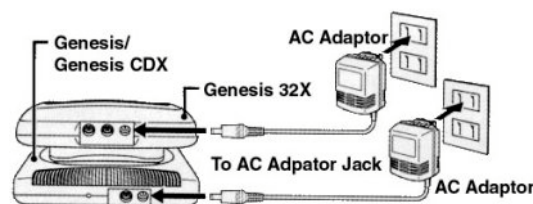

Operating the Genesis 32X

Playing Genesis 32X Cartridge Games

1. Insert a Genesis 32X cartridge, with the label facing forward, into the Genesis 32X cartridge slot. Press it firmly into the slot until the cartridge locks into place. Always turn the Genesis power button OFF before removing a game cartridge.
2. Turn the power to the TV ON.
3. Turn the Genesis Power Button ON
4. Press the RESET Button on the Genesis.
5. If all connections have been made properly, the Sega logo will appear, followed by the game's title screen. In most cases, a demonstration game will then begin.

Note: To play conventional Genesis 16-bit cartridge games, just insert the cartridge into the cartridge slot on the Genesis 32X. Before playing the 16-bit *Virtua Racing* game, remove the Genesis 32X from the Genesis unit.

Playing Sega CD 32X Games

1. Make sure that a game cartridge is NOT inserted in the Genesis 32X cartridge slot. If it is, the cartridge game will automatically be activated.
2. Turn on the power to the TV, then turn the Genesis Power Button ON.
3. To continue, refer to "Starting Up" in the Sega CD or Genesis CDX instruction manual.

Note: You can play conventional Sega CD games, music CDs and CD+G discs on your Sega CD without disconnecting the Genesis 32X.

Important

To Sega CD Users: When using cartridge software, leave the Sega CD AC Adaptor connected to an electrical outlet. However, always disconnect from an electrical outlet when not in use.

To Genesis CDX Users: Be careful not to damage the CD when inserting and removing the cartridge.

Saving Your games

If your Sega CD 32X or your Sega CD software has a save feature (often available in sports games and role-playing games), you can save your current game to the internal memory of the Sega CD or Genesis CDX or

cartridge memory for Sega CD (sold separately). Later, you can load the saved game and continue playing from where you left off. Refer to the Sega CD or Genesis CDX instruction manual for details.

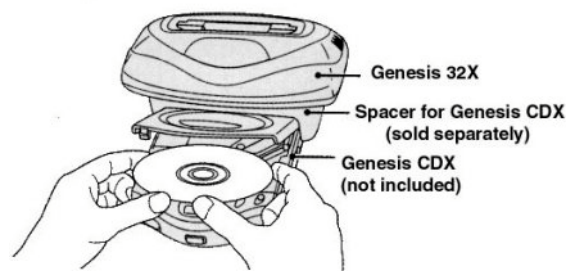
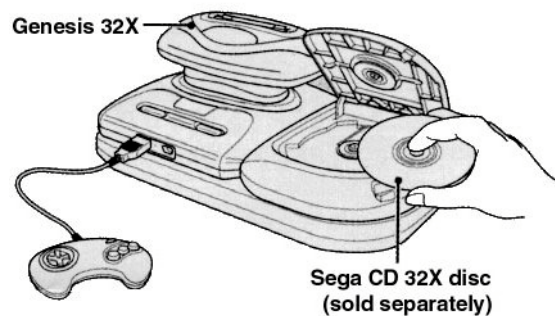
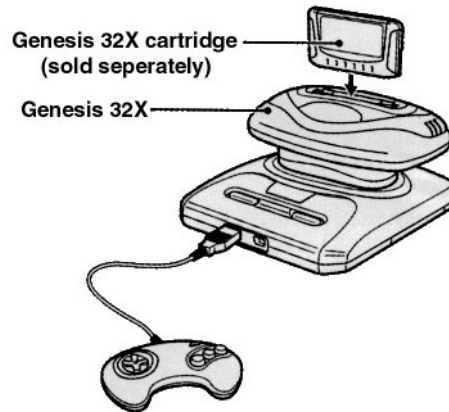

Be careful not to damage the CD when inserting and removing the cartridge.

Ending a Session

When ending a session using cartridge software:

1. Turn OFF the Power Button on the Genesis.
2. Remove the cartridge **holding down the Genesis 32X unit.**
3. Unplug all AC Adaptors from the electrical outlets.

When ending a session using CD software:

Sega CD 32X software functions the same as Sega CD software. For further details, see the Sega CD or Genesis CDX instruction manual.

Important: To prevent your units from wearing out, leave the Genesis 32X and/or the Sega CD connected to the Genesis unit.

The Genesis 32X Stereo Sound Connection

Attaching your Genesis and Genesis 32X to a stereo system dramatically increases the sound quality of audio discs and 32-bit games. It also enhances the sound performance of 16-bit games.

If your Genesis set-up appears below, see "To Connect Stereo Sound: Original Genesis Model."

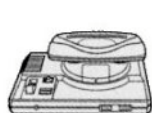

Genesis 32X
and Original Genesis Model



Genesis 32X,
Original Genesis Model
and Original Sega CD Model

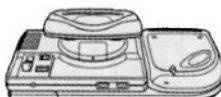

Genesis 32X,
Original Genesis Model
and New Sega CD Model

If your Genesis set-up appears below, see "To Connect Stereo Sound: New Genesis Model and Genesis CDX."



Genesis 32X
and New Genesis Model

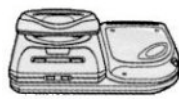

Genesis 32X,
New Genesis Model
and New Sega CD Model



Genesis 32X,
New Genesis Model
and Original Sega CD Model



Genesis 32X
and Genesis CDX

To Connect Stereo Sound: Original Genesis Model

Headphones or Mini-Speakers

Plug stereo headphones or mini-speakers with internal amplifiers into the Stereo Headphone Jack on the front of the Genesis. For further details, please refer to the Genesis instruction manual.

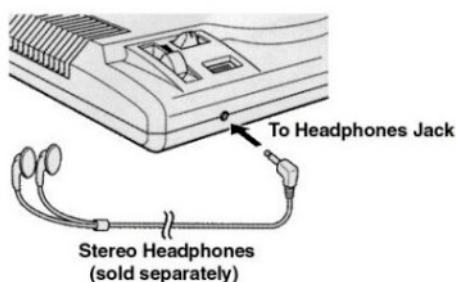

Sega CD and Home Stereo Systems or Portable Cassette Players

Use a mixing Cable and a standard 2-Pin RCA-type cable to connect your Sega CD system and your stereo system. For further details, please refer to the Sega CD instruction manual.

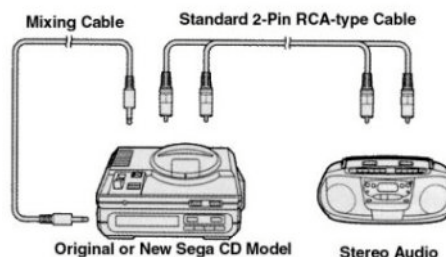

To Connect Stereo Sound: New Genesis Model and Genesis CDX

Stereo TV (or Stereo VCR)

1. Plug the single-end plug of the **Sega Stereo Audio/Video Cable** (sold separately) into the AV OUT Jack on the Genesis 32X.
2. Plug the **yellow** plug on the three-plug end to the Video Input Jack on your stereo TV or stereo VCR.
3. Plug the **white** plug to the left Audio Input Jack and connect the red plug to the right Audio Input Jack on your stereo TV or stereo VCR.

Note: When the Genesis 32X is connected to the Genesis CDX, you can get stereo signals either from

the LINE OUT Jack or PHONES Jack on the Genesis CDX.

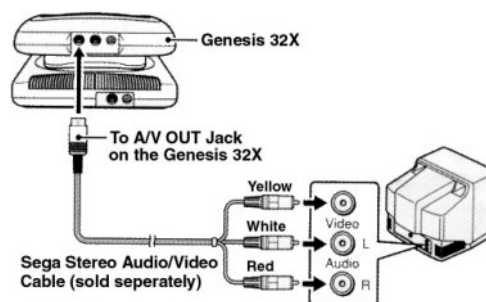

Maintaining Your Genesis 32X

The Genesis 32X's Location

- Keep your Genesis 32X out of direct sunlight and away from extreme hot or cold temperatures, such as near a heater or in an uninsulated garage.
- Do not let the Genesis 32X get wet. Avoid using it in humid areas. If condensation forms on the unit, wipe it dry and let the system rest for at least an hour before using it.

The Unit

- Be sure to turn the Genesis Power Button OFF when inserting or removing a cartridge.
- Do not attempt to insert another Genesis 32X or articles that aren't designed for the Genesis 32X into the cartridge slot on the Genesis 32X

- Do not take the unit apart or alter it in any way
- Do not drop the unit or pick it up by any connecting cable. Do not twist or pull the cables forcefully. Doing so may damage their connections.
- Clean the unit with a soft, moist cloth. Never use strong cleaning solutions or abrasives that could damage the components.

Power supply

- Use only the AC Adaptor supplied with your unit.
- When the AC Adaptor is not in use, unplug it from the electrical outlet.
- Always turn the Genesis Power Button OFF before connecting or disconnecting the Sega CD or Genesis 32X.

Troubleshooting

No picture and sound:

- Is the TV or monitor turned ON?
- Are the AC Adaptors connected to the Genesis 32X, Genesis and Sega CD?
- Are the AC Adaptors plugged into electrical outlets?
- Are the Genesis 32X and Sega CD **firmly** connected to the Genesis?
- Is the Genesis Power Button turned ON?
- Are all cable connections secure?
- Is the TV tuned to the appropriate channel ?
- Is the TV system switch on the RF Unit in the current position?
- Is the game cartridge **firmly** inserted in the Genesis 32X cartridge slot with the label facing forward?
- If connecting through the VCR -- is the VCR turned ON?
- If connecting through the VCR -- is the VCR set to receive line input?

Sega CD logo does not appear when the Sega CD or Sega CD 32X disc is Inserted:

- Is the game cartridge removed from the cartridge slot on the Genesis 32X?

Screen flickers or no color:

- Are the TV channel fine adjustments set properly?
- Are the TV color controls set properly?

No game sound:

- Is the TV volume too low or OFF?
- Have the connection cables come loose or been disconnected?
- Is the power switch on the audio system turned ON?

No picture:

- Are the Connector Cable and the Conversion Cable connected to the correct AV Jacks on the back of the Genesis 32X?

If you continue to have a problem, follow the instructions in this manual and carefully reconnect your Genesis 32X system. If the problem persists, please call the Sega Consumer Service Department at **1-800-USA-SEGA**

Genesis 32X Hardware Information

Physical Characteristics	
Power Usage	Genesis 32X AC Adaptor (DC 10V)
Elec. Consumption:	Approx. 4W
Usage Environment:	Temperature 5C to 35C Humidity 20% to 80% RH
Exterior Measurements:	Width 115 mm Length 210 mm Height 100 mm

Specifications	
CPU:	SH2 (23MHz) x 2
RAM:	2Mbit
Video RAM:	2Mbit
VDP:	Custom LSI, NTSC standard, 32,768 colors
Video output::	Video/RF/RGB
Sound Circuitry:	PWM sound source
Slot: Cartridge :	Slot

Note: Characteristics and specifications are subject to change.