

ORIGINAL VIDEO GAME

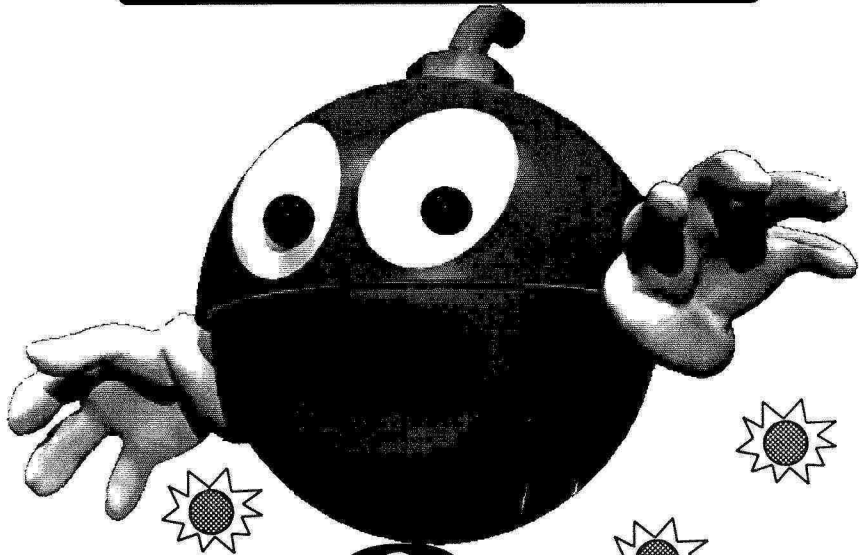

ZERO 2 POINT™

GUN SHOOTING GAME

OPERATOR'S

MANUAL

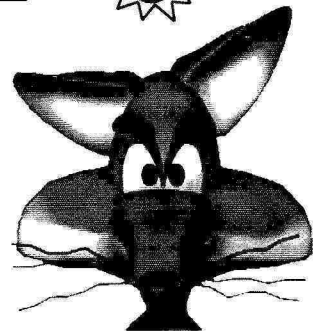

©1999 UNICO ELECTRONICS CO., LTD.

INTRODUCTION

1-1. EXPLANATION OF GAME SCREEN	_____	2
1-2. EXPLANATION OF THE SHOOTING GUN	_____	2
2-1. GAME SETTING SCREEN (BASIC)	_____	3
2-2. I/O CHECK SCREEN	_____	3
2-3. DIP SWITCH SETTING SCREEN	_____	4
2-4. SCREEN CHECK	_____	4
2-5. COLOR CHECK SCREEN	_____	5
2-6. SOUND CHECK SCREEN	_____	5
2-7. CALIBRATION SET SCREEN	_____	6
2-8. CALIBRATION CHECK SCREEN	_____	6
3-1. DIP SWITCH TABLE	_____	7
3-2. DIP SWITCH A	_____	7
3-3. DIP SWITCH B	_____	8
3-4. GUN CONNECTOR	_____	9
4-1. CONNECTOR SPEC	_____	10

1-1. EXPLANATION OF GAME SCREEN

"Move over video games, here's the real thing!"

Basic explanation of displays on the screen during the game.

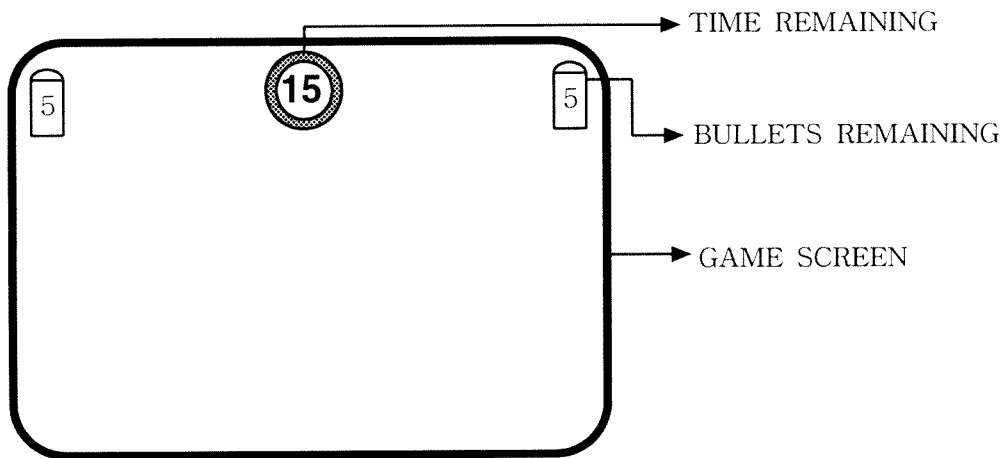

1-2. EXPLANATION OF THE SHOOTING GUN

*Everytime you shoot, the hammer of the gun will trigger like a real gun.

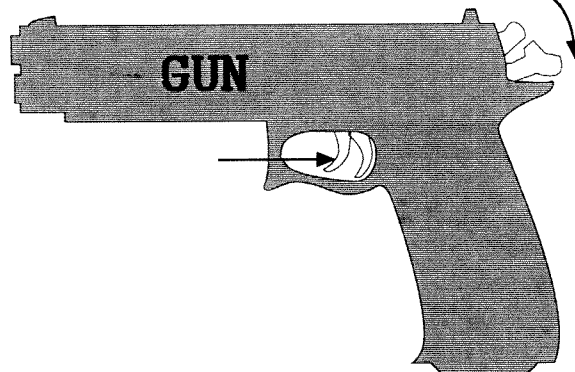

* WARNING *

Do not try to hold the hammer of the gun or move the hammer of the gun with your hand.

Do not hit, throw or any other way vandalize the gun.

Do not abuse or use excessive force against gun.

2-1. GAME SETTING SCREEN

Manually check and change the settings for the screen displays and game controls.

1. I/O CHECK
2. DIP SWITCH SETTING
3. SCREEN CHECK
4. COLOR CHECK
5. SOUND CHECK
6. CALIBRATION SETTING
7. CALIBRATION CHECK
8. FACTORY
9. EXIT

SELECT = 1P START
START = 2P START

2-2. I/O CHECK SCREEN

Mode for checking the performance of each control.

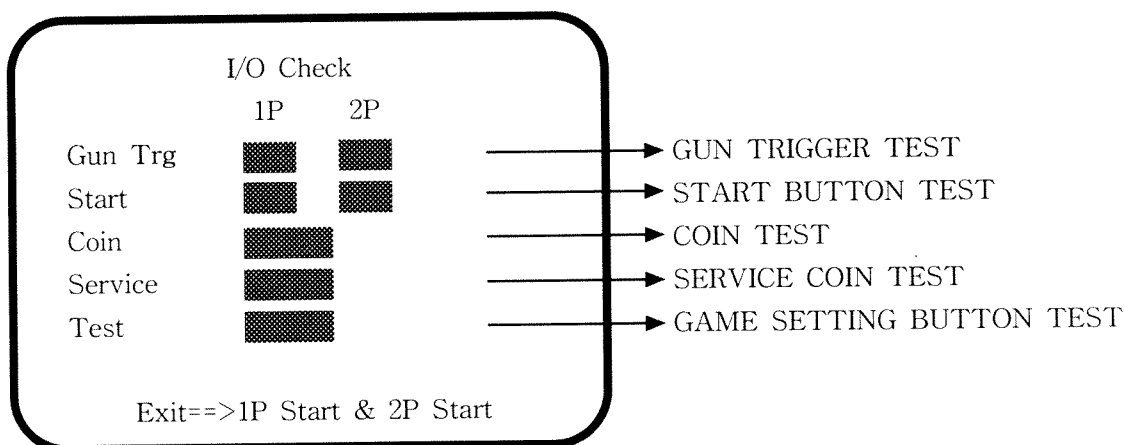

2-3. DIP SWITCH SETTING SCREEN

Dip switch setting mode.

When change the dip switch settings, set the dip switch by referring to the dip switch table.

DIP SWITCH SETTING



FREE PLAY = ON
DEMO SOUND = OFF
GUN LOADING = FACTORY



CREDIT COIN =
1 COIN 1CREDIT
DIFFICULTY = NORMAL
PLAYERS HEART = 4
CONTINUE MODE = ON
EXIT => 1P START

2-4. SCREEN CHECK

Mode the checking the state of screen

SCREEN CHECK

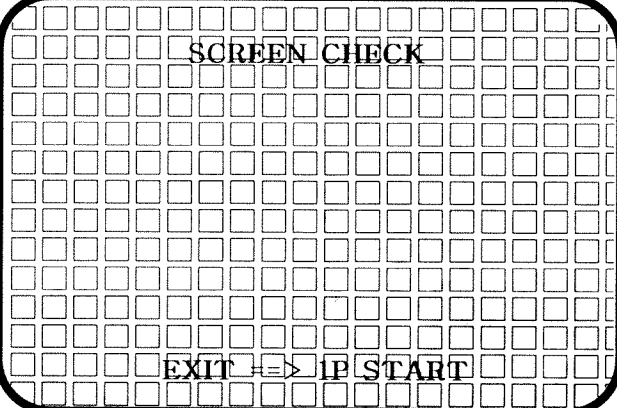

EXIT => 1P START

2-5. COLOR CHECK SCREEN

Mode for checking the display color.

The color of the color bars should appear properly graduated.

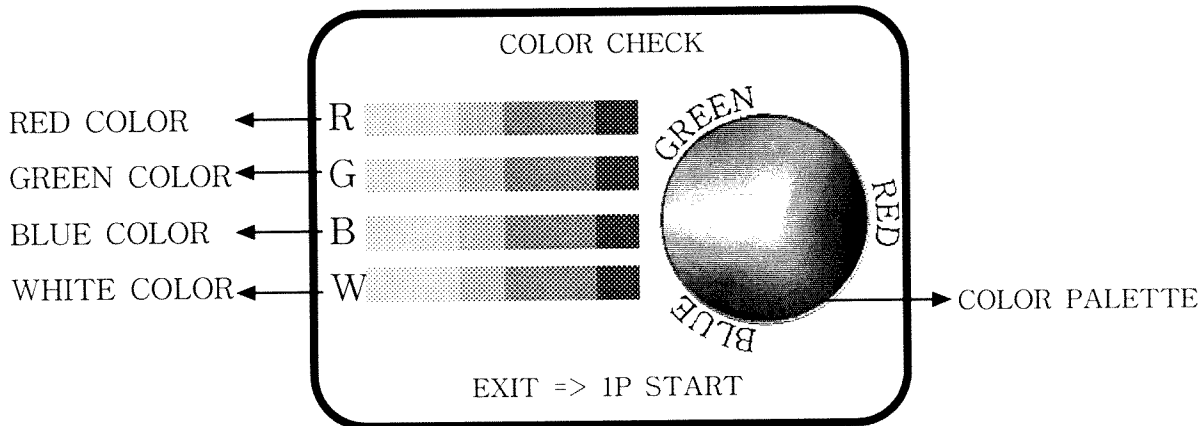

2-6. SOUND CHECK SCREEN

Mode the checking the sound & voice.

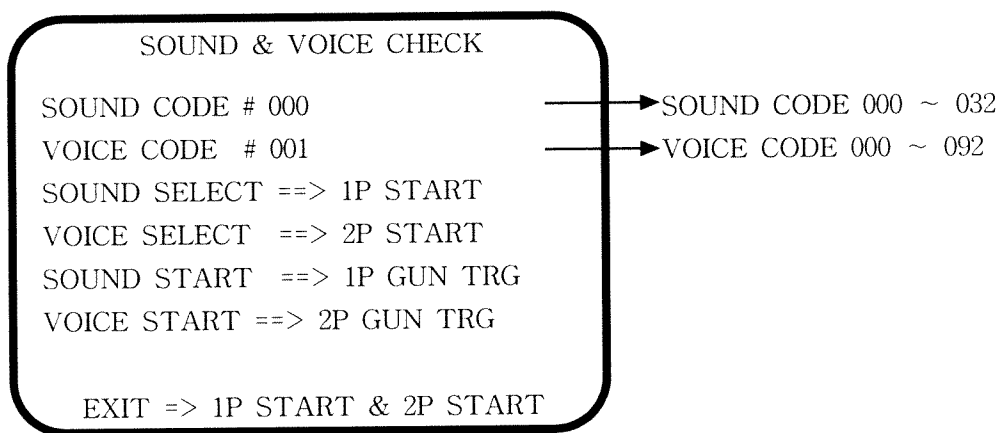

2-7. CALIBRATION SCREEN

Mode for setting up the shooting target point

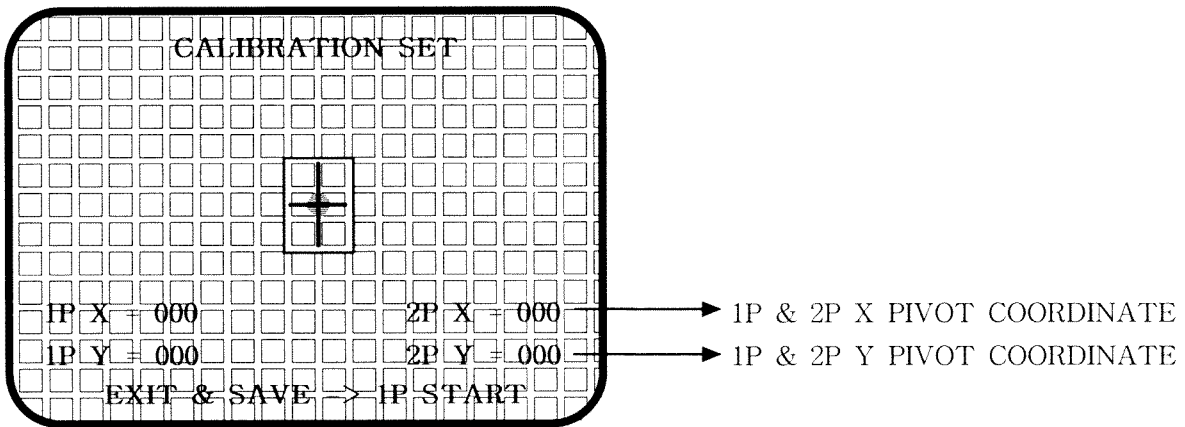

Save automatically when push "EXIT"

2-8. CALIBRATION CHECK SCREEN

Mode for checking the shooting target point.

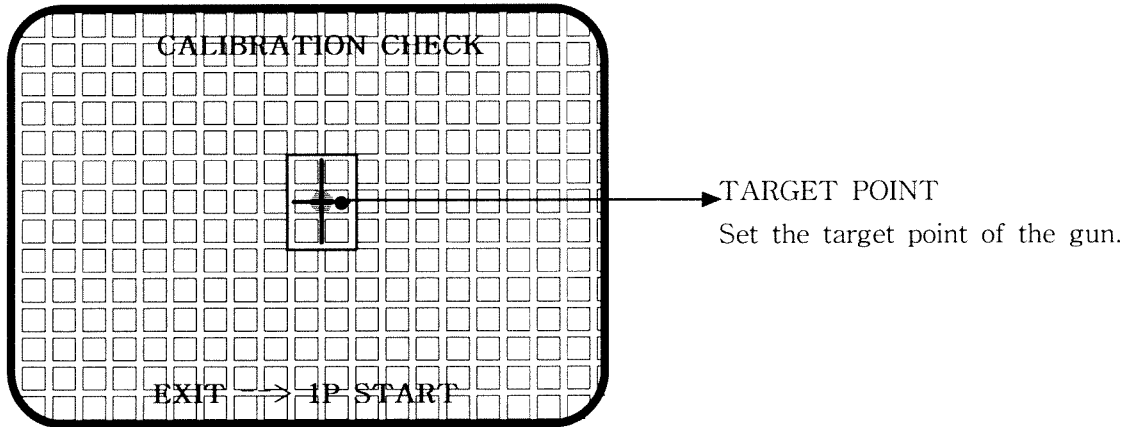

3-1. DIP SWITCH A

ITEM	DESCRIPTION	1	2	3	4	5	6	7	8
Free Play	On	ON							
Coin -Credit	1 Coin 1 Credit						OFF	OFF	OFF
	1 Coin 2 Credit						ON	OFF	OFF
	1 Coin 3 Credit						OFF	ON	OFF
	1 Coin 4 Credit						ON	ON	OFF
	2 Coin 1 Credit						OFF	OFF	ON
	3 Coin 1 Credit						ON	OFF	ON
	4 Coin 1 Credit						OFF	ON	ON
	5 Coin 1 Credit						ON	ON	ON
Continue Mode	1Coin 1Credit Continue 1Coin		ON						
	1Coin 2Credit Continue 1Coin		ON						
	1Coin 3Credit Continue 1Coin		ON						
	1Coin 4Credit Continue 1Coin		ON						
	2Coin 1Credit Continue 1Coin		ON						
	3Coin 1Credit Continue 1Coin		ON						
	4Coin 1Credit Continue 1Coin		ON						
	5Coin 1Credit Continue 1Coin		ON						
Gun Loading Mode	Factory Setting			OFF	OFF				
	Not-Reload			ON	OFF				
	Reload			OFF	ON				

3-2. DIP SWITCH B

ITEM	DESCRIPTION	1	2	3	4	5	6	7	8
Difficulty	Normal							OFF	OFF
	Easy							ON	OFF
	Hard							OFF	ON
	Very Hard							ON	ON
Player's Heart	4			OFF	OFF	OFF			
	5			ON	OFF	OFF			
	6			OFF	ON	OFF			
	2			ON	ON	OFF			
	3			OFF	OFF	ON			
Demo Sound	On		ON						

3-3. DIP SWITCH TABLE

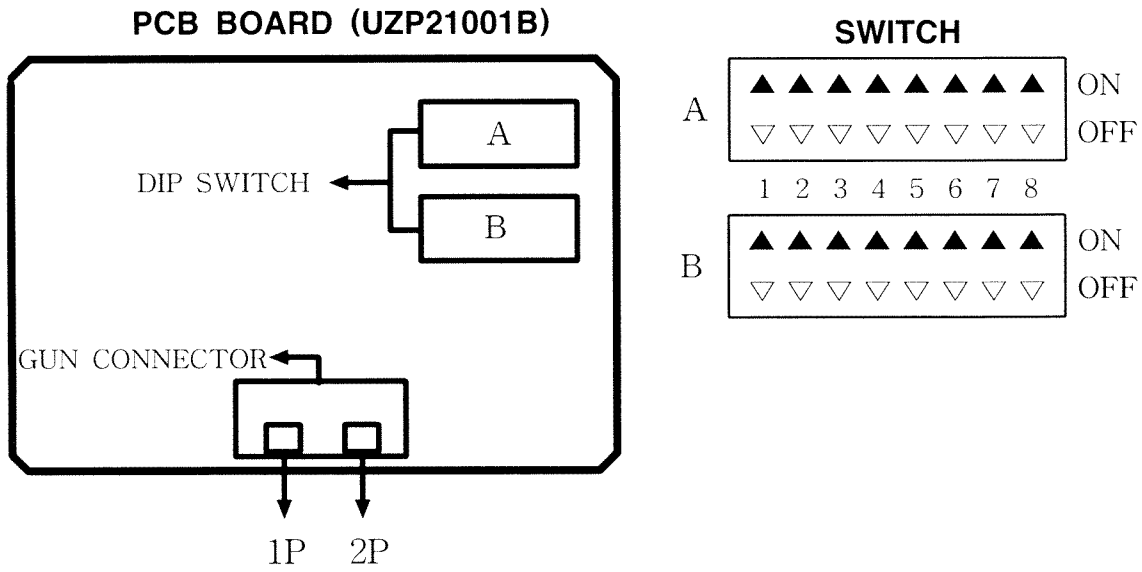

4-1. GUN CONNECTOR

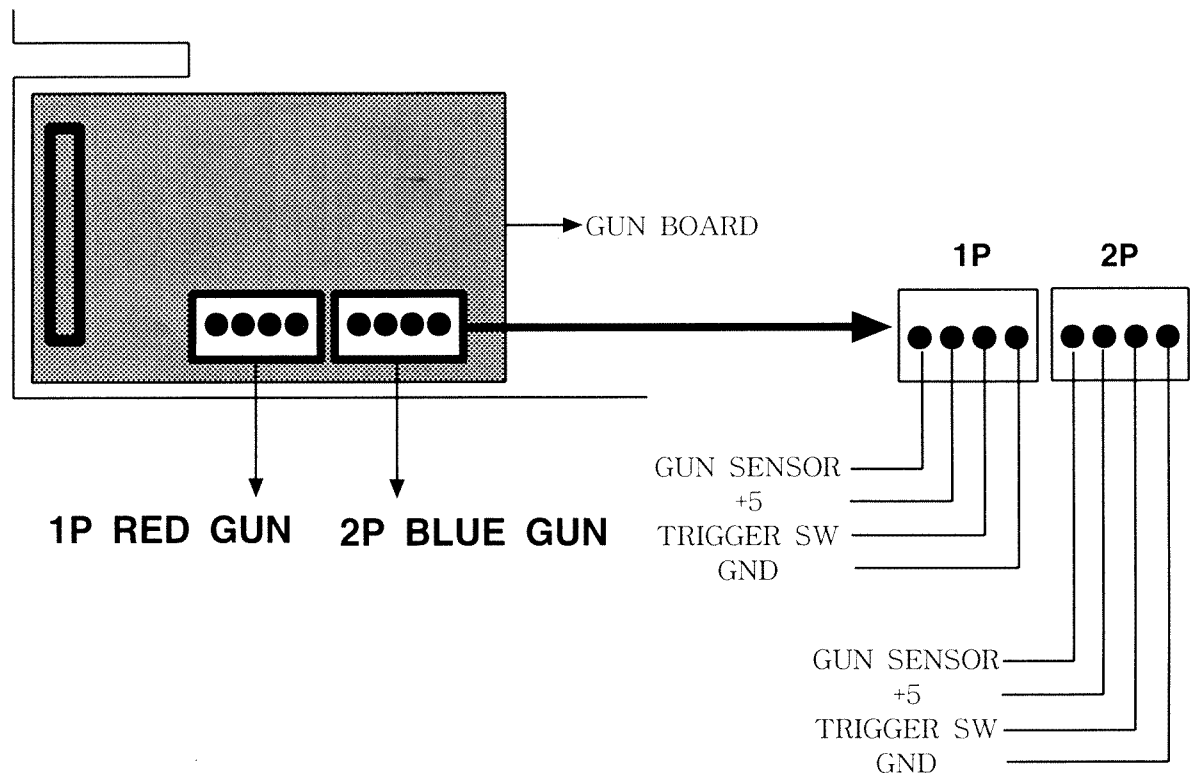

4-1. CONNECTOR SPEC

Solder Side	Terminal		Parts Side
GND	A	1	GND
GND	B	2	GND
+5	C	3	+5
+5	D	4	+5
	E	5	
+12	F	6	+12
	G	7	
	H	8	Coin Counter
2P Lamp	I	9	1P Lamp
Speaker (L)	J	10	Speaker (R)
	K	11	
Video GREEN	L	12	Video RED
Video SYNC	M	13	Video BLUE
Service SW	N	14	Video GND
NC	O	15	Test SW
2P Coin Switch	P	16	1P Coin Switch
2P Start	Q	17	1P Start
	R	18	
	S	19	
	T	20	
	U	21	
	V	22	
	W	23	
	X	24	
	Y	25	
	Z	26	
GND	a	27	GND
GND	b	28	GND

SPECIAL NOTICE

Sound wiring change

Please follow the speaker wiring instructions to avoid a distorted sound for the stereo.

The cabinet with one speaker:

Pin 10 goes to speaker and run ground to the negative side of speaker.

The cabinet with two speakers:

Pin 10 goes to the right speaker

Pin J goes to the left speaker and run a ground wire to the negative side of speakers.



GUN SHOOTING GAME
