

ADDS
Applied Digital Data Systems Inc.

VIEWPOINT/60
USER MANUAL

518-32300

VIEWPOINT®/60 USER MANUAL

November 1983

518-32300

**VIEWPOINT®/60
USER MANUAL**

This equipment complies with the requirements in Part 15 of FCC rules for a Class A computing device. Operation of this equipment in a residential area may cause unacceptable interference to radio and TV reception requiring the operator to take whatever steps are necessary to correct the interference.

Viewpoint is a registered trademark of Applied Digital Data Systems, Inc.

NOVEMBER 1983

This revision of the Viewpoint/60 User Manual supersedes the last issue dated JANUARY 1983.

A list of changed pages appears below, with a margin bar on affected text pages to indicate these changes.

There are no changes to this version of the Viewpoint/60 User Manual.

It is the policy of ADDS (Applied Digital Data Systems Inc.) to improve products as new technology, software, components, and firmware become available. ADDS, therefore, reserves the right to change specifications without prior notice.

All features, functions, and operations described herein may not be marketed by ADDS in all parts of the world. Consult your ADDS supplier or nearest ADDS office for the latest information.

1983
Applied Digital Data Systems Inc.
Hauppauge, New York



CHAPTER 1: INTRODUCTION

1.1	Overview	1-1
1.1.1	Manual Description	1-1
1.1.2	Chapter 1 Description.	1-1
1.1.3	Chapter 2 Description.	1-1
1.1.4	Chapter 3 Description.	1-1
1.1.5	Chapter 4 Description.	1-1
1.1.6	Appendix Description	1-2
1.2	Identifying Features	1-3
1.2.1	Section Overview	1-3
1.2.2	Identifying Features	1-3
1.3	Reader Information	1-6
1.3.1	Notes, Cautions and Warnings	1-6
1.3.2	Key Depress Notation	1-6
1.4	Related Documentation.	1-6

CHAPTER 2: INSTALLATION PROCEDURES

2.1	Selecting An Operating Site	2-1
2.1.1	Physical Requirements	2-1
2.1.1	Power Requirements.	2-1
2.1.3	Environmental Requirements.	2-1
2.2	Unpacking Procedures.	2-2
2.3	Getting Started	2-3
2.3.1	Identifying External Controls	2-3
2.3.2	Self Test	2-4
2.3.3	Setup Procedure	2-5
2.3.4	Interface Installation.	2-7
2.3.5	Summary Check	2-9
2.4	Repair Policy	2-10
2.5	Warranty.	2-11

CHAPTER 3: OPERATOR INFORMATION

3.1	INTRODUCTION	3-1
3.2	Terminal Information	3-1
3.2.1	Introduction	3-1
3.2.2	The Display.	3-1
3.2.2.1	Introduction	3-1
3.2.2.2	Screen, Status Line, Self-Test	3-1
3.2.2.3	Character and Cursor Displays.	3-3
3.2.2.4	Display Features	3-4

VIEWPOINT/60
TABLE OF CONTENTS

3.2.3	Communications	3-4
3.2.3.1	Introduction	3-4
3.2.3.2	XMIT Port.	3-4
3.2.3.3	Print Port	3-5
3.2.4	Keyboard	3-7
3.2.4.1	Introduction	3-7
3.2.4.2	Alphanumeric Group	3-7
3.2.4.3	Numeric Group.	3-8
3.2.4.4	Cursor Control Group	3-8
3.2.4.5	EDIT Group	3-9
3.2.4.6	Data Communications Group.	3-11
3.2.4.7	Mode Group	3-13
3.2.4.8	Special Function Group	3-13
3.2.4.9	Function Key Group	3-14
3.3	Operating Procedures	3-15
3.3.1	Introduction	3-15
3.3.2	Getting Started.	3-15
3.3.2.1	Introduction	3-15
3.3.2.2	Terminal On and Self Test.	3-15
3.3.2.3	Adjusting the Screen Viewing Angle and Intensity	3-16
3.3.2.4	TAB Stops and Defining TABS.	3-16
3.3.3	Data Entry Concepts.	3-17
3.3.3.1	Introduction	3-17
3.3.3.2	Cursor Concepts.	3-17
3.3.3.3	Formatted and Unformatted Screens.	3-17
3.3.4	How to Enter Data.	3-19
3.3.4.1	Introduction	3-19
3.3.4.2	Data Entry on an Unformatted Screen.	3-19
3.3.4.3	Data Entry on a Formatted Screen	3-19
3.3.5	How to Edit Data	3-20
3.3.5.1	Introduction	3-20
3.3.5.2	Inserting a Line	3-20
3.3.5.3	Deleting a Line.	3-20
3.3.5.4	Inserting a Character EOL/EOF.	3-21
3.3.5.5	Inserting a Character EOP.	3-22
3.3.5.6	Deleting a Character EOL/EOF.	3-22
3.3.5.7	Deleting a Character EOP	3-23
3.3.5.8	Erase to EOL or to EOF	3-23
3.3.5.9	Erase to EOP	3-24
3.3.5.10	Erasing all Variable Fields.	3-24
3.3.5.11	Erasing an Entire Page	3-24
3.3.6	How to Transmit Data	3-25
3.3.6.1	Introduction	3-25
3.3.6.2	How to Transmit to the Computer.	3-25
3.3.6.3	How to Send to the Printer Only (Print Local).	3-27

3.3.6.4	Computer to the Printer (Transparent Mode).	3-28
3.3.6.5	How to Send to the Computer and Printer Simultaneously.	3-28

CHAPTER 4: PROGRAMMER INFORMATION

4.1	INTRODUCTION	4-1
4.2	Programmer's Concepts.	4-1
4.2.1	Introduction	4-1
4.2.2	Display Commands	4-1
4.2.3	Cursor Commands.	4-2
4.2.4	Mode Commands.	4-2
4.2.5	Communication Commands	4-4
4.2.6	Keyboard Commands.	4-6
4.2.7	Miscellaneous Commands	4-6
4.3	Terminal Command Descriptions.	4-7
4.3.1	Introduction	4-7
4.3.2	Display Commands	4-7
4.3.3	Cursor Commands.	4-8
4.3.4	Edit Commands.	4-10
4.3.5	Mode Commands.	4-11
4.3.6	Communication Commands	4-12
4.3.7	Keyboard Commands.	4-13

APPENDICES

<u>Appendix</u>		<u>Page</u>
A	TERMINAL COMMANDS.	A-1
B	ASCII CHART.	B-1
C	CURSOR ADDRESSING.	C-1
D	VISUAL ATTRIBUTE CHART	D-1
E	SPECIAL GRAPHICS CHART	E-1
F	INTERNATIONAL KEYBOARD LAYOUTS	F-1
G	STORAGE OF CONTROL CODES	G-1
H	TERMINAL COMPARISON CHART.	H-1

ILLUSTRATIONS

<u>Figures</u>		<u>Page</u>
2-1	Diagram of Cabinet Illustrating External Controls	2-3
2-2	Screen Display with Status Line.	2-4
2-3	SETUP Mode Status Line	2-5

VIEWPOINT/60
TABLE OF CONTENTS

3-1	Detail of Screen Demonstrating the User Entry Area and the Status Line	3-2
3-2	Detail of Status Line with all Possible Messages	3-2
3-3	Detail of Character Dot Matrix Construction. . .	3-3
3-4	Business Graphic Application	3-4
3-5	Detail of Cabinet Illustrating Comm Ports. . . .	3-5
3-6	Detail of Keyboard W/Key Groupings	3-6

<u>Tables</u>		<u>Page</u>
3-1	Status Line Self Test Messages	3-3
3-2	Insert/Delete Character Functions.	3-11
4-1	Codes Generated by Keys F1-F8.	4-5

SECTION 1

1.1 OVERVIEW

1.1.1 Manual Description

This publication is a User Manual for the Viewpoint/60. It provides the reader with an introductory description of the terminal's many features and detailed reference material concerning the installation, operation, and application of the terminal.

The manual is comprised of four chapters, each discussing a different aspect of the terminal.

The following paragraphs provide a brief description of what is discussed in each chapter.

1.1.2 Chapter 1 INTRODUCTION

The Introductory chapter describes the terminal, its features and its options. It also provides the reader with information about the structure and content of the manual as well as a reference to other related technical publications.

1.1.3 Chapter 2 INSTALLATION

The Installation chapter provides procedural information for unpacking and inspecting the terminal, selecting all terminal operating parameters, and connecting the terminal to the power outlet, printer and computer. This is followed by an installation procedure test. Also included are an explanation of the repair policy and a copy of the warranty.

1.1.4 Chapter 3 OPERATOR INFORMATION

The Operator Information chapter consists of two major sections. In the first section, information is given about the screen display as well as a full description of the keyboard. The second section consists of operating procedures, data entry, edit techniques, and information about formatted and unformatted screens.

1.1.5 Chapter 4 PROGRAMMING INFORMATION

The Programmer Information Section contains all of the information necessary for the programmer to properly utilize the terminal's capabilities.

VIEWPOINT/60
CHAPTER 1: OVERVIEW

Included within the chapter are sections about the keyboard and computer (remote) generated codes, display formats and their creation, communications and interface information.

1.1.6 THE APPENDIX

The Appendix contains that information which supplements the text of the preceding chapters and presents it in a quick reference format.

Contained within the appendix are sections containing remote command codes and sequences, cursor addressing charts for both row/column and absolute cursor addressing and an ASCII code chart.

1.2 IDENTIFYING FEATURES

1.2.1 Section Overview

Your terminal has many features that make it very easy to use. Becoming familiar with the terminal's capabilities will help you take advantage of its features.

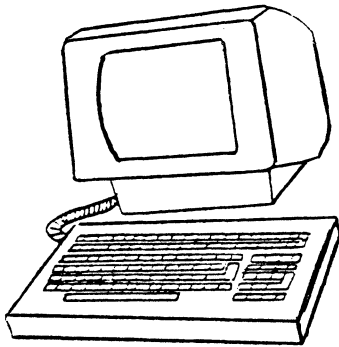

1. Easy to Read Display
2. A Variety of Display Formats
3. A Wide Variety of System Features
4. Versatile Keyboard
5. Full Editing Capabilities
6. Ease of Operation
7. A Choice of Communication Interfaces
8. Available Options

1.2.2 Identifying Features

1. Easy to Read Display

The terminal has a 12 inch diagonal display with minimal reflection available in either white (P4) or green (P31) phosphor. The display consists of 24 lines of 80 characters each, providing 1,920 character positions. An additional 25th line (Status Line) displays operating information. Characters are displayed with a 7 by 8 dot matrix formed within an 8 by 10 dot matrix boundary.

2. A Variety of Display Formats

A variety of display features are included both for aesthetic appeal as well as for expediting data entry. Included among these features are: fine line graphics and extensive visual highlights (full, half and zero intensities, blinking, underlining, reverse video and combinations).

3. System Features

The terminal has many system features which relieve the connected host computer from unnecessary operations thereby increasing its efficiency. Included among these features are:

VIEWPOINT/60
INTRODUCTION
CHAPTER 1: IDENTIFYING FEATURES

Forward and backward tabbing to variable fields; a terminal self-test; and compatibility to Regent and Viewpoint products where functions operate similarly.

4. Versatile Keyboard

The movable keyboard has stepped, sculptured keys in a typewriter style array with tactile feedback, typamatic (repeating) operation, two key rollover and selectable audible click. There are separate numeric, cursor control, edit and mode groups. There are 8 discrete pre-programmed function keys.

5. Full Editing Capability

In order to make data entry easier and to minimize editing and computer time, the terminal is designed to perform a wide variety of editing functions. The terminal has several discrete keys which permit full control of the cursor and enables the operator to insert and delete characters, to insert and delete lines, and to erase characters, lines and entire screens.

6. Ease of Operation

The terminal is easy to use. It is small, light weight and the display has two vertical viewing positions. For user comfort, the keyboard is moveable and has a stepped and sculptured typewriter-style array. In addition to these operator conveniences, there is a built-in terminal self test. It can easily be configured for operation via the keyboard with all operating parameters displayed on the Status Line (Set-Up).

7. A Choice of Communication Interfaces

Both the communication and auxiliary ports have extensive communication capabilities. A variety of interfaces are available for the communication port (i.e. RS-232C, RS-422 and current loop). The terminal supports X/ON - X/OFF protocol while the AUX device is enabled. The terminal can permit communication directly from the computer to a peripheral device without disturbing screen contents (transparent print). The terminal can also print the entire screen content (local print) on a peripheral device.

8. Available Options

The terminal has available several options which increase its flexibility and its application potential. The options involve the terminal display, the terminal interface and the keyboard.

Display - The terminal comes available with either a black and white screen (P4) or with a green phosphor screen (P31). This selection is made by user preference and is available at no extra charge.

The standard terminal is equipped with an RS-232C interface. The terminal may also be equipped with the RS422 or with the Current Loop interfaces when required by the individual application.

International Character Sets and Keyboard Layouts -

In order to further enhance its application potential, the terminal is available with either a domestic character set and a 110vac power supply or with a foreign power supply only. A separate foreign language package containing a foreign keycap set and an insertable foreign language PROM is available for both foreign and domestic units.

1.3 READER INFORMATION

This section will describe to the reader information which will aid in the understanding of the rest of the manual.

1.3.1 Notes, Cautions and Warnings

In order to direct the reader's attention to a specific idea or detail that require emphasis there are three notes:

NOTE: A note emphasizes a procedure or fact that should be considered for correct interpretation of the text.

CAUTION: A caution identifies and defines a procedure which must be followed to ensure correct use of the equipment.

WARNING: A warning identifies and defines a procedure which must be followed to ensure safe use of the equipment.

1.3.2 Key Depress Notation

Instructions for depressing keys in sequence will use either a comma, a hyphen, or a combination of the two.

A comma indicates that the keys should be depressed in sequence. One key should be depressed then released and the next key pressed and released. (Example: ESC,Ø,C)

A hyphen indicates that the two keys should be depressed simultaneously: (Example: CTRL-G)

1.4 RELATED DOCUMENTATION

This manual concerns itself with the installation, operation and application of the terminal as it comes from the factory.

For more detailed information concerning the terminal internal architecture, please refer to the following documents.

Viewpoint/60 Maintenance Manual

This manual provides all of the information pertinent to the maintenance and repair of the terminal. The manual provides an overview of the terminal's systems, discusses the terminal's operational theory, and offers a troubleshooting guide and a reference section with schematics.

SECTION 2

2.1 SELECTING AN OPERATING SITE

Although the terminal can function in a wide range of operating environments, there are several requirements to consider when selecting an installation site.

2.1.1 Physical Requirements

The site should accommodate the physical dimensions and support the weight of the terminal.

	CABINET	KEYBOARD
Height	12.5"	---
Width	14.5"	16"
Depth	14.0"	8.5"
Weight	22 lbs.	2.5 lbs.

2.1.2 Power Requirements

The power source must offer a three-pronged, grounded plug receptable. The terminal operates on the following power sources:

120 V/60 Hz @ 60W
220 V, 240 V/50 Hz @ 60W

2.1.3 Environmental Range Requirements

Temperature	operating: 10-40°C
	storage: 0-85°C
Humidity	10% to 95% (RH) non-condensing

2.2 UNPACKING PROCEDURES

Open the shipping container taking care not to damage it. Should your terminal ever require reshipping, it must be packed to prevent any damage to it while it is in transit.

Carefully remove the cabinet and keyboard from the shipping container.

Examine the cabinet and keyboard for any damage which may have occurred during shipping.

WARNING!

Should the video tube be shattered, DO NOT remove the debris without wearing heavy gloves. The glass is coated with a highly toxic substance and should not be handled without adequate protection.

Should you discover any damage to the terminal, notify the transporter and file a damage claim. Any damage due to shipping is not repairable under the warranty. (See Warranty Section)

2.3 GETTING STARTED

This terminal can easily be made ready for operation. After identifying the external controls, one simply switches the terminal on, selects all options from the keyboard and makes all interface cable connections.

2.3.1 Identifying External Controls

There are three external controls. The contrast knob and On-Off switch are located behind the cabinet. The tilt control is on the cabinet bottom. (See Diagram).

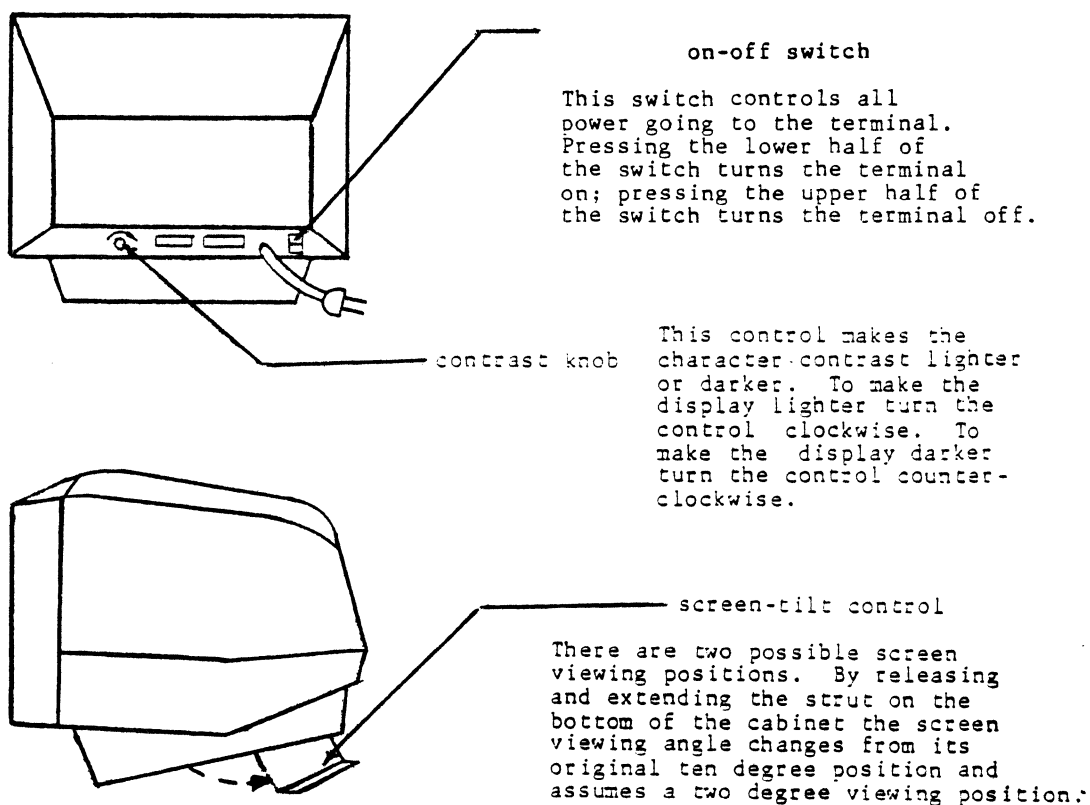

Figure 2-1 Diagram of Cabinet Illustrating External Controls

2.3.2 Self Test and Status Line Display

2.3.2.1 Self Test

Upon power up, the terminal will undergo a power-on self test.

If successfully completed, the word "PASS" will appear at the bottom of the screen in the STATUS LINE.

If the terminal detects a fault during the SELF TEST then the Status Line will display the message FAIL. If the FAIL messages appear after repeated power-up attempts then refer to the section on service in this chapter.

The test message will disappear after the entry of the first character.

If the word "EAROM" appears in the rightmost position of the Status Line, a fatal error in the nonvolatile memory has occurred. Default parameters will be in effect at this time and the terminal should be checked as soon as possible.

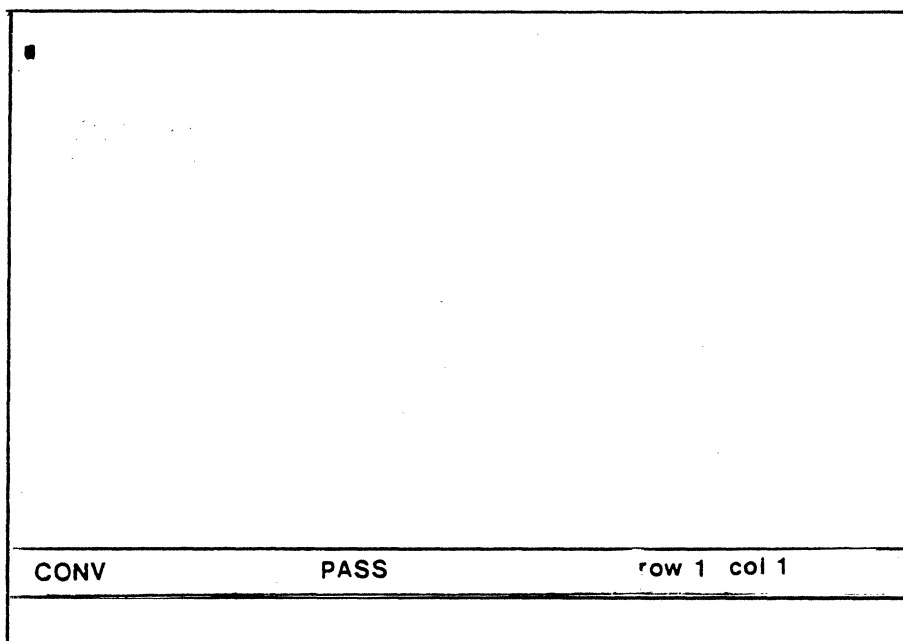

Figure 2-2 Screen Display with Status Line

2.3.3 The SETUP Procedures

2.3.3.1 Overview

All of the terminal's features and operating parameters are selected and stored in a non-volatile memory and are completely accessible from the keyboard. This feature allows the terminal to be tailored to its operating environment and easily changed to accommodate subsequent variations to that environment.

2.3.3.2 Selecting Internal Options

Because there are no switches for selecting operating parameters, the terminal is configured from the keyboard. By entering the setup mode (see the procedure below), the current terminal configuration will appear as four banks of numbers on the STATUS LINE. The following procedure and table will describe how to reconfigure the terminal and present the parameter codes.

Procedure: 1. To enter SETUP MODE simultaneously depress the SHIFT-HOME keys.

Effect: 1. The STATUS LINE will present the following display.
2. The cursor will move to the first operating parameter selection (Bank 1, bit 1).

SETUP	1=01110111	2=01011000	3=00010000	4=10000001	VP/60
-------	------------	------------	------------	------------	-------

Figure 2-3 SETUP Mode Status Line

Procedure: 1. Referring to the OPERATING PARAMETER CODE TABLE on the next page and select the desired configuration.
2. Change the number to a 1 or a 0 by depressing the cursor up key for 1 or depressing the LINE FEED key for 0. The cursor control keys are the only keys used for making these selections.
3. After each selection is made the cursor must be advanced to the next selection by using the cursor right key. The cursor may also move backward by using the cursor left key.
4. After all selections have been made and the new parameters are TO BE STORED then depress the HOME Key. If NO CHANGES are to be made or TO EXIT the SETUP Mode, then depress the ESC key.

VIEWPOINT/60
 CHAPTER 2: GETTING STARTED

- Effect:
1. If the HOME key is depressed then the terminal will exit SETUP mode and the terminal will then reflect the new configuration.
 2. If the ESC key is depressed then the terminal will exit SET UP mode and there will be no change in the operating parameters.

Table 2-1 Operating Parameter Value Table

Bank Number 1			
Position	Control	Comm Port	Baud Rates
1 - 4	EIA PORT	<u>Baud Rates</u>	<u>Bit Settings</u>
		110	0000
5 - 8	AUX PORT*	150	0001
		300	0010
		1200	0011
		1800	0100
		2400	0101
		4800	0110
		9600	0111
		19.2k	1000

* These Aux Port settings are for Print Local function only. Refer to pages 4-12 and 4-13 for CPU controlled Aux baud rates.

Bank Number 2					
Position	Function	Selection			
		Choice I		Choice II	
		Setting		Setting	
1	Duplex	Half	0	Full	1
2	Video presentation	Drk Lht	0	Lht Drk	1
3	Video highlight	Half	0	Full	1
4	Auto Scroll	Disable	0	Enable	1
5	Auto Line Feed	Disable	0	Enable	1
6	Display Parity				
	Error	Disable	0	Enable	1
7	Parity High Bit	Odd	00	Mark	10
8	Parity Low Bit	Even	01	Space	11

Bank Number 3					
Position	Function	Selection			
		Choice I	Setting	Choice II	Setting
1	Screen Refresh Rate	60Hz	0	50Hz	1
2	Cursor Suppress	Visual	0	Suppressed	1
3	Cursor Format 1	Block	0	Underline	1
4	Cursor Format 2	Blink	0	Steady	1
5,6	Character Case	Upper	00	Up Only	10
		Lower	01	---	11
Bit 7,8	Line Terminator	CR	00	CR EOT	10
		CR ETX	01	No Term.	11

Bank Number 4					
Position	Function	Selection			
		Choice I	Setting	Choice II	Setting
1	Reserved				
2	Cursor Home Upper Left	Disable	0	Enable	1
3	Keyclick	Disable	0	Enable	1
4,5,6*	Foreign Language	Span & Port	111		
		Swed & Fin	010		
		Germ & Swiss/ Dan & Nor	001		
		France	000		
7	Regent 40 Comp.	Disable	0	Enable	1
8	Reserved	---		---	

* Requires addition of International Keycap Kit.
See Appendix F for the Keycap Kit numbers.

2.3.4 Interface Installation Procedures

2.3.4.1 Overview

The final step in the installation process involves connecting the terminal to other communication devices. Select the appropriate interface after determining the system's interface requirements.

The communication port (Data Terminal Equipment or DTE) supports serial asynchronous reception and transmission while the auxiliary port (Data Communication Equipment or DCE) is configured for serial transmission. Normally, the communication port is connected to a computer or a modem and the auxiliary port is connected to some other peripheral device such as a printer.

VIEWPOINT/60
 CHAPTER 2: INTERFACE INSTALLATION

The information which follows will help identify the interface option required by your system.

2.3.4.2 RS-232C - Interface - The communication and auxiliary ports will both support this interface. It requires a DB-25P male connector for interconnection. The following chart identifies the pin assignments:

EIA PORT			AUX PORT		
EIA RS232C			EIA 232C		
REF	PIN NO.	FUNCTION	REF	PIN NO.	FUNCTION
AA	1	Frame Ground	AA	1	Frame Ground
BA	2	XMIT Data	BA	3	XMIT Data
BB	3	Receive Data			
CA	4	Request to Send			
CB	5	Clear to Send	CB	5*	Clear to Send
CC	6	Data Set Ready	CC	6*	Data Set Signal Ready
AB	7	Signal Ground	AB	7	Signal Ground
CF	8	Carrier Detect	CF	8*	Carrier Detect
CD	20	Data Terminal Ready	CD	20	Data Terminal Ready
					* Not Active

Table 2-2 Illustrating RS 232 Pin Assignments

2.3.4.3 CURRENT LOOP - The communication port will support this interface. (Current loop is inoperative at 19.2k baud.) It requires the installation of a CURRENT LOOP board.

The following chart will identify CURRENT LOOP pin assignments.

Pin No.	Signal	Description
15	LBIAS 1	(+13.2v through load resistor) Loop Bias
17	LIN+	Current Loop In +
18	LIN-	Current Loop In -
22	LBIAS 2	Loop Bias 2+
23	CLEIAOUT	EIA out from Current Loop selection
24	LOUT+	Current Loop Out+
25	LOUT-	Current Loop Out-

Table 2-3 Illustrating Current Loop Pin Assignments

2.3.4.4 RS-422 Interface - The communication port will support this interface. It requires the installation of an RS-422 board.

Pin No.	Signal	Description
17	422 LIN+	RS422 Line In+
18	422 LIN-	RS422 Line In-
24	422 LOUT+	RS422 Line Out+
25	422 LOUT-	RS422 Line Out-

Table 2-4 Illustrating RS 422 Pin Assignments

2.3.5 SUMMARY CHECK

Before operating the terminal be certain that the following conditions have been met.

1. Does the operating site (where the terminal will be used) fulfill the terminal's requirements?
2. Does the terminal display PASS after switching it on?
3. Have all selections been made in the SETUP mode display? Do the operating parameters match with those of the host computer?
4. Have all interface connections been properly established?

2.4 VIEWPOINT/60 REPAIR POLICY

Applied Digital Data Systems Inc. products are fully warranted (parts and labor) for a period of 90 days after shipment, provided repairs are performed at an Applied Digital Data Systems Inc. depot or factory repair center.

Applied Digital Data Systems Inc. products have been designed for maximum maintenance accessibility of major sub-assemblies. The user may elect to troubleshoot an equipment failure on his own and return a malfunctioning sub-assembly to the nearest Applied Digital Data Systems Inc. factory repair center for repair.

At the user option, a defective terminal may be returned to Applied Digital Data Systems Inc. for repair. Applied Digital Data Systems Inc. will repair any failure that occurred through normal use for a fee.

Please note that prior to returning any defective material for repair, the nearest Applied Digital Data Systems Inc. Repair Center (see below) should be contacted for a "Service Repair Authorization (SRA) Number". This number will be required to appear on all address labels and packing slips, for equipment being returned.

ADDS REPAIR CENTERS

Hauppauge, New York	516-231-5400
Atlanta, Georgia	404-455-9341
Schaumburg, Illinois	312-843-7560
Dallas, Texas	214-387-2337
Tustin, California	714-730-6444
Palo Alto, California	415-856-0560
Kent, Washington	206-872-5161

Those customers wishing to maintain an inventory of replacement parts in order to make their own repairs, may order parts directly from Applied Digital Data Systems Inc. as noted below.

ORDERING INFORMATION

All orders for spare parts must be sent to:

Applied Digital Data Systems Inc.
100 Marcus Blvd.
Hauppauge, NY 11788
ATT: ORDER ENTRY

Include the following information on your purchase order.

Bill-to address
Ship-to address
Purchase order number
Method of shipment (UPS, Air Freight, etc.)
Part Number and quantity of items ordered
Price and required delivery

MINIMUM ORDER REQUIRED.
PRICES ARE SUBJECT TO CHANGE WITHOUT NOTICE.
ALL ORDERS ARE SHIPPED F.O.B. HAUPPAUGE, NY

2.5 WARRANTY

Warranty-Communications and Terminal Products

The seller warrants each new communications and terminal manufactured by it, to be free from defects in material and workmanship under normal use and service for a period of 90 days from the date of shipment. Seller's sole obligation under this warranty is limited to making good, at its factory, any product or any part or parts thereof found to be defective, provided the buyer bears the cost of shipping charges in connection with the repair or replacement of the defective equipment. SELLER MAKES NO WARRANTY, EXPRESS OR IMPLIED: AND ANY IMPLIED WARRANTY OF MERCHANTABILITY OR FITNESS FOR A PARTICULAR PURPOSE WHICH EXCEEDS THE FOREGOING WARRANTY IS HEREBY DISCLAIMED BY SELLER AND EXCLUDED FROM ANY AGREEMENT MADE BY ACCEPTANCE OF ANY ORDER PURSUANT TO THIS QUOTATION. Seller will not be liable for any consequential damages, loss or expense arising in connection with the use of or the inability to use its products or goods for any purpose whatsoever. Seller's maximum liability shall not in any case exceed the contract price for the products.

SECTION 3



3 OPERATOR INFORMATION

3.1 Introduction

The purpose of this chapter is to present the operator with the information necessary for the operation of the terminal and to provide a conceptual understanding of the entire terminal operation process. The chapter has been divided into two parts: the first part provides information about the features of the product while the second part lists operational functions followed by detailed procedural information.

Note: In order to ensure a proper understanding of the text it is suggested that the reader first become familiar with the concept of formatted and unformatted screens which may be found in the section concerning Data Entry Concepts. (3.3.3)

3.2 TERMINAL INFORMATION

3.2.1 Introduction

A video display terminal (VDT) has two primary functions. First, it serves as a device for sending information to the computer. In its second function, the VDT is a receiving device displaying information being sent from the computer. While the computer controls what the terminal displays, it is the operator who generally controls what is entered on to the screen and transmitted to the computer.

The Terminal Information section will explain how the terminal displays information, how the information is communicated, and how the operator controls the terminal from the keyboard.

3.2.2 The Display

3.2.2.1 Introduction

Although the format of the screen display is determined by the programmer, the operator should be aware of how the screen display performs during terminal operations.

This section will discuss cursor and character display, the Status Line and Self Test display, and both the standard and optional display features.

3.2.2.2 The Display Screen, the Status Line and the Self Test

Data which is entered via the keyboard is simultaneously stored in a screen memory and displayed on the terminal. The screen display consists of the user entry area and the Status Line.

VIEWPOINT/60
 CHAPTER 3: TERMINAL INFORMATION
 -DISPLAYS-

The user entry area can display 24 lines of 80 characters per line.

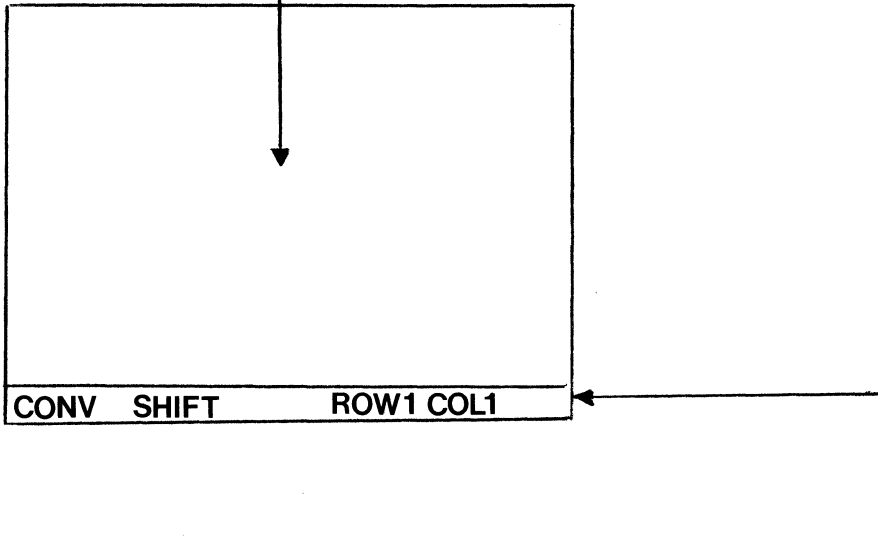

Below the user entry area, on the 25th line, the Status Line displays all terminal and user messages.

Figure 3-1 The User Entry Area and the Status Line

Status Line messages are displayed in eight distinct fields. The following chart lists the position of the fields and all of the possible messages to be found in each.

2 - 7	8 - 16	17 -23	25-27	31 - 47	48-51	55-67	71-78
<u>MODE</u>	<u>CASE</u>	<u>STATE</u>	<u>AUX STAT</u>	<u>MISC</u>	<u>CARRIER</u>	<u>ROW-COLUMN</u>	<u>VP/60</u>
CONV MSG PAGE FORM MODIFY	SHIFT	LOCAL TRNPRNT	AUX	PASS FAIL TRANSMIT PRINT LOCAL KEYBOARD LOCK INSERT EOL INSERT EOF INSERT EOP PROTECTED PRINT ONLY QUEUE OVERFLOW CONSTANT	CD	ROW XX COLXX	

Figure 3-2 Detail of Status Line with All Possible Messages

Turning the terminal on initiates a Self Test, the results of which are displayed in the Status Line. Upon completion of the Self Test, the message PASS or FAIL will be displayed. If the message FAIL appears, the rightmost field of the Status Line will display the diagnostic message RAM or EAROM.

STATUS LINE SELF TEST MESSAGES		
Message	Diagnosis	Corrective Procedure
PASS	Terminal is ready for operation	Proceed with operation
FAIL	Terminal is not ready for operation	Try power up procedure again or call Service

Table 3-1 Status Line Self Test Messages

3.2.2.3 The Character and Cursor Displays

All characters which appear on the screen are formed with a 7 x 8 dot matrix within an 8 x 10 dot matrix boundary. This allows for display of both upper and lower case characters with descenders; special and foreign characters; with Fine Line Graphics.



Figure 3-3 Detail of Character Dot Matrix Construction

The cursor designates the position where the next character will be entered on the user entry area. Displayed either as a steady or blinking block or underline, it serves the same purpose as a position indicator on a standard typewriter. The cursor advances automatically to the next position as characters are entered. When the cursor reaches the end of a line it automatically advances to the next line if Auto Line Feed is enabled. Otherwise, with Auto Line Feed disabled, the cursor returns to the beginning of the same line.

3.2.2.4 Display Features

The VDT displays information on the screen using several screen formats and visual highlights, both for aesthetic appeal and to facilitate data entry. This section will explain what the formats are and why they are useful.

Visual Highlights

Visual cues which help the operator enter data are enhanced through the use of visual highlights. The terminal can present display information using the following visual highlights: full, half, or zero intensities, reverse video, blinking, underlining, or any combination of these.

Fine Line Graphics

There are eleven Fine Line Graphic Symbols which can be used for the generation of a host of graphical representations, ranging from a business form outline and up to complex bar charts.

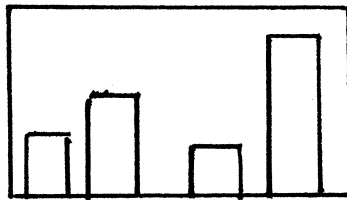

Figure 3-4 Business Graphic Application

3.2.3 COMMUNICATIONS

3.2.3.1 Introduction

This aspect of VDT operation involves communication between the terminal and the computer; the terminal and the printer (or other auxiliary device); or between the terminal, the computer and the printer simultaneously. Communication between the terminal and any external device is affected by the communication ports.

3.2.3.2 XMIT Port (EIA Port)

All communication between the terminal and the computer occurs through the XMIT (transmit) port. The CONV, MSG and PAGE mode keys govern how much data will be transmitted from the XMIT port after the XMIT key is depressed.

While in CONV (Conversational) mode data is sent to the computer on a character-by-character basis as it is entered via the keyboard.

During MSG (Message) and PAGE mode, the terminal holds the screen information in a screen buffer (hence buffered transmission) and transmits the information to the computer either line at a time (MSG mode) or page at a time (PAGE mode) when the XMIT key is depressed.

3.2.3.3 PRINT Port (AUX port)

All communications between the terminal and the printer (or any other auxiliary device) occur through the PRINT port which is controlled by the PRINT key and the AUX key. The PRINT port is uni-directional as it cannot receive data. Depressing the PRINT key will transmit displayed information to the printer (only) in a procedure called PRINT LOCAL.

With the terminal in CONV mode and the AUX port enabled, displayed information is transmitted to both the computer and to the printer. In this circumstance, transmission takes place on a character by character basis as it is being entered via the keyboard.

With the terminal in MSG or PAGE modes transmission to the printer occurs when the PRINT key is depressed.

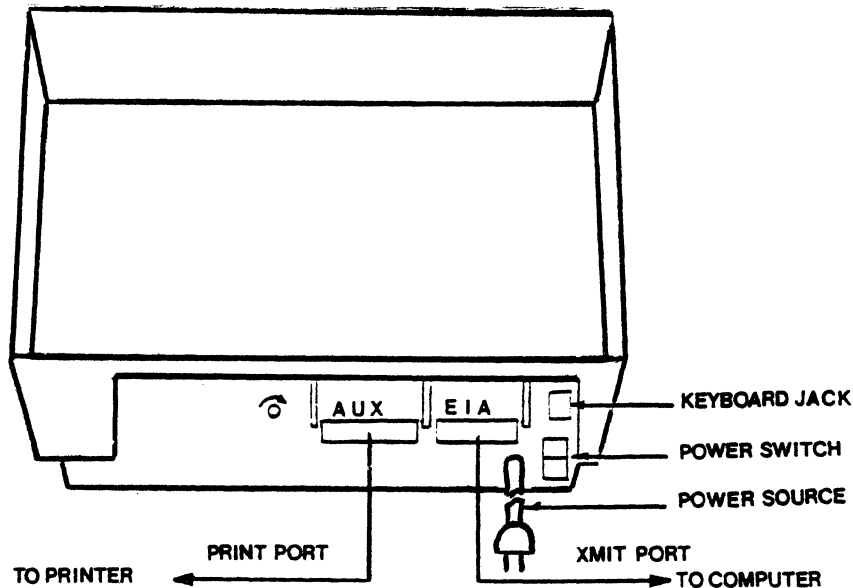

Figure 3-5 Detail Of Cabinet Illustrating Comm Ports

VIEWPOINT/60

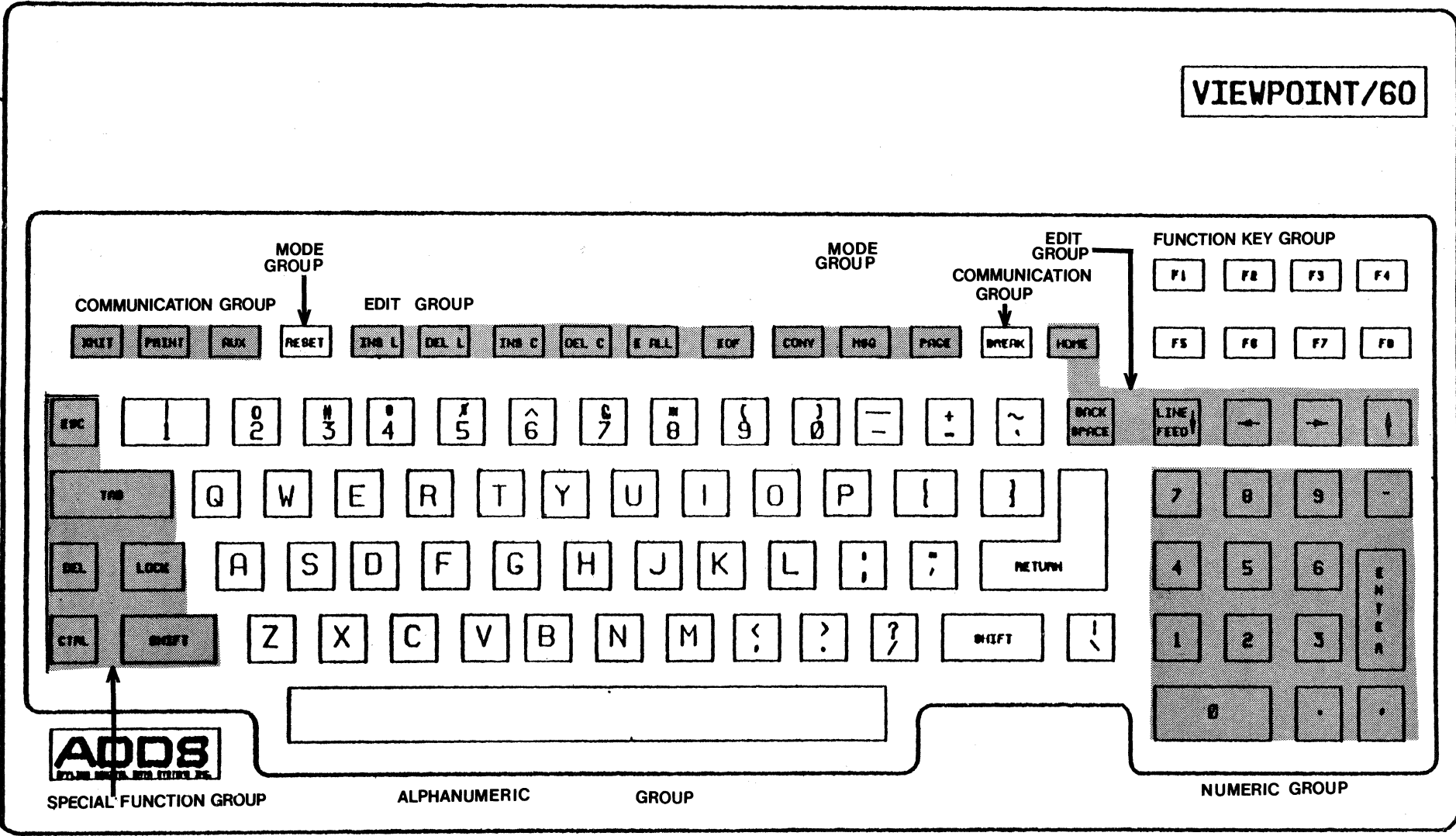

Figure 3-6 Detail of Keyboard With Key Groupings

3.2.4 KEYBOARD

3.2.4.1 Introduction

The VDT operator is primarily concerned with entering data, editing data and communicating data. All of these operations are entered through the keyboard. Although the keys are presented in this chapter as occupying eight separate groups, each group may be thought of as representing one of these basic operator procedures. Representing the data entry function are the Alphanumeric and Numeric groups. Data Edit is represented by the Data Edit Group and the Data Communications function by the Data Communication and Mode Groups. The keys of the Special Function are used by the operator to perform all three of these operator procedures.

Contained in this section is a description of the key groups, an explanation of how they work and their use.

3.2.4.2 Alphanumeric Group

The largest group of keys on the keyboard, the alphanumeric group, is arranged in a standard typewriter-style array. Consisting of fifty-two keys, this group includes upper and lower case alphabetic characters, numeric, SHIFT, LOCK, RETURN, SPACE, mathematical symbols and symbols for punctuation.

The F key and the J key have a deeper sculpture to facilitate touch typing by providing a cue to the operator.

SHIFT - The standard character set is indicated by the legends printed on the keycaps. Depending upon the selection made in Set-Up (see Installation Section) the SHIFT key will shift lower case to upper case, or upper case to lower case. It is also used to print a key's alternate character, and when used with a command key, will produce that key's alternate function. (Example: SHIFT- INS C inserts to the End of Page)

LOCK - This key will lock the shiftable keys of the keyboard into the SHIFTED position. A single depression engages the LOCK key. A second depression will disengage it.

RETURN- If the Auto Line Feed feature is enabled, then depressing this key will cause the cursor to return to the first unprotected position (see Data Entry Concepts) of the next line. If the Auto Line feature is not enabled, then the cursor will move to the first unprotected position of the current cursor line.

3.2.4.3 Numeric Group

In order to simplify the entry of numeric data, the keyboard has a separate numeric pad similar to a calculator-style array. Within the Numeric Group are numbers 0-9; minus (-) sign; a comma and a decimal point; and an ENTER key (which acts as a TAB key when the terminal is in FORM mode. Keys common to the Alphanumeric Group and the Numeric Group generate the same ASCII code values.

The 5 key has a deeper sculpture to provide cue to the operator.

3.2.4.4 Cursor Control Group

In addition to the TAB, ENTER and RETURN keys, the terminal has a separate Cursor Control Group. All five of the Cursor Control Group keys are used to position the cursor up or down, forward and backward; anywhere in the text entry area that is not protected.

LINE ↓ - This key moves the cursor vertically down the screen display. When the cursor reaches line 24 and the Auto Scroll feature is disabled, depressing this key will then cause the cursor to reposition to the top of the page. With the Auto Scroll enabled, and the terminal in CONV or MSG mode, the page would scroll upward destroying line number one and the cursor would remain on line twenty four while maintaining its vertical position.

← This key moves the cursor horizontally to the left. With the cursor at the leftmost position of a line, depressing this key will cause the cursor to wraparound to the last unprotected position of the previous line.

→ This key moves the cursor horizontally to the right. With the cursor at the rightmost position of a line depressing this key will cause the cursor to wraparound to the first unprotected position of the next line.

↑ This key moves the cursor vertically upward across the screen, a line at a time. When the cursor reaches line one, depressing this key will cause the cursor to wraparound to line twenty four while maintaining its vertical position.

- HOME - Depressing this key causes the cursor to move to the HOME position on the display screen. If the Auto Scroll feature is disabled then the HOME position is in the upper left hand corner of the screen. If the Auto Scroll feature is enabled then the HOME position is determined by the terminal operational mode. While the terminal is in PAGE, FORM and MODIFY mode, HOME position is in the upper left hand corner of the display. In MSG and CONV modes, HOME is in the lower left hand corner of the display. With Auto Scroll disabled, HOME is in the upper left hand corner. The user can define HOME to always be the left by the second choice in Bank 4 of the SETUP procedure. Enabling the second SETUP selection in Bank 4 to "On" forces HOME to be upper left regardless of the mode.
- BACK SPACE - This non-destruct function behaves in the same fashion as the Cursor Left ← key as it causes the cursor to move to the left one space at a time but sends a BACKSPACE code (BS) where cursor left sends a NAK code.
- CURSOR LEFT ← , CURSOR RIGHT → , CURSOR UP ↑ , BACK SPACE, and LINE FEED are all typamatic (repeating) keys. The HOME key is not typamatic.

3.2.4.5 Edit Group

The following six command keys comprise the Edit Group and are used for inserting, deleting and erasing the screen contents:

- INS L - This typamatic key is used for inserting a line on an unformatted screen or while the terminal is in FORM mode. As a line is inserted subsequent lines move down.
- DEL L - This typamatic key is used for deleting a line from the display. As a line is deleted all subsequent lines will move up. The key is not operative on a formatted screen unless the terminal is in FORM mode.
- INS C - This key is used for inserting characters onto the screen. The key must be pressed a second time to disengage the function. Depressing this key with a formatted screen causes a message INSERT EOF (end of field) to appear on the STATUS LINE. On an unformatted screen the message INSERT EOL (end of line) will appear. Using the key in conjunction with the SHIFT key causes the STATUS LINE message INSERT EOP (end of page) on an unformatted screen.

VIEWPOINT/60
CHAPTER 3: TERMINAL INFORMATION
- KEYBOARD -

When a character is inserted, all characters to the right of the current cursor position will move one space to the right.

DEL C - This typamatic key functions according to the screen format. When the screen is unformatted depressing this key causes the character at the present cursor position to be deleted and all subsequent characters to move to the left. This is a line limited function. If the screen is formatted the delete action is the same but repeated key depressions will delete to the end of the field. Using the key in conjunction with the SHIFT key will delete one character at a time to the end of the page on an unformatted screen and to the end of the field on a formatted screen.

In all cases deletion of a character will cause subsequent characters to move one space to the left.

EOF - This key is used to erase an entire variable field of a formatted screen and to the end of a line in a unformatted screen. It is enabled by simultaneously depressing CTRL-EOF.

E ALL - This key erases an entire screen and is enabled by simultaneously depressing CTRL-E ALL.

Table 3-2 Insert/Delete/Eraser Character Functions

Key Sequence	Screen Type	Function	Status Line Message
INS C DEL C	Form Mode or unformatted	Insert/Delete to end of line	TO EOL:
SHIFT-INS C SHIFT-DLE C	FORM Mode or unformatted	Insert/Delete to end of page	TO EOP:
*INS C *DEL C	Formatted Screen or Data Entry Mode	Insert/Delete to end of field	TO EOF:
CTRL-EOF	Form mode or unformatted	Erases to the end of the line	
CTRL-EOF	CONV, MSG, PAGE, MODIFY	Erases to the end of the variable field.	
CTRL-SHIFT, EOF	FORM mode or unformatted	Erases all characters and attributes from the cursor to the end of the page.	
CTRL-SHIFT, EOF	CONV, MSG, PAGE, MODIFY	Erases all variable fields from the cursor to the end of page. With the cursor in the HOME position, CTRL-SHIFT, EOF performs the same function as CTRL-E ALL	
CTRL-E ALL	FORM or unformatted	Erases the entire screen	
CTRL-E ALL	CONV, MSG, PAGE, MODIFY	Erases only variable fields on the page. Resets all modified data fields if in MODIFY mode	
CTRL-SHIFT, E ALL	FORM or unformatted	Erases the entire screen	
CTRL-SHIFT, E ALL	CONV, MSG, PAGE, MODIFY	Erases the entire screen	

*With a formatted screen or Data Entry Mode, SHIFT-INS C/DEL C has the same effect as INS C/DEL C.

3.2.4.6 Data Communication Group

The Data Communication Group is comprised of the XMIT, PRINT, AUX and BREAK keys. Because they control the terminal's two communication ports, each key determines whether the terminal will communicate with the computer, with the printer or simultaneously with the printer and computer.

VIEWPOINT/60
CHAPTER 3: TERMINAL INFORMATION
- KEYBOARD -

XMIT - When in buffered mode this key controls all transmission being sent from the terminal to the computer. Depressing it causes all unprotected displayed data to be transmitted from the XMIT port. The message XMIT will appear on the Status Line.

The XMIT key is used in MSG and the PAGE modes in determining how the displayed information will be transmitted to the XMIT port. While the terminal is in MSG mode, each depression of the XMIT key will cause the current cursor line information to be sent to the computer. If the terminal is in PAGE mode, the entire page (or a portion of a page) will be sent when the XMIT key is depressed. The terminal will transmit all data from the cursor to the end of the screen while in PAGE MODE.

PRINT - Depressing the PRINT key causes displayed information to be transmitted from the PRINT port (AUX port) and to the printer only. This procedure of transmitting information directly to the printer without transmitting it to the computer is called LOCAL PRINT.

AUX - This key is used when information is to be transmitted both to the computer and to the printer at the same time. The PRINT port (AUX port) is enabled when the AUX key is depressed and the message "AUX" is displayed on the STATUS line signifying the PRINT port status. A second depression of the AUX key disables the PRINT port.

With the AUX key enabled and the terminal in CONV mode, information will be sent to the computer and to the printer on a character by character basis as it is being entered onto the terminal screen. If the terminal is in a buffered mode then the information will be sent either line at a time (MSG mode) or page at a time (PAGE mode). A buffered mode transmission or LOCAL PRINT may be terminated by depressing the RESET key.

BREAK - This key is used to interrupt and to subsequently terminate transmission of a data stream. When simultaneously depressed with the CTRL key (CTRL-BREAK), a 500 milisecond spacing condition occurs in the data stream which causes data transmission to stop.

3.2.4.7 Mode Group

The MODE GROUP keys determine how the terminal will perform while it is being used. The Mode Group is comprised of the following keys:

The following three keys of the MODE GROUP control how data will be transmitted to the computer from the XMIT port.

- CONV - This places the terminal into CONVERSATION mode and initiates unbuffered data communication. While the terminal is in this mode, data is transmitted to the computer or to the computer and to the printer (if AUX is enabled) at the same time that it is entered onto the screen.
- MSG - The MSG key puts the terminal into the MESSAGE mode and initiates buffered transmission of data when the XMIT key is depressed. While the terminal is in MSG mode data on the current cursor position line will be transmitted when commanded by the the XMIT key.
- PAGE - This key initiates the PAGE mode and causes buffered transmission of information. Either a page or, depending on the screen format, a portion of a page (information occupying spaces from the first DEL code to the current cursor position) is transmitted when the XMIT key is depressed.
- RESET - This key is used to reset the operating mode without altering the display contents. It is typically used to terminate transmission and print tasks.

3.2.4.8 Special Functions Group

The Special Function Group is comprised of keys which have a variety of functions. The group is comprised of the following keys:

- CTRL - This key is typically used in conjunction with other keys to enable the terminal to generate various terminal control functions.
- TAB - This key generates a control code (HT) in CONV mode or enables the operator to use the terminal's TAB stop functions while in other modes. SHIFT-TAB causes a BACK TAB or sends a control sequence.

ESC - The ESC key is typically used by itself (or as the first character of a multi-code sequence) to generate the ASCII code ESCAPE. (CTRL-[)

DEL - The DEL key generates the ASCII code delete.

3.2.4.9 Function Key Group

The Function Key Group is comprised of the function keys F1-F8.

Function Key F1-F8

These keys are pre-programmed and the codes they transmit can not be altered. Depressing the function keys causes the terminal to send a code sequence to the computer which will respond according to the system's application program. The keys may be used alone to generate eight sequences and may be depressed with the SHIFT key (SHIFT-F1-8) to generate an additional eight sequences.

3.3 OPERATING PROCEDURES

3.3.1 Introduction

The purpose of the first half of chapter three was to show the operator how the different components of the terminal function. It also indicated how the various keyboard groups relate both to each other and to the overall function of the terminal.

The focus of the second half of the chapter is placed upon instructing the operator in the procedural techniques involved with the operation of the terminal. The section is designed to instruct the operator in using terminal functions.

Following the introduction, the second half of chapter three begins by providing information to help the operator get started. Following this is a section which familiarizes the operator with the fundamentals of data entry. It is essential that the operator understand these concepts as reference will be made to them throughout the rest of the chapter.

The balance of the chapter is presented in a tutorial format. In order that the chapter might serve both as an instruction and as a quick reference, each of the data entry edit and communication features have been listed by its function. (For example, How to Delete a Character). Each function is followed by a procedure and then an analysis.

3.3.2 Getting Started

3.3.2.1 Introduction

The purpose of this section is to familiarize the operator with the terminal by showing what to expect during the power up procedure. Following the procedure carefully will ensure operator comfort and accurate terminal operation.

The section assumes that the terminal has already been properly installed and adjusted.

3.3.2.2 How to Turn the Terminal On and Initiate the Terminal Self Test

Procedure: Press the On/Off switch, located at the back of the terminal, to the On position.

Effect: Powering up the terminal causes it to emit a 'beep' tone. This signifies that the terminal circuitry is functioning properly. The terminal will initiate a Self Test and display the word PASS on the Status Line. This signifies that the terminal has successfully completed the Self Test and is ready for operation.

Considerations: 1. In the event that the terminal is unable to successfully complete the Self Test, a diagnostic message will appear on the Status Line. See Table 3-1 for a list of possible diagnostic messages. (If the problem cannot be solved from this chart then refer the problem to your local service man.)

3.3.2.3 Adjusting the Screen Viewing Angle and Intensity

After the terminal has been powered up the operator may wish to re-adjust the viewing angle of the cabinet.

Procedure: Unhook the strut located at the bottom of the screen cabinet and move it down to the lock position.

Effect: The screen viewing angle changes from its original ten degree position and assumes a two degree viewing position.

Considerations: 1. By depressing the PRESS TO RELEASE tab on the locked strut, it will unlock and the screen will assume its original viewing position.

2. After setting the viewing angle the operator may adjust the screen intensity. Located at the back of the terminal is the contrast knob. Turning it clockwise increases the screen contrast.

3.3.2.4 TAB Stops and Defining TABS

The cursor will stop at the first character position of a variable field.

Terminal TAB Stops on a Formatted Screen (CONV, MSG or PAGE modes)

On a formatted screen (one containing a visual field - see Appendix D), the cursor will move to the first character position of an unprotected field following a protected field, upon receipt of a TAB command.

Terminal TAB Stops on a Formatted Screen (FORM mode)

The cursor moves from its current position to the first character space of the next protected or unprotected field.

3.3.3 Data Entry Concepts

3.3.3.1 Introduction

Because they directly influence how and where data is entered onto the terminal screen, controlling the cursor and screen format are the two aspects of data entry which are of primary concern to the operator. In order that data may be properly entered, it is first necessary to understand what the cursor is and how it behaves with relation to screen boundaries, terminal configuration and screen format. Similarly, it is also necessary to become familiar with the concept of formatted and unformatted screens as they not only affect data entry, but overall terminal performance as well.

3.3.3.2 Cursor Concepts

The cursor is the indicator which shows where the next character will be entered. It is controlled by the CURSOR CONTROL GROUP keys, the TAB key, and the RETURN key.

Cursor Wraparound and Scrolling

If the cursor occupies the first position of line two, then depressing the arrow left key will cause the cursor to reposition to the last position of line one. Similarly, if the last position of a line is occupied by the cursor, then depressing the arrow right key will advance the cursor to the first position of the following line, depending on the Auto Line Feed setting. If this is done on the last position of the last line the display will scroll upward and the cursor will occupy the first position of the new line or the cursor will wrap to the first position of line one (depending on mode). Auto Scroll (CONV and MSG mode only) is enabled by the Set UP mode described in the Installation Chapter of this manual.

When the terminal is set for Auto Scroll, and the cursor occupies the last line, the screen can be made to scroll. While the cursor occupies the last line, depressing the ↓ key will cause the display to move up one line.

When the Auto Scroll is disabled, depressing the Line Feed key with the cursor on the last line will cause the cursor to reposition to the first line.

3.3.3.3 Formatted and Unformatted Screens

The screen will sometimes contain visual cues which will help the operator or the computer to enter data into appropriate and designated areas of the screen. In order that these visual cues will not have to be recreated every time data is sent to the computer, they are placed into areas of the screen which prevent their transmission. The data which will be transmitted to the

computer or edited by the operator is placed into areas of the screen which permit it to be transmitted. Any screen which is divided in such a way is said to be formatted and any screen without this separation is called unformatted.

Protected and Unprotected Fields

The areas of the formatted screen which prevent and permit data entry are referred to as being protected and unprotected fields respectively. Each field type has its own considerations. Any number of fields may be created on the screen.

Protected Fields

Protected fields are those which prevent the data contained within them from being transmitted and prevents the user cursor from entering those fields.

1. Alphanumeric Protected

These fields appear on the screen display but are not transmitted during data communication. The operator cursor is not able to enter these fields. They are usually used as visual cues to direct the operator where information is to be entered onto the screen.

2. Constant Protected

These fields are not displayed on the screen display and cannot be altered by the operator. They are never transmitted to the printer during data communication. Instead they are transmitted to the computer where they are used for form titles and identification codes required by a computer application program.

3. Print-Only Protected

These fields do not appear in the display and are not sent to the computer. Instead, they are sent only to the printer as if they were part of the displayed information. These fields are generally used to print those forms which are longer or wider than the display.

Unprotected Fields (Variable Fields)

Unprotected fields, which are also called variable fields, are those which permit the data contained within them to be transmitted and also permit the entry of the operator cursor.

Modify Mode

Occasionally an application will contain information which is repetitious and needs little, if any, modification (for example, lists of similar numbers or names etc.). The Modify Mode allows the operator to either change the data as required or to TAB out of the field.

3.3.4 How to Enter Data

3.3.4.1 Introduction

One of the most important functions of the terminal is that of data entry. Data is entered through the keyboard and then communicated to a computer or an auxiliary device. In performing this function the operator is concerned not only with how data is to be entered but also how the terminal will perform according to screen format. This section will demonstrate the data entry procedures and how the screen format influences the data entry process.

3.3.4.2 Data Entry onto an Unformatted Screen (all modes)

Procedure: Data is entered onto the screen by using the keys of the Alphanumeric group and the Numeric group.

Character Space: The operator may enter eighty characters per line and twenty-four lines on a page. There are 1,920 character positions available on a screen.

Restrictions: Data may not be entered into the STATUS LINE area.

3.3.4.3 Data Entry on a Formatted Screen (all modes except FORM)

Procedure: Data is entered onto the screen by using the keys of the Alphanumeric group and the Numeric group.

Text Entry Area: The operator may enter data only into the appropriately designated fields of the formatted screen.

Considerations: 1. Data may be entered only into unprotected (variable) fields.

2. The Cursor Control Group key functions perform differently according to screen format.

3. TAB control function depends upon whether the screen is formatted or unformatted.

3.3.5 How to Edit Data

3.3.5.1 Introduction

After data has been entered, it may require correction. Correcting (or editing) data is accomplished through the use of the Edit Group keys. With these keys the operator can perform varying degrees of edit operation to individual characters, lines, fields, pages and entire screen.

This chapter provides a detailed explanation, procedure and analysis of the machine's edit capabilities. For easy reference and operator convenience, the edit features have been listed by their function.

3.3.5.2 Inserting a Line

- Procedure:
1. Position the cursor to where a line is to be inserted.
 2. Depress and release the INS L Key; the cursor will return to the beginning of the line. Lines of data beneath the cursor will move down one line.
 3. Type in the line to be inserted.

Effect:

Unformatted Display or FORM mode:

The present cursor line and all subsequent lines will move down one line with each depression of the INS L Key and the 24th line will disappear.

Formatted Display (In all modes except FORM):

This key is not operative on a formatted screen unless the terminal is in FORM mode.

3.3.5.3 Deleting a line

- Procedure:
1. Position the cursor any where on the line to be deleted.
 2. Depress and release the DEL L key.

Effect:

Unformatted Display or FORM mode:

Depressing this key will cause the current cursor line to be deleted. All subsequent lines will move up one line and line 24 will be blank.

Formatted Display (In all modes except FORM):

This key is not operative on a formatted screen unless the terminal is in FORM mode.

3.3.5.4 Inserting a Character with Reposition to End of Line or End of Field

Procedure:

1. Move the cursor to the appropriate character position.
2. Engage the INS C key by depressing and releasing it once.
3. Type in character(s) to be inserted.
4. Disengage the INS C key with a second depression and release.

Effect:

Unformatted Display or FORM mode:

Data on the line to the right of the cursor will move one position to the right. The character occupying column 80 will be deleted.

Depressing the INS C key will cause the STATUS LINE message INSERT EOL to appear.

Formatted Display (In all modes except FORM):

Character insertion can only take place in a variable field (unless the terminal is in FORM mode). The data in the variable field moves on position to the right and the character in the rightmost part of the field is deleted. The cursor will stop when it reaches the end of the field. To insert a character in the protected field the terminal must be in FORM mode.

Depressing the INS C key will cause the STATUS LINE to display INSERT EOF.

3.3.5.5 Inserting a Character with Reposition to End of Page

- Procedure:
1. Position the cursor to the appropriate character position.
 2. Simultaneously depress the SHIFT-INS C keys and release.
 3. Type in the character(s) to be inserted.
 4. Disengage the SHIFT-INS C keys with a second depression and release.

Effect:

Unformatted Display or FORM mode:

After the character is inserted all characters to the right of the cursor move to the right one position. The character occupying the 80 column position will move to the beginning of the next line. The character occupying the 80 column position of the 24th line is lost.

The message INSERT EOP will appear on the STATUS LINE.

Formatted Display (In all Modes except FORM):

Character insertion can only take place in a variable field. Depression of these keys enables insertion to the end of the field.

The message INSERT EOF will appear on the STATUS LINE.

3.3.5.6 Deletion of a Character with Repositioning of the line or field

- Procedure:
1. Position the cursor at the character to be deleted.
 2. Depress DEL C key.

Effect:

Unformatted Display or FORM mode:

The desired character will be deleted and all characters on that line will be moved one position to the left.

Formatted Display (In all modes except FORM):

The desired character will be deleted and all characters within the field will be moved one position to the left.

3.3.5.7 Deletion of a character with Reposition to End of Page

1. Position the cursor at the character to be deleted.
2. Simultaneously depress the SHIFT-DEL C keys.

Effect:

Unformatted Display or FORM mode:

The desired character will be deleted and all characters to the end of page are moved one position to the left. Characters in the first position of each line are moved to the last position of the previous line.

Formatted Display (in all modes except FORM):

Depressing these keys has the same effect as unshifted.

3.3.5.8 Erase to End of Line or to End of Field

- Procedure:
1. Position the cursor at the first character to be erased in the line or the field.
 2. Simultaneously depress and then release the CTRL-EOF keys.

Effect:

Unformatted Display or FORM mode:

All characters and spaces from the present cursor position to the end of the line are erased. All characters preceding the cursor are undisturbed and the cursor remains at its current location.

Formatted Display (in all modes except FORM)

Characters within the variable field following the cursor are erased and the protected fields are undisturbed. The cursor remains at its current location.

3.3.5.9 Erase to End of Page

- Procedure:
1. Position the cursor beneath the first character of the area to be erased.
 2. Simultaneously depress and release CTRL-SHIFT-EOF keys.

Effect:

Unformatted Display or FORM mode:

All characters from the present cursor position to the end of the page are erased and the characters preceding the cursor position are undisturbed.

Formatted Display (in all modes except FORM mode):

The contents of all variable fields from the cursor to the end of the page are erased. All protected fields are undisturbed as well as those variable fields preceding the cursor.

3.3.5.10 Erasing All Variable Fields

- Procedure:
1. Simultaneously depress and release the CTRL-E ALL keys.

Effect:

Unformatted Display or FORM mode:

Depression of these keys erases the entire page and brings the cursor to the HOME position.

Formatted Display (in all modes except FORM):

All variable fields are erased and the cursor is placed in the first unprotected field on the page. Protected fields are left undisturbed.

3.3.5.11 Erasing an Entire Page

- Procedure:
1. Simultaneously depress the CTRL-SHIFT-E ALL keys.

Effect:

Unformatted Display or FORM mode:

The entire display is erased and assumes a "blank" screen status. The cursor returns to the upper left hand corner of the screen.

Formatted Display (in all modes except FORM):

The entire display, including both protected and variable fields, are erased. The entire screen assumes an unformatted screen status. The cursor returns to the upper left hand corner of the screen.

3.3.6 How to Transmit Data

3.3.6.1 Introduction

The final function of the terminal, once the information has been entered and edited, is to send it either to the computer, the printer, or to the computer and the printer simultaneously. This section will explain the different kinds of transmission and demonstrate the data communication procedure.

3.3.6.2 How to Transmit to the Computer

Explanation: Information can be sent to the computer in either one of two ways. One way is with unbuffered transmission which is only available in CONV mode. Information is not held by the terminal (hence, unbuffered) and is transmitted from the XMIT port to the computer on a character by character basis as it is entered from the keyboard. The other method of transmitting data involves the buffered method of transmission (all modes except CONV). In this case information is first held by the terminal and is sent either line at a time or page at a time to the computer at the depression of the XMIT key.

Communication between the terminal and the computer always takes place through the XMIT port. How the information is transmitted to the computer is determined by what mode (CONV, MSG, PAGE, FORM or MODIFY) the terminal is operating in and by the screen format as well.

Procedure: (Unbuffered) If transmission is to occur as it is entered on the screen then place the terminal in CONV mode by depressing the CONV key.

(Buffered) If data is to be held on the screen before sending it to the computer then the terminal should be operating in either MSG,PAGE FORM, or MODIFY modes. The port is always enabled.

Effect on an Unformatted Screen:

CONV - Data is transmitted to the computer at the same time that it is displayed on the screen.

MSG - All data on the line of the present cursor position is transmitted. After the transmission has occurred the cursor returns to the leftmost margin of the transmitted line if Auto Line Feed is off. If Auto Line Feed is on, then the cursor returns to the leftmost margin of the following line.

PAGE - While the terminal is in PAGE mode transmission can occur either in a full or partial page format. Depressing the XMIT key will cause the data from the beginning of the page to the current cursor position to be transmitted. A DEL character will indicate the end of transmission.

If only a partial page of data has been transmitted, the balance of the screen may also be transmitted by moving the cursor to the end of the desired message and depressing the XMIT key. In this case the terminal will transmit from the DEL character to the cursor.

In order to save transmission time and expense the terminal does not transmit the spaces which follow the end of a line. (Instead of spaces, the terminal indicates line demarcation through the use of a special code called a Group Separator (GS) code. A line containing no data at all is represented as a single nondisplayed GS code. Data transmission of this type is referred to as Space Compression.)

FORM - All data contained within the screen memory is transmitted and the cursor returns to the HOME position. The transmission of highlighted fields is preceded by the code sequences used to create them.

Effect with a Formatted Screen:

CONV Mode - Data is not held in screen memory before it is sent to the computer (unbuffered). Instead, it is sent to the computer as it is entered onto the screen on a character by character basis. Only data entered into the unprotected fields is transmitted.

Because it is an unbuffered communication mode, transmission through the XMIT port occurs without having to first depress the XMIT key. The XMIT port is enabled by placing the terminal into CONV mode. A transmission terminator code is sent upon completion of the transmission.

MSG Mode - Data is first stored in screen memory (buffered) and then transmitted through the XMIT port by depressing the XMIT key. Only the unprotected data occupying the same line as the current cursor position is transmitted.

PAGE Mode - All unprotected data is transmitted through the XMIT port by depressing the XMIT key. A group separator code will be generated for all protected data on the screen.

FORM Mode - All data in screen memory is transmitted including field attribute codes.

3.3.6.3 How to Send to the Printer Only (Print Local)

Explanation: This procedure will enable the operator to print what is on the screen without transmitting to the computer. There are several Print Local procedures for varied results.

Print All Unprotected Fields and Print Only Fields:

Procedure: 1. Put the terminal into CONV, MSG or PAGE Mode.
2. Depress the PRINT key.

Effect: All unprotected and Print Only fields are printed. All visual attributes and predefined or Protected fields are transmitted as spaces.

Print All Fields but not Attributes:

Procedure: 1. Put the terminal into CONV, MSG or PAGE Mode.
2. Simultaneously depress the SHIFT-PRINT keys.

Effect: All fields are printed and Attributes are represented by spaces.

Print All Fields Including Attributes:

Procedure: 1. Put terminal into FORM mode.
2. Depress PRINT key.

Effect: All fields are printed. All attribute codes are printed.

NOTE: Printer must be able to accept the code stream.

3.3.6.4 Computer to the Printer (Transparent Print)

Explanation: This procedure enables the computer to communicate directly to the printer without involving the terminal.

Procedure: Place the terminal into Transparent Print operation by depressing ESC,3. This will be noted on the Status Line by the Message TRNPRNT AUX. The terminal is taken out of this mode by depressing ESC,4.

Effect: The ESC,3 command takes the terminal off line, enabling the host computer to bypass the terminal and communicate with the printer directly.

3.3.6.5 How to Send to the Computer and Printer Simultaneously

Explanation: Information on the screen will be sent to the computer and to the printer at the same time.

Procedure: 1. Depress the AUX key. The message AUX will appear in the Status Line.
2. Enter all data onto the terminal screen.
3. Send the message by depressing the XMIT key. (If the terminal is in any mode other than CONV mode.)
4. Disable the PRINT port by depressing the AUX key a second time.

- Effect:
1. Depressing the AUX key enables the PRINT port and keeps it open for transmission. Data will also go to the CPU via the EIA port if in CONV mode. If the terminal is in any other mode, than the XMIT key must be depressed.
 2. Only unprotected data is transmitted unless the terminal is operating in FORM mode which will transmit the entire contents of the screen memory.

SECTION 4



CHAPTER 4 PROGRAMMER INFORMATION

4.1 INTRODUCTION

This chapter provides the information which is required by the programmer. To facilitate ease of understanding, all conceptual information is presented in the first section of the chapter while the second section lists all terminal functions, function descriptions and command codes.

Previous sections of the manual will provide the reader with any additional information or help define any unfamiliar terminology.

4.2 PROGRAMMER'S CONCEPTS

4.2.1 INTRODUCTION

In addition to introducing those terminal features which pertain only to the programmer, this section will also provide the supplementary information required by the programmer for functions described previously in the manual. This additional information will enhance the reader's understanding of the many terminal features by presenting them from the perspective of the programmer.

4.2.2 DISPLAY COMMANDS

(UN)FORMATTED SCREENS

This format status is removed only when a Clear-All command is executed. One cannot remove a format status by writing over a protected field with an unprotected field.

VIDEO ATTRIBUTE

Field video attributes will only be created while the terminal is in FORM mode (while in Regent® 40 Compatible Mode, Video Attributes may be entered at any time). Attributes which have been entered in FORM mode will remain in effect until another video attribute is introduced or until the cursor reaches the end of the page.

Video attributes serve as visual delimiters between partitioned areas of the screen. As attributes they are available as either variable or protected. There are three protected attribute types: Print Only, Constant and Alphanumeric. (See DATA ENTRY CONCEPTS in the Operating Procedure Section.)

For a list of the video attributes refer to Appendix D.

FINE LINE GRAPHICS

The Fine Line Graphic feature enables the user to create charts, boxes, screen partitions and a variety of line drawings. There are eleven available symbols. Each symbol can be displayed as normal video, blinking, half intensity or as a combination of half intensity and blinking.

The line graphic symbols are displayed within an 8x10 dot matrix boundary. Each character position is occupied by a line graphic symbol and is able to connect to the next adjacent character.

For a list of the Fine Line Graphic Symbols see Appendix E.

4.2.3 CURSOR COMMANDS

CURSOR ADDRESS

The cursor may be moved to any part of the user entry area. The commands for directing cursor movement are present in the Absolute Cursor Addressing Chart and in the Vertical and Horizontal Cursor Addressing Chart included in Appendix C.

TAB STOPS

Depressing the TAB key when the terminal displays a formatted screen, the cursor will tab to the first space of a variable field. Depressing SHIFT-TAB will cause the cursor to move backwards.

4.2.4 MODE COMMANDS

FORM MODE

This mode is used to create formatted screen displays from the keyboard. All fields are accessible by the user cursor while the terminal is in FORM mode. All spaces between the attributes will then be filled by visual highlights.

A transmit (XMIT) command while the terminal is in FORM mode will transmit both variable and protected fields. The terminal will generate all codes necessary to recreate the form.

The following procedure describes how to create a formatted screen:

1. Put the terminal into FORM mode (ESC,R).
2. Referring to the Visual Attribute Chart in Appendix D, depress ESC,Ø and then enter an attribute code from the PROTECTED column. This will generate the chosen attribute on the entire screen.
3. Fill the protected field with the protected data.

4. Create a variable field by depressing ESC, Ø and entering an attribute code from the VARIABLE column of the Visual Attribute Chart. This will clear the protected attribute and replace it with the variable.
5. This procedure is continued until the form is completed.
6. Exit FORM mode by depressing the CONV, MSG, or PAGE mode keys. The screen is now formatted.

In the absence of a protected field an unformatted screen status exists.

TRANSMIT MODES

As described in the OPERATOR INFORMATION section, the operating modes CONV, MSG, and PAGE are used according to application requirements. The transmit function will send to the computer only data contained in a variable field, except FORM mode, in a manner determined by the operating mode. Transmission in CONV mode sends information on a character by character basis. In MSG mode transmission occurs to the end of the line and to the end of the screen while in PAGE mode.

MODIFY MODE

This is an operational mode which can be used when data entered to a form is largely repetitious. MODIFY mode is operational only on a formatted screen and requires variable fields to be present on the screen. MODIFY mode causes the terminal to transmit only those fields which have been edited since the preceding transmission by INS CHAR, DEL CHAR or by entry of a character into the field. MODIFY Mode reduces overhead for the application by reducing the volume of data sent back to the computer.

Modify mode is terminated when the terminal receives the command to enter CONV, MSG, PAGE or FORM mode. Execution of this command is signified by a STATUS LINE message.

MONITOR MODE

This is a function which is used to monitor data as it is being received from the computer. It displays control codes and is used to test data streams for accuracy. Monitor mode can be executed locally by the key depression sequence CTRL-1 and is disabled by CTRL-2. All control codes are displayed according to the assigned key codes (see Appendix B) but not acted upon by the terminal.

This feature is for diagnosing and correcting application programs.

VIEWPOINT/60

CHAPTER 4: PROGRAMMER'S CONCEPTS

- COMMUNICATION COMMANDS -
- KEYBOARD COMMANDS -

4.2.5 COMMUNICATION COMMANDS

X/ON - X/OFF

The X/ON - X/OFF feature enables the Viewpoint 60 to monitor and control communication between the computer and the device connected to the AUX port via the DTR control capability. If the printer is receiving data from the computer at a rate which exceeds its ability to print it, and if it causes a change in voltage (from +12 to -12) along the DTR control line, this causes the terminal to notify the computer to stop transmitting data by sending an X-OFF character. When the printer is able to accept data from the computer, it can change the voltage along the DTR control line (from -12 to +12) which causes the terminal to generate an X-ON character. This causes communication to resume.

- NOTES:
1. This protocol should not be used while the terminal is in HALF-DUPLEX Mode.
 2. DC1 and DC3 control codes, sent from the printer, are not recognized and are passed onto the CPU.
 3. The printer must support the DTR signal.

TERMINAL STATUS MESSAGE

The terminal status message, displayed on the Status Line when the terminal is turned on, indicates the current configuration of the terminal. It displays the operating mode (LOCAL, Keyboard Lock, etc.), error conditions, current cursor position and the data at the current cursor position.

Transmission of the terminal status message occurs locally in the on-line mode by depressing ESC, CTRL-E. On-line or Local Mode Transmission by the CPU occurs when an ESC, ENQ sequence is received by the EIA Port.

The terminal status message consists of 11 to 14 bytes of data. Each byte transmitted from the modem port has its most significant bit set according to the terminal parity (odd, even, marking or spacing). Each byte displayed on the screen has its most significant bit set to 0 so that a visual attribute character (where the MSB = 1) will not be displayed in the terminal status message. There are six bits remaining for information in each of the bytes of the terminal status messages.

Table 4-1 describes the terminal status message and defines all of the message positions.

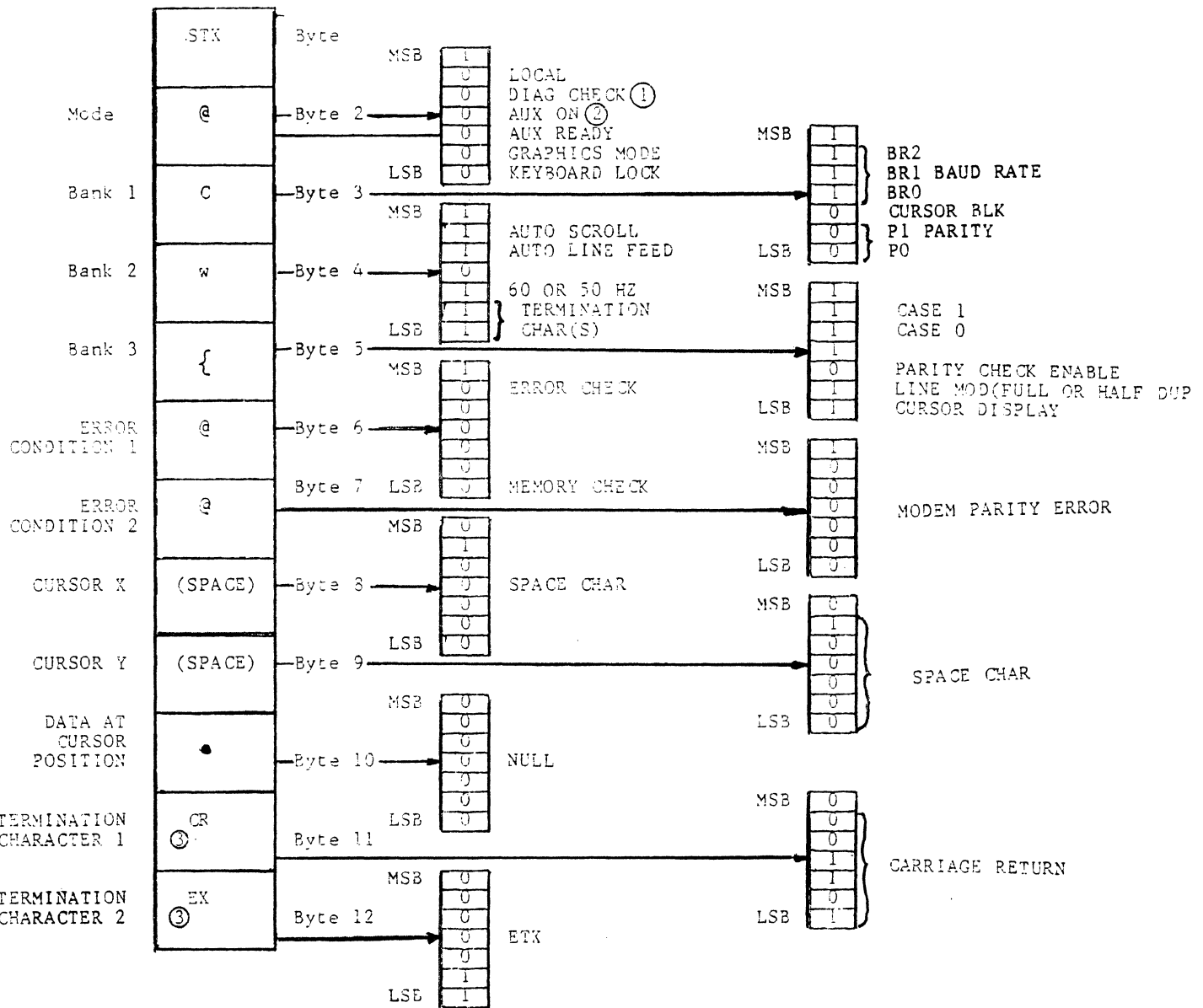

Table 4.1 Terminal Status Message Map

NOTE: If the cursor is positioned on an attribute or graphics character, the character is preceded by ESC,0 or ESC,1 respectively.

1. Not implemented in Regent® 60
2. Not implemented in Viewpoint® 60
3. Function of Termination Characters

4.2.6 KEYBOARD COMMANDS

Function Keys (F1-F8)

Function keys labeled F1 through F8 are provided above the numeric pad on the right side of the keyboard. The following table gives the codes generated by these keys. Sixteen unique codes can be transmitted by using the keys in conjunction with the SHIFT key. The end-of-line terminator code in use (selected in SETUP Mode) is automatically appended to the function sequence transmitted. The function keys transmit their sequence in all modes.

Function Key	UNSHIFTED	SHIFTED
F1	STX 1	STX !
F2	STX 2	STX "
F3	STX 3	STX #
F4	STX 4	STX \$
F5	STX 5	STX %
F6	STX 6	STX &
F7	STX 7	STX '
F8	STX 8	STX (

Figure 4-1 CODES Generated By Keys F1-F8

TERMINAL COMMANDS

Commands which generate ASCII codes to affect the state of the terminal can be entered using ASCII Code Sequences. However, frequently used commands can be obtained by using one of the function keys (F1-F8) alone or in conjunction with the SHIFT or CTRL key. For example, the Delete Character Command may be generated by depressing the DEL C key or the ASCII code sequence ESC,E.

The following Terminal Commands cannot be generated by dedicated keys on the terminal:

Cursor Addressing	Audible Tone
Baud Rate	Keyboard Lock/Unlock
Line Drawing Mode Enable/Disable	Enter Attribute
Read Status	Form Mode
Control Code Storage	Modify Mode
Transparent Mode Enable/Disable	Local
	Monitor Mode

4.2.7 MISCELLANEOUS COMMANDS

STORE CONTROL CODES

This function causes the character which follows the command sequence to be regarded by the terminal as a data character. This is useful for those applications which require that a control code to be stored in screen memory in order to execute some function. (e.g. a CR code placed at the end of a line in order to control the printer.)

4.3 TERMINAL COMMAND DESCRIPTIONS

4.3.1 INTRODUCTION

In this section of the chapter, all of the terminal functions are presented. Each function is listed with its remote command and followed by a brief description of what the function does and what elements are included in the remote command. Each command is listed alphabetically within its overall functional grouping (keyboard, mode, etc.).

In Appendix A of this manual the remote commands appear again but without an accompanying description. In this way the listing serves as a quick reference chart for the programmer's convenience.

4.3.2 DISPLAY COMMANDS

FINE LINE GRAPHICS (ESC,1)

This code places the terminal into a line drawing mode. See Appendix E for a list of the graphic symbols.

Disabled by the command ESC,2.

SET VIDEO ATTRIBUTES (ESC,Ø,x)

The character defined by x identifies the desired visual attribute (see Appendix D).

VIDEO OFF (ESC,D)

This function blanks the entire video screen. It can be utilized to inhibit viewing the screen during the creation process of a formatted screen.

VIDEO ON (ESC,d)

This function enables the entire video display.

STATUS LINE (Disabled) (ESC,B)

This function disables the STATUS LINE (line 25) display by suppressing its video representation.

STATUS LINE (Enable) (ESC,b)

This command displays the STATUS LINE (line 25).

4.3.3 CURSOR COMMANDS

ABSOLUTE ADDRESS (ESC,Y,r,c)

The characters r,c (row, column) respectively refer to the vertical and horizontal addresses for positioning the user cursor on the user entry area. The addresses are described in the Absolute Address Chart (see Appendix C).

BACKSPACE (BS) (CTRL-H)

This function moves the cursor one position to the left. If the cursor is at the beginning of a line it will go to the end of the previous line. If the cursor is at the top left position it goes to lower right.

CARRIAGE RETURN (CR) (CTRL-M)

With the Auto Line Feed function disabled, the cursor will return to the beginning of the current line. When the Auto Line Feed function is enabled, this command will move the cursor to the beginning of the next line.

CURSOR BACK (NAK) (CTRL-U)

This key functions in the same manner as the BACKSPACE key and generates the ASCII code NAK.

LINE FEED (Cursor Down LF) (CTRL-J)

This command causes the cursor to move down one line while maintaining the current column position. Scrolling will occur if the cursor is on line 24 on an unformatted screen and with the scroll function enabled. The cursor will move from line 24 to line 1 on a formatted screen.

CURSOR FORWARD (ACK) (CTRL-F)

This advances the cursor one position to the right. If the cursor occupies the last position of a line then this command causes the cursor to advance to the first position of the next line, depending on Auto Line Feed. If the cursor occupies the last position of an unformatted screen, scrolling will occur. If the screen is formatted then the cursor will reposition to the upper left position.

CURSOR HOME (SOH) (CTRL-A)

With the terminal operating in CONV mode on an unformatted screen, this function causes the cursor to move to the bottom left-hand corner of the screen. In all other modes the HOME cursor position will be in the upper left-hand corner of the screen.

The cursor can be forced to be always upper left via SETUP Mode.

CURSOR OFF (CTRL-W)

This command causes the user cursor to become invisible.

CURSOR ON (CTRL-X)

This command restores the visible cursor.

CURSOR UP (CTRL-Z)

This command causes the cursor to move upward one line while maintaining the same column or position. It functions conversely to the Cursor Down command with the exception that it does not cause scrolling.

HORIZONTAL ADDRESS (DLE,c)

This command moves the cursor horizontally to that column defined by the character "c" on the Row/Column Address Chart contained in the Appendix.

TAB (HT)

1. Formatted Screen (not FORM Mode)

The cursor moves to the first character position in a non protected field.

2. Formatted Screen (FORM mode)

The cursor moves from its current position to the beginning of the next protected or unprotected field.

BACK TAB (ESC,0)

This command causes the cursor to move backwards. If the cursor is positioned at the beginning of a variable field, it will TAB to the beginning of the previous field.

VERTICAL ADDRESS (VT,r)

The character "r" represents the row address as defined in the Row/ Column Cursor Address Chart. This command moves the cursor to that position defined by r.

MUST TAB MODE (ESC,H)

When this command is issued then all fields become MUST TAB fields. The operator must depress the TAB key to exit the field. When disabled (ESC,h) the cursor will automatically move to the next variable field when the present field is filled.

4.3.4 EDIT COMMANDS

DELETE CHARACTER (to EOF/EOL) (ESC,E)

This command deletes the characters in the present cursor position and causes characters to the right of the cursor to move one position to the left. The cursor does not move. Only the characters on the line of the current cursor position move to the left. A character space will occupy the rightmost portion of the line. The only characters affected are from the cursor to the end of the line (in the case of an unformatted screen) or to the end of a field (formatted screen).

If the display has been formatted and the terminal is in a data entry mode then this command will permit deletion of characters in a field.

DELETE CHARACTER to EOP (ESC,e)

This command is functional in FORM mode and in all unformatted operational modes only. It causes deletion of all characters from the present cursor position to the end of the page.

ERASE ALL (FF) (CTRL-L)

This command clears the entire screen including data fields and protected fields.

ERASE TO EOF/EOL (ESC,K)

This command erases all data from the current cursor position to the end of the line on an unformatted screen or to the end of the variable field on a formatted screen. In both cases, the character occupying the current cursor position is erased.

ERASE TO EOP (ESC,k)

On an unformatted screen or in FORM mode, all variable fields from the present cursor position to the end of the page are erased. All characters preceding the cursor are undisturbed. On a formatted screen all variable fields from the present cursor position to the end of the page are erased. All protected fields are undisturbed as well as those variable fields preceding the cursor.

ERASE VARIABLE DATA (ESC,G)

This command causes the contents of all variable fields to be erased. In FORM mode it will erase all data contained on the screen.

INSERT CHARACTER to EOF/EOL (ESC,F)

On an unformatted screen or in FORM mode, this command permits insertion of one or more characters at the current cursor position. The data on the line moves one position to the right with the right most character on the line being lost. When the cursor reaches the end of the line, it will not automatically advance to the next line.

On a formatted screen, in all modes except FORM mode, character insertion can only take place in variable fields. The data in the field moves one position to the right and the right most character is lost. The cursor will stop when it reaches the end of the variable field.

INSERT CHARACTER to EOP (ESC,f)

This function is similar to INSERT CHARACTER (to EOF/EOL) except that it is operational only in FORM mode and on an unformatted screen and is active to the end of the page.

INSERT LINE (ESC,M)

This command causes the current cursor line and all succeeding lines to be moved down one line. The bottom line is removed from the display. The cursor then moves to the beginning of the new blank line. This key is not operative when the screen is formatted unless the terminal is in FORM mode.

DELETE LINE (ESC,l "e1")

This command causes the current cursor line to be erased. All succeeding lines are moved up one line and line 24 becomes blank. The cursor moves to the beginning of the current line. This key is not operative when the screen is formatted unless the terminal is in FORM mode.

4.3.5 MODE COMMANDS

CONV MODE (ESC,V)

This non buffered mode enables the terminal to transmit data on a character by character basis.

MESSAGE MODE (ESC,u)

This buffered operating mode enables the terminal to transmit one line of data for each transmit command.

MODIFY MODE (ESC,C)

This command puts the terminal in Modify mode.

MONITOR MODE ON (CTRL-1) (use the alphanumeric keyboard group only)

This command enables the Monitor mode.

MONITOR MODE OFF (CTRL-2) (use the alphanumeric keyboard group only)

This command disables the Monitor mode.

OFF-LINE MODE (LOCAL mode) (ESC,t)

This command takes the terminal off line which temporarily suppresses any interaction between the terminal and the CPU. The Aux port is still enabled.

ON-LINE MODE (ESC,T)

This command sets On-Line mode and returns the terminal to its original operating mode.

PAGE MODE (ESC,U)

This command puts the terminal into the PAGE operating mode.

TRANSPARENT MODE (Enable) (ESC,3)

All data from the host CPU is output to the AUX port but not displayed on the screen following this command. The PRINT (XMIT) port is automatically enabled.

TRANSPARENT MODE (Disable) (ESC,4)

This command terminates the Transparent mode.

4.3.6 COMMUNICATION COMMANDS

AUX-OFF (DC4)

This command disables the AUX port.

AUX-ON (DC2)

This command enables the AUX port.

AUX BAUD RATE (set) (ESC,A,n)

The baud rate remains active until it is changed for all Aux functions or until the terminal is powered on.

The character n defines the Aux port baud rate as follows:

Rate	n=
110	1,A,Q,a,q
150	2,B,R,b,r
300	3,C,S,c,s
1200	5,E,U,e,u
1800	6,F,V,f,v
2400	7,G,W,g,w
4800	8,H,X,h,x
9600	:,J,Z,j,z
19,200	Not available

PRINT LOCAL (all) (ESC,x)

This function behaves in a similar fashion to the PRINT LOCAL Variable and Null; with the exception that protected data is printed instead of being replaced with spaces. (Refer to the next entry.)

PRINT LOCAL (Variable and Null) (ESC,X)

The PRINT LOCAL function enables the screen contents to be sent to the printer without transmitting to the computer.

All PRINT command functions begin at the upper left-hand corner of the screen (line 1, column 1). The entire screen is printed with protected fields replaced with the equivalent number of spaces in the data output stream (for output to pre-printed forms).

READ TERMINAL STATUS (ESC,ENQ)

This command causes the terminal to transmit the following to the CPU:

- a. The Terminal Status.
- b. Current Cursor position.
- c. Data at the current cursor position.

TRANSMIT (ESC,DC1)

This command causes data contained in screen memory to be transmitted to the CPU via the XMIT port according to the terminal operating mode.

4.3.7 KEYBOARD COMMANDS

KEYBOARD LOCK (ESC,5)

This command locks the terminal keyboard from the computer system preventing any operator activity.

VIEWPOINT/60
CHAPTER 4: TERMINAL COMMANDS
- KEYBOARD -

KEYBOARD UNLOCK (ESC,6)

This command unlocks the terminal keyboard.

AUDIBLE TONE (BEL) (CTRL-G)

This function causes the audio device in the keyboard to be activated for approximately 1/2 sec. (A volume control potentiometer is accessible through a hole in the bottom of the keyboard and, with a thin screwdriver, adjusts the sound level of the audible device. In addition to sounding a BEL tone this device also produces the audible key click.)

STORE CONTROL CODE (ESC,Z)

This command causes the characters which follow the command code to be considered as a data character and not acted upon by the terminal, regardless of its location on the ASCII chart.

<u>APPENDIX</u>	<u>CONTENTS</u>	<u>PAGES</u>
A	TERMINAL COMMANDS	A-1 - A-3
B	ASCII CHART	B-1
C	CURSOR ADDRESSING CHART	C-1
D	VISUAL ATTRIBUTE CHARTS	D-1
E	SPECIAL GRAPHICS CHART.	E-1
F	INTERNATIONAL KEYBOARD LAYOUTS.	F-1 - F-7
G	STORAGE OF CONTROL CODES.	G-1
H	TERMINAL COMPARISON CHART	H-1

Function	Keystroke	ASCII	Ch 4 Ref.	Explanation
DISPLAY COMMANDS				
Fine Line Graphics Fine Line (Disable) Set Video Attribute	---	ESC,1 ESC,2 ESC,0,x	2,6 1,6	See Appendix E The character defined by x identifies the desired Video attribute. (See App.B)
Video OFF		ESC,D	6	
Video ON		ESC,d	6	
Status Line (disable)		ESC,B	6	
Status Line (enable)		ESC,b	6	
CURSOR COMMANDS				
Absolute Address		ESC,Y, r,c	2,7	The characters r,c (row, column) refer to the vertical and horizontal address as described in the absolute address chart (See Appendix C)
Backspace	BACKSPACE	BS	7	
Carriage Return	RETURN	CR	7	
Cursor Back		NAK	7	
Cursor Down		LF	7	
Cursor Forward		ACK	7	
Cursor Home	HOME	SOH	7	
Cursor Off	CTRL-W		8	
Cursor On	CTRL-X		8	
Cursor Up		SUB	8	
Horizontal Address	---	DLE,c	8	The character c represents the column address on the horizontal address chart (see appendix C)
Line Feed	Line Feed	LF	8 2,8	
TAB	TAB	HT	2,8	
BACK TAB	SHIFT-TAB	ESC,0	2,8	

Function	Keystroke	ASCII	Ch 4 Ref.	Explanation
CURSOR COMMANDS				
Must TAB (enable) Must TAB (disable) Vertical Address	---	ESC,H ESC,h VT,r	9 9 2,8	The character r represents the row address on the vertical address chart (see Appendix C)
EDIT COMMANDS				
Delete Character (To EOF/EOL)	DEL C	ESC,E	8	
Delete Character (To EOP)	SHIFT-DEL C	ESC,e	8	
Erase All	CTRL-SHIFT-E ALL	FF	8	
Erase to EOF/EOL	CTRL-EOF	ESC,K	8	
Erase to EOP	CTRL-SHIFT-EOF	ESC,k	8	
Erase Variable Data	CTRL-E ALL	ESC,G	8	
Insert Character (to EOF/EOL)	INS C	ESC,F	8	
Insert Character (to EOP)	SHIFT-INS C	ESC,f	8	
Insert Line	INS L	ESC,M	10 10	
Delete Line	DEL L	ESC,l ("el")		
MODE COMMANDS				
Conversational Mode	CONV	ESC,V	10	
Form Mode	FORM	ESC,R	3,10	
Message Mode	MSG	ESC,u	10	
Modify Mode		ESC,C	3,10	
Monitor Mode (On)	CTRL-1	---	3,10	

Function	Keystroke	ASCII	Ch 4 Ref.	Explanation
MODE COMMANDS				
Monitor Mode (Off)	CTRL-2	---	10	
Off-Line Mode		ESC,t	10	
On-Line Mode	CTRL-LOCAL	ESC,T	10	
Page Mode	PAGE	ESC,U	11	
Transparent Mode (Disable)	---	ESC,4	11	
Transparent Mode (enable)	---	ESC,3	11	
COMMUNICATIONS				
Aux OFF	AUX	DC4	4,11	
Aux ON	AUX	DC2	4,11	
Aux Baud Rate (set)	---	ESC,A,n	11	The character n defines Aux port baud rate.
Print Local (all)	SHIFT-PRINT	ESC,x	11	
Print Local (variable, null)	PRINT	ESC,X	11	
Read Terminal Status	---	ESC,ENQ	4,12	
Transmit	XMIT	ESC,DC1	3,12	
KEYBOARD COMMANDS				
Keyboard Lock		ESC,5	12	
Keyboard Unlock		ESC,6	12	
MISC COMMANDS				
Audible Tone		BEL	12	
Store Control Code		ESC,Z	6,12	

APPENDIX B ASCII CHART

Bits					0 0 0	0 0 1	0 1 0	0 1 1	1 0 0	1 0 1	1 1 0	1 1 1
b ₄	b ₃	b ₂	b ₁	ROW ↓	0	1	2	3	4	5	6	7
0	0	0	0	0	NUL	DLE	SP	0	@	P	`	p
0	0	0	1	1	SOH	DC1	!	1	A	Q	a	q
0	0	1	0	2	STX	DC2	"	2	B	R	b	r
0	0	1	1	3	ETX	DC3	#	3	C	S	c	s
0	1	0	0	4	EOT	DC4	\$	4	D	T	d	t
0	1	0	1	5	ENQ	NAK	%	5	E	U	e	u
0	1	1	0	6	ACK	SYN	&	6	F	V	f	v
0	1	1	1	7	BEL	ETB	'	7	G	W	g	w
1	0	0	0	8	BS	CAN	(8	H	X	h	x
1	0	0	1	9	HT	EM)	9	I	Y	i	y
1	0	1	0	A	LF	SUB	*	:	J	Z	j	z
1	0	1	1	B	VT	ESC	+	;	K	[k	{
1	1	0	0	C	FF	FS	,	<	L	\	l	;
1	1	0	1	D	CR	GS	-	=	M]	m	}
1	1	1	0	E	SO	RS	.	>	N	^	n	~
1	1	1	1	F	SI	US	/	?	O	_	o	DEL



FIELD VISUAL ATTRIBUTES AND SPECIAL FIELDS

ESC,Ø,x where x =

	Variable	Protected	Special Constant	Protected Print Only
Normal	@	H		
Half Intensity (Half)	A	I		
Blink	B	J		
Half/Blink	C	K		
Zero	D	L	d	l
Reverse (Rev)	P	X		
Rev/Half	Q	Y		
Rev/Blink	R	Z		
Rev/Half/Blink	S	[
Rev/Zero	T	\	t	!
Underline (Ul)	`	h		
UL/Half	a	i		
UL/Blink	b	j		
UL/Half/Blink	c	k		
UL/Rev	p	x		
UL/Rev/Half	q	y		
UL/Rev/Blink	r	z		
UL/Rev/Blink/Half	s	{		











VIEWPOINT/60
APPENDIX E SPECIAL GRAPHICS CHART

ESC,l,x where x =

LINE DRAWING SYMBOL CHART

SYMBOL POSITION

VISUAL EFFECT

		NORMAL	HALF INTENSITY	BLINK	HALF BLINK
	LOWER RIGHT CORNER	@	A	B	C
	LOWER LEFT CORNER	D	E	F	G
	UPPER RIGHT CORNER	H	I	J	K
	UPPER LEFT CORNER	L	M	N	O
	BOTTOM INTERSECT	P	Q	R	S
	LEFT INTERSECT	T	U	V	W
	RIGHT INTERSECT	X	Y	Z	[
	TOP INTERSECT	\]	^	_
	HORIZONTAL LINE	-	a	b	c
	VERTICAL LINE		e	f	g
	CROSSED LINES	h	i	j	k

This mode is exited by depressing ESC,2.

APPENDIX F: INTERNATIONAL KEYBOARD LAYOUTS

This appendix details the International Keyboard layouts. Included on each page is the keyboard and its corresponding ASCII table. Those keys which differ from the standard keyboard are designated with a circle.

The following International kits are available:

<u>Language</u>	<u>Kit Part Number</u>
U.K.	370-17700
France	370-17800
Spain & Portugal	370-17900
Germany & Switzerland	370-18000
Sweden & Finland	370-18100
Denmark & Norway	370-18200

Kits are common to the VP/60 and VP/90. Only one kit can be used at a time. Each kit contains all necessary keycaps, two PROM's, installation instructions and International keyboard layout. After installing the kits, all characters will be displayed on the screen as they appear on the keyboard.

APPENDIX F INTERNATIONAL KEYBOARD LAYOUTS

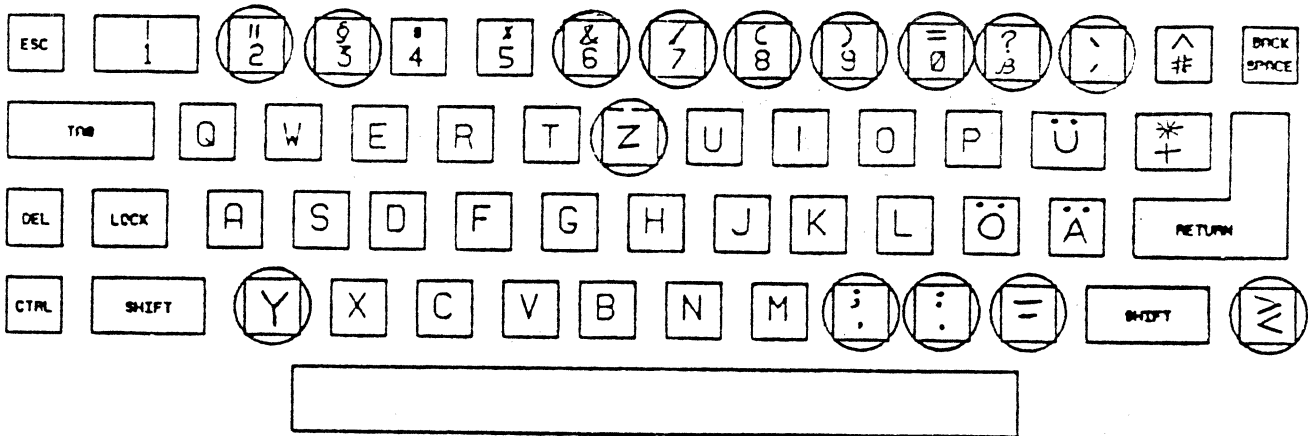

Bits					0 0	0 0 1	0 1 0	0 1 1	1 0 0	1 0 1	1 1 0	1 1 1
b ₄	b ₃	b ₂	b ₁	COLUMN ROW	0	1	2	3	4	5	6	7
0	0	0	0	0	NUL	DLE	SP	0	ø	P	'	ø
0	0	0	1	1	SOH	DC1	!	1	A	Q	a	q
0	0	1	0	2	STX	DC2	"	2	B	R	b	r
0	0	1	1	3	ETX	DC3	*	3	C	S	c	s
0	1	0	0	4	EOT	DC4	\$	4	D	T	d	t
0	1	0	1	5	ENQ	NAK	%	5	E	U	e	u
0	1	1	0	6	ACK	SYN	&	6	F	V	f	v
0	1	1	1	7	BEL	ETB	'	7	G	W	g	w
1	0	0	0	8	BS	CAN	(8	H	X	h	x
1	0	0	1	9	HT	EM)	9	I	Y	i	y
1	0	1	0	A	LF	SUB	•	:	J	Z	j	z
1	0	1	1	B	VT	ESC	•	;	K	Ä	k	ä
1	1	0	0	C	FF	FS	,	<	L	Ö	l	ö
1	1	0	1	D	CR	GS	-	•	M	Ü	m	ü
1	1	1	0	E	SO	RS	.	>	N	^	n	ß
1	1	1	1	F	SI	US	/	?	O	—	o	DEL

GERMANY / SWITZERLAND

APPENDIX F INTERNATIONAL KEYBOARD LAYOUTS

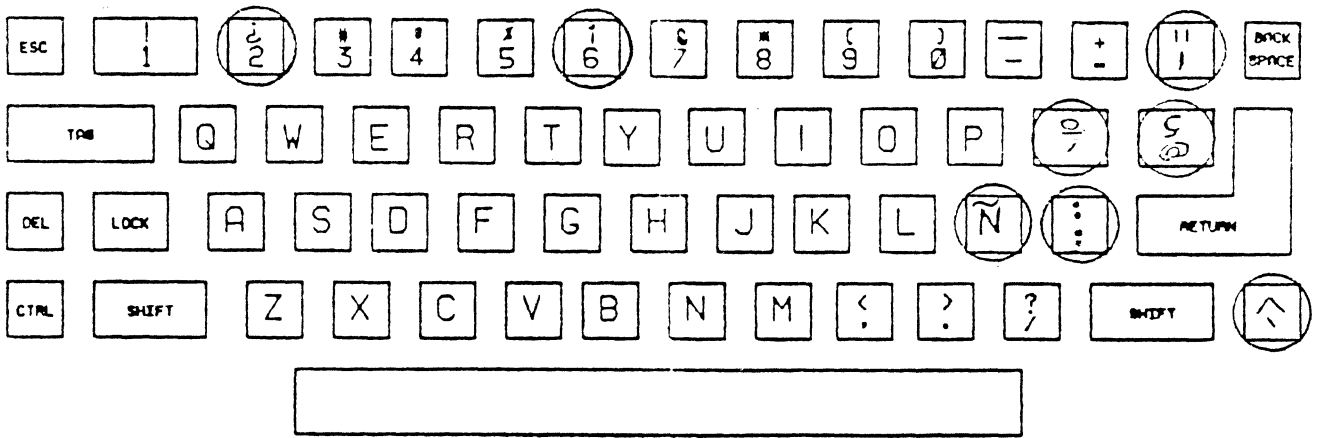

Bits					0 0	0 0 1	0 1 0	0 1 1	1 0 0	1 0 1	1 1 0	1 1 1
b ₄	b ₃	b ₂	b ₁	COLUMN ROW	0	1	2	3	4	5	6	7
0	0	0	0	0	NUL	DLE	SP	0	@	P	~	p
0	0	0	1	1	SCH	DC1	!	1	A	Q	a	q
0	0	1	0	2	STX	DC2	"	2	B	R	b	r
0	0	1	1	3	ETX	DC3	#	3	C	S	c	s
0	1	0	0	4	EOT	DC4	\$	4	D	T	d	t
0	1	0	1	5	ENQ	NAK	%	5	E	U	e	u
0	1	1	0	6	ACK	SYN	&	6	F	V	f	v
0	1	1	1	7	BEL	ETB	'	7	G	W	g	w
1	0	0	0	8	BS	CAN	(8	H	X	h	x
1	0	0	1	9	HT	EM)	9	I	Y	i	y
1	0	1	0	A	LF	SUB	*	:	J	Z	j	z
1	0	1	1	B	VT	ESC	+	;	K	[k	o
1	1	0	0	C	FF	FS	,	<	L	~	l	~
1	1	0	1	D	CR	GS	-	=	M	^	m	ç
1	1	1	0	E	SO	RS	.	>	N	^	n	/
1	1	1	1	F	SI	US	/	?	O	_	o	DEL

SPAIN / PORTUGAL

APPENDIX F INTERNATIONAL KEYBOARD LAYOUTS

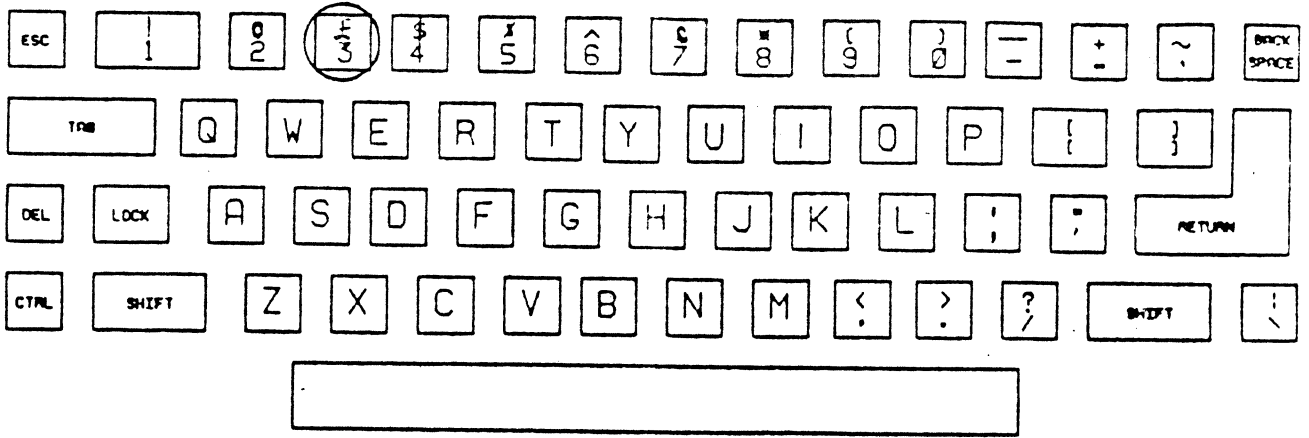

Bits					0 0	0 0 1	0 1 0	0 1 1	1 0 0	1 0 1	1 1 0	1 1 1	
b ₇	b ₆	b ₅	COLUMN		0	1	2	3	4	5	6	7	
			b ₄	b ₃	b ₂	b ₁	ROW						
0	0	0	0	0	0	NUL	DLE	SP	0	@	P	~	p
0	0	0	1	1	1	SOH	DC1	!	1	A	Q	a	q
0	0	1	0	0	2	STX	DC2	"	2	B	R	b	r
0	0	1	1	1	3	ETX	DC3	&	3	C	S	c	s
0	1	0	0	0	4	EOT	DC4	\$	4	D	T	d	t
0	1	0	1	1	5	ENQ	NAK	%	5	E	U	e	u
0	1	1	0	0	6	ACK	SYN	&	6	F	V	f	v
0	1	1	1	1	7	BEL	ETB	'	7	G	W	g	w
1	0	0	0	0	8	BS	CAN	(8	H	X	h	x
1	0	0	1	1	9	HT	EM)	9	I	Y	i	y
1	0	1	0	0	10	LF	SUB	*	:	J	Z	j	z
1	0	1	1	1	11	VT	ESC	+	;	K	[k	{
1	1	0	0	0	12	FF	FS	,	<	L	\	l	!
1	1	0	1	1	13	CR	GS	-	=	M]	m	}
1	1	1	0	0	14	SO	RS	.	>	N	^	n	~
1	1	1	1	1	15	SI	US	/	?	O	_	o	DEL

UNITED KINGDOM

APPENDIX F INTERNATIONAL KEYBOARD LAYOUTS

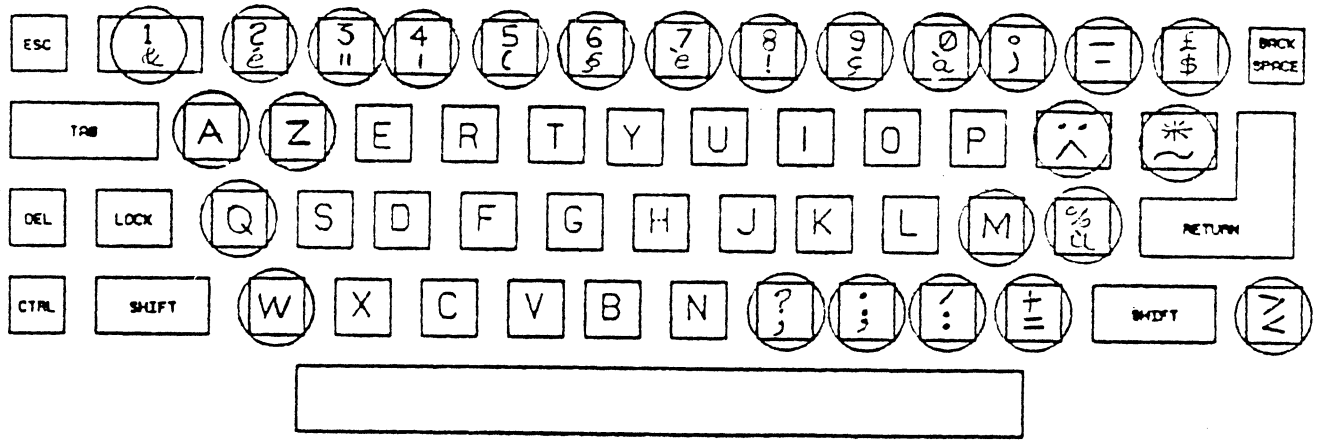

Bits					0 0	0 0	0 1	0 1	1 0	1 0	1 1	1 1				
b7	b6	b5	b4	b3	b2	b1	COLUMN	row	0	1	2	3	4	5	6	7
0	0	0	0	0	0	0	NUL	0	DLE	SP	0	à	P	••	p	
0	0	0	1	1	1	1	SOH	1	DC1	!	1	A	Q	q	q	
0	0	1	0	0	0	2	STX	2	DC2	"	2	B	R	b	r	
0	0	1	1	1	1	3	ETX	3	DC3	£	3	C	S	c	s	
0	1	0	0	0	0	4	EOT	4	DC4	\$	4	D	T	d	t	
0	1	0	1	1	1	5	ENQ	5	NAK	%	5	E	U	e	u	
0	1	1	0	0	0	6	ACK	6	SYN	&	6	F	V	f	v	
0	1	1	1	1	1	7	BEL	7	ETB	'	7	G	W	g	w	
1	0	0	0	0	0	8	BS	8	CAN	(8	H	X	h	x	
1	0	0	1	1	1	9	HT	9	EM)	9	I	Y	i	y	
1	0	1	0	0	0	A	LF	A	SUB	*	:	J	Z	j	z	
1	0	1	1	1	1	B	VT	B	ESC	-	;	K	O	k	é	
1	1	0	0	0	0	C	FF	C	FS	,	<	L	S	l	ù	
1	1	0	1	1	1	D	CR	D	GS	-	=	M	Ô	m	é	
1	1	1	0	0	0	E	SO	E	RS	.	>	N	^	n	~	
1	1	1	1	1	1	F	SI	F	US	/	?	O	_	o	DEL	

FRANCE

APPENDIX F INTERNATIONAL KEYBOARD LAYOUTS

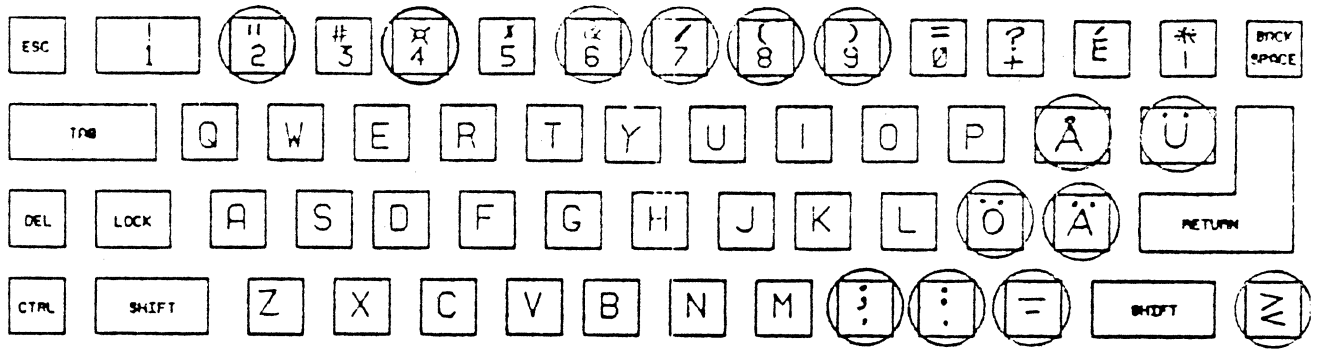

Bits					0 0	0 0	0 1	0 1	1 0	1 0	1 1	1 1
b ₇	b ₆	b ₅	b ₄	b ₃	0	1	2	3	4	5	6	7
				COLUMNS	ROW							
b ₄	b ₃	b ₂	b ₁									
0	0	0	0	0	NUL	DL	SP	0	É	P	é	p
0	0	0	1	1	SCH	DC1	!	1	A	Q	a	q
0	0	1	0	2	STX	DC2	"	2	B	R	b	r
0	0	1	1	3	ETX	DC3	#	3	C	S	c	s
0	1	0	0	4	EOT	DC4	¥	4	D	T	d	t
0	1	0	1	5	ENQ	NAK	%	5	E	U	e	u
0	1	1	0	6	ACK	SYN	&	6	F	V	f	v
0	1	1	1	7	BEL	ETB	'	7	G	W	g	w
1	0	0	0	8	BS	CAN	(8	H	X	h	x
1	0	0	1	9	HT	EM)	9	I	Y	i	y
1	0	1	0	A	LF	SUB	*	:	J	Z	j	z
1	0	1	1	B	VT	ESC	+	;	K	Å	k	å
1	1	0	0	C	FF	FS	,	<	L	Ö	l	ö
1	1	0	1	D	CR	GS	-	=	M	Ä	m	ä
1	1	1	0	E	SO	RS	.	>	N	Ü	n	ü
1	1	1	1	F	SI	US	/	?	O	—	o	DEL

SWEDEN/ FINLAND

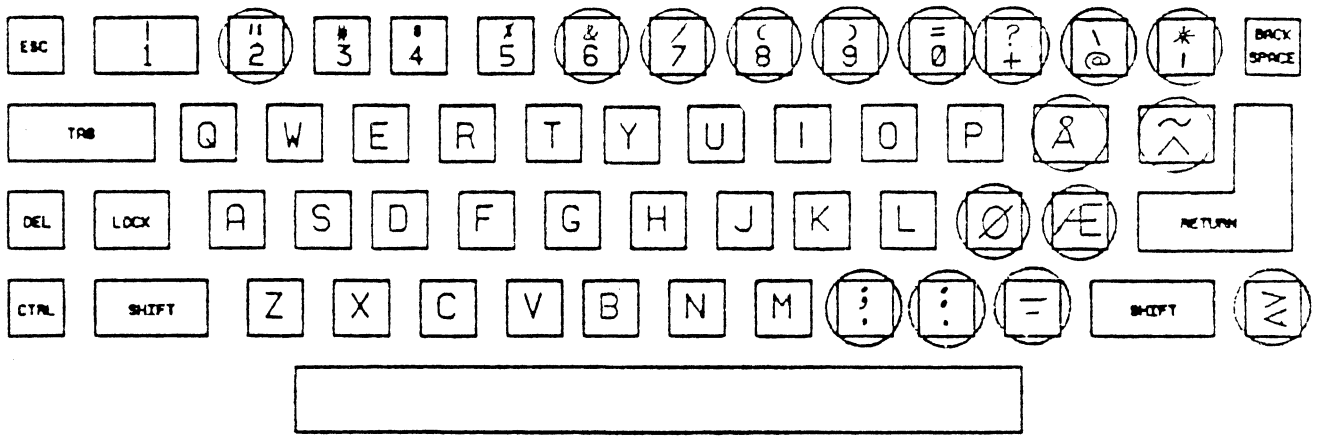







Bits					0 0	0 0 1	0 1 0	0 1 1	1 0 0	1 0 1	1 1 0	1 1 1
b ₇	b ₆	b ₅	COLUMN		0	1	2	3	4	5	6	7
b ₄ b ₃ b ₂ b ₁				ROW								
0	0	0	0	0	NUL	DLE	SP	0	@	P	~	ø
0	0	0	1	1	SCH	DC1	!	1	A	Q	a	q
0	0	1	0	2	STX	DC2	"	2	B	R	b	r
0	0	1	1	3	ETX	DC3	#	3	C	S	c	s
0	1	0	0	4	EOT	DC4	\$	4	D	T	d	t
0	1	0	1	5	ENQ	NAK	%	5	E	U	e	u
0	1	1	0	6	ACK	SYN	&	6	F	V	f	v
0	1	1	1	7	BEL	ETB	'	7	G	W	g	w
1	0	0	0	8	BS	CAN	(8	H	X	h	x
1	0	0	1	9	HT	EM)	9	I	Y	i	y
1	0	1	0	A	LF	SUB	*	:	J	Z	j	z
1	0	1	1	B	VT	ESC	+	;	K	Æ	k	æ
1	1	0	0	C	FF	FS	,	<	L	Ø	l	ø
1	1	0	1	D	CR	GS	-	=	M	Å	m	å
1	1	1	0	E	SO	RS	.	>	N	^	n	~
1	1	1	1	F	SI	US	/	?	O	—	o	DEL

DENMARK/NORWAY

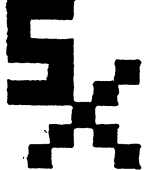
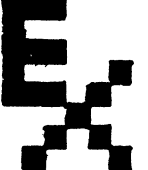

VIEWPOINT/60

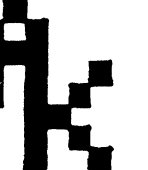
APPENDIX G: STORAGE OF CONTROL CODES

							
NULL	SOH	STX	ETX	EOT	ENQ	ACK	BEL

							
BS	HT	LF	VT	FF	CR	SO	SI

							
DLE	DC1	DC2	DC3	DC4	NAK	SYN	ETB

							
CAN	EM	SUB	ESC	FS	GS	RS	US

APPENDIX H: TERMINAL COMPARISON CHART

	Regent 40	Regent 60	Viewpoint/ 60	Viewpoint/ Color
HOME	CTRL A	CTRL A	CTRL A	CTRL A
CURSOR FORWARD	CTRL F	CTRL F	CTRL F	CTRL F
BELL	CTRL G	CTRL G	CTRL G	CTRL G
BACK SPACE	CTRL H	CTRL H	CTRL H	CTRL H
TAB	CTRL I	CTRL I	CTRL I	CTRL I
CURSOR DOWN	CTRL J	CTRL J	CTRL J	CTRL J
CURSOR BACK	CTRL U	CTRL U	CTRL U	CTRL U
ERASE ALL	CTRL L	CTRL L	CTRL F-L	CTRL L
CARRIAGE RETURN	CTRL M	CTRL M	CTRL M	CTRL M
PRINT ON	CTRL R	CTRL R	CTRL R	CTRL R
PRINT OFF	CTRL T	CTRL T	CTRL T	CTRL T
CURSOR UP	CTRL Z	CTRL Z	CTRL Z	CTRL Z
MONITOR MODE ENABLE	CTRL 1	CTRL 1	CTRL 1	CTRL 1
MONITOR MODE DISABLE	CTRL 2	CTRL 2	CTRL 2	CTRL 2
SET AUX BAUD RATE	N/A	ESC,A,x	ESC,A,x	ESC,A,x
STATUS LINE DISABLE	ESC,B	ESC,B	ESC,B	ESC,B
STATUS LINE ENABLE	ESC,b	ESC,b	ESC,b	ESC,b
MODIFY MODE	N/A	ESC,C	ESC,C	ESC,C
VIDEO OFF	ESC,D	ESC,D	ESC,D	ESC,D
VIDEO ON	ESC,d	ESC,d	ESC,d	ESC,d
DELETE CHARACTER IN LINE/FIELD	N/A	ESC,E	ESC,E	ESC,E
DELETE CHARACTER IN PAGE	N/A	ESC,e	ESC,e	ESC,e
INSERT CHARACTER IN LINE/FIELD	N/A	ESC,F	ESC,F	ESC,F
INSERT CHARACTER IN PAGE	N/A	ESC,f	ESC,f	ESC,f
ERASE VARIABLE DATA	N/A	ESC,G	ESC,G	ESC,G
MUST TAB ENABLE	N/A	ESC,H	ESC,H	ESC,H
MUST TAB DISABLE	N/A	ESC,h	ESC,h	ESC,h
ERASE TO END OF LINE/ FIELD	ESC,K	ESC,K	ESC,K	ESC,K
ERASE TO END OF PAGE	ESC,k	ESC,k	ESC,k	ESC,k
DELETE LINE	ESC,l	ESC,l	ESC,l	ESC,l
INSERT LINE	ESC,M	ESC,M	ESC,M	ESC,M
BACK TAB	N/A	ESC,O	ESC,O	ESC,O
FORMS, MODE	N/A	ESC,R	ESC,R	ESC,R
ON LINE	ESC,T	ESC,T	ESC,T	ESC,T
LOCAL	ESC,t	ESC,t	ESC,t	ESC,t
PAGE, MODE	N/A	ESC,U	ESC,U	ESC,U
MESSAGE, MODE	N/A	ESC,u	ESC,u	ESC,u
CONVERSATIONAL MODE	N/A	ESC,V	ESC,V	ESC,V
PRINT LOCAL VARIABLE AND NULL	N/A	ESC,X	ESC,X	ESC,X
PRINT LOCAL ALL	N/A	ESC,x	ESC,x	ESC,x
ABSOLUTE CURSOR ADDRESS	ESC,Y,r,c	ESC,Y,r,c	ESC,Y,r,c	ESC,Y,r,c

APPENDIX H: TERMINAL COMPARISON CHART

	Regent 40	Regent 60	Viewpoint/ 60	Viewpoint/ Color
SET ATTRIBUTE	ESC,Ø,x	ESC,Ø,x	ESC,Ø,x	ESC,Ø,x
LINE DRAW ENABLE	ESC,1	ESC,1	ESC,1	ESC,1
LINE DRAW DISABLE	ESC,2	ESC,2	ESC,2	ESC,2
TRANSPARENT ENABLE	ESC,3	ESC,3	ESC,3	ESC,3
TRANSPARENT DISABLE	ESC,4	ESC,4	ESC,4	ESC,4
KEYBOARD LOCK	ESC,5	ESC,5	ESC,5	ESC,5
KEYBOARD UNLOCK	ESC,6	ESC,6	ESC,6	ESC,6
VERTICAL ADDRESS	VT	VT,r	VT,r	VT,r
HORIZONTAL ADDRESS	DLE	DLE,c	DLE,c	DLE,c
TRANSMIT	ESC,DC1	ESC,DC1	ESC,DC1	ESC,DC1
READ STATUS	ESC,ENQ	ESC,ENQ	ESC,ENQ	ESC,ENQ
COLOR SELECT	N/A	N/A	N/A	ESC,7, ATTR,FC,BC
ATTRIBUTE SET VIDEO	ESC,Ø,a	ESC,Ø,a	ESC,Ø,a	ESC,Ø,a
STORE CONTROL CODES	ESC,Z,c	ESC,Z,c	ESC,Z,c	ESC,Z,c

ESC,A,x = The character "x" equals the desired baud rate.

ESC,Y,r,c = The characters "r" and "c" equal the row and column location on the display screen.

ESC,Ø,x = The character "x" equals the desired attribute.

ESC,7,ATTR,FC,BC = The lead in ESC,7 is followed by the desired attribute to be set, foreground color and background color.

ESC,Ø,a = The character "a" equals the desired attribute.

ESC,Z,c = The character "c" equals the code to be stored.

NOTES

