



# INSTRUCTION MANUAL

 **Gottlieb**  
AMUSEMENT GAMES

165 W. Loko Street, Northlake, IL 60164  
(312) 562-7400 Telex 72-8463

A Columbia Pictures Industries Company 

# I. INSTALLATION

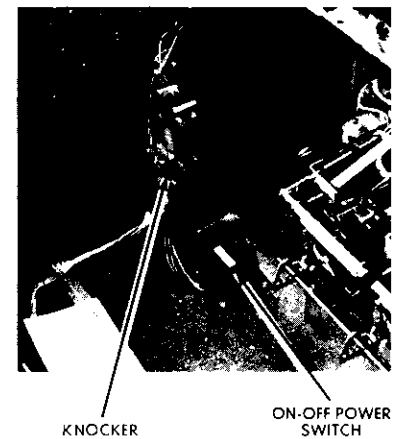
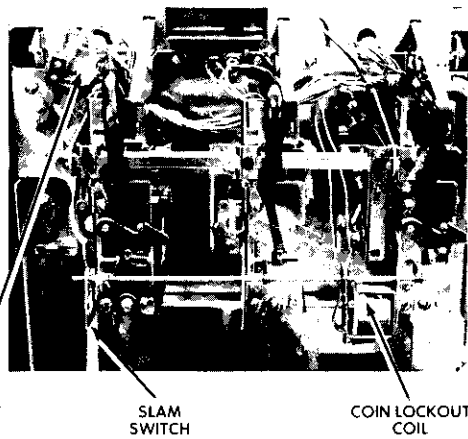
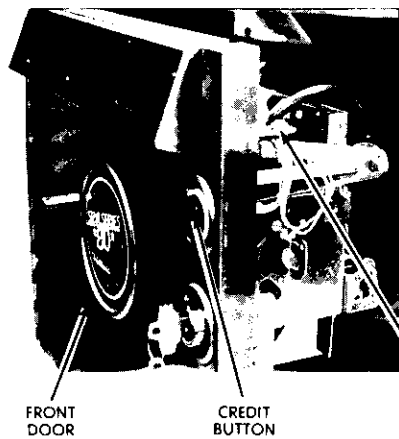
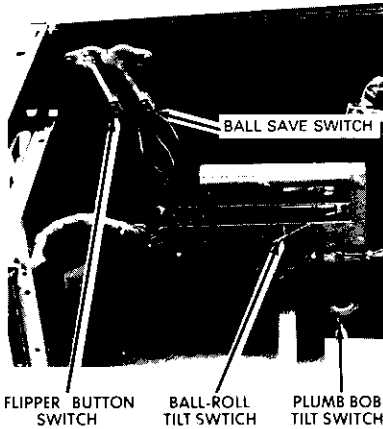
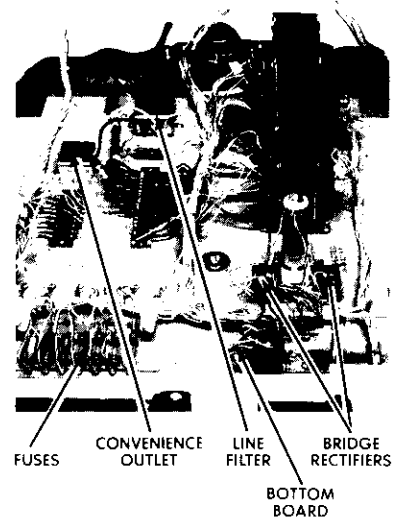
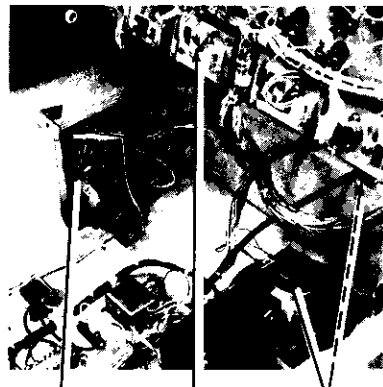
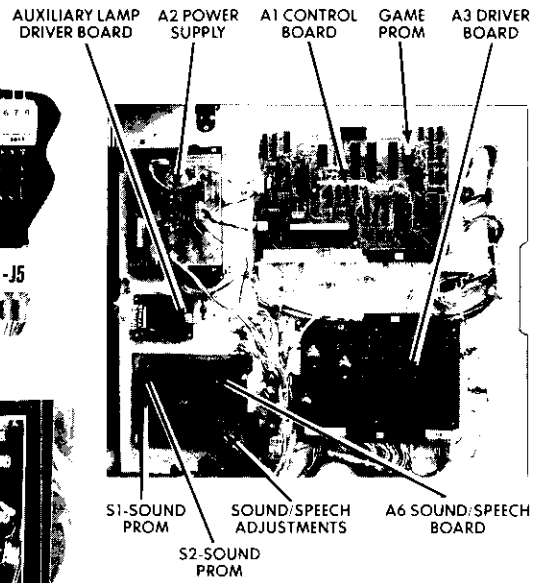
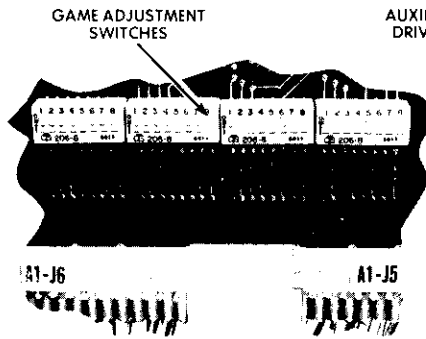
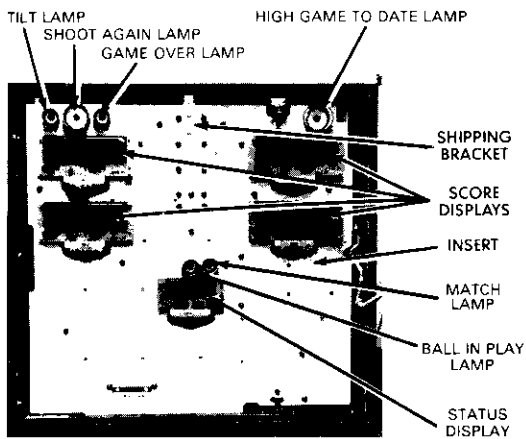

# I. INSTALLATION

## A. SET-UP

1. Bolt the legs to the cabinet.
2. Feed the line cord through the slot provided in the pedestal.
3. Place the lightbox atop the pedestal, making sure to engage the holding bracket.
4. Insert the key and unlock the lightbox door. Swing the backglass door out.
5. Loosen and lower the shipping bracket at the top center of the lightbox insert panel.
6. Lift the insert; then swing it out.
7. Secure lightbox to cabinet with bolts and washers provided.
8. Connect all cables and secure with cable clamps provided.
9. Open the cabinet door and loosen the front moulding locking arm.
10. Remove the moulding from the playfield.
11. Slide glass forward and let all 3 balls drain to the outhole.
12. Check for any loose wires.
13. Check switches for loose solder or other foreign matter.
14. Be certain all fuses are firmly seated.
15. Check transformers for any foreign matter across terminals.
16. Be sure transformer wiring corresponds to the supply voltage.
17. Check the setting of the normally open tilt switch on the underside of the playfield. One blade should be free-floating with a weight on the end.
18. Level the machine.
19. Adjust the plumb-bob tilt and the ball roll tilt to the sensitivity desired. Both tilt switches are normally open.
20. With the line cord unplugged, drop a coin into one of the chutes. It should be rejected.
21. Plug game into a properly grounded 3-wire receptacle **ONLY!**

## B. CHECK-OUT

1. Check that all cables are clear of moving parts.

LIGHTBOX HOLDING BRACKET

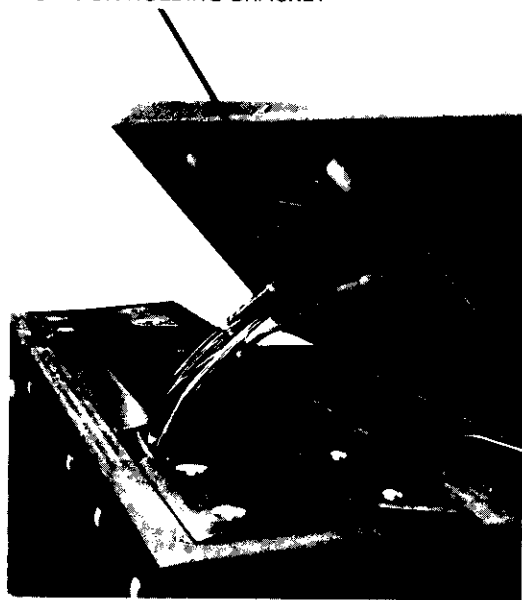

LOCATED ON PLAYBOARD UNDERSIDE

BALL SAVE RELAY (B) MOTOR RELAY (M) TILT RELAY (T)  
GAME OVER RELAY (Q)

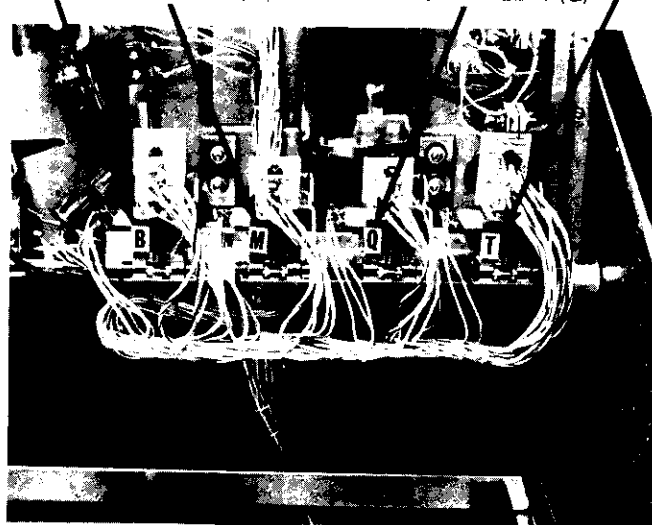

## II. INITIALIZATION

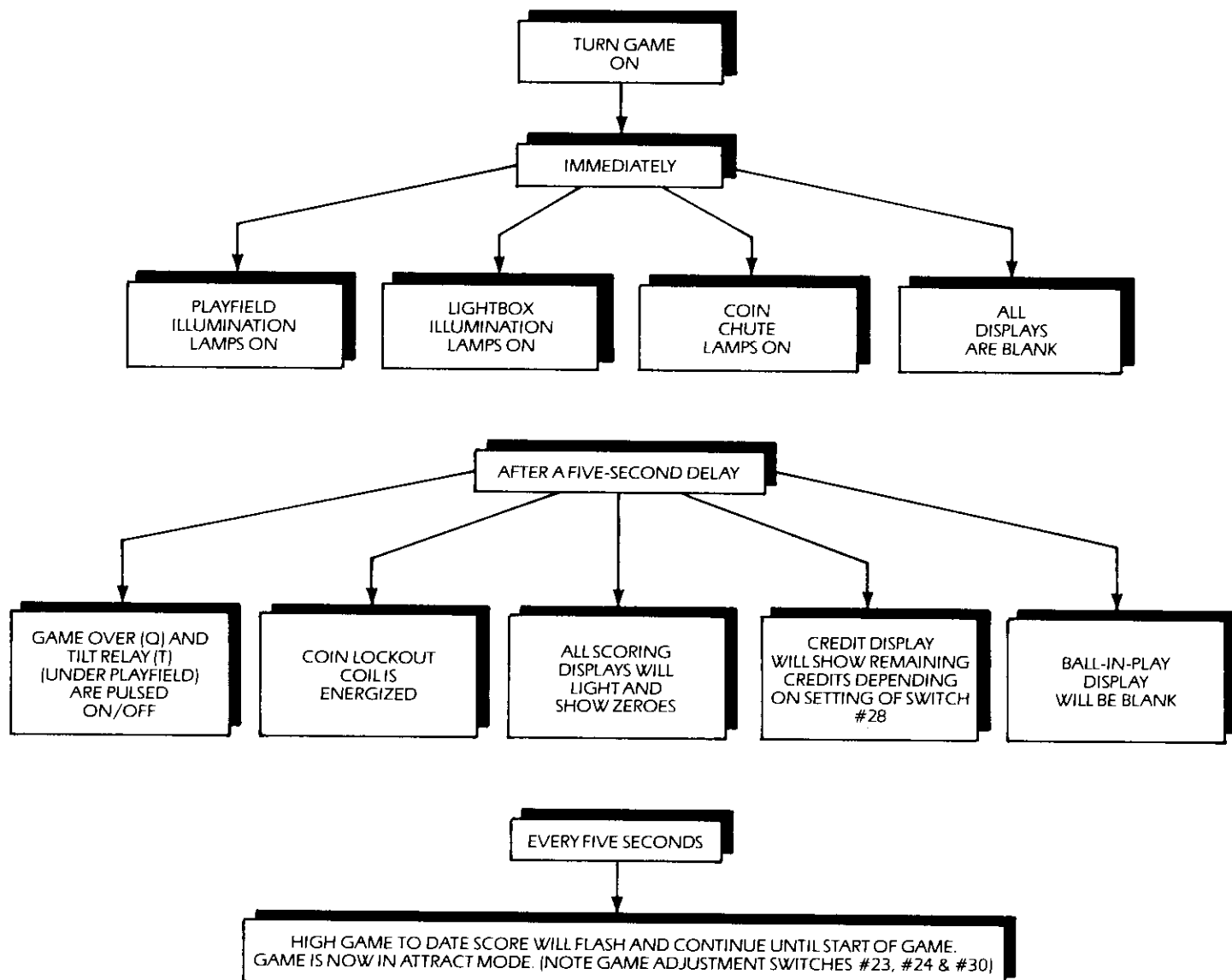

## III. GAME OPERATION

### A. GAME START

All three balls must be in the ball return trough to start a game.

1. Insert coins into coin chute.
  - a. Coin chute tune is played (dependent on Switch #27).
  - b. Total credits are displayed in status display (dependent on Switch #28).
2. Press Credit Button to start game.
  - a. Credit tune or voice is played.
  - b. Total credits displayed decrease by one.
3. All playfield features reset. Ball Shooter Guide moves back and forth.
4. The first player score display flashes a single zero.
5. When the ball is released to the shooter:
  - a. Playfield controlled lamps flash.
  - b. High Game to Date is briefly displayed in all four players' score displays.

### III. GAME OPERATION

#### B. FIRST PLAYER

1. First player's score display flashes single zero.
2. The other players' displays are now blank.
3. A "1" appears on the ball-in-play display.
4. When the ball enters the outhole, the bonus is scored.

#### C. ADDITIONAL PLAYERS

1. Additional players are indicated by a zero (not flashing) in each corresponding player's display.
2. After the maximum number of players are added, or no more credits remain, the Credit Button has no effect.
3. Additional players can be added any time the first player's first ball is still in play. If the Credit Button is pressed after the first player's first ball has entered the outhole, all players' scores will be erased with the first player's score display showing a flashing zero, indicating a new game only for the first player.

#### D. EXTRA BALLS

1. When the SHOOT AGAIN lamp is lit, neither the player-up nor the ball-in-play display changes when the ball enters the outhole.
2. Only one extra ball per ball-in-play is given.

#### E. TILT MODE

1. Tilting the game results in a loss of ball in play.
2. When the game is tilted, all the

playfield lamps go off except the pop bumper lights.

3. All accumulated bonus and bonus multipliers are lost.

#### F. SLAM MODE

1. If the normally closed slam switch (located inside front door) is opened, the entire game is ended for all players.
2. The GAME OVER lamp comes on.
3. The entire switch matrix is inactive for three seconds.
4. All coins will be rejected if dropped into any coin chute during the three second delay.
5. If the match feature exists (dependent on Switch #18), a replay can be won even if the game is slammed.
6. Game returns to the attract mode.

#### G. GAME OVER

1. When the last ball enters the outhole, the GAME OVER lamp continually flashes.
2. A random number appears in the ball-in-play display. If this number matches the last two digits in any player's score, a replay (dependent on Switch #18) is awarded.
3. HGTD is periodically flashed in all players' displays. When a score higher than this is achieved, an award (dependent on Switches #23 and #24) is given.
4. All captive balls will be ejected and returned to the outhole.
5. The two target banks will reset.

## IV. GAME PLAY AND SCORING

### SHOOTER GUIDE

When a ball is served to the shooter, drop target lights start sequencing and the shooter lane guide is activated. The right green button freezes the shooter guide and the rotating drop target lights. Hitting any switch except a ten-point switch restarts the drop target lights sequencing.

### BALL-SAVE

Hitting any individually lit drop target lights the "BALL-SAVE" on the left outlane. When the left green button is pressed, the BALL-SAVE is activated.

### CRATER FREEZE

- Volcano craters are sequentially lit (except during MULTI-BALL).
- Pressing the right green button freezes the crater lights for approximately one second.
- A scoring switch must be hit to enable the button to re-freeze crater lights.

### MULTI-BALL PLAY

- When a ball enters a lit crater, it will be captured and another released to the ball shooter.
- Two red lights ("LAVA LEVEL") in the middle of the playfield flash to show how many balls are captured. When one ball is captured, Lava Level One lamp will flash. When two balls are captured, both Lava Level One and Lava Level Two lamps will flash.
- When the third ball is captured, all balls will be launched, one at a time, from the "VOLCANO SHAFT."
- During MULTI-BALL PLAY, playfield scoring is 2X (two times) (3-Ball only). Playfield scoring remains 1X (one time) during 5-Ball play.
- No Volcano craters are lit.
- When two balls enter the outhole, scoring returns to 1X.
- Captive balls are remembered from ball to ball, unless another player uses them. Each player must capture three balls for MULTI-BALL.

### MULTIPLIERS

Lava Flow Multiplier (Playfield Scoring)

- Ball entering Craters 2, 3 or 4 will light corresponding lava flow multiplier for a timed period.

Seismic Multiplier (BONUS)

- Increased when an individually lit drop target is hit.

### COLLECT BONUS

- "COLLECT SEISMIC VALUE" arrow lights when bonus value reaches 19 (maximum).
- When ball enters hole kicker when ("COLLECT SEISMIC VALUE") is lit.
- After entering outhole.
- Turns off spinner light and resets "SEISMIC MULTIPLIER" to 1X.

### SPECIAL

- Ball entering all four craters will light "SPECIAL".
- Awarded when ball enters hole kicker when "SPECIAL" lamp is lit.
- Craters remembered ball to ball.
- "SPECIAL" light remembered ball to ball (3-Ball only).

### EXTRA BALL

- Completing both drop target banks will light "EXTRA BALL".
- Awarded when ball enters "FIRE PIT" when "EXTRA BALL" lamp is lit.
- Ball through right outlane with gate closed will light "EXTRA BALL" for one shot only (dependent on setting of Switch 31).

### CRATERS

- Capture ball if lit (See MULTI-BALL PLAY).
- Remembered ball to ball for SPECIAL.

#### CRATER 1

- Score 1000 points.
- Add BONUS.

#### CRATER 2

- Score 4000 points.
- Add two BONUS.
- Light 2X lava flow multiplier.

## IV. GAME PLAY AND SCORING

### CRATER 3

- Score 9000 points.
- Add three BONUS.
- Light 3X lava flow multiplier.
- Light spinner (See SPINNER).

### CRATER 4

- Score 16,000 points.
- Add four BONUS.
- Light 4X lava flow multiplier.
- Light spinner.

### FIRE PIT

- Score 5000 points.
- Award EXTRA BALL when lit.

### DROP TARGETS

- Score 100 points unlit.
- Score 1000 points when bank is lit.
- Score 5000 points, light left "BALL SAVE" and advance multiplier when individual lit target is hit.
- Add BONUS.
- Completed target bank resets, lights bank for 1000 point scoring, and lights "OPEN GATE" spot target.

### ROLLOVERS AND ROLLUNDER

#### LEFT RETURN ROLLOVER

- Score 100 points.
- Add BONUS.

#### LEFT OUTLANE ROLLOVER

- Score 3000 points.

#### RIGHT OUTLANE ROLLOVER

- Score 5000 points and light "EXTRA BALL" for one shot only when ball gate is closed. (Dep. on switch 31)
- Score 1000 points when "GATE OPEN" lamp is on; Ball Gate closes.

#### ROLLUNDER

- Score 3000 points.
- Add BONUS.

### HOLE KICKER

- Score 3000 points when collect bonus is unlit.
- Award special when lit.
- Collect bonus when lit.

### SPOT TARGET

- Score 1000 points.
- Opens right ball gate when lit.
- Turns off target light.

### SPINNER

- Score 100 points unlit.
- Score 1000 points when lit.
- Spinner lit when ball enters Crater #3 or Crater #4. (See CRATERS).

### TOP POP BUMPERS AND KICKING TARGET

- Score 1000 points (3-BALL).
- Score 100 points (5-BALL).

### BOTTOM POP BUMPERS

- Score 100 points.

### 10-POINT SWITCHES

- Score 10 points.

### HIGH GAME TO DATE

If the High Game to Date is 990,000 or greater at the start of a new game, the High Game to Date will automatically reset to 770,000.

## V. GAME SPEECH

### ATTRACT MODE OCCURRENCE

"DANGER VOLCANO"	Random.
"IT'S GONNA BLOW"	Random.
"THROW ME A SACRIFICE"	Random.

### GAME MODE OCCURRENCE

"VOLCANO"	a. Pressing credit button. b. Random scoring.
"SHOOT LIT VOLCANO"	Ball to Shooter.
"BALL SAVE"	Hitting lit drop target.
"LAVA RISING"	Capturing a ball in lit crater.
"ERUPTION"	When MULTI-BALL play is initiated.
"FIRE PIT"	When EXTRA BALL is lit.
"DANGER"	Random during scoring.
"IT'S GONNA BLOW"	When any non-capturing ball enters crater and no ball is in subway.
"THROW ME A SACRIFICE"	Random during scoring.
"TILT, TILT, TILT"	When game is tilted.
"OOOooo"	When game is slammed.



# VI. GAME ADJUSTMENTS

## A. CONTROL BOARD SWITCH ADJUSTMENTS

There are 32 switches on the control board which permit adjustment of the game parameters. These switches are contained in four packages of eight switches each, as shown below:

S1-S8	S9-S16	S17-S24	S25-S32
-------	--------	---------	---------

Switch settings are recognized only during normal power-up and when starting the first player of a new game (not when additional players are added).

SWITCHES				COIN CHUTE ADJUSTMENTS
S1	S2	S3	S4	Left Chute
S5	S6	S7	S8	Right Chute
S9	S10	S11	S12	Center Chute

NOTE: FOR GERMAN GAMES ONLY, switches S5-S8 adjust the center chute and switches S9-S12 adjust the right chute.

COINS/CREDITS				
OFF	OFF	OFF	OFF	1/1
OFF	OFF	OFF	ON	1/2
OFF	OFF	ON	OFF	1/3
OFF	OFF	ON	ON	1/4
OFF	ON	OFF	OFF	1/5
OFF	ON	OFF	ON	1/6
OFF	ON	ON	OFF	1/7
OFF	ON	ON	ON	1/8
ON	OFF	OFF	OFF	1/9
ON	OFF	OFF	ON	2/1*
ON	OFF	ON	OFF	2/2*
ON	OFF	ON	ON	2/3*
ON	ON	OFF	OFF	2/4*
ON	ON	OFF	ON	2/5*
ON	ON	ON	OFF	1/1 AND 2/3
ON	ON	ON	ON	3/1*

\*NO CREDITS UNTIL LAST COIN IS INSERTED.

**SWITCH 13** — **EXTRA CREDITS**  
 ON ..... Adds 9 credits to center coin chute setting  
 OFF ..... No effect

NOTE: FOR GERMAN GAMES ONLY, Switch 13 adds 9 credits to the right coin chute setting, when ON.

**SWITCH 14** — **COIN CHUTE CONTROL**  
 ON ..... Left and Right Chutes Same  
 OFF ..... Left and Right Chutes Separate

NOTE: FOR GERMAN GAMES ONLY, Switch 14 controls the left and center coin chutes.

SWITCHES		MAXIMUM CREDITS
15	16	
OFF	OFF	8
OFF	ON	10
ON	OFF	15
ON	ON	25

**SWITCH 17** — **BALLS PER GAME**  
 ON ..... 3  
 OFF ..... 5

**SWITCH 18** — **MATCH FEATURE**  
 ON ..... ON  
 OFF ..... OFF

**SWITCH 19** — **REPLAY LIMIT**  
 ON ..... Limits each player to one replay per game  
 OFF ..... No replay limit

**SWITCH 20** — **NOVELTY MODE**  
 ON ..... Playfield SPECIAL and EXTRA BALL features award 50,000 points and 5 knocks. High score, high game to date, and match features disabled.  
 OFF ..... Normal game mode

NOTE: SWITCH 20 overrides SWITCH 21.

**SWITCH 21** — **GAME MODE**  
 ON ..... Extra Ball  
 OFF ..... Replay

NOTE: IF SWITCH 21 is ON, the high game to date and match awards are disabled.

**SWITCH 22** — **PLAYFIELD SPECIAL**  
 ON ..... Awards Extra Ball  
 OFF ..... Awards Special

SWITCHES		HIGH GAME TO DATE
23	24	
OFF	OFF	Not displayed—no award
OFF	ON	Displayed—no award
ON	OFF	Displayed—awards 2 replays
ON	ON	Displayed—awards 3 replays

**SWITCH 25** — **MUST REMAIN ON**

**SWITCH 26** — **REPLAY BUTTON TUNE?**  
 ON ..... Yes  
 OFF ..... No

**SWITCH 27** — **COIN SWITCH TUNE?**  
 ON ..... Yes  
 OFF ..... No

**SWITCH 28** — **CREDITS DISPLAYED?**  
 ON ..... Yes  
 OFF ..... No

**SWITCH 29** — **OFF**

**SWITCH 30** — **ATTRACT FEATURES**  
 ON ..... ON  
 OFF ..... OFF

**SWITCHES 31, 32** — **LIBERAL-CONSERVATIVE**

(SEE SECTION VI, B)

## B. LIBERAL-CONSERVATIVE ADJUSTMENTS

- Game Adjustment Switch #31

ON (Liberal) — Ball through right outlane with gate closed will light EXTRA BALL for one shot only.

OFF (Conservative) — No EXTRA BALL through right outlane.

## VI. GAME ADJUSTMENTS

### C. POST ADJUSTMENTS

There is one post adjustment that provides liberal or conservative game play. See Playboard Information (page 31) for post positioning.

Damage to board components may result if settings are changed, unless an oscilloscope and calibration procedure is followed.

**THE SOUND/SPEECH BOARD (A6) USED IN VOLCANO GAME #667 IS NOT INTERCHANGEABLE WITH SOUND BOARDS (A6) USED IN GAMES PREVIOUS TO MARS (#666).**

### D. SOUND/SPEECH ADJUSTMENTS

Volume potentiometer for adjusting the speaker output is located on the bottom board and is accessible through the front door.

**IMPORTANT:** All potentiometers (pots) on the sound/speech board are factory adjusted for maximum voltage.

#### SWITCH BANK (SBI) SETTINGS:

SBI-1	USED IN SELF-TEST ONLY.	
SBI-2	NOT USED	
SBI-3	SBI-4	Attract Mode Speech
OFF	OFF	Disabled.
ON	OFF	Every 10 Seconds.
OFF	ON	Every 2 Minutes.
ON	ON	Every 4 Minutes.
SBI-5	ON	Background sound enabled.
	OFF	Background sound disabled.
SBI-6	ON	All Speech enabled.
	OFF	All Speech disabled.
SBI-7	NOT USED	
SBI-8	NOT USED	

SOUND/SPEECH BOARD (A6) TEST SEE SECTION IX, E PAGE 14.

## VII. BOOKKEEPING AND SELF TEST

The circuitry in this game helps the operator perform many bookkeeping and game test functions. The information is shown one step at a time in the first player's score display, while the step number is shown in the credit display (refer to flow chart Section VII, C for order and function).

any data is invalid or bad, that information will flash while it is displayed.

- If the SELF-TEST button is not pressed within 60 seconds of each step, the game will return to the attract mode.

### A. BOOKKEEPING

- Pressing the SELF-TEST button inside the front door begins the bookkeeping which are steps 01 through 15.
- The data in any of these steps may be reset to zero while it is displayed by pressing the replay button on the front door.
- **The SELF-TEST button must then be pressed to enter zero into memory.**
- All bookkeeping information is checked against itself to insure that it is correct. If

### B. SELF-TEST

- Steps 16 through 20 are SELF-TEST or game tests the operator can use for quick troubleshooting.
- All the tests are explained in the flow chart (Section VII, C).
- Each test can be repeated by pressing the replay button on the front door. This starts the test for another 60 seconds.
- If the SELF-TEST button or the replay button is not pressed within 60 seconds, the game will return to the attract mode.

# VII. BOOKKEEPING AND SELF TEST

## C. FLOW CHART

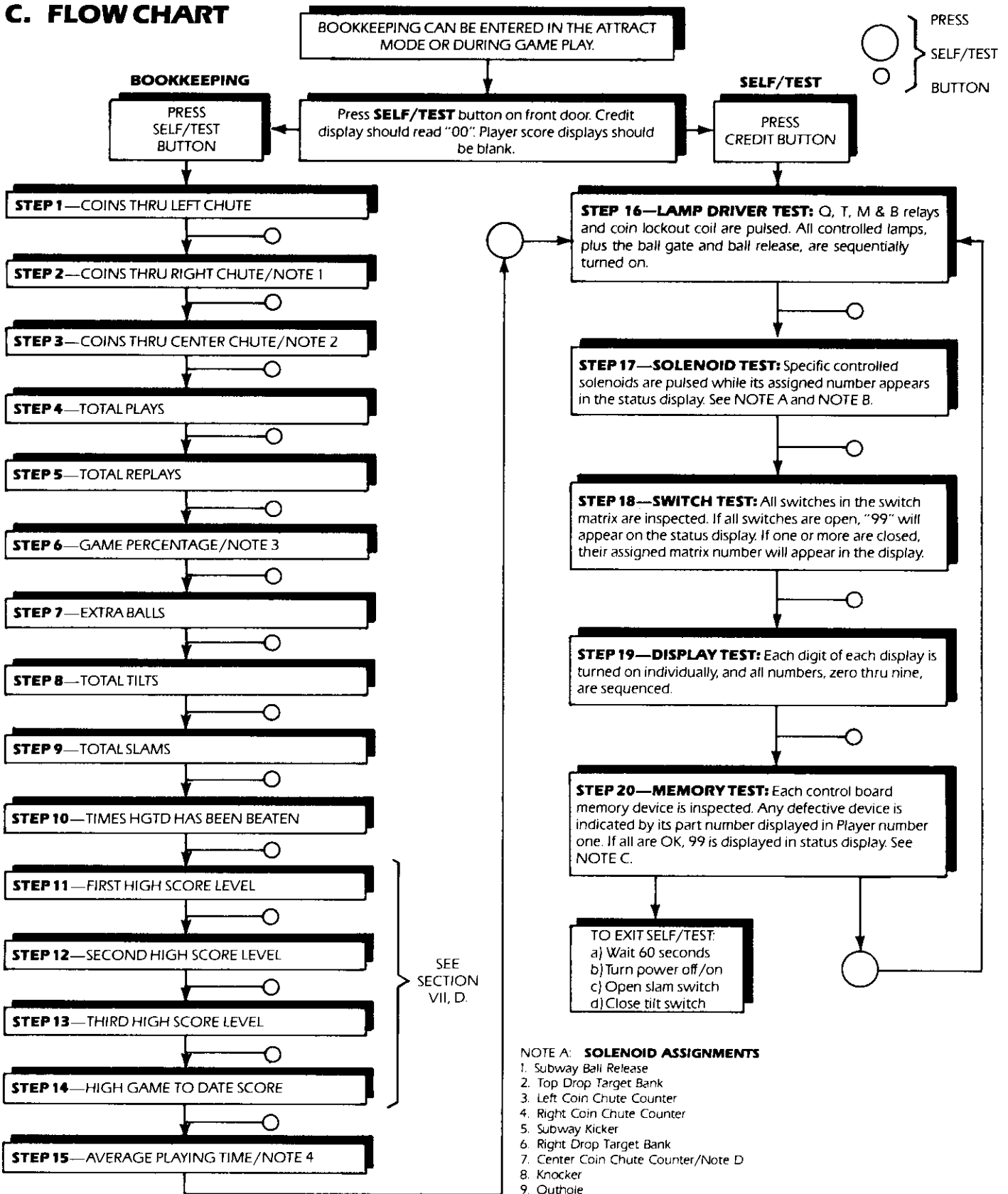

1. If control board switch #14 is on, Steps 01 and 02 are added together and displayed in Step 01.
2. IN GERMAN GAMES ONLY, Step 02 displays total coins thru center chute, and Step 03 displays total coins thru right chute.
3. If Step 06 is reset, Steps 04 and 05 must also be reset.
4. If Step 15 is reset, Step 04 must also be reset.

### NOTE A: SOLENOID ASSIGNMENTS

1. Subway Ball Release
2. Top Drop Target Bank
3. Left Coin Chute Counter
4. Right Coin Chute Counter
5. Subway Kicker
6. Right Drop Target Bank
7. Center Coin Chute Counter/Note D
8. Knocker
9. Outhole

NOTE B: Mechanical coin counters are optional and are not pulsed during solenoid test.

NOTE C: James Bond and later System 80 games will display 7641-1 for a bad 2716 game prom.

NOTE D: FOR GERMAN GAMES ONLY, solenoid #4 is assigned to center coin chute and solenoid #7 is assigned to right coin chute

## VII. BOOKKEEPING AND SELF TEST

### D. HOW TO RESET HIGH SCORE LEVELS OR HIGH GAME TO DATE SCORES

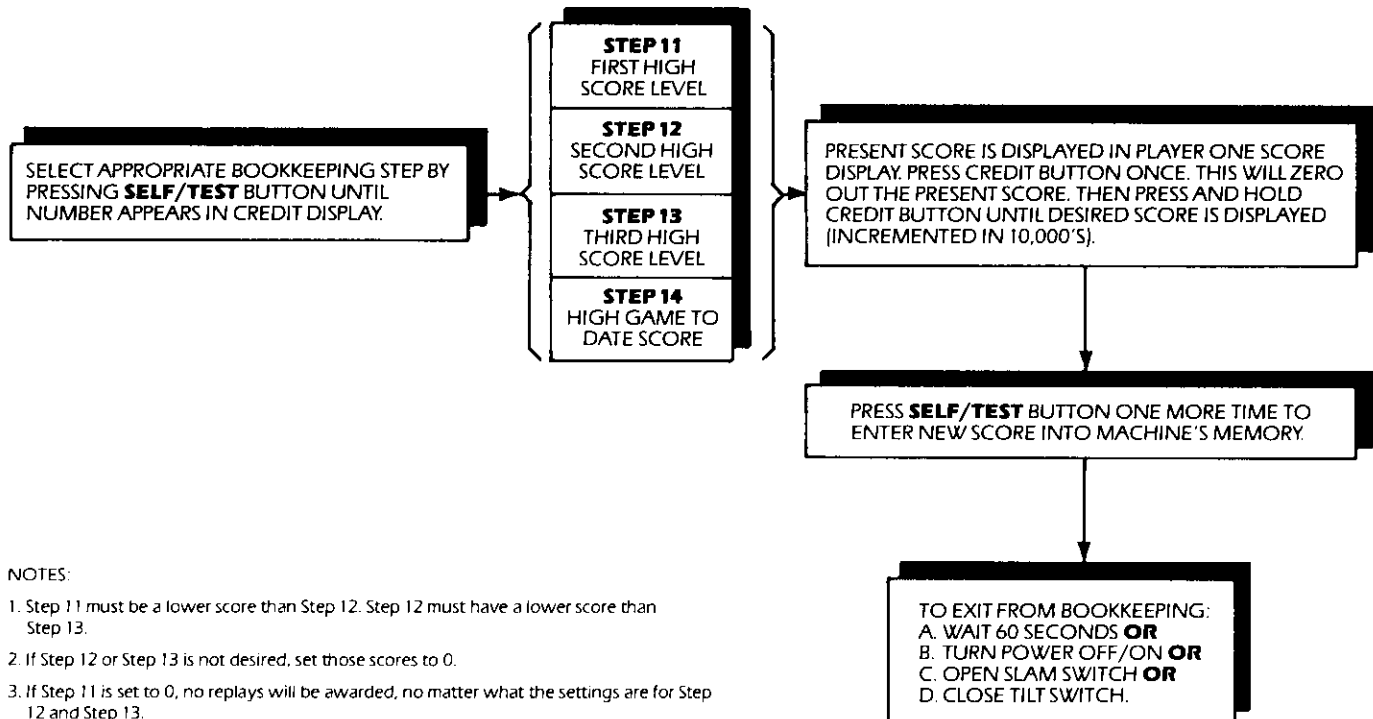

## VIII. OPTIONS

### A. ELECTRO-MECHANICAL COIN COUNTERS

Electro-mechanical coin counters may be installed on the bottom board, directly behind the 7-position fuse block. Solder lugs are provided which will connect the counters to the electronic circuitry.

1. Position the counter and secure it to the bottom board. Mounting holes are spotted for most standard 24 volt counters.

2. **CAUTION:** A 1N4004 diode must be connected across each counter with the cathode lead connected to the solder lug with the RED-BLACK-BLACK wire.
3. Connect one counter lead to each of the two solder lugs provided for each counter.
4. The counter should increment once when the respective coin chute switch is closed.

## IX. GENERAL INFORMATION

### A. PRINTED CIRCUIT BOARDS ARE DESIGNATED AS FOLLOWS:

- A1 — Control Board
- A2 — Power Supply
- A3 — Driver Board
- A4 — Score Displays (4)
- A5 — Status Display
- A6 — Sound/Speech Board
- A8 — Pop Bumper Driver Boards (4)
- A11 — Auxiliary Lamp Driver Board—  
Lightbox

Printed circuit board connectors will be labeled AX-JX. For example, A3-J4 is the connector J4 on the driver board (A3).

### B. WIRE COLORS ARE SHOWN AS NUMBERS:

0 Black	5 Green
1 Brown	6 Blue
2 Red	7 Purple
3 Orange	8 Slate
4 Yellow	9 White

For example, 688 is a BLUE-SLATE-SLATE striped wire.

### C. FUSES

#### BOTTOM BOARD

- |    |                        |                 |
|----|------------------------|-----------------|
| F1 | Lightbox Illumination  | 8 Amp SLO-BLO   |
| F2 | Playboard Illumination | 8 Amp SLO-BLO   |
| F3 | Controlled Lamps       | 7-1/2 Amp       |
| F4 | Sound Board            | 2 Amp SLO-BLO   |
| F5 | Power Supply           | 5 Amp SLO-BLO   |
| F6 | Solenoids              | 8 Amp SLO-BLO   |
| F7 | Displays               | 1/4 Amp SLO-BLO |
| F8 | Primary Fuse 110 VAC   | 5 Amp SLO-BLO   |
|    | Primary Fuse 220 VAC   | 2.5 Amp SLO-BLO |

#### SOUND/SPEECH POWER SUPPLY

- |    |               |               |
|----|---------------|---------------|
| F9 | Sound, Speech | 1 Amp SLO-BLO |
|----|---------------|---------------|

#### PLAYBOARD

- |     |   |                 |
|-----|---|-----------------|
| F10 | Center Pop Bumper                               | 2.5 Amp Slo/Blo |
| F11 | Left Top Pop Bumper                             | 2.5 Amp Slo/Blo |
| F12 | Right Bottom Pop Bumper                         | 2.5 Amp Slo/Blo |
| F13 | Left Bottom Pop Bumper                          | 2.5 Amp Slo/Blo |
| F14 | Outhole, Subway Ball Release.                   | 2 Amp Slo/Blo   |
| F15 | Top and Right Drop Target Banks, Subway Kicker. | 2.5 Amp Slo/Blo |
| F16 | Fire Pit  | 5 Amp Slo/Blo   |
| F17 | Hole Kicker and Ball Release                    | 2.5 Amp Slo/Blo |

## IX. GENERAL INFORMATION

### D. COIL CHART

#### SOLENOID COILS

PART NUMBER	GENERAL USAGE*	RESISTANCE (ohms)	NUMBER OF TURNS	WIRE GAUGE	WRAPPER COLOR
A-1496	KICKING RUBBERS POP BUMPERS	2.95	635	#23	Yellow
A-4893	POP BUMPERS BALL KICKER	2.1	535	#22	Red
A-5194	GONG	4.5	780	#24	Blue
A-5195	KNOCKER, HOLE KICKER	12.3	1305	#26	White
A-16570	HOLE KICKER, OUTHOLE	15.5	1450	#27	Green
A-17875	FLIPPERS	2.8/40.0	560/1100	#24/31	Yellow
A-17891	5 BANK RESET	3.35	850	#22	White
A-18102	3 BANK RESET, 7 BANK RESET USES 2	9.0	1430	#24	Red
A-18318	4 BANK RESET	6.7	1130	#24	Orange
A-19300	BALL KICKER	7.8	1075	#25	Orange
A-20095	SUPER FLIPPER	1.55/35.5	450/900	#22/31	Red
<b>RELAY COILS</b>					
A-16890	O, T, AND COIN LOCKOUT RELAYS	231.0	4000	#35	Orange
A-17564 A-20558	GATE RELAY	156.0	3400	#34	White
A-18642	MEMORY/ DROP TARGETS	58.0	1590	#33	White

\*Coils may vary from game to game. Check game manual for exact coil usage.

# IX. GENERAL INFORMATION

## E. SOUND/SPEECH BOARD (A6) TEST

1. Game must be in game over mode to initiate test.
2. Pressing the test button on the sound board will initiate the test.
3. The test must be completed to enable the sound board or game power must be turned off/on.
4. Words in bold print with quotation marks are the voice responses the sound board issues at specific points in the test.

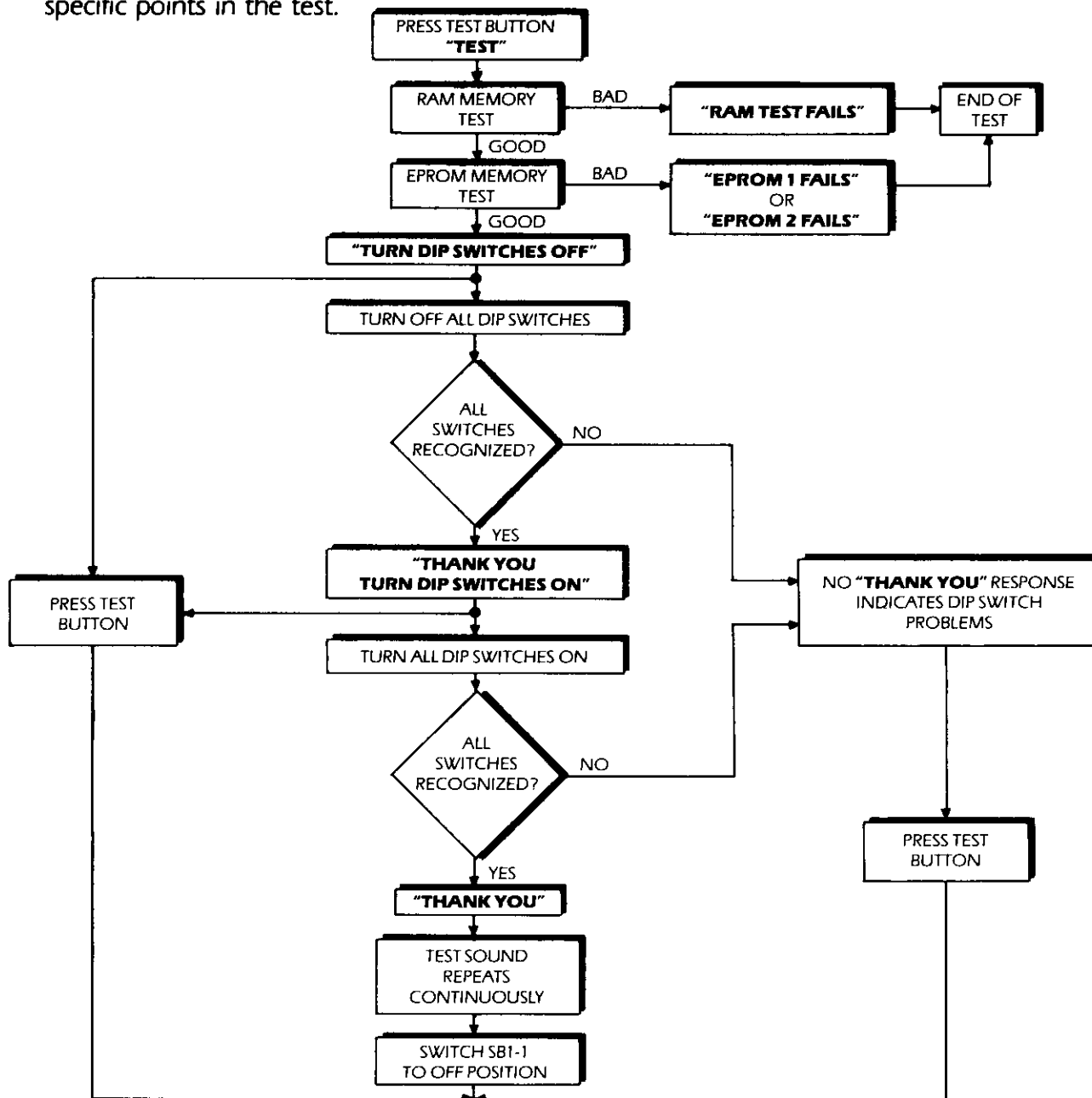

**SOUND ENABLE TEST**  
 JUMPER, ONE AT A TIME, THE FOLLOWING SOUND ENABLE INPUTS (AT THE A6-J1 CONNECTOR) TO GROUND.  
 A6J1-8 Sound 1 —Response "1"  
 A6J1-9 Sound 2 —Response "2"  
 A6J1-11 Sound 4 —Response "4"  
 A6J1-12 Sound 8 —Response "8"  
 A6J1-2 Sound 16—Response "16"  
 IF BAD AT ANY INPUT, ONE WILL HEAR "FAILS"; OR NO VOICE, INDICATING THE ENABLING SIGNAL IS NOT BEING RECOGNIZED AT ALL.

**WARNING!**  
 A6J1-10 IS +30V DC  
 DO NOT JUMPER.

NOTE: SBI-2 AND SBI-8 ARE NOT INVOLVED IN DIP SWITCH TESTS.

PRESS TEST BUTTON  
**"TEST COMPLETE"**

# X. WIRING AND SCHEMATIC DIAGRAMS, PARTS LISTS

## TABLE OF CONTENTS

	PAGE
<b>CONTROL BOARD (A1)</b>	
<b>COMPONENT LOCATION AND PARTS LIST</b> .....	16
<b>SCHEMATIC DIAGRAM</b> .....	17
<b>DRIVER BOARD (A3)</b>	
<b>COMPONENT LOCATION AND PARTS LIST</b> .....	20
<b>SCHEMATIC DIAGRAM</b> .....	21
<b>SPEECH/SOUND BOARD (A6)</b>	
<b>COMPONENT LOCATION AND PARTS LIST</b> .....	23
<b>SCHEMATIC DIAGRAM</b> .....	24
<b>AUXILIARY LAMP DRIVER BOARD (A11)</b>	
<b>COMPONENT LOCATION AND PARTS LIST</b> .....	26
<b>SCHEMATIC DIAGRAM</b> .....	26
<b>LIGHT BOX WIRING</b> .....	27
<b>6-DIGIT DISPLAY (A4)</b>	
<b>COMPONENT LOCATION AND PARTS LIST</b> .....	29
<b>SCHEMATIC DIAGRAM</b> .....	29
<b>4-DIGIT DISPLAY (A5)</b>	
<b>COMPONENT LOCATION AND PARTS LIST</b> .....	30
<b>SCHEMATIC DIAGRAM</b> .....	30
<b>PLAYBOARD</b>	
<b>PLAYBOARD INFORMATION</b> .....	31
<b>PLAYBOARD SWITCH AND LAMP ASSIGNMENTS</b> .....	32
<b>PLAYBOARD SWITCH MATRIX</b> .....	33
<b>PLAYBOARD ILLUMINATION AND SOLENOIDS</b> .....	34
<b>POP BUMPER DRIVER BOARD (A8)</b>	
<b>COMPONENT LOCATION AND PARTS LIST</b> .....	36
<b>SCHEMATIC DIAGRAM</b> .....	36
<b>SOUND/SPEECH BOARD (A6) POWER SUPPLY</b>	
<b>COMPONENT LOCATION AND PARTS LIST</b> .....	36
<b>SCHEMATIC DIAGRAM</b> .....	37
<b>BOTTOM BOARD AND CABINET SCHEMATIC</b> .....	37
<b>POWER SUPPLY (A2)</b>	
<b>COMPONENT LOCATION AND PARTS LIST</b> .....	39
<b>SCHEMATIC DIAGRAM</b> .....	40



# X. WIRING AND SCHEMATIC DIAGRAMS, PARTS LISTS

## CONTROL BOARD (A1) COMPONENT LOCATION

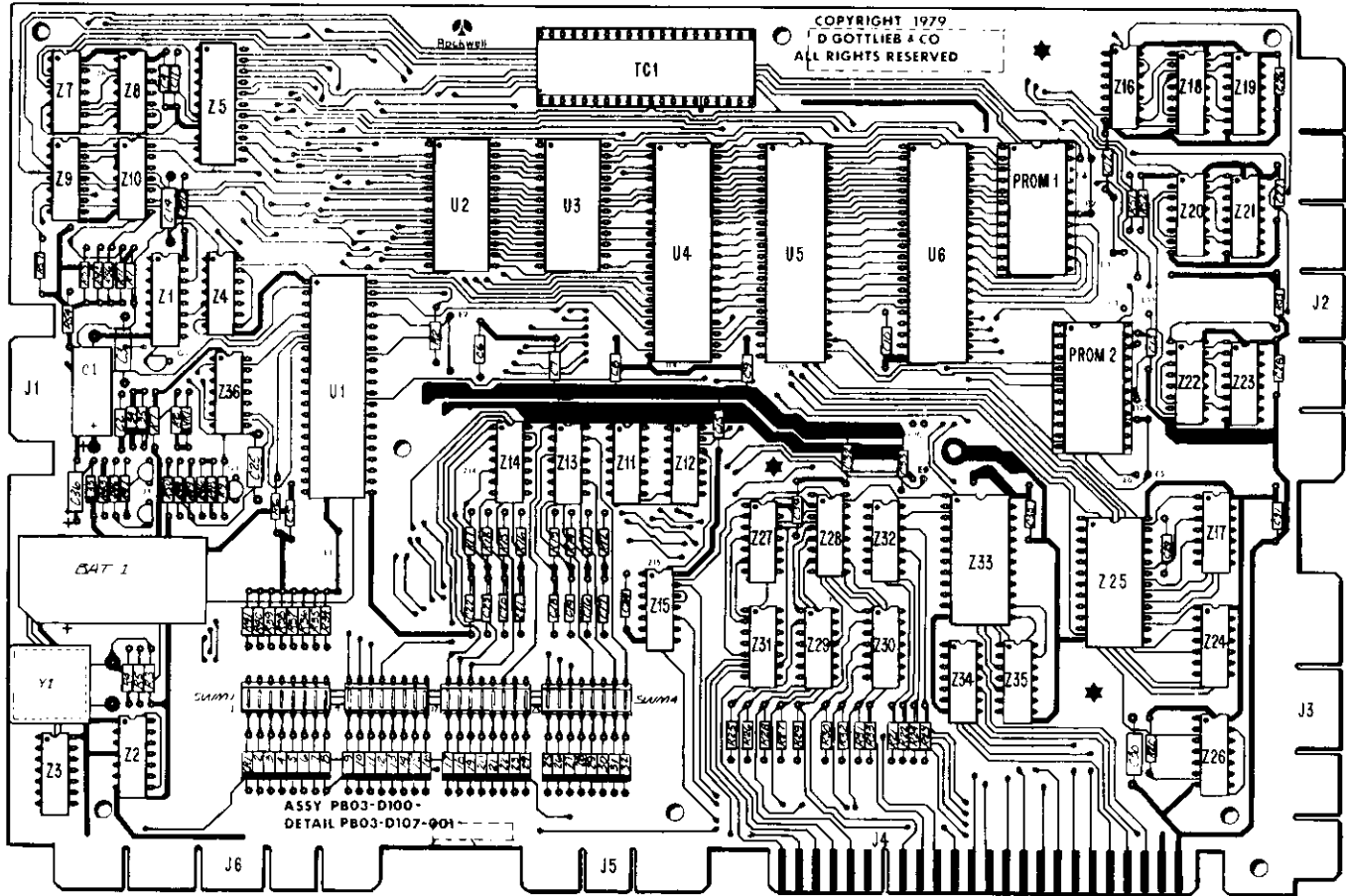

## CONTROL BOARD (A1) PARTS LIST

REFERENCE	DESCRIPTION	PART NUMBER	REFERENCE	DESCRIPTION	PART NUMBER
BAT.1	Battery—3.6V	326R10-002	U3	ROM	R3272-12
C1	Capacitor, 100 mfd., 10V		U4, U5, U6	RIOT	R6532-18
C2	Capacitor, .01 mfd., 50V		VR1	Zener Diode—3.0V, 5%	1N5225B or 1N5987B
C4-C13,			Y1	Crystal, 3.579545 MHZ	333R08-001
C15-C24,			Z1	IC-CMOS—Dual 1 Shot	SCL4528B
C26-C29,			Z2	IC—Dual Flip Flop	SN7474N
C31-C35			Z3, Z11,	IC—Hex Inverter	SN7404N
C3, C14,	Capacitor, .1 mfd., 50V		Z12, Z16,		
C25, C30			Z17, Z24,		
CR1-CR35	Diode, GP	1N4148	Z26, Z27,		
O1, O4	Transistor—PNP	MPS-A70	Z34, Z35		
Q2, Q3	Transistor, NPN (Motorola)	2N440	Z4	IC-CMOS—Quad 2 Input "AND"	SCL4081B
R1, R6,	Resistor, 3.0K ohm, 5%, 1/4W		Z5	IC-RAN/CMOS	P5101-L
R11-R24,			Z7	IC—Hex Inverter	SN74LS04N
R42, R45,			Z8	IC—2 Input "NOR"	SX7402N
R46, R48,			Z9, Z13,	IC—2 Input "NAND"	SN7400N
R51-R57			Z14		
R2	Resistor, 4.7K ohm, 5%, 1/4W		Z10	IC—Open Collector Inverter	SN74LS05N
R34-R41			Z15	IC—2 Input—"OR"	SN7432N
R3, R43,	Resistor, 5.6K ohm, 5%, 1/4W		Z18, Z20	IC—"D" Flip Flop	SN74175N
R49			Z22		
R4, R5,	Resistor, 2.0K ohm, 5%, 1/4W		Z19, Z21,	IC—4 to 7 Decoder	SN7448N
R44			Z23		
R7	Resistor, 62 ohm, 5%, 1/4W		Z25, Z33	IC—4 to 16 Decoder	SN74154N
R8, R50	Resistor, 180 ohm, 5%, 1/4W		Z28	IC—2-to-4 Decoder	SN74LS139N
R9	Resistor, 1K ohm, 5%, 1/4W		Z29, Z30	IC—Hex Inverter—OC/HV	SN7416N
R10	Resistor, 2.8M ohm, 5%, 1/4W		Z31	IC—2 Input "AND"	SN7408N
R25-R33	Resistor, 620 ohm, 5%, 1/4W		Z32	IC—Hex Buffer—OC	SN7417N
R47	Resistor, 24K ohm, 5%, 1/4W		Z36	IC—CMOS	MM74C04 or
SW1-SW4	Dip Switch Pak—8 Position	341R31-005		Socket—DIL, 24 PIN	SCL4069B
TC1	Socket, 40 Pin	640379-3		Spacer, Cork	640361-3
U1	CPU	R6502-13			131R06-001
U2	ROM	R3273-12			

NOTE: UNLESS OTHERWISE INDICATED;  
 1. RESISTORS ARE  $\pm 5\%$ , 1/4W.  
 2. CAPACITORS ARE .01UF, 50V.  
 3. DIODES ARE TYPE IN4148.  
 4. REF. DESIGNATION Z6 NOT USED.

Spare Gates

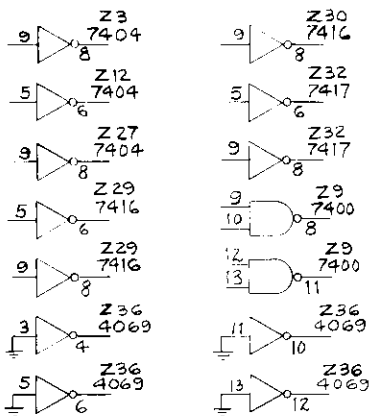

Clock Logic

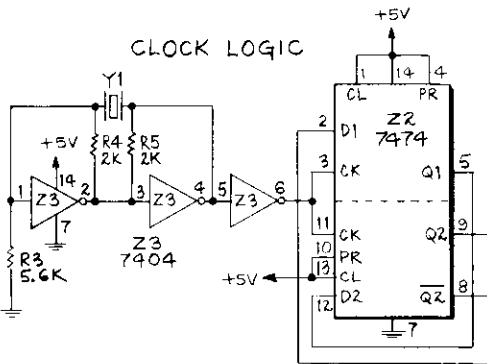

Delay Circuit

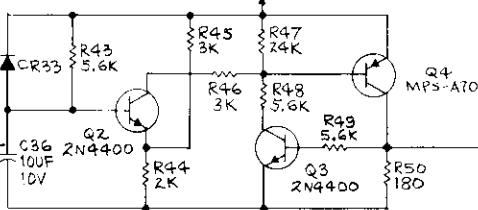

UP/DOWN MEMORY PROTECT LOGIC

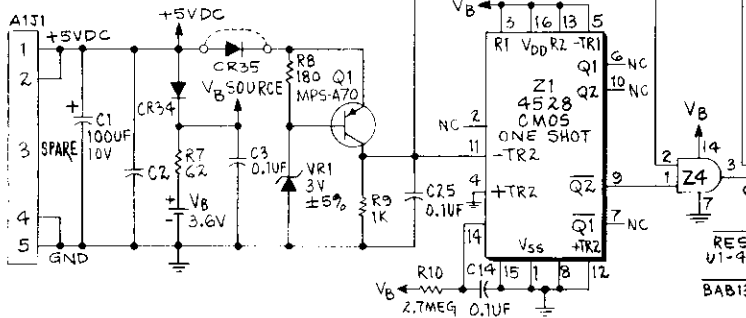

INPUT/OUTPUT DEVICE SELECTION

