

FIRST PRINTING OCTOBER 1996

SEGA™

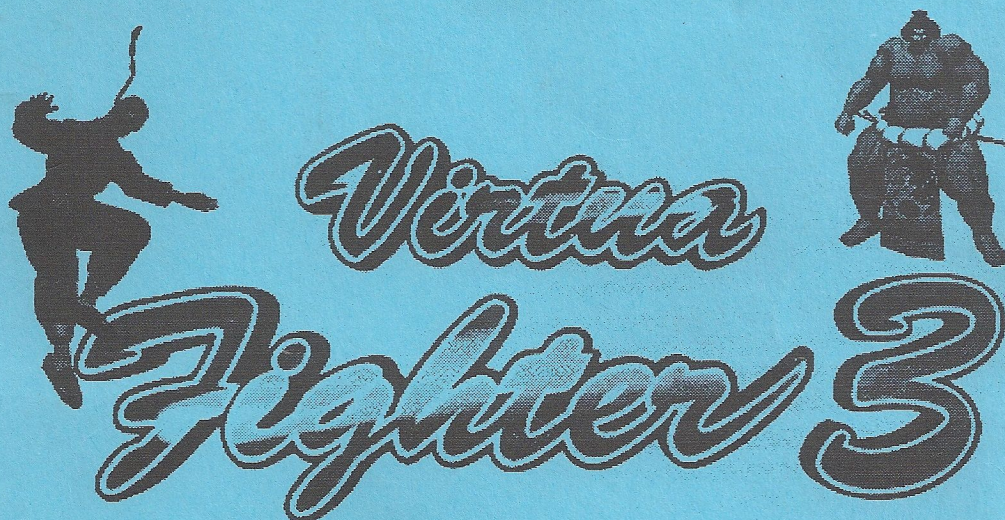

DELUXE

SERVICE MANUAL

MANUAL NO. 4201-6221-01

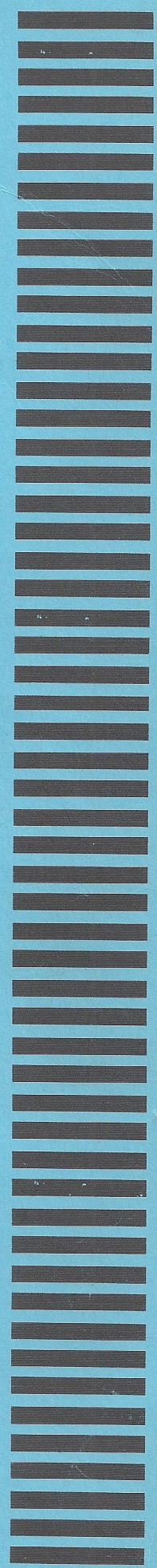



COPYRIGHT NOTICE

This SEGA product has a copyright notice as follows:

© 1996 Sega Enterprises, Inc. (USA) All rights reserved.

This signifies that this work was disclosed in 1996 and is the property of SEGA ENTERPRISES, INC. (USA).

Every effort has been made to ensure that this manual is accurate. Sega Enterprises, Inc. (USA) is not liable for any printing or clerical errors.

Specifications noted herein are subject to change without notice.

Contents

INTRODUCTION TO THE OWNER'S MANUAL	3
GAME REGISTRATION	4
GENERAL PRECAUTIONS	5
INSTALLATION LOCATION PRECAUTIONS	6
SAFETY AND REGULATORY INFORMATION	6
SPECIFICATIONS	7
INSTALLATION ITEMS	8
ASSEMBLING THE MACHINE	9
ASSEMBLING THE PTV	10
CONNECT THE CABINETS	12
LEG ADJUSTERS	14
ASSEMBLY CHECKS	15
EXPLANATION OF TEST AND DATA DISPLAYS	16
TEST MODE	18
MEMORY TEST	19
INPUT TEST	20
BOUNDARY SCAN	21
OUTPUT TEST	22
SOUND TEST	22
CRT TEST	23
TIMER	24
BATTERY CHECK	25
RTC	25
GAME ASSIGNMENTS	26
COIN ASSIGNMENT	28
COIN CREDITS	29
MANUAL SETTINGS	30
BOOKKEEPING	31
GLOBAL DATA	33
BACK UP DATA CLEAR	38
SERVICE INFORMATION	
COIN SELECTOR	45
PTV CARE AND ADJUSTMENT	46
STATIC CONVERGENCE ADJUSTMENT	47
REMOTE CONTROL	48
FLUORESCENT LAMP	39
TROUBLESHOOTING	40
GAME BOARD	42
GAME BOARD SERVICE RECORD	44
DESIGN RELATED PARTS	49
PARTS IDENTIFICATION	50
MANUAL COMMENTS	53
WIRING DIAGRAM	54

INTRODUCTION OF THE OWNERS MANUAL

SEGA ENTERPRISES, LTD., has for more than 30 years been supplying various innovative and popular amusement products to the world market. This Owners Manual is intended to provide detailed descriptions together with all the necessary installation, game settings and parts ordering information related to *Virtua Fighter 3 DELUXE*, a new SEGA product.

This manual is intended for those who have knowledge of electricity and technical expertise, especially in ICs, CRTs, microprocessors, and circuit boards. Read this manual carefully to acquire sufficient knowledge before working on the machine. Should there be a malfunction, non-technical personnel should under no circumstances touch the interior system. Should the need arise, contact our main office, or the closest branch office listed below.

SEGA ENTERPRISES, INC. (USA)
Customer Service
45133 Industrial Drive
Fremont, CA 94538
Phone 415-802-1750
Fax 415-802-1754
7:30 am - 4:00 pm, Pacific Standard Time
Monday thru Friday

General Precautions

Follow Instructions: All operating and use instructions should be followed.

Attachments: Do not use attachments not recommended by the product manufacturer as they may cause hazards.

Accessories: Do not place this product on an unstable cart, stand, tripod, bracket, or table. The product may fall, causing serious injury to a child or adult, and serious damage to the product. Use only with a cart, stand, tripod, bracket, or table recommended by the manufacturer, or sold with the product. Any mounting of the product should follow the manufacturer's instructions, and should use only mounting accessories recommended by the manufacturer.

Moving the Product: This product should be moved with care. Quick stops, excessive force, and uneven surfaces may cause the product to overturn.

Ventilation: Slots and openings in the cabinet are provided for ventilation, to ensure reliable operation of the product and to protect it from overheating; these openings must not be blocked or covered. The openings should never be blocked by placing the product in a built-in installation such as a bookcase or rack unless proper ventilation is provided or the manufacturer's instructions have been adhered to.

Power Sources: This product should be operated only from the type of power source indicated on the marking label. If you are not sure of the type of power supply to your location, consult your local power company. For products intended to operate from battery power or other sources, refer to the operating instructions.

Grounding or Polarization: This product is equipped with a three-wire grounding-type plug, a plug having a third (grounding) pin. This plug will only fit into a grounding-type power outlet. This is a safety feature. If you are unable to insert the plug into the outlet, contact your electrician to replace your obsolete outlet. Do not defeat the safety purpose of the grounding-type plug.

Power Cord Protection: Power-supply cords should be routed so that they are not likely to be walked on or pinched by items placed upon or against them, paying particular attention to cords at plugs, convenience receptacles, and the point where they exit from the product.

Overloading: Do not overload wall outlets, extension cords, or integral convenience receptacles as this can result in a risk of fire or electric shock.

Object and Liquid Entry: Never push objects of any kind into this product through openings as they may touch dangerous voltage points or short-out parts that could result in a fire or electric shock. Never spill liquid of any kind on the product.

Servicing: Do not attempt to service this product yourself as opening or removing covers may expose you to dangerous voltage or other hazards. Refer all servicing to qualified service personnel.

Damage Requiring Service: Unplug this product from the wall outlet and refer servicing to qualified service personnel under the following conditions:

- a) If the power cord or plug is damaged;
- b) If liquid has been spilled, or objects have fallen into the product;
- c) If the product has been exposed to rain or water;
- d) If the product does not operate normally when following the operating instructions. Adjust only those controls that are explained in the operating instructions. An improper adjustment of other controls may result in damage and will often require extensive work by a qualified technician to restore the product to its normal operation;
- e) If the product has been dropped or damaged in any way;
- f) When the product exhibits a distinct change in performance; this indicates a need for service.

Replacement Parts: When replacement parts are required, be sure the service technician has used replacement parts specified by the manufacturer or that have the same characteristics as the original part. Unauthorized substitutions may result in fire, electric shock, or other hazards.

Safety Check: Upon completion of any service or repairs to this product, ask the service technician to perform safety checks to determine that the product is in proper operating condition.

Heat: The product should be situated away from heat sources such as radiators, heat registers, stoves, or other products (including amplifiers) that produce heat.

Lithium Battery- Dispose of batteries only in accordance with the battery manufacturer's recommendations. Do not dispose in an open flame condition, since the battery may explode.

Cleaning: When cleaning the monitor glass, use water or glass cleaner and a soft cloth. Do not apply chemicals such as benzine, thinner, etc.

Location: This an indoor game machine, DO NOT install it outside. To ensure proper usage, avoid installing indoors in the places mentioned below:

- Places subject to rain/water leakage, or condensation due to humidity;
- In close proximity to a potential wet area;
- Locations receiving direct sunlight;
- Places close to heating units or hot air;
- In the vicinity of highly inflammable/volatile chemicals or hazardous matter;
- On sloped surfaces;
- In the vicinity of emergency response facilities such as fire exits and fire extinguishers;
- Places subject to any type of violent impact;
- Dusty places.

INSTALLATION PRECAUTIONS

- Verify the amperage of the branch circuit outlet before plugging in the power plug. Do not overload the circuit.
- Avoid using an extension cord. If one is required, use an extension cord of type SJT, 16/3 AWG rated min. 120 VAC, 7A.
- Moving this unit requires a minimum clearance (of doors, etc.) of 32" (W) by 77" (H).
- For the operation of this machine, secure a minimum area of 32" (W) by 42"(D).

REGULATORY APPROVALS

This game has been tested and found to comply with the Federal Communications Commission Rules.

This device complies with Part 15 of the FCC Rules. Operation is subject to the following two conditions: (1) This device may not cause harmful interference, and (2) this device must accept any interference received, including interference that may cause undesired operation.

This game has been tested and listed by Underwriters Laboratories, Inc., to ANSI/UL22.



AMUSEMENT MACHINE

SPECIFICATIONS

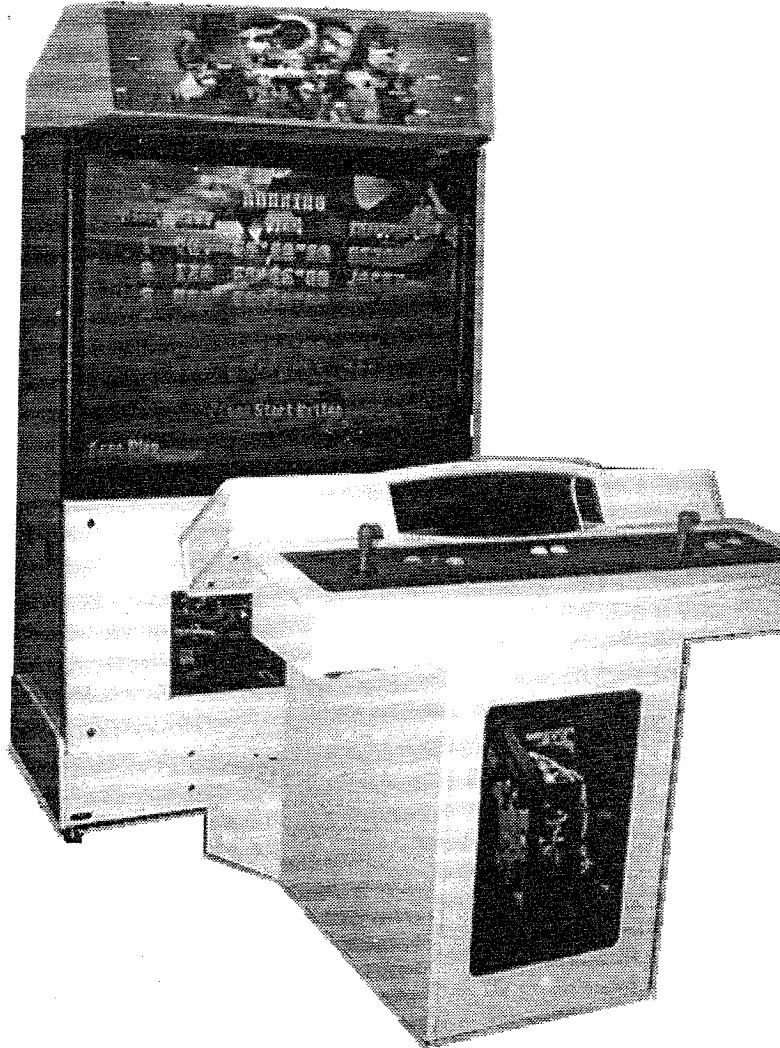

Virtua Fighter 3 50" Deluxe

Height	90 inches
Depth	65 inches
Width	45 inches

Monitor	50"
Amperage	7A FB

INSTALLATION ITEMS

The following items are supplied with the machine. Be sure that these items remain with the game if it is transported or sold.

- 1 Service Manual, *Virtua Fighter 3*
- 1 Tamperproof wrench, M5
- 1 Remote Controller, Mitsubishi Projection TV
- 1 Model 3 PCB warranty shipping carton

NOTICE:

Do not remove the game board from the shield case at any time.
Doing so may void your warranty.
If you have any questions, contact the Sega Technical Services
Department immediately.

① ON-SCREEN DISPLAY

Monitor Position

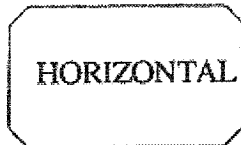

Synchronous Frequency
24.39 kHz

② CONTROL PANEL

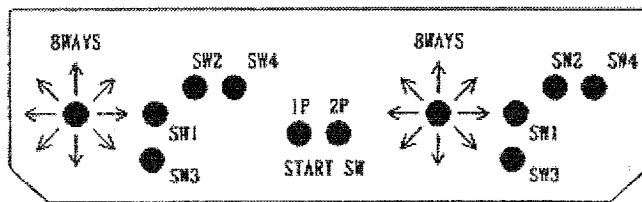

PLAYER 1

PLAYER 2

SW1: PUNCH
SW2: KICK
SW3: GUARD
SW4: DODGE

ASSEMBLY AND PRECAUTIONS

- Perform the assembly work by following the procedure stated herein. Failing to comply with the instructions can cause an injury or electrical shock.
- Assembly should be performed as per the instructions in this manual. This is a complex machine and erroneous assembly can cause electrical shock or damage to the machine resulting in undesired operation.
- When assembling the machine, be sure that more than one person is available to perform the work. Depending on the assembly work, there are some cases in which performing the work alone can cause personal injury or damage the game.

When carrying out the assembly work, follow the procedure in the following sequence:

- 1 Assembling the Projection Television Monitor (PTV)
- 2 Assembling the cabinet
- 3 Securing in place (leg adjusters)
- 4 Power supply
- 5 Assembly check

ASSEMBLING THE PTV

The Projection Television monitor (PTV) unit for this game is shipped assembled. However, refer to these directions if you should need to disassemble the PTV unit for maintenance.



WARNING!

When performing work on the PTV unit, be sure that two or more persons are available to do the work.

When mounting the PTV on the PTV base, be sure that the work is performed by 4 or more persons. Executing the work by less than 4 persons can cause severe injury.



CAUTION!

To perform the work safely, be sure to prepare a step or ladder which is secure and stable. Using an unstable step can cause both personal injury and damage to the product.

By using the specified screws, secure the 2 mask holders to the projection display ceiling.

Insert the TV mask from the underside as shown, and secure with 6 screws.

Secure panel mount bracket L and R to the front of the projection display in the installation direction shown with 2 screws for each.

Secure the front panel to both panel mount brackets with a total of 4 screws. At this time, ensure that the upper 2 screws used are black and the 2 lower ones are chromeplated.

Insert the billboard connector into the terminal board of the projection display ceiling.

Insert the billboard from the front as shown and secure with 2 screws.

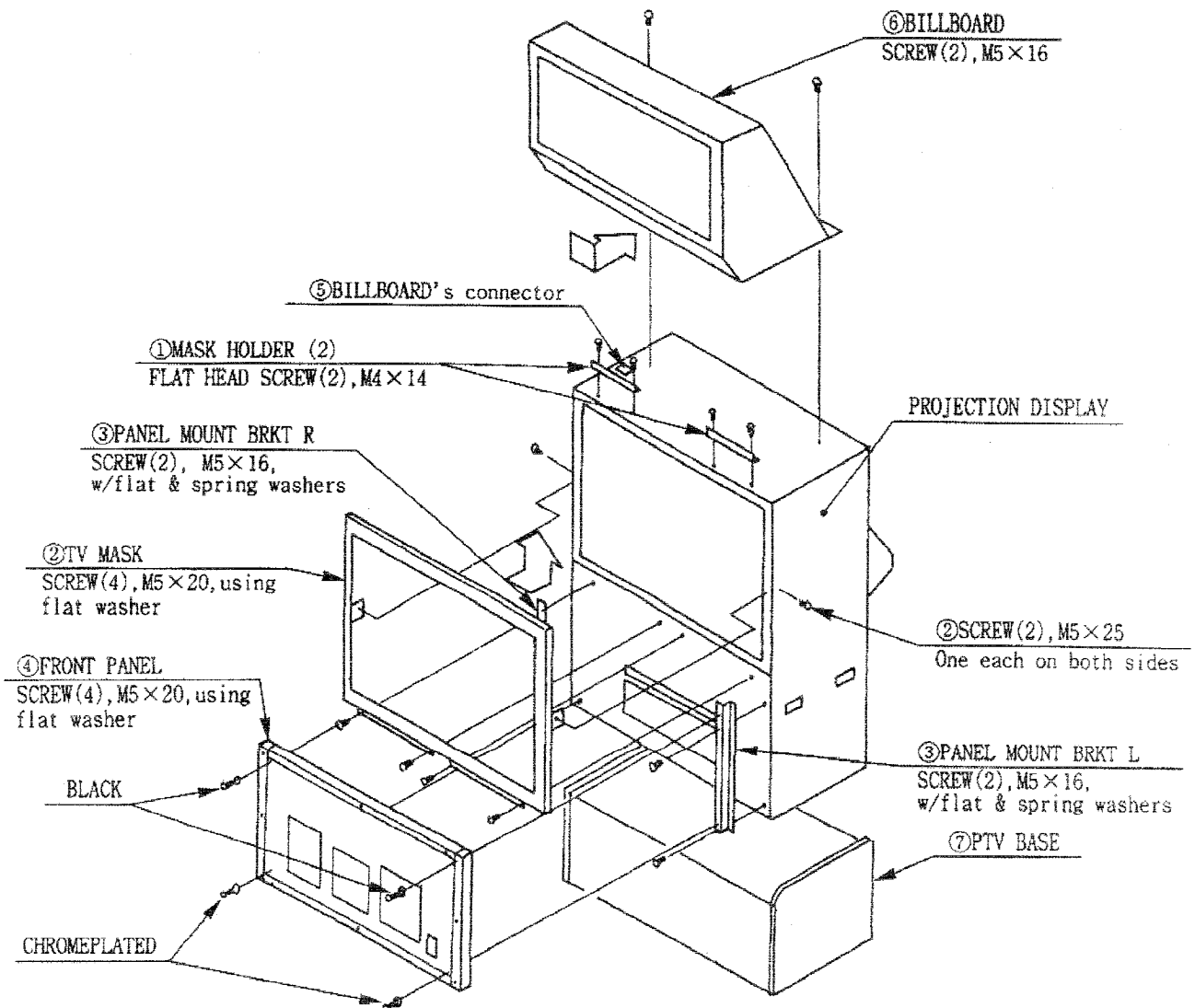

Mount the assembled PTV on the PTV base. After mounting the PTV, move it to the rear of the PTV base.

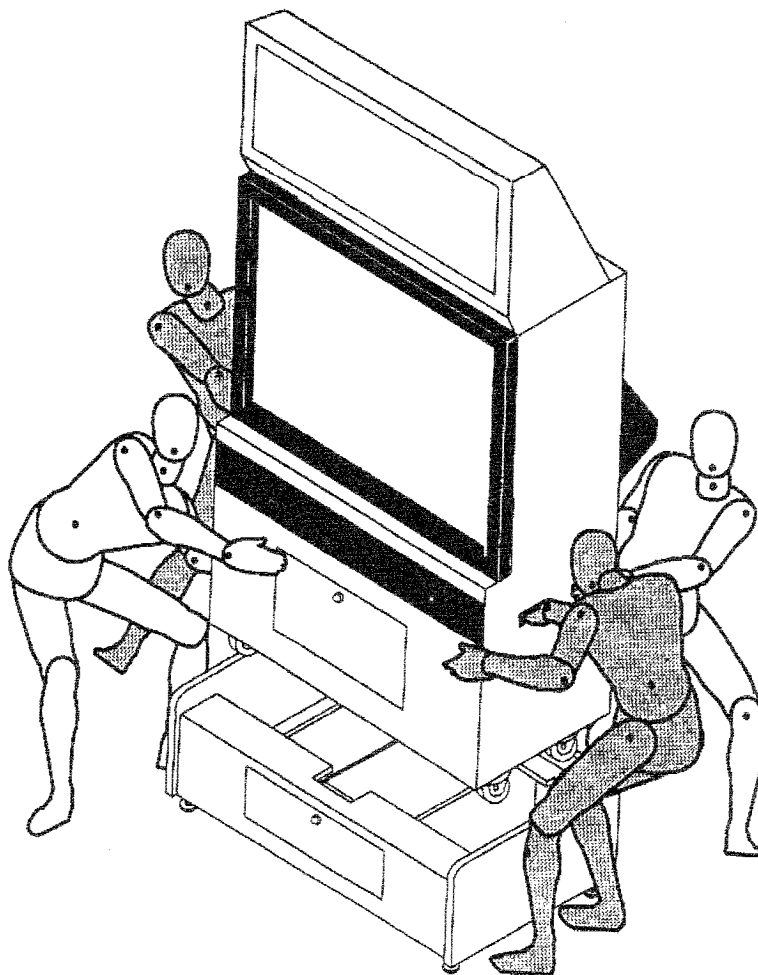

Be careful so as not to damage wiring. Damaged wiring can cause an electric shock and short circuit.

Bring the PTV and Game Cabinet together, with a distance of 30 cm between them.

Remove the two tamperproof screws on the right side door of the game cabinet, unlock the door and remove.

Remove the two side access panels. (Refer to photo)

Use the hex bolts and washers supplied to secure the game cabinet to the PTV in 4 places.

There are 4 BNC video cables that need to be connected from the VPM buffer board in the game cabinet to the PTV. Observe that proper Red/Green/Blue/Sync connections are made for video.

The PTV has the main power wire that passes through the monitor pedestal to the game cabinet. Insert this 3 pin male connector into the proper connector on the inner wall.

The PTV power is brought from the game cabinet to the PTV by cable with a 3 pin white connector route this cable through the PTV and connect.

Recheck the connections to ensure that no wires are crossed or missing.

Replace side access panels on two sides and replace all hardware and the main side door to the game cabinet.

Plug game power cord into the wall.

Setup is complete if game is visible on the screen.

Perform assembly checks on page 15.

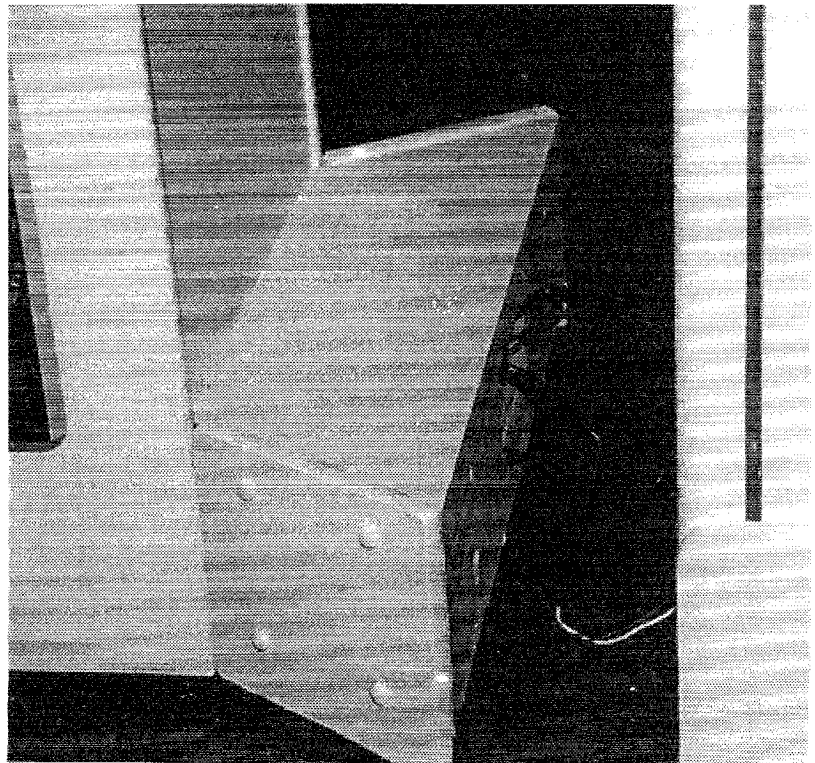



WARNING!

Make sure that all the leg adjusters are in contact with the floor. If they are not, the cabinet can move, causing an accident.

This machine has 8 casters and 6 leg adjusters. When the installation position has been determined, cause the leg adjusters to come into contact with the floor, and make adjustments so that the casters are raised approximately 5mm from the floor. Ensure that the machine is level.

Move the machine to the installation position.

Cause all of the leg adjusters to make contact with the floor. By using a wrench, make adjustments in the height of the leg adjusters to ensure that the machine is level.

After making adjustments, fasten the leg adjuster nut upwards to secure the height of the leg adjuster.

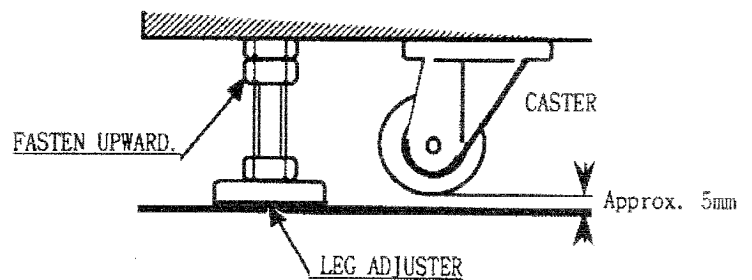

Assembly Checks

In the test mode, perform the following tests:

1. Memory Test

Selecting the Memory Test on the test mode menu screen causes the on-board memory to be tested automatically. The game board is satisfactory if the display beside each IC number shows GOOD.

CPU ROM TEST			
GOOD	(CROM01 BANK)	IC. 1	80h
GOOD	(CROM02 BANK)	IC. 2	80h
GOOD	(CROM03 BANK)	IC. 3	80h
GOOD	(CROM04 BANK)	IC. 4	80h
GOOD	(CROM11 BANK)	IC. 5	80h
GOOD	(CROM12 BANK)	IC. 6	80h
GOOD	(CROM11 BANK)	IC. 7	80h
GOOD	(CROM10 BANK)	IC. 8	80h
GOOD	(CROM23 BANK)	IC. 9	80h
GOOD	(CROM22 BANK)	IC. 10	80h
GOOD	(CROM21 BANK)	IC. 11	80h
GOOD	(CROM30 BANK)	IC. 12	80h
GOOD	(CROM33 BANK)	IC. 13	80h
GOOD	(CROM32 BANK)	IC. 14	80h
GOOD	(CROM31 BANK)	IC. 15	80h
GOOD	(CROM40 BANK)	IC. 16	80h
GOOD	(CROM43)	IC. 17	80h
GOOD	(CROM42)	IC. 18	80h
GOOD	(CROM41)	IC. 19	80h
GOOD	(CROM40)	IC. 20	80h

PRESS TEST BUTTON TO CONTINUE

2. Input Test

Selecting the Input Test on the test mode menu screen causes the screen (on which each switch is tested) to be displayed. Press each switch. For the coin switch test, insert a coin from the coin inlet with the coin chute door open. If the display beside each switch indicates ON, the switch and wiring connections are satisfactory.

INPUT TEST		
PLAYER	1P	2P
PUNCH :	OFF	OFF
KICK :	OFF	OFF
GUARD :	OFF	OFF
ESCAPE :	OFF	OFF
UP :	OFF	OFF
DOWN :	OFF	OFF
LEFT :	OFF	OFF
RIGHT :	OFF	OFF
START :	OFF	OFF
COIN CHUTE #1 :	OFF	
COIN CHUTE #2 :	OFF	
SERVICE :	OFF	
TEST :	OFF	
B SERVICE :	OFF	
B TEST :	OFF	

PRESS SERVICE+TEST BUTTON TO EXIT

3. Output Test

In the Output Test mode, carry out the lamp test to ascertain that each lamp lights up satisfactorily.

OUTPUT TEST	
1P SIGN CHECK	
2P SIGN CHECK	
CLEAR CHECK	
EXIT	

PRESS SERVICE BUTTON TO SELECT
PRESS TEST BUTTON TO EXEC

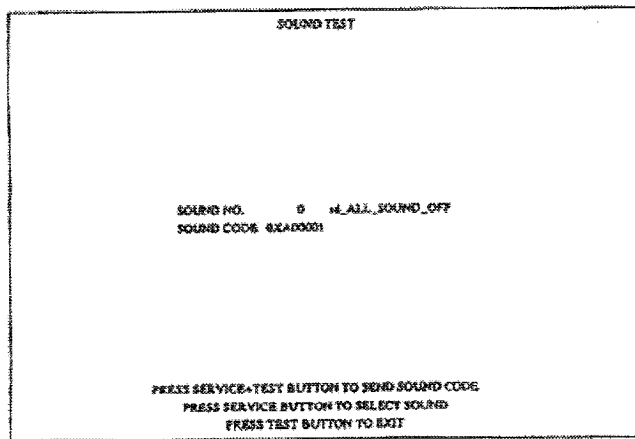

4. Sound Test

In the Test mode, selecting Sound Test causes the screen (on which sound-related board and wiring connections are tested) to be displayed.

Be sure to check if the sound is satisfactorily emitted from each speaker and the sound volume is appropriate.

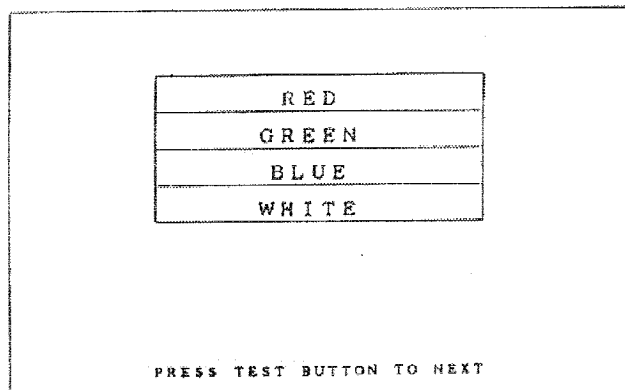

5. C.R.T. Test

In the Test mode menu, selecting C.R.T. Test allows the screen (on which the monitor is tested) to be displayed. Although the monitor adjustments have been made at the time of shipment from the factory, color deviation, etc. may occur due to the effect caused by geomagnetism, the location building's steel frames and other game machines on the periphery. By watching the test mode screen, decide whether an adjustment is needed. If it is necessary, adjust the monitor by referring to the Monitor Adjustments section.

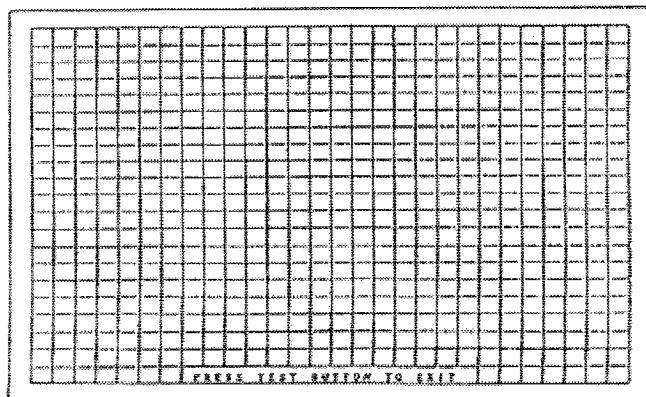



- ◆ When moving the machine, be sure to pull the plug out from the power supply. Moving the machine with the plug inserted can cause the power cord to be damaged, resulting in fire or electric shock.
- ◆ When moving the machine on the floor, retract the leg adjusters so that the casters come in contact with the floor. During transportation, pay careful attention that the casters do not tread over power cords or wires. Damaging the power cords can cause short circuit or electric shock.
- ◆ In places with steps or inclines, separate the PTV from the base and cabinet to move them. Attempting to move these parts together, or incline the PTV as it is attached to the base can cause the PTV to fall from the base.
- ◆ When moving the PTV, do not push it from the front or rear. Push from the side at all times. Pushing the PTV from the front or rear can cause it to overturn causing damage and serious personal injury. Due to the weight of the PTV cabinet, have two or more persons available at all times when attempting to move the PTV.



When lifting or inclining the cabinet, do not hold the controller portion. Holding the controller can cause the controller and installation portion to be damaged due to the empty weight.

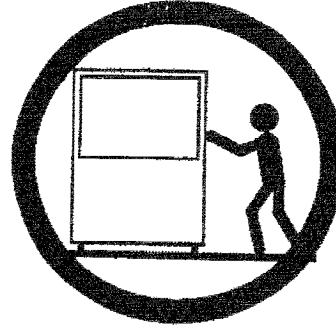

TEST MODE

This mode checks the operation of the game board for accuracy, makes monitor color adjustments, and allows for changes to the coin assignments and game assignments.

Selection of Test Items:

1. After turning power on, press the test button on the switch unit to cause the following test menu to appear.

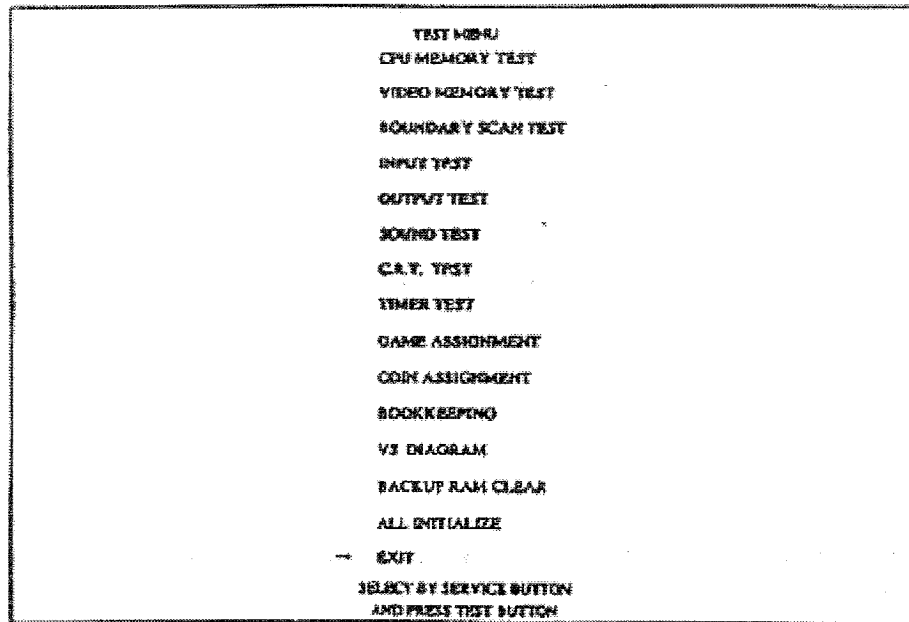

2. By pressing the service button, bring the arrow mark -> to the desired item and press the test button.
3. When tests have been completed, bring the arrow -> to Exit and press the test button. The game mode returns to the screen.

CPU MEMORY TESTS

Check the operation of CPU memory ICs on the IC board. If the IC is satisfactory, "Good" will be indicated. "Bad" will indicate any malfunctions.

CPU ROM TEST				
GOOD	(CROM03 BANK)	IC.	1	20b
GOOD	(CROM02 BANK)	IC.	2	20b
GOOD	(CROM01 BANK)	IC.	3	20b
GOOD	(CROM00 BANK)	IC.	4	20b
GOOD	(CROM13 BANK)	IC.	5	20b
GOOD	(CROM12 BANK)	IC.	6	20b
GOOD	(CROM11 BANK)	IC.	7	20b
GOOD	(CROM10 BANK)	IC.	8	20b
GOOD	(CROM23 BANK)	IC.	9	20b
GOOD	(CROM22 BANK)	IC.	10	20b
GOOD	(CROM21 BANK)	IC.	11	20b
GOOD	(CROM20 BANK)	IC.	12	20b
GOOD	(CROM33 BANK)	IC.	13	20b
GOOD	(CROM32 BANK)	IC.	14	20b
GOOD	(CROM31 BANK)	IC.	15	20b
GOOD	(CROM30 BANK)	IC.	16	20b
GOOD	(CROM3)	IC.	17	20b
GOOD	(CROM2)	IC.	18	20b
GOOD	(CROM1)	IC.	19	20b
GOOD	(CROM0)	IC.	20	20b

PRESS TEST BUTTON TO CONTINUE

The test starts immediately after the test item is selected from the test menu. During the test, the "testing now" message is displayed in the lower part of the screen. Press the test button to proceed to the RAM test.

CPU RAM TEST				
GOOD	(SDRAM)	IC.	13	IC. 15
GOOD	(BACKUP SRAM)	IC.	21	IC. 22
GOOD	(SCROLL \$DRAM)	IC.	04	IC. 19 IC. 20
GOOD	(SCROLL SRAM)	IC.	17	IC. 18

PRESS TEST BUTTON TO EXIT

This test starts immediately after proceeding from the CPU ROM test. During the test, the "testing now" message is indicated on the lower part of the screen. In case of an error, several error messages can be displayed. After the test has been completed, press the test button to have the menu mode return to the screen.

VIDEO MEMORY TEST

This allows the operation of the video memory ICs on the IC board to be tested. When the IC is in good operating condition, "Good" will be indicated. If any malfunction exists, "Bad" will be indicated.

VIDEO BOARD ROM TEST			
GOOD	(VROM01)	IC. 26	1acc
GOOD	(VROM02)	IC. 27	1acc
GOOD	(VROM03)	IC. 28	1acc
GOOD	(VROM04)	IC. 29	1acc
GOOD	(VROM05)	IC. 30	1acc
GOOD	(VROM06)	IC. 31	1acc
GOOD	(VROM07)	IC. 32	1acc
GOOD	(VROM08)	IC. 33	1acc
GOOD	(VROM09)	IC. 34	1acc
GOOD	(VROM10)	IC. 35	1acc
GOOD	(VROM11)	IC. 36	1acc
GOOD	(VROM12)	IC. 37	1acc
GOOD	(VROM13)	IC. 38	1acc
GOOD	(VROM14)	IC. 39	1acc
GOOD	(VROM15)	IC. 40	1acc
GOOD	(VROM16)	IC. 41	1acc

PRESS TEST BUTTON TO CONTINUE

This test starts immediately after the test item is selected from the test mode menu. During the test, "testing now" will be displayed in the lower part of the screen. Press the test button to proceed to the video RAM test.

VIDEO BOARD RAM TEST			
----------------------	--	--	--

PRESS TEST BUTTON TO EXIT

This test starts immediately after proceeding from the video board ROM test. During this test, "testing now" will be displayed in the lower part of the screen. If the test is satisfactory, nothing will be displayed. After the test has been completed, press the test button to have the menu mode return to the screen.

BOUNDARY SCAN TEST

If there exists any problem with the game hardware, error display will be indicated.

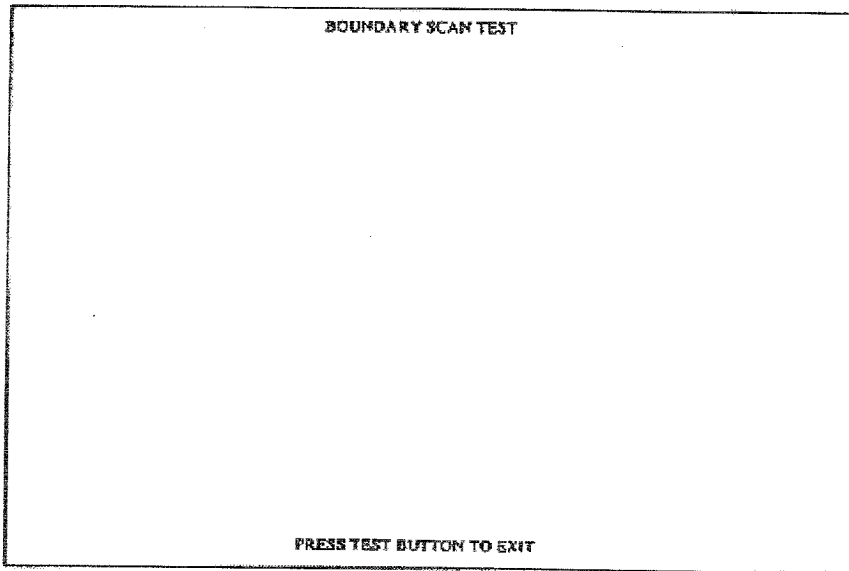

After the test has been completed, press the test button to have the menu mode return to the screen. When this test is performed, be sure to exit the test menu without entering another test item.

INPUT TEST

This test displays the state of each switch and button. If the switch or button goes ON when activated, it is satisfactory.

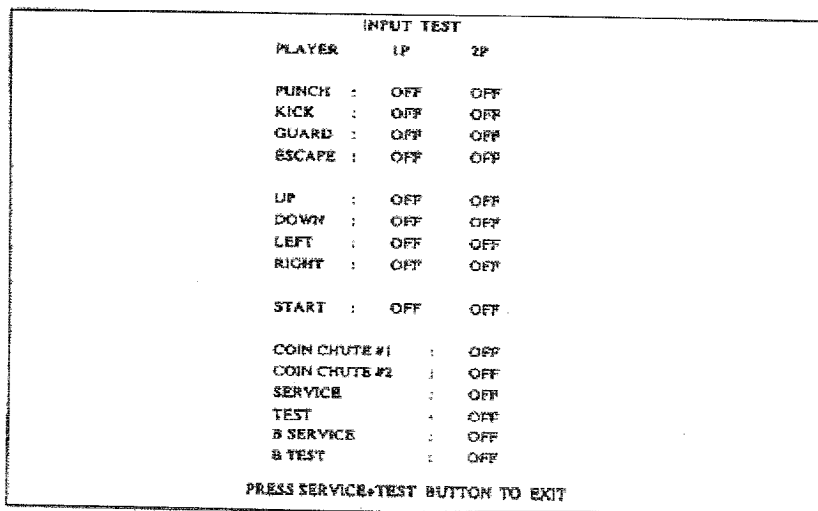

Simultaneously press the service and test button to have the menu mode return to the screen.

OUTPUT TEST

This allows the “versus play” cabinet’s billboard display (Winner Lamp, 7 Seg for 1P and 2P) to be checked.

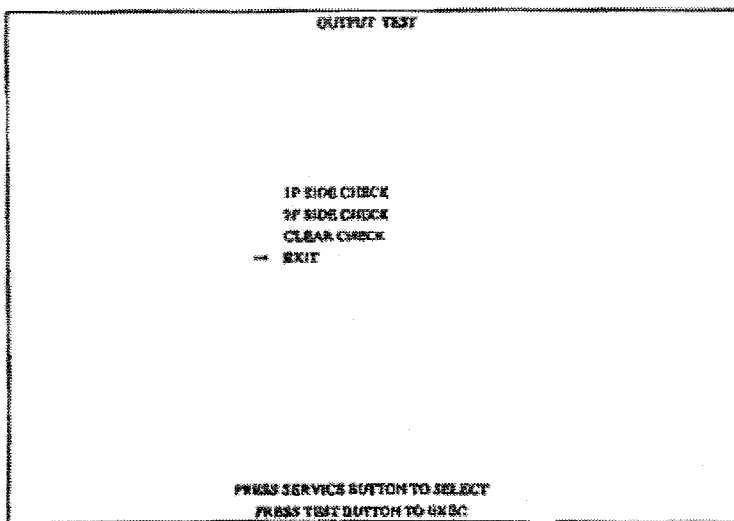

Choose the test item with the service button and press the test button to perform the test. When 1P or 2P is selected, 7-SEG display is show while the winner lamp is blinking. To stop the check, choose clear check. Press the test button to have the menu mode return to the screen.

SOUND TEST

This allows sound and background music to be tested.

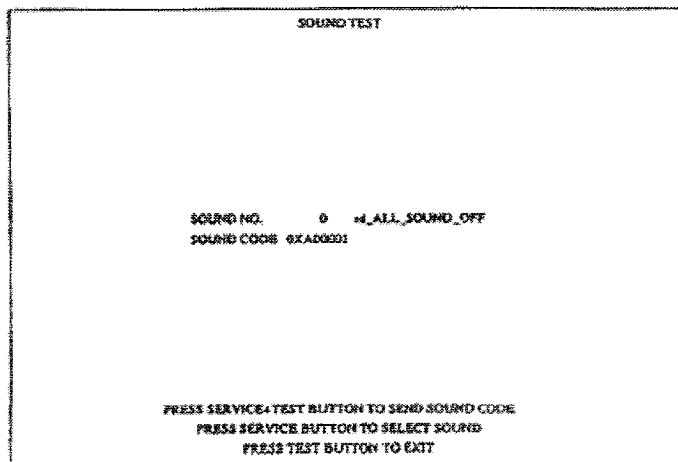

Pressing the service button increases the sound no. Pressing the test button while keeping the service button pressed will have the sound emitted or the music played. The 1P side control panel can also be used. The sound no. can be changed by moving the lever up/down, left/right. Use the punch button to cause the music to play. The kick button stops the background music and the guard button stops sound effects. Press the test button or the 1P side start button to return the menu to the screen.

CRT TEST
A) RGB COLOR ADJUSTMENT

This allows the monitor color to be checked.

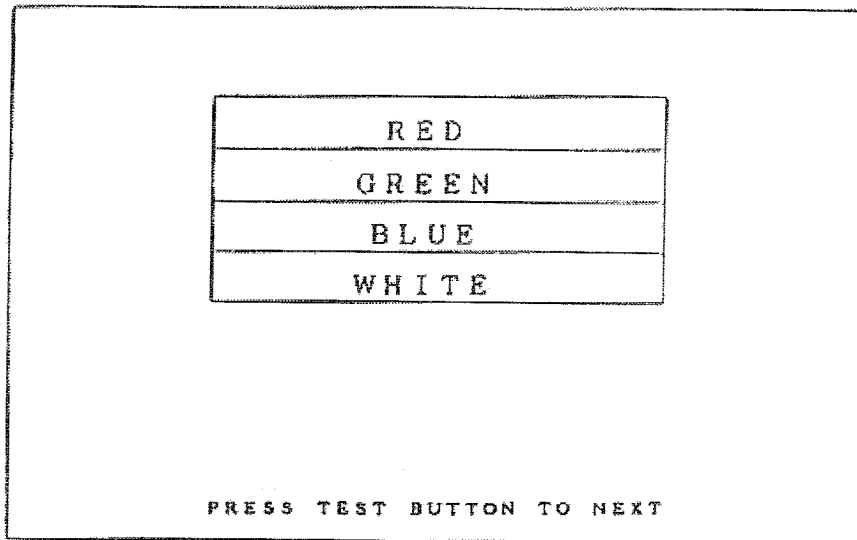

Each of the Red, Green and Blue colors is darkest at the left hand end and becomes brighter toward the right hand end. The monitor brightness is correct if the white color bar is black at the left hand end and white at the right hand end. Press the test button or 1P punch button to proceed to the next screen.

B) MONITOR SIZE ADJUSTMENT

This allows the monitor size to be checked.

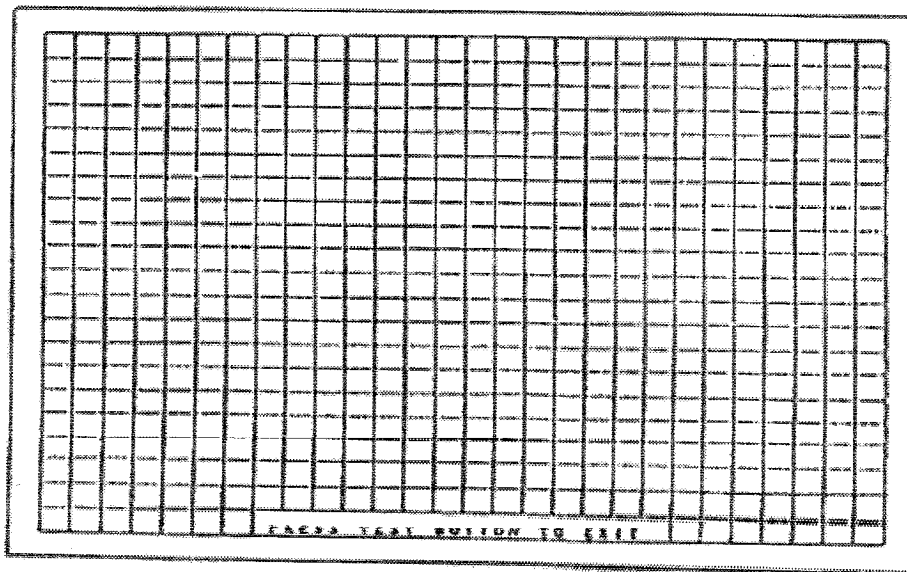

Make adjustments in a manner so that the checkered portions for checking do not go beyond the screen. Press the test button to have the menu return to the screen.

TIMER TEST

This test mode allows the date (year, month, day) to be set, and the incorporated battery as well as the real time clock to be checked.

Selection of the desired item:

Press the service button to move the arrow -> to the desired item.

Press the test button to select the item.

The above can also be performed using the 1P side lever up/down and the punch button.

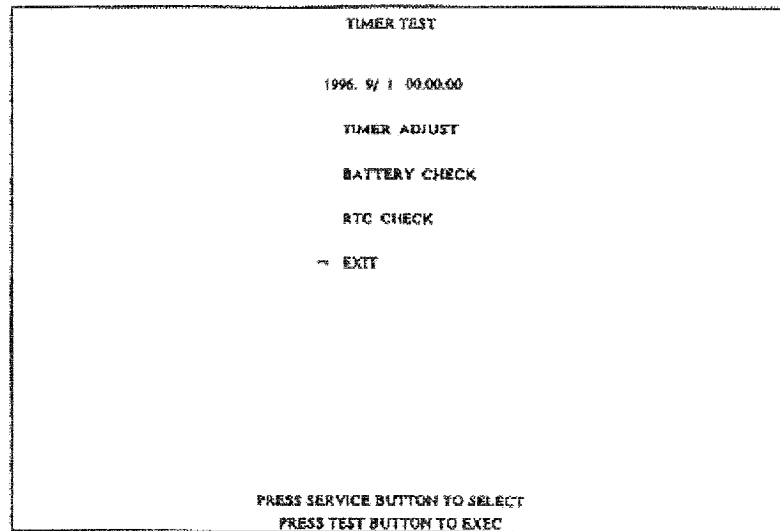

TIMER ADJUST

This allows the year, month, day, hour, minute and second to be set. Use the test button to choose year->month->day->hour->minute->second and change numerals with the service button. After the setting is complete, pressing the test button at the position second is set will have the item selection screen return. Press the test and service buttons at the same time to exit this page.

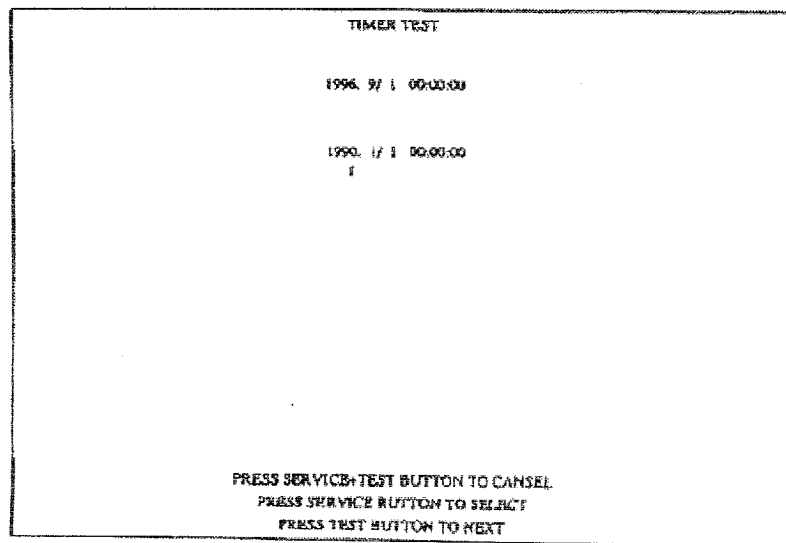

BATTERY CHECK

This allows the incorporated battery's voltage to be checked. Pressing the test button in the item selection screen allows for automatic checking. If the check is satisfactory, O K is displayed. If any error exists, "BATTERY VOLTAGE IS LOWER THAN 2.65V" is displayed. Press the test button to have item selection return to the screen.

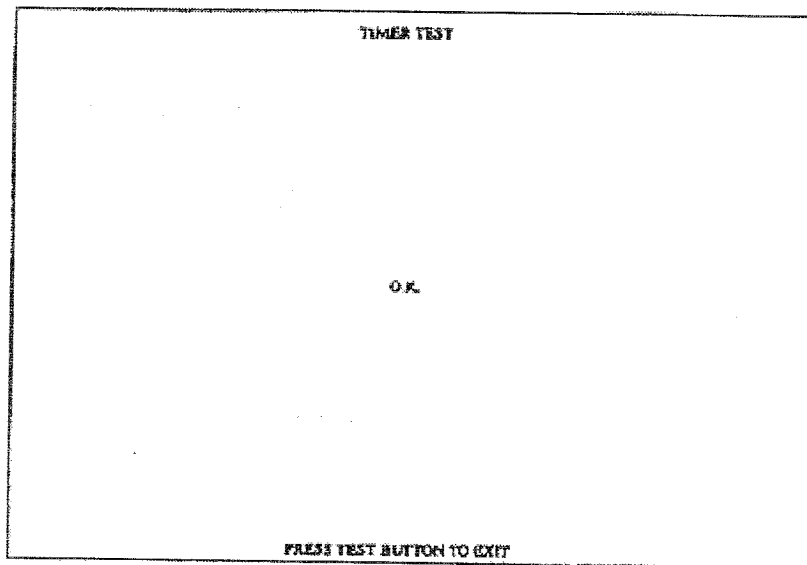

RTC CHECK

This allows the real time clock to be checked. Pressing the test button in the item selection screen allows for automatic checking. If any error exists, "RTC IS BROKEN DOWN" will be displayed. Press the test button to have the item selection screen return.

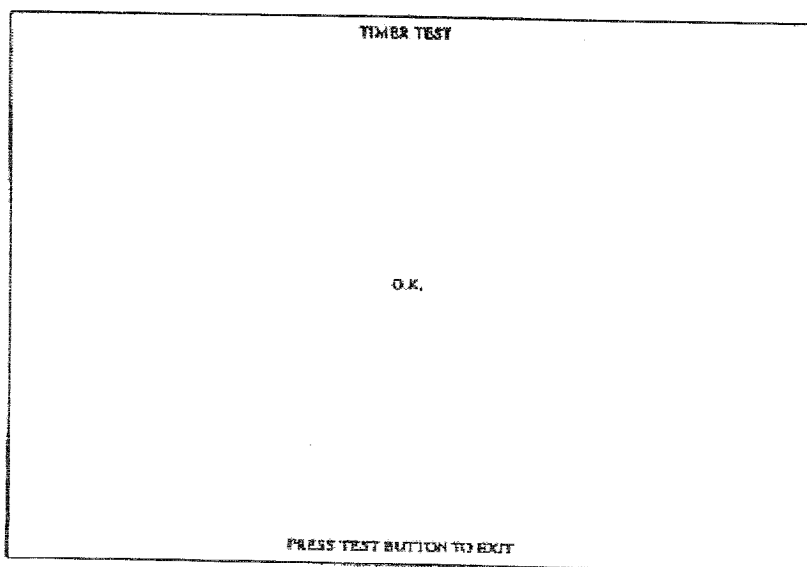

GAME ASSIGNMENTS

In this TEST mode, the settings of game difficulty level, etc. can be changed.

SELECTION OF THE SETTING ITEM

- 1) Press the SERVICE button to move “-” and bring it to the desired item.
- 2) Press the TEST button to change the setting.
- 3) When the setting is completed, move “-” to EXIT and press the TEST button.

The above can also be performed by using 1P side LEVER (up/down) and PUNCH button.

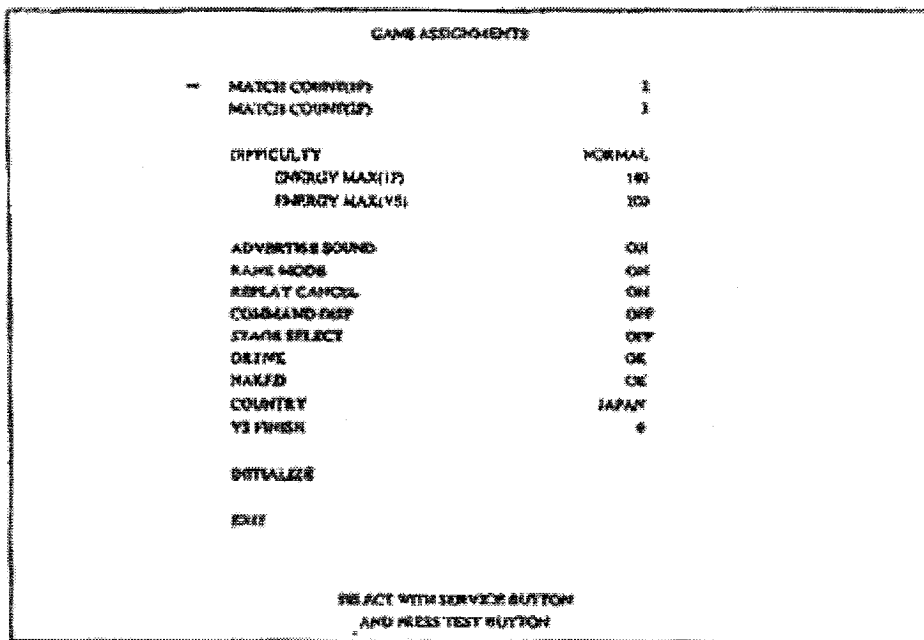

(A) MATCH COUNT (1P)

This sets the first to win how many points a match to be a winner in the case of 1P play. The setting from 1 to 5 points is possible. As a standard, it is set to 2.

(B) MATCH COUNT (VS)

This sets the first to win how many points a match to be a winner in the case of vs. play. The setting from 1 to 5 points is possible. As a standard, it is set to 3.

(C) DIFFICULTY

Sets the game's difficulty and the character's physical strength. The difficulty has 4 categories, i. e., EASY, NORMAL, HARD and HARDEST. Set to NORMAL in the standard setting. ENERGY MAX (100~360) for 1P play and (100~400) for the vs. play can be set on the ENERGY GAUGE. As a standard, set to 180 (for 1P play) and 200 (for vs. play).

(D) ADVERTISE SOUND

Determines whether the ADVERTISE SOUND is to be emitted or not. Set to ON or OFF. Set to ON for the standard setting in which the sound is emitted.

(E) RANK MODE

Sets whether the rank is to be determined and the results are to be displayed or not. When the game is continued, the determination of rank will be based on the results of the first one game. Set to ON or OFF. Set to ON for the standard setting.

(F) REPLAY CANCEL

Determines whether or not the REPLAY CANCEL set by the opponent using the START button is to be made ineffective by your player using the GUARD button. Set to ON or OFF. Set to ON for the standard setting.

(G) COMMAND DISP

Set to ON or OFF. When set to ON, only in the case where the COMMAND (while pressing P+K+G+E, press the START button) is inputted in 1P play, the player's COMMAND input is displayed. Set to OFF for the standard setting.

(H) STAGE SELECT

Determines whether in the versus play, STAGE select is allowed or not. Set to OFF or CHALLENGER. Set to OFF for the standard setting.

(I) DRINK

Determines whether when the Suiken character drinks, his face is to be flushed or not. Set to OK or NG. Set to ON for the standard setting.

(J) NAKED

Determines 1P side setting of Takaarashi's appearance. Set to OK or NG. In case of OK, he wears loincloth only, and a Yukata robe in case of NG. Set to OK for the standard setting.

(K) COUNTRY

Determines which one the Game Specifications are to be set to, JAPAN or USA or EXPORT.

(L) VS FINISH

Determines how many opponent characters your player should win over until Game Over. Setting made is between 0~10. When set to 1~10, if your player wins over the set number of opponent characters, the game is over. When set to 0, the game continues irrespective of the number of the opponent characters your player win over. Set to 0 for the standard setting.

(M) INITIALIZE

Initializes all of the GAME ASSIGNMENT settings.

(N) EXIT

Causes the MENU mode to return to the screen.

CO IN ASSIGNMENTS

In this mode, the CO IN/CREDIT setting, etc. can be changed

- 1) Press the SERVICE button to move “-” and bring it to the desired setting item.
- 2) Press the TEST button to cause the setting to change.
- 3) When the setting has been completed, move “-” to EXIT and press the TEST button.

The above can also be performed by using 1P side LEVER (up/ down) and PUNCH button.

COIN ASSIGNMENTS		
COIN CHUTE TYPE		COMMON
CREDIT TO 1P START		2 CREDITS
CREDIT TO 1P CONTINUE		3 CREDITS
CREDIT TO VS START		3 CREDITS
CREDIT TO VS CONTINUE		3 CREDITS
COIN/CREDIT SETTING		#1
CONC CREDIT #0	1 COIN	1 CREDIT
CONC CREDIT #1	1 COIN	1 CREDIT
MANUAL SETTING		
EXIT		
SELECT WITH SERVICE BUTTON AND PRESS TEST BUTTON		

(COMMON Setting)

COIN ASSIGNMENTS		
COIN CHUTE TYPE		INDIVIDUAL
CREDIT TO 1P START		1 CREDIT
CREDIT TO 1P CONTINUE		1 CREDIT
CREDIT TO VS START		1 CREDIT
CREDIT TO VS CONTINUE		1 CREDIT
COIN/CREDIT SETTING #1		
CONC CHUTE	1 COIN	1 CREDIT
MANUAL SETTING		
EXIT		
SELECT WITH SERVICE BUTTON AND PRESS TEST BUTTON		

(INDIVIDUAL setting)

A) CO IN CHUTE TYPE

Set to either of the following as applicable.

COMMON The cabinet type in which 2 players use a coin chute in common.

INDIVIDUAL Each of the 2 players uses his own coin chute (Versus City, etc.)

- (B) CREDIT TO 1P START (1~5 CREDITS)
 1P CONTINUE (1~5 CREDITS)

Sets the credits required for start/continue for 1P play.

- (C) CREDIT TO VS START (1~5 CREDITS)
 VS CONTINUE (1~5 CREDITS)

Sets the credits required for start/continue for vs. play.

- (D) CO IN/CREDIT SETTING (#1 ~ #27)
 (INDIVIDUAL setting)

Sets the CREDIT increase increment per coin insertion. There are 27 settings from #1 to #27, expressed in OO CREDITS as against OO COINS inserted. Note that #27 refers to FREE PLAY. For details, refer to Table 1 (COMMON) and Table 2 (INDIVIDUAL).

(E) MANUAL SETTING

The CREDITs incremental increase settings as against a coin insertion are shown in further details than in (D) above (refer to Table 3). Note that when this MANUAL SETTING is performed, settings as per D above, Coin Credit setting becomes ineffective.

NAME OF SETTING	COIN CHUTE 1		COIN CHUTE 2	
SETTING # 1	1 COIN	1 CREDIT	1 COIN	1 CREDIT
SETTING # 2	1 COIN	2 CREDITS	1 COIN	1 CREDIT
SETTING # 3	1 COIN	3 CREDITS	1 COIN	1 CREDIT
SETTING # 4	1 COIN	4 CREDITS	1 COIN	1 CREDIT
SETTING # 5	1 COIN	5 CREDITS	1 COIN	1 CREDIT
SETTING # 6	1 COIN	2 CREDITS	1 COIN	2 CREDITS
SETTING # 7	1 COIN	5 CREDITS	1 COIN	2 CREDITS
SETTING # 8	1 COIN	3 CREDITS	1 COIN	3 CREDITS
SETTING # 9	1 COIN	4 CREDITS	1 COIN	4 CREDITS
SETTING # 1 0	1 COIN	5 CREDITS	1 COIN	5 CREDITS
SETTING # 1 1	1 COIN	6 CREDITS	1 COIN	6 CREDITS
SETTING # 1 2	2 COINS	1 CREDIT	2 COINS	1 CREDIT
SETTING # 1 3	1 COIN	1 CREDIT	2 COINS	1 CREDIT
SETTING # 1 4	1 COIN	2 CREDITS	2 COINS	1 CREDIT
SETTING # 1 5	1 COIN	1 CREDIT	1 COIN	1 CREDIT
	2 COINS	3 CREDITS	2 COINS	3 CREDITS
SETTING # 1 6	1 COIN	3 CREDITS	1 COIN	1 CREDIT
			2 COINS	3 CREDITS
SETTING # 1 7	3 COINS	1 CREDIT	3 COINS	1 CREDIT
SETTING # 1 8	4 COINS	1 CREDIT	4 COINS	1 CREDIT
SETTING # 1 9	1 COIN	1 CREDIT	1 COIN	1 CREDIT
	2 COINS	2 CREDITS	2 COINS	2 CREDITS
	3 COINS	3 CREDITS	3 COINS	3 CREDITS
	4 COINS	5 CREDITS	4 COINS	5 CREDITS
SETTING # 2 0	1 COIN	5 CREDITS	1 COIN	1 CREDIT
			2 COINS	2 CREDITS
			3 COINS	3 CREDITS
			4 COINS	5 CREDITS
SETTING # 2 1	5 COINS	1 CREDITS	5 COINS	1 CREDIT
SETTING # 2 2	1 COIN	2 CREDITS	3 COINS	1 CREDIT
			5 COINS	2 CREDITS
SETTING # 2 3	2 COINS	1 CREDIT	2 COINS	1 CREDIT
	4 COINS	2 CREDITS	4 COINS	2 CREDITS
	5 COINS	3 CREDITS	5 COINS	3 CREDITS
SETTING # 2 4	1 COIN	3 CREDITS	2 COINS	1 CREDIT
			4 COINS	2 CREDITS
			5 COINS	3 CREDITS
SETTING # 2 5	1 COIN	1 CREDIT	1 COIN	1 CREDIT
	2 COINS	2 CREDITS	2 COINS	2 CREDITS
	3 COINS	3 CREDITS	3 COINS	3 CREDITS
	4 COINS	4 CREDITS	4 COINS	4 CREDITS
	5 COINS	6 CREDITS	5 COINS	6 CREDITS
SETTING # 2 6	1 COIN	6 CREDITS	1 COIN	1 CREDIT
			2 COINS	2 CREDITS
			3 COINS	3 CREDITS
			4 COINS	4 CREDITS
			5 COINS	6 CREDITS
SETTING # 2 7	FREE PLAY		FREE PLAY	

NAME OF SETTING	COIN CHUTE FOR EACH SEAT	NAME OF SETTING	COIN CHUTE FOR EACH SEAT
SETTING # 1	1 COIN 1 CREDIT	SETTING # 2 1	5 COINS 1 CREDIT
SETTING # 2	1 COIN 2 CREDITS	SETTING # 2 3	2 COINS 1 CREDIT
SETTING # 3	1 COIN 3 CREDITS		4 COINS 2 CREDITS
SETTING # 4	1 COIN 4 CREDITS		5 COINS 3 CREDITS
SETTING # 5	1 COIN 5 CREDITS	SETTING # 2 5	1 COIN 1 CREDIT
SETTING # 1 1	1 COIN 6 CREDITS		2 COINS 2 CREDITS
SETTING # 1 2	2 COINS 1 CREDIT		3 COINS 3 CREDITS
SETTING # 1 5	1 COIN 1 CREDIT		4 COINS 4 CREDITS
	2 COINS 3 CREDITS		5 COINS 6 CREDITS
SETTING # 1 7	3 COINS 1 CREDIT	SETTING # 2 7	FREE PLAY
SETTING # 1 8	4 COINS 1 CREDIT		
SETTING # 1 9	1 COIN 1 CREDIT		
	2 COINS 2 CREDITS		
	3 COINS 3 CREDITS		
	4 COINS 5 CREDITS		

COIN TO CREDIT (No. of coins required for one credit)	1 COIN 1 CREDIT
	2 COINS 1 CREDIT
	3 COINS 1 CREDIT
	4 COINS 1 CREDIT
	5 COINS 1 CREDIT
	6 COINS 1 CREDIT
	7 COINS 1 CREDIT
	8 COINS 1 CREDIT
	9 COINS 1 CREDIT

BONUS ADDER (BONUS COIN)	NO BONUS ADDER
	2 COINS GIVE 1 EXTRA COIN
	3 COINS GIVE 1 EXTRA COIN
	4 COINS GIVE 1 EXTRA COIN
	5 COINS GIVE 1 EXTRA COIN
	6 COINS GIVE 1 EXTRA COIN
	7 COINS GIVE 1 EXTRA COIN
	8 COINS GIVE 1 EXTRA COIN
	9 COINS GIVE 1 EXTRA COIN

COIN CHUTE (#1/#2) MULTIPLIER (For each coin chute)	1 COIN COUNTS AS 1 COIN
	1 COIN COUNTS AS 2 COINS
	1 COIN COUNTS AS 3 COINS
	1 COIN COUNTS AS 4 COINS
	1 COIN COUNTS AS 5 COINS
	1 COIN COUNTS AS 6 COINS
	1 COIN COUNTS AS 7 COINS
	1 COIN COUNTS AS 8 COINS
	1 COIN COUNTS AS 9 COINS

BOOKKEEPING

This test mode allows each of the data such as the number of coins inserted, credits, time and game frequency to be checked.

- GLOBAL DATA 1(1/4)

BOOKKEEPING 1P (GLOBAL DATA 1)				
TOTAL COINS	#1	#2		
COIN CHUTE #1	0	0		
COIN CHUTE #2	0	0		
TOTAL CREDITS	0			
COIN CREDITS	0			
SERVICE CREDITS	0			
FREE PLAY	0			
TOTAL TIME	00	00	00	00
PLAY TIME	00	00	00	00
1P PLAY TIME	00	00	00	00
VS PLAY TIME	00	00	00	00
PLAY WAIT TIME	00	00	00	00
OTHER TIME	00	00	00	00
PLAY TIME BATH(%)				
TOTAL GAME COUNT	0			
1P GAME COUNT	0			
VS GAME COUNT	0			
TOTAL AVERAGE TIME	00	00	00	00
1P AVERAGE TIME	00	00	00	00
VS AVERAGE TIME	00	00	00	00
PRESS SERVICE BUTTON TO CONTINUE PRESS TEST BUTTON TO EXIT				

(A) TOTAL COINS

Displays the number of all the coins inserted.

(B) COIN CHUTE #1

Displays the number of coins inserted in COIN CHUTE #1.

(C) COIN CHUTE #2

Displays the number of coins inserted in COIN CHUTE #2.

(D) TOTAL CREDITS

Displays the total number of credits.

(E) COIN CREDITS

Displays the number of credits from the coins inserted.

(F) SERVICE CREDITS

Displays the number of credits from the input by using the SERVICE button.

(G) FREE PLAY

Displays the frequency of game start in FREE PLAY.

(H) TOTAL TIME

Displays the total energized time of the machine.

(I) PLAY TIME Displays game play time. (J) 1P PLAY TIME

Displays the play time by 1P (against Computer).

(K) VS PLAY TIME
Displays vs. play time.

(L) PLAY WAIT TIME
Displays wait time as in the SELECT MODE, etc. during play.

(M) OTHER TIME
Displays the ineffective play time during which game can not be played due to WARNING, etc., or discontinued due to some accident, etc.

(N) PLAY TIME RATIO
Displays the ratio of PLAY TIME as against the total energized time.

(O) TOTAL GAME COUNT
Displays the total game play frequency.

(P) 1P GAME COUNT
Displays the frequency of play by 1P (against CPU)

(Q) VS GAME COUNT
Displays the vs. play frequency.

(R) TOTAL AVERAGE TIME
Displays the total average play time.

(S) 1P AVERAGE TIME
Displays the average time of play by 1P (against CPU).

(T) VS AVERAGE TIME
Displays the average play time in vs. play.

Press the SERVICE button to proceed to the next page (2/4).

Press the TEST button to have the MENU MODE return to the screen.

GLOBAL DATA (2/4)

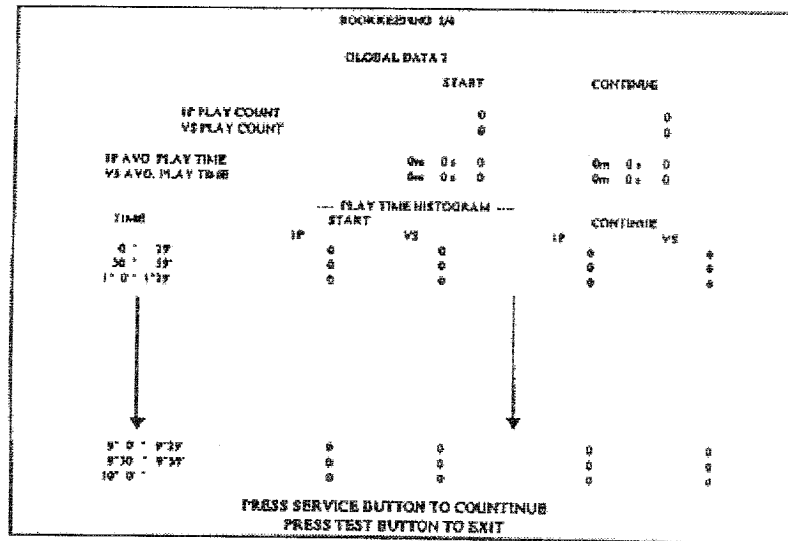

(U)

Displays the frequency of play in each of 1P game and vs. game.
Displays the average play time in each of 1P play and vs. play.

(W)

Displays by-play-time histogram.

Press the SERVICE button to proceed to next page (3/ 4). Press the TEST button to proceed to the next page.

1P GAME DATA(3/4)

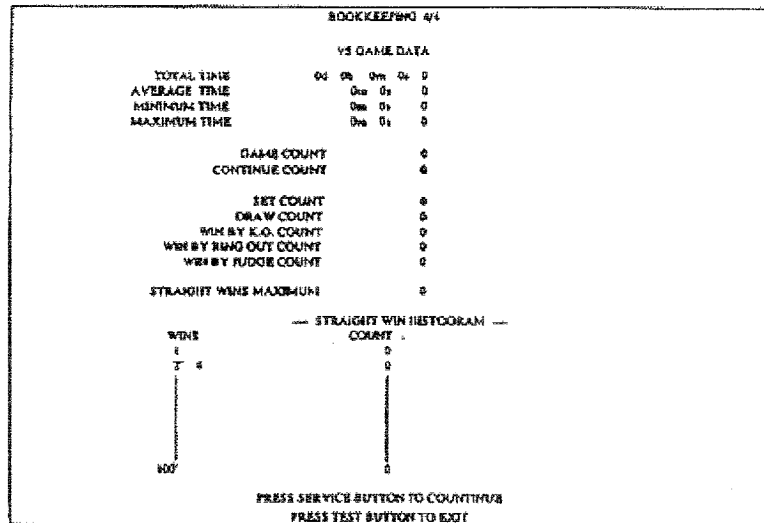

(X)TOTAL TIME

Displays the total play time in 1P play.

(Y)AVERAGE TIME

Displays the average play time in 1P play.

(Z)MINIMUM TIME

Displays the minimum play time in 1P play.

(a)MAXIMUM TIME

Displays the maximum play time in 1P play.

(b)GAME COUNT

Displays the frequency of 1P play.

(c)CONTINUE COUNT

Displays the frequency of CONTINUE play in 1P play.

(d)SET COUNT

Displays the total set count in 1P play.

(e)DRAW COUNT

Displays the frequency of DRAW in 1P play.

(f)WIN BY K.O. COUNT

Displays the frequency of win by K.O.

(g)WIN BY RING OUT COUNT Displays the frequency of win by ring out in 1P play.

(h)WIN BY JUDGE COUNT

Displays the frequency of win by JUDGE COUNT in 1P play.

(i) ROUND DATA HISTOGRAM

Displays by-round frequency of play and win, play time and win ratio in 1P play.

Press the SERVICE button to proceed to next page (4/4).

Press the TEST button to have the MENU MODE return to the screen.

VS GAME DATA (4/4)

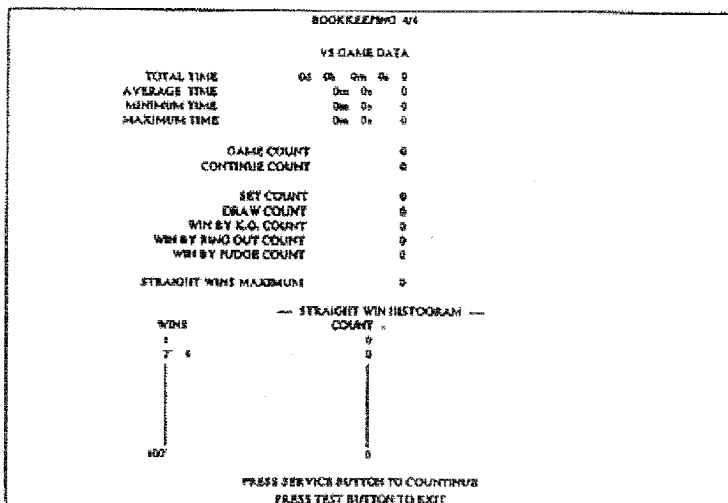

(j) TOTAL TIME

Displays the total play time in vs. play.

(k) AVERAGE TIME

Displays the average play time in vs. play.

(l) MINIMUM TIME

Displays the minimum play time in vs. play.

(m) MAXIMUM TIME

Displays the maximum play time in vs. play.

(n) GAME COUNT

Displays the frequency of vs. play.

(o) CONTINUE COUNT

Displays the frequency of CONTINUE play in vs. play.

(p) SET COUNT

Displays the total set count in vs. play.

(q) DRAW COUNT

Displays the frequency of DRAW in vs. play.

(r) WIN BY K. O. COUNT

Displays the frequency of win by K.O. in vs. play.

(s) WIN BY RING OUT COUNT

Displays the frequency of win by ring out in vs. play.

it) WIN BY JUDGE COUNT

Displays the frequency of win by JUDGE COUNT in vs. play.

(u) STRAIGHT WIN HISTOGRAM

Displays the straight win histogram in vs. play.

Press the SERVICE button to proceed to next page (1/ 4).

Press the TEST button to have the MENU MODE return to the screen.

2)VS DIAGRAM

This allows each character's data to be checked.

Press the SERVICE button to proceed to the next page (all pages).

Press the TEST button to have the MENU MODE return to the screen.

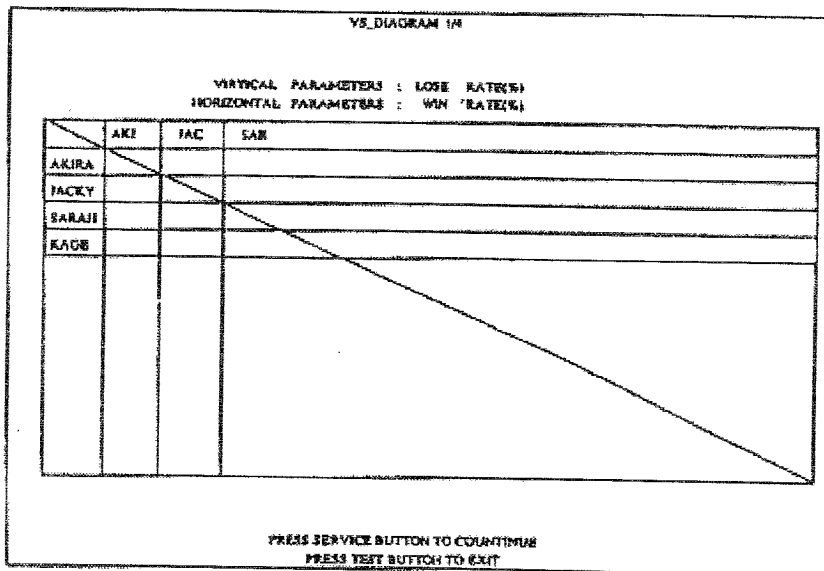

BACK UP RAM CLEAR

Clears the contents of BOOKKEEPING.

BACK UP RAM CLEAR

YES(CLEAR)
← NO(CANCEL)

PRESS SERVICE BUTTON TO SELECT
PRESS TEXT BUTTON TO EXEC

When clearing, bring “->” to “YES” by using the SERVICE button and press the TEST button. To have the MENU MODE return to the screen, bring “->” to “NO” and press the TEST button. When clearing has been finished, “COMPLETED” will be displayed. Pressing the TEST button will have the MENU MODE return to the screen. The above can also be performed by using 1P side LEVER (up/down) and PUNCH button.

ALL INITITALIZE

In this TEST mode, the contents of all settings are initialized.

ALL INITIALIZE

YES(CLEAR)
← NO(CANCEL)

PRESS SERVICE BUTTON TO SELECT
PRESS TEXT BUTTON TO EXEC

When initializing, bring the arrow “->” to “YES” by using the SERVICE button and press the TEST button. To have the MENU return to the screen, bring “->” to “NO” and press the TEST button. When initialization has been finished, “COMPLETE” will be displayed. Pressing the TEST button will have the MENU return to the screen. The above can also be performed by using 1P side LEVER (up/down) and PUNCH button.

REPLACEMENT OF THE FLUORESCENT LAMP



WARNING!

When performing work, be sure to turn power off. Working on the machine with power on can cause an electric shock or short circuit accident.

The fluorescent lamp, which gets very hot, can cause burns. Be very careful when replacing the fluorescent lamp.



CAUTION!

To perform work safely and securely, be sure to prepare a step which is in a secure and stable position. Using an unstable step can cause falls resulting in both personal injury and product damage.

Remove the billboard holder and pull the billboard upward to remove and replace the fluorescent lamp.

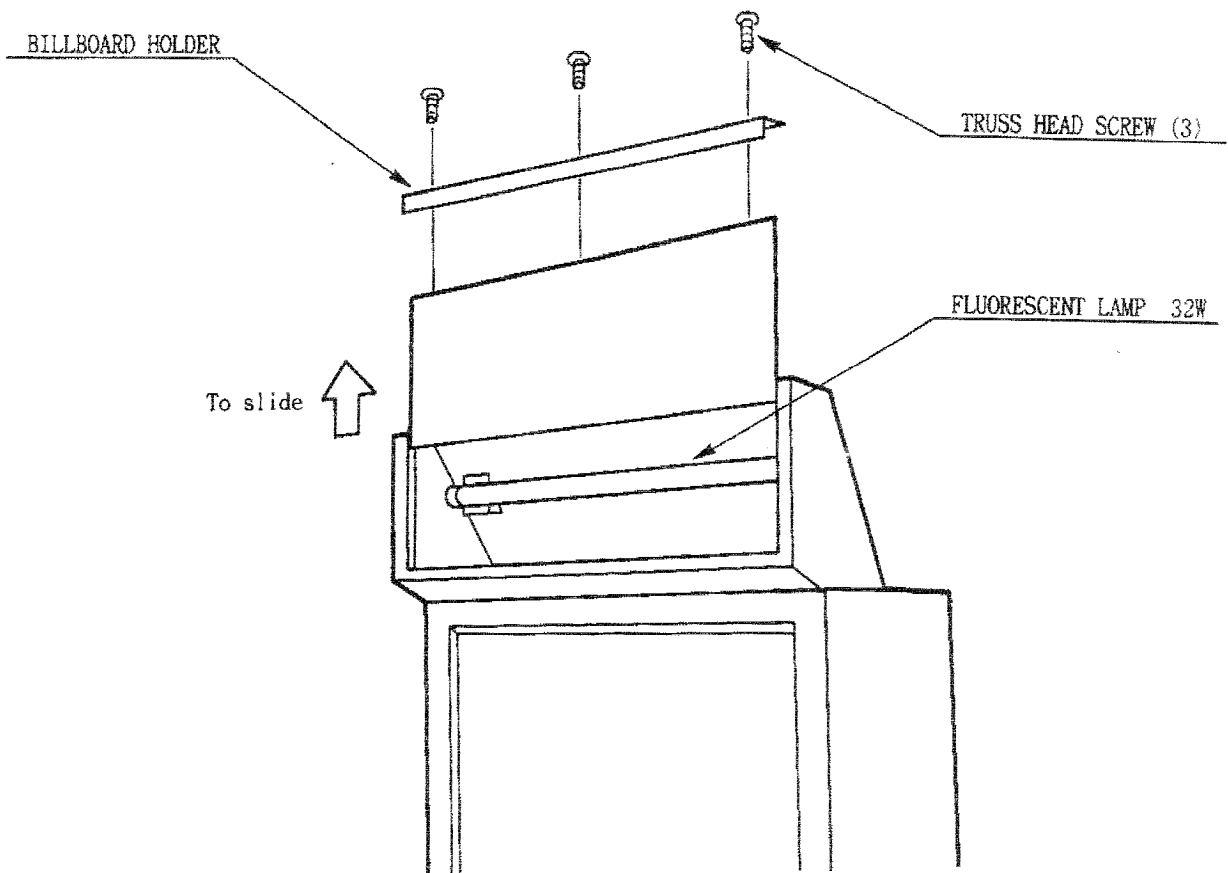

TROUBLESHOOTING



In order to prevent an electric shock, be sure to turn power off before performing work and touching the interior of the machine.
Be careful so as not to damage wiring. Damaged wiring can cause an electric shock or short circuit accident.

For troubleshooting, first check the connection of the wiring connectors.

PROBLEM	CAUSE	COUNTER MEASURE
When the main SW is turned ON, the machine is not activated.	The cord is not plugged in. Incorrect power source/voltage. Primary or secondary fuse blown.	Firmly insert the plug into the outlet. Make sure that the power supply voltages are correct. First, remove the cause of overcurrent, then replace the fuse. Primary Fuse: 7A 250V Fast Blo

The items listed below will assist in troubleshooting when a problem occurs. As a first step, check all wiring connector connections and verify AC power to the machine.

TABLE 1: TROUBLESHOOTING

PROBLEM	CAUSE	COUNTER MEASURE
MONITOR screen is blackened and the fluorescent lamp does not light up.	Primary or secondary fuse blown.	First, remove the cause of overcurrent, then replace the fuse. Primary Fuse: 7A 250V Fast Blo
MONITOR screen is all blue.	Defective connections between boards.	Make sure of correct connections between boards.
The color of image on MONITOR screen is incorrect.	Incorrect monitor adjustment. RGB connections are mixed up.	Make appropriate adjustments. Reconnect RGB cables correctly.
The on-screen image of the monitor sways or shrinks.	The power source and voltage are not correct.	Make sure that the power supply voltages are correct.
During game play, when controller switch is moved, no response onscreen.	SW malfunctioning.	Replace SW.
Marquee lamp doesn't light up.	Fluorescent lamp needs replacement. The connector is disconnected. Primary fuse is blown.	Replace lamp. Check connector connections in the marquee. Replace fuse.
Sound is not emitted.	Sound volume adjustment is not correct. Malfunctioning of sound board and/or memory.	Adjust the service panel volume control knob. Perform the <i>SOUND TEST</i> . Replace secondary fuse.
Game makes sounds, but has no picture.	Secondary fuse blown.	Replace the secondary fuse.



In order to prevent an electric shock, be sure to turn power off before performing work and touching interior parts of the machine.
Be careful so as not to damage wiring and cause an electric shock or short circuit.



Do not expose the game board without good reason. In this product, setting changes are made during the test mode. The game board need not be operated. Use the game board as is, with the settings made at the time of shipment.

TAKING OUT THE SHIELD CASE ASSEMBLY

When a problem occurs on the game board, remove the shield case assembly for return to the factory by using the following procedure:

Turn the main switch off.

The shield case is inside the cabinet, accessible from the locked door on the right side.

Remove two tamperproof screws using the tool provided to you. Unlock the side door and remove.

Remove connectors to filter board on shield case assembly and remove 4 wood screws that secure the shield case to the cabinet. Remove the shield case from the cabinet, and exercise care not to drop the shield case when doing so.

Place shield case securely in the re-useable box provided to you with the game.



Do not open the shield case for any reason. Any inspection or repairs to the game board must be performed at the Sega facility only. Removing the game board from the shield case may cause your factory warranty to be voided.

FOR REFERENCE ONLY

COMPOSITION OF GAME BOARD

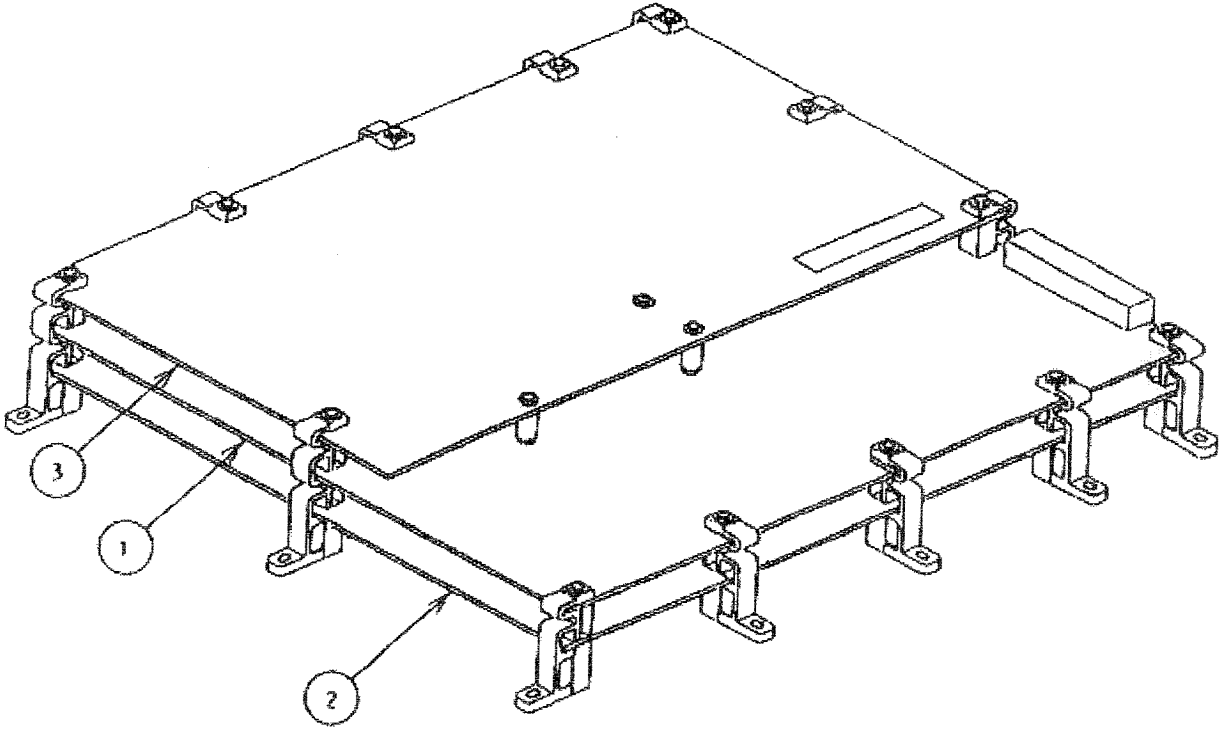

	PART No.	DESCRIPTION
GAME BD (①+②+③)	833-12712	GAME BD VIRTUA FIGHTER 3
CPU BD ①	837-11858	MODEL3 CPU BD COM
VIDEO BD ②	837-11859	MODEL3 VIDEO BD COM
ROM BD ③	834-12821	ROM BD VIRTUA FIGHTER 3

GAME BOARD SERVICE RECORD

This page is provided for your use in tracking repairs or replacements of your Sega game PCBs and assemblies. This information can help provide a service history for your game should it ever be sold or transferred.

DATE **BOARD ASSY NO.** **PCB SERIAL NO.** **RMA NO.**

DATE	BOARD ASSY NO.	PCB SERIAL NO.	RMA NO.

HANDLING THE COIN JAM

Even when the REJECT button is pressed, if the coin is not rejected, open the coin chute door and open the selector gate. After removing the jammed coin, put a normal coin in and check to see that the selector correctly functions.

CLEANING THE COIN SELECTOR

- 1) Turn the power for the machine OFF.
Open the coin chute door.
- 2) Open the gate and dust off by using a soft brush (made of wool, etc.).
- 3) Remove stain by wiping with a soft cloth which contains water or chemicals detergent.
- 4) Remove the CRADLE. When removing the retaining ring (E ring), be very careful so as not to bend the shaft.
- 5) Remove stain from the shaft and pillow portions by wiping off with a soft cloth, etc.
- 6) After wiping off as per 5 above, further apply a dry cloth, etc. to cause the coin selector to dry completely.

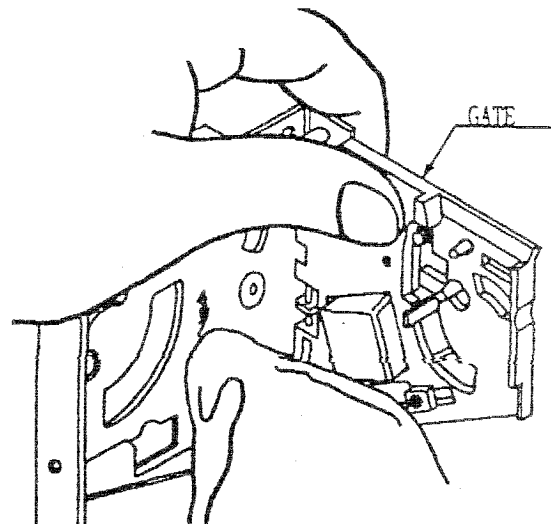

NOTE:

Absolutely do not apply machine oil, etc. to the coin selector.

After cleaning the coin selector, insert a regular coin in the normal working status and ascertain that the selector correctly functions.

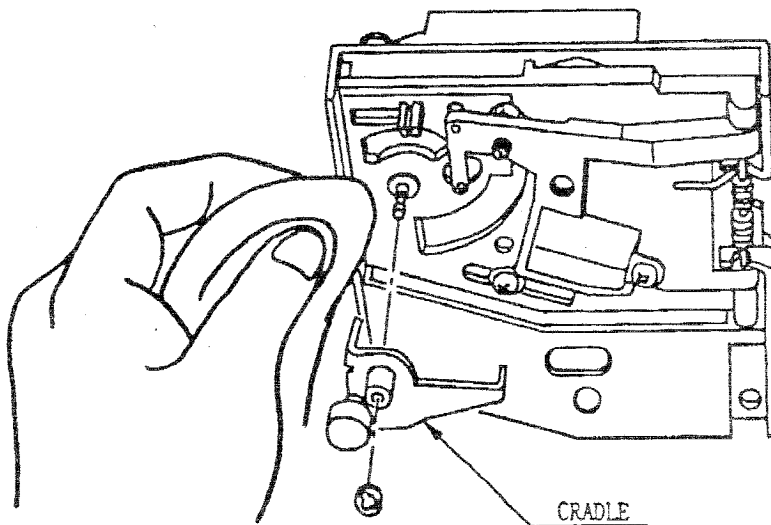

PROJECTOR

ADJUSTMENTS



CAUTION!

Since the projector has been adjusted at the time of shipment, do not make any further adjustments without good reason.

Fine adjustments are stored in the projector. Pressing the fine adjustment switch (Convergence adjustment) results in entering the fine adjustments mode, and this may cause the stored fine adjustment to be changed. During work other than for adjustment, should you touch the fine adjustment switch by mistake, immediately turn off power by using the main switch and then turn it back on again. If any distortion or color deviation is found in the test mode, and adjustments are needed, use the specified adjustment knob or perform the adjustments by using the remote control. Note that projector models and makes may vary, and adjustment methods will differ dependent on the manufacturer.



IMPORTANT!

The projector is subject to color deviation due to convergence deviation caused by geomagnetism at the installation location and peripheral magnetic field. After the installation of machine, and before commencing operation, check for convergence deviation and, if deviated, make necessary adjustments.

CLEANING THE SCREEN



CAUTION!

Since the projector screen is highly susceptible to damage, pay careful attention to its handling. When cleaning, refrain from using water or volatile chemicals.

When the screen surface becomes dirty with dust, etc, clean it using a soft cloth such as gauze. When water and volatile chemicals such as benzine, thinner, etc, spill onto the the screen surface, it may be susceptible to damage, therefore, refrain from exposing the surface to these liquids. Also, since the screen surfaces are easily susceptible to damage from abrasion, avoid rubbing them with any hard materials or using a duster.

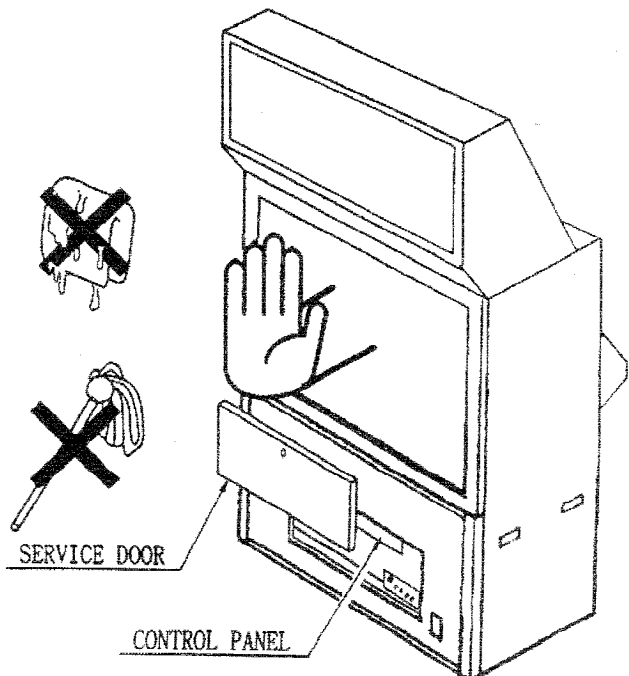

MITSUBISHI PROJECTOR

□ MITSUBISHI PROJECTOR CONTROL PANEL

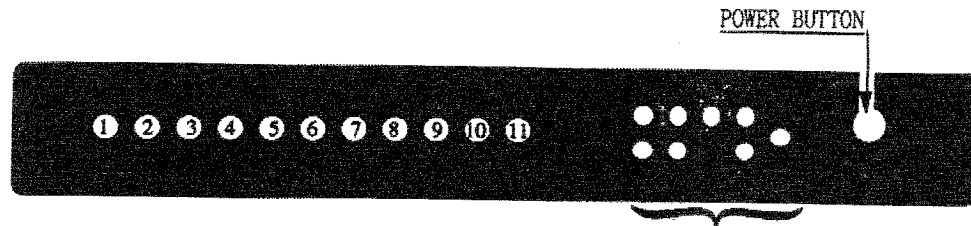

CONVERGENCE ADJUSTMENT SW

- | | | | | |
|----------|---|----------|----------|----------|
| ① V. POS | ② H. POS | ③ R-GAIN | ④ G-GAIN | ⑤ B-GAIN |
| ⑥ CONT | ⑦ BRI | ⑧ V-W | ⑨ H-W | |
| ⑩ R·H·L | } Linearity adjustments in horizontal directions
(red or blue) are made. | | | |
| ⑪ B·H·L | | | | |

STATIC CONVERGENCE ADJUSTMENT

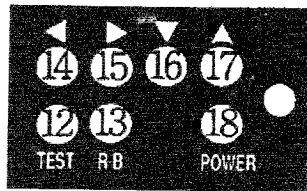

Convergence Adjustment SW

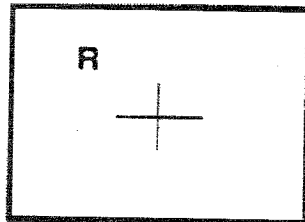

- | | |
|---------|----------------------|
| ⑫ TEST | Test mode on/off key |
| ⑬ R/B | R/B shift key |
| ⑭ ◀ | Left shift key |
| ⑮ ▶ | Right shift key |
| ⑯ ▼ | Lower shift key |
| ⑰ ▲ | Upper shift key |
| ⑱ POWER | Power button |

- For the convergence adjustment mode, press the test mode on/off key.
- Ensure that "R" is displayed on the screen.
- Make adjustments so as to cause the red cross pattern to match with the green cross pattern by using the left shift key (14), right shift key (15), lower shift key (16), and upper shift key (17).
- By using the R/B shift key (13), cause the red adjustment "R" to shift to blue adjustment "B" and make sure that "B" is displayed on the screen.
- In the same manner as above, make the blue cross pattern match with the green cross pattern.
- After making adjustments, press the test mode on/off key to cancel the convergence adjustment mode.



Although remote control buttons other than those specified below do not function even if pressed during convergence adjustment, do not press them during adjustment work to avoid causing a malfunction.

Operate the remote control towards the PTV screen. If directed other than toward the screen, the remote control does not function.

BEFORE USING THE REMOTE CONTROL

First, make sure that the main switch on the projector's control panel is ON and the LED adjacent to the main switch is lit.

For convergence adjustment mode, press the test button. Ensure that "R" is displayed on the screen.

Make adjustment so as to cause the red cross pattern to match with the green cross pattern. When the red cross matches the green cross, the green cross turns yellow or white.

Use the remote control buttons as shown below to move the red cross.

- (5) to the left
- (7) to the right
- (2) Upward
- (10) Downward

Use remote control buttons (6) to shift "R" to "B." Make sure "B" is displayed on the screen. Each time button (6) is pressed, red and blue adjustments are shifted.

In the same manner, cause the blue cross to match with the green cross. When the blue cross matches, the green cross will turn white.

After adjustments are made, press the test button to cancel the convergence adjustment.

When 2 minutes or more elapse in the convergence mode screen without any action being taken, the on-screen adjustment mode will disappear.

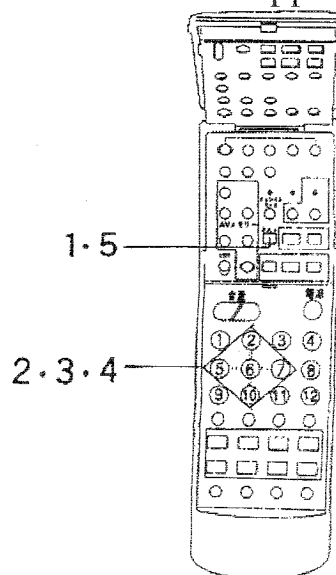
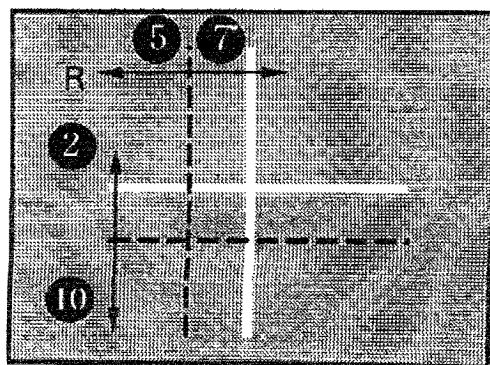



CONTROL PANEL GRAPHIC	CMGG-00671
MARQUEE GRAPHIC	CMGG-00679
INSTRUCTION GRAPHIC	CMGG-00673
MONITOR SIDE GRAPHIC	CMGG-00672
GREEN BUTTON	58-2610-13G
RED BUTTON	58-2610-10G
YELLOW BUTTON	58-2610-15G
WHITE BUTTON	STVV-00225
JOYSTICK	50-7608-130
VALIDATOR	42-6969-00
COIN DOOR	

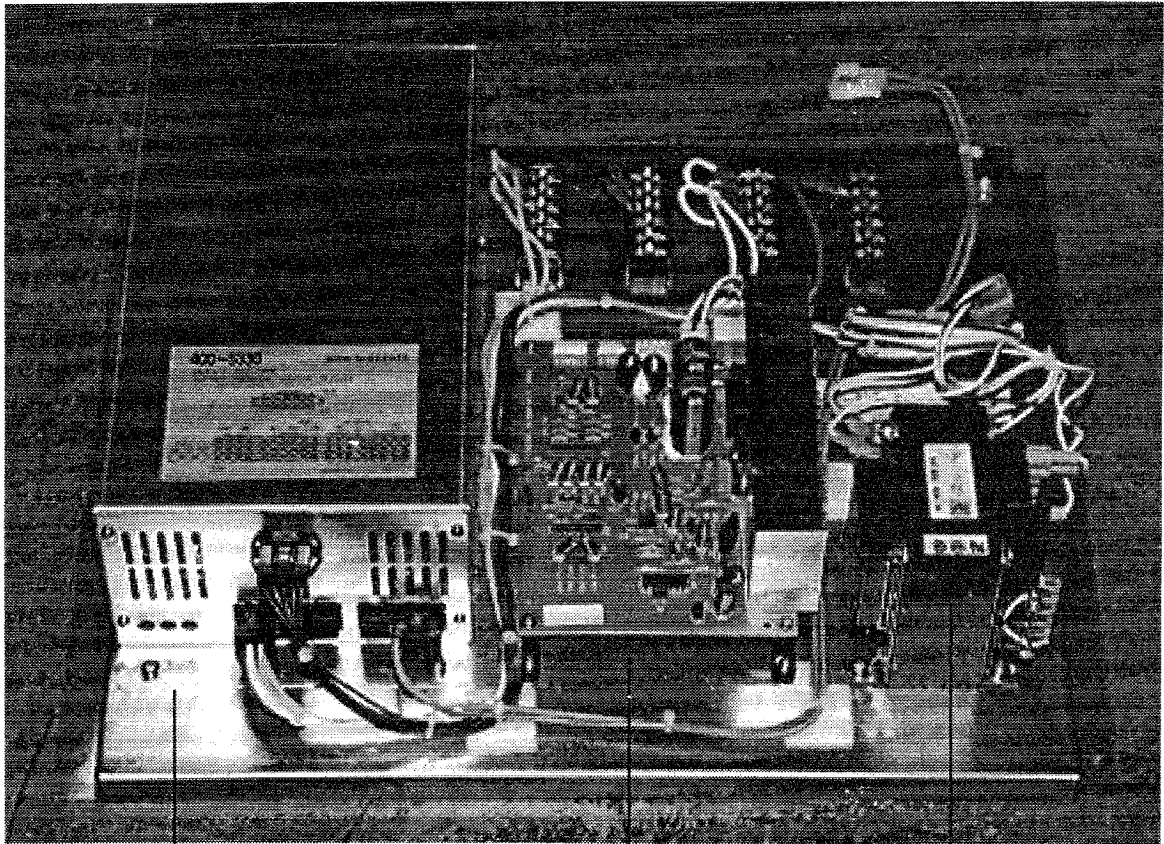

POWER SUPPLY
400-5330

AUDIO AMP
838-12796

MCI
TRANSFORMER
4-49-8036

BILL VALIDATOR
42-6969-00

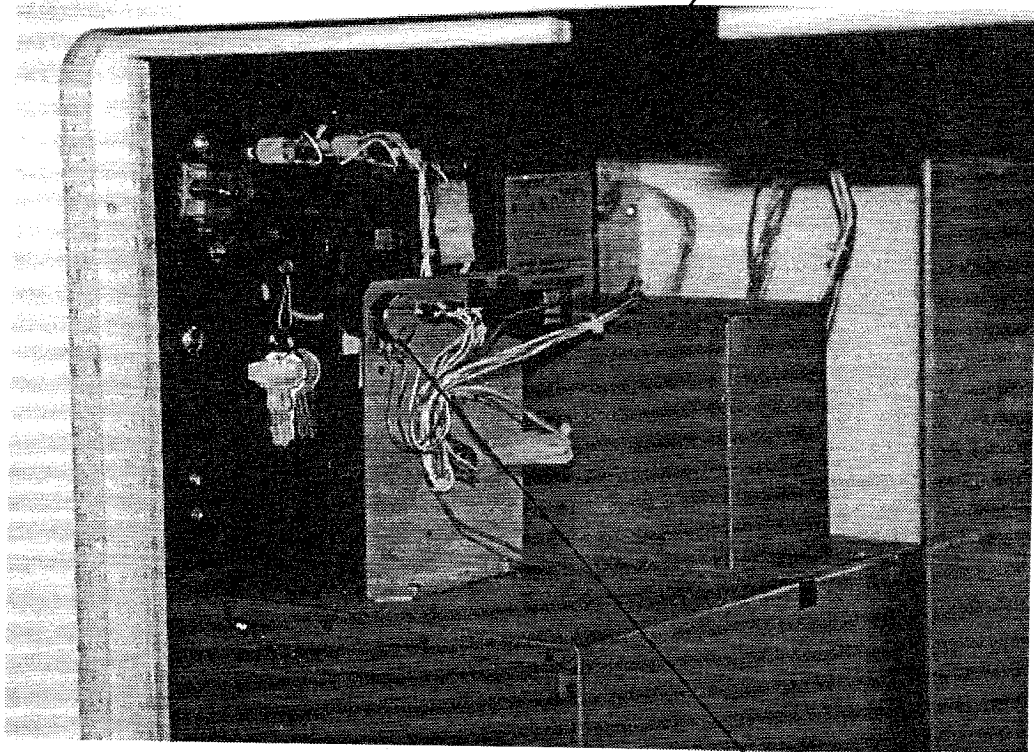

VOLUME 5K POT
TEST
SERVICE BUTTONS

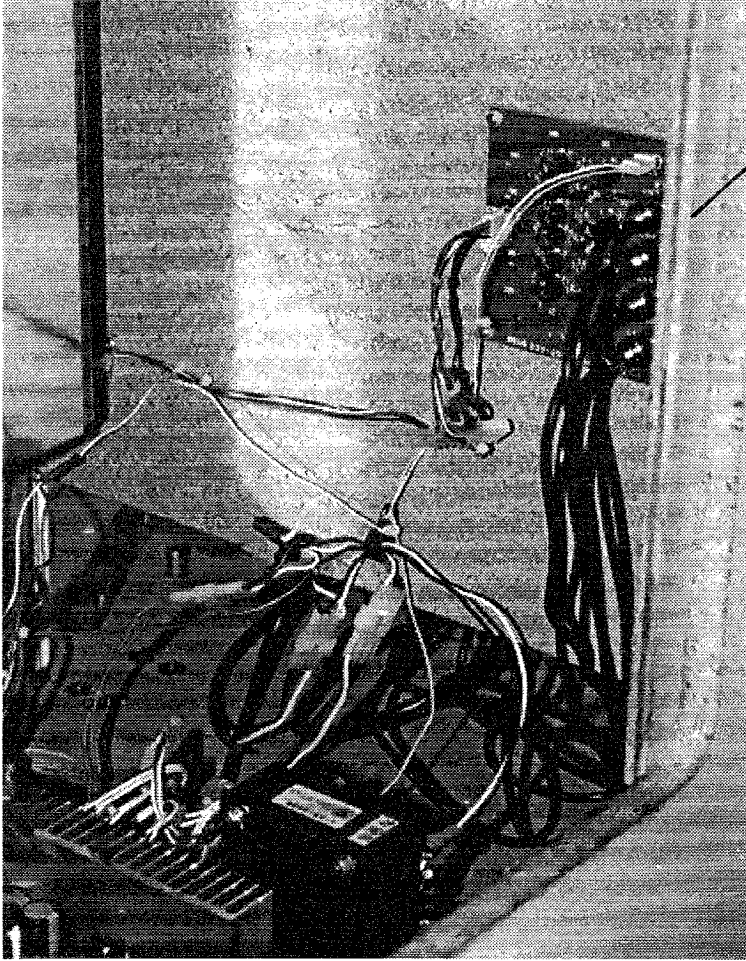

VPM BUFFER BOARD

839-0582

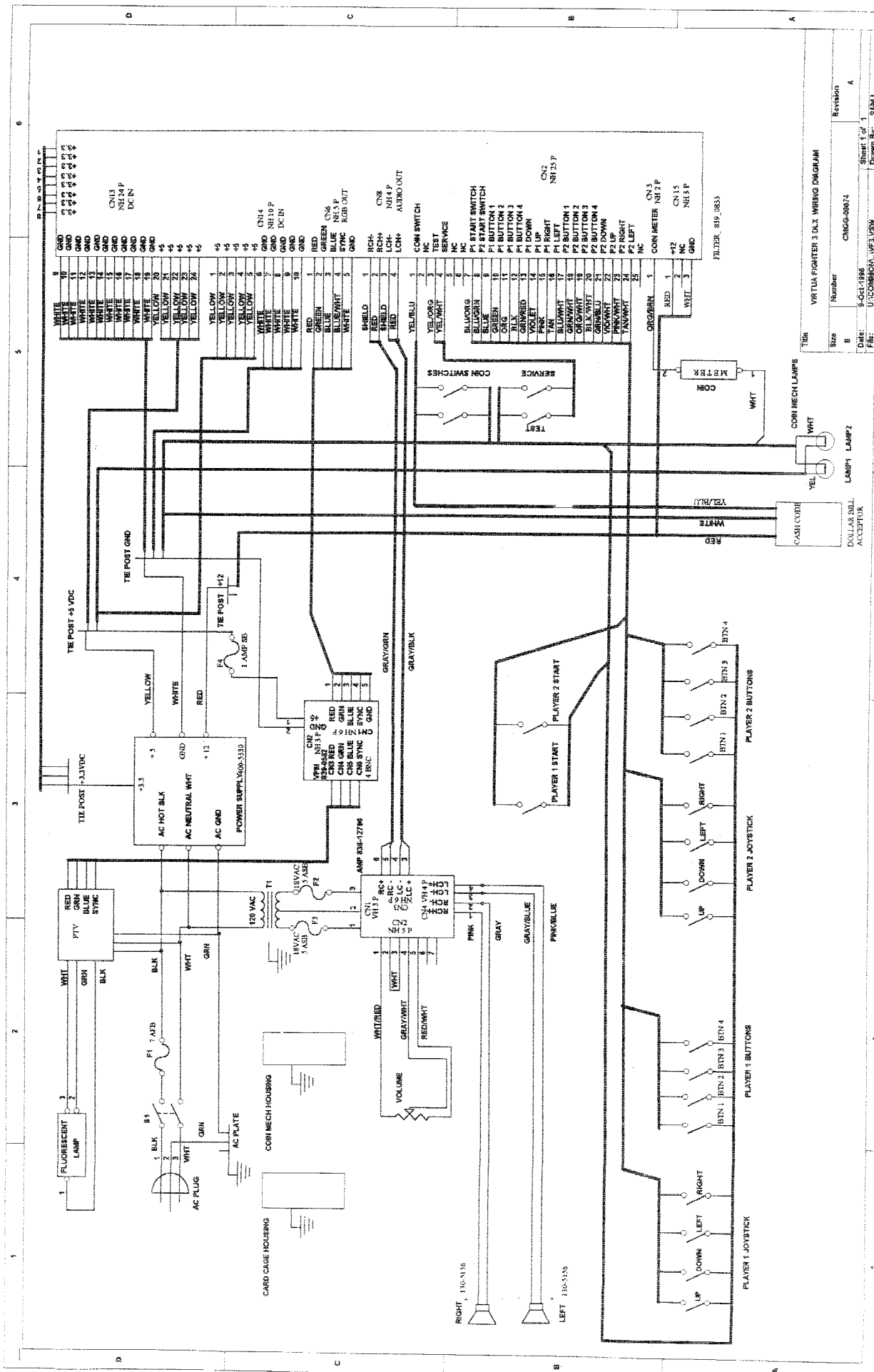

Title		Revision	
VIRTUAL FIGHTER 3 DAX WIRING DIAGRAM		Number	Revision
A		CMGG-00874	A
B		9-OCT-1986	Sheet 1 of 1
C		U:COMMCHA, WFL:VSW	Drawn By: SMML

4 42.60

ADDENDUM

This Procedure is to set the Virtua Fighter 3 for 4 Coins to start and 3 Coins to continue.

1) Setting Cash Code Dollar Bill Acceptor:

Dip switch settings

1 2 3 4 5 6 7 8 OFF

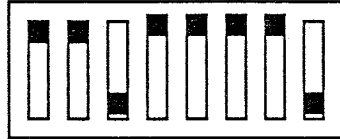

ON

Switches 1 and 2 must be set in the OFF position, remaining switches 3 - 8 per this diagram.

2) Setting of Coinage and Coin to Credit:

Enter into Test Mode by depressing Test Button on Service Panel through the Coin Door. Use Service Button to scroll to "COIN ASSIGNMENTS" category and press Test button to get into "COIN ASSIGNMENTS".

COIN ASSIGNMENTS

COIN CHUTE TYPE		COMMON
CREDIT TO 1P START		4 CREDIT (S)
1P CONTINUE		3 CREDIT (S)
CREDIT TO VS START		4 CREDIT (S)
VS CONTINUE		3 CREDIT (S)
COIN/CREDIT SETTING #1		
COIN CHUTE #1	1 COIN	1 CREDIT
COIN/CREDIT SETTING #2		
COIN CHUTE #2	1 COIN	1 CREDIT
MANUAL SETTING		
EXIT		

SELECT WITH SERVICE BUTTON
AND PRESS TEST BUTTON

3) Setup complete, exit Test Mode

3. MOUNTING AND OVERALL DIMENSIONS

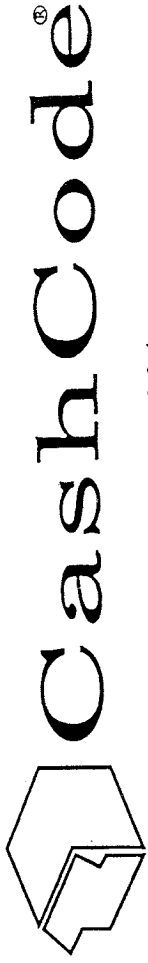
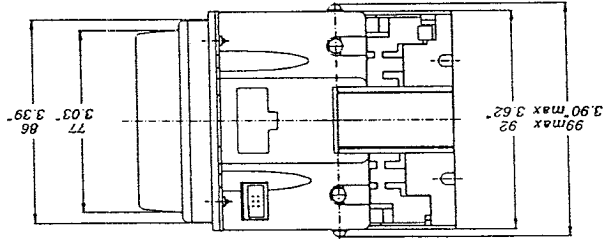
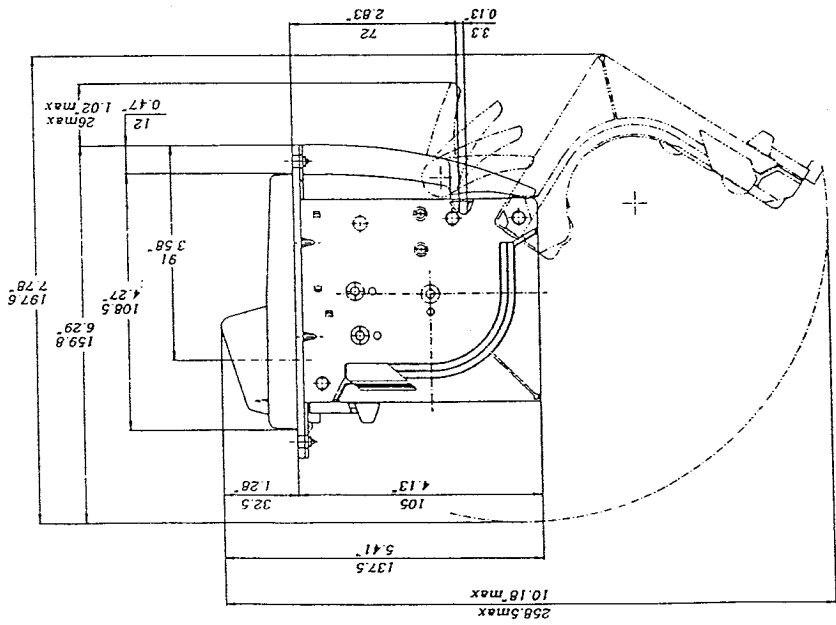
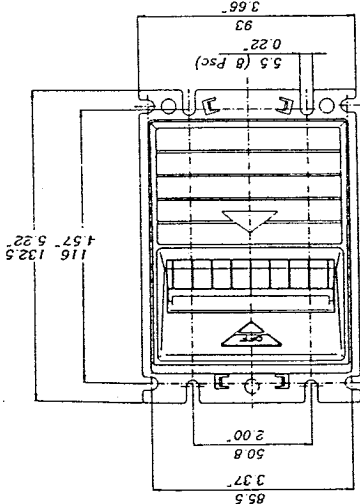

SMX-USA-001

BILL VALIDATOR

(US \$1 only)

User's Guide

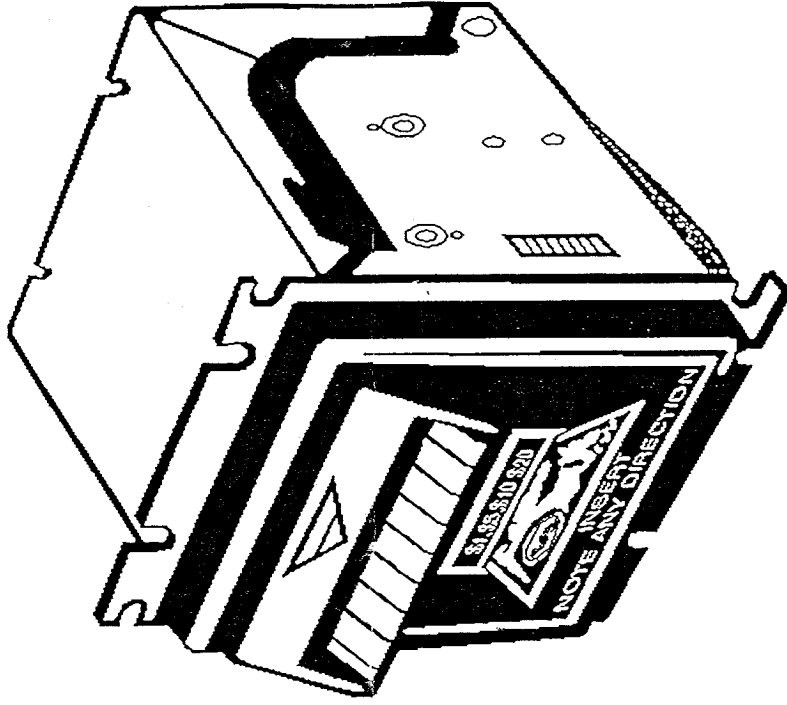

Tel.

(905) 669-2274

Fax:

1-800-584-2633

(905) 669-2633

1-800-593-2633

CashCode Company Inc.
3-390 Edgeley Blvd.
Concord, Ontario
Canada L4K 3Z6

DIP Switch Settings

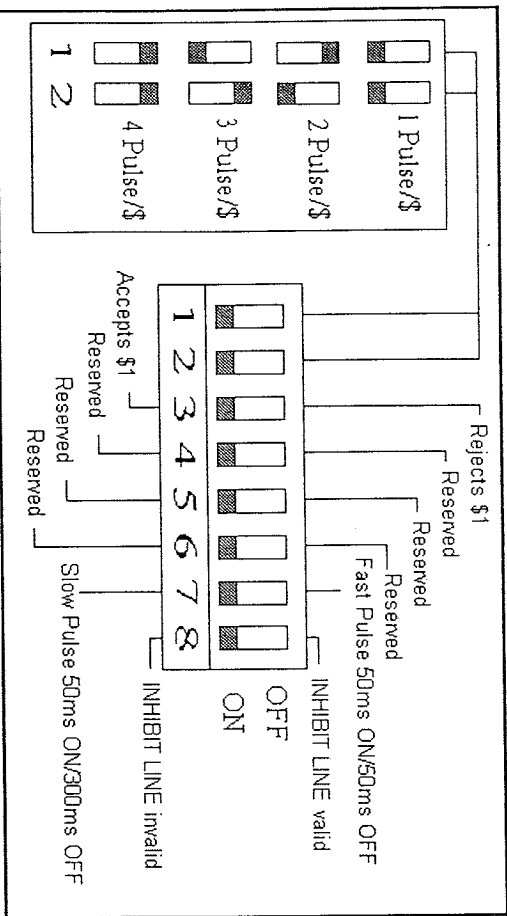

1. ISOLATED PULSE INTERFACE (INHIBIT LINE feature disabled)

1. Set DIP Switch 8 to ON position.

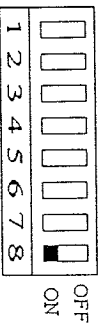

2. Connect bill validator to the machine controller via CashCode's® 6 Pin Power Harness PT# AMZ-XXX-12-06.

The Pulse Output is a bounce free N/O contact and polarity of output wiring does not matter.

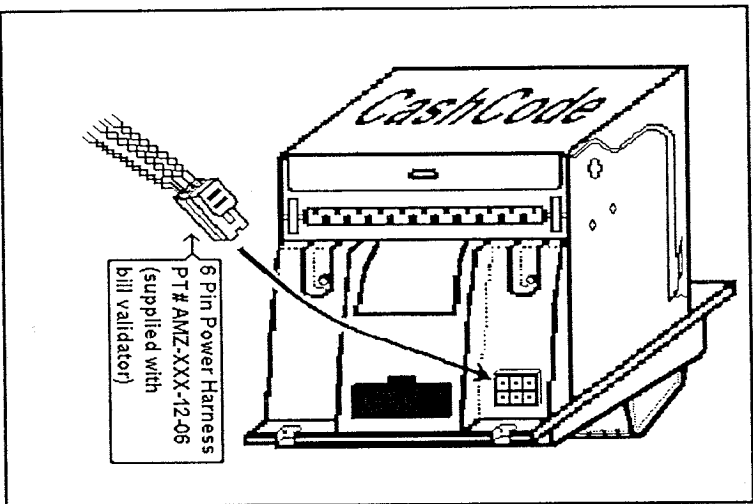
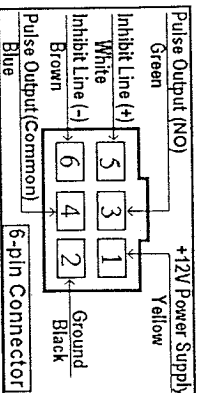

2. ISOLATED PULSE INTERFACE (INHIBIT LINE feature enabled)

1. Set DIP Switch 8 to OFF position.

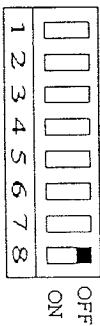

2. Connect bill validator to the machine controller via CashCode's® 6 Pin Power Harness PT# AMZ-XXX-12-06.

The Pulse Output is a bounce free N/O contact and polarity of output connection does not matter.

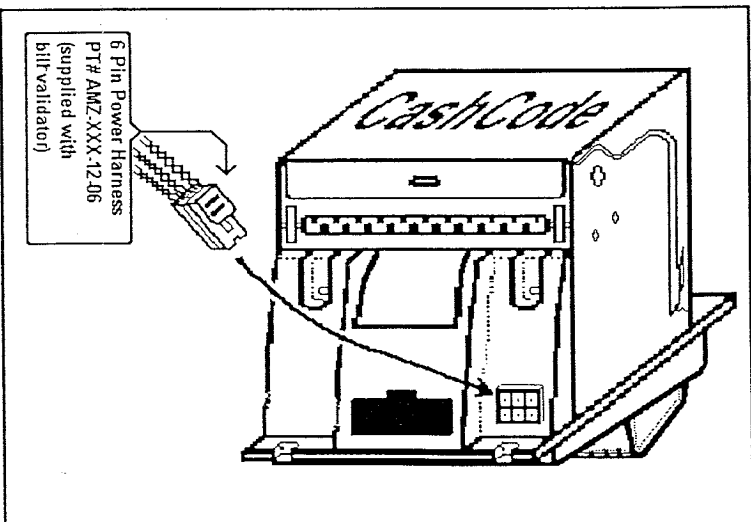
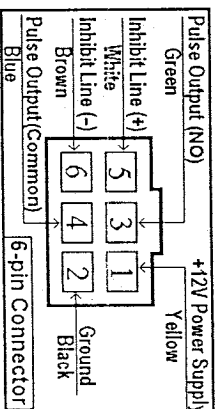

3. Provide wiring of the INHIBIT LINE depending on machine controller lockout circuitry. See Fig. 1, Fig. 2 or Fig. 3 below.

If INHIBIT LINE wires are not connected properly the red light on the front of bill validator goes ON and bill validator will not accept any bank note.

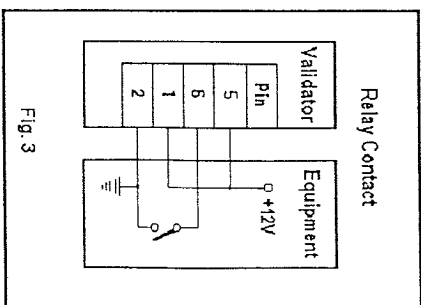
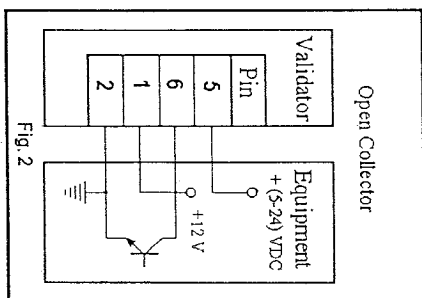
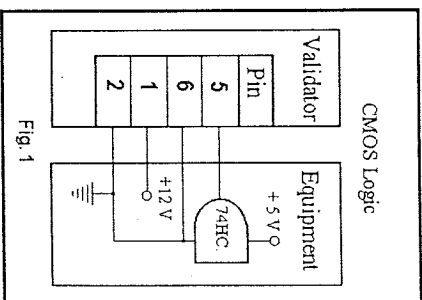

Virtua Fighter 3

Quick Start for Easy Installation

Bring the Projection Television Monitor (PTV) and control Cabinet together, with a distance of 12 inches between them.

Using the wrench provided in the convenience kit, remove the two tamperproof screws on the right side door of the control cabinet, unlock the door and remove.

Remove the two side access panels located on the lower control cabinet base.

Use the hex bolts and washers supplied to secure the game cabinet to the PTV in 4 places.

There are 4 BNC video cables that need to be connected from the VPM buffer board in the game cabinet to the PTV. Observe that proper Red/Green/Blue/Sync connections are made for video.

The PTV has the main power wire that passes through the monitor pedestal to the game cabinet.

Insert this 3 pin male connector into the proper connector on the inner wall.

The PTV power is brought from the game cabinet to the PTV by cable with a 3 pin white connector. Route this cable through the PTV and connect.

Recheck the connections to ensure that no wires are crossed or missing.

Replace side access panels on two sides and replace all hardware and the main side door to the game cabinet.

Plug game power cord into the wall.

Setup is complete if the game is visible on the screen.

Perform assembly checks.

The manufacturers recommended coin setting is setting #18.

Move the machine to the installation position.

Adjust all of the leg adjusters to make contact with the floor. By using a wrench, make adjustments in the height of the leg adjusters to ensure that the machine is level.

After making adjustments, fasten the leg adjuster nut upwards to secure the height of the leg adjuster. To test game settings, press the test button located on the service panel. Refer to the owners manual for further details.

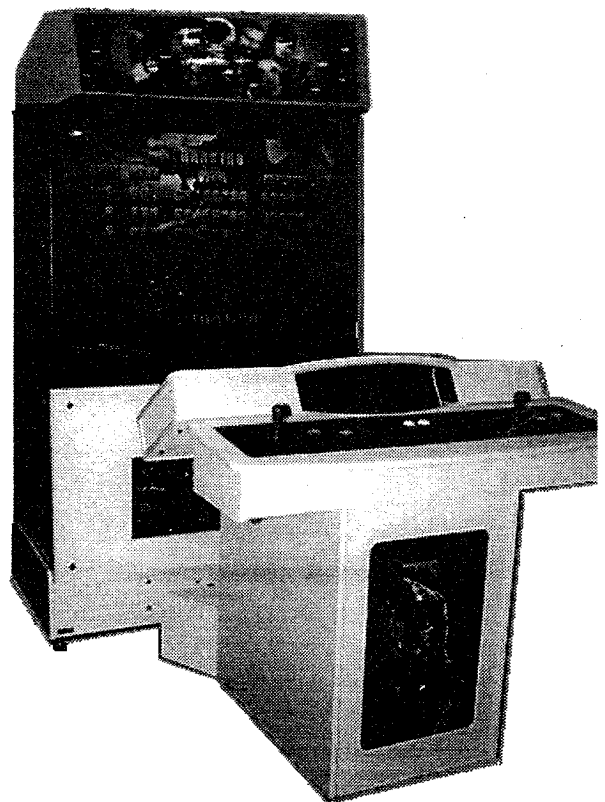

CPU ROM TEST			
0000	(CROM1) BANK	IC. 1	28h
0000	(CROM2) BANK	IC. 2	28h
0000	(CROM3) BANK	IC. 3	28h
0000	(CROM4) BANK	IC. 4	28h
0000	(CROM5) BANK	IC. 5	28h
0000	(CROM6) BANK	IC. 6	28h
0000	(CROM7) BANK	IC. 7	28h
0000	(CROM8) BANK	IC. 8	28h
0000	(CROM9) BANK	IC. 9	28h
0000	(CROM10) BANK	IC. 10	28h
0000	(CROM11) BANK	IC. 11	28h
0000	(CROM12) BANK	IC. 12	28h
0000	(CROM13) BANK	IC. 13	28h
0000	(CROM14) BANK	IC. 14	28h
0000	(CROM15) BANK	IC. 15	28h
0000	(CROM16) BANK	IC. 16	28h
0000	(CROM17) BANK	IC. 17	28h
0000	(CROM18) BANK	IC. 18	28h
0000	(CROM19) BANK	IC. 19	28h
0000	(CROM20) BANK	IC. 20	28h

PRESS TEST BUTTON TO CONTINUE

INPUT TEST		
PLAYER	1P	2P
PUNCH	: OFF	OFF
KICK	: OFF	OFF
GUARD	: OFF	OFF
ESCAPE	: OFF	OFF
UP	: OFF	OFF
DOWN	: OFF	OFF
LEFT	: OFF	OFF
RIGHT	: OFF	OFF
START	: OFF	OFF
COIN CHUTE #1	: OFF	
COIN CHUTE #2	: OFF	
SERVICE	: OFF	
TEST	: OFF	
B SERVICE	: OFF	
B TEST	: OFF	

PRESS SERVICE-TEST BUTTON TO EXIT

1. Memory Test

Selecting the Memory Test on the test mode menu screen causes the on-board memory to be tested automatically. The game board is satisfactory if the display beside each IC number shows GOOD.

2. Input Test

Selecting the Input Test on the test mode menu screen causes the screen (on which each switch is tested) to be displayed. Press each switch. For the coin switch test, insert a coin from the coin inlet with the coin chute door open. If the display beside each switch indicates ON, the switch and wiring connections are satisfactory.

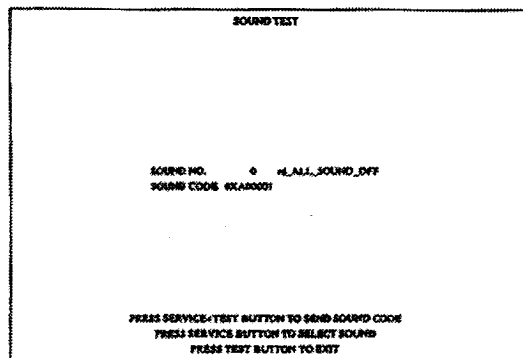
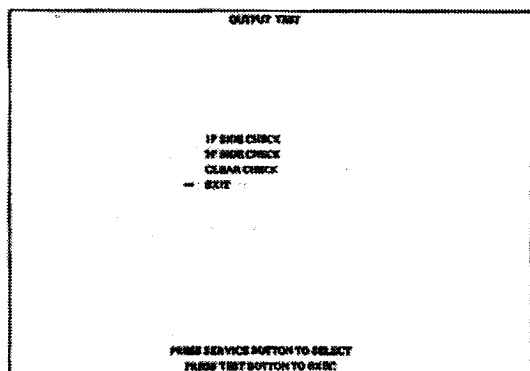

3. Output Test

In the Output Test mode, carry out the lamp test to ascertain that each lamp lights up satisfactorily.

4. Sound Test

In the Test mode, selecting Sound Test causes the screen (on which sound-related board and wiring connections are tested) to be displayed.

Be sure to check if the sound is satisfactorily emitted from each speaker and the sound volume is appropriate.

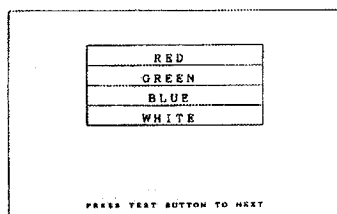

5. C.R.T. Test

In the Test mode menu, selecting C.R.T. Test allows the screen (on which the monitor is tested) to be displayed. Although the monitor adjustments have been made at the time of shipment from the factory, color deviation, etc. may occur due to the effect caused by geomagnetism, the location building's steel frames and other game machines on the periphery. By watching the test mode screen, decide whether an adjustment is needed. If it is necessary, adjust the monitor by referring to the Monitor Adjustments section.

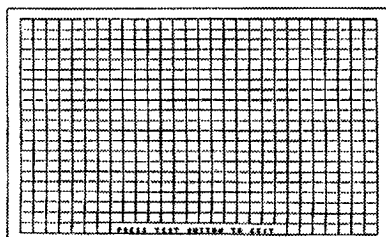

SEGA™

SEGA ENTERPRISES, INC. (USA)

45133 Industrial Drive

Fremont, CA 94538

415-802-1750 Phone

415-802-1754 Fax