

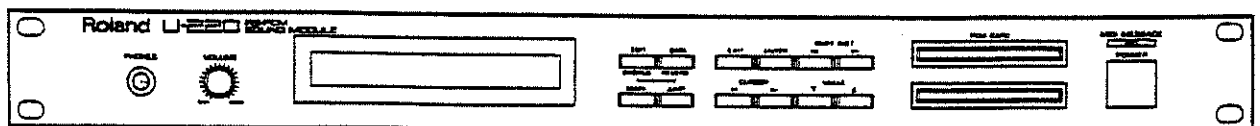

 Roland®

U-220

Owner's Manual



	CAUTION RISK OF ELECTRIC SHOCK DO NOT OPEN	
ATTENTION: RISQUE DE CHOC ELECTRIQUE NE PAS OUVRIE		
CAUTION: TO REDUCE THE RISK OF ELECTRIC SHOCK, DO NOT REMOVE COVER (OR BACK). NO USER-SERVICEABLE PARTS INSIDE. REFER SERVICING TO QUALIFIED SERVICE PERSONNEL.		



The lightning flash with arrowhead symbol, within an equilateral triangle, is intended to alert the user to the presence of un-insulated "dangerous voltage" within the product's enclosure that may be of sufficient magnitude to constitute a risk of electric shock to persons.



The exclamation point within an equilateral triangle is intended to alert the user to the presence of important operating and maintenance (servicing) instructions in the literature accompanying the product.

INSTRUCTIONS PERTAINING TO A RISK OF FIRE, ELECTRIC SHOCK, OR INJURY TO PERSONS.

IMPORTANT SAFETY INSTRUCTIONS

WARNING — When using electric products, basic precautions should always be followed, including the following:

1. Read all the instructions before using the product.
2. Do not use this product near water — for example, near a bathtub, washbowl, kitchen sink, in a wet basement, or near a swimming pool, or the like.
3. This product should be used only with a cart or stand that is recommended by the manufacturer.
4. This product, either alone or in combination with an amplifier and headphones or speakers, may be capable of producing sound levels that could cause permanent hearing loss. Do not operate for a long period of time at a high volume level or at a level that is uncomfortable. If you experience any hearing loss or ringing in the ears, you should consult an audiologist.
5. The product should be located so that its location or position does not interfere with its proper ventilation.
6. The product should be located away from heat sources such as radiators, heat registers, or other products that produce heat.
7. The product should avoid using in where it may be effected by dust.
8. The product should be connected to a power supply only of the type described in the operating instructions or as marked on the product.
9. The power-supply cord of the product should be unplugged from the outlet when left unused for a long period of time.
10. Do not tread on the power-supply cord.
11. Do not pull the cord but hold the plug when unplugging.
12. When setting up with any other instruments, the procedure should be followed in accordance with instruction manual.
13. Care should be taken so that objects do not fall and liquids are not spilled into the enclosure through openings.
14. The product should be serviced by qualified service personnel when:
 - A. The power-supply cord or the plug has been damaged; or
 - B. Objects have fallen, or liquid has been spilled into the product; or
 - C. The product has been exposed to rain; or
 - D. The product does not appear to operate normally or exhibits a marked change in performance; or
 - E. The product has been dropped, or the enclosure damaged.
15. Do not attempt to service the product beyond that described in the user-maintenance instructions. All other servicing should be referred to qualified service personnel.

SAVE THESE INSTRUCTIONS

WARNING: THIS APPARATUS MUST BE EARTHED

For the U.K.

IMPORTANT: THE WIRES IN THIS MAINS LEAD ARE COLOURED IN ACCORDANCE WITH THE FOLLOWING CODE.
GREEN-AND-YELLOW: EARTH, BLUE: NEUTRAL, BROWN: LIVE

As the colours of the wires in the mains lead of this apparatus may not correspond with the coloured markings indentifying the terminals in your plug proceed as follows:

The wire which is coloured GREEN-AND-YELLOW must be connected to the terminal in the plug which is marked by the letter E or by the safety earth symbol  or coloured GREEN or GREEN-AND-YELLOW.

The wire which is coloured BLUE must be connected to the terminal which is marked with the letter N or coloured BLACK.

The wire which is coloured BROWN must be connected to the terminal which is marked with the letter L or coloured RED.

The product which is equipped with a THREE WIRE GROUNDING TYPE AC PLUG must be grounded.

U-220 RS-PCM SOUND MODULE

Owner's Manual

■ Introduction

Thank you for purchasing the U-220 RS-PCM Sound Module. The U-220 contains a RS-PCM digital sound generator that can produce a wide variety of high-quality sounds. To take full advantage of the U-220's features and ensure long and trouble-free enjoyment, please read this manual carefully.

Copyright © 1989 by ROLAND CORPORATION

All rights reserved. No part of this publication may be reproduced in any form without the written permission of ROLAND CORPORATION.

CONTENTS

Listening to ROM Play	5
IMPORTANT NOTES	7
FRONT PANEL AND REAR PANEL	8
Main Features	10
How to use this manual	12

Chapter 1 How to play the sounds

1. Getting ready to play	14
a. Connections	14
b. Turn the power on	15
2. Play the sounds of the U-220	16

Chapter 2 About MIDI

1. How MIDI data is communicated	18
a. Connections	18
b. MIDI Channels	19
2. MIDI data used by the U-220	21

Chapter 3 Introducing the U-220

1. How the sound generator is organized	24
2. Memory structure	25
3. How the sound is output	27
4. How MIDI data is received	29
5. Operation	31
a. Operation Modes	31
b. Operation procedures	32

Chapter 4 Function reference

1. Play Mode	42
2. Edit Mode	45
a. Setup settings	45
Master Tune	46
Effect	46
LCD	46
MIDI	46
Map	49
b. Patch setting	53
Naming	53
Effect	54
Controller	56
Part settings	58
Rhythm Part	63
c. Editing a timbre	64
Naming	65
Tone	65
Level	66
Pitch	68
Vibrato	70
d. Editing a rhythm set	71
Naming	72
Bender	72
Inst	73

3. Data Mode	80
a. Write procedure	80
Patch	82
Timbre	84
Rhythm Set	86
b. Bulk Dump	88
All data	90
Setup data	91
Temporary	92
Memory	92
c. Initialize	93
All data	95
Setup data	95
Temporary	96
Jump Page	96
d. Utility	97
ROM Play	97
MIDI Monitor	97

Chapter 5 Basic Procedures

1. How to adjust the volume	100
2. How to change the output	102
3. How to select patches	104
4. How to change the current sound	105
5. How to change the pitch	107
6. How to add reverb	110
7. How to add chorus	111
8. How to add vibrato	112
9. How to set channels	113
10. How to use a sequencer	114

Chapter 6 Supplementary material

1. Error messages	120
2. Troubleshooting	121
3. Parameter List	123
4. Preset Tone List	126
5. Initialized Settings	130
6. Blank Charts	133

Roland Exclusive Messages	139
MIDI Implementation	143
MIDI Implementation Chart	151
MIDI Flow Chart	153
SPECIFICATIONS	154
INDEX	155

Listening to ROM Play

The U-220 contains two songs which demonstrate its multi-timbral capabilities. The ROM Play function is used to play these songs.

To listen to the ROM play demonstration and also to take full advantage of the multi-timbral functions, we recommend that you connect the U-220 to a stereo amplifier or listen through headphones.

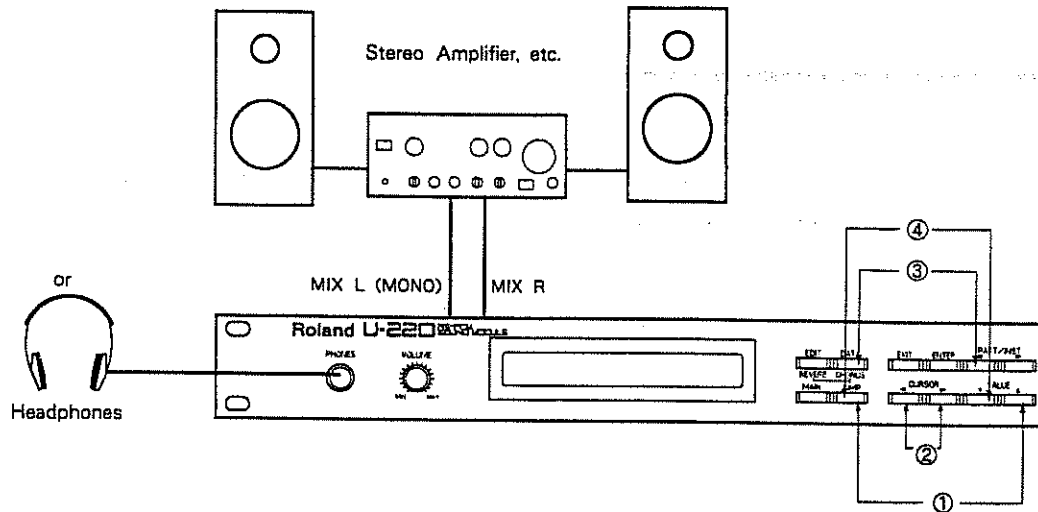

[Procedure]

- ① While holding **JUMP** press **VALUE** **(Δ)**.

```
Data/Util/ROM Play : Stop
Song #1 HIGHLANDER
```

- ② Use **◀** **CURSOR** **▶** to select a song.

# 1	HIGHLANDER	Music by Marvin Sanders Copyright © 1989, Marvin Sanders
# 2	U MIGHT BE THE 1	Music by Eric Persing Copyright © 1989, Eric Persing Music

- ③ To start the song press **ENTER** (or **VALUE** **(Δ)**).

To stop the song press **EXIT** (or **VALUE** **(▽)**).

Use the **VOLUME** knob to regulate volume. It is often convenient to hear the ROM Play demonstration while making connections or adjusting the volume.

* If you start playback without selecting a song, songs 1—2 will continue repeating. If you specify song 2 and start playback, song 1 will begin when song 2 ends. Then songs 1 and 2 will continue playing.

- ④ To return to the normal display press **EXIT** three times.
(or hold **JUMP** and press **VALUE** **(▽)**.)

《Notes on ROM Play》

If you want to use the **VOLUME** knob to adjust the volume, set the rear panel **FIXED / VARIABLE** switch to "**VARIABLE**". Turn the U-220 power off before changing the switch setting.

The ROM Play data is not transmitted from **MIDI OUT**.

Messages from **MIDI IN** will not be received during ROM Play.

You will need a MIDI sequencer if you want to use the U-220 to create an ensemble performance like the ROM Play demonstration.

● Biographies of ROM demo's Composers

MARVIN SANDERS

Marvin Sanders is an accomplished composer / keyboardist and authority on creative sequencing applications. An active musical director and composer for film, television, and theatre, he lives in Los Angeles where his talents are utilized in studios and live performance. As a product specialist and clinician for the Roland Corporations have included the "Cityslicker" ROM demo in the D-5, and programming for the TN-Series Style Cards.

ERIC PERSING

Eric Persing is one of the most in-demand session players and programmers in the Los Angeles area. Eric began working for Roland as a product specialist, first doing clinics and support, then gradually became more involved in product and sound design. Eric has worked with such artists as Michel Jackson, Denise Williams, Lionel Richie, Larry Carlton, and REO Speedwagon. His music and sounds can also be heard on many TV shows and commercials. Actively involved in film music, he has worked with top composers including Michel Coulumbier, Danny Elfman, and Bill Conti.

IMPORTANT NOTES

In addition to the items listed under Safety Precautions, on page 2, we request that you please read and adhere to the following.

Concerning the power supply

- Whenever you make any connections with other devices, always turn off the power to all equipment first. This will help in preventing malfunction, and damage to speakers.
- Do not force the unit to share the same power outlet as one used for distortion producing devices (such as motors, variable lighting devices). Be sure to use a separate power outlet.

Concerning placement

- Placing the unit near power amplifiers or other equipment containing large transformers may induce hum.
- Should the unit be operated nearby television or radio receivers, TV pictures may show signs of interference, and static might be heard on radios. In such cases, move the unit out of proximity with such devices.

Maintenance

- For everyday cleaning, wipe the unit with a soft dry cloth, or one that is dampened slightly. To remove dirt that is more stubborn, wipe using a mild, neutral detergent. Afterwards, make sure to wipe thoroughly with a soft cloth.
- Never apply benzene, thinners, alcohol or any like agents, to avoid the risk of discoloration and deformation.

Other Precautions

- Never apply strong pressure to the display, or strike it in any way.
- A certain small amount of heat will be radiated from the unit, and thus should not be considered abnormal.
- Before using the unit in a foreign country, check first with your local Roland Service Station.

Concerning memory backup

- Within the unit is contained a battery which serves in maintaining the contents of memory while the main power is off. The normal life of this battery is 5 years or more, but it is strongly recommended that you change it every 5 years as a rule. When it is time to change the battery, contact a Roland Service Station.
- * The first time you need to change the battery could occur before 5 years have passed.

- When the battery gets weak the following will appear in the display. By this time, it is possible that the contents of memory have already been lost.

“Internal Battery Low”

- Please be aware that the contents of memory may at times be lost; when sent for repairs or when by some chance a malfunction has occurred. Important data should be written down on paper. During repairs, due care is taken to avoid the loss of data, however, in certain cases, such as when circuitry related to memory itself is out of order, we regret that it may be impossible to restore the data.

《Front Panel》

1 Power switch

This switch turns the power on/off.

2 MIDI message indicator

This indicator lights when a MIDI message is received.







3 PCM card slot

Separately sold sound library cards (SN-U110 series) can be inserted into this slot.

4 Part/Rhythm instrument select buttons

Use these buttons to select parts 1—6 in play mode or when editing.

5 Value buttons

These buttons are used to change setting values. The value will decrease each time you press , and will increase each time you press . If you continue pressing a button the value will increase continuously. If you press  () while holding  () the value will change more rapidly.

6 Enter button

This button is used mainly to specify a menu item from a menu display in edit mode or data mode.

7 Exit button

This button is used to return to the previous higher level in editing mode or data mode. (This button moves in the opposite direction of )

8 Cursor buttons

In edit mode or data mode, use these buttons to move the blinking cursor to select menu items or parameters. In play mode use these buttons to select displays.

9 Data (reverb) button

Press this button to enter Data mode, where you can store edited settings or transmit data. If you press this button after pressing Jump button you will move to the reverb display.

10 Edit (chorus) button

Press this button to enter Edit mode, where you can edit (modify) the settings of a patch or sound. If you press this button after pressing Jump button you will move to the chorus display.

11 Jump button

Use this button to jump to a specific display.

12 Mark button

Use this button to memorize the display to which you want to Jump.

13 Display

This shows the various settings and parameter values.

14 Volume knob

This adjusts the overall volume that is output from the Mix Out jacks and the Phones jack. (This knob is effective only when the Fixed/Variable switch is set to Variable.)

15 Phones jack

A set of headphones can be connected to this jack. Use stereo headphones of impedance 8—150 ohms. Sound will appear at the output jacks regardless of whether the Phones jack is being used.

《Rear Panel》

16 MIDI connectors

Use these connectors to connect other MIDI devices.

17 Direct out 1, 2 jacks

The direct sound without the effect will be output in stereo from these jacks.

* When the U-220 is shipped, the direct outputs are turned off.

18 Mix out jacks

The sound of each part processed through the effect will be output in stereo from these jacks. For normal use, connect these jacks to your amp/speaker system.

19 Fixed/Variable switch

This switch determines whether or not the front panel Volume knob will adjust the volume of the sound from the Mix Out outputs.

When set to Fixed the volume will be at maximum regardless of the setting of the Volume knob.

When set to Variable the Volume knob will regulate the volume.

* Turn the power off before changing the setting of this switch.

Main Features

High quality RS-PCM sound generator

RS-PCM stands for ReSynthesized Pulse Code Modulation. PCM is a method of digitally recording a waveform. However simply recording and playing back the sound of an instrument is not enough to create a truly musical sound.

RS-PCM sound generation uses Roland's advanced signal processing technology to process and resynthesize musical sounds recorded by PCM, to create realistic and playable musical sounds.

The U-220 contains 128 high quality instrumental sounds ranging from piano and other sounds appropriate for a classical or jazz ensemble, to the synthesizer sounds of rock and fusion. Various parameters (aspects of the sound) such as pitch and level can be adjusted for each Tone (sound) to allow you detailed control over timbral nuances.

Tones from a separately sold PCM card (sound library SN-U110 series) can be used in addition to the tones built into the U-220.

Multi timbral sound generator

The U-220 contains a multi-timbral sound generator that can simultaneously produce 6 parts and a rhythm part. The sounds (timbres) and effects of each part can be stored in 64 different settings as patches. When using a MIDI sequencer, this allows a single U-220 to produce all the instrumental sounds of an entire ensemble. Tone assignments and settings for the rhythm part can be stored as one of four rhythm setups. You can select any one of these four to use as the rhythm part.

Multi outputs

The U-220 has three sets of stereo output; Mix Out, Direct Out 1, and Direct Out 2. These output can also be used as multiple outputs. Each sound can be sent from its own output terminal, allowing you to use an external mixer and effect units to mix and process each sound independently.

Voice reserve

The U-220 can produce up to 30 voices at once. The voice reserve settings allow you to specify how many voices will be used by each part.

Built-in digital effect

The U-220 includes a built in digital reverb/chorus effect unit, providing a spacious feeling of stereo depth. Each sound patch can be given its own effect settings.

Jump function

The jump function allows you to instantly jump (move) to a specified display. In addition to the pre-defined jump destinations, you may also define your own. Using the jump function allows you to edit more efficiently.

Map function

The U-220 allows you to create a **Program Change Number map** that specifies which sound will be selected by each incoming MIDI program change. Patches, timbres, rhythm sets, and rhythm instruments each have four maps.

How to use this manual

This manual is organized into the following chapters. Read each chapter as necessary.

Chapter 1 How to play the sounds This explains how to connect the U-220 to external devices (how to prepare for playing) and how to hear the sounds.

Chapter 2 About MIDI This explains the basics of MIDI that you will need to know in order to use the U-220.

Chapter 3 Introducing the U-220 This explains how the U-220 is organized, how to view the displays, and basic operation. In order to take full advantage of the U-220 please be sure to read this chapter.



Chapter 4 Function reference This explains the functions for each level of the U-220.

Chapter 5 Basic procedures This explains basic procedures for various operations. Refer to this chapter when you want to create your own sounds or use the performance functions.

Chapter 6 Supplementary materials This contains parameter lists, an explanation of the error messages, and help for troubleshooting.

Front panel buttons in the text

In this manual, front panel buttons are referred to by the name printed above (or below) each button.

(Example) Edit button → 
Cursor button → 

Chapter 1 How to play the sounds

In chapter 1 we will explain how to connect the U-220 to external devices (getting ready to play) and how to hear the sounds.

1. Getting ready to play

a. Connections

Connect the rear panel MIX OUT jacks to the input jacks of a keyboard amp or mixer. When playing in stereo, use the L and R jacks. When playing in mono, use only the L (MONO) jack. Before making connections, make sure that the power switches of the U-220 and the amp are off. When using headphones, insert the headphone plug into the PHONES jack.

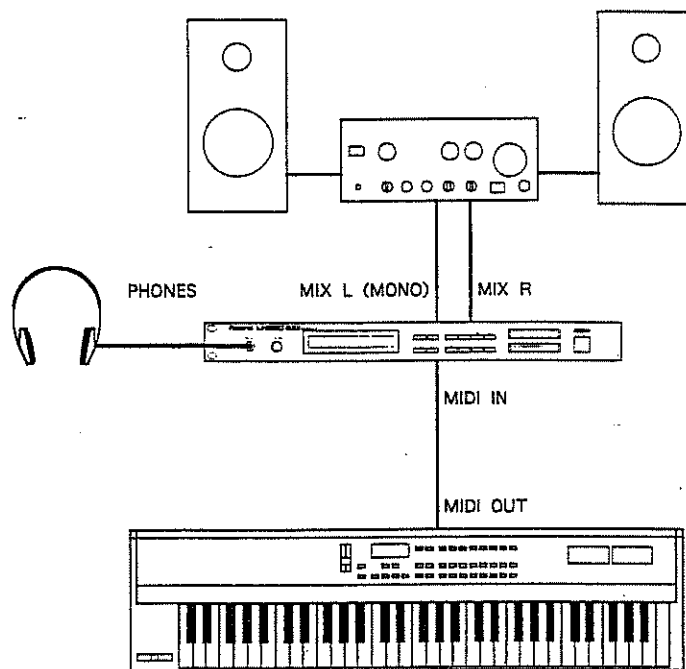

- * The U-220 does not contain a built-in power amp or speaker, and will not make sound by itself unless you use headphones.
- * When shipped, the U-220 is set so that no sound appears at the DIRECT OUT jacks.
- * If you connect the U-220 directly to a stereo system, be careful of the output level. Excessively high levels can damage the speakers of your stereo system.
- * To take full advantage of the U-220, we recommend that you play it in stereo.

b. Turn the power on

【Procedure】

① Check that connections for power and external equipment (amplifiers, etc.) are correct.

② Turn the power switch of the U-220 on.

The following message will be briefly displayed.

```
RS-PCM Sound Module  
Roland U-220
```

Then the patch name will be displayed.

```
P-01: Acoust Piano [001]  
RX 10110110110110110
```

③ Turn on the power of the external equipment (amplifiers, etc.).

Now you are ready to play.

* After the power is turned on, the U-220's protection circuit inserts a short delay before beginning to operate.

2. Play the sounds of the U-220

Here's how to play the factory preset sounds of the U-220.

* Set your keyboard to transmit channel 1.

- ① Get the display that appears immediately after the power is turned on.
(We will call this the *Play display*.)

```
P-01: Acoust Piano [001]
RX |01|01|01|01|01|01|10
```

If the display is different press **EXIT** several times.

- ② Use **▽** VALUE **△** to select P-01—P-64 while playing the keyboard.

```
P-04: Bright EP [004]
RX |01|02|03|04|05|06|10
```

The sounds that you are selecting in step ② are called *Patches*.
The following chapter “Introducing the U-220” will explain more about patches.

- ③ Press PART/INST **▶**.

```
P-04: Bright EP [004]
RX |01|02|03|04|05|06|10
```

- ④ Press **▽** VALUE **△** to select T-001—T-128 while playing the keyboard.

```
T-030: Slap 1 [030]
RX |01|01|01|01|01|01|10
```

The sounds you are selecting in step ④ are called *Timbres*. The following chapter
“Introducing the U-220” will explain more about timbres.

Chapter 2 About MIDI

This chapter explains the basic concepts of MIDI that you will need to know when using the U-220.

1. How MIDI data is communicated

MIDI (Musical Instrument Digital Interface) is a world-wide standard for exchanging musical data such as performances and sounds. If a device has MIDI, it can be connected to another MIDI device (even of a different type or manufacturer) to exchange musical data.

MIDI transmits various types of musical data such as data indicating that a key has been pressed or released, or that a controller has been moved. When you play a MIDI-equipped instrument, it will transmit MIDI data to indicate the performance gestures. Another MIDI device that receives this data will produce sound just as though it were the instrument being played.

This section explains how MIDI data is transmitted and received.

a. Connections

MIDI-equipped devices usually have three jacks; IN, OUT, and THRU. Use a MIDI cable to connect these jacks to the other devices in your system.

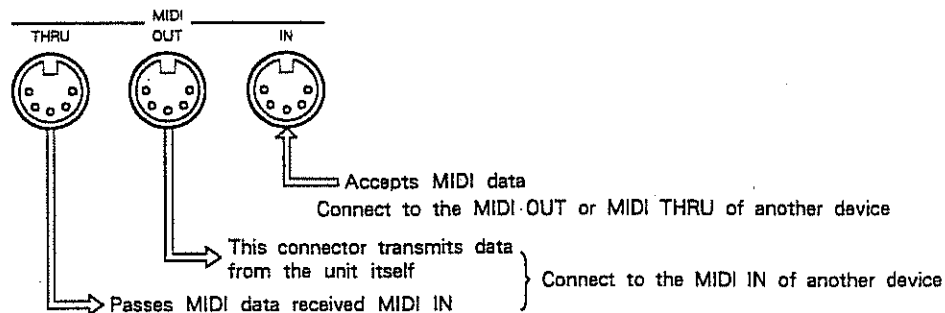

Controlling the U-220 from another device

When using a sequencer or MIDI keyboard to control the U-220 make connections as follows.

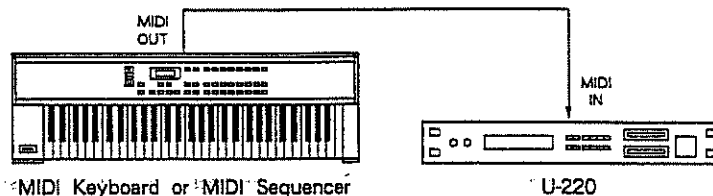

Using MIDI THRU

MIDI THRU can be used to send the same stream of data to two or more devices.

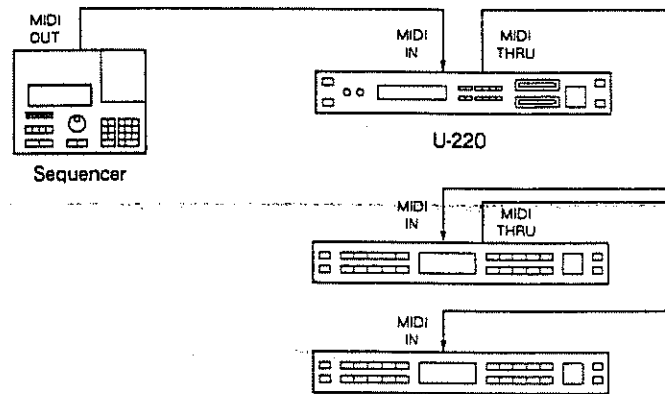

* It is theoretically possible to use MIDI THRU to connect any number of devices. However three is about the practical limit. Running a MIDI signal through many THRU's can garble the transmitted data. If you need to connect more than three devices please use a MIDI Thru Box.

b. MIDI Channels

MIDI uses "channels" to transmit data independently to multiple devices over a single cable. You can think of MIDI channels as being similar to television channels. You can switch channels on a television receiver to receive many different broadcasts. When the channel of the receiver matches the channel of the transmitter, the data of that channel is received.

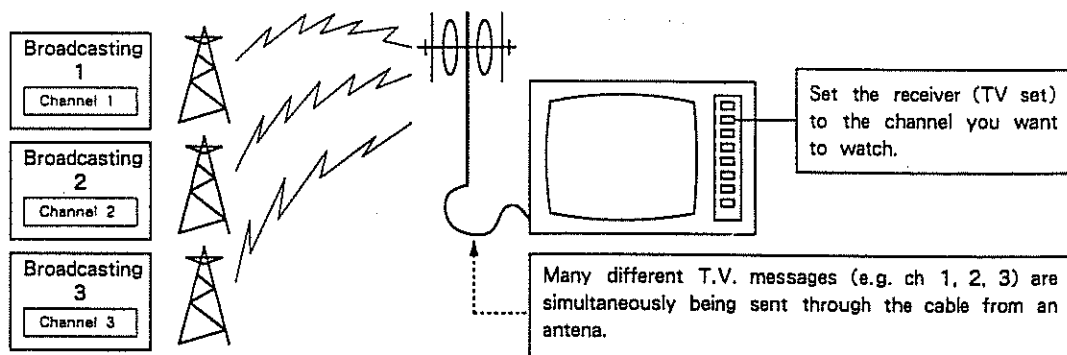

MIDI has sixteen channels, numbered 1—16. When the MIDI channel of the receiving device matches the MIDI channel of the transmitting device, the data will be received and the receiving device will produce the appropriate sound.

.How MIDI data is communicated

Sounds

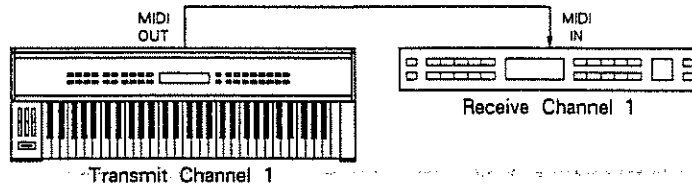

Does not sound

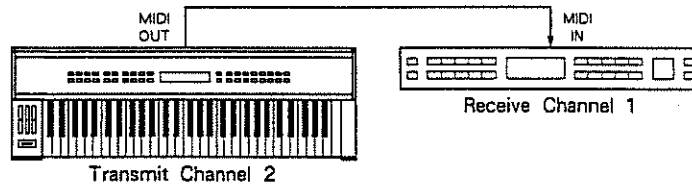

only Sound Module B sounds

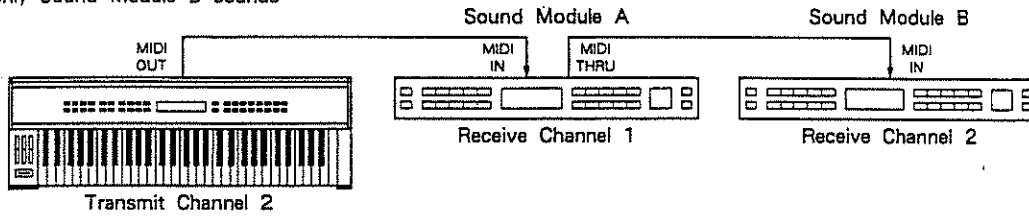

2. MIDI data used by the U-220

MIDI transmits data using various types of Message. The following types of MIDI message are used by the U-220.

Channel Voice Messages	Note Data Program Change Control Change Pitch Bender Aftertouch
System Messages	Exclusive Messages etc.

Channel voice messages

Channel voice messages are transmitted and received on a specific MIDI channel. These messages include basic types of musical data.

Note: data from the keyboard

Note messages tell how the keyboard is being played. These messages indicate which key (the note number) was played, and how strongly (the velocity).

Similar messages are transmitted when a key is released. For the U-220's rhythm part and for most other rhythm machines, each note number will play a different rhythm sound.

Program change: data that selects sounds

Program change messages are used mainly to select sounds. The U-220 uses program change messages to select patches, timbres, and rhythm setups. Devices made by different manufacturers will respond in different ways to program change messages. Check the manuals for your equipment.

Control change: data for musical expression

Control change messages are used to control musical expressions such as vibrato, hold, volume, and pan. Devices made by different manufacturers may transmit and receive different types of control change message, and respond in different ways to these messages. Consult the MIDI implementation charts of your equipment to see which control change messages are transmitted and received.

Pitch bend Change: data for pitch change

The pitch bender lever found on many keyboards only transmits the position of the lever. The actual pitch change (bend range) will depend on the settings of the U-220. The pitch bend range can be set for each timbre of the U-220.

Aftertouch

The aftertouch data transmitted by many keyboards transmits the force with which you press down on the keyboard after playing a note. The effect this will have will depend on the settings of the U-220. Aftertouch is divided into "channel aftertouch" and "polyphonic aftertouch". Channel aftertouch transmits a single aftertouch value telling the pressure of the key being pressed most strongly, and affects all notes on the MIDI channel. Polyphonic aftertouch transmits an aftertouch value for each key (note), telling how strongly each key is being pressed. This allows you to affect individual notes within a single MIDI channel.

The U-220's sound generator can respond to both types of aftertouch.

System messages

System messages contain data that control all devices in an entire MIDI system, and are received by devices regardless of their channel number setting. In addition to exclusive messages (explained below), system messages include various types of message used by sequencers, and other messages that help to keep a MIDI system running properly.

Exclusive messages

Exclusive messages contain data unique to each device, such as sound data. Normally these messages are transmitted and received only between devices of the same type made by the same manufacturer. For example exclusive messages can be used to transmit sound data to another U-220, or to store sound data in a sequencer.

■ About the MIDI Implementation Chart

MIDI is able to transmit and receive data between various types of device, but not all devices are able to transmit and receive the same types of data. The owner's Manual of each MIDI device has a "MIDI Implementation Chart" which shows the types of data that the device is able to transmit and receive. (see page 151.)

All Implementation Charts are a standard size, so that you can place two charts side by side to see how two devices will be able to communicate with each other.

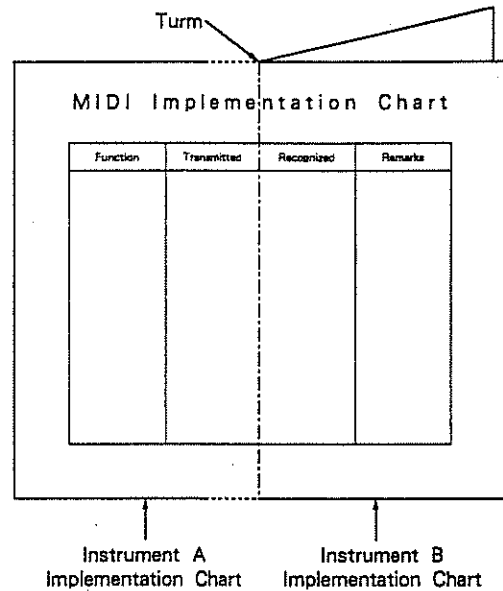

Chapter 3 Introducing the U-220

This chapter explains how the U-220 is organized, how to view the displays, and basic operation. In order to take full advantage of the U-220 please be sure to read this chapter.

1. How the sound generator is organized

The U-220 is organized into the following memories.

- **Tone**

A tone is a basic sound which is used in a Timbre or a Rhythm Set. The internal memory of the U-220 contains 128 tones, but an optional PCM card can be inserted to provide additional tones.
- **Timbres**

Timbres are the basic unit of sound which you will play. A tone is the basic element of each timbre. Each timbre also contains settings which determine the pitch, vibrato, and level of the Tone. 128 timbres can be created (see page 64).
- **Rhythm Set**

A Rhythm Set is a combination of drum sounds and settings to determine how each drum sound will be played. As with timbres, tones are the basic elements from which a rhythm set is made. 4 rhythm sets can be created (see page 71).
- **Part**

The U-220 has 6 parts and a rhythm part. Each part has its own MIDI channel, and can be used as an independent sound generator module. Each part 1—6 has a timbre assigned to it, and a rhythm set can be assigned to the rhythm part.
- **Patch**

A Patch consists of settings which determine the rhythm set or timbre assigned to each part, how the parts will be sounded, and settings for chorus or reverb. 64 sound patches can be created. (see page 53.)

Patches can be set in a variety of ways depending on how you are using the U-220. For example if you are creating an ensemble using just the U-220 alone, you can set each part to act as an independent sound generator. Or if you are using the U-220 as a single tone generator you can create a single sound using several parts (timbres).

More about tones

- **Types of tone and simultaneous polyphony**

The U-220 can produce up to 30 notes (voices) at once, but this will depend on the type of tones being used. Tones which consist of a single voice can play up to 30 notes. Tones which consist of two voices can play up to 15 notes. (see page 65.)

- **Pitch range**

Each tone has an upper limit beyond which it cannot produce sound. Each acoustic instrument has a different sound-producing range, and the sound-producing ranges of the U-220's sounds are based on these ranges.

2. Memory structure

The U-220 can be used in a variety of ways depending on the settings of various parameters. The settings of these parameters are stored in various Memories. The memories are divided by function and use into the following areas; *setup area*, *memory area*, *temporary area*, and *tone area*.

● Setup area

The **setup area** stores parameters that affect the entire U-220; master tuning, settings which determine how MIDI data is handled, settings which determine how program change data is handled, etc. Settings in the setup area are preserved even when the power is turned off.

● Memory area

The **memory area** stores 64 patches, 128 timbres, and 4 rhythm sets. Settings in the memory are preserved even when the power is turned off.

● Temporary area

The **temporary area** is where you modify the settings of patches, timbres, or rhythm sets. When you select a patch etc., the settings in the memory area are called into the temporary area. Settings in the temporary area are temporary, and will be lost when you select another patch etc.

● Tone area

A **tone** is the basic element of sound (wave data) from which a timbre or rhythm set is created. The U-220 contains 128 tones. Tones in a PCM card are also handled as part of the tone area data. It is not possible to change tone settings.

When you play the U-220, the settings in the setup area and the current settings in the temporary area will determine how the U-220 sounds. When you select a patch, the settings of that patch and the timbre and rhythm set settings specified by that patch will be read into the temporary area from the memory area. When you select a timbre the specified part will be read. When you select a rhythm set, the rhythm part will be read.

* When we say that data from the memory area is "read" into the temporary area, we mean that the settings of the memory area are copied into the temporary area.

The important thing to remember is that when you modify the settings of a patch, timbre, or rhythm set, you are modifying the settings of the temporary area, not the settings of the memory area. Settings in the temporary area are only temporary. When you select another patch or timbre these new settings will be read into the temporary area, and your previous changes will be lost.

If you want to keep the changes you make in the temporary area you must use the Write operation to write the settings into the memory area.

When making settings, be sure to remember how the memories are related.

Data is transferred inside the U-220 as shown in the following diagram.

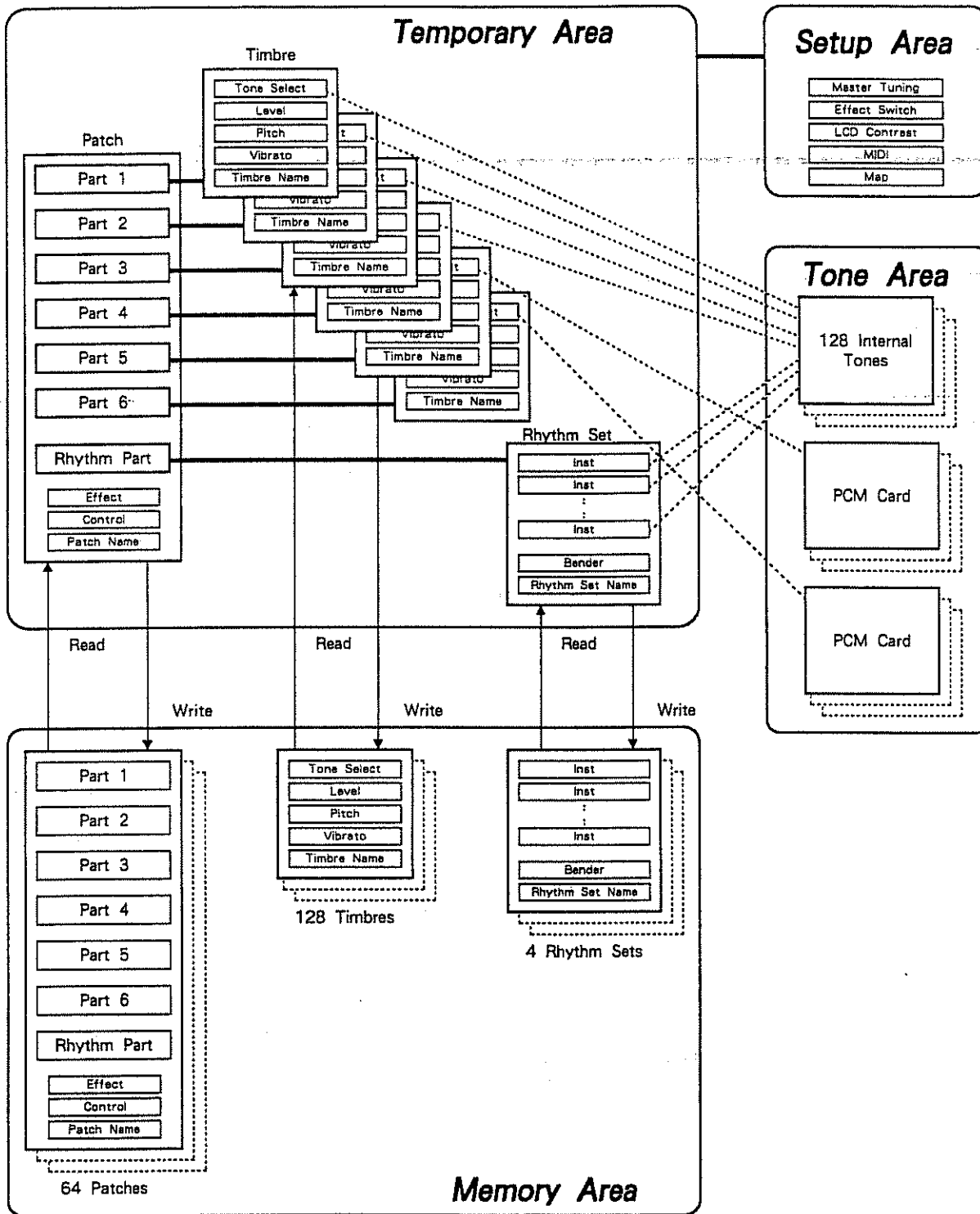

3. How the sound is output

The U-220 has three pairs of stereo output jacks. When the U-220 is shipped it is set so that sound is not output from the MIX OUT jacks, but you can set these as required by your musical needs.

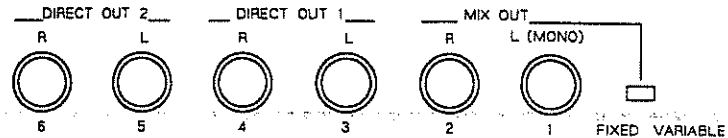

Each part 1—6 can be set to send its sound from any output jack (page 61).

For the rhythm part, you can specify the output for each rhythm sound in the rhythm set (see page 79).

Patch					
Part 1	Part 2	Part 3	Part 4	Part 5	Part 6
MIX OUT	MIX OUT	MIX OUT	MIX OUT	MIX OUT	MIX OUT
DIRECT OUT 1	DIRECT OUT 1	DIRECT OUT 1	DIRECT OUT 1	DIRECT OUT 1	DIRECT OUT 1
DIRECT OUT 2	DIRECT OUT 2	DIRECT OUT 2	DIRECT OUT 2	DIRECT OUT 2	DIRECT OUT 2

Rhythm Set		
Bass Drum	Rim Shot	Ride Cymbal
MIX OUT	MIX OUT	MIX OUT
DIRECT OUT 1	DIRECT OUT 1	DIRECT OUT 1

- The chorus/reverb effect is applied to the sound from the MIX OUT jacks. The rear panel Fixed/Variable switch determines whether or not the front panel Volume knob will regulate the volume. If you want to use the front panel Volume knob to regulate the volume then set the switch to Variable. If you want the sound to be output at a fixed level regardless of the position of the Volume knob then set the switch to Fixed. When using a mixer to adjust the volume, set the switch to Fixed.

- The chorus/reverb effect is not applied to the sound from the DIRECT OUT 1/2 jacks. The volume will always be at a fixed level regardless of the Volume knob.

* Even if you specify that the sound be output from the Direct Out jacks, the sound will be output from the Mix Out jacks (without the effect) if the Direct Out jacks are not used. (The volume can be adjusted by the Volume knob.)

3.How the sound is output

● In addition to the output jack selection, each part has its own pan setting to determine the stereo position (page 62). Each rhythm sound in a rhythm set has its own pan setting (page 79). By setting the output selection and pan of each part as shown in the following diagram, you can send the sound of each part from its own output jack.

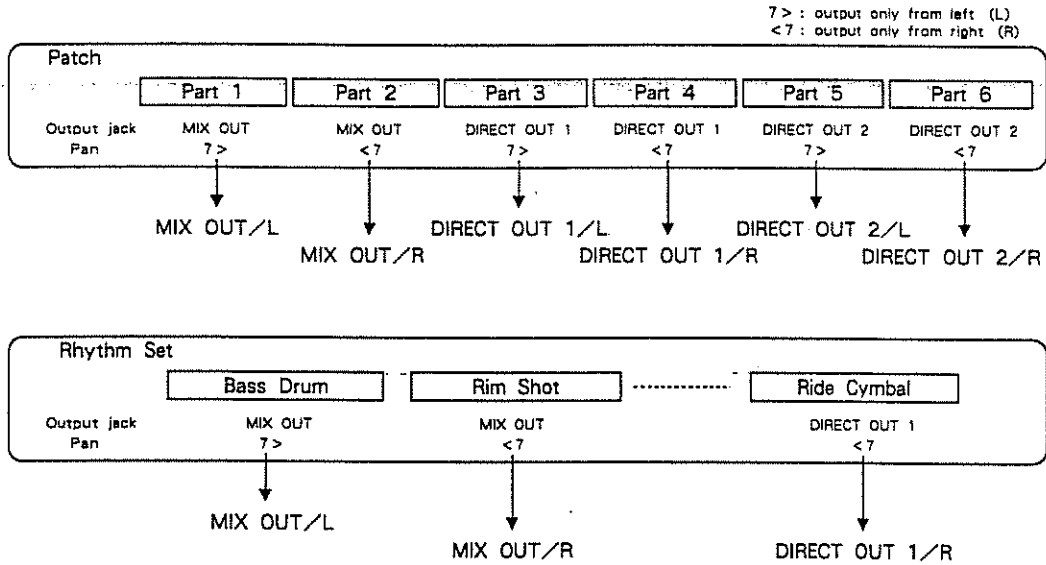

4. How MIDI data is received

The following diagram shows how the U-220 receives MIDI data.

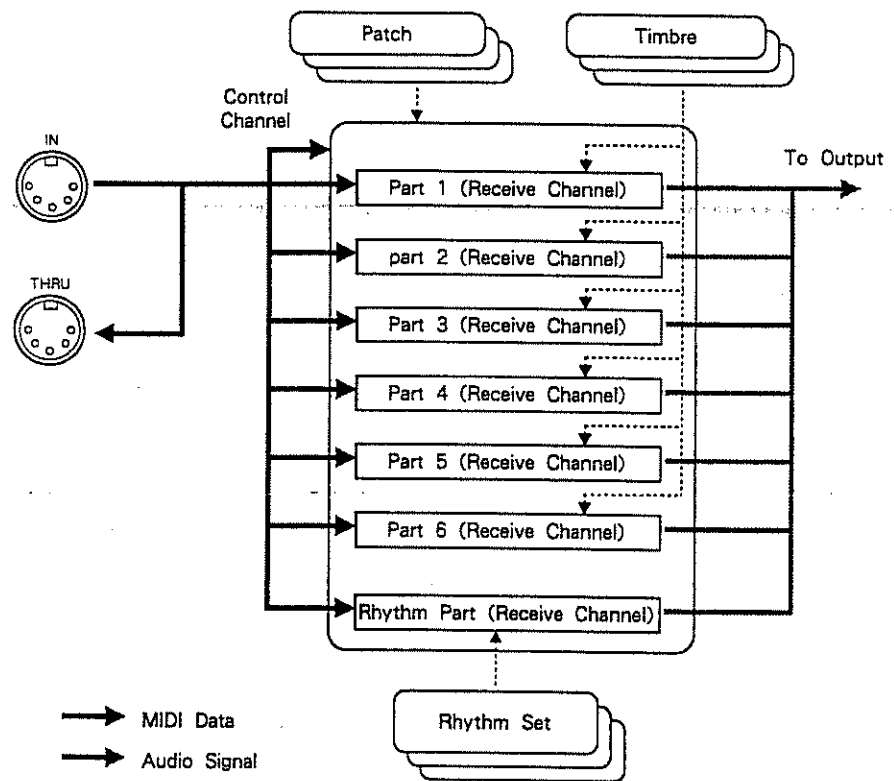

● Each part receives MIDI data on its own MIDI channel (page 19). For example when part 1 receives note data, it will sound using the timbre assigned to part 1. Program change data can select timbres or rhythm sets. In addition, control change data can affect the sound of timbres in other ways.

● In addition to the MIDI channel for each part, there is a Control Channel (page 46) for selecting the patch. On the control channel, program changes can select patches, and control change data can adjust the settings of the effect unit.

Program change data The U-220 can receive program change data to select the following.

Data selected by program change	
Control Channel	Patch
MIDI channels of parts 1—6	Timbre
MIDI channels of Rhythm part 1—6	Rhythm Set

Each incoming program change can select the patch / timbre / rhythm set shown in the following table. You can change these assignments if you wish.

Patch Number	Program Change Number
P-01—64	1—64
Timbre Number	Program Change Number
T-001—128	1—128
Rhythm Set Number	Program Change Number
R-1—4	1—4

A set of correspondences between program numbers and memories is called a Map.

You can create four maps of your own for each type of memory. By arranging program numbers in the order of their use in a live performance, you will be able to select the right sound for each song using consecutive program changes. For details refer to “Function reference” (page 49).

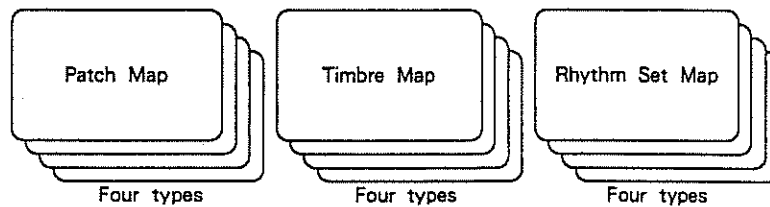

Control change data

The U-220 receives control change data to control modulation, volume, pan, etc. In addition, you can adjust the settings of a specified parameter using control change data. Each patch has settings which specify which parameter will be regulated by which controller. For details refer to “Function reference” (page 56).

5. Operation

This section will explain how the U-220's operations are organized. The following chapter "Function reference" will explain how to modify each type of parameter, but this section will help you understand the overall flow of operation.

a. Operation modes

The many operations of the U-220 are grouped in the following three modes.

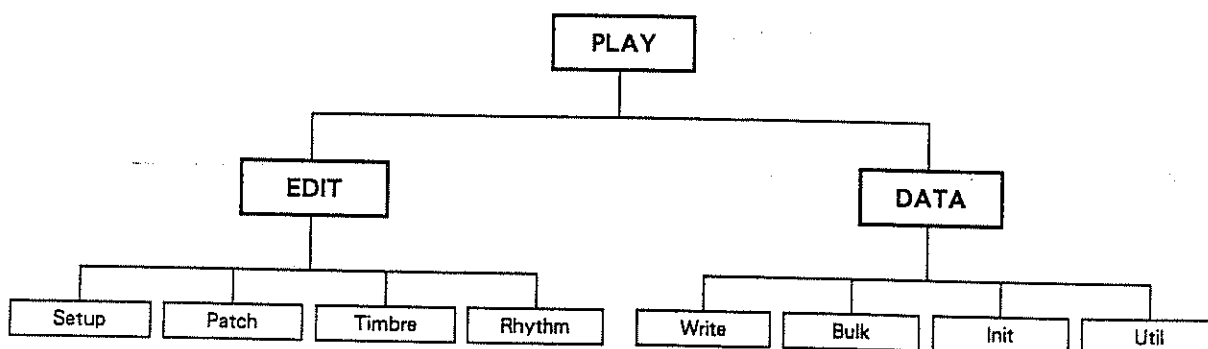

Play mode (page 42)

You will normally play the U-220 in play mode. You can also check patch settings and part settings.

Edit mode (page 45)

In edit mode you can edit (adjust or modify) the various control settings and sound (patch/timbre/rhythm set) settings. Editing always affects the temporary area, and your edited settings are temporary. If you want to store your newly edited settings, you must use a data mode operation to write them into memory.

* Setup settings (edits) directly affect the setup memory, not the temporary area, so the write operation is not necessary.

Data mode (page 80)

In data mode you can write your edited settings into memory, or transmit data via MIDI (bulk dump). In addition, you can initialize settings or monitor the MIDI data being received. You can also listen to the U-220's demo performances.

b. Operation procedures

The various groups of parameters you edit in Edit mode and the various operations of write/data transmission/initialization in Data mode are grouped into the following levels.

● Edit mode contains menu displays from which you will select the parameter group, and parameter displays in which you modify the value of the parameters.

First select the group of the parameter you wish to edit, and then move to the parameter display. Next select the parameter you wish to edit and modify the value.

● Data mode contains displays from which you will select the write/data transfer/initialize/utility function, and displays in which you specify the unit of data. First select the desired function. Then specify the unit of data and execute the operation.

As explained in the following procedure, press the buttons to move to each level. Then select and modify the parameter. You can also use the Jump function (page 37) to move quickly to a desired display.

- ① Press **EDIT** or **DATA** to select the operation mode.
Then use **◀** **CURSOR** **▶** and **ENTER** to move to the level of the parameter you wish to modify.
- ② When you reach the desired parameter, use **▽** **VALUE** **△** to change the setting or value.
- ③ Press **EXIT** to return to the desired display.

*When you want to modify the same parameter for different parts in a patch, use

◀ **PART/INST** **▶** at step ② to move between parts.

(You can also use **◀** **PART/INST** **▶** to move between timbres or rhythm instruments when editing a timbre or rhythm set.)

If you loose track of where you are, press **EXIT** several time to return to the play display. (Or hold **JUMP** and press **▽** **VALUE**.)

```
P-01: Acoust Piano [001]
RX |01|01|01|01|01|01|10
```

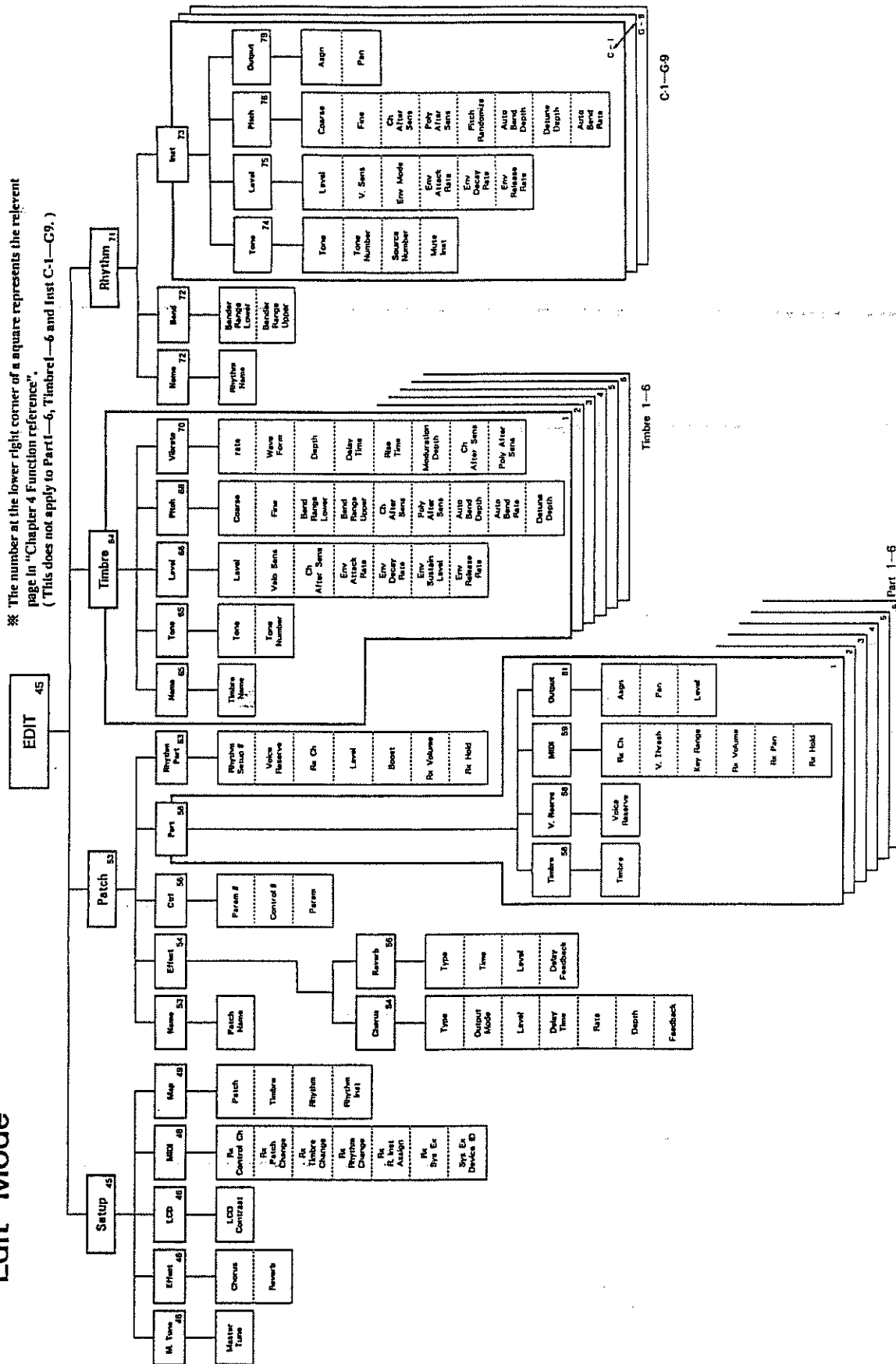

Edit Mode

※ The number at the lower right corner of a square represents the referent page in "Chapter 4 Function reference".
 (This does not apply to Part1-6, Timbre1-6 and Inst C-1-G9.)

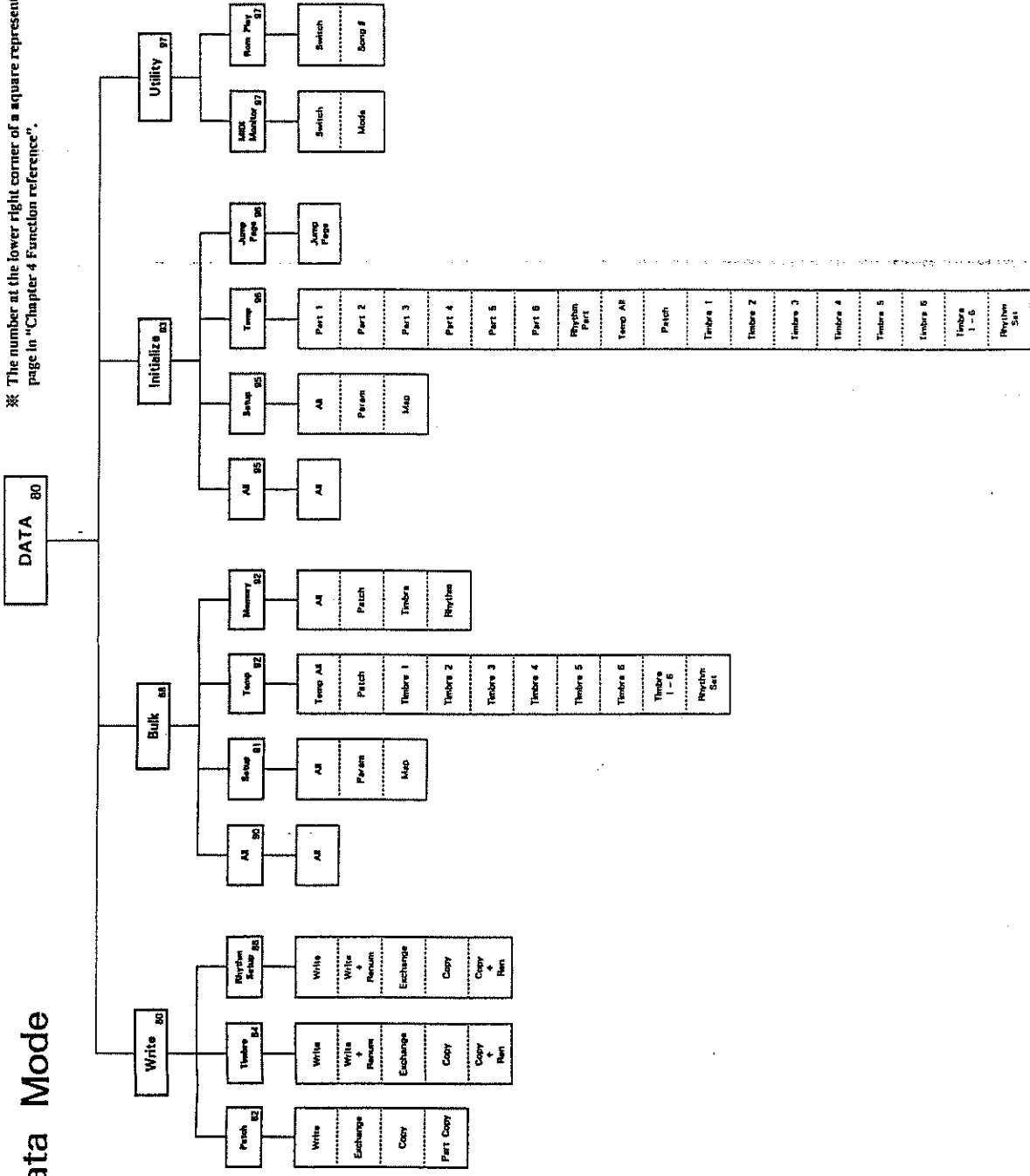

Data Mode

※ The number at the lower right corner of a square represents the relevant page in "Chapter 4 Function reference".



How to use the buttons

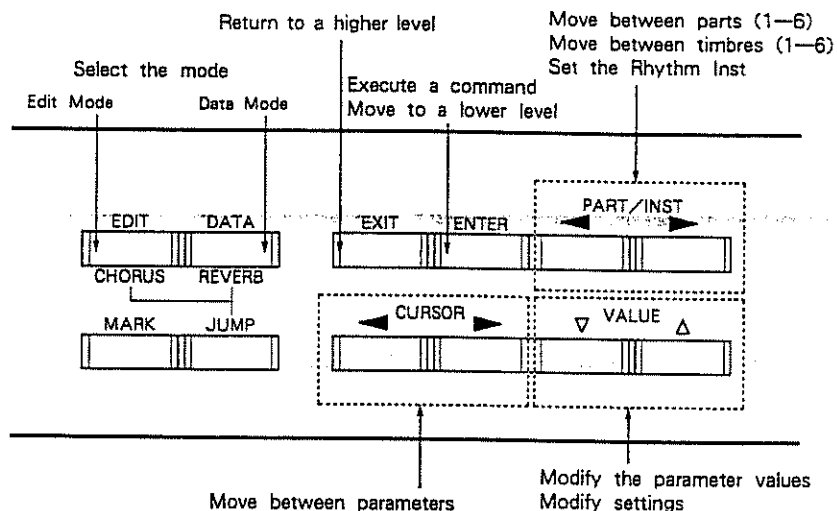

EDIT

Press this button to move to edit mode.

DATA

Press this button to move to data mode.

◀ CURSOR ▶

Use these buttons to select parameters that are in the same level.

ENTER

Press this button to move to the next lower level.

▽ VALUE ▲

Use these buttons to modify parameter values or settings.

◀ PART/INST ▶

Use these buttons to move between parts (parts 1—6) in a patch. When editing a timbre, use these buttons to move between timbres (timbres 1—6). When editing a rhythm set, use these buttons to move between instrument numbers (B1—D7).

EXIT

Press this button to return to the next higher level.

The upper line of the display will show the levels through which you have moved as you progress down toward the parameter level.

The level to which you have entered

```

Edit/Setup/MIDI
◀ Rx SysEx = Off ▶
    
```

↑
Parameter

(Example)

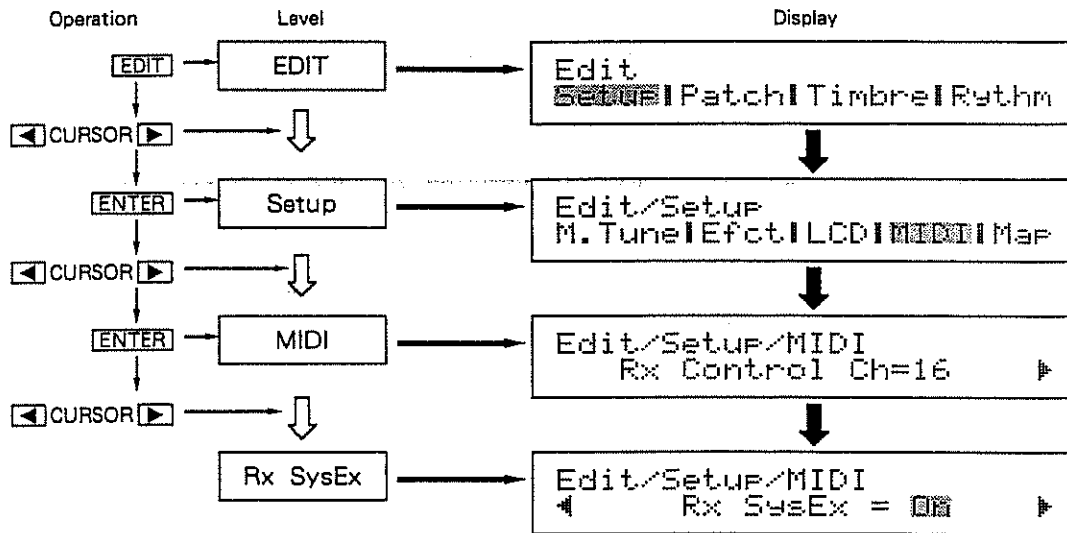

* The "◀" and "▶" in the display indicate that other parameters exist at the same level.

In data mode there will be the following additional display to execute the selected operation. This display will appear whenever you are about to write data or initialize.

```

Data/****/****
Sure? [VALUE▲] / [EXIT]
  
```

When execution is complete the following display will appear.

```

Data/****/****
Function Completed.
  
```

* After a short time the previous display will reappear.

The Jump function

Frequently used displays in the U-220 have been preset so that you can use the **JUMP** button to move quickly to them. This is called the Jump function.

While holding **JUMP** press the button for which the desired display has been preset. Page 38 has a list of the preset jump displays (functions).

- It is not possible to change the preset jump display (function) destinations, but you can use the **MARK** button to mark any display (function) to which you wish to jump. Page 39 lists the displays that are marked by the factory settings.

【How to mark a Display】

- ① Select the display you wish to mark.
In all displays the location of the cursor will also be marked.
- ② Press **MARK**.
- ③ Press the button for which you want to mark the display.

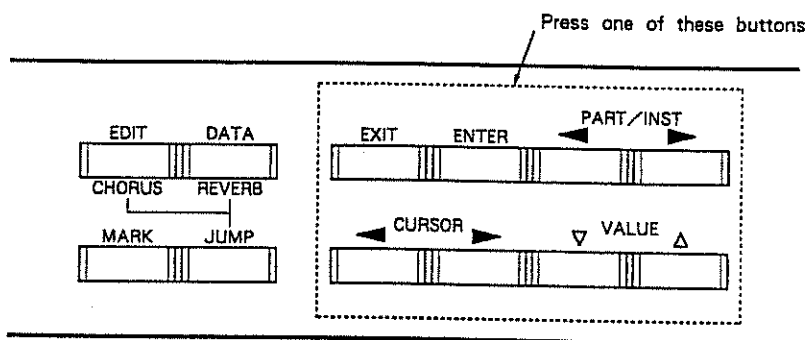

To move to the display you have marked, press **JUMP** and then press the button for which you have marked the desired display. (This procedure is also used to jump to the displays marked for **EDIT** and **DATA**.)

* If you want to restore the marks to the factory settings, you can initialize the marks (see page 93).

● Preset jump functions

The following jump functions have been preset, and cannot be changed.

While holding JUMP or After Pressing JUMP	EDIT	The display to set the chorus of the patch Edit/Patch/Effect/Chorus *****
	DATA	The display to set the reverb of the patch Edit/Patch/Effect/Reverb *****
While holding JUMP	EXIT	The display to transmit the parameter group currently being edited Data/Bulk/****
	ENTER	The display to write the parameter group currently being edited Data/Write/**** *You can jump here only from edit mode. However you cannot jump here from editing the setup parameters which do not need to be written into memory.
	◀ CURSOR	Move to the next parameter group (Same as EXIT → ◀ CURSOR → ENTER)
	CURSOR ▶	Move to the next parameter group (Same as EXIT → CURSOR ▶ → ENTER)
	◀ PART/INST	Return to the previous display you passed through (up to 32 displays)
	PART/INST ▶	Advance to the next display after returning to previous displays
	▽ VALUE	The play mode display where you last were
VALUE ▲	The display to play ROM demo (the song previously selected) Data/Util/ROM Play : Stop Song *****	

● **Settable jump functions**

The following jump functions have been set at the factory. (You can change these if you wish.)

After Pressing JUMP	EXIT	Edit/Patch/Part1/MIDI Rx Ch=01 ▶
	ENTER	Edit/Timbre[1]/Tone Tone = I-002 A.PIANO 4
	◀ CURSOR	Edit/Patch/R.Part ◀ Rx Ch=10
	CURSOR ▶	Edit/Rhythm/Inst/Tone B1 : I-128 DRUMS ▶
	◀ PART/INST	Edit/Patch/Part1/Output Asgn=Dry Pan=7◀ ▶
	PART/INST ▶	Edit/Patch/Part1/Output ◀ Level=127
	▽ VALUE	Edit/Patch/Part1/U.Rsv Voice Reserve=0 [30]
	VALUE ▲	Edit/Timbre[1]/Level Level=100 Velo Sens=+7 ▶

1. The first part of the document is a list of names and titles, including "The Hon. Mr. Justice G. D. C. O'Connell, Chief Justice of the Supreme Court of the State of New South Wales" and "The Hon. Mr. Justice G. D. C. O'Connell, Chief Justice of the Supreme Court of the State of New South Wales".

10
11
12

13
14
15

16
17
18

Chapter 4 Function reference

This chapter explains the functions for each level of the U-220.

1. Play Mode (Play)

In play mode you can view the effect settings of the patch and the settings of each part.

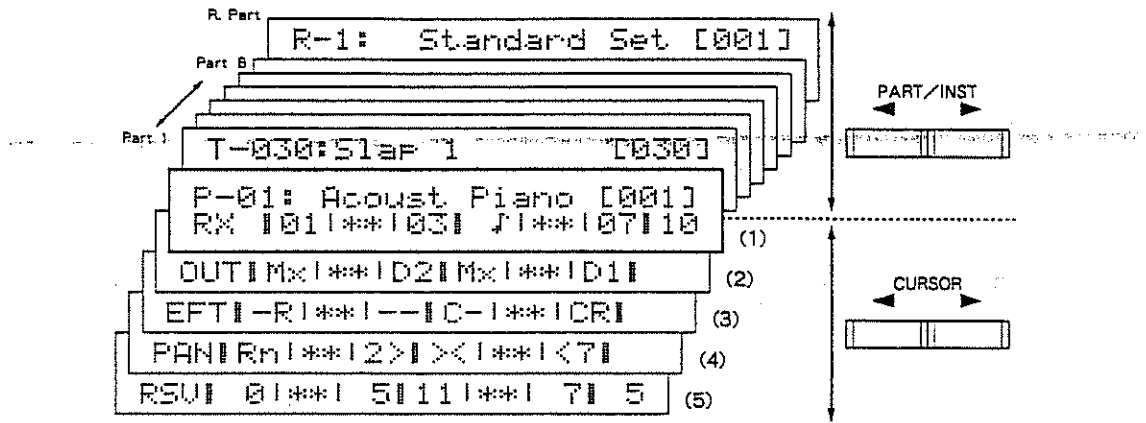

The top line shows the currently used patch name, timbre name, or rhythm set name.

Use PART/INST to move between the following displays.

Patch ⇄ Part 1 ⇄ Part 2 ⇄ Part 3 ⇄ Part 4 ⇄ Part 5 ⇄ Part 6 ⇄ Rhythm part

Use VALUE to select patches, the timbre of each part, or the rhythm set of the rhythm part.

The program change number which corresponds to the patch or timbre is displayed in square brackets []. If no program change is assigned to the patch, timbre, or rhythm set, this will display [---].

Map (Patch, Timbre, Rhythm Set)

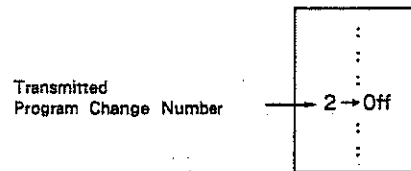

If *** is displayed in the [], the program change reception switch is Off for the selected patch, timbre, or rhythm set.

(Example)



* If more than one program change number is assigned to the same patch number, the lowest-numbered program change will be shown.

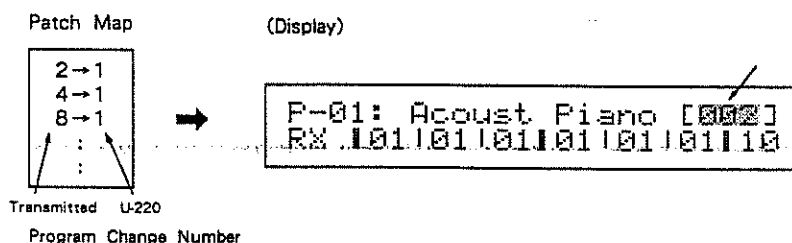

The lower line shows the reception channel and output for each part.

Use CURSOR to switch the display as follows.

RX (reception channel) ⇔ OUT (output assign) ⇔ EFT (effect) ⇔ PAN (pan) ⇔ RSV (voice reserve)

The cursor in the upper line corresponds to each part.

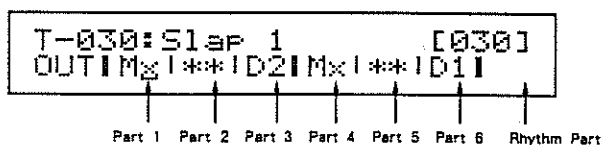

(1) RX (1—16, **, ♪)

This shows the reception channel setting of each part, and also serves as a simple monitor of which parts are sounding.

1—16 : reception channel number

** : not receiving (off)

♪ : now sounding

(2) OUT (Mx, D1, D2, **)

This shows the output setting of each part.

Mx : MIX OUT

D1 : DIRECT OUT 1

D2 : DIRECT OUT 2

** : not used, since the reception channel is off

※ The rhythm part will not be displayed.

(3) EFT (CR, C -, -R, --, **)

This shows the chorus/reverb setting of each part.

CR : from chorus to reverb

C - : chorus only

- R : reverb only

-- : the setup effect settings for chorus and reverb are both off

** : not used, since the reception channel is off

※ The rhythm part will not be displayed.

(4) PAN (7 > .. 1 >, > <, < 1 .. < 7, Rnd, **)

This shows the pan setting of each part.

7-1 > : panned to left

> < : panned to center

< 1-7 : panned to right

Rnd : random pan change for each note

** : not used, since the reception channel is off

※ The rhythm part will not be displayed.

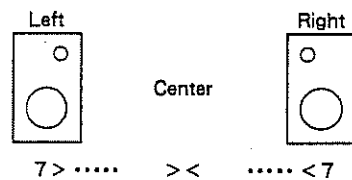

(5) RSV (0-30, ♪, **)

This shows the number of reserved voices for each part.

0-30 : number of reserved voices

♪ : notes are sounding which exceed the number of reserved voices

** : not used, since the reception channel is off

2. Edit Mode (Edit)

In edit mode you can edit setup, patch, timbre, and rhythm set data. Edited settings are temporary, and will be lost when you select another patch/timbre/rhythm set. If you want to keep the current settings, you must write the data into memory.

Precautions when editing

While editing, you can hold **JUMP** and press **ENTER** to move to the display for writing the current parameter. By holding **JUMP** and pressing **EXIT** you can move to the display for transmitting the current parameter.

If you press **ENTER** while editing, the value of the selected (blinking) parameter will be transmitted from MIDI OUT as a system exclusive message.

However Setup/MIDI or Setup/Map settings will not be transmitted.

```

Edit/Patch/Part1/Output
┆          Level=127
  
```

For example if you press **ENTER** from the above display, the volume level setting (127) for part 1 will be transmitted.

If you have selected the setup parameter master tune, it will be transmitted from MIDI OUT as a control change.

a. Setup settings (Setup)

These settings affect the setup. Setup settings are always memorized, and there is no need to write them after modifying the settings.

[Example operation]

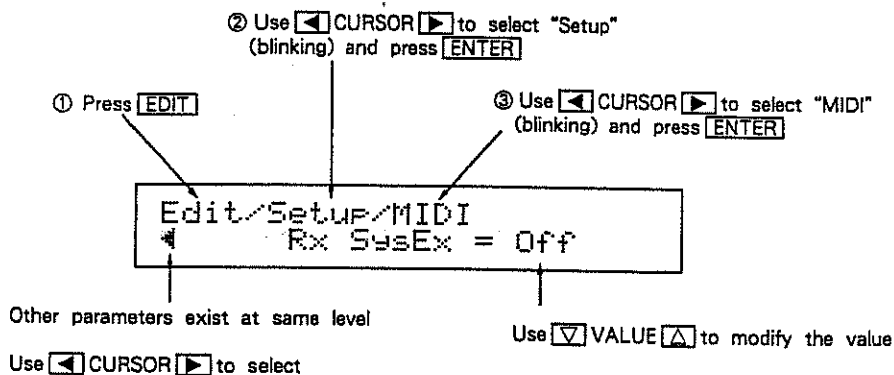

* The value of the currently selected parameter will blink.

* Return to the play display by pressing **EXIT** several times.
(or hold **JUMP** and press **▽ VALUE**)

■ Master Tune

Master Tune 427.4Hz—452.9Hz

This adjusts the pitch of all parts. The displayed value indicates the frequency of A4. The decimal place is approximate.

```
Edit/Setup/M.Tune
Master Tune=440.0Hz
```

■ Effect

Chorus On/Off

Chorus can be turned on/off regardless of the patch settings. When this is turned off, there will be no chorus effect even if chorus is turned on for individual parts in the patch.

Reverb On/Off

Reverb can be turned on/off regardless of the patch settings. When this is turned off, there will be no reverb effect even if reverb is turned on for individual parts in the patch.

```
Edit/Setup/Effect
Chorus=On Reverb=On
```

- * The on/off settings for chorus/reverb are memorized even if you change patches.
- * The effect sound is output from MIX OUT L and R.

■ LCD

LCD Contrast 0—15

This adjusts the contrast of the display.

```
Edit/Setup/LCD
LCD Contrast=10
```

■ MIDI

Rx Ctrl Ch (Rx Control Channel) 1—16

This specifies the channel on which program changes will be received to select patches.

This also determines the channel on which control change data is received to modify effect parameters (page 56).

```
Edit/Setup/MIDI
Rx Control Ch=16 ▶
```

Rx Patch Change Map1—4, Dir, Off

This determines how program change data is received to select patches.

```

Edit/Setup/MIDI
◀Rx Patch Change=Dir ▶

```

Map1—4 : When a program change is received the patch specified by the map will be selected.

Dir : When a program change is received the correspondingly numbered patch will be selected.

Off : Program changes will be ignored.

Rx Timbre Change Map1—4, Dir, Off

This determines how each part of the patch will receive program change data. When a program change is received, a timbre will be selected for the part which is receiving that channel.

```

Edit/Setup/MIDI
◀Rx Timbre Change=Dir ▶

```

Map1—4 : When a program change is received the timbre specified by the map will be selected.

Dir : When a program change is received the correspondingly numbered timbre will be selected.

Off : Program changes will be ignored.

* If the control channel is the same as the channel of the part for which you want to select timbres, an incoming program change will first select the patch and then select the timbre.

Rx Rhythm Change Map1—4, Dir, Off

This determines how program change data is received by the rhythm part.

When a rhythm part receives a program change it will change rhythm sets.

```

Edit/Setup/MIDI
◀Rx Rhythm Change=Dir ▶

```

Map1—4 : When a program change is received the rhythm set specified by the map will be selected.

Dir : When a program change is received the correspondingly numbered rhythm set will be selected.

Off : Program changes will be ignored.

* If the control channel and the rhythm part channel are the same, an incoming program change will first select the patch and then select the rhythm set.

Rx R.Inst Assign (Rx Rhythm Inst Assign) Map1—4, Dir, Off

This determines how the rhythm part will receive note data.

```
Edit/Setup/MIDI
◀Rx R.Inst Assign=Dir ▶
```

Map1—4 : When note data is received it will be converted into the note specified by the selected map.

- Dir : Note data will be received. Note numbers will not be converted.
- Off : Note data will be ignored.

Rx SysEx (Rx System Exclusive) On, Off

This determines whether exclusive messages will be received or not.

```
Edit/Setup/MIDI
◀ Rx SysEx = Off ▶
```

- On : Exclusive messages will be received
- Off : Exclusive messages will not be received

While an exclusive message is being received the following display will appear.

```
Receiving SysEx
```

Device ID 1—32

When sending and receiving exclusive messages, the two MIDI devices must be set to the same device ID number. Exclusive messages will not be received unless the device ID numbers of the two devices match.

```
Edit/Setup/MIDI
◀ SysEx Device ID=17
```

Map

The U-220 allows you to create Maps to specify which sound is selected by each incoming program change number. This allows you to select any sound using any program change number. Patch, timbre, rhythm set, and rhythm instrument each have four maps.

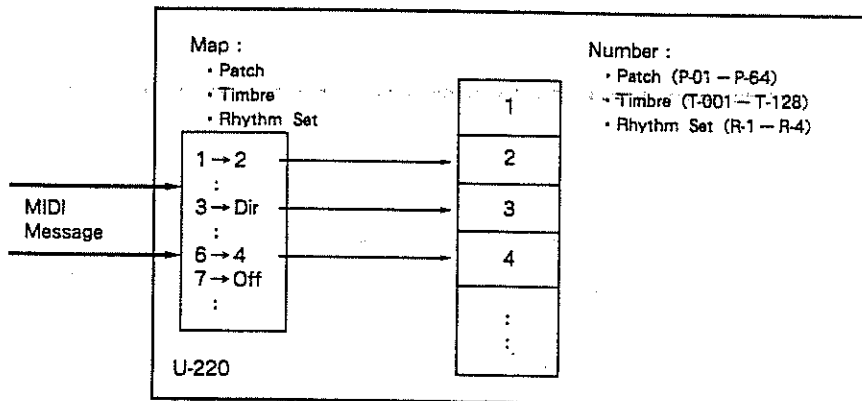

```

Edit/Setup/Map/Patch
Patch Map1: #021 →064
    
```

When `:` is displayed you can set the map from the U-220's controls.

- When setting the map, you can specify the number from the U-220 and also from an external MIDI device. Use the following procedure.

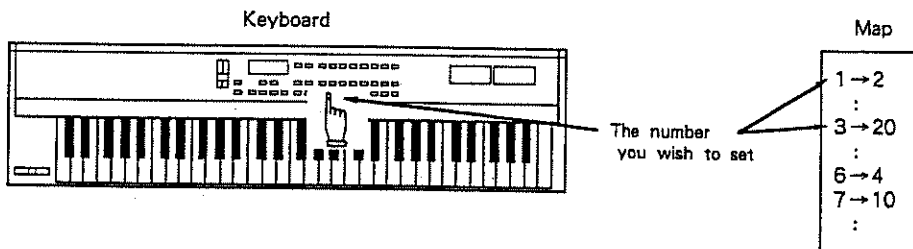

【Procedure】

- ① While holding `JUMP` press `MARK`.

```

Edit/Setup/Map/Patch
Patch Map1> #021 →064
    
```

This is the same for Timbre, Rhythm, and R. Inst Map

The `:` will change to `>`.

② When you transmit a program change from the connected keyboard, A will change to that number and the number B which is currently set for that program change will be displayed.

③ Use **◀** CURSOR **▶** to move the cursor to B and use **▽** VALUE **△** to specify the memory number you want the program change to select.

With the cursor located at B you can repeat steps ② and ③ to set program change numbers from the keyboard.

* When setting the rhythm instrument map, set the U-220 and the keyboard to the same transmission/reception channels (page 59).

* When selecting a patch from the keyboard while playing, transmit the program change on the control channel.

When selecting a timbre, rhythm set, or rhythm instrument, transmit the program change data (note data for a rhythm instrument) on the same channel as the reception channel for the part you want to select.

④ Once again, hold **JUMP** and press **MARK** and the **>** will return to **:**.

Patch Map (Patch Change Map) 1—64, Dir, Off

This setting determines how program change numbers are related to patch numbers when selecting patches from an external MIDI device. Each patch map determines how the 128 program change numbers correspond to the 64 patches.

Four patch change maps can be set. The Rx Patch Change parameter determines which of these four maps is used. (page 47.)

- 1—64 : The patch number that will be selected by the incoming program change
- Dir : The incoming program change will select the patch of the same number
- Off : The incoming program change will not change the patch

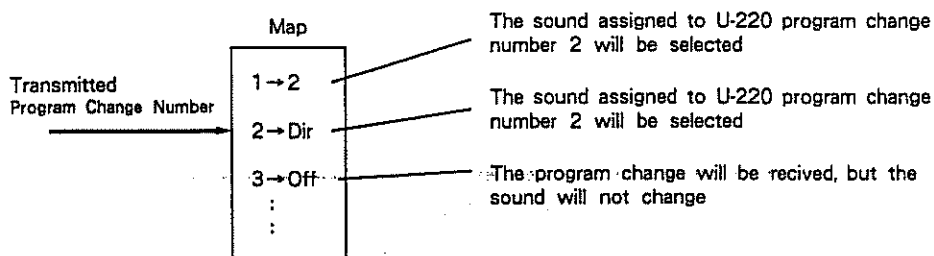

```

Edit/Setup/Map
Patch Map1: #021 +064
    
```

Timbre Map (Timbre Change Map) 1—128, Dir, Off

This setting determines how program change numbers are related to the part number of each timbre when selecting the timbre of each part from an external MIDI device. Each timbre map determines how the 128 program change numbers correspond to the 128 timbres. Four timbre change maps can be set. The Rx Timbre Change parameter determines which of these four maps is used. (page 47.)

- 1—128 : The timbre number that will be selected by the incoming program change
 Dir : The incoming program change will select the timbre of the same number
 Off : The incoming program change will not change the timbre

```

Edit/Setup/Map
Timbre Map1: #040+041
  
```

Rhythm Map (Rhythm Change Map) 1—4, Dir, Off

This setting determines how program change numbers are related to the rhythm set when selecting the rhythm set of the rhythm part from an external MIDI device. Each rhythm map determines how the 128 program change numbers correspond to the 4 rhythm set numbers. Four rhythm change maps can be set.

The Rx Rhythm Change parameter determines which of these four maps is used. (page 47.)

- 1—4 : The rhythm set number that will be selected by the incoming program change
 Dir : The incoming program change will select the rhythm set of the same number
 Off : The incoming program change will not change the rhythm set

```

Edit/Setup/Map
Rhythm Map1: #122+003
  
```

R.Inst Map (Rhythm Inst Map) B1—D7, Dir, Off

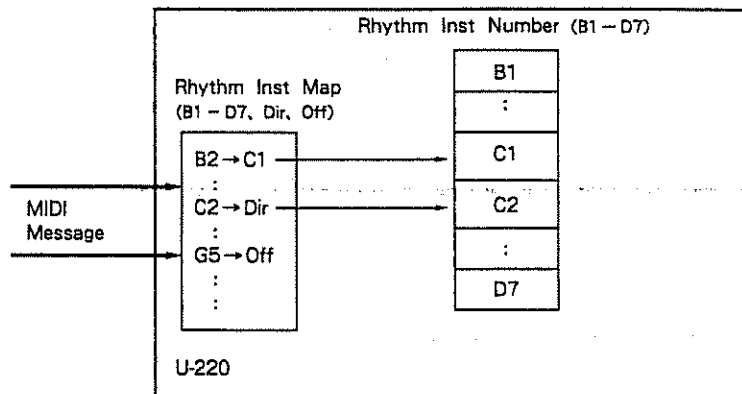

This setting determines how key numbers of an external MIDI instrument are related to the key numbers of the U-220 rhythm instrument. Each rhythm instrument map determines how each MIDI key number corresponds to each rhythm instrument number. Four rhythm instrument maps can be set. The Rx R.Inst Assign parameter determines which of these four maps is used. (page 48.)

- B1—D7** : The key number of the rhythm Instrument which corresponds to each incoming key number
- Dir** : The incoming key number will play the rhythm Instrument of the same key number
- Off** : The incoming key number will not play a rhythm Instrument

```

Edit/Setup/Map
R.Inst Map2: C-1 +Dir
    
```

b. Patch setting (Patch)

A patch consists of part settings, effect settings, etc. 64 patches can be stored in internal memory. Edited settings are temporary. If you want to keep your edited settings you must write them into memory (page 80).

【Example operation】

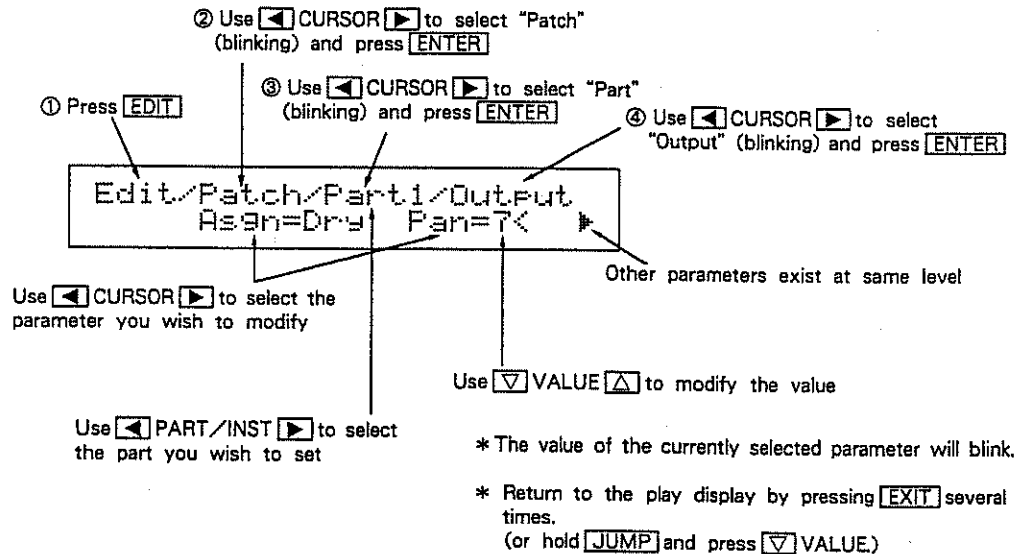

■ Naming (Name)

Patch Name

Each patch can be given a 12-character name.

Use **◀ CURSOR ▶** to move the cursor and use **▽ VALUE ▲** to change the character located at the cursor.

```

Edit/Patch/Name
Patch Name=EretlessBass
  
```

* The following characters can be used : space A-Z a-z 0-9 - / + * . , ; = ! " # \$ % & ' () < > { } [] _ ? `

Effect

These are the chorus and reverb settings.

● Chorus / Flanger

Type Chorus1, Chorus2, FB-Chorus, Flanger, Short Delay

Select the type of chorus from the following five types.

```

Edit/Patch/Effect/Chorus
Type=FB-Chorus
    
```

Chorus1	Rich spacious effect.
Chorus2	Deep ensemble effect, especially effective for layered strings.
FB-Chorus	An effect midway between chorus and flanger.
Flanger	An effect of strongly emphasized shifting overtones, especially effective on sounds with a strong overtone structure such as HEAVY.EG.
Short Delay	A delay repeated in a short time.

Out (Output Mode) Pre Rev, Post Rev

This determines how the chorus and reverb are connected. The output assign setting (page 61) of each part will determine which effects are used.

Pre Rev : Reverb will be added to the sound that has been processed through the chorus.

Post Rev : Reverb will not be added to the sound that has been processed through the chorus.

```

Edit/Patch/Effect/Chorus
Out=Pre Rev Level=24
    
```

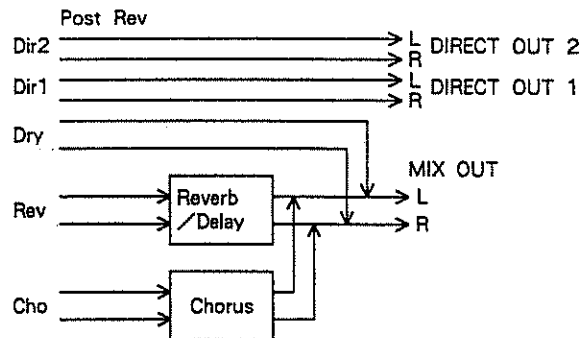
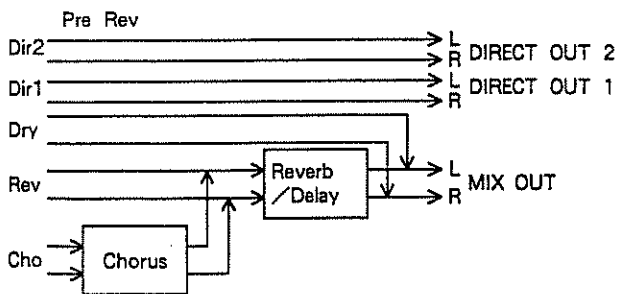

Level 0—31

This determines the volume of the effect processed sound.

```
Edit/Patch/Effect/Chorus
◀Out=Pre Rev  Level=24▶
```

Delay Time 0—31

This adjusts the internal delay time of the chorus / flanger.

```
Edit/Patch/Effect/Chorus
◀Delay Time=5  Rate=10▶
```

- * For Chorus 1, 2, and FB-Chorus, higher settings will result in a more spacious effect. For Flanger, lower settings will result in a stronger flanging effect. Higher settings will be closer to a chorus effect.

For Short Delay, this adjusts the timing of the repeats.

Rate 0—31

This adjusts the modulation frequency of the chorus / flanger.

```
Edit/Patch/Effect/Chorus
◀Delay Time=5  Rate=10▶
```

- * This Rate setting has no effect when Short Delay is selected.

Depth 0—31

This adjusts the depth of the chorus or flanger effect.

```
Edit/Patch/Effect/Chorus
◀ Depth=10  Feedback=±0▶
```

- * This Depth setting has no effect when Short Delay is selected.

Feedback -31—+31

This determines the amount of feedback for the flanger or delay. The phase will be different for positive (+) or negative (-) settings, and the effect will change.

```
Edit/Patch/Effect/Chorus
◀ Depth=10  Feedback=±0▶
```

- * For Flanger and FB-Chorus this will change the character of the effect. For Short Delay this will determine the number of repeats. For Chorus 1, 2 it has no effect.

● Reverb / Delay

Type Room1—3, Hall1—2, Gate, Delay, Cross Delay

This selects the type of reverb / delay.

```

Edit/Patch/Effect/Reverb
Type=Hall1      Time=10
    
```

Room 1—3	Sharply-defined reverb with a broad spread
Hall 1, 2	Smooth reverb, with greater depth than Room
Gate	A sharply muted reverb; i.e., "gated" to procedure an artificially fast decay
Delay	Standard delay effect
Cross Delay	Delay repeats pan to left and right

Time 0—31

This adjusts the reverb time.

```

Edit/Patch/Effect/Reverb
Type=Hall1      Time=10
    
```

* When Delay or Cross Delay has been selected, this adjusts the delay time.

Level 0—31

This adjusts the level of the reverberant sound (delayed sound).

```

Edit/Patch/Effect/Reverb
Level=9      Delay FB=12
    
```

Feedback 0—31

This adjusts the number of delayed repeats.

```

Edit/Patch/Effect/Reverb
Level=9      Delay FB=12
    
```

* This parameter is effective only when Delay or Cross Delay is selected.

■ Controller (Ctrl)

Control change data from an external MIDI device can control three parameters of the U-220. This allows you to control parameter values of timbres or effects from an external MIDI device. You can specify the three control change numbers that will be received, and the three parameters which will be controlled by each control change.

Prm # (Control Number) 0—5, 7—31, 64—95,

This selects the three control change numbers that will be received.

```
Edit/Patch/Ctrl
Prm1=#0ff  Timbre Level▶
```

```
Edit/Patch/Ctrl
#Prm2=#92  Env Attack ▶
```

```
Edit/Patch/Ctrl
#Prm3=#92  A.Bend Rate
```

Parameter Select

This specifies the U-220 parameters that will be affected by each control change.

- * If you have specified a timbre parameter, send control change data from a sequencer or keyboard on the reception channel of the part you wish to control.
- * If you have specified an effect parameter, send control change data from a sequencer or keyboard on the control channel.

Selectable Parameters

	Display	Parameter
Timbre Parameters	Timbre Level Env Attack Env Decay Env Sustain Env Release A.Bend Depth A.Bend Rate Detune Depth Vib Rate Vib Waveform Vib Depth Vib Delay Vib RiseTime Vib ModDepth	Timbre Level Env Attack Rate Env Decay Rate Env Sustain Level Env Release Rate Auto Bend Depth Auto Bend Rate Detune Depth Vibrato Rate Vibrato Waveform Vibrato Depth Vibrato Delay Vibrato Rise Time Vibrato Modulation Depth
Effect Parameters	Chrs Level Chrs Rate ChrsFeedback Rev Level DelayFeedback	Chorus Level Chorus Rate Chorus Feedback Reverb Level Delay Feedback

■ Part settings (Part1—6)

These settings are made for part 1—6 of each patch.

● Timbre

Timbre (Timbre select) T-001—T-128

This specifies the timbre which will be used for each part 1—6 of the patch.

Use VALUE to select timbres.

```
Edit/Patch/Part1/Timbre  
Timbr=T-001:A.Piano 2
```

● Voice Reserve

Voice Reserve 0—30

The Voice Reserve parameter is effective when using the U-220 as a multi-timbral sound module. Voice reserve determines the minimum number of voices (notes of polyphony) that will be reserved for each part, ensuring that even if the maximum number of simultaneous notes is exceeded, the sound of important parts will not be cut off.

Voice reserve is set for each part. It is not possible to make settings that would total over 30 voices for all parts.

```
Edit/Patch/Part1/U.Rsv  
Voice Reserve=0 [30]
```

The Number of voices reserved The number of unreserved voices

The U-220 can produce up to 30 voices (notes) at once. Each part will sound freely until the total of sounding notes reaches 30 voices. When the number of requested voices exceeds 30, voices will be taken (turned off) from parts which are sounding more notes than their voice reserve setting allows, and these voices will be used to play the new notes. Voices will be taken in order or low priority from parts which are sounding more than their quota of reserved notes.

* If voices are taken from a part which is playing a sound with a long release, the sound may break off unnaturally.

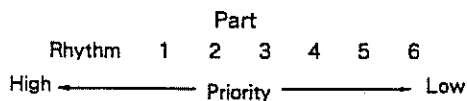
(Order of priority between parts)

If no parts are sounding notes in excess of their number of reserved notes, then the part to which the request came will be the lowest priority part, and the oldest sounding note in that part will be turned off to make room for the newly played note. In this case voices will not be taken from other parts.

- * The number specified by the Voice Reserve setting is the number of voices, and is not related to the MIDI Note Number which is received.
- * Tones which uses two voices (DETUNE, DUAL, V-MIX) will use voices and give up voices by pairs of two voices. When using a two-voice tone, be sure to set its voice reserve setting to an even number. (Refer to page 65, and the tone chart on page 126.)
- * If more than 30 notes are requested, the timing of the notes may become inaccurate.

● MIDI

Rx Ch (Rx Channel) 1—16, Off

This sets the reception channel of each part 1—6 in the patch.

When playing the patch from a keyboard, set the transmission channel of the keyboard to match the reception channel of the parts you want to play. You can play parts in unison by setting two or more parts to the same reception channel as the transmission channel of the keyboard.

When playing from a sequencer, set the reception channel of each part to match the transmission channel of each track of data transmitted by the sequencer.

```

Edit/Patch/Part1/MIDI
Rx Ch=01
```

K.Range (Key Range) C-1—G9

This determines the range of notes (key numbers) which will be received by each part. Specify the key range by the note names of the lowest and highest notes to be received. You can play different parts from different areas of the keyboard by setting two or more parts to the same reception channel and specifying a different key range for each part.

```

Edit/Patch/Part1/MIDI
Key Range C-1 - G9
```

Example : Split bass and brass sounds around the C4 Key

	Part 1	Part2
Rx Ch	1	1
Velocity Range	C-1 - B3	C4 - G9
Timbre	Bass Sound	Brass Sound

* Transmit channel of the keyboard : 1

Velo Thresh (Velocity Threshold) 1—127/Above, Below

This determines the range of velocities for which each part will receive note data. You can play different sounds for notes of different playing strengths by setting two or more parts to the same reception channel and specifying a different velocity threshold for each part.

```

Edit/Patch/Part1/MIDI
V.Thresh=100 Lvl=Above
    
```

Example : Softly played notes sound a fingered bass, strongry played notes sound a slap bass.

	Part 1	Part 2
Rx Ch	1	1
Velocity Threshold	99 Below (1 - 99)	100 Above (100 - 127)
Timbre	Fingered Bass Sound	Slap Bass Sound

* Transmit channel of the keyboard : 1

Rx Volume On, Off

This switch determines whether or not each part will receive volume control data from an external MIDI device. For example you can set two parts to receive the same MIDI channel and use volume control data from an external device to control only one of the parts.

```

Edit/Patch/Part1/MIDI
Rx Volume=On
    
```

* If the reception channel of each part is turned off, volume data will not be received even if you turn the volume reception switch on.

Rx Pan On, Off

This switch determines whether or not each part will receive pan data from an external MIDI device. For example you can set two parts to receive the same MIDI channel and use pan control data from an external device to control only one of the parts.

```

Edit/Patch/Part1/MIDI
Rx Pan=Off
    
```

* If the reception channel of each part is turned off, pan data will not be received even if you turn the pan reception switch on.

Rx Hold On, Off

This switch determines whether or not each part will receive hold data from an external MIDI device. For example you can set two parts to receive the same MIDI channel and use hold data from an external device to control only one of the parts.

```

Edit/Patch/Part1/MIDI
Rx Hold=Off
    
```

* If the reception channel of each part is turned off, hold data will not be received even if you turn the hold reception switch on.

● **Output**

Asgn (Output Assign) Dry, Rev, Cho, Dir1, Dir2

This selects the effect (chorus, reverb/delay) and output jack used by each part. Chorus can be used in two ways, Pre Rev or Post Rev, as determined by the output mode of the effect (see page 54).

```

Edit/Patch/Part1/Output
Asgn=Dry Pan=7<
    
```

Output Mode	Effect	Output Jacks
Dry	No effect is used	MIX OUT
Rev	Only Reverb	
Cho	Pre Rev : Chorus and Reverb Post Rev : Only Chorus	
Dir 1	No effect is used	DIRECT OUT 1
Dir 2	No effect is used	DIRECT OUT 2

- * If a plug is not inserted into the DIRECT OUT jack, the output of the DIRECT OUT jack will be sent from MIX OUT.
- * The rear panel has a FIXED/VARIABLE switch. If the MIX OUT jacks are being used, setting this switch to Fixed will set the output at maximum level regardless of the position of the front panel Volume knob, and setting this switch to Variable will allow you to regulate the volume using the VOLUME knob.
- * The FIXED/VARIABLE switch has no effect on the sound that is being output from DIRECT OUT. You will not be able to regulate the volume using the VOLUME knob.

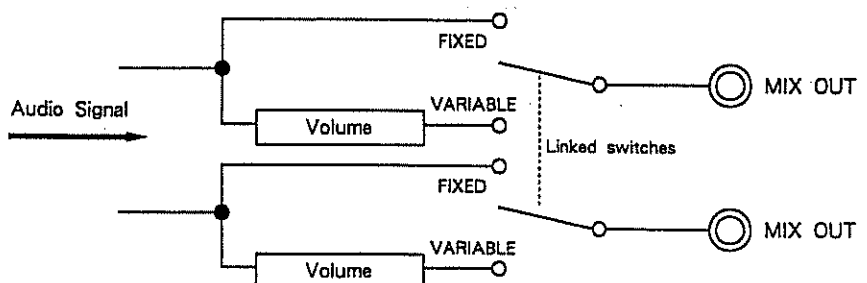

- * The FIXED/VARIABLE switch has no effect on the headphone volume. When using headphones, you can always adjust the volume using the VOLUME knob.
- * Be sure to turn the U-220's power off before changing the position of the FIXED/VARIABLE switch.

The U-220 is able to independently output the sound of each part. (Multi out.) In this case, the MIX OUT, DIRECT-OUT-1, DIRECT-OUT-2 jacks are used as OUT-1, 2, 3, 4, 5, and 6. The settings for the rear panel OUT 1—6 will be as follows.

Output Jack	Output Assign	Pan
OUT 1 (MIX L)	Dry ★	7<
OUT 2 (MIX R)	Dry ★	>7
OUT 3 (DIR 1 L)	Dir 1	7<
OUT 4 (DIR 1 R)	Dir 1	>7
OUT 5 (DIR 2 L)	Dir 2	7<
OUT 6 (DIR 2 R)	Dir 2	>7

- ★ If the OUT 1 and OUT 2 settings are set so that the output assign is Rev or Cho, the output of OUT 1 and OUT 2 will no longer be independent.

After selecting the OUT from which to output the sound, make appropriate settings for output assign and pan.

Pan 7>—><—<7, Rnd

This determines the pan (stereo position) of parts 1—6.

```

Edit/Patch/Part1/Output
Assign=Dry Pan=7< ▶
    
```

```

Left      Center      Right
7> ..... >< ..... <7
    
```

- * When Rnd is selected the pan position will change randomly for each note.
- * When the output assign of a part is set to Rev or Cho, the effect sound will be output from MIX L, R. If you want to pan a sound to far left or right, either set the output assign to Dry or make setup settings so that the effect is off.

Lvl (Part Level) 0—127

This determines the volume level of parts 1—6.

```

Edit/Patch/Part1/Output
Level=127 ◀
    
```

■ Rhythm Part

Rhythm = # (Rhythm Set select) # 1—4

Select one of the four rhythm sets for the rhythm part to use.

```

Edit/Patch/R.Part
Rhythm=R-1:Standard Set▶
  
```

Voice Reserve 0—30

The number of reserved voices can be set for the rhythm part in the same way as for the other parts (see page 58).

```

Edit/Patch/R.Part
◀ Voice Reserve=1 [29]▶
  
```

Rx Ch (Rx Channel) 1—16, Off

This sets the reception channel of the rhythm part.

```

Edit/Patch/R.Part
◀ Rx Ch=10 ▶
  
```

Level/Boost 0—127/On, Off

This sets the volume of the rhythm part. When Boost=Off the volume will be the specified value, but when Boost=On the volume will be greater than the specified value.

```

Edit/Patch/R.Part
◀ Level=120 Boost=On ▶
  
```

Rx Volume On, Off

This determines whether or not the rhythm part will receive volume data from an external MIDI device.

```

Edit/Patch/R.Part
◀ Rx Volume=On ▶
  
```

* If the reception channel of the rhythm part is set off, volume data will not be received even if the volume reception switch is on.

Rx Hold On, Off

This determines whether or not the rhythm part will receive hold data from an external MIDI device.



* If the reception channel of the rhythm part is set off, hold data will not be received even if the hold reception switch is on.

C. Editing a Timbre (Timbre)

This is where you edit timbre settings.

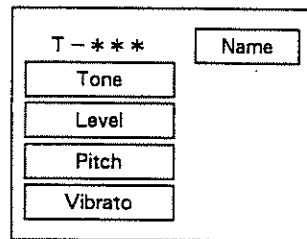

Edited settings are temporary. If you want to keep your edited settings you must write them into memory (page 84).

【Example operation】

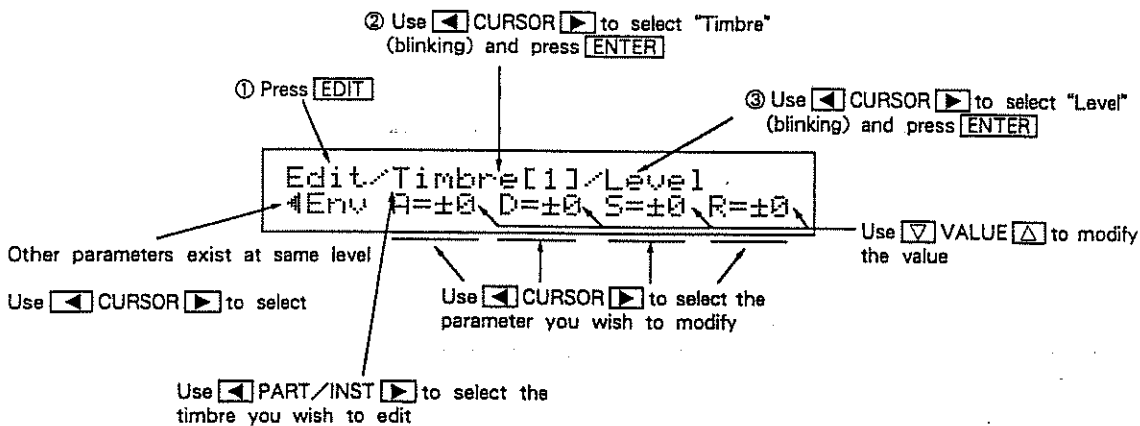

* The value of the currently selected parameter will blink.

* Return to the play display by pressing **EXIT** several times.
 (or hold **JUMP** and press **DOWN VALUE**)

■ Naming (Name)

Timbre Name

Each timbre can be given a 12-character name. Use CURSOR to move the cursor and use VALUE to change the character located at the cursor.

```

Edit/Timbre[1]/Name
Timbre Name=B.Piano 2

```

* The following characters can be used : space A—Z a—z 0—9 - / + * . , ; = ! " # \$ % & ' () < > { } [] _ ? ♪

■ Tone

Tone (Tone Select)

This is where you select the tone on which the timbre is based. You can select a tone from the 128 tones in internal (see page 126) or from tones in a separately sold PCM card.

```

Edit/Timbre[1]/Tone
Tone = I-002 A.PIANO 2

```

A B

A : (I) when an internal tone is selected, (1—31) when a PCM card (separately sold) tone is selected

B : The number of the selected tone (1—128)

Tones are classified into the following types. The list of tones (page 126) indicates the type of each tone.

Tone Type	Number of Voices	
Single	1	A Tone consisting of a single sound
Velocity Switch	1	A Tone which switches between two sounds according to on the key velocity
Dual	2	A Tone consisting of two different sounds
Detune	2	A Tone consisting of two sounds of different pitch
Velocity mix	2	A Tone which mixes two sounds according to the key velocity

■ Using a separately sold sound library card(SN-U110 series)

Each card is numbered by type; 01, 02, Check the number of the card, and insert it firmly into the front panel PCM CARD slot. You may insert a card into either the right or left slot. Up to two cards can be used at the same time.

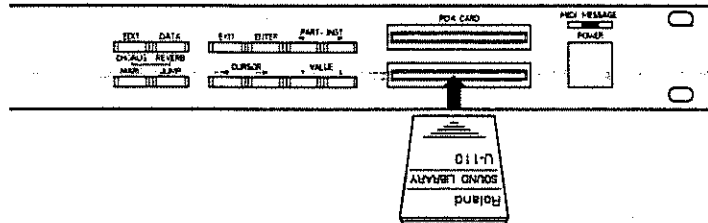

Set the tone select setting to the number of the inserted card and the number of the tone you want to use. The number of tones in a card will vary according to the card. When you insert or remove a PCM card the following display will briefly appear, and operation will halt for a short time.

```
Checking PCM Card...
```

While playing, the PCM card which contains the tones being used must remain inserted. If a card tone is selected but the correct card is not inserted, the following display will appear and there will be no sound.

```
Edit/Timbre[1]/Tone
Tone = 01-003 No Card!
```

■ Level

Level (Timbre Level) 0—127

This determines the volume of the timbre.

```
Edit/Timbre[1]/Level
Level=100 Velo Sens=+7 ▶
```

Velo Sens (Velocity Sensitivity) -7—+7

This determines how the volume will change in response to differences in the key velocity of an incoming note event.

```
Edit/Timbre[1]/Level
Level=100 Velo Sens=+7 ▶
```

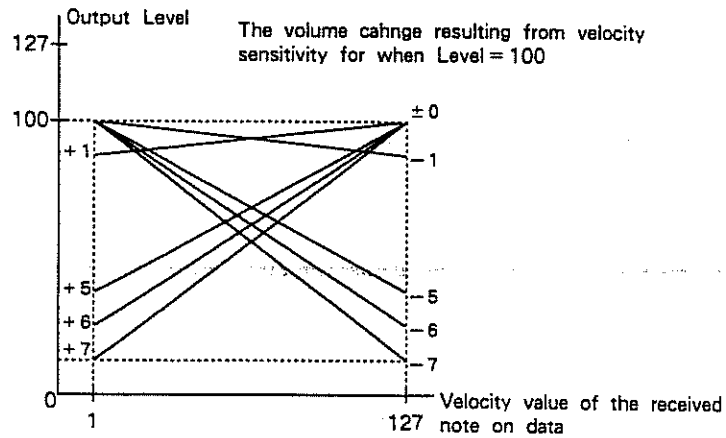

- ↑ +7 Strongly played notes will be louder
- 0 Velocity will not affect volume
- ↓ -7 Strongly played notes will be softer

Ch After Sens (Channel Aftertouch Sensitivity) -7 — +7

This determines how channel aftertouch (pressing down on the keyboard after playing a note) will affect volume.

```

Edit/Timbre[1]/Level
  Ch After Sens=±0
    
```

- ↑ +7 Stronger aftertouch will increase the volume
- 0 Aftertouch will not affect volume
- ↓ -7 Stronger aftertouch will decrease the volume

Env (Envelope)

The various parameters determine how the volume will change over time.

```

Edit/Timbre[1]/Level
  Env A=±0 D=±0 S=±0 R=±0
    
```

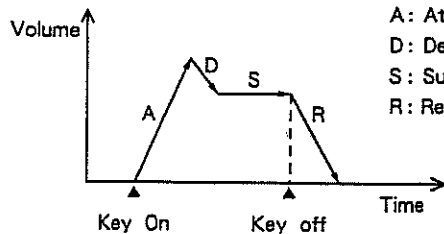

- A: Attack Rate (-7—+7) the rate at which the sound begins
- D: Decay Rate (-7—+7) the rate at which the sustain level is reached
- S: Sustain Level (-7—+7) the volume level at which the sounds is sustained.
- R: Release Rate (-7—+7) the rate at which the volume disappears

Attack Rate, Decay Rate, Release Rate

- ↑ +7 Changes more rapidly
- ↓ -7 Changes more slowly

Sustain Level

- ↑ +7 Increased volume
- ↓ -7 Decreased volume

* These envelope settings are relative to the envelope settings of the tone itself. By modifying the envelope parameters you can make the tone change relative to the envelope settings of the tone. Depending on the envelope of the selected tone, modifying these setting may have no effect.

■ Pitch

These settings determine the basic pitch of the timbre, and how the pitch is controlled.

* For some timbres, the pitch cannot be raised more than 1.5 octaves.

Pitch (Pitch Shift)

This shifts the basic pitch of the tone in relation to the master tune setting.

Coarse (pitch shift coarse) - 24 — + 24 : half-steps ± 2 octaves

Fine (pitch shift fine) - 50 — + 50 : units of 1 cent ± 50 cents

```

Edit/Timbre[1]/Pitch
Coarse=±0 Fine=±0 ▶
    
```

1 octave = 1200 cents = 12 half-steps
 100 cents = 1 half-step

Bender Range

This determines the range of the change in pitch when the bender lever is used to bend up or down.

Bend down (- 36, - 24, - 12—0) : - 3, - 2 octaves, half-steps (- 1—0 octave)

Bend up (0—12) : half-steps (0—1 octave)

```

Edit/Timbre[1]/Pitch
◀ Bender Range=▼-2 ▲2 ▶
    
```

Ch After Sens (Channel Aftertouch Sensitivity) - 36, - 24, - 12—+ 12

This determines how channel aftertouch will affect the pitch.

- 3, - 2 octaves, half-steps (- 1—+1 octave)

```

Edit/Timbre[1]/Pitch
◀ Ch After Sens=±0 ▶
    
```

↑	+ 12	Stronger aftertouch will raise the pitch
	:	
	± 0	Aftertouch will not affect the pitch
	:	
	- 12	
	- 24	
↓	- 36	Stronger aftertouch will lower the pitch

Poly After Sens (Polyphonic Aftertouch Sensitivity) - 36, - 24, - 12—+ 12

This determines how polyphonic aftertouch will affect the pitch.

- 3, - 2 octaves, half-steps (- 1—+1 octave)

```

Edit/Timbre[1]/Pitch
└ Poly After Sens=±0

```

Auto Bend

Auto bend is an effect which creates an automatic pitch-bend each time a sound is played.

Depth (- 36, - 24, - 12—+ 12) : Amount of pitch change

- 3, - 2, octaves, half-steps (- 1—+1 octave)

Rate (0—15) : Rate of pitch change

```

Edit/Timbre[1]/Pitch
└ Auto Bend Depth=±0

```

```

Edit/Timbre[1]/Pitch
└ Auto Bend Rate=15

```

↑ 15 Rapid change in pitch
↓ 0 Slow change in pitch

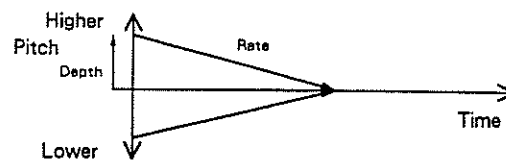
**Detune Depth 0—15**

This determines how greatly detune-type tones are detuned. This parameter is meaningful only when a detune-type tone is selected.

```

Edit/Timbre[1]/Pitch
└ Detune Depth=5

```

■ Vibrato

These settings determine how vibrato (cyclic change in pitch) is applied and controlled.

Rate 0—63

This determines the speed of the vibrato.

```
Edit/Timbre[1]/Vibrato
Rate=50 Waveform=Tri ▶
```

↑ 63 Fast vibrato
↓ 0 Modulation becomes slower

Waveform Tri, Sine, Square, SawUp, SawDown, Trill1, Trill2, Randm1—4

This selects the waveform of the LFO that creates vibrato.

```
Edit/Timbre[1]/Vibrato
Rate=50 Waveform=Tri ▶
```

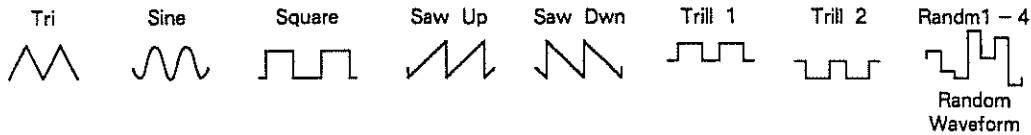

Depth 0—15

This selects the waveform of the LFO that creates vibrato.

```
Edit/Timbre[1]/Vibrato
◀Depth=0 Delay Time=0 ▶
```

Delay Time 0—15

This determines the time delay from when a note is played to when the vibrato begins.

```
Edit/Timbre[1]/Vibrato
◀Depth=0 Delay Time=0 ▶
```

Rise Time 0—15

This determines the time from when the vibrato begins to when the vibrato depth increases to the specified value.

```
Edit/Timbre[1]/Vibrato
◀ Rise Time=0 ▶
```

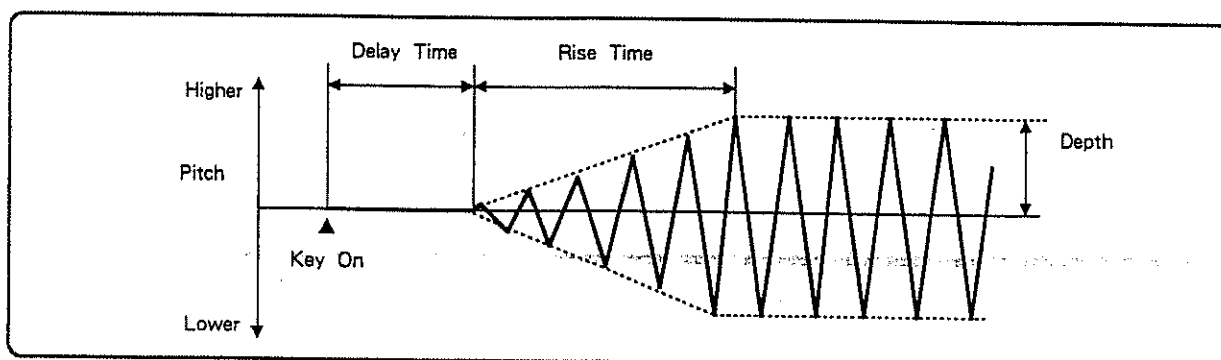
**Modulation Depth 0—15**

This determines how modulation data will affect the vibrato depth.

```

Edit/Timbre[1]/Vibrato
  Modulation Depth=12
  
```

Ch After Sens (Channel Aftertouch Sensitivity) 0—15

This determines how channel aftertouch will affect the amount of vibrato.

```

Edit/Timbre[1]/Vibrato
  Ch After Sens=0
  
```

Poly After Sens (Polyphonic Aftertouch Sensitivity) 0—15

This determines how polyphonic aftertouch will affect the amount of vibrato.

```

Edit/Timbre[1]/Vibrato
  Poly After Sens=0
  
```

d. Editing a rhythm set (Rhythm Setup)

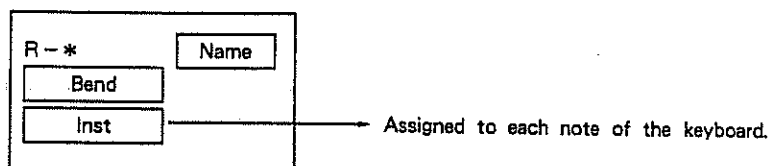

Four different Rhythm Sets can be created. A rhythm set plays a different rhythm sound for each note of the keyboard.

By changing the setting of a rhythm part, you can assign a different sound to each note, and adjust the balance using pan and level.

[Example operation]

② Use **◀ CURSOR ▶** to select "Rhythm" (blinking) and press **ENTER**

③ Use **◀ CURSOR ▶** to select "Inst" (blinking) and press **ENTER**

④ Use **◀ CURSOR ▶** to select "Tone" (blinking) and press **ENTER**

① Press **EDIT**

Use **◀ PART/INST ▶** to select the note name of the received note data

Use **◀ CURSOR ▶** to select the parameter you wish to modify

Use **▽ VALUE ▲** to modify the value

```

Edit/Rhythm/Inst/Tone
B1 :#Source=38 Mute=Off
    
```

* The value of the currently selected parameter will blink.

* Return to the play display by pressing **EXIT** several times.
(or hold **JUMP** and press **▽ VALUE**.)

■ Naming (Name)

Rhythm Name (Rhythm Set Name)

Each rhythm set can be given a 12-character name. Use **◀ CURSOR ▶** to move the cursor and use **▽ VALUE ▲** to change the character located at the cursor.

* The following characters can be used : space A—Z a—z 0—9 - / + * . , ; = ! " # \$ % & ' () < > { } [] _ ? `

```

Edit/Rhythm/Name
Rhythm Name=Standard Set
    
```

■ Bender (Bend)

Bender Range

This determines the range of the pitch change when the bender lever is used to bend up or down.

Bend down (-36, -24, -12—±0) : -3, -2, -1—0 octave

Bend up (0—12) : half-steps (0—1 octave)

```

Edit/Rhythm/Bender
Bender Range=7-2 2
    
```

■ Inst

These settings determine the instruments assigned to the rhythm set, and how they will sound and be output.

```

Edit/Rhythm/Inst/Level
B1 :Level=31 U.Sens=+7▶
  
```

When ▶ is displayed you can set the map from the U-220's controls.

- When making instrument settings, you can select the key to assign (the key to edit) from the U-220 or from a MIDI keyboard. Use the following procedure.

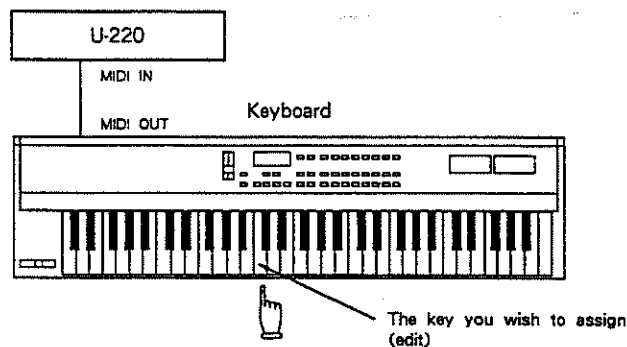

[Procedure]

- ① While holding **JUMP** press **MARK**.

```

Edit/Rhythm/Inst/Level
B1 >Level=31 U.Sens=+7▶
  
```

A The key you wish to assign (edit) B

▶ will change to >.

- ② When note data is transmitted from the connected keyboard, the display of A will change to indicate that note, and at the same time the settings B for that note will also change.
- ③ Use **◀** CURSOR **▶** to move the cursor to B, and use **▽** VALUE **△** to set the parameter values.

By repeating steps ② and ③ with the cursor in position B, you can select the keys you want to assign (edit) from the keyboard.

* Make sure that the transmission channel of the keyboard matches the reception channel of the U-220 (page 59). The keyboard must transmit note data on the same channel as received by the part you are editing.

- ④ Once again, while holding **JUMP** press **MARK** and the > will return to ▶. When ▶ is displayed, specify key numbers from the U-220 front panel.

● Tone

These settings select the tones assigned to the rhythm set.

Tone (Tone Number, Tone Select)

This selects the tone that is played by each key. For a rhythm set, a single tone consists of a tone number, tone name, and source number.

You can also select a tone other than the drum tone (1—128 Drums).

A : When using an internal tone, select I.

When using a PCM card tone, select the card number 1—31.

B : Select the tone number (1—128)

```

Edit/Rhythm/Inst/Tone
B1 : I-128 DRUMS
  
```

A B

Source (Source Number) 1—127

Each rhythm tone (tone no. 1-128 Drums) has tone numbers assigned to it (page 129).

This parameter determines the key number of the tone which corresponds to the note name of the received note event.

```

Edit/Rhythm/Inst/Tone
B1 : Source=38 Mute=Off
  
```

Note name of the received note data Key number assigned to the rhythm tone (page 129)

Mute B1—D7

This parameter allows the specified tone be muted by a received note event of the specified key number.

```

Edit/Rhythm/Inst/Tone
B1 : Source=42 Mute=F#2
  
```

(Example) The sound that began playing in response to a A # 2 note event will be muted by a F # 2 note event.

● Level

Level 0—31

By adjusting the volume level of each key, you can regulate the volume balance with the sounds of other keys.

```

Edit/Rhythm/Inst/Level
B1 :Level=31  U.Sens=+7▶
  
```

V.Sens (Velocity Sensitivity) -7—+7

This determines how the volume will change in response to the velocity of a received note event.

```

Edit/Rhythm/Inst/Level
B1 :Level=31  U.Sens=+7▶
  
```

↑ +7 Strongly played notes will be louder
 0 Velocity will not affect the volume
 ↓ -7 Strongly played notes will be softer

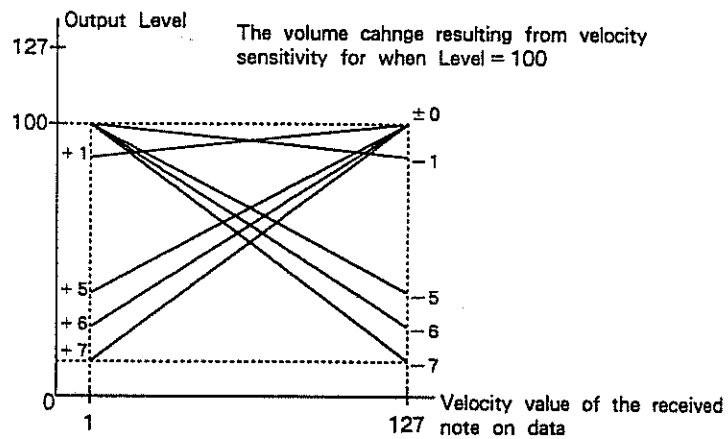

Env Mode (Envelope Mode) Sustain, NoSustain

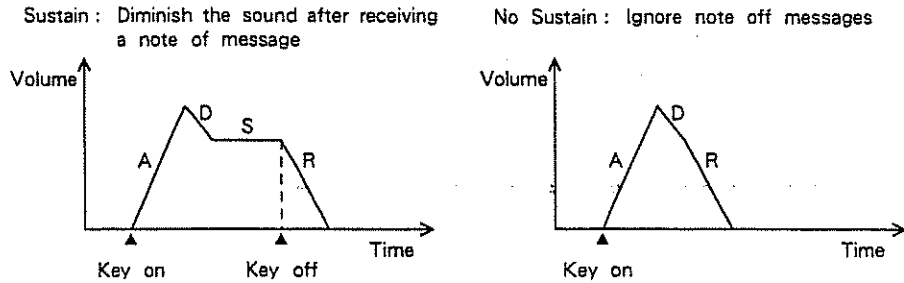

```

Edit/Rhythm/Inst/Level
B1 :◀Env Mode=NoSustain▶
    
```

When playing the rhythm part from a rhythm machine (or a sequencer that has a rhythm track) that transmits note events with a short gate time (i.e., if the note off messages come immediately after the note on messages), you should set this parameter to NoSustain.

Env (Envelope)

This adjusts the volume envelope (the volume change over time).

- A : Attack rate (-7 - +7)
- D : Decay rate (-7 - +7)
- R : Release rate (-7 - +7)

↑ +7 Faster change
 ↓ -7 Slower change

```

Edit/Rhythm/Inst/Level
B1 :◀Env A=±0 D=±0 R=±0▶
    
```

* These settings are relative to the envelope settings of the tone. Depending on the envelope of the selected tone, modifying these setting may have no effect.

● **Pitch**

These settings determine the pitch of the instrument assigned to each key, and how the pitch will change.

* For some instruments, the pitch cannot be raised more than 1.5 octaves.

Pitch Shift

This adjusts the pitch of the tone.

Coarse (pitch shift coarse) - 36, - 24, - 12—+ 12 :
- 3, - 2, - 1—+1 octaves(half-step units)

Fine (pitch shift fine) - .50—+.50 : units of 1 cent

```

Edit/Rhythm/Inst/Pitch
B1 : Coarse=±0 Fine=±0 ▶

```

Ch After Sens (Channel Aftertouch Sensitivity) - 36, - 24, - 12—+ 12

This determines how the pitch will be affected by channel aftertouch messages.

```

Edit/Rhythm/Inst/Pitch
B1 : Ch After Sens=±0 ▶

```

```

↑ +12 Stronger aftertouch will raise the pitch
  ± 0 Aftertouch will not affect the pitch
  -12
  -24
  -36 Stronger aftertouch will lower the pitch

```

Poly After Sens (Polyphonic Aftertouch Sensitivity) - 36, - 24, - 12—+ 12

This determines how polyphonic aftertouch will affect pitch.

```

Edit/Rhythm/Inst/Pitch
B1 : Poly Aft Sens=±0 ▶

```

Pitch Randomize 0—15

This determines the amount of random pitch change that will occur each time a note is played.

```

Edit/Rhythm/Inst/Pitch
B1 : Pitch Randomize=0 ▶

```

```

↑ 15 Much random pitch change
  0 No random pitch change

```

Auto Bend Dpth
Auto Bend Rate

The auto bend effect creates an automatic pitch bend for each note.

```
Edit/Rhythm/Inst/Pitch  
B1 :◀Auto Bend Dpth=±0 ▶
```

```
Edit/Rhythm/Inst/Pitch  
B1 :◀Auto Bend Rate= 0 ▶
```

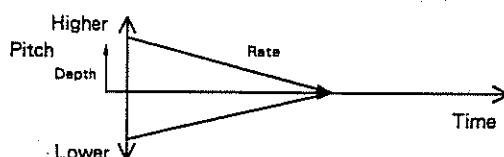

Depth (-36, -24, -12--+12) :

the amount of pitch change (-3, -2, -1--+1 octaves)

Rate (0-15) : the speed of pitch change

- ↑ 15 Rapid pitch change
- ↓ 0 Slow pitch change

Detune Depth 0-15

This determines how greatly the pitch of the two sounds in a detune-type tone will be spread apart.

This parameter is effective only when a detune-type tone is selected. (see page 65, 126.)

```
Edit/Rhythm/Inst/Pitch  
B1 :◀ Detune Depth=0
```

● Output

Output (Output Assign) Dry, Rev, Cho, Dir1

This selects the effect (chorus, reverb/delay) for the tone. Chorus will be applied according to the chorus output mode (patch) settings (page 54).

```

Edit/Rhythm/Inst/Output
B1 : Assign=Dry Pan=7<

```

Output Mode	Effect	Output Jacks
Dry	No effect is used	MIX OUT
Rev	Only Reverb	
Cho	Pre Rev : Chorus and Reverb Post Rev : Only Chorus	
Dir 1	No effect is used	DIRECT OUT 1

* When a plug is not inserted into the DIRECT OUT jacks, the sound will be output from MIX OUT even if you have selected Dir 1.

* DIRECT OUT 2 cannot be used.

Pan 7 >—><—< 7, Rnd

This determines the pan (stereo position).

```

Edit/Rhythm/Inst/Output
B1 : Assign=Dry Pan=7<

```

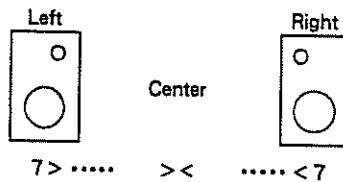

** When Rnd is selected, pan will change randomly each time a note is played.

3. Data Mode (Data)

In data mode you can store edited settings and organize data. This mode includes functions that allow you to “write”, “transmit via MIDI”, or “initialize” edited patches or timbres, and functions such as ROM play and “MIDI monitor”.

a. Write procedure (Write)

This operation stores edited settings by parameter group into the memory area. In addition to the normal write operation, “exchange” and “copy” operations are provided to help you organize your data.

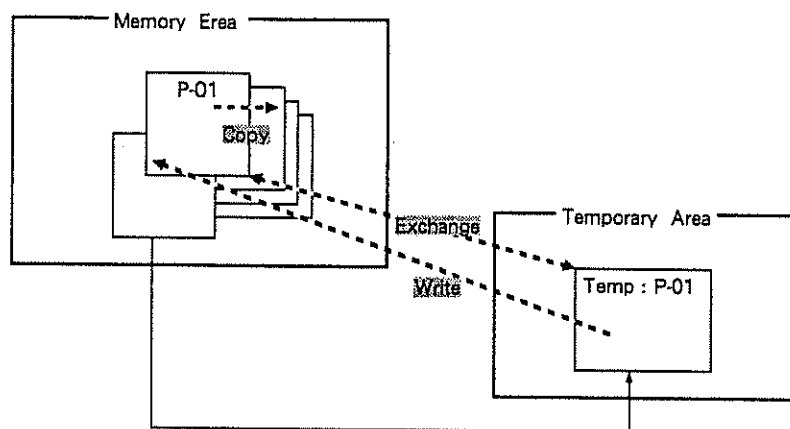

* It is not necessary to write Setup settings.

The Renumber function

A patch selects sounds by specifying a timbre number for each part. When you edit a timbre used by a patch and then write that timbre into another timbre memory, the patch settings must be modified so that the memory of the newly edited timbre is specified.

This is what the renumber function automatically does. When you write an edited timbre into another timbre memory, the renumber function will modify (renumber) the timbre selections in each patch that uses the newly edited timbre. If you use the renumber function, you won't have to modify the timbre selections for patches in the memory area.

The renumber function can also be used when copying.

(Example) If after editing timbre T-001 you write or copy it into memory area T-002, all patches P-01—P-64 which specify timbre number T-001 will be modified to specify timbre number T-002.

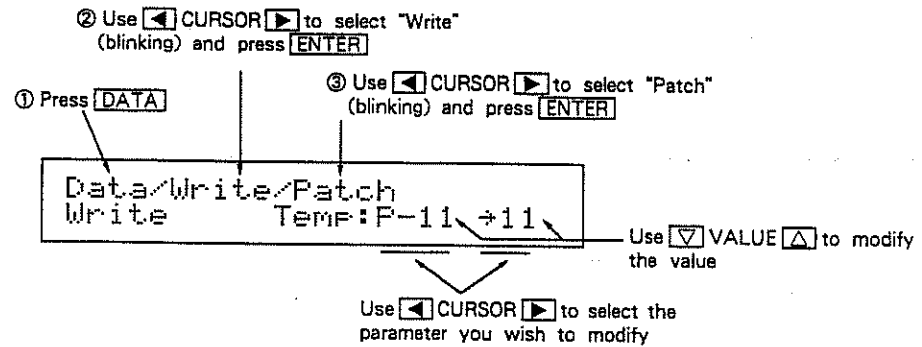
[Example operation]

* The value of the currently selected parameter will blink.

After specifying the value, press **ENTER**.

```

Data/Write/Patch
Sure? [VALUE▲] / [EXIT]
  
```

* You will be asked if you are sure.

* Check the settings once again. If you decide to change the settings then press **EXIT** and you will return to the write setting display.

If you are sure that you want to write the data, press **VALUE** **△**.

```

Data/Write/Patch
Function Completed.
  
```



and after few seconds

```

Data/Write/Patch
Write      Temp:P-11 →11
  
```

To return to the play display press **EXIT** several times (or hold **JUMP** and press **▽** VALUE).

This completes the procedure.

■ Patch Write, Exchange, Copy, Part Copy

Edited settings are temporary. If you select another patch, new data will be read into the temporary area and the settings of the previous patch will be lost. If you want to keep your edited settings you must use the patch write operation.

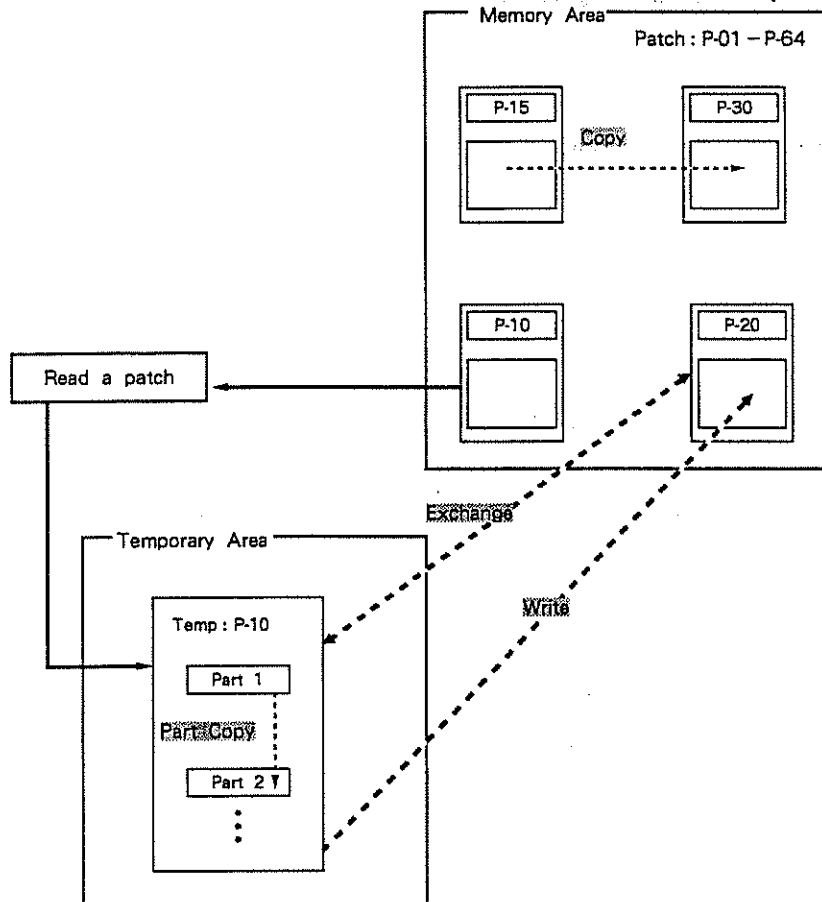

- Patch settings in the temporary will be preserved even when the power is turned off.

Write

This operation writes edited patch settings into a patch in the memory area.

```
Data/Write/Patch
Write      Temp:P-11 →11
```

The number of the patch currently in the temporary area

The patch number of the destination (memory area)

Exchange

This operation exchanges the edited patch settings with a patch in the memory area. This allows you to compare the edited patch settings with the patch settings in the memory area. To compare the edited and unedited patches, specify the same patch number when exchanging.

* After exchanging, the patch settings in the temporary area will automatically become the patch in the memory area.

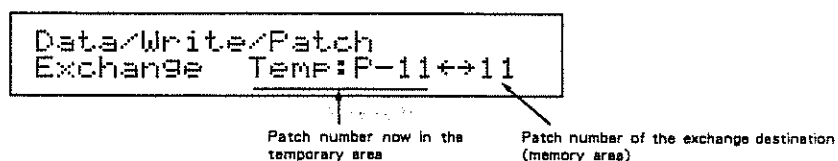

Copy

This function copies the settings of a specified patch in the memory area to another patch number. Or you can specify a range of two or more patch numbers to be copied to a specified patch number and following patches.

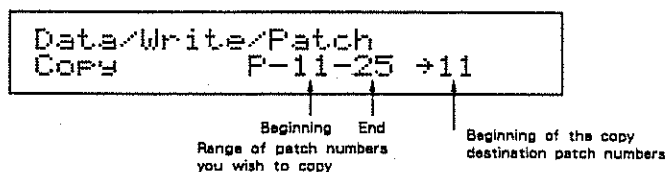

Part Copy

This function copies the settings of a part in the currently edited patch to another part in the patch. This is convenient when setting two parts in a patch to the same settings.



* Copied part settings are temporary. If you want to keep the copied part settings you must use the patch write operation.

Timbre Write, Write + Ren, Exchange, Copy, Copy + Ren

Edited timbre settings are temporary. If you select another timbre, new data will be read into the temporary area and the settings of the previous timbre will be lost. If you want to keep your edited settings you must use the timbre write operation.

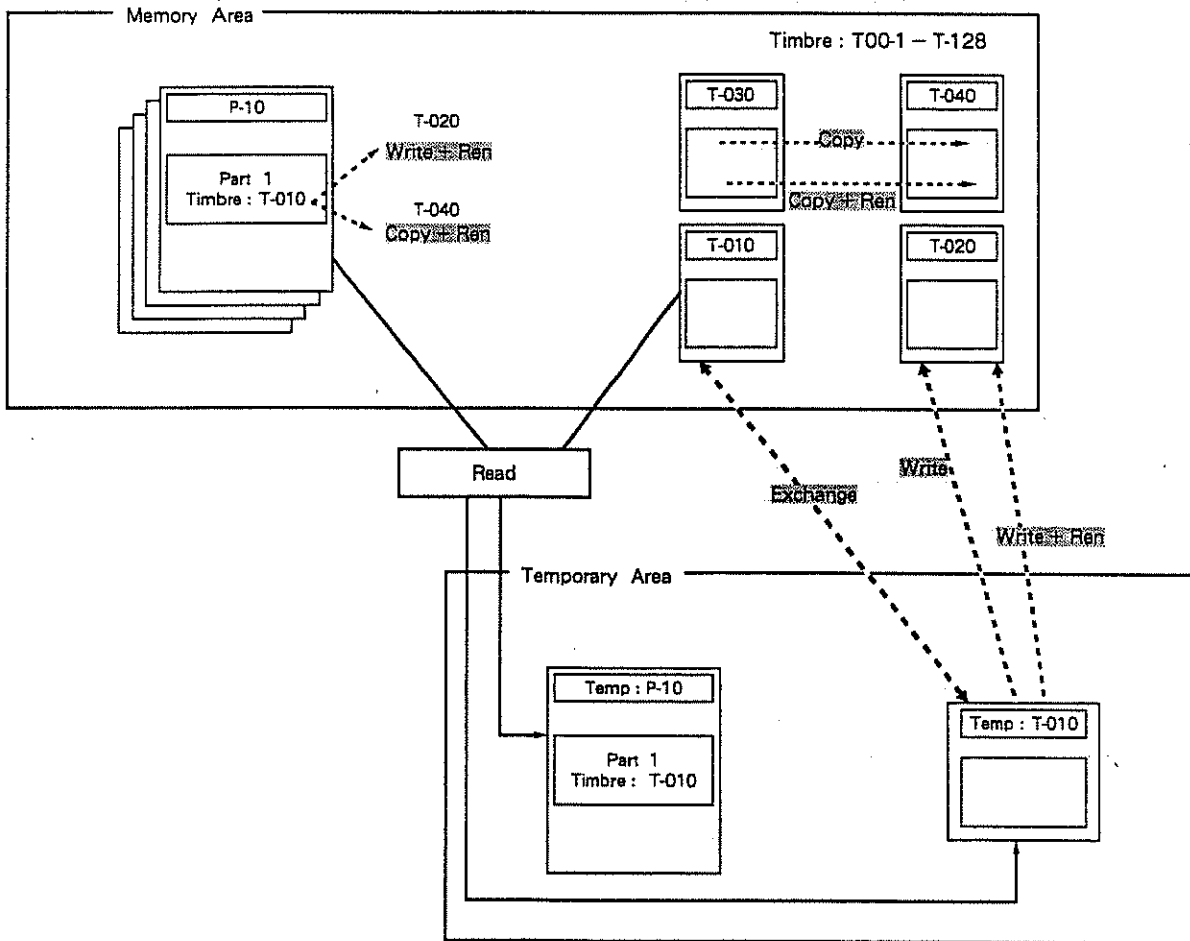

Write

This operation stores edited timbre settings into a memory area timbre.

```
Data/Write/Timbre[1]
Write   Tmp:T-011 →011
```

Timbre number now in the temporary area

Timbre number of the writing destination (memory area)

Write + Ren (Write + Renumber)

This operation stores edited timbre settings into the memory area and at the same time re-writes the timbre numbers of all other patches which specify that timbre.

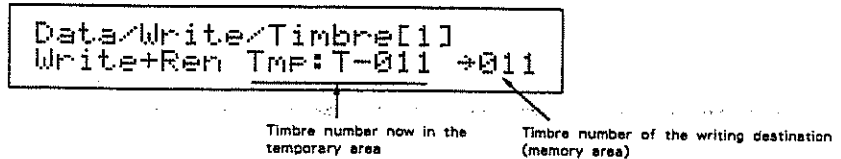
**Exchange**

This operation exchanges the edited timbre settings with timbre settings from the memory area. This allows you to compare edited settings with settings in memory. To compare the edited and unedited settings, specify the same timbre number for exchange.

* When the exchange operation is executed, timbre settings in the temporary area will automatically become a timbre in the memory area.

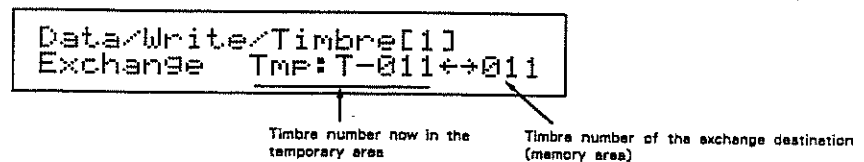
**Copy**

This operation copies a specified timbre from the memory area into another timbre in the memory area. It is also possible to specify two or more timbres to be copied into the specified destination and the following memories.

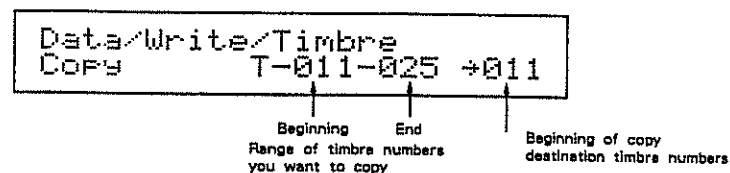
**Copy + Ren (Copy + Renumber)**

This function copies a specified timbre from the memory area into another timbre in the memory area, and at the same time automatically re-writes the timbre numbers for all patches which use that timbre.

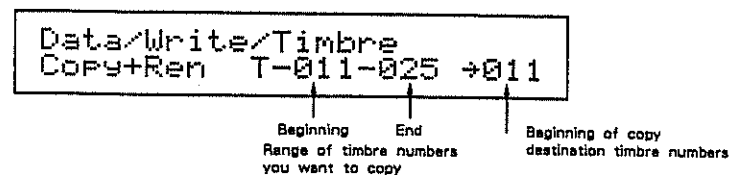

■ Rhythm Set (Rhythm Setup) Write, Write + Ren, Exchange, Copy, Copy + Ren

Edited rhythm set settings are temporary. If you select another rhythm set, new data will be read into the temporary area and the settings of the previous rhythm set will be lost. If you want to keep your edited settings you must use the rhythm set write operation.

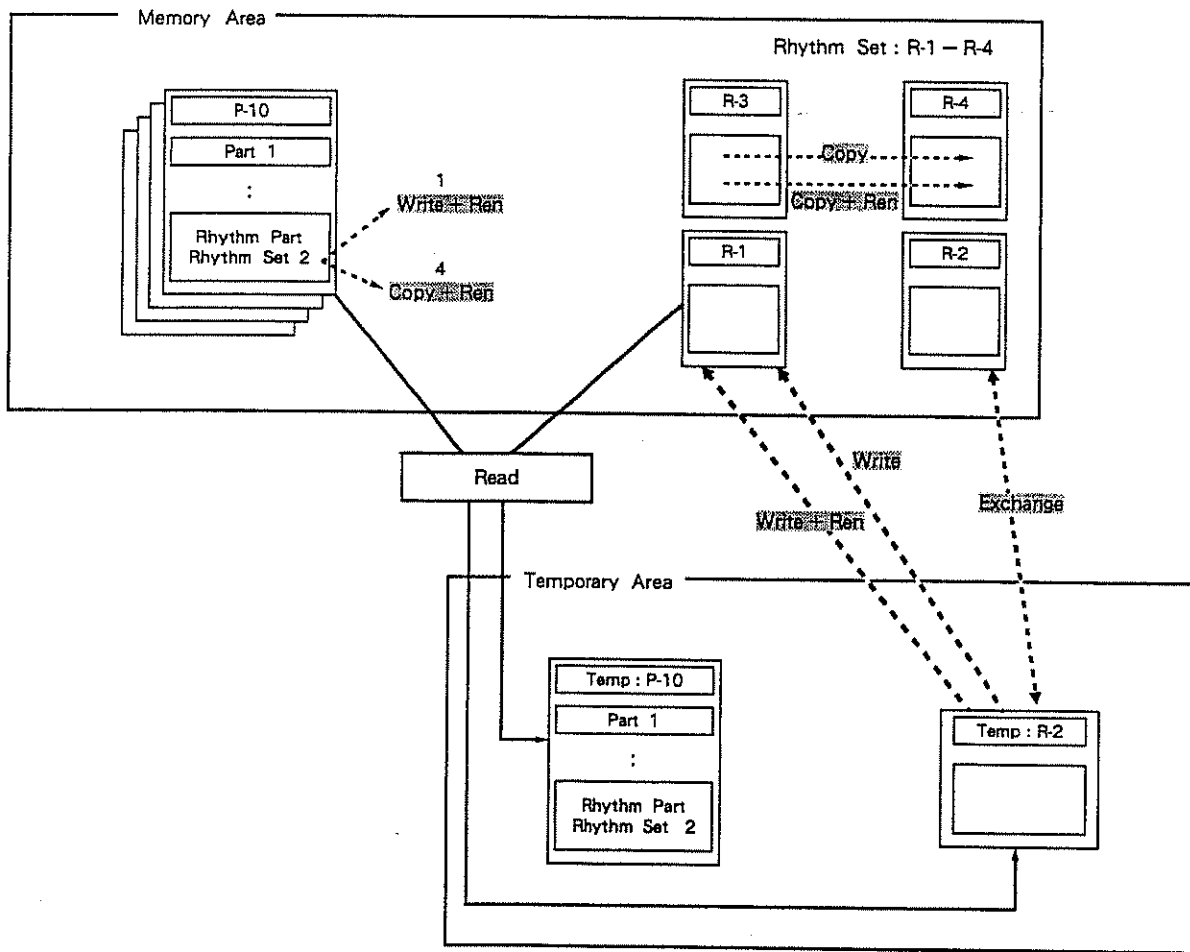

Write

This operation stores edited rhythm set settings into a memory area rhythm set number.

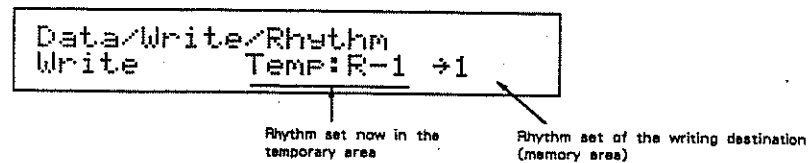

Write + Ren (Write + Renumber)

This operation stores edited rhythm set settings into the memory area and at the same time re-writes the rhythm set number of all other patches which specify that rhythm set.

```
Data/Write/Rhythm
Write+Ren Temp:R-1 →1
```

Rhythm set now in the temporary area

Rhythm set of the writing destination (memory area)

Exchange

This operation exchanges the edited rhythm set settings with rhythm set settings from the memory area. This allows you to compare edited settings with settings in memory. To compare the edited and unedited settings, specify the same rhythm set number for exchange.

```
Data/Write/Rhythm
Exchange Temp:R-1 ↔1
```

Rhythm set now in the temporary area

Rhythm set of the exchange destination (memory area)

Copy

This operation copies a specified rhythm set from the memory area into another rhythm set in the memory area. It is also possible to specify two or more rhythm sets to be copied into the specified destination and the following memories.

```
Data/Write/Rhythm
Copy R-1 →1
```

Rhythm set number you want to copy

Copy destination rhythm set number

Copy + Ren (Copy + Renumber)

This function copies a specified rhythm set from the memory area into another rhythm set in the memory area, and at the same time automatically re-writes the rhythm set number for all patches which use that timbre.

```
Data/Write/Rhythm
Copy+Ren R-1 →1
```

Rhythm set number you want to copy

Copy destination rhythm set number

c. Bulk Dump

The dump function allows you to set another U-220 to the same settings, or to transmit data to a sequencer for storage. Data stored in a sequencer can be transmitted back to the U-220 to restore the previous setup.

Data is transmitted as a system exclusive message.

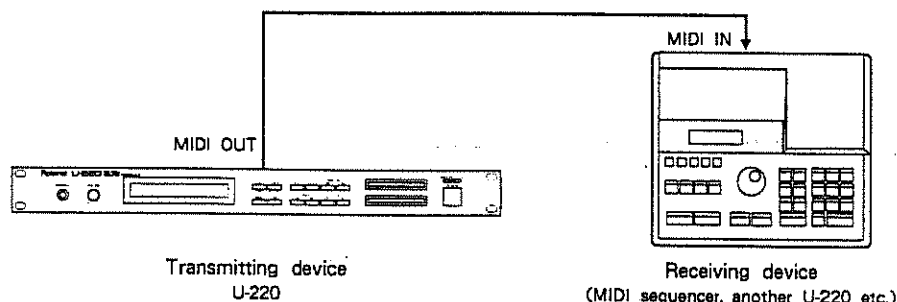

The dump function transmits data one way. In one-way transmission, the data is transmitted regardless of the condition of the receiving device.

- * Be sure to set the transmitting device and the receiving device to the same device ID number. If the two device IDs do not match, the data will not be received (see page 48). Set the exclusive reception switch of the receiving device on. (Rx SysEx = On : see page 48.)
- * It is not possible to transmit the setting of the exclusive reception switch or the value of the device ID.

[Example]

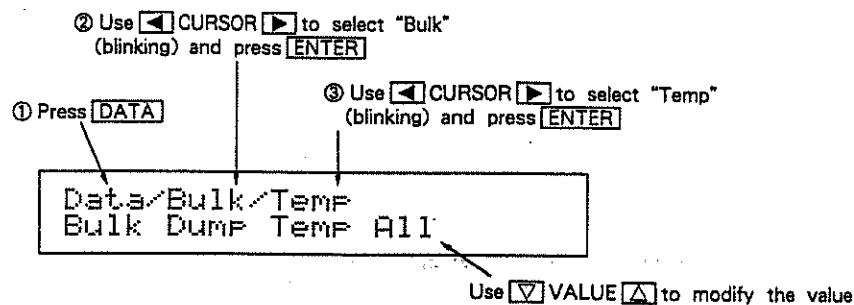

* The value of the currently selected parameter will blink.

After you have set the values, press **ENTER**.

```
Data/Bulk/Temp
Transmitting SysEx.
```

* Data is being transmitted.

```
Data/Bulk/Temp
Function Completed.
```



and after few seconds

```
Data/Bulk/Temp
Bulk Dump Temp All
```

To return to the play display press **EXIT** several times
(or hold **JUMP** and press **▽** VALUE).

This completes the procedure.

Data Groups for Transmission

Type of Data	Data Group	Transmitted Data
All	All	all data in Temp, Memory, Setup
Setup	All	all Setup data
	Param	Master Tune, Effect, LCD, MIDI (except maps)
	Map/All	all maps
	Map/Patch Map	Patch maps : select from 1, 2, 3, 4, 1-4
	Map/Timbre Map	Timbre maps : select from 1, 2, 3, 4, 1-4
	Map/Rhythm Map	Rhythm maps : select from 1, 2, 3, 4, 1-4
Temp	Map/R. Inst Map	Rhythm Inst maps : select from 1, 2, 3, 4, 1-4
	Temp All	all data in the temporary area
	Patch	the patch in the temporary area
	Timbre1	timbre assigned to part 1
	Timbre2	timbre assigned to part 2
	Timbre3	timbre assigned to part 3
	Timbre4	timbre assigned to part 4
	Timbre5	timbre assigned to part 5
Timbre6	timbre assigned to part 6	
Timbre1-6	timbre assigned to part 1-6	
Rhythm Set	rhythm set assigned to the rhythm part	
Memory	All	all data in the memory area
	Patch	Patch (select from 1-64)
	Timbre	Timbre (select from 1-128)
	Rhythm	Rhythm Set (select from 1-4)

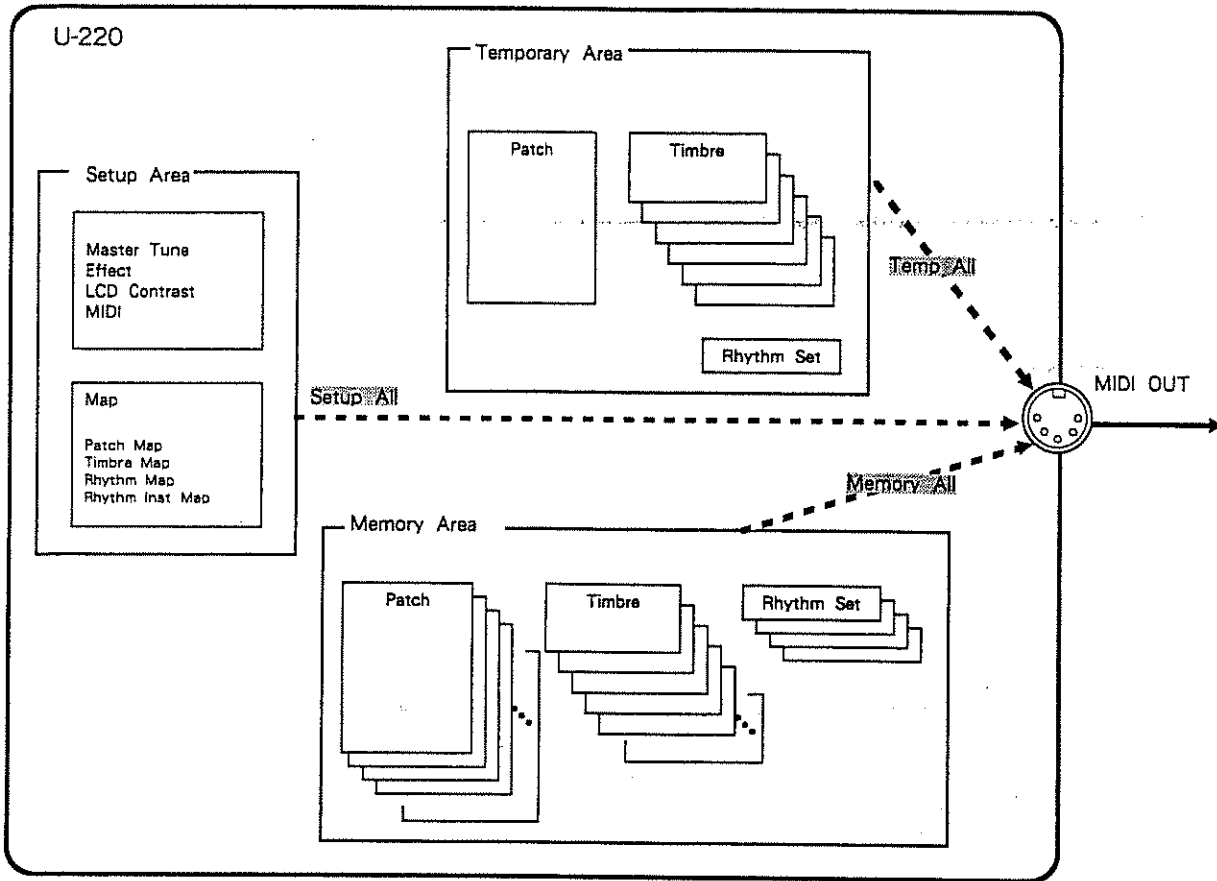

■ All data (All)

All

This operation transmits all data from the setup area, memory area, and temporary area.

Transmitted data : Temp, Memory, Setup

```
Data/Bulk/All
Bulk DUMP All
```

■ Setup data (Setup)

All

This operation transmits all setup data...

Transmitted data : M.Tune, Effect, LCD, MIDI, Map

```
Data/Bulk/Setup/All
Bulk DUMP Setup All
```

Param (Setup/parameter)

This operation transmits all parameter values in the setup data other than maps.

```
Data/Bulk/Setup/Param
Bulk DUMP Setup Param
```

* Parameters other than maps cannot be transmitted individually.

Map/All Patch, Timbre, Rhythm, Rhythm Inst

This operation transmits all map settings.

```
Data/Bulk/Setup/Map/All
Bulk DUMP Map All
```

Map/Patch Map1, 2, 3, 4, 1-4

This operation transmits patch map settings.

```
Data/Bulk/Setup/Map/Ptch
Bulk DUMP Patch Map1-4
```

Map/Timbre Map1, 2, 3, 4, 1-4

This operation transmits timbre map settings.

```
Data/Bulk/Setup/Map/Tmbr
Bulk DUMP Timbre Map1-4
```

Map/Rhythm Map1, 2, 3, 4, 1-4

This operation transmits rhythm map settings.

```
Data/Bulk/Setup/Map/Rytm
Bulk DUMP Rhythm Map1-4
```

Map / R.Inst (Rhythm Inst) Map1, 2, 3, 4, 1-4

This operation transmits rhythm instrument map settings.

```
Data/Bulk/Setup/Map/RIns  
Bulk DUMP R.Inst Map1-4
```

■ Temporary (Temp) All, Patch, Timbre1, 2, 3, 4, 5, 6, 1-6, Rhythm Set

This operation transmits data from the temporary area (the data being edited).

```
Data/Bulk/Temp  
Bulk DUMP TEMP All
```

■ Memory (Memory)

All Patch × 64, Timbre × 128, Rhythm Set × 4

This function transmits all data from the memory area.

```
Data/Bulk/Memory/All  
Bulk DUMP Memory All
```

Patch 1-64

This function transmits patch settings from the memory area. Specify the patch 1-64 that will be transmitted.

```
Data/Bulk/Memory/Patch  
Bulk DUMP P-01-20
```

Timbre 1-128

This function transmits timbre settings from the memory area. Specify the timbre 1-128 that will be transmitted.

```
Data/Bulk/Memory/Timbre  
Bulk DUMP T-001-020
```

Rhythm 1-4

This function transmits rhythm set settings from the memory area. Specify the rhythm set 1-4 that will be transmitted.

```
Data/Bulk/Memory/Rhythm  
Bulk DUMP R-1-3
```

c. Initialize

These functions initialize data.

- * Initializing setup or jump page data will restore it to the factory settings.
- * When temporary area data (the data being edited) is initialized, it will be set to the values listed on page 130.
- * To set all data to the factory settings, consult your nearby Roland service center.

【Example operation】

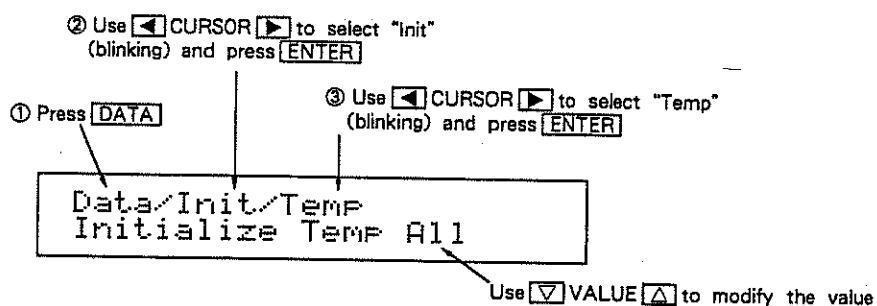

* The value of the currently selected parameter will blink.

After you have set the values, press .

```

Data/Init/Temp
Sure? [VALUE] / [EXIT]
  
```

- * The display will ask you for confirmation.
- * Check the settings once again. If you decide to modify the settings then press and you will return to the setting display.

If you are sure you want to initialize the data press VALUE .

```

Data/Init/Temp
Function Completed.
  
```



and after a few seconds

```

Data/Init/Temp
Initialize Temp All
  
```

To return to the play display press **EXIT** several times.

(or hold **JUMP** and press **▽** VALUE).

This completes the procedure.

Data Groups for Initialization

Type of Data	Data Group	Initialized Data
All	All	all data in Temporary and Setup, and jump page data
Setup	All Param Map/All Map/Patch Map Map/Timbre Map Map/Rhythm Map Map/R.Inst Map	all setup data Master Tune, Effect, LCD, MIDI (exsept maps) all maps Patch maps : select for 1, 2, 3, 4, 1-4 Timbre maps : select for 1, 2, 3, 4, 1-4 Rhythm maps : select for 1, 2, 3, 4, 1-4 Rhythm Inst maps : select for 1, 2, 3, 4, 1-4
TEMP	TEMP All Patch Part 1 Part 2 Part 3 Part 4 Part 5 Part 6 Rhythm Part Timbre 1 Timbre 2 Timbre 3 Timbre 4 Timbre 5 Timbre 6 Timbre 1-6 Rhythm Set	all data in the temporary area the patch in the temporary area settings for part 1 settings for part 2 settings for part 3 settings for part 4 settings for part 5 settings for part 6 settings for the rhythm part timbre assigned to part 1 timbre assigned to part 2 timbre assigned to part 3 timbre assigned to part 4 timbre assigned to part 5 timbre assigned to part 6 timbre assigned to part 1-6 rhythm set assigned to the rhythm part
JUMP Page	Jump Page	jump page displays you set

■ All data (All)

All

This operation initializes all data in the temporary area, all data in the setup area, and the jump page data.

Initialized data : Temp, Setup, Jump Page

```
Data/Init/All
Initialize All
```

■ Setup data (Setup)

All

This operation initializes all data in the setup area.

Initialized data M.Tune, Effect, LCD, MIDI, Map

```
Data/Init/Setup/All
Initialize Setup All
```

Param (Parameter)

This operation initializes all setup data parameter values except maps.

Initialized data : M.Tune, Effect, LCD, MIDI

```
Data/Init/Setup/Param
Initialize Setup Param
```

* It is not possible to initialize individual parameters other than maps.

Map / All Patch, Timbre, Rhythm, Rhythm Inst

This operation initializes all maps.

```
Data/Init/Setup/Map/All
Initialize Map All
```

Map / Patch Map1, 2, 3, 4, 1-4

This operation initializes patch maps.

```
Data/Init/Setup/Map/Ptch
Initialize Patch Map1-4
```

Map / Timbre Map1, 2, 3, 4, 1—4

This operation initializes timbre maps.

```
Data/Init/Setup/Map/Tmbr  
Initialize Timbre Map1-4
```

Map / Rhythm Map1, 2, 3, 4, 1—4

This operation initializes rhythm maps.

```
Data/Init/Setup/Map/Rytm  
Initialize Rhythm Map1-4
```

Map / R.Inst (Rhythm Inst) Map1, 2, 3, 1—4

This operation initializes rhythm instrument maps.

```
Data/Init/Setup/Map/RIns  
Initialize R.Inst Map1-4
```

■ **Temporary (Temp)**

All, Patch, Part1, 2, 3, 4, 5, 6, Rhythm Part, Timbre1, 2, 3, 4, 5, 6, 1—6,
Rhythm Set

This operation initializes data in the temporary area (the data being edited).

```
Data/Init/Temp  
Initialize Temp All
```

■ **Jump page**

Jump Page

This operation initializes the jump page settings.

```
Data/Init/Jump Page  
Initialize Jump Page
```

d. Utility

【Example operation】

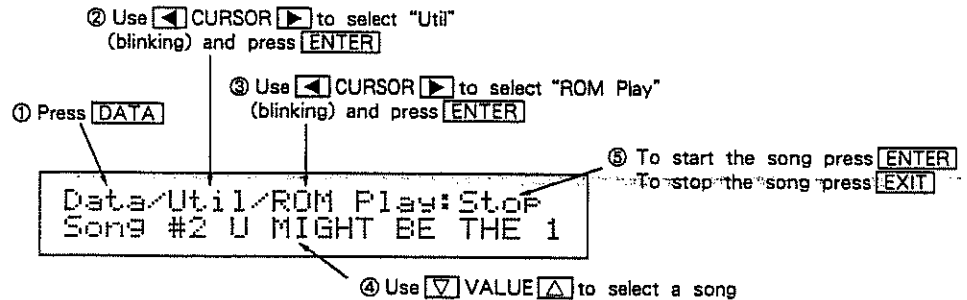

* The value of the currently selected parameter will blink.

* Return to the play display by pressing **EXIT** several times.
(or hold **JUMP** and press **▽ VALUE**.)

■ ROM Play

The U-220 has two demonstration songs that take advantage of its multi-timbral capabilities. For details refer to "Listening to ROM Play" (page 5).

```

Data/Util/ROM Play: Stop
Song #1 HIGHLANDER
  
```

■ MIDI Monitor

The MIDI Monitor function allows you to view the data that is being received by the U-220 from an external MIDI device.

The MIDI Monitor puts the data received from MIDI IN into a monitoring buffer, and displays it in hexadecimal form. The buffer can hold 256 bytes.

When new data is received, the old data will be overwritten starting with the oldest data.

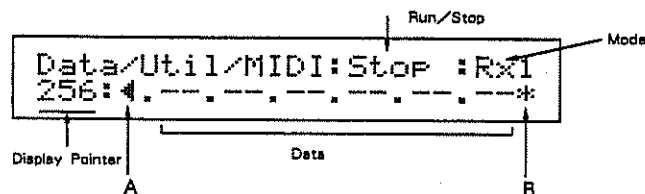

In the MIDI Monitor display, you can set the following parameters to determine how MIDI data will be monitored.

RUN / STOP

While this is set to RUN, incoming data will be received into the monitor buffer. Data will continue to be received even if you move to another display.

When this is set to STOP, data reception will stop.

* Use **◀ CURSOR ▶** to select Run/Stop and use **▽ VALUE ▲** to switch the setting.

Mode (Rx1, Rx2)

This determines how data will be received into the monitor buffer.

Rx1 : All incoming MIDI data will be monitored

Rx2 : All incoming MIDI data except for realtime messages will be monitored

- * When you change the mode setting, all data in the buffer will be cleared.
- * Realtime messages are used mainly to synchronize sequencers and rhythm machines. Active sensing is included in realtime messages.
- * Use CURSOR to make Rx1 or Rx2 blink, and use VALUE to switch the monitoring mode.

About the MIDI monitor Display

Display Pointer

The display pointer indicates the position in the data buffer which the currently displayed data occupies. If the display pointer is 256, the most recently received data is being displayed.

- * If new data is received during RUN, the display pointer will automatically be set to 256.
- * Use PART / INST to move the display pointer and scroll through the entire data buffer to see all the data in the buffer.

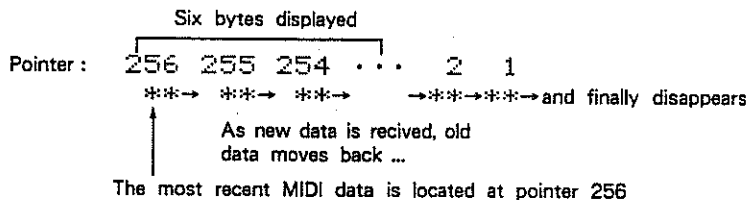

Data Level

MIDI data is displayed in hexadecimal notation. "—" indicates that MIDI data has not yet been received. One of the following symbols will be displayed in front of each MIDI data byte to indicate the type of data.

- _ : 00—7F, F7 (data bytes, EOX)
- / : 80—F6 (status bytes)
- . : F8—FE (realtime messages)

A, B

If data exists in the buffer before or after the displayed data, "A" or "B" will be displayed to indicate this. Immediately after MIDI data is received, B will show "B".

- * When the power is turned on, the monitor buffer will be empty and the monitor will be set to STOP.

Chapter 5 Basic Procedures

This chapter explains basic procedures for various operations. Refer to this chapter when you want to create your own sounds or use the performance functions.

1. How to adjust the volume

How to adjust the volume of the entire U-220

Adjust the VOLUME knob.

How to adjust the volume by playing notes strongly or softly

Modify the velocity sensitivity.

```
Edit/Timbre[1]/Level
Level=100 Velo Sens=000 ▶
```

↑ +7 Strongly played notes will be louder
0 Velocity will not affect volume
↓ -7 Strongly played notes will be softer

How to adjust the volume by pressing down on the keyboard

Modify the channel aftertouch sensitivity.

```
Edit/Timbre[1]/Level
Level=100 Velo Sens=000 ▶
```

← CURSOR ▶

```
Edit/Timbre[1]/Level
Ch After Sens=000 ▶
```

↑ +7 Stronger aftertouch will increase the volume
0 Aftertouch will not affect volume
↓ -7 Stronger aftertouch will decrease the volume

How to adjust the volume of sound without affecting the part level

Modify the timbre level.

```
Edit/Timbre[1]/Level
Level=000 Velo Sens=+7 ▶
```

How to adjust the balance of instruments in the rhythm

Modify the rhythm inst level.

```
Edit/Rhythm/Inst/Level
B1 :Level=000 U.Sens=+7 ▶
```

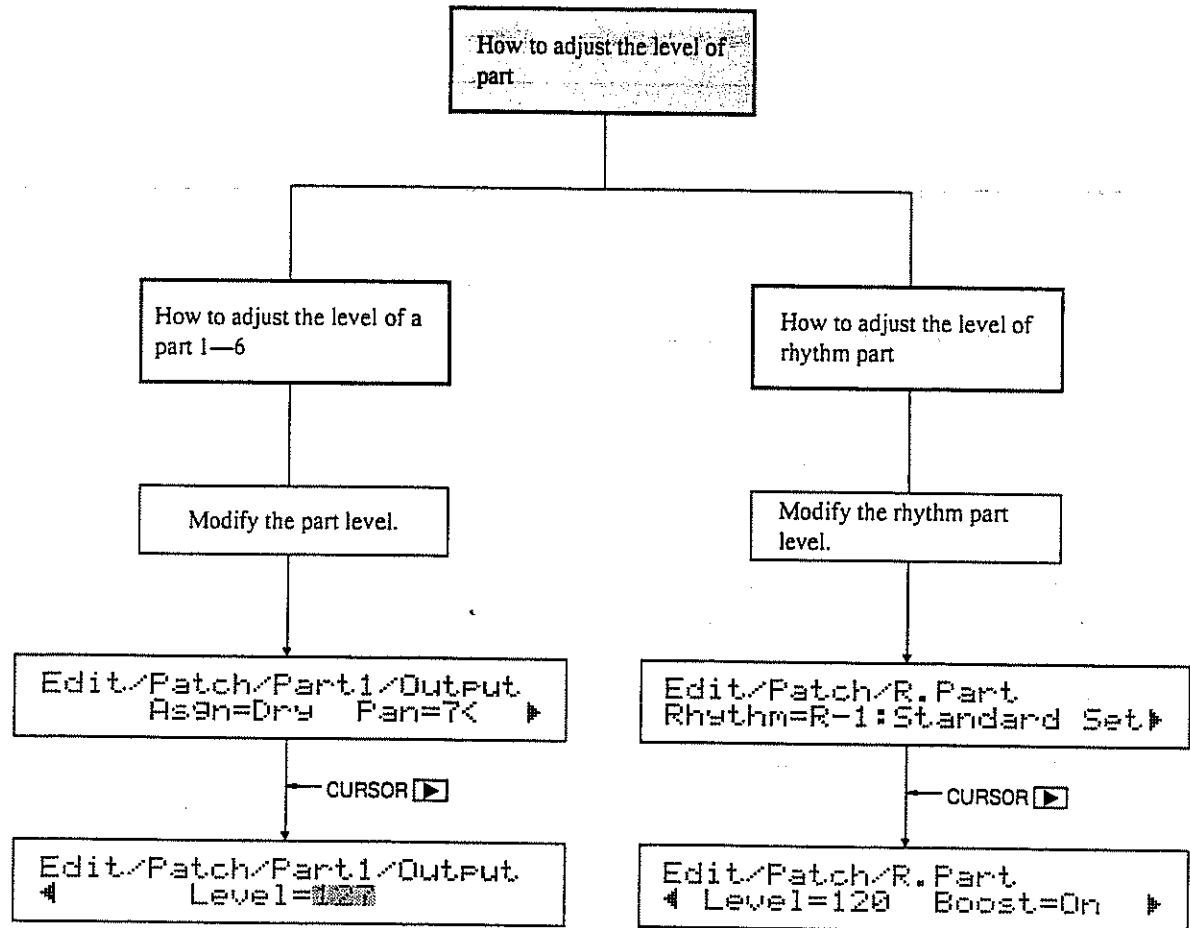

2. How to change the output

How to use the MIX OUT

In the output assign setting display, select one of the following settings.

```

Edit/Patch/Part1/Output
  Assign=0000  Pan=7<
  
```

Output Assign	Effect	Output Jacks
Dry	No effect is used	MIX OUT
Rev	Only Reverb	
Cho	Pre Rev : Chorus and Reverb Post Rev : Only Chorus	

Pre Rev : reverb is added to the sound processed by chorus

Post Rev : reverb is not added to the sound processed by chorus

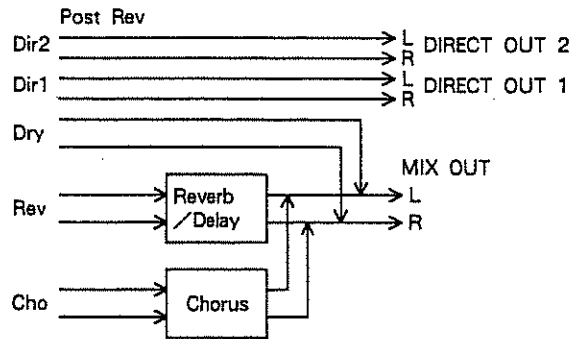
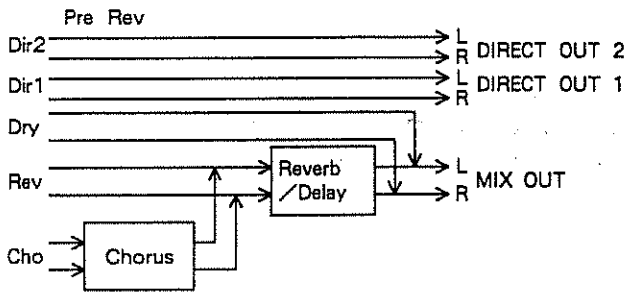

How to independently output a specified part

You can output all parts independently by using MIX OUT (L/R), DIRECT OUT 1 (L/R), and DIRECT OUT 2 (L/R) as multi outputs. When using these as multi outputs, the output will be mono.

In order to use multi outputs, specify the output assign and pan setting in the output assign display for each part as follows.

```

Edit/Patch/Part1/Output
  Assign=0000  Pan=7<
  
```

Output Assign	Effect	Output Jacks
Dir 1	No effect is used	DIRECT OUT 1
Dir 2	No effect is used	DIRECT OUT 2

How to independently output all parts

You can output all parts independently by using MIX OUT (L/R), DIRECT OUT 1 (L/R), and DIRECT OUT 2 (L/R) as multi outputs. When using these as multi outputs, the output will be mono.

In order to use multi outputs, specify the output assign and pan setting in the output assign display for each part as follows.

```

Edit/Patch/Part1/Output
  Assign=0000 Pan=0000 ▶
  
```

Output Jack	Output Assign	Pan
OUT 1 (MIX L)	Dry ★	7<
OUT 2 (MIX R)	Dry ★	>7
OUT 3 (DIR 1 L)	Dir 1	7<
OUT 4 (DIR 1 R)	Dir 1	>7
OUT 5 (DIR 2 L)	Dir 2	7<
OUT 6 (DIR 2 R)	Dir 2	>7

★ If you set output assign to Rev or Cho for OUT 1 and OUT 2, the output from OUT 1 and OUT 2 will no longer be independent.

3. How to select patches

How to select patches from the U-220 panel

```
P-00: Acoust Piano [001]
RX 10110110110110110110
```

Use ∇ VALUE \triangle to select.
 *To return to the play display press **EXIT** several times.
 (or hold **JUMP** and press ∇ VALUE.)

How to select the patch corresponding to each program change number

```
Edit/Setup/MIDI
Rx Patch Change=0000 ▶
```

① Set the patch change reception switch to "Dir".

```
Edit/Setup/MIDI
Rx Control Ch=000 ▶
```

② Set the control channel.

③ Press **EXIT** several times to return to the play display.
 (or hold **JUMP** and press ∇ VALUE.)

④ Transmit a program change from the keyboard on the control channel you set in step ②.

How to select patches from a connected keyboard

How to select a specific patch

Map settings

```
Edit/Setup/Map/Patch
PatchMap#01-100
```

① Set the patch map as explained on page 50.

```
Edit/Setup/MIDI
Rx Patch Change=Map ▶
```

② Set the patch reception switch to the number of the map you set.

```
Edit/Setup/MIDI
Rx Control Ch=000 ▶
```

③ Set the control channel.

④ Press **EXIT** several times to return to the play display.
 (or hold **JUMP** and press ∇ VALUE.)

⑤ Transmit a program change from the keyboard on the control channel you set in step ③.

4. How to change the current sound

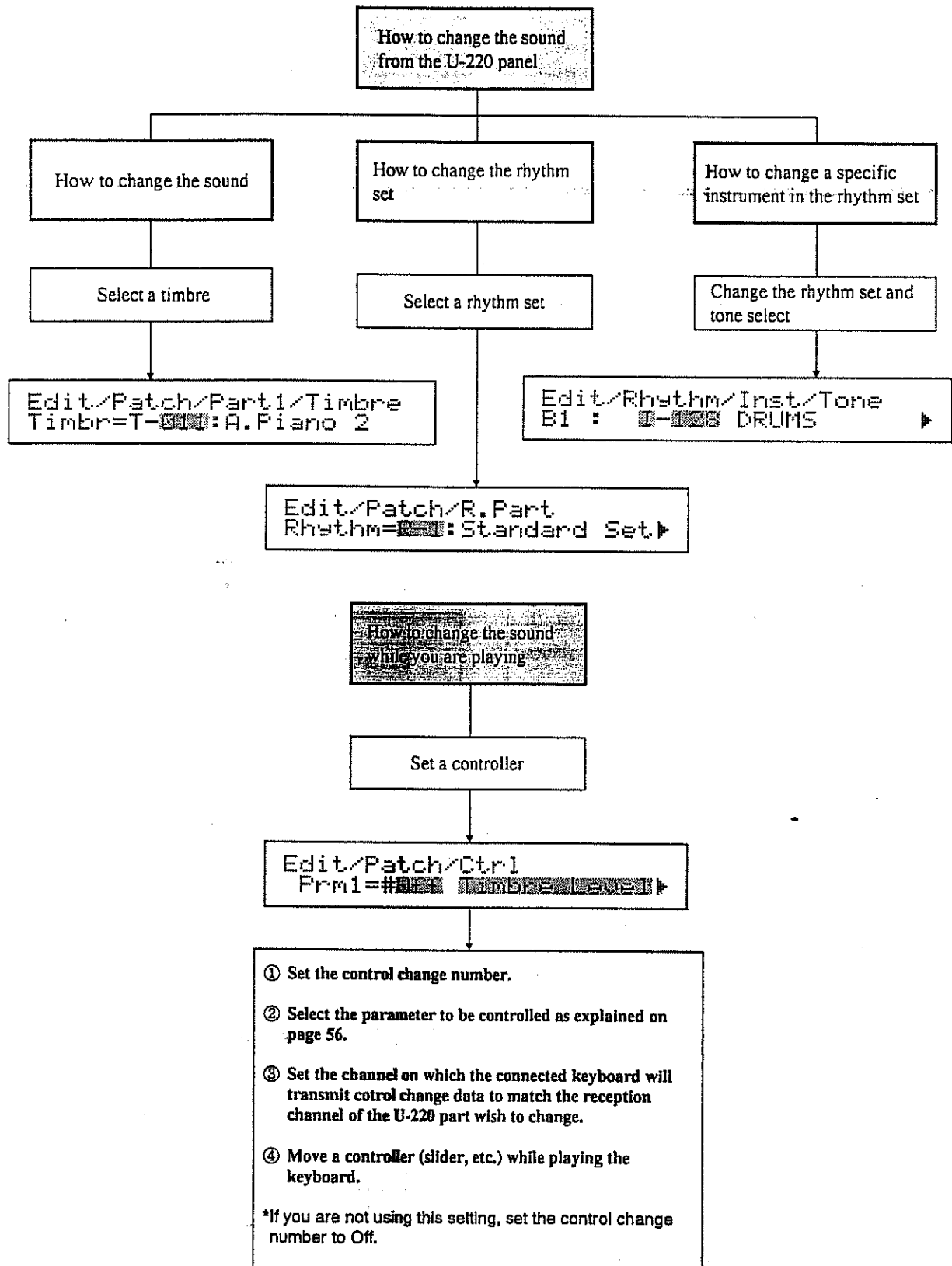

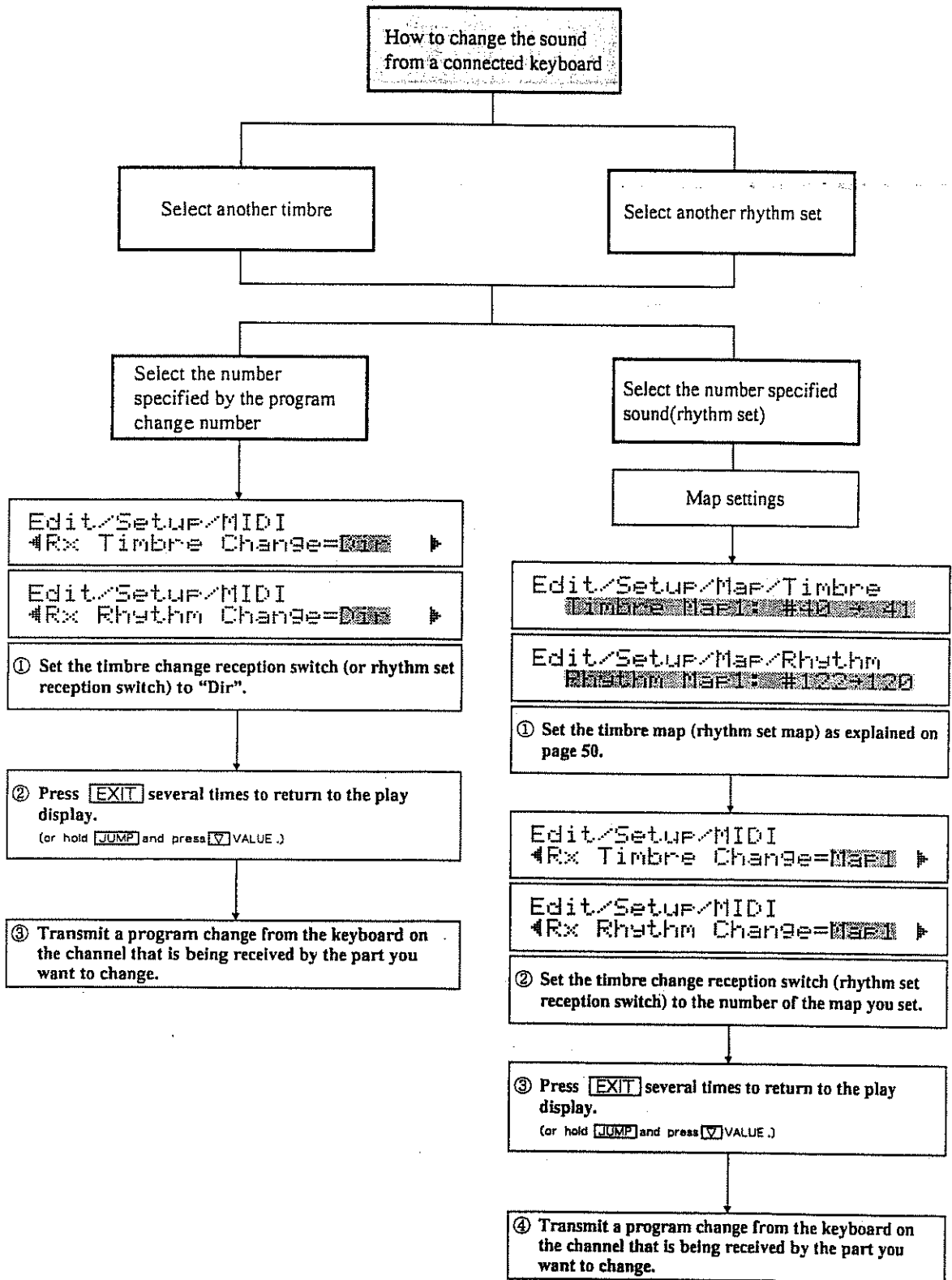

5. How to change the pitch

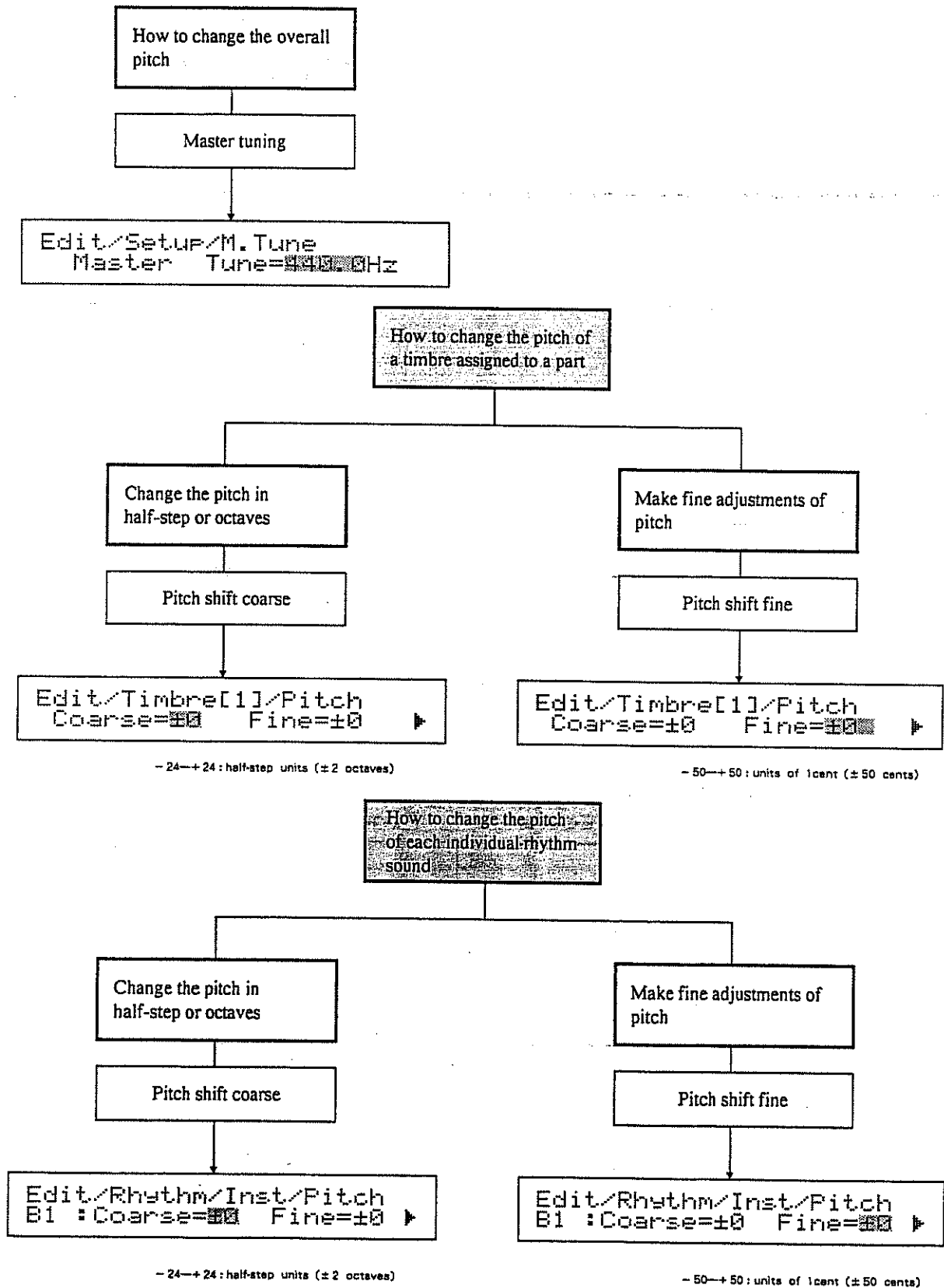

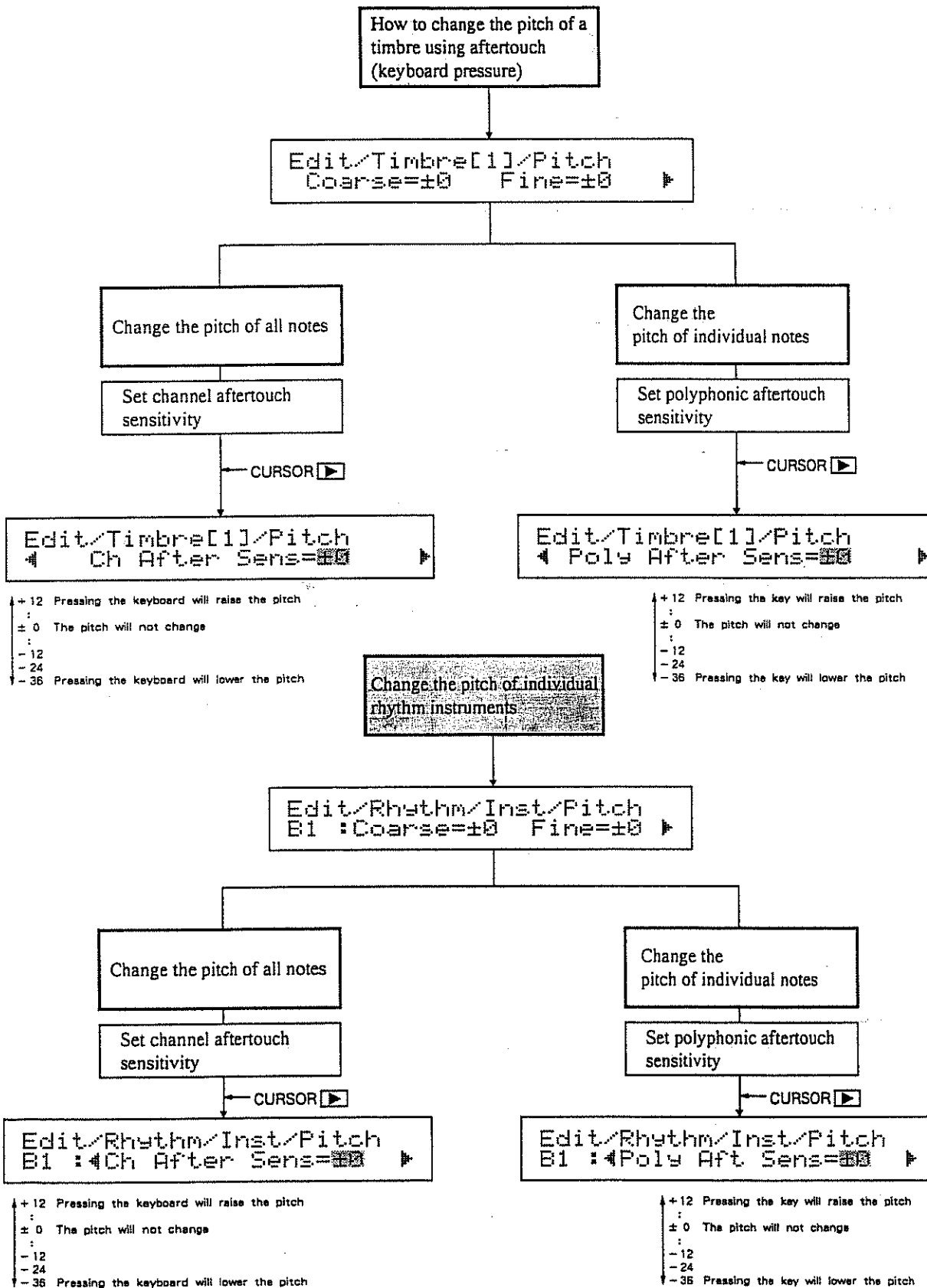

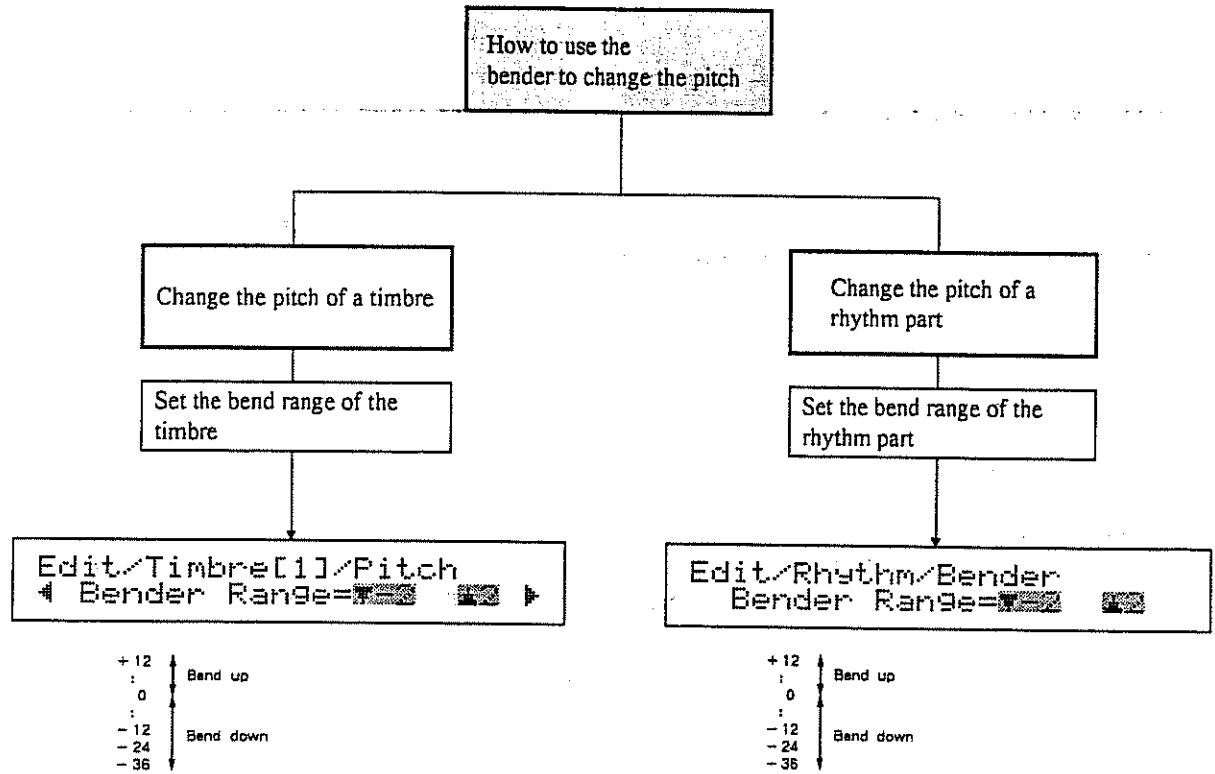

6. How to add reverb

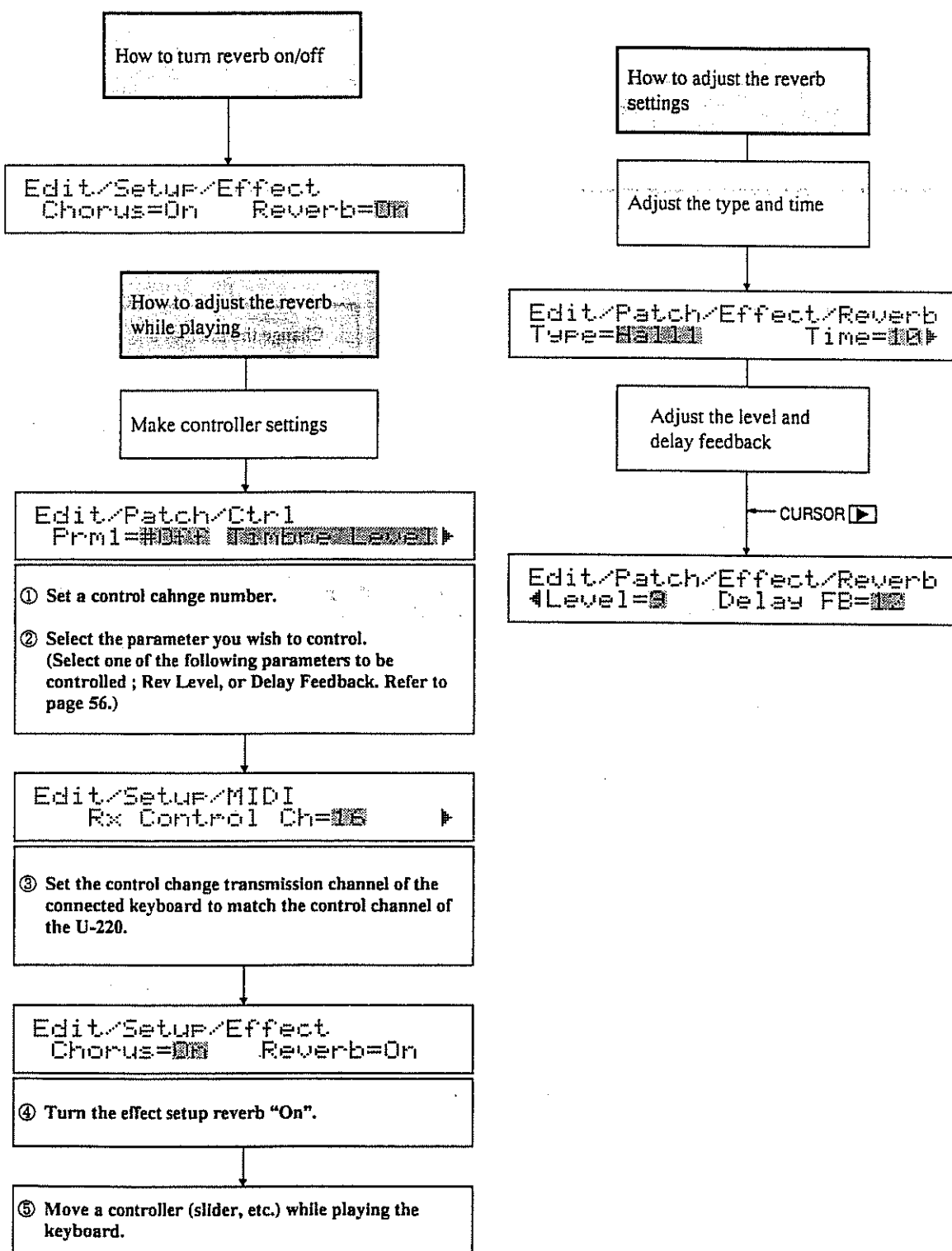

*If you are not using this setting, set the control change number "Off".

7. How to add chorus

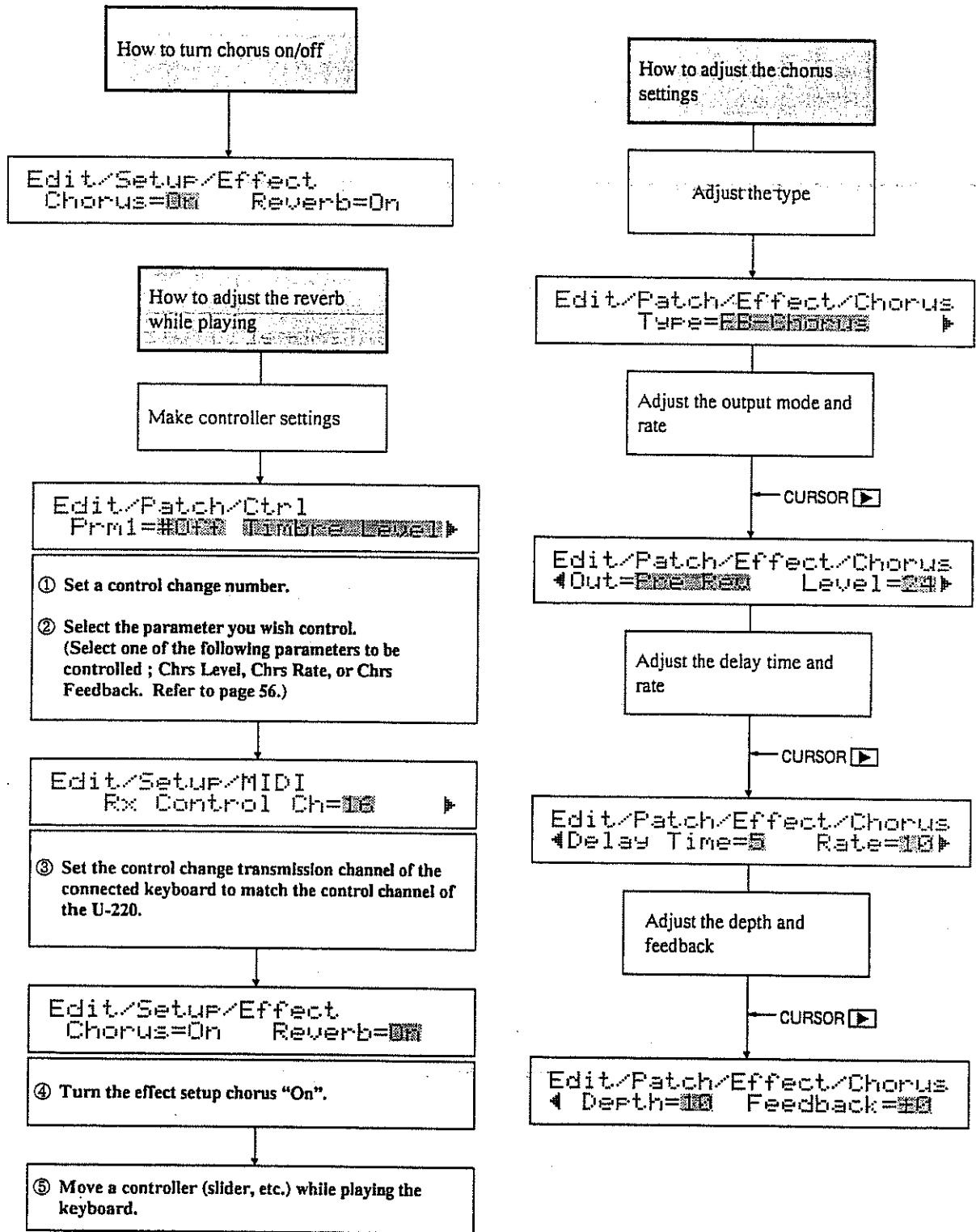

*If you are not using this setting, set the control change number "Off".

8. How to add vibrato

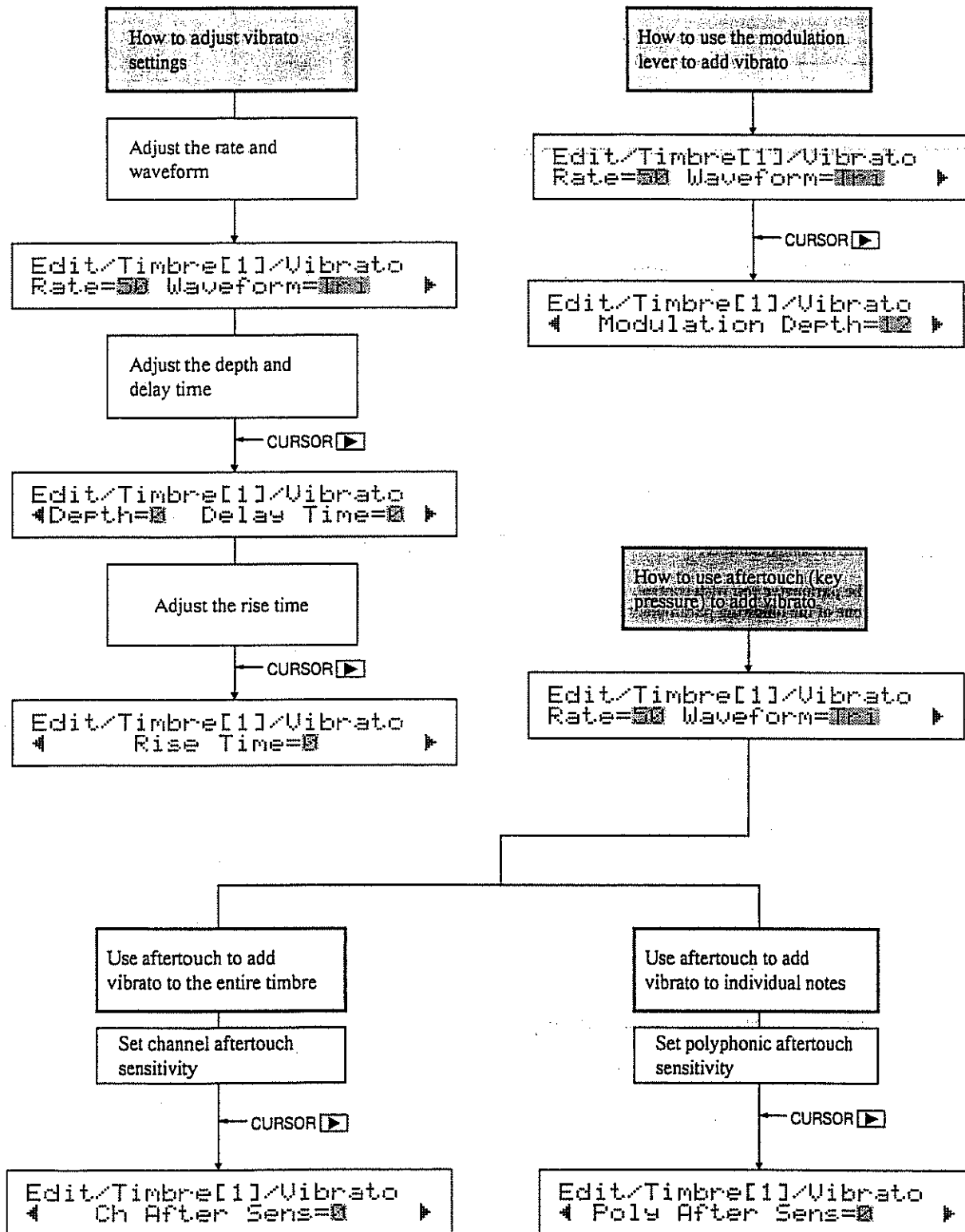

9. How to set channels

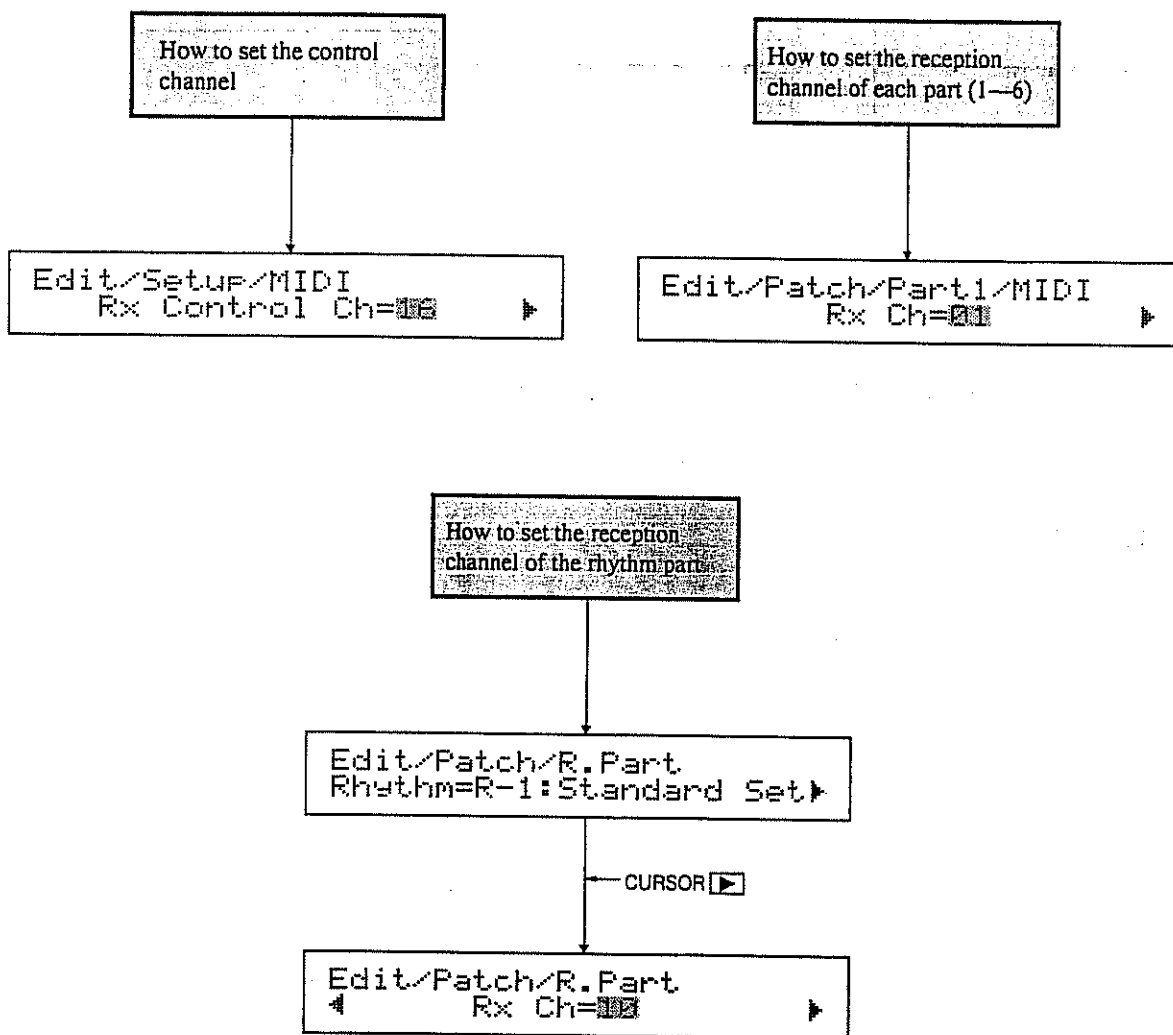

10. How to use a sequencer

[Example of connections]

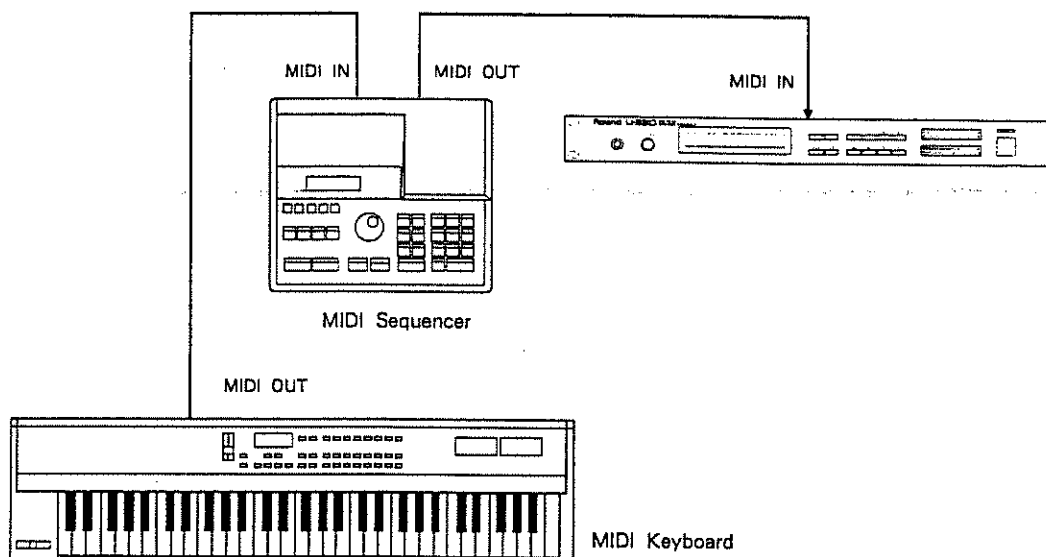

How to select patches

- ① Set the patch change reception switch to "Dir".
(If you want to select patches as specified by the patch map you set, select the appropriate patch map number.)

```
Edit/Setup/MIDI  
◀Rx Patch Change=Dir▶
```

- ② Transmit a program change on the same channel as the U-220's control channel.

- * Program changes are received only when in the play display.
- * Patch program change numbers are the same as patch numbers.

How to change the volume of a part

Transmit a control change message (control change number 7) on the same channel as the part you want to affect.

How to change part panning (stereo position)

Transmit a control change message (control change number 10) in the same channel as the part you want to affect.

- * To set the U-220 to random panning you must use an exclusive message.
- * Each instrument in the rhythm part can be panned independently. The panning of the rhythm part cannot be controlled using control change message.

How to select timbres

- ① Set the timbre change reception switch to "Dir".
(If you want to select timbres as specified by the timbre map you set, select the appropriate timbre map number.)

```

Edit/Setup/MIDI
◀Rx Timbre Change=0000 ▶
  
```

- ② Transmit a program change on the channel being received by the part you want to select.
 - * Program changes are received only when in the play display.
 - * Timbre program change numbers are the same as timbre numbers.

How to select rhythm sets

- ① Set the rhythm change reception switch to "Dir".
(If you want to select rhythm sets as specified by the rhythm map you set, select the appropriate rhythm set map number.)

```

Edit/Setup/MIDI
◀Rx Rhythm Change=0000 ▶
  
```

- ② Transmit a program change on the channel being received by the rhythm part.
 - * Program changes are received only when in the play display.
 - * Rhythm set program change numbers are the same as rhythm set numbers.

How to control a specific parameter

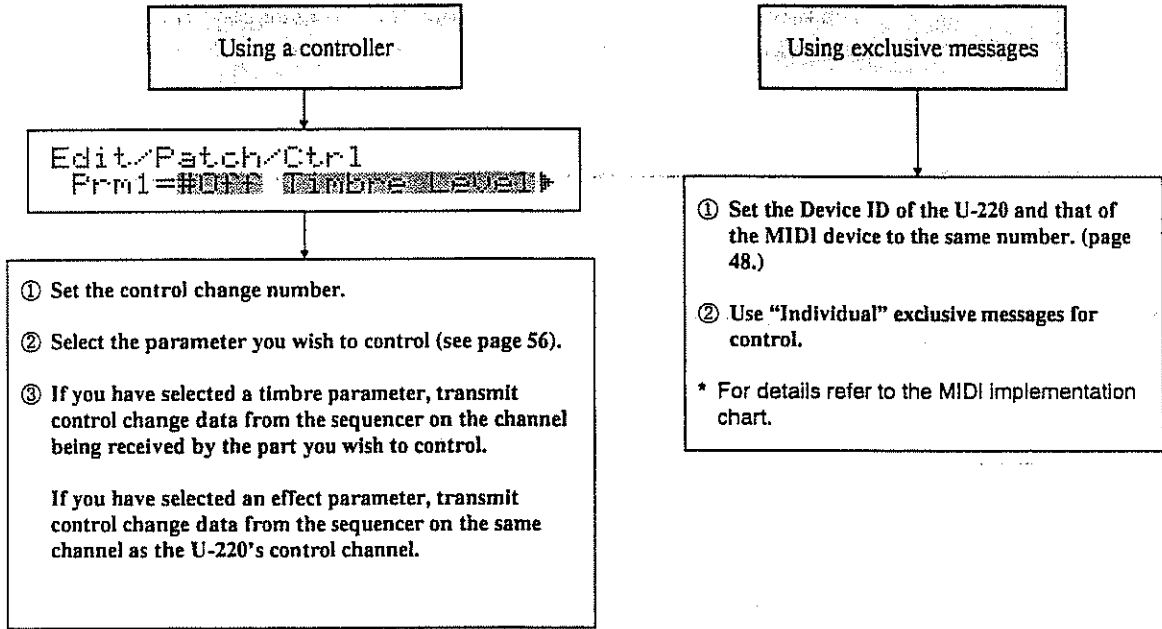

How to use a sequencer to reproduce the current settings

Transmit data from the U-220 to the sequencer (see page 88). Transmit all data from the setup area and the temporary area.

* When using the SUPER-MRC/MRC-500 or MRB-500 sequencer, use realtime record (SOFT THRU OFF). When using other sequencers, use realtime record mode. Some sequencers may not be able to receive or transmit the data correctly.

(1) Transmit the data from the setup area

- ① Select "Setup All" from the following display.

```

Data/Bulk/Setup/All
Bulk Dump SETUP ALL
  
```

- ② Press **ENTER**.

```

Data/Bulk/Setup/All
Function Completed.
  
```

(2)Transmit the data from the temporary area

- ① Select "Temp All" from the following display.

```
Data/Bulk/Temp
Bulk Dump TEMP ALL
```

- ② Press **ENTER**.

```
Data/Bulk/Temp
Function Completed.
```

Chapter 6 Supplementary material

This chapter contains an explanation of the error messages, help for troubleshooting, parameter lists, and other material.

1. Error messages

When the U-220 has been operated incorrectly or when an operation ended with an unexpected result, an error message will be displayed. Various other messages will be displayed for other special cases. Check the problem and take the appropriate action.

Messages which appear when the power is turned on

Internal Battery Low!

Problem : The internal backup battery has run low.

Action : Consult a Roland service station.

Messages which appear when a PCM card (SN — U110 series) is used

Check PCM Card...

When a PCM card is inserted or removed this display will briefly appear and operation will halt for a short time, but this not a malfunction.

Illegal PCM Card!
Please, take it out.

Problem : A card other than a PCM card is inserted into the PCM card slot.

Action : Immediately remove the card from the PCM card slot.

Messages which appear when external MIDI devices are used

SysEx Check Sum Error!

Problem : Exclusive data was incorrectly received.

Action : Check MIDI cables and the transmitted data, and try the operation once again.

SysEx Data Length Error!

MIDI Buffer Full!

Problem : The amount of MIDI data received was too much for the U-220 to handle.

Action : Check if a large number of messages which require a bit of time to process (such as program changes, etc.) are being transmitted in rapid succession.

MIDI Off Line!

Problem : After receiving an active sensing message, no messages have been received since 300 msec ago.

Action : Check if the MIDI cable has been unplugged.

2. Troubleshooting

If there is no sound or if the U-220 behaves in an unexpected way, check these points first. If these do not solve the problem, consult the dealer where you purchased the U-220 or a nearby Roland service station.

No sound / volume too low

[No sound / volume too low even in ROM play]

- Is the VOLUME lowered?

Check the volume adjustment of the U-220 and the connected mixer/amp system.

- Are the outputs connected correctly?

If you hear sound in the headphones, the reason is probably in the amp or cable. Check connections once again.

[No sound / volume too low in other than ROM play]

- Are the part's key range and velocity threshold settings appropriate?

Refer to page 59.

- Are the part or timbre levels lowered?

Refer to page 62, 66, 75.

- Have the part levels or timbre levels been lowered by a control change message from an external MIDI device?

Select another or the same patch.

- Is the PCM card containing the selected tone inserted correctly?

Refer to page 66.

- Does the transmission channel of the connected keyboard match the reception channel of each part?

Check these settings in the play mode display (page 16).

The pitch is incorrect

- Is the master tuning correct?
Refer to page 46.
- Are the pitch shift settings of each timbre correct?
Refer to page 68.
- Has a MIDI pitch bender message (other than 0) been received?
Transmit a pitch bender message of 0 (center) to the U-220 or re-select the patch.

Cannot select sounds

- Are you in edit mode or data mode?
Press **EXIT** to return to play mode.

The effect is not applied

- Turn on the setup chorus or reverb settings (page 46).
- Are the output assign settings of each part set to Dry, Dir 1, or Dir 2?
Set the output assign of each part to Rev or Cho (page 61, 78).

MIDI data from a sequencer is not received correctly

- Are the reception channels of each part set correctly?
Check these settings from the play mode display (page 16).
- Are the key range or velocity threshold of each part set correctly?
See page 60.
- Are the voice reserve settings appropriate?
See page 58, 63.

3. Parameter List

■ Setup

Parameter Group	Parameter	Setting Range
M.Tune	Master Tuning	427.4—452.9 Hz
Effect	Chorus Switch	Off, On
	Reverb Switch	Off, On
LCD	LCD Contrast	0—15
MIDI	Control Channel	1—16
	Patch Change Switch	Map1—4, Dir, Off
	Timbre Change Switch	Map1—4, Dir, Off
	Rhythm Change Switch	Map1—4, Dir, Off
	Rhythm Inst Assign	Map1—4, Dir, Off
	Rx Exclusive Switch	Off, On
	Device ID	1—32
Map	Patch Map	1—64, Dir, Off
	Timbre Map	1—128, Dir, Off
	Rhythm Map	1—4, Dir, Off
	Rhythm Inst Map	C-1—G9, Dir, Off

■ Rhythm Set

Parameter Group	Parameter	Setting Range	
Name	Rhythm Set Name (12 Characters)	(space) A-Z a-z 0-9 - / + * . : ; = ! " # \$ % & ' () () [] _ ? `	
Bender	Bender Range (Bend Down)	- 36, - 24, - 12—± 0	
	Bender Range (Bend Up)	0—12	
Inst (B1—D7)	Tone	Tone Select	I, 1—31 - 1—128
		Source Key	C-1—G9
		Mute	Off, B1—D7
	Level	Level	0—31
		Velocity Sensitivity	- 7—+ 7
		Env Mode	Sustain, NoSustain
		Env Attack Rate	- 7—+ 7
		Env Decay Rate	- 7—+ 7
		Env Release Rate	- 7—+ 7
	Pitch	Pitch Shift Coarse	- 36, - 24, - 12—+ 12
		Pitch Shift Fine	- 50—+ 50
		Channel Aftertouch Sensitivity	- 36, - 24, - 12—+ 12
		Polyphonic Aftertouch Sensitivity	- 36, - 24, - 12—+ 12
		Pitch Randomize	0—15
		Auto Bend Depth	- 36, - 24, - 12—+ 12
		Auto Bend Rate	0—15
	Output	Detune Depth	0—15
		Output Assign	Dry, Rev, Cho, Dir
		Pan	7>—><—< 7, Rnd

■ Patch

Parameter Group		Parameter	Setting Range
Name		Patch Name (12 Characters)	(space) A-Z a-z 0-9 - / + * . : ; = " # \$ % & ' () () { } [] _ ? `
Effect	Chorus	Chorus/Flanger Type	Chorus1, Chorus2, FB - Chorus, Flanger, Short Delay
		Output Mode	Pre-Rev, Post-Rev
		Chorus/Flanger Level ★	0-31
		Delay Time	0-31
		Chorus /Flanger Rate ★	0-31
		Chorus/Flanger Depth	0-31
	Feedback ★	- 31—+ 31	
	Reverb	Reverb/Delay Type	Room1-3, Hall1, 2 Gate, Delay, Cross Delay
		Reverb/Delay Time	0-31
		Reverb/Delay Level ★	0-31
Feedback ★		0-31	
Ctrl	Prm1	Control Number	0-5, 7-31, 64-95, Off
		Parameter Select	See * 1
	Prm2	Control Number	0-5, 7-31, 64-95, Off
		Parameter Select	See * 1
	Prm3	Control Number	0-5, 7-31, 64-95, Off
		Parameter Select	See * 1
Part1-6	Timbre	Timbre Select	T-001-T-128
	V.Rsv	Voice Reserve	0-30 See * 2
	MIDI	Rx Channel	1-16, Off
		Key Range	C-1-G9
		Velocity	1-127, Above, Below
		Volume Receive Switch	Off, On
		Pan Receive Switch	Off, On
		Hold Receive Switch	Off, On
	Output	Output Assign	Dry, Rev, Cho, Dir
		Part Level	0-127
Pan		7 >—> <—< 7, Rnd	
R.Part	Rhythm Set Select	1-4	
	Voice Reserve	0-30 See * 2	
	Rx Channel	1-16, Off	
	Part Level	0-127	
	Part Level Boost	Off, On	
	Volume Receive Switch	Off, On	
	Hold Receive Switch	Off, On	

* 1 Parameters indicated by ★ can be controlled (see page 56).

* 2 Voice reserve settings for Parts 1-6 and the Rhythm Part must total 30 or less.

■ Timbre

Parameter Group	Parameter	Setting Range
Name	Timbre Name (12 Characters)	(space) A-Z a-z 0-9 - / + * . : ; = ! " # \$ % & ' () < > [] _ ? `
Tone	Tone Select	1, 1—31 - 1—128
Level	Timbre Level ★	0—127
	Velocity Sensitivity	-7—+7
	Channel Aftertouch Sensitivity	-7—+7
	Env Attack Rate ★	-7—+7
	Env Decay Rate ★	-7—+7
	Env Sustain Level ★	-7—+7
	Env Release Rate ★	-7—+7
Pitch	Pitch Shift Coarse	-24—+24
	Pitch Shift Fine	-50—+50
	Bender Range (Bend Down)	-36, -24, -12—0
	Bender Range (Bend Up)	0—12
	Channel Aftertouch Sensitivity	-36, -24, -12—+12
	Polyphonic Aftertouch Sensitivity	-36, -24, -12—+12
	Auto Bend Depth ★	-36, -24, -12—+12
	Auto Bend Rate ★	0—15
	Detune Depth ★	0—15
Vib	Rate ★	0—63
	Waveform ★	Tri, Sine, Square, SawUp, SawDown, Trill1, Trill2, Randm1—4
	Depth ★	0—15
	Delay Time ★	0—15
	Rise Time ★	0—15
	Modulation Depth ★	0—15
	Channel Aftertouch Sensitivity	0—15
	Polyphonic Aftertouch Sensitivity	0—15

★ : These parameters can be controlled using Control Change data. In the Patch, specify the parameters you want to control. (see page 56.)

4. Preset Tone List

*(note name) = split point (v =) = velocity threshold

No.	Tone Name	Tone Type	Remarks
Piano			
1	A.Piano 1	V - MIX	Soft
2	A.Piano 2	V - MIX	
3	A.Piano 3	V - MIX	Bright
4	A.Piano 4	V - MIX	Honky-tonk
5	A.Piano 5	SINGLE	Soft
6	A.Piano 6	DETUNE	Soft
7	A.Piano 7	SINGLE	Hard
8	A.Piano 8	DETUNE	Hard
9	A.Piano 9	SINGLE	Hard and bright
10	A.Piano 10	DETUNE	Hard and bright
11	E.Piano 1	V - MIX	Soft + hard
12	E.Piano 2	SINGLE	Soft
13	E.Piano 3	DETUNE	Soft
14	E.Piano 4	SINGLE	Hard
15	E.Piano 5	DETUNE	Hard
16	BRIGHT EP1	SINGLE	
17	BRIGHT EP2	DETUNE	
Vibraphone			
18	VIB 1	SINGLE	Soft
19	VIB 2	DETUNE	Soft
20	VIB 3	V - MIX	Soft + hard
Bell			
21	BELL 1	SINGLE	Long decay
22	BELL 2	DETUNE	Long decay
Marimba			
23	MARIMBA	SINGLE	
Guitar			
24	A.GUITAR 1	SINGLE	
25	A.GUITAR 2	DETUNE	
26	A.GUITAR 3	DUAL	
27	A.GUITAR 4	DUAL	Added lower octave
28	A.GUITAR 5	V - SW	Slow attack/fast (v = 100)
29	E.GUITAR 1	V - SW	Muted/unmuted (v = 100)
30	E.GUITAR 2	SINGLE	Muted
31	E.GUITAR 3	SINGLE	
32	E.GUITAR 4	DETUNE	
33	HEAVY.EG 1	SINGLE	Combination fifths
34	HEAVY.EG 2	DETUNE	Combination fifths
Bass			
35	SLAP 1	SINGLE	Thumped, pulled, harmonics (E2, F # 4)
36	SLAP 2	DETUNE	Thumped, pulled, harmonics (E2, F # 4)
37	SLAP 3	SINGLE	Thumped, pulled, harmonics (B2, F # 4)
38	SLAP 4	DETUNE	Thumped, pulled, harmonics (B2, F # 4)
39	SLAP 5	V - SW	Thumped/pulled (v = 100), harmonics (F # 4)
40	SLAP 6	V - SW	Slow attack/fast attack (v = 100), harmonics (F # 4)
41	SLAP 7	SINGLE	Thumped, pulled, harmonics (B2, C # 4)
42	SLAP 8	DETUNE	Thumped, pulled, harmonics (B2, C # 4)
43	SLAP 9	SINGLE	Thumped, pulled, harmonics (B2, C # 4)
44	SLAP 10	DETUNE	Thumped, pulled, harmonics (B2, C # 4)
45	SLAP 11	V - SW	Thumped/pulled (v = 100), harmonics (C # 4)
46	SLAP 12	V - SW	Slow attack/fast attack (v = 100), harmonics (C # 4)

No	Tone name	Tone Type	Remarks
Bass			
47	FINGERED 1	SINGLE	Fingered, harmonics (C # 5)
48	FINGERED 2	DETUNE	Fingered, harmonics (C # 5)
49	PICKED 1	SINGLE	
50	PICKED 2	DETUNE	
51	FRETLESS 1	SINGLE	Fretless, harmonics (D # 6)
52	FRETLESS 2	DETUNE	Fretless, harmonics (D # 6)
53	AC.BASS	V - MIX	Added fret noise
54	SYN.BASS 1	V - MIX	Soft + hard
55	SYN.BASS 2	SINGLE	Soft
56	SYN.BASS 3	SINGLE	Hard
57	SYN.BASS 4	SINGLE	
58	SYN.BASS 5	SINGLE	
59	SYN.BASS 6	SINGLE	
60	SYN.BASS 7	SINGLE	
61	SYN.BASS 8	V - MIX	
Choir			
62	CHOIR 1	SINGLE	Long decay
63	CHOIR 2	SINGLE	Short decay
64	CHOIR 3	DUAL	Long decay, added lower
65	CHOIR 4	DUAL	Short decay, added lower octave
Strings			
66	STRINGS 1	SINGLE	Long decay
67	STRINGS 2	SINGLE	Short decay
68	STRINGS 3	DUAL	Long decay, added lower
69	STRINGS 4	DUAL	Short decay, added lower octave
Organ			
70	E.ORGAN 1	SINGLE	
71	E.ORGAN 2	DETUNE	
72	E.ORGAN 3	SINGLE	
73	E.ORGAN 4	DETUNE	
74	E.ORGAN 5	SINGLE	
75	E.ORGAN 6	DETUNE	
76	E.ORGAN 7	SINGLE	
77	E.ORGAN 8	DETUNE	
78	E.ORGAN 9	DUAL	
79	R.ORGAN 1	DUAL	
80	R.ORGAN 2	DUAL	
Wind			
81	SOFT TP 1	SINGLE	
82	SOFT TP 2	DETUNE	
83	TP/TRB 1	SINGLE	
84	TP/TRB 2	SINGLE	Soft
85	TP/TRB 3	SINGLE	Bright
86	SAX 1	SINGLE	
87	SAX 2	SINGLE	Soft
88	SAX 3	SINGLE	Bright
89	SAX 4	DETUNE	
90	SAX 5	DUAL	Added lower octave
91	BRASS 1	SINGLE	
92	FLUTE 1	SINGLE	
93	SHAKU 1	SINGLE	
94	SHAKU 2	DETUNE	

4.Preset Tone List

No	Tone Name	Tone Type	Remarks
Synthesizer			
95	FANTASIA	DUAL	
96	BELL PAD	DUAL	
97	SYN CHOIR	SINGLE	
98	BREATH VOX	DUAL	
99	SYN.VOX 1	SINGLE	
100	SYN.VOX 2	SINGLE	
101	L.CALLIOPE	DUAL	
102	CALLIOPE	SINGLE	
103	METAL HIT	DUAL	
104	RICH BRASS	SINGLE	
105	JP.BRASS 1	SINGLE	
106	JP.BRASS 2	SINGLE	
107	BRASTRINGS	DUAL	
108	STRINGPAD1	SINGLE	
109	STRINGPAD2	DUAL	
110	JP.STRINGS	SINGLE	
111	PIZZAGOGO	DUAL	
112	FANTA BELL	SINGLE	
113	SPECT BELL	DUAL	
114	BELL DRUM	DUAL	
115	SYNTH HARP	SINGLE	
116	PULSEWAVE1	SINGLE	
117	PULSEWAVE2	SINGLE	
118	PULSEWAVE3	SINGLE	
119	SAW WAVE 1	SINGLE	
120	SAW WAVE 2	SINGLE	
121	PIZZ	SINGLE	
122	METAL	SINGLE	
123	BREATH	SINGLE	
124	NAILS	SINGLE	
125	SPECTRUM 1	SINGLE	
126	SPECTRUM 2	SINGLE	
127	N.DANCE	SINGLE	
Drums			
128	DRUMS	SINGLE	Refer to the drums list

● Drums List

		Tone Name
C3	35	Bass Drum 1
	36	Bass Drum 2
	37	Rim Shot
	38	Snare Drum 1
	39	Hand Clap
	40	Snare Drum 2
	41	Low Tom Tom 1
	42	Closed High Hat 1
	43	Low Tom Tom 2
	44	Open High Hat 2
C3	45	Middle Tom Tom 1
	46	Open High Hat 1
	47	Middle Tom Tom 2
	48	High Tom Tom 1
	49	Crash Cymbal
	50	High Tom Tom 2
	51	Ride Cymbal
	52	China Cymbal
	53	Cup (Mute)
	54	Off
C4	55	Off
	56	Cowbell
	57	Crash Cymbal
	58	Snare Drum 3
	59	Ride Cymbal
	60	Off
	61	Off
	62	Off
	63	Off
	64	Off
C5	65	Off
	66	Off
	67	Off
	68	Off
	69	Cabasa
	70	Off
	71	Off
	72	Off
	73	Off
	74	Off
C6	75	Off
	76	Off
	77	Off
	78	Off
	79	High Pitch Tom Tom 2
	80	Off
	81	High Pitch Tom Tom 1
	82	Off
	83	Off
	84	Bass Drum 3
C7	85	Bass Drum 4
	86	Snare Drum 4
	87	Snare Drum 5
	88	Snare Drum 6
	89	Low Tom Tom 3
	90	Closed High Hat 2
	91	Middle Tom Tom 3
	92	China Cymbal
	93	High Tom Tom 3
	94	Ride Cymbal
95	Off	
96	Off	

5. Initialized Settings

For the initialization procedure, see page 93.

■ Setup

Parameter Group	Parameter	Value
M.Tune	Master Tune	440.0 Hz
Effect	Chorus Sw	On
	Reverb Sw	On
LCD	LCD Contrast	10
MIDI	Rx Control Ch	16
	Rx Patch Change	Dir
	Rx Timbre Change	Dir
	Rx Rhythm Change	Dir
	Rx Rhythm Inst Assign	Dir
	Rx SysEx	On
	SysEx Device ID	17
Map	Patch Map	1—64 all Dir
	Timbre Map	1—128 all Dir
	Rhythm Map	1—4 all Dir
	Rhythm Inst Map	B1—D7 all Dir

■ Patch

Parameter Group	Parameter	Value	
Name	Patch Name	Acoust Piano	
Effect	Output Mode	Pre Rev	
	Chorus	Chorus Level	25
		Chorus Type	Chorus1
		Delay Time	12
		Chorus Rate	25
		Chorus Depth	5
	Feedback	0	
	Reverb	Reverb Type	Hall1
		Reverb Time	0
		Reverb Level	6
Delay FB		0	
Ctrl	Prm1	Ctrl #	Off
		Parameter	Timbre Level
	Prm2	Ctrl #	Off
		Parameter	Timbre Level
	Prm3	Ctrl #	Off
		Parameter	Timbre Level
Part1—6	Timbre	Timbre #	T-001
	V.Rsv	Voice Reserve	0
	MIDI	Rx Ch	(same as part number)
		Key Range	C-1 – G9
		Velocity Thresh	127/Below
		Rx Volume	On
		Rx Pan	On
	Rx Hold	On	
	Output	Output Assign	Rev
		Part Level	127
		Pan	> <
	R.Part	Rhythm Set #	1
		Voice Reserve	0
Rx Ch		10	
Part Level		127	
Boost		Off	
Rx Volume		On	
Rx Hold	On		

■ Timbre

Parameter Group	Parameter	Value
Name	Timbre Name	A.Piano 2
Tone	Tone #	I - 2
Level	Timbre Level	127
	Velocity Sensitivity	+ 7
	Ch Aftertouch Sens	0
	Env Attack Rate	0
	Env Decay Rate	0
	Env Sustain Level	0
Pitch	Env Release Rate	0
	Pitch Shift Coarse	0
	Pitch Shift Fine	0
	Bender Range (Down)	- 2
	Bender Range (Up)	2
	Ch Aftertouch Sens	0
	Poly Aftertouch Sens	0
	Auto Bend Depth	0
	Auto Bend Rate	15
Detune Depth	5	
Vib	Rate	50
	Waveform	Tri
	Depth	0
	Delay Time	0
	Rise Time	0
	Modulation Depth	8
	Ch Aftertouch Sens	0
	Poly Aftertouch Sens	0

■ Rhythm Set Inst B1 - D7

Parameter	Value
Rhythm Set Name	Standard Set
Bender Range (Down)	- 12
Bender Range (Up)	12

Inst B1 - D7

Tone # : Name	Refer to following table
Source Key	
Mute	
Inst Level	31
Velocity Sensitivity	+ 7
Env Mode	No Sustain
Env Attack Rate	0
Env Decay Rate	0 (G3 is + 2)
Env Release Rate	0
Pitch Shift Coarse	0 (G3 is 12)
Pitch Shift Fine	0
Ch Aftertouch Sens	0
Poly Aftertouch Sens	0
Pitch Randomize	0
Auto Bend Depth	0
Auto Bend Rate	0
Detune Depth	0
Output Assign	Refer to following table
Pan	

5.Initialized Settings

		Inst			Tone		Output	
		Tone # : Name	Source Number	Mute	Pan	Output Assign		
		35	1-128 : DRUMS	35 : Bass Drum 1	off	><	Dry	
		36	1-128 : DRUMS	36 : Bass Drum 2	off	><	Dry	
C2		37	1-128 : DRUMS	37 : Rim Shot	off	><	Rev	
		38	1-128 : DRUMS	38 : Snare Drum 1	off	><	Rev	
		39	1-128 : DRUMS	39 : Hand Clap	off	2>	Rev	
		40	1-128 : DRUMS	40 : Snare Drum 2	off	><	Rev	
		41	1-128 : DRUMS	41 : Low Tom Tom 1	off	6>	Rev	
		42	1-128 : DRUMS	42 : Closed H.H 1	A # 2	<2	Rev	
		43	1-128 : DRUMS	43 : Low Tom Tom 2	off	6>	Rev	
		44	1-128 : DRUMS	44 : Open H.H 2	A # 2	<2	Rev	
		45	1-128 : DRUMS	45 : Mid Tom Tom 1	off	><	Rev	
		46	1-128 : DRUMS	46 : Open H.H 1	G # 2	<2	Rev	
		47	1-128 : DRUMS	47 : Mid Tom Tom 2	off	><	Rev	
C3		48	1-128 : DRUMS	48 : Hi Tom Tom 1	off	<4	Rev	
		49	1-128 : DRUMS	49 : Crash Cymbal	off	<2	Rev	
		50	1-128 : DRUMS	50 : Hi Tom Tom 2	off	<4	Rev	
		51	1-128 : DRUMS	51 : Ride Cymbal	off	4>	Rev	
		52	1-128 : DRUMS	52 : China Cymbal	off	6>	Rev	
		53	1-128 : DRUMS	53 : Cup (mute)	off	4>	Rev	
		54	2-002: LATIN 2	54 : Tambourine	off	4>	Rev	
		55	1-128 : DRUMS	55 : Splash Cymbal	off	><	Rev	
		56	1-128 : DRUMS	56 : Cowbell	off	2>	Rev	
		57	1-128 : DRUMS	57 : Crash Cymbal	off	<2	Rev	
		58	1-128 : DRUMS	58 : Snare Drum 3	off	><	Rev	
C4		59	1-128 : DRUMS	59 : Ride Cymbal	off	4>	Rev	
		60	2-002: LATIN 2	60 : Bongo - H	off	<4	Rev	
		61	2-002: LATIN 2	61 : Bongo - L	off	<2	Rev	
		62	2-002: LATIN 2	62 : Conga (mute)	off	2>	Rev	
		63	2-002: LATIN 2	63 : Conga - H	off	2>	Rev	
		64	2-002: LATIN 2	64 : Conga - L	off	4>	Rev	
		65	2-002: LATIN 2	65 : Timbale - H	off	<2	Rev	
		66	2-002: LATIN 2	66 : Timbale - L	off	<4	Rev	
		67	2-002: LATIN 2	67 : Agogo - H	off	4>	Rev	
		68	2-002: LATIN 2	68 : Agogo - L	off	4>	Rev	
		69	1-128 : DRUMS	69 : Cabasa	off	2>	Rev	
		70	2-002: LATIN 2	70 : Maracas	off	<2	Rev	
C5		71	2-002: LATIN 2	71 : Short Whistle	off	2>	Rev	
		72	2-002: LATIN 2	72 : Long Whistle	off	2>	Rev	
		73	2-002: LATIN 2	73 : Vibra - Slap	off	4>	Rev	
		74	2-002: LATIN 2	74 : Bell Tree	off	4>	Rev	
		75	2-002: LATIN 2	75 : Claves	off	6>	Rev	
		76	2-028: GUIRO 2	76 : Guiro 2	F 5	><	Rev	
		77	2-027: GUIRO 1	77 : Guiro 1	E 5	><	Rev	
		78	2-002: LATIN 2	78 : Castanets	off	<4	Rev	
		79	1-128 : DRUMS	79 : Hi Pitch Tom 2	off	<2	Rev	
		80	2-002: LATIN 2	80 : Triangle	off	><	Rev	
		81	1-128 : DRUMS	81 : Hi pitch Tom 1	off	<6	Rev	
		82	2-002: LATIN 2	82 : Wood Block	off	7>	Rev	
		83	2-002: LATIN 2	83 : Jingle Bell	off	<2	Rev	
C6		84	1-128 : DRUMS	84 : Bass Drum 3	off	><	Dry	
		85	1-128 : DRUMS	85 : Bass Drum 4	off	><	Dry	
		86	1-128 : DRUMS	86 : Snare Drum 4	off	><	Rev	
		87	1-128 : DRUMS	87 : Snare Drum 5	off	><	Rev	
		88	1-128 : DRUMS	88 : Snare Drum 6	off	><	Rev	
		89	1-128 : DRUMS	89 : Low Tom Tom 3	off	4>	Rev	
		90	1-128 : DRUMS	90 : Closed H.H 2	off	<2	Rev	
		91	1-128 : DRUMS	91 : Mid Tom Tom 3	off	<4	Rev	
		92	1-128 : DRUMS	92 : China Cymbal	off	<2	Rev	
		93	1-128 : DRUMS	93 : Hi Tom Tom 3	off	2>	Rev	
		94	1-128 : DRUMS	94 : Ride Cymbal	off	4>	Rev	
		95	2-002: LATIN 2	95 : Native Drum - 1	off	<4	Rev	
C7		96	2-002: LATIN 2	96 : Native Drum - 2	off	<2	Rev	
		97	2-002: LATIN 2	97 : Native Drum - 3	off	><	Rev	
		98	1-128 : DRUMS	98 : -----	off	><	Rev	

6. Blank Charts

Date _____

■ Setup

M.Tune	Master Tune	Hz	
Effect	Chorus	Off	On
	Reverb	Off	On
LCD	LCD Contrast		
MIDI	Rx Ctrl Ch		
	Rx Patch Change		
	Rx Timbre Change		
	Rx Rhythm Change		
	Rx Rhythm Inst Assign		
	Rx Sys Ex	Off	On
	Sys Ex Device ID		

● Patch Map : #

	0	1	2	3	4	5	6	7	8	9
0										
10										
20										
30										
40										
50										
60										
70										
80										
90										
100										
110										
120										

● Rhythm Set Map : #

	0	1	2	3	4	5	6	7	8	9
0										
10										
20										
30										
40										
50										
60										
70										
80										
90										
100										
110										
120										

● Timbre Map : #

	0	1	2	3	4	5	6	7	8	9
0										
10										
20										
30										
40										
50										
60										
70										
80										
90										
100										
110										
120										

● Rhythm Inst Map : #

	C	C#	D	D#	E	E#	F	F#	G	G#	A	A#	B
-1													
1													
2													
3													
4													
5													
6													
7													
8													
9													

Date _____

■ Patch # :		Name :		
Effect	Chorus	Type		
		Output Mode		
		Level		
		Delay Time		
		Rate		
		Depth		
	Reverb	Type		
		Time		
		Level		
	Ctrl	Prm1	Ctrl #	
			Parameter	
		Prm2	Ctrl #	
	Part 1	Timbre	Timbre #	
			V.Rsv	Voice Reserve
MIDI		Rx Ch		
		Key Range	--	
		Velocity Thresh		
		Rx Volume		
		Rx Pan		
Output		Output Assign		
		Level		
		Pan		
Part 2		Timbre	Timbre #	
			V.Rsv	Voice Reserve
		MIDI	Rx Ch	
			Key Range	--
	Velocity Thresh			
	Rx Volume			
	Rx Pan			
	Output	Output Assign		
		Level		
		Pan		
	Part 3	Timbre	Timbre #	
			V.Rsv	Voice Reserve
		MIDI	Rx Ch	
			Key Range	--
Velocity Thresh				
Rx Volume				
Rx Pan				
Output		Output Assign		
		Level		
		Pan		
Part 4		Timbre	Timbre #	--
			V.Rsv	Voice Reserve
		MIDI	Rx Ch	
			Key Range	--
	Velocity Thresh			
	Rx Volume			
	Rx Pan			
	Output	Output Assign		
		Level		
		Pan		
	Part 5	Timbre	Timbre #	
			V.Rsv	Voice Reserve
		MIDI	Rx Ch	
			Key Range	--
Velocity Thresh				
Rx Volume				
Rx Pan				
Output		Output Assign		
		Level		
		Pan		
Part 6		Timbre	Timbre #	
			V.Rsv	Voice Reserve
		MIDI	Rx Ch	
			Key Range	--
	Velocity Thresh			
	Rx Volume			
	Rx Pan			
	Output	Output Assign		
		Level		
		Pan		
	Rhythm Part	Rhythm Set #		
		Voice Reserve		
		Rx Ch		
		Level		
Boost				
Rx Volume				
Rx Hold				

Date _____

■ Timbre # :		Name :	
Tone #			
Level	Timbre Level		
	Velocity		
	Ch Aftertouch		
	Env Attack		
	Env Decay		
	Env Sustain		
	Env Release		
Pitch	Pitch Coarse		
	Pitch Fine		
	Bender Range (Down)		
	Bender Range (Up)		
	Ch Aftertouch		
	Poly Aftertouch		
	A. Bend Depth		
	A. Bend Rate		
	Detune Depth		
Vib	Rate		
	Waveform		
	Depth		
	Delay Time		
	Rise Time		
	Mod. Depth		
	Ch Aftertouch		
	Poly Aftertouch		

■ Timbre # :		Name :	
Tone #			
Level	Timbre Level		
	Velocity		
	Ch Aftertouch		
	Env Attack		
	Env Decay		
	Env Sustain		
	Env Release		
Pitch	Pitch Coarse		
	Pitch Fine		
	Bender Range (Down)		
	Bender Range (Up)		
	Ch Aftertouch		
	Poly Aftertouch		
	A. Bend Depth		
	A. Bend Rate		
	Detune Depth		
Vib	Rate		
	Waveform		
	Depth		
	Delay Time		
	Rise Time		
	Mod. Depth		
	Ch Aftertouch		
	Poly Aftertouch		

■ Timbre # :		Name :	
Tone #			
Level	Timbre Level		
	Velocity		
	Ch Aftertouch		
	Env Attack		
	Env Decay		
	Env Sustain		
	Env Release		
Pitch	Pitch Coarse		
	Pitch Fine		
	Bender Range (Down)		
	Bender Range (Up)		
	Ch Aftertouch		
	Poly Aftertouch		
	A. Bend Depth		
	A. Bend Rate		
	Detune Depth		
Vib	Rate		
	Waveform		
	Depth		
	Delay Time		
	Rise Time		
	Mod. Depth		
	Ch Aftertouch		
	Poly Aftertouch		

Date _____

■ Rhythm Set # : Name :

Bender (Down)	
Bender (Up)	

Inst # :

Tone # : Name	- :
Source Key	
Mute	
Level	
Velocity	
Env Mode	
Env Attack	
Env Decay	
Env Release	
Pitch Coarse	
Pitch Fine	
Ch Aftertouch	
Poly Aftertouch	
Pitch Random	
A. Bend Depth	
A. Bend Rate	
Detune Depth	
Output Assign	
Pan	

■ Rhythm Set # : Name :

Bender (Down)	
Bender (Up)	

Inst # :

Tone # : Name	- :
Source Key	
Mute	
Level	
Velocity	
Env Mode	
Env Attack	
Env Decay	
Env Release	
Pitch Coarse	
Pitch Fine	
Ch Aftertouch	
Poly Aftertouch	
Pitch Random	
A. Bend Depth	
A. Bend Rate	
Detune Depth	
Output Assign	
Pan	

■ Rhythm Set # : Name :

Bender (Down)	
Bender (Up)	

Inst # :

Tone # : Name	- :
Source Key	
Mute	
Level	
Velocity	
Env Mode	
Env Attack	
Env Decay	
Env Release	
Pitch Coarse	
Pitch Fine	
Ch Aftertouch	
Poly Aftertouch	
Pitch Random	
A. Bend Depth	
A. Bend Rate	
Detune Depth	
Output Assign	
Pan	

■ Rhythm Set # : Name :

Bender (Down)	
Bender (Up)	

Inst # :

Tone # : Name	- :
Source Key	
Mute	
Level	
Velocity	
Env Mode	
Env Attack	
Env Decay	
Env Release	
Pitch Coarse	
Pitch Fine	
Ch Aftertouch	
Poly Aftertouch	
Pitch Random	
A. Bend Depth	
A. Bend Rate	
Detune Depth	
Output Assign	
Pan	

Date

■ Rhythm Set # :		Name :		Bender ▼ :		▲ :				
		Tone			Level		Pitch		Output	
		Tone # : Name	Source	Mute	Level	Velo	Coarse	Fine	Assign	Pan
C2	35									
	36	37								
	38									
	40	39								
	41									
	43	42								
	45	44								
	47	46								
C3	48									
	50	49								
	52	51								
	53									
	55	54								
	57	56								
	59	58								
C4	60									
	62	61								
	64	63								
	65									
	67	66								
	69	68								
	71	70								
C5	72									
	74	73								
	76	75								
	77									
	79	78								
	81	80								
	83	82								
C6	84									
	86	85								
	88	87								
	89									
	91	90								
	93	92								
	95	94								
C7	96									
	98	97								

Date _____

■ Jump

EXIT

ENTER

.....

.....

◀ PART/INST

PART/INST ▶

.....

.....

◀ CURSOR

CORSOR ▶

.....

.....

▽ VALUE

VALUE ▲

.....

.....

Roland Exclusive Messages

1. Data Format for Exclusive Messages

Roland's MIDI implementation uses the following data format for all exclusive messages (type IV):

Byte	Description
F0H	Exclusive status
41H	Manufacturer ID (Roland)
DEV	Device ID
MDL	Model ID
CMD	Command ID
[BODY]	Main data
F7H	End of exclusive

MIDI status : F0H, F7H

An exclusive message must be flanked by a pair of status codes, starting with a Manufacturer-ID immediately after F0H (MIDI version 1.0).

Manufacturer-ID : 41H

The Manufacturer-ID identifies the manufacturer of a MIDI instrument that triggers an exclusive message. Value 41H represents Roland's Manufacturer-ID.

Device ID : DEV

The Device-ID contains a unique value that identifies the individual device in the multiple implementation of MIDI instruments. It is usually set to 00H - 0FH, a value smaller by one than that of a basic channel, but value 00H - 1FH may be used for a device with multiple basic channels.

Model ID : MDL

The Model-ID contains a value that uniquely identifies one model from another. Different models, however, may share an identical Model-ID if they handle similar data.

The Model-ID format may contain 00H in one or more places to provide an extended data field. The following are examples of valid Model-IDs, each representing a unique model:

01H
02H
03H
00H, 01H
00H, 02H
00H, 00H, 01H

Command-ID : CMD

The Command-ID indicates the function of an exclusive message. The Command-ID format may contain 00H in one or more places to provide an extended data field. The following are examples of valid Command-IDs, each representing a unique function:

01H
02H
03H
00H, 01H
00H, 02H
00H, 00H, 01H

Main data : BODY

This field contains a message to be exchanged across an interface. The exact data size and contents will vary with the Model-ID and Command-ID.

2. Address-mapped Data Transfer

Address mapping is a technique for transferring messages conforming to the data format given in Section 1. It assigns a series of memory-resident records—waveform and tone data, switch status, and parameters, for example—to specific locations in a machine-dependent address space, thereby allowing access to data residing at the address a message specifies.

Address-mapped data transfer is therefore independent of models and data categories. This technique allows use of two different transfer procedures: one-way transfer and handshake transfer.

One-way transfer procedure (See Section 3 for details.)

This procedure is suited for the transfer of a small amount of data. It sends out an exclusive message completely independent of a receiving device status.

Connection Diagram

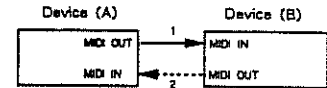

Connection at point 2 is essential for "Request data" procedures. (See Section 3.)

Handshake-transfer procedure (See Section 4 for details.)

This procedure initiates a predetermined transfer sequence (handshaking) across the interface before data transfer takes place. Handshaking ensures that reliability and transfer speed are high enough to handle a large amount of data.

Connection Diagram

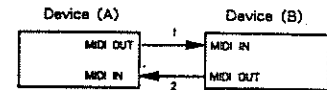

Connection at points 1 and 2 is essential.

Notes on the above two procedures

*There are separate Command-IDs for different transfer procedures.

*Devices A and B cannot exchange data unless they use the same transfer procedure, share identical Device-ID and Model-ID, and are ready for communication.

3. One-way Transfer Procedure

This procedure sends out data all the way until it stops and is used when the messages are so short that answerbacks need not be checked.

For long messages, however, the receiving device must acquire each message in time with the transfer sequence, which inserts intervals of at least 20 milliseconds in between.

Types of Messages

Message	Command ID
Request data 1	RQ1 (11H)
Data set 1	DT1 (12H)

Request data # 1 : RQ1 (11H)

This message is sent out when there is a need to acquire data from a device at the other end of the interface. It contains data for the address and size that specify designation and length, respectively, of data required.

On receiving an RQ1 message, the remote device checks its memory for the data address and size that satisfy the request.

If it finds them and is ready for communication, the device will transmit a "Data set 1 (DT1)" message, which contains the requested data. Otherwise, the device will send out nothing.

Byte	Description
F0H	Exclusive status
41H	Manufacturer ID (Roland)
DEV	Device ID
MDL	Model ID
11H	Command ID
asH	Address MSB
⋮	⋮
	LSB
asH	Size MSB
⋮	⋮
	LSB
sum	Check sum
F7H	End of exclusive

Roland Exclusive Messages

Request data : RQD (41H)

This message is sent out when there is a need to acquire data from a device at the other end of the interface. It contains data for the address and size that specify designation and length, respectively, of data required.

On receiving an RQD message, the remote device checks its memory for the data address and size which satisfy the request. If it finds them and is ready for communication, the device will transmit a "Data set (DAT)" message, which contains the requested data. Otherwise, it will return a "Rejection (RJC)" message.

Byte	Description
F0H	Exclusive status
41H	Manufacturer ID (Roland)
DEV	Device ID
MDL	Model ID
41H	Command ID
aaH	Address MSB
⋮	⋮
	LSB
aaH	Size MSB
⋮	⋮
	LSB
sum	Check sum
F7H	End of exclusive

*The size of the requested data does not indicate the number of bytes that make up a "Data set (DAT)" message, but represents the address fields where the requested data resides.

*Some models are subject to limitations in data format used for a single transaction. Requested data, for example, may have a limit in length or must be divided into predetermined address fields before it is exchanged across the interface.

*The same number of bytes comprises address and size data, which, however, vary with the Model-ID.

*The error checking process uses a checksum that provides a bit pattern where the least significant 7 bits are zero when values for an address, size, and that checksum are summed.

Data set : DAT (42H)

This message corresponds to the actual data transfer process. Because every byte in the data is assigned a unique address, the message can convey the starting address of one or more data as well as a series of data formatted in an address-dependent order.

Although the MIDI standards inhibit non-real time messages from interrupting an exclusive one, some devices support a "soft-through" mechanism for such interrupts. To maintain compatibility with such devices, Roland has limited the DAT to 256 bytes so that an excessively long message is sent out in separate segments.

Byte	Description
F0H	Exclusive status
41H	Manufacturer ID (Roland)
DEV	Device ID
MDL	Model ID
42H	Command ID
aaH	Address MSB
⋮	⋮
	LSB
ddH	Data
⋮	⋮
sum	Check sum
F7H	End of exclusive

*A DAT message is capable of providing only the valid data among those specified by an RQD or WSD message.

*Some models are subject to limitations in data format used for a single transaction. Requested data, for example, may have a limit in length or must be divided into predetermined address fields before it is exchanged across the interface.

*The number of bytes comprising address data varies from one model ID to another.

*The error checking process uses a checksum that provides a bit pattern where the least significant 7 bits are zero when values for an address, size, and that checksum are summed.

Acknowledge : ACK (43H)

This message is sent out when no error was detected on reception of a WSD, DAT, "End of data (EOD)", or some other message and a requested setup or action is complete. Unless it receives an ACK message, the device at the other end will not proceed to the next operation.

Byte	Description
F0H	Exclusive status
41H	Manufacturer ID (Roland)
DEV	Device ID
MDL	Model ID
43H	Command ID
F7H	End of exclusive

End of data : EOD (45H)

This message is sent out to inform a remote device of the end of a message. Communication, however, will not come to an end unless the remote device returns an ACK message even though an EOD message was transmitted.

Byte	Description
F0H	Exclusive status
41H	Manufacturer ID (Roland)
DEV	Device ID
MDL	Model ID
45H	Command ID
F7H	End of exclusive

Communications error : ERR (4EH)

This message warns the remote device of a communications fault encountered during message transmission due, for example, to a checksum error. An ERR message may be replaced with a "Rejection (RJC)" one, which terminates the current message transaction in midstream.

When it receives an ERR message, the sending device may either attempt to send out the last message a second time or terminate communication by sending out an RJC message.

Byte	Description
F0H	Exclusive status
41H	Manufacturer ID (Roland)
DEV	Device ID
MDL	Model ID
4EH	Command ID
F7H	End of exclusive

Rejection : RJC (4FH)

This message is sent out when there is a need to terminate communication by overriding the current message. An RJC message will be triggered when:

- a WSD or RQD message has specified an illegal data address or size.
- the device is not ready for communication.
- an illegal number of addresses or data has been detected.
- data transfer has been terminated by an operator.
- a communications error has occurred.

An ERR message may be sent out by a device on either side of the interface. Communication must be terminated immediately when either side triggers an ERR message.

Byte	Description
F0H	Exclusive status
41H	Manufacturer ID (Roland)
DEV	Device ID
MDL	Model ID
4FH	Command ID
F7H	End of exclusive

= Example of Message Transactions

● Data transfer from device (A) to device (B).

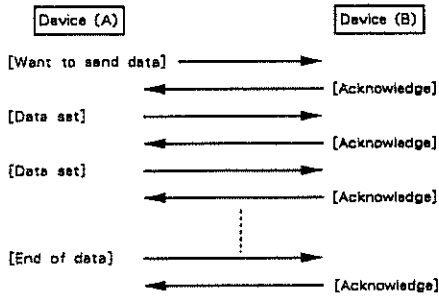

● Device (A) requests and receives data from device (B).

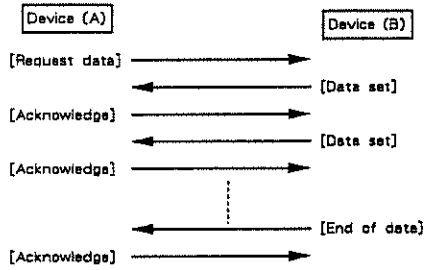

● Error occurs while device (A) is receiving data from device (B).

1) Data transfer from device (A) to device (B).

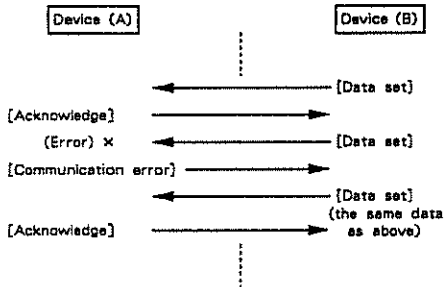

2) Device (B) rejects the data re-transmitted, and quits data transfer.

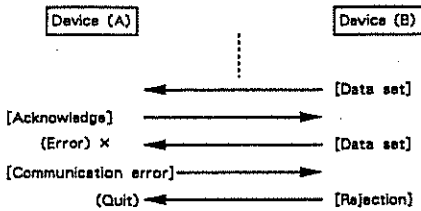

3) Device (A) immediately quits data transfer.

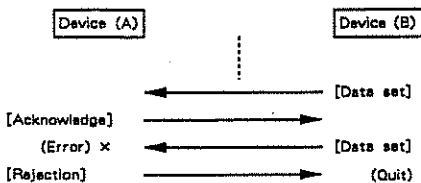

1. TRANSMITTED DATA

■ Channel Voice Message

● Control Change

○ Data Entry

Status	Second	Third
DnH	08H	mmH

mm = MSB of the value of the parameter specified by RPN
 n = MIDI channel No. 0H - FH (0 - 15) 0 = ch.1 15 = ch.16

Status	Second	Third
BnH	26H	llH

ll = LSB of the value of the parameter specified by RPN
 n = MIDI channel No. 0H - FH (0 - 15) 0 = ch.1 15 = ch.16

○ RPN LSB

Status	Second	Third
BnH	64H	vvH

vv = LSB of the parameter number controlled by RPN
 n = MIDI channel No. 0H - FH (0 - 15) 0 = ch.1 15 = ch.16

○ RPN MSB

Status	Second	Third
BnH	65H	vvH

vv = MSB of the parameter number controlled by RPN
 n = MIDI channel No. 0H - FH (0 - 15) 0 = ch.1 15 = ch.16

*** RPN ***

The Control Change can employ an RPN (Registered Parameter Number), or a message that can be used after being registered for MIDI. Using MIDI RPN, parameters can be changed by Control Change messages. RPN MSB and LSB specify the parameter to be controlled, while Data Entry provides the parameter value.

Master Fine Tune is transmitted by RPN on U-220.

RPN	Data Entry	Comments
MSB	MSB	LSB
00H	01H	mmH llH
Master Fine Tune		
	MSB	LSB
	20	00 -50 cent
	:	
	40	00 0 cent
	:	
	60	00 +50 cent

*In 'Edit/Setup/M.Tune', The U-220 transmits PRN MSB, RPN LSB and Data Entry (MSB, LSB) when [ENTER] key is pressed.

*The message is recognized through 'Setup/MIDI/Rx Control Ch'.

■ System Exclusive Message

Status	Data
F0H	llH,ddH,.....,eeH
F7H	

F0H : System Exclusive
 ll = ID number : 40H (65)
 dd...ee = data : 00H - 7FH (0 - 127)
 F7H : EOX (End of Exclusive/System Common)

*A set of various parameter is transmitted, and received using MIDI System Exclusive messages.

Refer to section 3 and 'Roland Exclusive Messages' for details.

2. RECOGNIZED RECEIVE DATA

This message is always recognized except for ROM Play.

■ Channel Voice Message

● Note Off

Status	Second	Third
8nH	kkH	vvH
9nH	kkH	00H

kk = Note number 0H - 7FH (0 - 127)
 vv = Velocity Ignored
 n = MIDI channel No. 0H - FH (0 - 15) 0 = ch.1 15 = ch.16

*The message is recognized through 'Patch/Part/MIDI/Rx Ch', 'Patch/R.Part/Rx Ch'.

*The message is recognized through 'Patch/Part/MIDI/Key Range'.

● Note On

Status	Second	Third
9nH	kkH	vvH

kk = Note number 0H - 7FH (0 - 127)
 vv = Velocity 1H - 7FH (1 - 127)
 n = MIDI channel No. 0H - FH (0 - 15) 0 = ch.1 15 = ch.16

*The message is recognized through 'Patch/Part/MIDI/Rx Ch', 'Patch/R.Part/Rx Ch'.

*Note number is recognized through 'Patch/Part/MIDI/Key Range'.

*Note velocity is recognized through 'Patch/Part/MIDI/V.Thresh'.

● Polyphonic Key Pressure

Status	Second	Third
AnH	kkH	vvH

kk = Note number 0H - 7FH (0 - 127)
 vv = 0H - 7FH (0 - 127)
 n = MIDI channel No. 0H - FH (0 - 15) 0 = ch.1 15 = ch.16

*The message is recognized through 'Patch/Part/MIDI/Rx Ch', 'Patch/R.Part/Rx Ch'.

● Control Change

○ Modulation Depth

Status	Second	Third
BnH	01H	vvH

vv = 0H - 7FH (0 - 127)
 n = MIDI channel No. 0H - FH (0 - 15) 0 = ch.1 15 = ch.16

*The message is recognized through 'Patch/Part/MIDI/Rx Ch', 'Patch/R.Part/Rx Ch'.

○ Volume

Status	Second	Third
BnH	07H	vvH

vv = 0H - 7FH (0 - 127)
 n = MIDI channel No. 0H - FH (0 - 15) 0 = ch.1 15 = ch.16

*The message is recognized through 'Patch/Part/MIDI/Rx Ch', 'Patch/R.Part/Rx Ch'.

*The message is not recognized if 'Patch/Part/MIDI/Rx Volume' is set as 'Off', or 'Patch/R.Part/Rx Volume' is set as 'Off'.

*The value (vvH) corresponds to 'Patch/Part/Output/Level'.

○ Pan

Status	Second	Third
BnH	0AH	vvH

vv = 0H - 7FH (0 - 127)
 n = MIDI channel No. 0H - FH (0 - 15) 0 = ch.1 15 = ch.16

* The message is recognized through 'Patch/Part/MIDI/Rx Ch'.
 * The message is not recognized if 'Patch/Part/MIDI/Rx Pan' is set as 'Off'.
 * The message is through 'Patch/Part/Output/Pan', but range are changed from 7 > to < 7.

○ Hold1

Status	Second	Third
BnH	40H	vvH

vv = 0H - 3FH (0 - 63) : Off, 40H - 7FH (64 - 127) : On
 n = MIDI channel No. 0H - FH (0 - 15) 0 = ch.1 15 = ch.16

* The message is recognized through 'Patch/Part/MIDI/Rx Ch', 'Patch/R.Part/Rx Ch'.
 * The message is not recognized if 'Patch/Part/MIDI/Rx Hold' is set as 'Off', or 'Patch/R.Part/Rx Hold' is set as 'Off'.

○ Sound Control Parameter 1

Status	Second	Third
BnH	cch	vvH

cch = 0H - 5H (0 - 5), 7H - 1FH (7 - 31), 40H - 5FH (64 - 95)
 vvH = 0H - 7FH (0 - 127)
 n = MIDI channel No. 0H - FH (0 - 15) 0 = ch.1 15 = ch.16

* The message is recognized through 'Setup/MIDI/Rx Control Ch', 'Patch/Part/MIDI/Rx Ch' and 'Patch/R.Part/Rx Ch'.

* Change the number through 'Patch/Ctrl/Prm1,2,3 #'.

○ Data Entry

Status	Second	Third
BnH	08H	mmH

mm = MSB of the value of the parameter specified by RPN
 n = MIDI channel No. 0H - FH (0 - 15) 0 = ch.1 15 = ch.16

Status	Second	Third
BnH	26H	llH

ll = LSB of the value of the parameter specified by RPN
 n = MIDI channel No. 0H - FH (0 - 15) 0 = ch.1 15 = ch.16

○ RPN LSB

Status	Second	Third
BnH	64H	vvH

vv = LSB of the parameter number controlled by RPN
 n = MIDI channel No. 0H - FH (0 - 15) 0 = ch.1 15 = ch.16

○ RPN MSB

Status	Second	Third
BnH	65H	vvH

vv = MSB of the parameter number controlled by RPN
 n = MIDI channel No. 0H - FH (0 - 15) 0 = ch.1 15 = ch.16

* Master Fine Tune and Pitch Bend Sensitivity are controllable by RPN on U - 220.

RPN	Data Entry	Comments
MSB LSB	MSB LSB	
00H 00H	mmH llH	Pitch Bend Sensitivity
		MSB LSB
		00 ignore 0 cent
		:
		0C ignore 1200 cent
		:
		0D ignore
		:
		7F ignore

* The message is recognize through 'Patch/Part/Rx Ch', 'Patch/R.Part/Rx Ch'.

RPN	Data Entry	Comments
MSB LSB	MSB LSB	
00H 01H	vvH uufI	Master Fine Tune
		MSB LSB
		20 00 - 60 cent
		:
		40 00 0 cent
		:
		60 00 + 60 cent

* The message is recognized through 'Setup/MIDI/Rx Control Ch'.

● Program Change

Status	Second
CnH	ppH

pp = Program Change number 0H - 7FH (0 - 127)
 n = MIDI channel No. 0H - FH (0 - 15) 0 = ch.1 15 = ch.16

* The Program Change is not recognized except for PLAY mode.

○ In the case of Patch Change

pp = 0H - 3FH (0 - 63) ... Patch # P - 01 - P - 64
 The Patch Change is recognized through 'Setup/MIDI/Rx Control Ch'.
 The Patch Change is not recognized if 'Setup/MIDI/Rx Patch Change' is set as 'Off', or 'Rx Patch Change' is set as 'Map' and the converted value is set as 'Off'.

○ In the case of Timbre Change

pp = 0H - 7FH (0 - 127) ... Timbre # T - 001 - T - 128
 The Timbre Change is recognized through 'Patch/Part/MIDI/Rx Ch'.
 The Timbre Change is not recognized if 'Setup/MIDI/Rx Timbre Change' is set as 'Off', or 'Rx Timbre Change' is set as 'Map' and the converted value is set as 'Off'.

○ In the case of Rhythm - Set Change

pp = 0H - 3H (0 - 3) ... Rhythm - Set # R - 1 - R - 4
 The Rhythm - Set Change is recognized through 'Patch/R.Part/Rx Ch'.
 The Rhythm - Set Change is not recognized if 'Setup/MIDI/Rx Rhythm Change' is set as 'Off', or the 'Rx Rhythm change' is set as 'Map' and the converted value is set as 'Off'.

● Channel Pressure

Status	Second
DnH	vvH

vv = 0H - 7FH (0 - 127)
 n = MIDI channel No. 0H - FH (0 - 15) 0 = ch.1 15 = ch.16

* The message is recognized through 'Patch/Part/MIDI/Rx Ch', 'Patch/R.Part/Rx Ch'.

● Pitch Bend Change

Status	Second	Third
EnH	llH	mmH

ll = Lower Pitch Bender value 00H - 7FH (0 - 127)
 mm = Upper Pitch Bender value 00H - 7FH (0 - 127)
 n = MIDI channel No. 0H - FH (0 - 15) 0 = ch.1 15 = ch.16

* The message is recognized through 'Patch/Part/MIDI/Rx Ch', 'Patch/R.Part/Rx Ch'.

■ Channel Mode Message

● Reset All Controllers

Status	Second	Third
BnH	79H	00H

n = MIDI channel No. 0H - FH (0 - 15) 0 = ch.1 15 = ch.16

* When Reset All Controllers is recognized, each of the controllers is set as follows.

Controller	Value
Modulation	0 (min)
Hold1	0 (off)
Pitch Bend Change	+ / - 0 (center)
Channel Pressure	0 (min)
Polyphonic Key Pressure	0 (min)

* The message is recognized through 'Patch / Part / MIDI / Rx Ch', 'Patch / R.Part / Rx Ch'.

● All Notes Off

<u>Status</u>	<u>Second</u>	<u>Third</u>
BnH	7BH	00H

n = MIDI channel No. 0H - FH (0 - 15) 0 = ch.1 15 = ch.16

* When All Notes Off is recognized, all the notes which have been turned on by MIDI Note On message are turned off.

* The message is recognized through 'Patch / Part / MIDI / Rx Ch', 'Patch / R.Part / Rx Ch'.

● Omni Off

<u>Status</u>	<u>Second</u>	<u>Third</u>
BnH	7CH	00H

n = MIDI channel No. 0H - FH (0 - 15) 0 = ch.1 15 = ch.16

* Recognized as All Notes Off only.
* The U - 220 stays in Mode 3 (Omni Off, Poly).

● Omni On

<u>Status</u>	<u>Second</u>	<u>Third</u>
BnH	7DH	00H

n = MIDI channel No. 0H - FH (0 - 15) 0 = ch.1 15 = ch.16

* Recognized as All Notes Off only.
* The U - 220 stays in Mode 3 (Omni Off, Poly).

● Mono

<u>Status</u>	<u>Second</u>	<u>Third</u>
BnH	7EH	mmH

mm = Mono channel range ignore
n = MIDI channel No. 0H - FH (0 - 15) 0 = ch.1 15 = ch.16

* Recognized as All Notes Off only.
* The U - 220 stays in Mode 3 (Omni Off, Poly).

● Poly

<u>Status</u>	<u>Second</u>	<u>Third</u>
BnH	7FH	00H

n = MIDI channel No. 0H - FH (0 - 15) 0 = ch.1 15 = ch.16

* Recognized as All Notes Off only.
* The U - 220 stays in Mode 3 (Omni Off, Poly).

■ System Realtime Message

● Active Sensing

Status
FEH

* Once receiving this message, the U - 220 expects to accept status or data in sequence, at last within 300 msec intervals. If the unit fails to receive a message 300 msec after previous one, it judges there is a problem somewhere in MIDI path, muting the current sound and setting each of controllers as below; then stopping 300 msec - interval monitoring of incoming signal.

■ System Exclusive Message

<u>Status</u>	<u>Data</u>
F0H	!!!,ddH,....eeH
F7H	

F0H : System Exclusive
H = ID number : 40H (66)
dd,....ee = data : 00H - 7FH (0 - 127)
F7H : EOX (End of Exclusive / System Common)

* A set of various parameter is transmitted, and received using MIDI System Exclusive messages.

* The message is not recognized if 'Setup / MIDI / Rx SysEx' is set as 'Off'.
* Recognized through 'Setup / MIDI / Device ID'.

Refer to section 3 and 'Roland Exclusive Messages' for details.

3. EXCLUSIVE COMMUNICATIONS

U - 220's exclusive map is roughly divided into two area, Bulk - Dump area and individual parameter area.

Bulk - Dump area is suited for dumping a set of parameters owing to its hi - speedness, while individual parameter area is suited for controlling each parameter.

■ Device ID

The message is transmitted or received through 'Setup / MIDI / Device ID'.

■ Model ID

Model - ID# in the Exclusive message : 2BH

■ Bulk Dump

When U - 220 is transmitter, Panel operation or MIDI Exclusive Data Request1.

U - 220's Bulk - Dump follows the rules shown below.

1. One byte data read from U - 220's internal memory is transferred after it is divided into two (upper 4 bits and lower 4 bits).
For example, 0ABh will be divided into 0Bh and 0Ah (lower first).

2. In the case of sending 1 packet of Exclusive message, 64 bytes of internal data will be transferred in 128 bytes.

However, the last 1 packet to be sent may get fractional according to the amount of data to be read from internal memory.

Therefore, contents of Bulk - Dump can easily be known from the structure of internal memory's data.

[Table1] - [Table8] are maps of internal memory, not maps of MIDI. Transformation must be considered for address and data.

The first address to be read for Bulk - Dump is noted 0.

If certain bits of 1 byte data have meanings individually, their bit numbers are also noted. Bits that are not specified are to be recognized as "-" (reserved).

Basical value for data noted as "reserved" is 0.

As for values and display, refer to the explanation of individual parameter area. Explanation is common between the two. However, some of the Set up parameters cannot be controlled individually. Those kinds are explained here.

■ Transmit

Exclusive messages are transmitted under following conditions.

1) Edit Parameter Dump

Value of parameter currently being edited can be transmitted by pressing [ENTER]. However, parameters that are not supported by Exclusive message will not be transmitted.

2) Bulk Dump Mode

<u>Transmit as follows.</u>	<u>Parameters</u>
Data / Bulk / Temp :	All, Patch, Timbre [1]-[6], Timbre All, Rhythm Setup
Data / Bulk / Memory :	All, Setup, Patch, Timbre, Rhythm Setup

3) Recognize RQ1

When receiving RQ1 (refer to Roland Exclusive Format), parameter corresponding to the address is transmitted. RQ1 for certain parameters is ignored.

U - 220 can not send discontinuous blocks by one RQ1.

■ Recognized Receive Data

This message is always recognized except for ROM Play.

■ Parameter Address Map

address DT: RQ1 (*...available)

[Bulk Dump Area]

00 00 00 * * Setup Parameter	00 00 10H Bytes [Table 1] (Size of Exclusive Address Map)
00 06 00 * * Patch Temp	00 01 20H Bytes [Table 2]
00 10 00 * * Timbre[1] Temp	00 00 40H Bytes [Table 3]
00 11 00 * * Timbre[2] Temp	00 00 40H Bytes
00 12 00 * * Timbre[3] Temp	00 00 40H Bytes
00 13 00 * * Timbre[4] Temp	00 00 40H Bytes
00 14 00 * * Timbre[5] Temp	00 00 40H Bytes
00 15 00 * * Timbre[6] Temp	00 00 40H Bytes
00 20 00 * * Rhythm Setup Temp	00 0C 20H Bytes [Table 4]
02 00 00 * * Timbre T-001...128	00 40 00H Bytes [Table 5]
03 00 00 * * Patch P-01...P-64	00 50 00H Bytes [Table 6]
05 00 00 * * Rhythm Setup R-1...R-4	00 31 00H Bytes [Table 7]
07 00 00 * * Patch Map Map1...Map4	00 08 00H Bytes [Table 8]
07 08 00 * * Timbre Map Map1...Map4	00 08 00H Bytes
07 10 00 * * Rhythm Map Map1...Map4	00 08 00H Bytes
07 18 00 * * R. Inst Map Map1...Map4	00 08 00H Bytes

[Individual Parameter Control Area]

Temporary Area : Patch, Timbre, Rhythm Setup.

10 00 00 * * Setup Parameter	00 00 03H Bytes [Table 9]
10 04 00 * * Patch Common	00 00 29H Bytes [Table 10]
10 04 60 * * Patch Rhythm Part	00 00 07H Bytes [Table 11]
10 05 00 * * Patch Part1	00 00 0DH Bytes [Table 12]
10 05 10 * * Patch Part2	00 00 0DH Bytes
10 05 50 * * Patch Part6	00 00 0DH Bytes
10 10 00 * * Timbre[1]	00 00 32H Bytes [Table 13]
10 11 00 * * Timbre[2]	00 00 32H Bytes
10 15 00 * * Timbre[6]	00 00 32H Bytes
11 00 00 * * Rhythm Setup Common	00 00 1AH Bytes [Table 14]
11 23 00 * * Rhythm Setup Inst=B1	00 00 14H Bytes [Table 15]
11 24 00 * * Rhythm Setup Inst=C2	00 00 14H Bytes
11 63 00 * * Rhythm Setup Inst=D7	00 00 14H Bytes

[Table 1] Setup Parameter

Memory Offset Address	Description
00 00H	bit E-F - Chorus Sw (0...1 : Off...On) Reverb Sw (0...1 : Off...On)
00 02H	bit 0-F - LCD Contrast (0...15 : 0...15)
00 04H	bit 5-F - Master Tune (0...255 : 427.4...452.9)
00 06H	bit 0-4 - Rx Ctrl Channel (0...15 : 1...16, Off)
00 08H	bit F -

bit C-E	R. Inst Assign	(0...5 : Map1...Map4, Dir, Off)
bit B	-	
bit B-A	Rhythm Change	(0...5 : Map1...Map4, Dir, Off)
bit 7	-	
bit 4-6	Timbre Change	(0...5 : Map1...Map4, Dir, Off)
bit 3	-	
bit 0-2	Patch Change	(0...5 : Map1...Map4, Dir, Off)

Total size = 08H (Size on Memory)

[Table 2] Patch Temporary

Memory Offset address	Description	
00 00H	bit 0-7	Name
:		
00 0BH		
00 0CH	bit B-F	Chorus Depth
bit B-A		Chorus Level
bit 5		-
bit 0-4		Chorus Rate
00 0EH	bit D-F	Chorus Type
bit 7-C		Chorus Feedback
bit 6		-
bit 0-5		Rev/Delay Time
00 10H	bit B-F	Delay Feedback
bit 5-A		-
bit 0-4		Chorus Delay Time
00 12H	bit F	Chorus Out Mode
bit C-E		Rev/Delay Type
bit B		-
bit B-A		Rev Pre Delay Time
bit 5		-
bit 0-4		Rev/Delay Level
00 14H	bit D-F	-
bit B-C		Parameter1
bit 7		-
bit 0-6		Ctrl # 1
00 16H	bit D-F	-
bit B-C		Parameter2
bit 7		-
bit 0-6		Ctrl # 2
00 18H	bit D-F	-
bit B-C		Parameter3
bit 7		-
bit 0-6		Ctrl # 3
00 1AH	bit F	-
bit E		Rx Volume
bit D		Rx Hold
bit B-C		Rhythm Part Channel
bit 7		-
bit 5-6		Rhythm Setup #
bit 0-4		Rhythm Part Voice Reserve
00 1CH	bit B-F	-
bit 7		Rhythm Part Level Boost Sw
bit 0-6		Rhythm Part Level

----- Part 1-6 -----

Memory Offset address	Description	
00 1EH	bit D-F	Output Assign
bit B-C		Voice Reserve
bit 7		Rx Volume
bit 0-6		Timbre #
00 20H	bit C-F	Panning
bit 5-B		Part Level
bit 0-4		Receive Channel (off, 1-16)
00 22H	bit F	Rx Pan
bit B-E		Key Range HI
bit 7		Rx Hold
bit 0-6		Key Range Low
00 24H	bit F	-
bit B-E		Velo Threshold
bit 1-7		-
bit 0		Velo Level

Total size = 50H

[Table 3] Timbre1, 2, 3, 4, 5, 6 Temporary

Offset address	Description	
00 00H	bit 0-7	Name
:		
00 0BH		
00 0CH	bit C-F	Detune Depth
bit 7-B		Tone Media
bit 0-6		Tone #
00 0EH	bit F	-
bit B-E		Timbre Level
bit 4-7		Level Channel Press Sens
bit 0-3		Level Velo Sens
00 10H	bit C-F	Env Release
bit B-B		Env Sustain
bit 4-7		Env Decay
bit 0-3		Env Attack
00 12H	bit E-F	-
bit B-D		Pitch Shift Coarse
bit 7		-
bit 0-6		Pitch Shift Fine
00 14H	bit E-F	-
bit 9-D		Auto Bend Depth
bit 5-B		Bend Range Upper
bit 0-4		Bend Range Lower
00 16H	bit E-F	-
bit A-D		Auto Bend Rate
bit 5-9		Pitch Ch. Press Sens
bit 0-4		Pitch Poly Press Sens
00 18H	bit C-F	Vib Depth
bit B-B		Vib Delay
bit 4-7		Vib Modulation Depth
bit 0-3		-
00 1AH	bit C-F	-
bit B-B		Vib Waveform
bit B-7		-
bit 0-5		Vib Rate
00 1CH	bit C-F	Vib Poly Press Sens
bit B-B		Vib Ch Press Sens
bit 4-7		-
bit 0-3		Vib Rise Time
00 1EH	bit 0-F	-

Total size = 20H

[Table 4] Rhythm Setup Temporary

Offset address	Description	
00 00H	bit 0-7	Name
:		
00 0BH		
00 0CH	bit 8-F	-
bit 5-8		Bend Range Upper
bit 0-4		Bend Range Lower
----- Inst "B1" -- "D7" -----		
Offset address	Description	
00 0EH	bit C-F	Detune Depth
bit 7-B		Tone Media
bit 0-6		Tone #
00 10H	bit C-F	Auto Bend Rate
bit 7-B		Pitch Offset Coarse
bit 0-6		Pitch Offset Fine
00 12H	bit F	Env Mode
bit A-E		Pitch Channel Press Sens
bit 5-9		Pitch Poly Press Sens
bit 0-4		Auto Bend Depth
00 14H	bit C-F	Env Release
bit 8-B		Env Decay
bit 4-7		Env Attack
bit 0-3	Level Velo Sens	
00 16H	bit F	-
bit 8-E		Mute Inst
bit 7		-
bit 0-6		Source Key
00 18H	bit F	-
bit 8-E		Pitch Randomize
bit 9-A		Out Asgn
bit 4-8		Out Level
bit 0-3		Panning

Total size = 310H

[Table 5] Timbre 1 - 128

Offset address	Description
----------------	-------------

Same as Temporary Timbre Area

Total size = 1000H

[Table 6] Patch 1 - 64

Offset address	Description
----------------	-------------

Same as temporary Patch Area

Total size = 1400H

[Table 7] Rhythm Setup 1 - 4

Offset address	Description
----------------	-------------

Same as Rhythm Setup Area

Total size = C40H

[Table 8] Patch Map, Timbre Map, Rhythm Map, R.Inst Map

Offset address	Description	
00 00H	bit 0-7	Patch Map1 (0...65 : 1...64, Dir, Off)
:		
00 7FH		
00 80H	bit 0-7	Patch Map2
:		
01 FFH		Patch Map4
02 00H	bit 0-7	Timbre Map1 (0...129 : 1...128, Dir, Off)
:		
02 7FH		
02 80H	bit 0-7	Timbre Map2
:		
03 FFH		Timbre Map4
04 00H	bit 0-7	Rhythm Map1 (0...5 : 1...4, Dir, Off)
:		
04 7FH		
04 80H	bit 0-7	Rhythm Map2
:		
05 FFH		Rhythm Map4
06 00H	bit 0-7	R. Inst Map1 (0...65 : 81...D7, Dir, Off)
:		
06 7FH		
06 80H	bit 0-7	R. Inst Map2
:		
07 FFH		R. Inst Map4

Total size = 800H

[Table 9] Setup Parameter (Individual)

address	D71	RQ1	
10 00 00	*	*	Chorus Sw (0...1 : Off...On)
01	*	*	Reverb Sw (0...1 : Off...On)
02	*	*	LCD Contrast (0...15 : 0...15)

Total size = 00 00 03H

[Table 10] Patch Common Parameter (Individual)

```

address DT1 RQ1
10 04 00 * * Patch Name1 Lower 4bit
01 * * Patch Name1 Upper 4bit
:
:
17 * * Patch Name12 Upper 4bit

18 * * Chorus Type
(0...4 : Chorus1, Chorus2, FB-Chorus, Flanger,
Shard Delay)
19 * * Chorus Out Mode (0...1 : Pre Rev, Post Rev)
1A * * Chorus Level (0...31 : 0...31)
1B * * Chorus Delay (0...31 : 0...31)
1C * * Chorus Rate (0...31 : 0...31)
1D * * Chorus Depth (0...31 : 0...31)
1E * * Chorus Feedback (1...63 : -31...+31)
1F * * Reverb Type
(0...7 : Room1, Room2, Room3, Hall1, Hall2, Gate, Delay,
CrossDelay)
20 * * Reverb Time (0...31 : 0...31)
21 * * Reverb Level (0...31 : 0...31)
22 * * Reverb Delay Feedback (0...31 : 0...31)
23 * * Param1 # (0...63 : 00...05, 07...31, 64...95, Off)
24 * * Param1 Param
(0...18 : Timbre Level, Env Attack, Env Decay,
Env Sustain, Env Release, A Bend Depth, A Bend Rate,
Detune Depth, Vib Rate, Vib Waveform, Vib Depth,
Vib Delay, Vib Rise Time, Vib Mod Depth, Chrs Level,
Chrs Rate, Chrs Feedback, Rev Level, Delay Feedback)

25 * * Param2 # (0...63 : 00...05, 07...31, 64...95, Off)
26 * * Param2 Param (Same as Param1)
27 * * Param3 # (0...63 : 00...05, 07...31, 64...95, Off)
28 * * Param3 Param (Same as Param1)

```

Total size = 00 00 29H

[Table 11] Patch Rhythm Part Parameter (Individual)

```

10 04 80 * * Rhythm Setup # (0...3 : 1...4)
81 * * Voice Reserve (0...30 : 0...30)
82 * * Receive Channel (0...16 : 0...16, Off)
83 * * Level (0...127 : 0...127)
84 * * Level Boost Sw (0...1 : Off, On)
85 * * Rx Volume (0...1 : Off, On)
86 * * Rx Hold (0...1 : Off, On)

```

Total size = 00 00 07H

[Table 12] Patch Part1 Parameter (Individual)

```

10 05 00 * * Timbre Number (0...127 : T-001...128)
01 * * Voice Reserve (0...31 : 0...31)
02 * * Receive Channel (0...16 : 1...16, Off)
03 * * Key Range Low (0...127 : C-1...G9)
04 * * Key Range Hi (0...127 : C-1...G9)
05 * * Velo Level (0...1 : Above, Below)
06 * * Velo Threshold (1...127 : 1...127)
07 * * Output Assign (0...4 : Dry, Rev, Cho, Dir1, Dir2)
08 * * Level (0...127 : 0...127)
09 * * Pan (0...15 : 7>...>C...<7, Rnd)
0A * * Rx Volume (0...1 : Off, On)
0B * * Rx Pan (0...1 : Off, On)
0C * * Rx Hold (0...1 : Off, On)

```

Total size = 00 00 0DH

[Table 13] Timbre Parameter [1] (Individual)

```

address DT1 RQ1
10 10 00 * * Patch Name1 Lower 4bit
01 * * Patch Name1 Upper 4bit
:
:
17 * * Patch Name12 Upper 4bit

18 * * Tone Media (0...31 : 1, 01...31)
19 * * Tone Number (0...127 : 000...127)
1A * * Timbre Level (0...127 : 0...127)
1B * * Velocity Sens (1...15 : -7...+7)
1C * * Channel Press Sens (1...15 : -7...+7)
1D * * Env Attack Rate (1...15 : -7...+7)
1E * * Env Decay Rate (1...15 : -7...+7)
1F * * Env Sustain Level (1...15 : -7...+7)
20 * * Env Release Rate (1...15 : -7...+7)
21 * * Pitch Shift Coarse (8...56 : -24...+24)
22 * * Pitch Shift Fine (14...114 : -50...+50)
23 * * Bend Range Lower (0...15 : -36, -24, -12...0)
24 * * Bend Range Upper (0...12 : 00...12)
25 * * Channel After Sens (0...27 : -36, -24, -12...+12)
26 * * Poly After Sens (0...27 : -36, -24, -12...+12)
27 * * Auto Bend Depth (0...27 : -36, -24, -12...+12)
28 * * Auto Bend Rate (0...15 : 0...15)
29 * * Detune Depth (0...15 : 0...15)
2A * * Rate (0...63 : 0...63)
2B * * Waveform (0...8 : Tri, Sine, Square, SawUp, SawDwn, Rand01...4)
2C * * Depth (0...15 : 0...15)
2D * * Delay (0...15 : 0...15)
2E * * Rise Time (0...15 : 0...15)
2F * * Modulation Depth (0...15 : 0...15)
30 * * Ch After Sens (0...15 : 0...15)
31 * * Poly After Sens (0...15 : 0...15)

```

Total size = 00 00 32H

[Table 14] Rhythm Setup Parameter (Individual)

```

address DT1 RQ1
11 00 00 * * Setup Name1 Lower 4bit
01 * * Setup Name1 Upper 4bit
:
:
17 * * Setup Name12 Upper 4bit
18 * * Bender Range Lower (0...15 : 36, 24, 12...0)
19 * * Bender Range Upper (0...12 : 0...12)

```

Total size = 00 00 1AH

[Table 15] Rhythm Setup Parameter Inst = B1 (Individual)

```

11 23 00 * * Tone Media (0...31 : 1, 01...31)
01 * * Tone Number (0...127 : 0...127)
02 * * Source Key (0...127 : C-1...G9)
03 * * Mute Inst (34...98 : Off, B1...D7)
04 * * Inst Level (0...31 : 0...31)
05 * * Velocity Sens (0...15 : 0...15)
06 * * Env Mode (0...1 : Sustain, No Sustain)
07 * * Env Attack Rate (1...15 : -7...+7)
08 * * Env Decay Rate (1...15 : -7...+7)
09 * * Env Release Rate (1...15 : -7...+7)
0A * * Pitch Shift Coarse (0...27 : -36, -24, -12...+12)
0B * * Pitch Shift Fine (14...114 : -50...+50)
0C * * Chnel After Sens (0...27 : -36, -24, -12...+12)
0D * * Poly After Sens (0...27 : -36, -24, -12...+12)
0E * * Random (0...15 : 00...15)
0F * * Auto Bend Depth (0...27 : -36, -24, -12...+12)
10 * * Auto Bend Rate (0...15 : 0...15)
11 * * Detune Depth (0...15 : 0...15)
12 * * Output Assign (0...3 : Dry, Rev, Cho, Dir1)
13 * * Pan (0...15 : 7>...>C...<7, Rnd)

```

Total size = 00 00 14H

[Bulk Dump Area]

address	Block	Sub Block	Reference
00-00-00	Setup Memory		Table 1
00-05-00	Patch Temp		Table 2
00-10-00	Timbre Temp	Timbre [1]	Table 3
		Timbre [2]	
		Timbre [3]	
		Timbre [4]	
		Timbre [5]	
		Timbre [6]	
00-18-00	Rhythm Setup Temp		Table 4
02-00-00	Timbre		Table 5
03-00-00	Patch		Table 6
05-00-00	Rhythm Setup		Table 7
07-00-00	Map	Patch Map	Table 8
		Timbre Map	
		Rhythm Map	
		R. Inst Map	

[Individual Parameter Control Area]

10-00-00	Setup		Table 9
10-04-00	Patch Common		Table 10
10-04-80	Patch Rhythm		Table 11
10-05-00	Patch	Part 1	Table 12
		Part 2	
		Part 3	
		Part 4	
		Part 5	
		Part 6	
10-10-00	Timbre [i] 50bytes	Timber 1	Table 13
		Timber 2	
		Timber 3	
		Timber 4	
		Timber 5	
		Timber 6	
11-00-00	Rhythm Setup Com		Table 14
11-23-00	Rhy Setup Inst=B1	Inst=B1	Table 15
		:	
		Inst=D7	

MIDI Implementation Chart

Function ***		Transmitted	Recognized	Remarks
Basic Channel	Default	1 - 16	1 - 16	Memorized
	Changed	1 - 16	1 - 16	
Mode	Default Messages Altered	Mode 3 x *****	Mode 3 x	
Note Number	True Voice	x *****	0 - 127 0 - 127	
Velocity	Note ON Note OFF	x x	○ x	
After Touch	Key's Ch's	x x	○ ○	
Pitch Bender		x	* 1	9 bit resolution
Control Change	0 - 5, 7 - 31, 64 - 95	x	* 1 (assignable)	prm1, 2, 3
	1	x	○	Modulation Volume Panpot Hold 1
	7	x	○	
	10	x	○	
	64	x	○	
	100, 101 6, 38	* 2 (RPN # 1) * 3	* 2 (RON # 0, # 1) * 3	RPN LSB, MSB Data Entry MSB, LSB
	121	x	○	Reset all Contorolers
Prog Change	True #	x *****	* 1 0 - 127 0 - 127	* 3
System Exclusive		* 2	* 2	
System Common	Song Pos Song Sel Tune	x x x	x x x	
System Real Time	Clock Commands	x x	x x	
Aux Message	Local ON/OFF All Notes OFF Active Sense Reset	x x x x	x ○ ○ x	
Notes	<p>* 1 Can be set to ○ or x manually, and memorized. * 2 Can be memorized manually. * 3 RPN = Registered Parameter Number RPN # 0 : Pitch Bend Sensitivity RPN # 1 : Master Fine Tune</p>			

Mode 1 : OMNI ON, POLY
Mode 3 : OMNI OFF, POLY

Mode 2 : OMNI ON, MONO
Mode 4 : OMNI OFF, MONO

○ : Yes
x : No

■ How to read a MIDI Implementation Chart

○: MIDI data that can be transmitted or received

×: MIDI data that cannot be transmitted or received

* 1 : Transmission or reception can be turned on or off. The setting is remembered even when the power is turned off.

* 2 : Transmission or reception can be turned on or off.

● Basic Channel

The MIDI channel for transmitting (receiving) MIDI data can be specified over this range. The MIDI channel setting is remembered even when the power is turned off.

● Mode

Most recent synthesizers use mode 3 (omni off, poly).

Reception: Data is received only on the specified channels, and played polyphonically.

Transmission: All musical data is transmitted on the specified MIDI channel.

*"Mode" refers to MIDI Mode messages.

● Note Number

This is the range of note numbers that can be transmitted (received). Note number 60 is middle C (C4).

The U-220 does not transmit this message.

● Velocity

This is the range over which velocity can be transmitted (received) by Note On and Note Off messages.

● Aftertouch

Key's: polyphonic aftertouch

Ch's: channel aftertouch

● Pitch Bender

The bender range setting of each Timbre determines the range of pitch change caused by pitch bender data. When set to 0, pitch bender data will be ignored.

● Control Change

This indicates the control numbers that can be transmitted (received), and what they will control. For details, refer to the MIDI implementation.

● Program Change

The program change numbers in the chart indicate the actual data. (This is one less than the Pitch and Timbre program change numbers.)

● Exclusive

Exclusive message reception can be turned on/off by the exclusive switch (setup).

● Common, Realtime

These MIDI messages are used to synchronize sequencers and rhythm machines. The U-220 does not use these messages.

● Other

These messages are mainly used to keep a MIDI system running correctly.

U-220 MIDI Flow Chart

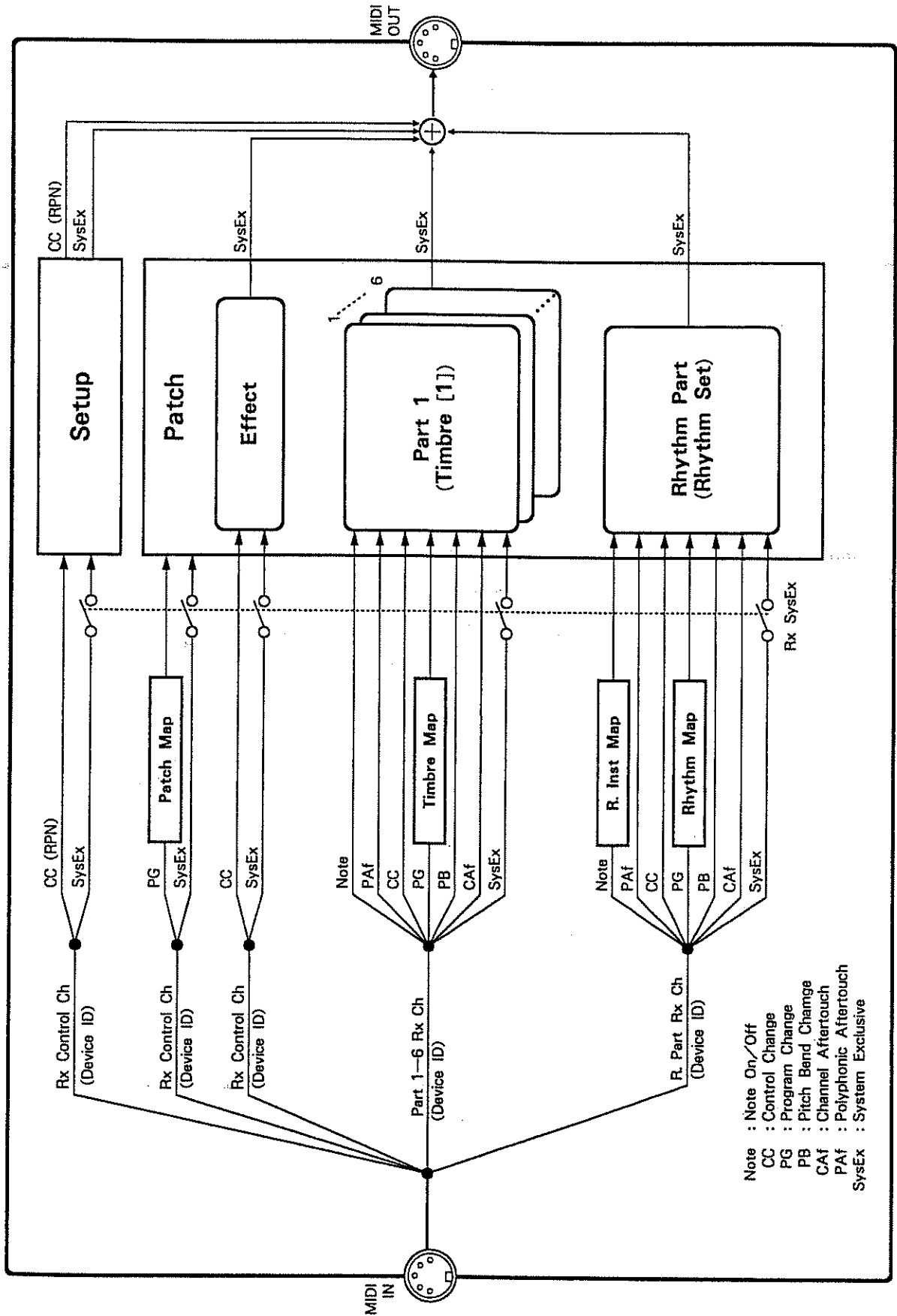

SPECIFICATIONS

U-220 : RS-PCM sound module

【Sound generator】

RS-PCM type



Maximum simultaneous notes: 30 notes



Output impedance: 1.2 k Ω

【Front panel】

VOLUME knob

PART/INST buttons ( )

CURSOR buttons ( )

VALUE button ( )

EXIT button

ENTER button

EDIT/REVERB button

DATA/CHORUS button

JUMP button

MARK button

PCM CARD slot \times 2

PHONES jack

POWER switch

【Display】

24 character 2 line LCD (with backlight)

【Indicator】

MIDI MESSAGE indicator

【Rear panel】

MIDI connectors (IN, OUT, THRU)

Output terminals (MIX OUT L/R, DIRECT OUT 1 L/R,

DIRECT OUT 2 L/R)

FIXED/VARIABLE switch

【Dimensions】

482 (W) \times 358 (D) \times 45 (H) mm

19" \times 14-1/8" \times 1-3/4"

EIA — 1 U rack mount type

【Weight】

4.4 kg/9 lb 11oz

【Power consumption】

20 W (117/220/240V)

【Included items】

Audio cable (2.5m) \times 1

MIDI cable (1m) \times 1

Owner's manual

Factory Settings

【Optional items】

Sound library SN-U110 series

Stereo headphone RH-100

Audio cable PJ-1M

MIDI/SYNC cable MSC-07/15/25/50/100

* The included MIDI cable is for MIDI only. It cannot be used for DIN SYNC or audio.

* Specifications and appearance are subject to change without notice for product improvement.

INDEX

[A]

Auto Bend
 Timbre/Pitch69
 Rhythm Inst/Pitch77

[B]

Bender Range
 Timbre/Pitch68
 Rhythm Set/Pitch72
Boost63
Bulk Dump
 Setup91
 Temp92
 Memory92

[C]

Ch After Sens
 Timbre/Pitch67
 /Vibrato68
 /Level71
 Rhythm Inst/Pitch76
Chorus54
Chorus Level55
Chorus Type54
Copy
 Patch83
 Timbre85
 Rhythm Set87
Copy+Ren
 Timbre85
 Rhythm Set87
Ctrl56

[D]

Delay Feedback56
Delay Time
 Chorus55
 Timbre/Vibrato70
Depth
 Chorus55
 Timbre/Vibrato70
Detune Depth
 Timbre/Pitch69
 Rhythm Inst/Pitch78
Device ID48

[E]

Edit
 Setup45
 Patch53
 Timbre64
 Rhythm Set71
Edit Mode45
Effect54
Env
 Timbre67
 Rhythm Inst72
Exchange
 Patch83
 Timbre85
 Rhythm Set87

[F]

Feedback55

[I]

Initialize
 Setup95
 Temp96
 Jump Page96

[J]

Jump37

[K]

Key Range59

[L]

Level
 Timbre66
 Rhythm Inst75
LCD Contrast46

[M]

MIDI17
MIDI Monitor97
Mark37
Master Tune46
Modulation Depth71

[O]

Output Assign
 1 - 6Part61
 Rhythm Inst78
Output mode54

[P]

Pan
 1 - 6Part62
 Rhythm Inst78
Parameter Dump45
Part24
Part Copy83
Part Level
 1 - 6Part62
 Rhythm Part63
Patch24
Patch Map50
Patch Name53
PCM Card66
Pitch Randomize77
Pitch Shift
 Timbre/Pitch68
 Rhythm Inst/Pitch76
Poly After Sens
 Timbre/Pitch69
 /Vibrato71
 Rhythm Inst/Pitch77

[R]

R.Inst Map51
ROM Play97
Rate
 Chorus55
 Timbre/Vibrato70
Reverb56
Reverb Level56
Reverb Time56
Reverb Type56
Rhythm Inst73
Rhythm Map51
Rhythm Setup24
Rise Time70
Rx Ch
 1 - 6Part59
 R.Part63
Rx Control Ch46

Rx Hold
 1 - 6Part61
 R.Part64
Rx Pan60
Rx Patch Change47
Rx Rhythm Change47
Rx Rhythm Inst Assign48
Rx Sys Ex48
Rx Timbre Change47
Rx Volume
 1 - 6Part60
 R.Part63

[S]

Setup45
Source Number74

[T]

Timbre24
Timbre Map51
Timbre Name65
Tone24

[V]

Velo Sens
 Timbre/Level66
 Rhythm Inst/Level75
Velo Thresh60
Voice Reserve
 1 - 6Part58
 R.Part63

[W]

Waveform70
Write
 Patch82
 Timbre84
 Rhythm Set86
Write+Ren
 Timbre85
 Rhythm Set87

MEMO

MEMO

For Nordic Countries

Apparatus containing Lithium batteries

ADVARSEL!

Lithiumbatteri. Eksplosionsfare.
Udskiftning må kun foretages af en sagkyndig,
og som beskrevet i servicemanual.

VARNING!

Lithiumbatteri. Explosionsrisk.
Får endast bytas av behörig servicetekniker.
Se instruktioner i servicemanualen.

ADVARSEL!

Lithiumbatteri. Fare for eksplosion.
Må bare skiftes af kvalificeret tekniker som
beskrevet i servicemanualen.

VAROITUS!

Lithiumparisto. Räjädysvaara.
Pariston saa vaihtaa ainoastaan
alan ammottimies.

For West Germany

Bescheinigung des Herstellers/Importeurs

Hiermit wird bescheinigt, daß der/die/das
RS-PCM SOUND MODULE U-220
(Gerät. Typ. Bezeichnung)

in Übereinstimmung mit den Bestimmungen der
Amtsbl. Vfg 1046/1984
(Amtsblattverfügung)

funk-erstört ist.

Der Deutschen Bundespost wurde das Inverkehrbringen dieses Gerätes angezeigt und die Berechtigung zur Überprüfung der Serie auf Einhaltung der Bestimmungen eingeräumt.

Roland Corporation Osaka/Japan

Name des Herstellers/Importeurs

For the USA

RADIO AND TELEVISION INTERFERENCE

WARNING — This equipment has been verified to comply with the limits for a Class B computing device, pursuant to Subpart J, of Part 15, of FCC rules. Operation with non-certified or non-verified equipment is likely to result in interference to radio and TV reception.

The equipment described in this manual generates and uses radio frequency energy. If it is not installed and used properly, that is, in strict accordance with our instructions, it may cause interference with radio and television reception. This equipment has been tested and found to comply with the limits for a Class B computing device in accordance with the specifications in Subpart J, of Part 15, of FCC Rules. These rules are designed to provide reasonable protection against such interference in a residential installation. However, there is no guarantee that the interference will not occur in a particular installation. If this equipment does cause interference to radio or television reception, which can be determined by turning the equipment on and off, the user is encouraged to try to correct the interference by the following measure:

- Disconnect other devices and their input/output cables one at a time. If the interference stops, it is caused by either the other device or its I/O cable.
 - These devices usually require Roland designated shielded I/O cables. For Roland devices, you can obtain the proper shielded cable from your dealer. For non Roland devices, contact the manufacturer or dealer for assistance.
- If your equipment does cause interference to radio or television reception, you can try to correct the interference by using one or more of the following measures:
- Turn the TV or radio antenna until the interference stops.
 - Move the equipment to one side or the other of the TV or radio.
 - Move the equipment farther away from the TV or radio.
 - Plug the equipment into an outlet that is on a different circuit than the TV or radio. (That is, make certain the equipment and the radio or television set are on circuits controlled by different circuit breakers or fuses.)
 - Consider installing a rooftop television antenna with coaxial cable lead-in between the antenna and TV. If necessary, you should consult your dealer or an experienced radio/television technician for additional suggestions. You may find helpful the following booklet prepared by the Federal Communications Commission: "How to Identify and Resolve Radio — TV Interference Problems"

This booklet is available from the U.S. Government Printing Office, Washington, D.C., 20402, Stock No. 004-000-00345-4.

For Canada

CLASS B

NOTICE

This digital apparatus does not exceed the Class B limits for radio noise emissions set out in the Radio Interference Regulations of the Canadian Department of Communications.

CLASSE B

AVIS

Cet appareil numérique ne dépasse pas les limites de la classe B au niveau des émissions de bruits radioélectriques fixés dans le Règlement des signaux parasites par le ministère canadien des Communications.

Roland®

10490

UPC 10490



10490

Roland®