

RE-MANUAL 2005

CASIO

DIGITAL SAMPLING RHYTHM

RZ-1

SAMPLING
LEVEL

VOLUME

RZ-1

DIGITAL SAMPLING RHYTHM COMPOSER

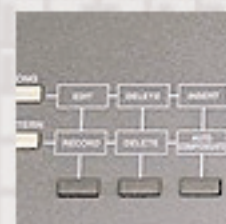

0.0 sec



CASIO.
RETRO SYNTHETICS

CASIO RZ-1 Sounds

These are the original RZ-1-Sounds from the RZ-1 Tape Collection (released ~'86). 91 „Samples“ on a C-15 double sided **Audio** Cassette Tape. Each side containing really punchy Kicks, Snares a la Roland 808/909, Simmons, LinnDrum and a lot of other Vintage Drum-Machines. Each Sound is introduced by a Japanese in english. Very Funny! I made a CD-R with Cover from the **original Tape in 1:1**, sampled with 16 Bit, 44,1 khz. No denoising or fx were used to keep the „flair“. If you want it, mail me. I'll upload some MP3-Demos on my site later. cosmo@cosmosynthesizer.de



LADO A

No.	NOMBRE DEL INSTRUMENTO	TIPO	NUMERO DE BANCOS
1	BASS DRUM	A	1
2	BASS DRUM	B	1
3	BASS DRUM	C	1
4	BASS DRUM	D	1
5	SNARE DRUM	A	1
6	SNARE DRUM	B	1
7	SNARE DRUM	C	1
8	SNARE DRUM	D	1
9	SNARE DRUM	DOUBLE	1
10	SNARE DRUM	OPEN RIM	1
11	GATED SNARE DRUM	A	2
12	GATED SNARE DRUM	B	2
13	GATED SNARE DRUM	C	4
14	SNARE DRUM	CLOSED RIM A	1
15	SNARE DRUM	CLOSED RIM B	1
16	SNARE DRUM	STICK RIM	1
17	TOM 1	A	1
18	TOM 1	B	2
19	TOM 2	A	2
20	TOM 2	B	2
21	TOM 3	A	2
22	TOM 3	B	2
23	TOM 4	A	2
24	TOM 4	B	2
25	CLOSED HIHAT	A	1
26	CLOSED HIHAT	B	1
27	CLOSED HIHAT	C	1
28	CLOSED HIHAT	D	1
29	OPEN HIHAT	A	2
30	OPEN HIHAT	B	2
31	OPEN HIHAT	C	2
32	PEDAL HIHAT	A	1
33	PEDAL HIHAT	B	1
34	PEDAL HIHAT	C	1
35	RIDE CYMBAL	A	4
36	RIDE CYMBAL	B	4
37	CRASH CYMBAL	A	4
38	CRASH CYMBAL	B	4
39	CYMBAL CUP SHOT	A	4
40	CYMBAL CUP SHOT	B	4
41	CHINESE CYMBAL		4
42	HAND CLAPS	A	1
43	HAND CLAPS	B	1
44	HAND CLAPS	C	1
45	FINGER SNAP	A	1
46	FINGER SNAP	B	1

LADO B

No.	NOMBRE DEL INSTRUMENTO	TIPO	NUMERO DE BANCOS
47	HIGH CONGA	CLOSED	1
48	HIGH CONGA	OPEN A	1
49	HIGH CONGA	OPEN B	1
50	LOW CONGA		2
51	HIGH BONGO	CLOSED	1
52	HIGH BONGO	OPEN	1
53	LOW BONGO		1
54	AGOGO	LOW	1
55	AGOGO	MIDDLE	1
56	AGOGO	HIGH	1
57	CABASA		1
58	SHAKER	A	1
59	SHAKER	B	1
60	GUIRO	LONG	2
61	GUIRO	SHORT	1
62	GUIRO	PATTERN	2
63	CUICA	LOW	1
64	CUICA	HIGH	1
65	COWBELL	HIGH	1
66	COWBELL	MIDDLE	1
67	COWBELL	LOW	1
68	WOOD BLOCK	HIGH	1
69	WOOD BLOCK	MIDDLE	1
70	WOOD BLOCK	LOW	1
71	TAMBOURINE	A	1
72	TAMBOURINE	B	2
73	WIND CHIMES	A	4
74	WIND CHIMES	B	4
75	SAMBA WHISTLE	LOW	1
76	SAMBA WHISTLE	MIDDLE	1
77	SAMBA WHISTLE	HIGH	1
78	CASTANET	A	1
79	CASTANET	B	1
80	BELLS		2
81	HIGH TIMBAL	OPEN	2
82	HIGH TIMBAL	OPEN RIM	2
83	LOW TIMBAL	OPEN	2
84	LOW TIMBAL	OPEN RIM	1
85	ELECTRONIC BASS	A	1
86	ELECTRONIC BASS	B	1
87	ELECTRONIC SNARE	A	1
88	ELECTRONIC SNARE	B	1
89	ELECTRONIC TOM 1		2
90	ELECTRONIC TOM 2		2
91	ELECTRONIC TOM 3		2

* La duración de algunas de las muestras que requieren 4 bancos en realidad es mayor que el tiempo de muestreo de 0,8 segundos.

FEATURES

- Four banks are available for storage of up to 0.2 seconds each of sounds sampled using either line or microphone input. Linking banks together also makes it possible to store sounds of either 0.4 seconds or 0.8 seconds duration.
- Pattern programming can be performed using either the 4 sampled sounds or 12 realistic preset tones of outstanding quality.
- Besides a wide variety of sound variations to work with, accent and mute effects can be applied individually to any one of the 16 tones available. This allows playback of drum effects with delicate modulation adjustments.
- Both real-time writing and step writing of notes are available, and both methods can be mixed freely within a single selection. This means that patterns can be programmed individually and then linked together into a single song.
- Pattern programming allows the time and number of measures to be specified to make any type of rhythm possible.
- The minimum note value settable is 1/96, and an auto compensate function automatically makes adjustments for mistiming during real-time writing.
- A wide variety of editing functions including copy, chain, delete, and insert aid in the creation of original compositions.
- MIDI terminals (IN/OUT/THRU) make it possible to connect to synthesizers, sequencers, personal computers, or any other MIDI device for easy system expansion or upgrading.
- Recording of compositions is aided by 10-channel parallel output and stereo output terminals.

CARE OF YOUR UNIT

- 1. Avoid heat, humidity, and direct sunlight.**
Do not overexpose the unit to direct sunlight, place it near a heater, or in any area subject to high temperature.
- 2. Severe impacts can result in malfunction.**
When carrying or transporting the unit, protect it by packing with soft cloth.
- 3. Keep the unit free of liquids, dust, particles, etc.**
Do not allow foreign matter to enter at the keys or controls. Be especially careful of metallic objects such as hairpins, sewing needles, or coins. Also, do not allow the unit to get wet.
- 4. Never attempt to modify any part of the unit.**
Your unit is a precision musical instrument made up of sophisticated electronic parts. Any modification of, or tampering with internal components can cause trouble or malfunction.
- 5. Do not use lacquer thinner or similar chemicals for cleaning.**
Clean with a soft cloth dampened with a mild detergent. Soak the cloth in the detergent solution and squeeze it until almost dry.

CONTENTS

1 GENERAL GUIDE	
1-1 Function Outline	4
1-2 Control Panel	5
1-3 Rear Panel	8
2 PATTERN PROGRAMMING	
2-1 Real-time Recording	10
2-2 Step Recording	12
2-3 Auto Compensate/Swing Function	15
2-4 Delete	17
2-5 Copy	18
2-6 Pattern Playback	19
3 SONG EDIT	
3-1 Song Edit	20
3-2 Delete	21
3-3 Insert	21
3-4 Chain	22
3-5 Copy	23
3-6 Song Playback	23
4 SAMPLING	
4-1 Sampling Mode	25
4-2 Sampling Bank Linking	25
4-3 Accessory Cassette	26
5 MT FUNCTION	
5-1 Connection with a Tape Recorder	28
5-2 Data SAVE/VERIFY	29
5-3 Data LOAD	31
6 MIDI	
6-1 Transmit/Receive Data	32
6-2 MIDI Channel Settings	32
6-3 Clock Setting	32
APPENDICES	
A-1 Memory Back Up	34
A-2 Specifications	34
RZ-1 PATTERN SAMPLES	73
PATTERN DIAGRAM	104
MIDI Implementation Chart	105

1 GENERAL GUIDE

1-1 Function outline

The functions of the RZ-1 can be generally divided among the seven modes (function groups) described below.

1 PATTERN PLAY mode

Used to play back rhythm patterns which have been written. Playback can be performed in real-time using the 12 INSTRUMENT keys and the 4 SAMPLE keys.

- One hundred rhythm patterns can be stored, and each pattern is assigned a number from 00 through 99. The number of the selected rhythm pattern is indicated on the display of the unit.

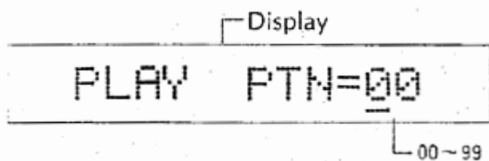

2 SONG PLAY mode

Used to play back songs created by editing patterns. Playback can be performed in real-time using the 12 INSTRUMENT keys and the 4 SAMPLE keys.

- Twenty songs can be stored, and each song is assigned a number from 01 through 20. The number of the selected song is indicated on the display of the unit.

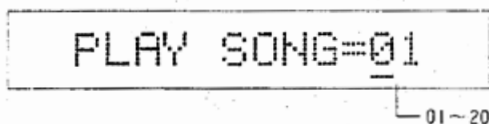

3 PATTERN RECORD mode

Used to create partial rhythm patterns after specifying the time and number of measures. Two different types of writing methods are possible: REAL TIME RECORD in which notes are written in real-time and STEP RECORD in which notes and rests are written one step at a time.

- First, a pattern number is selected in the PATTERN PLAY mode, and then the PATTERN RECORD mode is set to enter PATTERN RECORD stand by for the selected pattern number. (Fig. 1) Pressing the START/STOP key allows REAL TIME RECORD writing, while pressing the VALUE ▲ key allows STEP RECORD writing. (Fig. 2)

Fig. 1

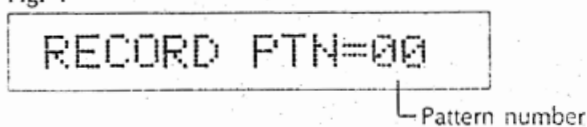
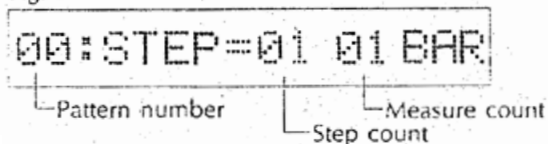

Fig. 2



4 SONG EDIT mode

Used to create rhythms for entire songs by combining various patterns.

- A song can be created using a maximum of 99 pattern steps.
- First, a song number is selected in the SONG PLAY mode, and then the SONG EDIT mode is set. Input of pattern numbers is performed in order for each step.

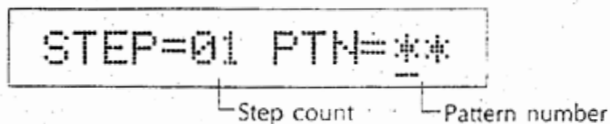

5 SAMPLING mode

Used to input sampled sounds into one of four banks (SAMPLE 1 ~ 4).

- The bank into which the sampled sound will be input is indicated on the display during SAMPLING stand by. The SAMPLING mode is automatically canceled when a sound is input.

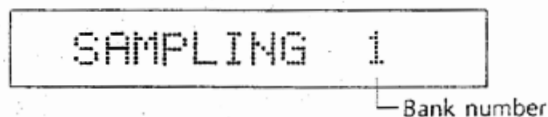

6 MT mode

Used to transmit pattern, song, and sampled sound data from the MT terminal to a cassette tape recorder.

- This mode is made up of the three following functions, one of which will be indicated on the display:
SAVE: Saving data from the RZ-1 to tape
LOAD: Loading data from tape to the RZ-1
VERIFY: Verifying that data from the RZ-1 has been correctly recorded on tape

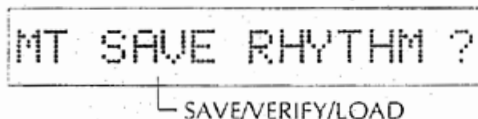

7 MIDI mode

Used for such MIDI settings as MIDI channel, clock, etc.

- Fig. 3 shows the display for MIDI channel settings, while Fig. 4 shows the display MIDI clock settings.

Fig. 3

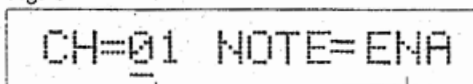
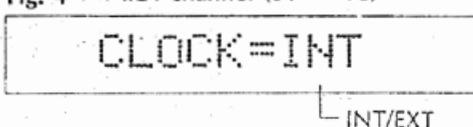
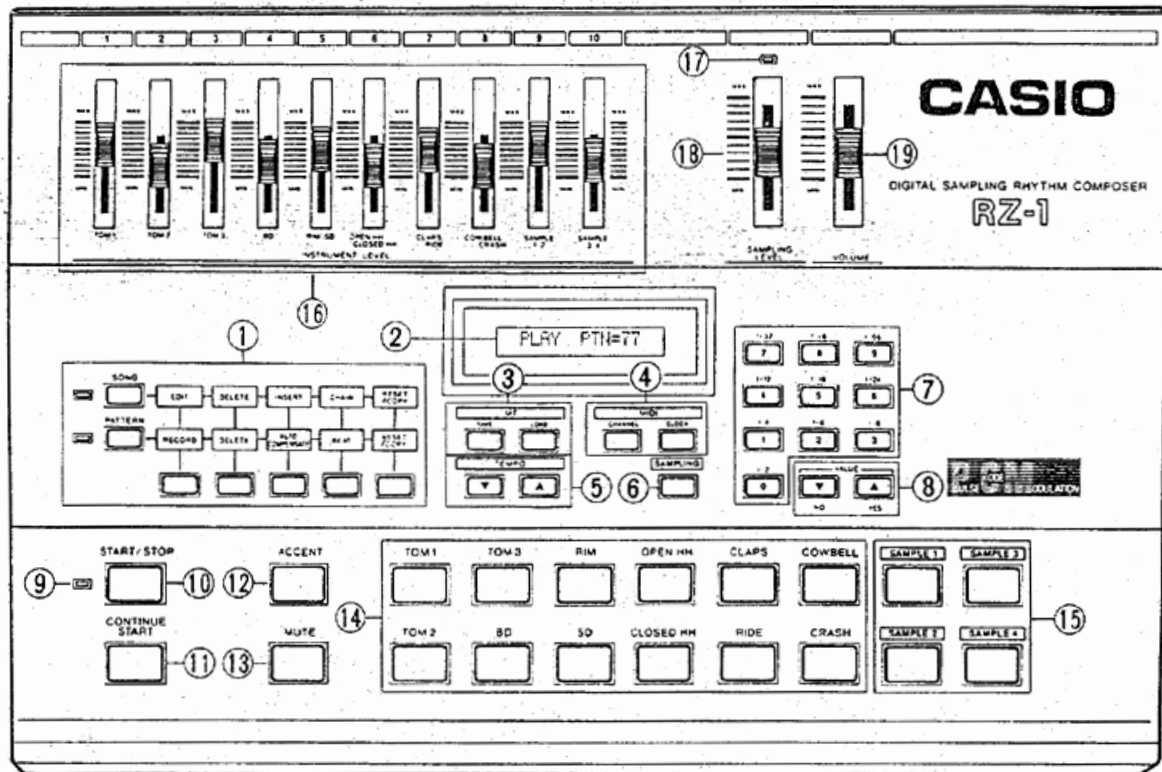

Fig. 4 MIDI channel (01 ~ 16) ENA/DIS



1-2 CONTROL PANEL

Fig. 1 CONTROL PANEL



① Parameter controls

Ten parameters are available for programming patterns and editing songs. The SONG key and PATTERN key are used in combination with five selectors to set the desired parameters. (Fig. 2)

Fig. 2 PARAMETER CONTROLS

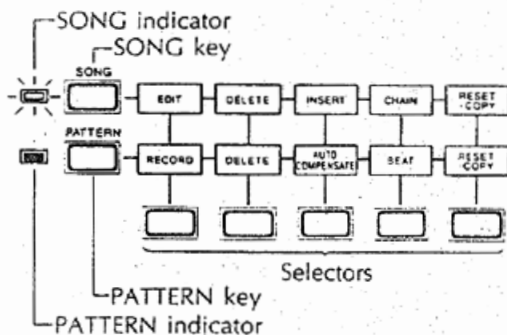

- **PATTERN key**
Used to set either the PATTERN PLAY mode or PATTERN RECORD mode. The PATTERN indicator lights when this key is in the ON setting.
- **PATTERN indicator**
Lights green to indicate the PATTERN PLAY mode and red to indicate the PATTERN RECORD mode.

- **SONG key**
Used to set either the SONG PLAY mode or SONG EDIT mode. The SONG indicator lights when this key is in the ON setting.
- **SONG indicator**
Lights green to indicate the SONG PLAY mode and red to indicate the SONG EDIT mode.
- **Parameters**

RECORD (PATTERN RECORD)

Used to program a pattern by writing notes. Pressing while in the PATTERN PLAY mode changes the color of the PATTERN indicator to red indicating the PATTERN RECORD mode. Pressing while in the PATTERN RECORD mode returns to the PATTERN PLAY mode.

DELETE (PATTERN DELETE)

Used to delete all of the notes written for a single pattern or the notes for a specific sound source. Pressing while in the PATTERN PLAY mode or PATTERN RECORD mode will erase all of the notes for the selected pattern. Pressing an INSTRUMENT key or SAMPLE key while holding down this selector will erase the notes for the INSTRUMENT or SAMPLE key pressed only.

AUTO COMPENSATE

Used in the PATTERN RECORD mode in combination with the ten-key pad to input numeric values to set the minimum value of written notes. Timing misses during REAL TIME RECORD note writing are then automatically corrected according to this preset value. Timing for notes on even beats of  can also be set to one of six steps using the swing function.

BEAT (BEAT/BAR)

Used in the PATTERN RECORD mode in combination with the ten-key pad to input numeric values to make BEAT and BAR settings.

RESET/COPY (PATTERN COPY)

Used in the PATTERN PLAY mode to copy the note data from the currently selected pattern number to another pattern. Pressing during STEP RECORD resets the step count to STEP 1.

EDIT (SONG EDIT)

Used for song editing where patterns are combined to create a song. Pressing while in the SONG PLAY mode changes the color of the SONG indicator to red indicating the SONG EDIT mode. Pressing while in the SONG EDIT mode returns to the SONG PLAY mode.

DELETE (SONG DELETE)

Used to delete all of the patterns written for a single song or the pattern for a specific step. Pressing while in the SONG PLAY mode erases all of the patterns for the selected song. Pressing while in the SONG EDIT mode erases the pattern for a specific step only.

INSERT

Used to insert a new pattern between two data items of a previously written song.

CHAIN (SONG CHAIN)

Used to chain songs together. Pressing after the first song to be played back is recalled in the SONG PLAY mode allows specification of the next song using the ten-key pad.

RESET/COPY (SONG COPY)

Used in the SONG PLAY mode to copy the data of the currently selected song to another song number. Pressing while in the SONG EDIT mode resets the step count to STEP 1.

② Liquid Crystal Display (LCD)

A 16-character LCD shows the current status of the unit, including such information as the current pattern number, song number, parameter, and function, as well as data.

③ MT (SAVE key/LOAD key)

Used to send (SAVE) data to and retrieve (LOAD) data from a cassette tape through the MT terminal.

<SAVE/LOAD DATA>

- RHYTHM:**
- PATTERN data
 - SONG data (including CHAIN)
 - TEMPO values
 - MIDI channel numbers and NOTE = ENA/DIS data
 - PATTERN/SONG numbers selected for SAVE values and PATTERN key/SONG key ON/OFF status
- SAMPLE:**
- Sample sound (SAMPLE 1 ~ 4) data

④ MIDI (CHANNEL key/CLOCK key)

Used to set the transmit/receive channel and MIDI clock status when connecting with another MIDI device through the MIDI terminals.



• CHANNEL key

Used to set any channel from CH1 through CH16 as a MIDI transmit/receive channel. Channel numbers are input using the ten-key pad. The VALUE key is used to switch between NOTE = ENABLE/DISABLE (note data can/cannot be transmitted/received).

• CLOCK key

Used to set the clock synchronizing signal to either the internal clock (CLOCK = INTERNAL) or an external MIDI clock (CLOCK = EXTERNAL) as the synchronizing signal. The VALUE key is used to switch between the two settings.

⑤ TEMPO (key/ key)

Tempo can be adjusted within the range of $J = 40 \sim 250$. Each press of the  key decreases the numeric value representing tempo by one, while pressing the  key increases the value by one. Holding either key down changes the value at high speed.

⑥ SAMPLING key

Used to set the SAMPLING mode. Pressing one of the SAMPLE keys (1 ~ 4) while this key is depressed enters SAMPLING stand by. Sampling is performed automatically at this point if a sound is input through MIC or LINE IN, and the sampled sound is stored in the bank specified by the SAMPLE number. Sampling is possible to individual banks, or longer samples can be recorded in banks 1 and 2, 3 and 4, or 1 through 4.

7 Ten-key pad

Used to input numeric values for setting pattern numbers, song numbers, AUTO COMPENSATE, BEAT, BAR, COPY, and MIDI channels.

8 VALUE (▾ key/ ▴ key)

Used to raise and lower numeric values within preset ranges for the pattern number and song number, as well as the step count for STEP RECORD and SONG EDIT. Each press of the ▾ key decreases the numeric value by one; while pressing the ▴ key increases the value by one. Also used for NO (cancel)/YES (execute) settings to avoid misoperation during DELETE, CHAIN, COPY, and MT (SAVE/LOAD) operations.

9 START/STOP indicator

Lights during pattern playback, song playback, and REAL TIME RECORD writing.

10 START/STOP key

Used to start and stop pattern playback, song playback, and REAL TIME RECORD writing.

11 CONTINUE START key

Resumes pattern playback and song playback from the point at which they were suspended.

12 ACCENT key

Used to specify an accent for notes being written. Pressing an INSTRUMENT key or SAMPLE key (1 ~ 4) while this key is depressed during pattern programming accents the note and stores it in memory. This key can also be used to accent notes during real-time play.

13 MUTE key

Used to specify a mute for notes being written. Pressing an INSTRUMENT key or SAMPLE key (1 ~ 4) while this key is depressed during pattern programming mutes the note and stores it in memory. This key can also be used to mute notes during real-time play.

14 INSTRUMENT keys

Used during pattern programming to write notes and during real-time play to produce sounds from the various sound sources available. Also used for real-time play in combination with playback of previously written patterns or songs.

<INSTRUMENT key outline>

- TOM 1 High tom-tom
- TOM 2 Middle tom-tom
- TOM 3 Low tom-tom
- BD Bass drum
- RIM Rim shot
- SD Snare drum
- OPEN HH Open hi hat
- CLOSED HH Closed hi hat

- CLAPS Hand clap
- RIDE Ride cymbal
- COWBELL Cowbell
- CRASH Crash cymbal

NOTE: Notes cannot exist simultaneously for the following pairs of instruments:

TOM 1/TOM 2	OPEN HH/CLOSED HH
TOM 3/BD	CLAPS/RIDE
RIM/SD	COWBELL/CRASH

Notice that the controls for these pairs are located together (i.e. TOM 1 is above TOM 2, etc.). When these combinations are input at the same note, the latest input note takes priority.

15 SAMPLE keys (1 ~ 4)

Used to select among areas 1 through 4 for storage of a sampled sound. Also used in an identical manner as the INSTRUMENT keys to write notes during pattern programming and to produce sounds during real-time play to produce sounds from the sampled sound sources stored in banks 1 through 4. Real-time play in combination with playback of previously written patterns or songs can also be performed.

NOTE: SAMPLE 1 cannot be produced simultaneously with SAMPLE 2, and SAMPLE 3 cannot be produced simultaneously with SAMPLE 4. The sample written last is given priority when these combinations are written into a pattern for a single note.

16 INSTRUMENT LEVEL

Used to adjust the balance among the INSTRUMENT and SAMPLE keys as noted below.

1 TOM 1	6 OPEN HH/CLOSED HH
2 TOM 2	7 CLAPS/RIDE
3 TOM 3	8 COWBELL/CRASH
4 BD	9 SAMPLE 1, 2
5 RIM/SD	10 SAMPLE 3, 4

NOTE: INSTRUMENT LEVEL controls 5 ~ 10 are assigned two sound sources each.

17 SAMPLING INDICATOR

Lights red in the SAMPLING mode when a sound is input from an external source to indicate that sampling is being performed, and goes out when sampling is complete.

18 SAMPLING LEVEL

Used to adjust the sampling level (volume) when a sound is being input through MIC or LINE IN.

19 VOLUME

Used to control the overall output volume, including STEREO OUT (L/R) and HEADPHONE volume.

* Does not control volumes of LINE OUT 1 through 10.

1-3 Rear Panel

Fig. 1 REAR PANEL

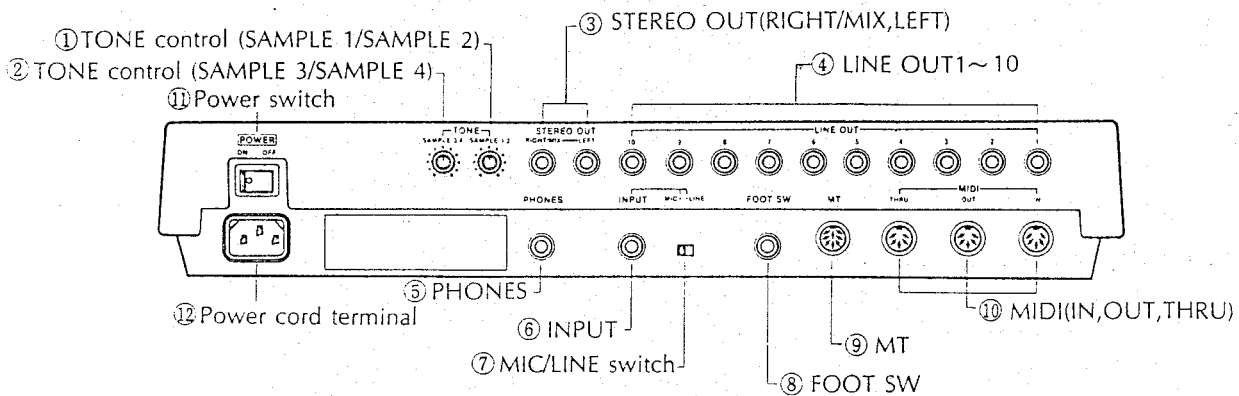

① TONE control (SAMPLE 1, 2)

Used to adjust the tone of the sampled sounds in SAMPLE 1 and 2. Rotating to the left intensifies lower tones, while turning to the right intensifies higher tones. (Fig. 2)

② TONE control (SAMPLE 3, 4)

Used to adjust the tone of the sampled sounds in SAMPLE 3 and 4. Rotating to the left intensifies lower tones, while turning to the right intensifies higher tones. (Fig. 2)

Fig. 2

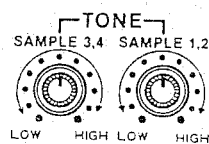

③ STEREO OUT (RIGHT/MIX, LEFT)

Stereo output terminal. Stereo output is produced in accordance with the independent settings of each sound source. The output level of each sound source is adjusted using the INSTRUMENT LEVEL controls on the control panel of the unit.

- A stereo output signal is obtained when monaural plugs are inserted into both the RIGHT and LEFT terminals, or when a stereo plug is inserted into the LEFT terminal.
- RIGHT and LEFT output is mixed and output when a monaural plug is inserted into the RIGHT terminal only.

④ LINE OUT 1 ~ 10

Line out terminal. Independent output is produced for the ten lines as noted below.

- | | |
|----------|---------------------|
| ① TOM 1 | ⑥ OPEN HH/CLOSED HH |
| ② TOM 2 | ⑦ CLAPS/RIDE |
| ③ TOM 3 | ⑧ COWBELL/CRASH |
| ④ BD | ⑨ SAMPLE 1, 2 |
| ⑤ RIM/SD | ⑩ SAMPLE 3, 4 |

Note that lines ⑤ ~ ⑩ are assigned two sound sources each. The output level for each line is adjusted by the INSTRUMENT LEVEL controls on the control panel of the unit.

- The master volume has no effect on LINE OUT 1 ~ 10.
- STEREO OUT output is impossible when a plug is inserted into LINE OUT.

⑤ PHONES

For connection of headphones which allows stereo output signal monitoring in accordance with the independent settings of each sound source.

- Output to the headphones is cut for any sound source assigned to a LINE OUT terminal into which a plug is inserted.

⑥ INPUT

Sampling input terminal. Input can be performed through a microphone or line. (Fig. 3)

⑦ MIC/LINE switch

Used to switch between line input and microphone input for sampling.

Fig. 3

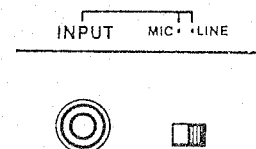

⑧ FOOT SW

For connection of a foot switch (optional SP-1) which allows foot control of pattern and song play identical to that of the START/STOP key on the control panel of the unit.

⑨ MT

For connection of a cassette tape recorder which allows pattern, sound, and sampled sound data to be saved to and loaded from cassette tape.

- The accessory MT connecting cord is used for connection of a cassette tape recorder.

⑩ MIDI (IN/OUT/THRU)

For connection of other MIDI devices or personal computers for data interchanges.

• MIDI IN

For reception of MIDI data from an external device under the control of the RZ-1.

• MIDI OUT

For transmission of MIDI data to an external device under the control of the external device.

• MIDI THRU

For reception of MIDI data and retransmission to an external device without modification.

⑪ POWER switch

Switches the power of the unit ON and OFF. Data contained in the unit are maintained by built-in memory protection batteries even when power is OFF.

⑫ Power cord terminal

For connection of the accessory AC power cord.

2 PATTERN PROGRAMMING

The RZ-1 is preprogrammed before shipment from the factory with 60 rhythm patterns (see Pattern Samples). It is suggested that these patterns be stored on cassette tape using the MT function before programming new rhythm patterns (see MT FUNCTION).

2-1 Real-time Recording

Real-time writing of rhythm patterns can be performed by playing the INSTRUMENT and SAMPLE keys while monitoring the rhythm count signal. Specific measures can also be specified for repeat playback for addition of other notes to write modified patterns.

1. Pattern number specification

Either the ten-key pad of VALUE \blacktriangle / \blacktriangledown keys can be used to change the displayed pattern number to the desired value.

- The display appears as illustrated below.

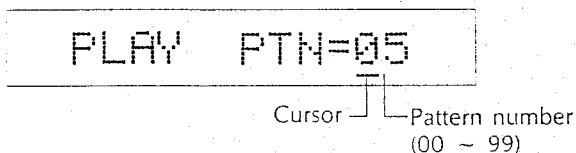

Example:

To change the pattern number to 05, either press keys \square and \square on the ten-key pad, or press the VALUE \blacktriangle / \blacktriangledown keys until the value 05 appears on the display.

2. PATTERN RECORD mode setting

Press the parameter control RECORD selector while in the PATTERN PLAY mode.

- The PATTERN indicator changes from green to red to indicate the PATTERN RECORD mode.

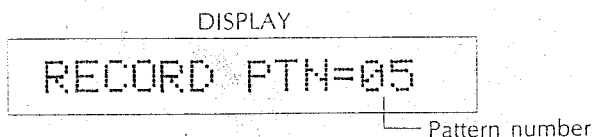
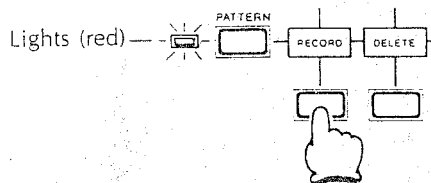

This display indicates a status known as "write stand by".

- Press the RECORD selector again to return from the PATTERN RECORD mode to the PATTERN PLAY mode.

3. Time and number of measures setting

Press the parameter control BEAT selector while in the PATTERN RECORD mode.

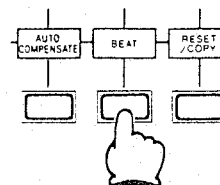

- The display should now appear as illustrated below. Use the ten-key pad and VALUE keys to input numeric values.

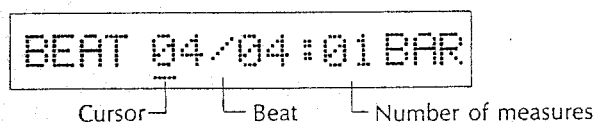

- The display above shows the initialized settings of 4/4 time and a number of measure value of 1. The VALUE \blacktriangle / \blacktriangledown keys are used to move the cursor under the value to be changed, and values are entered using the ten-key pad.

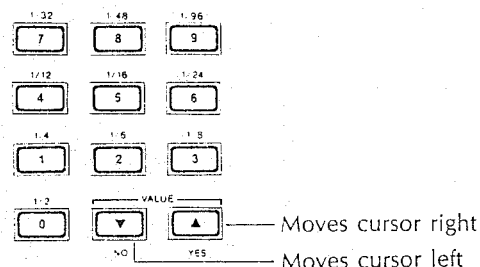

Example:

The following input should be performed to change to 3/4 time and two measures. \square \square \blacktriangle \blacktriangle \square \square

- The denominator of the time can be set at 02, 04, 08, and 16 only. These values are set by pressing the respective $\frac{1}{2}$, $\frac{1}{4}$, $\frac{1}{8}$, or $\frac{1}{16}$ key on the ten-key pad once.
- The numerator of the time as well as the number of measures can be set within a range of 01 ~ 99.
- The time and number of measures for patterns into which notes have already been written cannot be changed.

Pressing the BEAT selector again returns the display to the write stand by previously shown in 2., completing the time/number of measures setting procedure.

4. Setting minimum note values

The initial setting for the minimum note value in the PATTERN RECORD mode is 1/16 (♩). It is necessary to change this setting to input 32nd, 48th, or 96th notes.

- Press the parameter control AUTO COMPENSATE selector while in the PATTERN RECORD mode. This will cause the following display to appear.

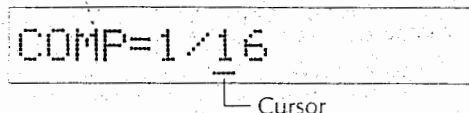

- Once a pattern is written, the above display will show COMP = 1/2, 1/4, 1/6, 1/12, or 1/24 in the PATTERN RECORD mode to indicate the actual value of the written pattern. When COMP = 1/32, 1/48, or 1/96 for the written pattern, however, the display will show COMP = 1/16.
- The numerator is fixed at 1 for minimum note values, but the denominator can be set to any one of the values marked above each of the keys in the ten-key pad by simply pressing the corresponding key.
- Pressing the AUTO COMPENSATE selector again returns the display to the write stand by previously shown in 2.

See the section titled Auto Compensate/Swing Function for further details.

5. Writing notes

Pressing the START/STOP key makes it possible to perform real-time note writing. At this time, the START/STOP indicator lights and a rhythm count sounds.

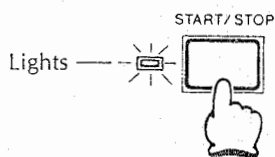

- An accent sounds on the first beat of the measure. The best method is to listen to one or two measures of the rhythm count to become accustomed to the timing and then begin to write notes.
- Notes are written by hitting the INSTRUMENT keys or SAMPLE keys in the desired timing. Notes are recorded according to the minimum note value setting input for the AUTO COMPENSATION function in 4.

- The display appears as illustrated below during writing of notes.

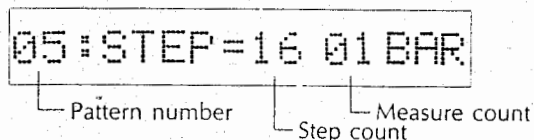

The step count advances within a range preset by the minimum note value for AUTO COMPENSATION. For COMP = 1/16, for example, the step count proceeds from 01 to 16 then returns to 01 to continue play when 16 is reached. The measure count shows which measure is being input in accordance with the number of measures preset for the BEAT function in 3. Once the preset number of measures is exceeded, the unit automatically returns to the beginning of the first measure.

- Up to eight notes can be input for a single step, but the following combinations are impossible for the same note.

TOM 1/TOM 2	CLAPS/RIDE
TOM 3/BD	COWBELL/CRASH
RIM/SD	SAMPLE 1/SAMPLE 2
OPEN HH/CLOSED HH	SAMPLE 3/SAMPLE 4

With these combinations, the latest input note takes priority over other notes.

- Accents can be applied to notes by holding down the ACCENT key while pressing the desired INSTRUMENT key or SAMPLE key. Similarly, a mute effect can be applied by holding down the MUTE key while pressing the desired INSTRUMENT key or SAMPLE key.
- When mistiming occurs during input, the timing is automatically corrected from the following measure in accordance with the value set for AUTO COMPENSATE.
- Pressing the START/STOP key completes writing procedures. Then pressing the parameter control RECORD selector cancels the PATTERN RECORD mode and returns the unit to the PATTERN PLAY mode.
- Pressing the parameter control AUTO COMPENSATE selector or BEAT selector while writing during REAL TIME RECORD cancels the writing mode. At this time the AUTO COMPENSATE value can be changed. The beat and number of measures values, however, merely appear on the display for a short period of time and then clear to the write stand by display. The beat and number of measures cannot be changed at this time. Pressing the START/STOP returns to the unit to the write status.

6. Break pattern input

A pattern which has been transferred to REAL TIME RECORD by pressing the START/STOP key once in the PATTERN RECORD mode becomes a break pattern in accordance with the specified beat and measure even if notes have not been input and is treated as a pattern for which recording is complete.

NOTES ON AUTO COMPENSATION AND BEAT

When AUTO COMPENSATE = $1/a$, and BEAT = $b/c : d$ BAR,

- $\frac{a \times b}{c} = n \leq 99$ must be true (n: integer)
- In the case of $\frac{a \times b}{c} \times d$, memory capacity is exceeded and input becomes impossible. When AUTO COMPENSATE and BEAT settings which exceed memory capacity are performed, the following display appears to indicate that the pattern memory is full.

PTN MEMORY FULL

At this time, the parameter control RECORD selector should be pressed to cancel the PATTERN RECORD mode, or the AUTO COMPENSATE/BEAT setting which caused memory capacity to be exceeded should be changed.

MEMORY CAPACITY CONFIRMATION

Pressing the PATTERN key while in the PATTERN PLAY mode will cause the percentage of pattern memory area used to appear on the display.

PTN 77% USED

23% of memory remains

2-2 Step Recording

Rhythm patterns are created using step recording by pressing INSTRUMENT keys and/or SAMPLE keys once for each note to be input at each step.

1. Pattern number specification

Either the ten-key pad of VALUE \blacktriangle \blacktriangledown keys can be used to change the displayed pattern number to the desired value.

- The display appears as illustrated below.

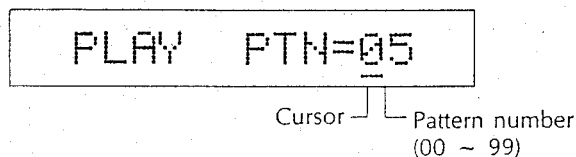

Example:

To change the pattern number to 05, either press keys [0] and [5] on the ten-key pad, or press the VALUE \blacktriangle \blacktriangledown keys until the value 05 appears on the display.

2. PATTERN RECORD mode setting

Press the parameter control RECORD selector while in the PATTERN PLAY mode.

- The PATTERN indicator will change from green to red to indicate the PATTERN RECORD mode.

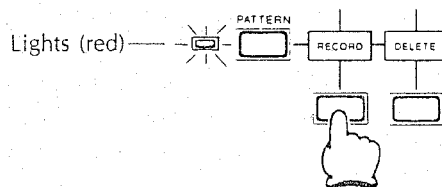

DISPLAY

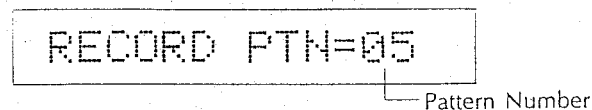

This display indicates a status known as "write stand by".

- Press the RECORD selector again to return from the PATTERN RECORD mode to the PATTERN PLAY mode.

3. Time and number of measures setting

Press the parameter control BEAT selector while in the PATTERN RECORD mode.

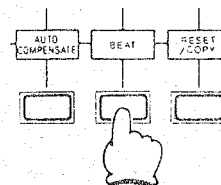

- The display should now appear as illustrated below. Use the ten-key pad and VALUE keys to input numeric values.

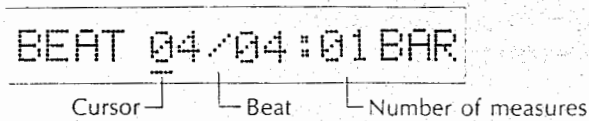

- The display above shows the initialized settings of 4/4 time and a number of measure value of 1. The VALUE \blacktriangle / \blacktriangledown keys are used to move the cursor under the value to be changed, and values are entered using the ten-key pad.

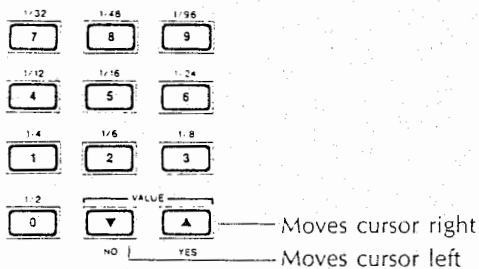

Example:

The following input should be performed to change to 3/4 time and two measures. $\square\square\blacktriangle\blacktriangle\square\square$

- The denominator of the time can be set at 02, 04, 08, and 16 only. These values are set by pressing the respective $\frac{1}{2}$, $\frac{1}{4}$, $\frac{1}{8}$, or $\frac{1}{16}$ key on the ten-key pad once.
- The numerator of the time as well as the number of measures can be set within a range of 01 ~ 99.
- The time and number of measures for patterns into which notes have already been written cannot be changed.

Pressing the BEAT selector again returns the display to the write stand by previously shown in 2., completing the time/number of measures setting procedure.

4. Setting minimum note values

The initial setting for the minimum note value in the PATTERN RECORD mode is 1/16 (♩). It is necessary to change this setting to input 32nd, 48th, or 96th notes.

- Press the parameter control AUTO COMPENSATE selector while in the PATTERN RECORD mode. This will cause the following display to appear.

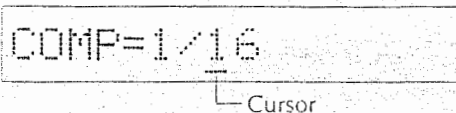

- Once a pattern has already been written, the above display will show COMP = 1/2, 1/4, 1/6, 1/12, or 1/24 in the PATTERN RECORD mode to indicate the actual value of the written pattern. When COMP = 1/32, 1/48, or 1/96 for the written pattern, however, the display will show COMP = 1/16.
- The numerator is fixed at 1 for minimum note values, but the denominator can be set to any one of the values marked above each of the keys in the ten-key pad by simply pressing the corresponding key.
- Pressing the AUTO COMPENSATE selector again returns the display to the write stand by previously shown in 2.

See the section titled Auto Compensate/Swing Function for further details.

5. Writing notes

Pressing the VALUE \blacktriangle key enters STEP RECORD and notes can be written from step 1. At this time the display will appear as illustrated below.

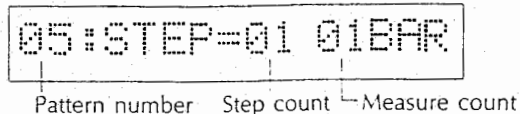

- Each press of the VALUE \blacktriangle key advances to the next step, and the length of each note is equivalent to the setting made using AUTO COMPENSATE. Pressing the VALUE \blacktriangledown key returns to the preceding step.
- Once the step in which notes are to be input is displayed using the VALUE keys, the INSTRUMENT keys, and SAMPLE keys are used to write the notes into the pattern.
- Rests are input by pressing the VALUE \blacktriangle key without pressing the INSTRUMENT keys or SAMPLE keys.
- Once the final step (determined by the AUTO COMPENSATE setting) is reached, the next press of the VALUE \blacktriangle key returns the step count to 01. When the AUTO COMPENSATE setting equals 1/16, for example, the step count will return to 01 if the VALUE \blacktriangledown is pressed at step 16.
- Moving to a step in which notes are already written causes the previously written notes to be played.
- The measure number is also displayed up to the number of measures set using the BEAT selector in 3. The unit automatically returns to the first measure when the preset number of measures is exceeded.

- Up to eight notes can be input for a single step, but the following combinations are impossible for the same note.

TOM 1/TOM 2	CLAPS/RIDE
TOM 3/BD	COWBELL/CRASH
RIM/SD	SAMPLE 1/SAMPLE 2
OPEN HH/CLOSED HH	SAMPLE 3/SAMPLE 4

With these combinations, the latest input note takes priority over other notes.

- Accents can be applied to notes by holding down the ACCENT key while pressing the desired INSTRUMENT key or SAMPLE key. Similarly, a mute effect can be applied by holding down the MUTE key while pressing the desired INSTRUMENT key or SAMPLE key.
- Press the RECORD selector again to return from the PATTERN RECORD mode to the PATTERN PLAY mode.
- Pressing the parameter control RESET/COPY selector during writing operations returns to the write stand by display of 2. without canceling the PATTERN RECORD mode.
- Pressing the parameter control AUTO COMPENSATE selector or BEAT selector while writing during REAL TIME RECORD will cancel the writing mode. At this time the AUTO COMPENSATE value can be changed. The beat and number of measures values, however, will merely appear on the display for a short period of time and then clear to the write stand by display. The beat and number of measures cannot be changed at this time. Pressing the START/STOP returns to the unit to the write status.

STEP RECORD WRITING EXAMPLE

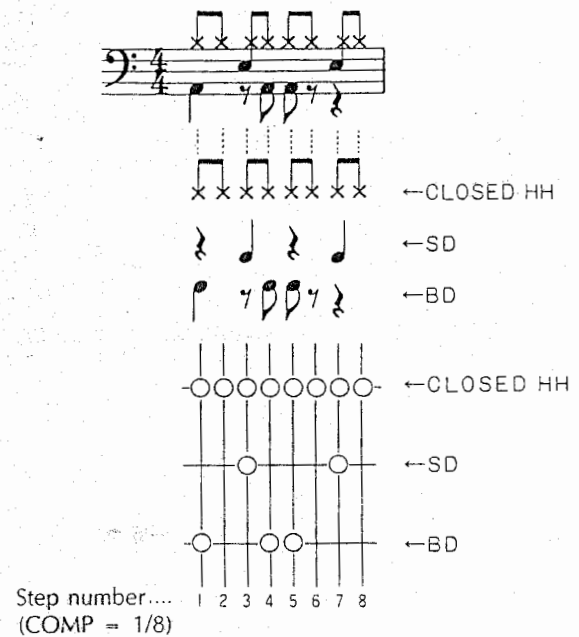

Press the corresponding INSTRUMENT key to write notes where indicated by the O in the diagram. A rest (no input) is indicated when no O is present. Since the minimum note value is an eighth note, AUTO COMPENSATE should be set at 1/8.

The same results can be obtained using one of two possible input methods. One possibility is to input the CLOSED HH the first time through, then the SD line the second time, and finally the BD line the third time. Input of two or more instruments each time through a measure is also possible.

6. Break pattern input

A pattern which has been transferred to STEP RECORD by pressing the VALUE ▲ key once in the PATTERN RECORD mode becomes a break pattern in accordance with the specified beat and measure even if notes have not been input and is treated as a pattern for which recording is complete.

2-3 Auto Compensate/Swing Function

When using REAL TIME RECORD, the AUTO COMPENSATE function operates to automatically correct timing errors up to $\pm 50\%$. AUTO COMPENSATE functions in an identical manner during STEP RECORD to set the minimum value of notes input. AUTO COMPENSATE also features a SWING function by which the timing of even numbered beats of $\frac{1}{2}$ notes can be preset to produce the "ride" feeling for the swing beat.

1. AUTO COMPENSATE setting

Press the parameter control AUTO COMPENSATE selector while in the PATTERN RECORD mode.

- The display should appear as illustrated below.

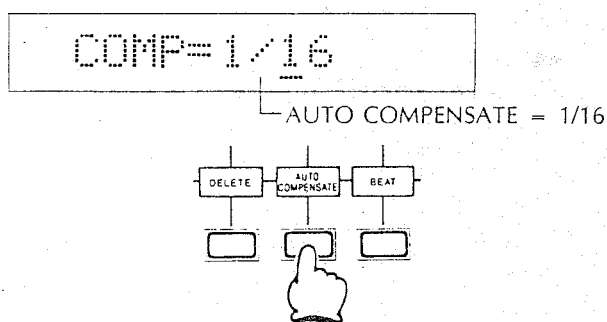

- The initial AUTO COMPENSATE value for any pattern which contains no input is always 1/16. Generally, the AUTO COMPENSATE value for a pattern which contains note data will be that set while writing to the pattern.
- The AUTO COMPENSATE value can be set to values from 1/2 through 1/96 by pressing the corresponding key on the ten-key pad.

COMP. = $\frac{1}{2}$	$\frac{1}{2}$	[0]
COMP. = $\frac{1}{4}$	$\frac{1}{4}$	[1]
COMP. = $\frac{1}{6}$	$\frac{1}{6}$	[2]
COMP. = $\frac{1}{8}$	$\frac{1}{8}$	[3]
COMP. = $\frac{1}{12}$	$\frac{1}{12}$	[4]
COMP. = $\frac{1}{16}$	$\frac{1}{16}$	[5]
COMP. = $\frac{1}{24}$	$\frac{1}{24}$	[6]
COMP. = $\frac{1}{32}$	$\frac{1}{32}$	[7]
COMP. = $\frac{1}{48}$	$\frac{1}{48}$	[8]
COMP. = $\frac{1}{96}$	$\frac{1}{96}$	[9]

AUTO COMPENSATE values are input by pressing a single key

The value set should be equal to the minimum value note used in the entire pattern. Note the following examples.

MINIMUM VALUE	COMP SETTING
	1/8
	1/16
	1/12
	1/24

- Once the AUTO COMPENSATE value is set, pressing the parameter control AUTO COMPENSATE selector again returns to write stand by, and the display appears as illustrated below.

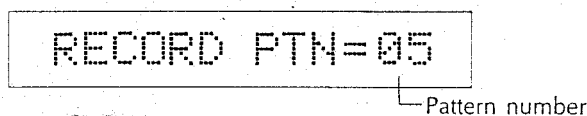

- Mistiming of $\pm 50\%$ during REAL TIME RECORD is corrected automatically.

Example: REAL TIME RECORD when COMP = 1/8

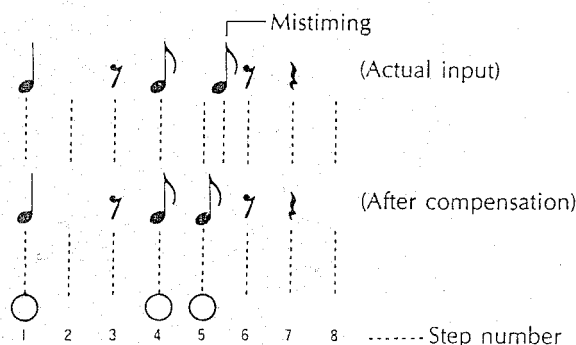

2. Proper application of AUTO COMPENSATE

The AUTO COMPENSATE value can be changed for each instrument or sample, and for each note within a single pattern.

- Changing the AUTO COMPENSATE value for each instrument or sample can be simplified by inputting a single instrument or sample during each pass through the measure.

Example: Inputting a 16-beat rhythm

PASS	INSTRUMENT	COMPSETTING
1	SD	1/4
2	BD	1/8
3	HH	1/16

In this way, the number of steps in the measure for instruments for which there are fewer notes is decreased.

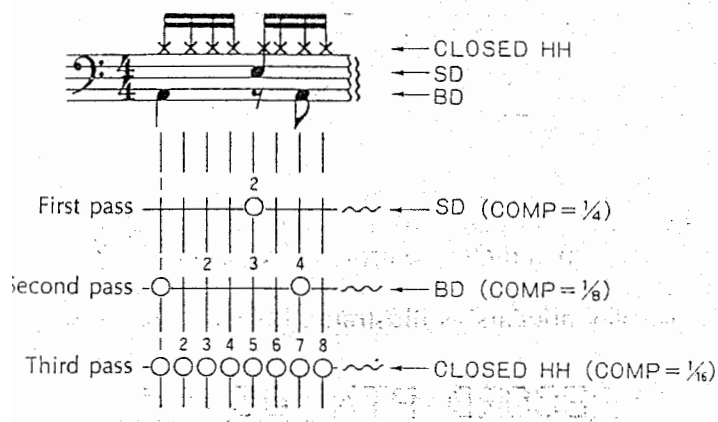

- For such complex rhythm fill-ins as triplets ($\underline{\underline{\underline{\quad}}}$) occurring in one part of a pattern, simply change the AUTO COMPENSATE value to match the input for that specific portion of the pattern.

NOTE

Generally, the AUTO COMPENSATE value for patterns into which notes have already been written equals the value used at input. In the case of 1/32, 1/48, and 1/96, however, the value will be displayed as 1/16 when the PATTERN RECORD mode is reentered. The value will also be 1/16 when two or more settings are used and the least common multiple of the denominator for each value is divisible by 16 (16, 32, 48, 96). Otherwise (i.e. in the case of 4, 6, 8, 12, and 24), the value will be 1/n, where n is the least common multiple of the denominator for each value.

Example:

- BD (COMP = 1/4) } COMP = 1/16
- SD (COMP = 1/8) }
- HH (COMP = 1/16) }

- BD (COMP = 1/32) } COMP = 1/16
- SD (COMP = 1/16) }
- HH (COMP = 1/16) }

- BD (COMP = 1/8) } COMP = 1/4
- SD (COMP = 1/4) }
- TOM (COMP = 1/16) }

3. Swing function

When the AUTO COMPENSATE value is set to 1/8 in the PATTERN RECORD mode, the timing of the even numbered beats for inputs of $\underline{\underline{\underline{\quad}}}$ will be delayed.

- Setting the AUTO COMPENSATE value to 1/8 will cause the display to appear as illustrated below.

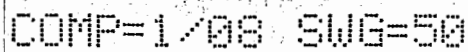

SWING function display

The "SWG = 50" on the SWING function display means that no delay at all is applied, and expresses a percentage of 50%. The initial value is COMP = 1/8, SWG = 50(%)

- Each press of the VALUE \blacktriangle key increases the value of the SWING setting to one of six levels in the order of 50 \rightarrow 54 \rightarrow 58 \rightarrow 63 \rightarrow 67 \rightarrow 71. The VALUE \blacktriangle key can also be used to decrease the value in reverse order.

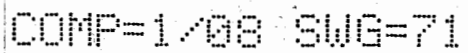

SWING = 71%

The higher the value, the greater the delay of the timing for even numbered beats. The maximum delay possible is 71%.

NOTE: The percentages used in the SWING functions are expressed as follows:

$$SWG = \frac{\text{Odd-numbered beat length}}{\text{Odd-numbered beat length} + \text{Even-numbered beat length}} \times 100\%$$

- The effect applied using the SWING function can only be confirmed during playback. The method used for writing notes to patterns with this function is identical to that used for normal input.

NOTE

The SWING function is canceled whenever AUTO COMPENSATE is changed to any other value besides 1/2, 1/4, or 1/8. At this time, all notes shorter than 8th notes written using the SWING function are eliminated. Resetting the AUTO COMPENSATE value to 1/8 restores the SWING function set value.

2-4 Delete

All of the notes written into a pattern, all of the notes for a specific sound source used in a pattern, or individual notes in a pattern can be deleted while in the PATTERN RECORD mode.

1. Deleting all notes in a pattern

Press the parameter control DELETE selector while in the PATTERN RECORD mode write stand by.

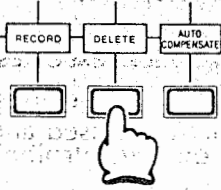

- At this time, the display should appear as illustrated below.

DELETE PTN 05 ?

Selected pattern number

Pressing the VALUE ▲ (YES) key will cause the display to appear as illustrated below. The unit automatically returns to write stand by once deletion is complete.

DELETE OK!

- Pressing the VALUE ▼ (NO) key immediately returns to write stand by without deleting the pattern.

2. Deleting a specific sound source

Enter the PATTERN RECORD write standby. Press the INSTRUMENT key or SAMPLE key that corresponds to the sound source to be deleted while holding down the parameter control DELETE selector.

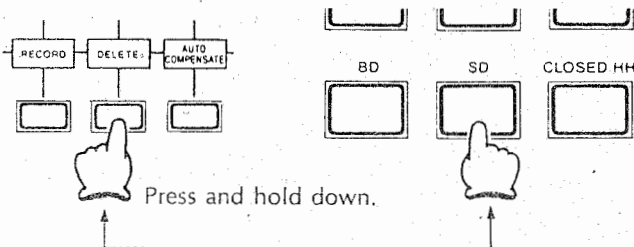

- At this time, the display should appear as illustrated below.

DELETE SNARE ?

Snare drum example

Pressing the VALUE ▲ (YES) key will cause the display to appear as illustrated below. The unit automatically returns to write stand by once deletion is complete.

DELETE OK!

3. Deleting specific notes in STEP RECORD

During the STEP RECORD writing procedure, press the INSTRUMENT key or SAMPLE key that corresponds to the sound source of the note to be deleted while holding down the parameter control DELETE selector. At this time, the note for the selected sound source will be deleted in the step currently appearing on the display.

- The display will not change when specific notes are deleted using this procedure.

4. Deleting specific notes in REAL TIME RECORD

During the REAL TIME RECORD writing procedure, press the INSTRUMENT key or SAMPLE key that corresponds to the sound source of the note to be deleted while holding down the parameter control DELETE selector. This procedure should be timed with the play of the specific note to be deleted.

- Only the notes for the selected sound source while the parameter control DELETE selector is pressed will be deleted.
- The display will not change when specific notes are deleted using this procedure.
- Specific notes can be deleted from complex patterns by first suspending REAL TIME RECORD by pressing the START/STOP key. Then the VALUE ▲ key can be used to move to the step to be deleted, and actual deletion can be performed using the procedure outlined previously for STEP RECORD 3.

2-5 Copy

Identical copies of note data stored under one pattern number can be made to other pattern numbers.

1. Copying to a pattern which contains no data

- ① While in the PATTERN PLAY mode, ensure that the START/STOP indicator is OFF and select the number of the pattern to be copied.
 - The VALUE ▲▼ keys or the ten-key pad can be used to change the selected pattern number shown on the display.

PLAY PTN=07

Number of pattern to be copied

- ② Pressing the parameter control COPY selector will cause the display to appear as illustrated below.

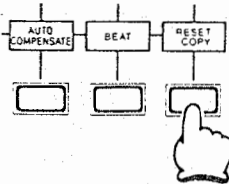

COPY PTN 07→**

Number of pattern to be copied

- ③ Use the ten-key pad to enter a 2-digit number which represents the destination pattern of the data being copied.

Example: Enter 12 using the ten-key pad to designate pattern 12 as the destination pattern of the data being copied.

COPY PTN 07→12?

- ④ Pressing the VALUE ▲ (YES) key will cause the display to appear as illustrated below, which indicates that the copy operation is complete.

COPY OK!

- The unit automatically returns to the PATTERN PLAY mode (for PTN = 07 in this example) once the copy operation is complete.
- Pressing the VALUE ▼ (NO) key will immediately return to the PATTERN PLAY mode without performing the copy operation.

2. Existing data in destination pattern

(Continuing from step ③ above)

- ④ Pressing the VALUE ▲ (YES) key will cause the display to appear as illustrated below.

DELETE PTN 12 ?

Number of destination pattern (which contains data)

- ⑤ Pressing the VALUE ▲ (YES) key again proceeds to the next display and executes copy operations.
 - In this case, the data previously stored in the destination pattern is erased and the new (copy) data is stored.
 - The unit automatically returns to the PATTERN PLAY mode once the copy operation is complete.
 - To maintain the data in the original destination pattern in the above example, press the VALUE ▼ (NO) selector to return to the PATTERN PLAY mode. Then press the COPY selector again and change the destination pattern number.

2-6 Pattern Playback

The PATTERN PLAY mode allows play back of patterns into which notes are written. The INSTRUMENT keys and SAMPLE keys can be used to play along with the rhythm pattern as it is played back.

1. PATTERN PLAY mode setting

The unit is set to either the PATTERN PLAY mode or SONG PLAY mode when the PATTERN RECORD, SONG EDIT, SAMPLING, MT, and MIDI modes are all canceled. The unit can be switched from the SONG PLAY MODE (SONG indicator green) to the PATTERN PLAY mode by pressing the PATTERN key. At this time, the PATTERN indicator will light green and the SONG indicator will go out.

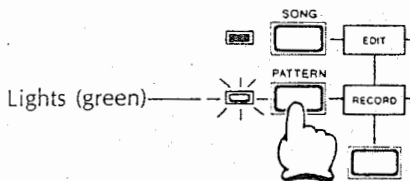

- The display will appear as illustrated below when the PATTERN PLAY mode is entered.

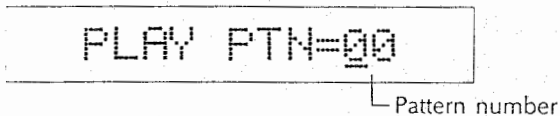

- The pattern number displayed immediately after the power of the unit is switched on is the same as that selected when the power was last switched off. The last pattern number selected will generally be displayed after switching to another mode and then back to the PATTERN PLAY mode.

NOTE: The display of the PATTERN PLAY mode after playback of a song in the SONG PLAY mode will show the pattern at which playback was terminated in the SONG PLAY mode.

2. Pattern number specification

The ten-key pad is used to specify the number of the pattern to be played back. Settings are made by inputting a 2-digit number, and the number selected is shown on the display.

- The pattern number can also be increased or decreased by one with each press of the VALUE ▲▼ keys.

Example: Recalling pattern 16

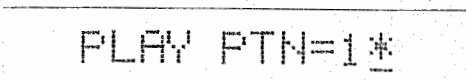

- ① When [1] is pressed on the ten-key pad, the number "1" appears on the display and the cursor shifts under the "*" on the right.

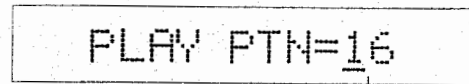

- ② When [6] is pressed, the number "6" appears on the display and the cursor returns to its original position.

3. START/STOP

Pressing the START/STOP key begins playback of the pattern stored under the number selected in 2.

- The START/STOP indicator remains lit (red) during playback.

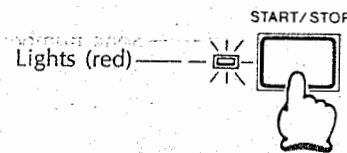

- Playback is performed as an endless loop from the beginning of the pattern to the end, and then back to the beginning again.
- Pressing the START/STOP key again terminates playback at that point.

4. CONTINUE START

Playback can be resumed from the point at which it is terminated by pressing the START/STOP key in 3. above by pressing the CONTINUE START key.

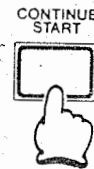

3 SONG EDIT

3-1 Song edit

Multiple song patterns can also be combined into a single rhythm line (song).

1. Song number setting

The desired song number can be set in the SONG PLAY mode using the ten-key pad or the VALUE ▲▼ keys.

- At this time the display will appear as illustrated below.

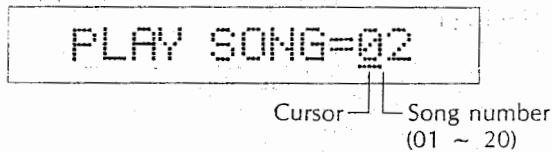

Example: To select song 02, either enter 02 on the ten-key pad or press the VALUE ▲▼ keys until 02 is shown on the display.

2. SONG EDIT mode setting

Press the parameter control EDIT selector while in the SONG PLAY mode.

- At this time, the color of the SONG indicator changes from green to red indicating the SONG EDIT mode.

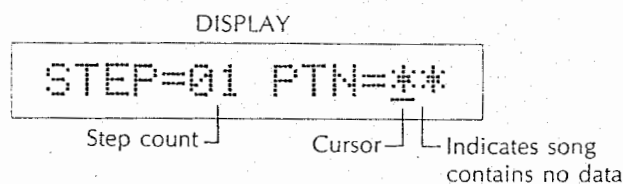
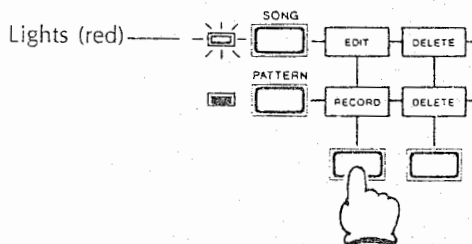

- The SONG EDIT mode is canceled by pressing the EDIT selector again. At this time, the unit returns to the SONG PLAY mode.

3. Writing to a song which contains no data

The display appears as illustrated below when the SONG EDIT mode is entered for a song number which contains no data.

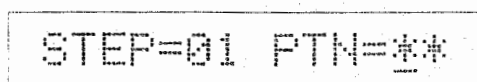

- ① Use the ten-key pad to input a 2-digit number which represents the number of the pattern to be written into the first step.

Example: To select song 08, enter 08 on the ten-key pad.

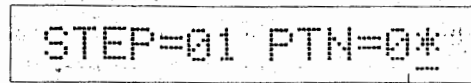

When 0 is pressed, "0" appears on the display and the cursor shifts under the "*" on the right.

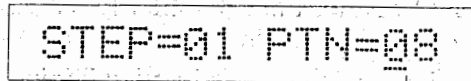

When 0 is pressed, "8" appears on the display and the cursor returns to its original position.

- ② The VALUE ▲ key is used to advance to the next step.

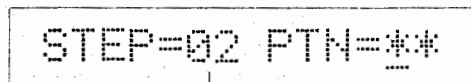

- ③ Use the ten-key pad to input a 2-digit number which represents the number of the pattern to be written into the second step.
- Following the procedures outlined above for the third and subsequent steps allows multiple patterns to be combined into a single rhythm pattern (song).
- The VALUE ▼ key can be used to return to previous steps, and pressing the parameter control RESET selector returns to step one.
- Up to twenty songs (01 ~ 20) with a maximum of 99 steps each can be written.
- ④ Once writing is complete, the SONG EDIT mode is canceled by pressing the EDIT selector again.

NOTE

MEMORY CAPACITY CONFIRMATION

Pressing the SONG selector while in the SONG PLAY mode will cause the percentage of song memory area used to appear on the display.

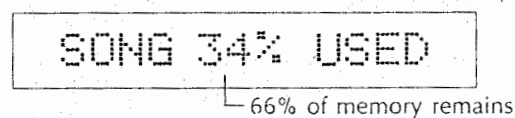

The following display appears when the memory capacity is exceeded while writing a song.

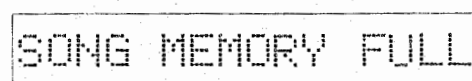

- This message may also appear when performing INSERT (page 21) or COPY (page 23) operations.
- At this time, press the EDIT selector to cancel the SONG EDIT mode.

4. Modifying written songs

The SONG EDIT mode can be used to display each step and its pattern number for previously written songs. The ten-key pad can then be used to change the displayed pattern number.

- ① Press the VALUE ▲ key to display the step to be modified.
 - The VALUE ▼ key can also be used to steps preceding the displayed step.
 - Holding down the VALUE ▲▼ keys causes the displayed step to change at high speed.
- ② Inputting a 2-digit number using the ten-key pad will change the displayed pattern number to the number input.

3-2 Delete

1. Deleting a specific step

The SONG EDIT mode can be used to delete specific steps from previously written songs.

- ① Enter the SONG EDIT mode and use the VALUE ▲▼ keys to display the step to be deleted.

STEP=03 PTN=20

Step to be deleted | Pattern number

- ② Press the parameter control DELETE selector and the display will appear as illustrated below.

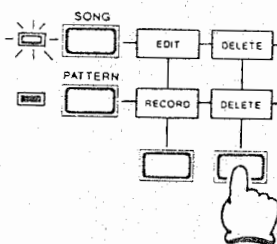

DELETE STEP 03 ?

- ③ Pressing the VALUE ▲ (YES) key causes the display to appear as illustrated below. The unit automatically advances to and displays the next step once deletion is complete.

DELETE OK!

Deletion being performed

STEP=03 PTN=21

All data from step 04 onwards is shifted to fill the space created by the deleted step.

- Pressing the VALUE ▼ (NO) key immediately returns to the SONG EDIT mode without deleting the step.

2. Deleting an entire song

All of the data included in a song can be deleted in the SONG PLAY mode.

- ① Enter the SONG PLAY mode and use the ten-key pad or VALUE ▲▼ keys to display the number of the song to be deleted.
- ② Pressing the parameter control DELETE selector causes the display to appear as illustrated below.

DELETE SONG 02 ?

Number of song to be deleted

- ③ Pressing the VALUE ▲ (YES) key causes the display to appear as illustrated below.

DELETE OK!

Deletion being performed

- The unit automatically returns to the SONG PLAY mode once the selected song is deleted.
- Pressing the VALUE ▼ (NO) key immediately returns to the SONG PLAY mode without deleting the step.

3-3 Insert

The SONG EDIT mode can also be used to insert patterns at any location between patterns (steps) already written into a song.

- ① Enter the SONG EDIT mode and use the VALUE ▲▼ keys to display the step at which the new pattern is to be inserted.

Example: To insert a new pattern at step 06, press the VALUE ▲ key until step 06 appears on the display.

STEP=06 PTN=14

Step where insertion will be performed

Currently written pattern number

- ② Pressing the parameter control INSERT selector causes the display to appear as illustrated below.

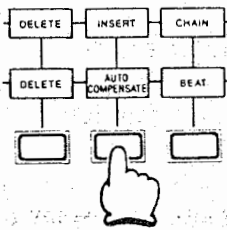

STEP=06 PTN=***

The pattern previously written in this step is shifted into the next step.

- ③ Use the ten-key pad to input a 2-digit number which represents the number of the pattern to be inserted into the song.

STEP=06 PTN=31

Number of pattern to be inserted

- Pressing the INSERT selector again returns to the SONG EDIT mode without changing the song.

3-4 Chain

Multiple songs can be "chained" together for continuous playback.

- ① Enter the SONG PLAY mode and use the ten-key pad or VALUE ▲▼ keys to display the number of the first song of the series (chain).
- ② Press the parameter control CHAIN selector.

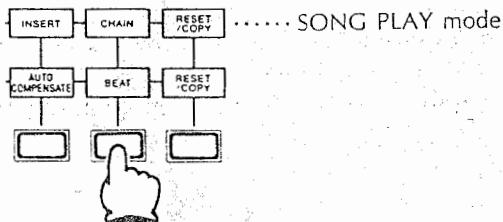

- At this time, the display appears as illustrated below.

CHAIN SONG 03+***

Pattern number set in ①

- ③ Use the ten-key pad to input a 2-digit number which represents the number of the next song in the chain. At this time, the display appears as illustrated below.

SONG 03+01 ?

Number of song to be chained

- Specifying the same song for the first and second steps of the chain results in repeat play of the same song.

- ④ Pressing the VALUE ▲ (YES) key causes the display to appear as illustrated below.

CHAIN OK!

- The unit automatically returns to the SONG PLAY mode once the chain operation is complete.
- Pressing the VALUE ▼ (NO) key immediately returns to the SONG PLAY mode without performing the chain operation.

<Modifying and canceling chains>

- Pressing the CHAIN selector again allows the second song in the chain to be changed.
- Pressing the DELETE selector after the CHAIN selector makes it possible to cancel a chain.

DELETE CHAIN ?

Executed by VALUE ▲ (YES) key

DELETE OK!



CHAIN SONG 03+***

Chain canceled

3-5 Copy

While in the SONG PLAY mode and with the START/STOP indicator OFF, the data stored in the selected song can be copied exactly as it is into another song.

1. Copying to a song which contains no data

- ① While in the SONG PLAY mode, ensure that the START/STOP indicator is OFF and select the number of the song to be copied.
- The VALUE ▲▼ keys or the ten-key pad can be used to change the selected song number shown on the display.

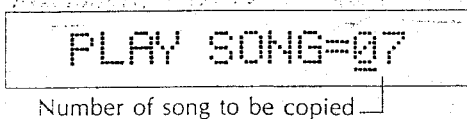

- ② Pressing the parameter control COPY selector causes the display to appear as illustrated below.

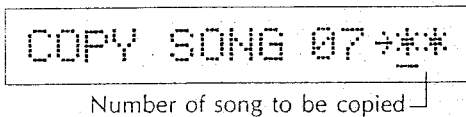
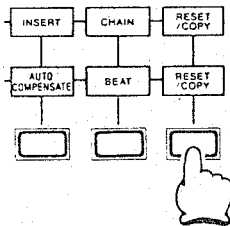

- ③ Use the ten-key pad to enter a 2-digit number which represents the destination song of the data being copied.
Example: Enter 12 using the ten-key pad to designate song 12 as the destination song of the data being copied.

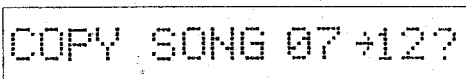

- ④ Pressing the VALUE ▲(YES) key causes the display to appear as illustrated below, which indicates that the copy operation is complete.

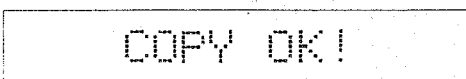

- The unit automatically returns to the SONG PLAY mode (for SONG = 07 in this example) once the copy operation is complete.
- Pressing the VALUE ▼(NO) key immediately returns to the SONG PLAY mode without performing the copy operation.

2. Existing data in destination song

(Continuing from step ③ above)

- ④ Pressing the VALUE ▲(YES) key causes the display to appear as illustrated below.

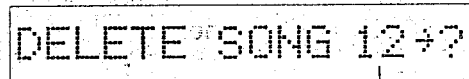

Number of destination song (which contains data)

- ⑤ Pressing the VALUE ▲(YES) key again proceeds to the next display and executes copy operations.
 - In this case, the data previously stored in the destination song is erased and the new (copy) data is stored.
 - The unit automatically returns to the SONG PLAY mode once the copy operation is complete.
 - To maintain the data in the original destination song in the above example, press the VALUE ▼(NO) selector to return to the SONG PLAY mode. Then press the COPY selector again and change the destination song number.

3-6 Song Playback

The SONG PLAY mode allows play back of songs into which notes are written. The INSTRUMENT keys and SAMPLE keys can be used to play along with the song as it is played back.

1. SONG PLAY mode setting

The unit is set to either the PATTERN PLAY mode or SONG PLAY mode when the PATTERN RECORD, SONG EDIT, SAMPLING, MT, and MIDI modes are all canceled. The unit can be switched from the PATTERN PLAY MODE (PATTERN indicator green) to the SONG PLAY mode by pressing the SONG key. At this time, the SONG indicator will light green and the PATTERN indicator will go out.

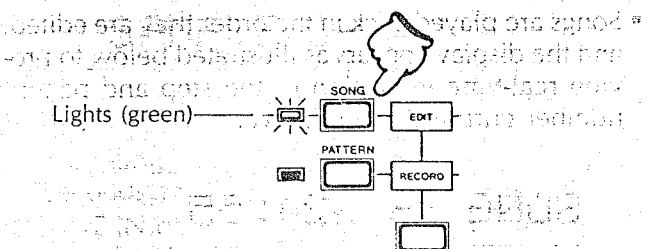

- The display will appear as illustrated below when the SONG PLAY mode is entered.

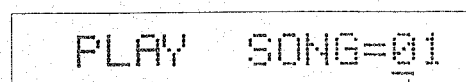

- The song number displayed immediately after the power of the unit is switched on is the same as that selected when the power was last switched off. The last song number selected will generally be displayed after switching to another mode and then back to the SONG PLAY mode.

2. Song number specification

The ten-key pad is used to specify the number of the song to be played back. Settings are made by inputting a 2-digit number, and the number selected is shown on the display.

- The song number can also be increased or decreased by one with each press of the VALUE ▲▼ keys.

Example: Recalling song 16

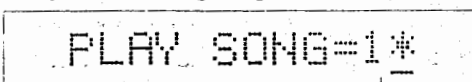

- ① When [1] is pressed on the ten-key pad, the number "1" appears on the display and the cursor shifts under the "*" on the right.

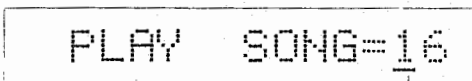

- ② When [6] is pressed, the number "6" appears on the display and the cursor returns to its original position.

3. START/STOP

Pressing the START/STOP key begins playback of the song stored under the number selected in 2.

- The START/STOP indicator remains lit (red) during playback.

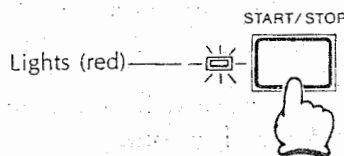

- Songs are played back in the order they are edited, and the display appears as illustrated below to provide real-time indication of the step and pattern number currently being played.

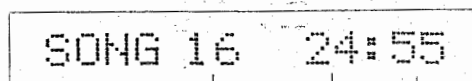

Song number Step Pattern number

- * Indicates that step 24 of song 16 is being played back, and that this particular part of the song is made up of pattern 55.

- Playback is automatically terminated after the final measure written for the song is played. Playback can also be manually terminated at any point by pressing the START/STOP key.
- If another song is chained to the selected song, the last measure of the selected song is played and then playback of the next (chained) song begins without interruption. The song number shown on the display changes to indicate the number of the next (chained) song.

4. CONTINUE START

Playback can be resumed from the point at which it is terminated (using the START/STOP key in 3. above) by pressing the CONTINUE START key.

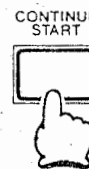

NOTE

RECALLING A RECORDED PATTERN

Playback of a song will stop with the recall of any step that contains an unrecorded pattern within the song.

RECALLING A BREAK PATTERN

A rest will be input in accordance with the specified beat and measure with the recall of any step during song playback that contains a break pattern (see pages 12 and 14).

4 SAMPLING

4-1 Sampling mode

The SAMPLING mode of the RZ-1 allows input of sampled sound through either MIC or LINE IN input and storage in one of four banks (SAMPLE 1 ~ 4). The sampling period for each bank is 0.2 seconds.

1. Sampling procedures

- ① While in the PATTERN PLAY mode or SONG PLAY mode, ensure that the START/STOP indicator is OFF. Press one of the SAMPLE keys (1 ~ 4) while holding down the SAMPLING key.

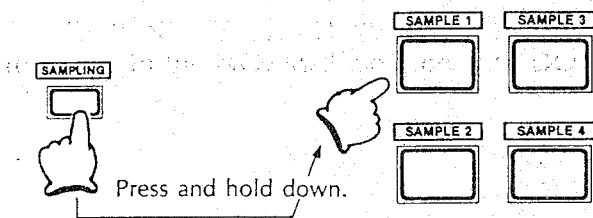

- This operation enters the SAMPLING mode and causes the display to appear as illustrated below.

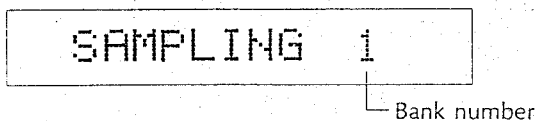

- This display indicates sampling stand by.
- ② Sampling is performed automatically any time input is received through either LINE IN or MIC while sampling stand by.

- The input level is adjusted using the SAMPLING LEVEL control.
- The SAMPLING indicator lights during sampling operations and goes out once sampling is complete.
- The display appears as illustrated below when sampling is complete and then the unit returns to its original (PATTERN PLAY or SONG PLAY) mode.

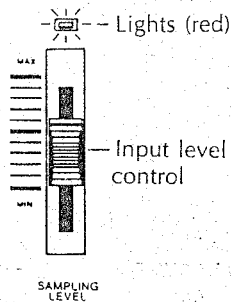

- Pressing the SAMPLING key immediately returns to the original (PATTERN PLAY or SONG PLAY) mode without performing the sampling operation.

The procedure outlined above can be used to store sounds of 0.2 seconds duration to one sampling bank (1 through 4). Once a sampled sound is assigned to a bank, it can be sounded and incorporated into rhythm patterns by pressing the SAMPLE keys. The operation of the SAMPLE keys is identical to that used for the INSTRUMENT keys.

4-2 Sampling Bank Linking

Sampling banks can be linked in such combinations as SAMPLE 1/SAMPLE 2, SAMPLE 3/SAMPLE 4 or SAMPLE 1 ~ 4 to allow sampling of sound 0.4 seconds or 0.8 seconds in duration.

1. SAMPLE 1/SAMPLE 2

- ① Simultaneously press SAMPLE key 1 and SAMPLE key 2 while holding down the SAMPLING key.
- This operation enters the SAMPLING mode and causes the display to appear as illustrated below (sampling stand by).

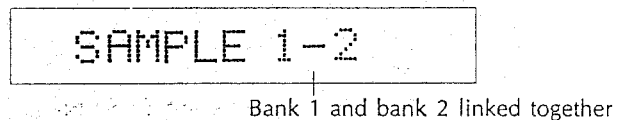

- ② Sampling is performed automatically for 0.4 seconds any time input is received through either LINE IN or MIC while in sampling stand by. The sampled sound is stored in sampling banks 1 and 2.

2. SAMPLE 3/SAMPLE 4

- ① Simultaneously press SAMPLE key 3 and SAMPLE key 4 while holding down the SAMPLING key.
- This operation enters the SAMPLING mode and causes the display to appear as illustrated below (sampling stand by).

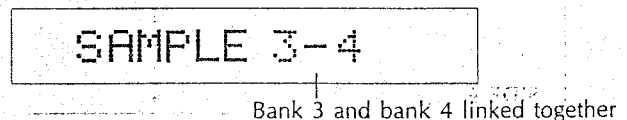

- ② Sampling is performed automatically for 0.4 seconds any time input is received through either LINE IN or MIC while in sampling stand by. The sampled sound is stored in sampling banks 3 and 4.

3. SAMPLE 1 ~ 4

- ① Simultaneously press SAMPLE key 1 and SAMPLE key 4 while holding down the SAMPLE key.
- This operation enters the SAMPLING mode and causes the display to appear as illustrated below (sampling stand by).



All 4 banks linked together

- ② Sampling is performed automatically for 0.8 seconds any time input is received through either LINE IN or MIC while in sampling stand by. The sampled sound is stored in sampling banks 1, 2, 3, and 4.

4-3 Accessory Cassette

The "SOUND COLLECTION" cassette tape that comes with the unit contains recordings of drum and other percussion sounds sampled using the RZ-1.

SIDE A	BASIC DRUM SOUNDS
SIDE B	LATIN PERCUSSION AND SYNTHESIZED DRUMS

A total of 91 different samples are included with a narrative explanation preceding each one. See the Sound Collection Listing at the end of this manual for details on the 91 samples included on the tape.

1. Using the Sound Collection Listing

- Samples 1 through 46 are recorded on SIDE A of the cassette, while samples 47 through 91 are on SIDE B. Each sample is also assigned a name and type.
- The "NUMBER OF BANKS" column shows the number of banks used to take the sample, and also indicates the approximate duration of the sample (i.e. 1 bank = 0.2 seconds, 2 banks = 0.4 seconds, 4 banks = 0.8 seconds).

Indicates difference between similar names

- Different sound: A/B/C/D/
- Different playing style: CLOSED/OPEN, HIGH/MIDDLE/LOW

Sequence

Number of sampling banks
 1 bank: SAMPLE 1, 2, 3, or 4 can be used
 2 banks: SAMPLE 1/2 or SAMPLE 3/4 can be used
 4 banks: SAMPLE 1/2/3/4 must be used

SIDE A

No.	INSTRUMENT NAME	TYPE	NUMBER OF BANKS
1	BASS DRUM	A	1
2	BASS DRUM	B	1
3	BASS DRUM	C	1
4	BASS DRUM	D	1
5	SNARE DRUM	A	1
6	SNARE DRUM	B	1
7	SNARE DRUM	C	1
8	SNARE DRUM		1
9	SNARE DRUM		1

2. Cassette recorder connection

The sampled sounds are input to the RZ-1 through the LINE terminal using any standard cassette recorder.

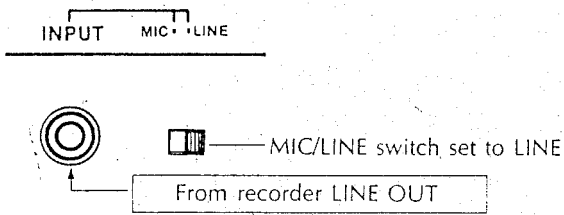

- The "SOUND COLLECTION" cassette tape was recorded in the NORMAL position with DOLBY ON.
- Though input of the recorded sounds can also be performed using a microphone, it is suggested that line input be used to avoid the effects of noise.

3. Sampling procedure

A narration giving the number, name, and type of the sample is included before the actual sample sounds. Perform the following procedures for sampling while monitoring the output of the tape through headphones or speakers.

- ① After listening to the narration portion for the desired sample, press the PAUSE button on the cassette recorder before the sample sounds.

Example:

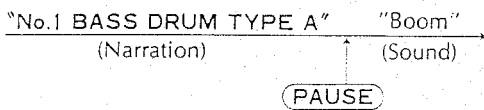

- ② Set the RZ-1 to the SAMPLING mode and adjust the SAMPLING LEVEL control to the desired input setting (see Sampling Procedure and Sampling Bank Linking).
- ③ Once the RZ-1 is in sampling stand by, press the PAUSE button of the cassette recorder again to start playback of the tape. Sampling will be performed automatically when the sample is sounded.

5 MT FUNCTION

Pattern, song, and sample data can be saved to or loaded from cassette tape through the MT terminal of the RZ-1.

< SAVE/LOAD DATA >

RHYTHM: a. PATTERN data
 b. SONG data (including CHAIN)
 c. TEMPO values
 d. MIDI channel numbers and NOTE ENA/DIS data
 e. PATTERN/SONG numbers selected for SAVE values and PATTERN key/SONG key ON/OFF status

SAMPLE: Sample sound (SAMPLE 1 ~ 4) data

< Connection to the recorder >

- WHITE PLUG To remote (REM) terminal
 * Only used if recorder has a remote terminal.
- BLACK PLUG To earphone (EAR) or load (LOAD) terminal
- RED PLUG To microphone (MIC) or save (SAVE) terminal
 * Actual connections may differ according to the type of recorder. Consult the owner's manual of the recorder being used for details on proper connections.

5-1 Connection with a Tape Recorder

Prepare a commercially available data recorder or cassette tape recorder and one cassette tape that is in good condition. Use the accessory MT connection cord to connect the RZ-1 as illustrated with the recorder being used.

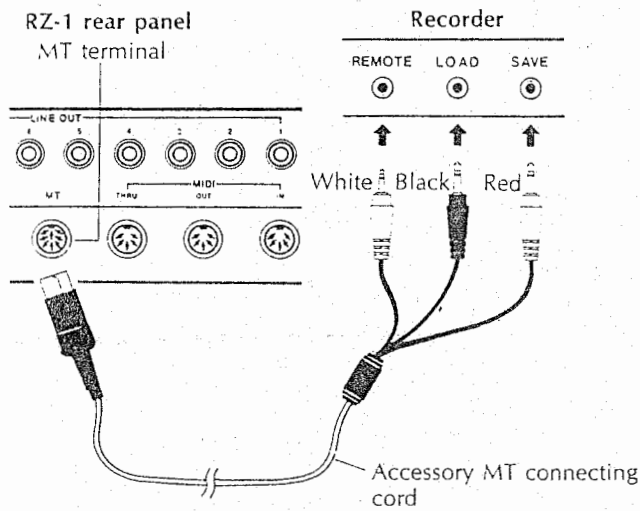

- The recorder end of the connection cord is divided among three plugs: white (REMOTE), black (LOAD), and red (SAVE).

5-2 Data SAVE/VERIFY

1. Data SAVE

- ① While in either the PATTERN PLAY mode or SONG PLAY mode, press the MT SAVE key to enter MT mode RHYTHM data SAVE stand by.
- At this time, the display will appear as illustrated below.

MT SAVE RHYTHM ?

└ RHYTHM data SAVE

< Saving RHYTHM data >

- ② Setting the recorder to RECORD and pressing the VALUE ▲ (YES) key begins recording of RHYTHM data a. through e.
- Tape transport will begin when a signal is received from the REMOTE terminal of the recorder.
 - The display appears as illustrated below during SAVE operations.

MT SAVE RUN!

└ SAVE being performed

< Saving SAMPLE data >

- ② First press the VALUE ▼ (NO) key to enter SAMPLE data SAVE stand by.
- At this time, the display will appear as illustrated below.

MT SAVE SAMPLE ?

└ SAMPLE data SAVE

Setting the recorder to RECORD and pressing the VALUE ▲ (YES) key begins recording of SAMPLE data (SAMPLE 1 ~ 4).

- Tape transport will begin when a signal is received from the REMOTE terminal of the recorder.
- The display appears as illustrated below during SAVE operations.

MT SAVE RUN!

└ SAVE being performed

- ③ The following display appears when RHYTHM/ SAMPLE data save operations are complete.

MT SAVE OK!

After a short period of time, the display appears as illustrated below.

MT VERIFY ?

- The procedures outlined above complete actual data save operations. The following procedure is used to verify whether or not the data was correctly transferred from the RZ-1 to the cassette tape.

2. Data VERIFY

The following is a continuation of the procedures previously outlined up to 1.—③.

- ① Rewind the cassette tape to the point at which data save was first initiated.
- ② After pressing the VALUE ▲ (YES) key, begin playback of the tape on the recorder and data VERIFY operations will begin.
 - At this time the RZ-1 will verify whether or not the save data has been transferred correctly to the tape.

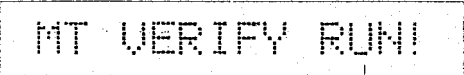

MT VERIFY RUN!

└ VERIFY being performed

- ③ The display appears as follows after VERIFY operations are complete when there are no errors detected in the data stored on the cassette.

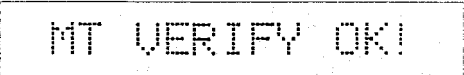

MT VERIFY OK!

In a few moments the unit automatically returns to the original (PATTERN PLAY or SONG PLAY) mode.

- This display appears as follows when an error is detected in the data stored on the cassette.

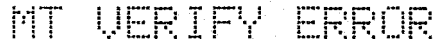

MT VERIFY ERROR

└ Error display

In this case, press the PATTERN key or SONG key to cancel the MT mode, and begin SAVE operations from the 1. Data SAVE step.

NOTE

- Errors detected by the VERIFY operation and trouble during LOAD operations may be caused by problems with the recorder equipment being used. An insufficient playback level during VERIFY or recording level during SAVE may make proper data interchange impossible. In such cases, set levels properly, or use different equipment.
- Pressing the RESET selector during VERIFY terminates the function and generates an error message. Pressing the RESET selector during SAVE terminates the function and returns the unit to its original (PATTERN PLAY or SONG PLAY) mode.

5-3 Data LOAD

- ① While in either the PATTERN PLAY mode or SONG PLAY mode, press the MT LOAD key to enter MT mode RHYTHM data SAVE stand by.
 - At this time, the display appears as illustrated below.

MT LOAD RHYTHM ?

└ RHYTHM data LOAD

<Loading RHYTHM data>

- ② Set the tape so that playback is at a point immediately preceding the RHYTHM data to be loaded.

<Loading SAMPLE data>

- ② First press the VALUE ▼(NO) key to enter SAMPLE data LOAD stand by.
 - At this time, the display appears as illustrated below.

MT LOAD SAMPLE ?

└ SAMPLE data LOAD

Set the tape so that playback is at a point immediately preceding the SAMPLE data to be loaded.

- ③ After pressing the VALUE ▲(YES) key, press the PLAYBACK key of the recorder and data LOAD will begin.

MT LOAD RUN!

└ LOAD being performed

- ④ The following display appears when RHYTHM/SAMPLE data load operations are complete.

MT LOAD OK!

After a short period of time, the display unit returns to its original (PATTERN PLAY or SONG PLAY) mode.

- The display appears as illustrated below when LOAD is not performed correctly.

MT LOAD ERROR

└ Error display

In this case, press the PATTERN key or SONG key to cancel the MT mode, and begin LOAD operations from the ① Data LOAD step.

NOTE

- Trouble during LOAD operations may be caused by problems with the recorder equipment being used. An insufficient playback level during LOAD may make proper data interchange impossible. In such cases, set the level properly, or use different equipment.
- Pressing the RESET selector during LOAD will terminate the function and generate an error message.

6 MIDI

6-1 Transmit/Receive Data

The following table shows the data that the RZ-1 is capable of transmitting and receiving.

Message	Transmit	Receive
NOTE ON (NOTE No.) (Velocity)	<input type="radio"/> 36 ~ 62 <input type="radio"/> 48, 64, 112	<input type="radio"/> 35 ~ 64 <input type="radio"/> 1 ~ 127 (3 steps)
NOTE OFF		
CLOCK	<input type="radio"/>	<input type="radio"/>
COMMAND (START/STOP, CONTINUE START)	<input type="radio"/>	<input type="radio"/>
SONG SELECT	<input type="radio"/>	<input type="radio"/>

- NOTE TRANSMIT
 - Velocity = 48: MUTE applied
 - Velocity = 64: Normal note
 - Velocity = 112: ACCENT applied
- NOTE RECEIVE
 - Velocity = 1 ~ 48: MUTE applied
 - Velocity = 49 ~ 96: Normal note
 - Velocity = 97 ~ 127: ACCENT applied

6-2 MIDI Channel Settings

Transmit/receive operations with the RZ-1 are performed in MODE 3 (fixed), and channels 1 through 16 can be set as transmit/receive channels.

- ① Pressing the MIDI CHANNEL KEY while in the PATTERN PLAY mode or SONG PLAY mode causes the display to appear as illustrated below.

CH=01 NOTE=ENA

Use the ten-key pad to input a 2-digit number which represents the transmit/receive channel.

- ② Press either the VALUE ▲ or ▼ key to switch the display between NOTE = ENA and NOTE = DIS.
- * NOTE = ENA (ENABLE)
Indicates that NOTE data transmission/reception is possible.
 - * NOTE = DIS (DISABLE)
Indicates that NOTE data transmission/reception is not possible.
- ③ Pressing the MIDI CHANNEL key again returns the unit to its original (PATTERN PLAY or SONG PLAY) mode. The corresponding PATTERN PLAY key or SONG PLAY key can also be pressed in place of the MIDI CHANNEL key to directly enter either mode.

6-3 Clock Setting

Either the internal clock or an external clock can be selected for use during the PATTERN PLAY mode and SONG PLAY mode. The internal clock is automatically selected when the power of the unit is switched ON.

- ① Pressing the MIDI CLOCK KEY while in the PATTERN PLAY mode or SONG PLAY mode the display to appear as illustrated below.

CLOCK=INT

CLOCK=EXT

Press either the VALUE ▲ or ▼ key to switch the display between CLOCK = INT and CLOCK = EXT.

- * CLOCK = INT (INTERNAL)
- * CLOCK = EXT (EXTERNAL)

- ② Pressing the MIDI CLOCK key again returns the unit to its original (PATTERN PLAY or SONG PLAY) mode. The corresponding PATTERN PLAY key or SONG PLAY key can also be pressed in place of the MIDI CLOCK key to directly enter either mode.

(※ C. = 60)

Source	Note number	
	Transmit	Receive
BD	35、36	36
RIM	37	37
SD	38、40	38
TOM 1	41、43	41
TOM 2	45、47	45
TOM 3	48、50	48
CLOSED HH	42、44	42
OPEN HH	46	46
CRASH	49	49
RIDE	51	51
COWBELL	56	56
CLAPS	39	39
SAMPLE 1	52、53	52
SAMPLE 2	55、57	55
SAMPLE 3	59、60	59
SAMPLE 4	62、64	62

APPENDICES

A-1 Memory Back Up

The memory protection battery of the RZ-1 maintains the following data when the main power of the unit is switched OFF.

1. Pattern data
2. Song data (including CHAIN)
3. Tempo data
4. Sample data (SAMPLE 1 ~ 4)
5. MIDI channel data (including NOTE = ENA/DIS)
6. Pattern numbers
7. Song numbers
8. Whether PATTERN PLAY or SONG PLAY is currently selected

A-2 Specifications

Number of tones:	16 (PCM sound source × 12, sampled sounds × 4)
Sampling method:	LINE IN or MIC
Sampling period:	0.2 ~ 0.8 sec maximum per tone
Number of patterns:	100
Pattern input method:	REAL TIME RECORD, STEP RECORD
Number of songs:	20
AUTO COMPENSATE:	1/2, 1/4, 1/6, 1/8, 1/12, 1/16, 1/24, 1/32, 1/48, 1/96
BEAT:	1/2 ~ 99/16
Number of measures:	1 ~ 99/1 PATTERN
Editing functions:	COPY, CHAIN, DELETE, INSERT
Other:	ACCENT, MUTE, START/STOP, CONTINUE START, TEMPO (♩ = 40 ~ 250)
MT:	SAVE/VERIFY/LOAD
MIDI channel:	CH 1 ~ CH 16
NOTE:	ENA/DIS
CLOCK:	INT/EXT
Display:	16-character LCD (with back light)
Volume:	INSTRUMENT LEVEL 1 ~ 10, SAMPLING LEVEL, VOLUME(MASTER)
Tone control:	SAMPLE 1 ~ 4
Audio terminals:	LINE OUT 1 ~ 10, LEFT, RIGHT/MIX, LINE IN/MIC, PHONES Output impedance = 1kΩ/output voltage = 0.4V (RMS) max. Input impedance = 47kΩ/input sensitivity = 0.5mV
Control terminals:	MIDI IN, OUT, THRU, MT(SAVE/VERIFY/LOAD), FOOT SW
Power consumption:	17W
Dimensions:	430 × 292 × 75 mm
Weight:	3.7 kg
Accessories:	Sampled sound tape, MT connecting cord, plug cord set, AC power cord.

Model RZ-1 MIDI Implementation Chart

Version : 1

Function ...	Transmitted	Recognized DIS ENA	Remarks
Basic Default Channel Changed	BACK UP 1-16	BACK UP 1-16	Receive channel= Transmit channel
Mode Default Messages Altered	Mode 3 X *****	Mode 3 X X	Fixed
Note Number: True voice	36-62 *****	35-64	When receive is NOTE= ENA
Velocity Note ON Note OFF	○ 9n v=48,64,112	○ *9n v=1-127	*3 steps { 1-48: MUTE 49-96: NORMAL 97-127:ACCENT
After Key's Touch Ch's	X X	X X	
Pitch Bender	X	X	
Control Change	X	X	
Prog Change: True #	X *****	X	
System Exclusive	○	○	GLIDE ON/OFF
System : Song Pos Common : Song Sel : Tune	X ○	X ○	
System : Clock Real Time : Commands	○ ○	○ * ○	* When CLOCK=EXT
Aux : Local ON/OFF : All Notes OFF Mes- : Active Sense sages : Reset	X X X X	X X X X	
Notes			

Mode 1 : OMNI ON, POLY
Mode 3 : OMNI OFF, POLY

Mode 2 : OMNI ON, MONO
Mode 4 : OMNI OFF, MONO

○ : Yes
x : No