

ROAD RUNNER

Operators Manual
with Illustrated Parts Lists

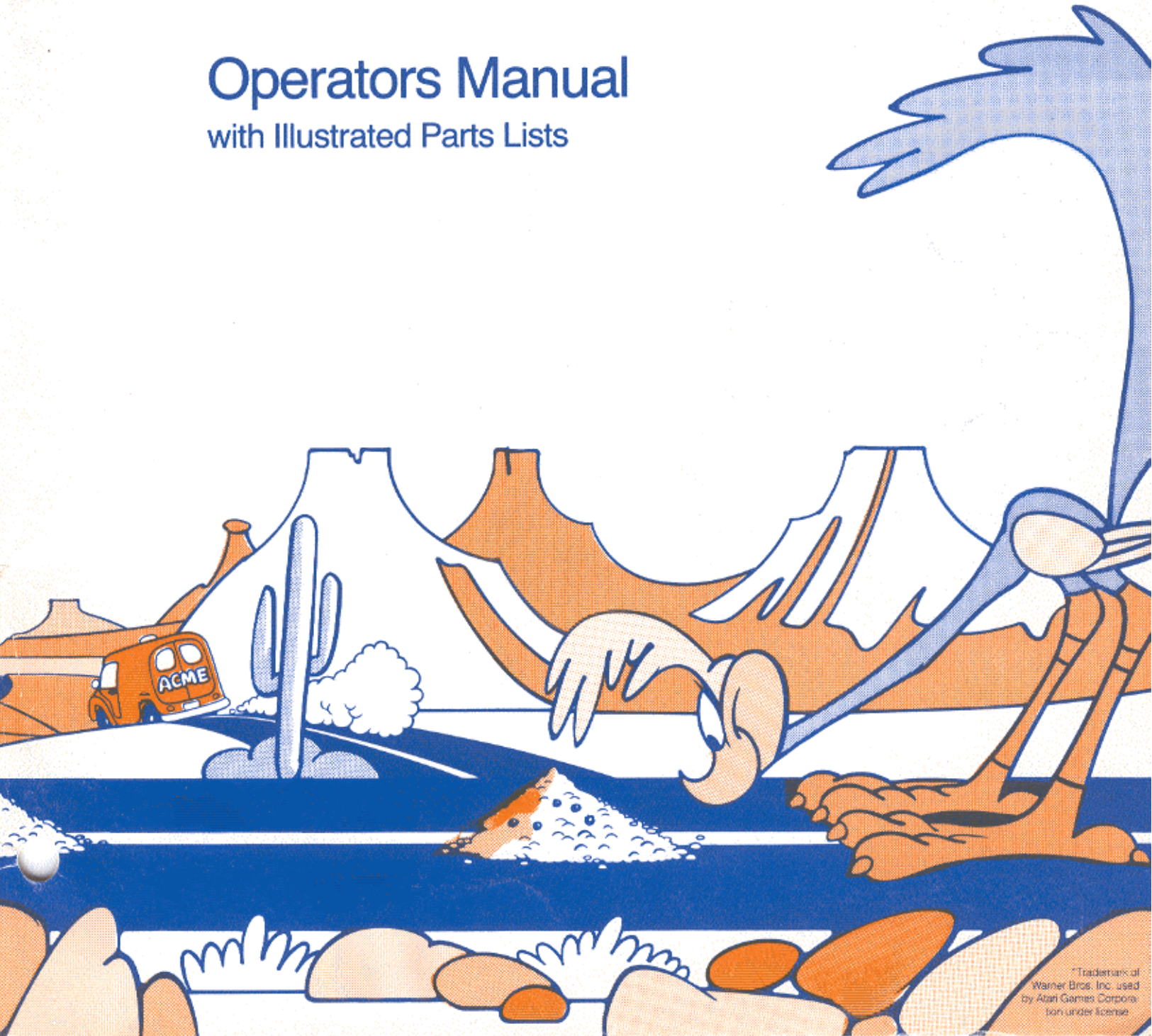

Atari Games Corporation Customer Service

If reading through this manual does not lead to solving a maintenance or repair problem, call TELEHELP® at one of these Atari Games Customer Service offices:

UNITED STATES

Parts and Service

Atari Games Corporation
California Customer Service Office
737 Sycamore Drive
P.O. Box 361110
Milpitas, CA 95035-1110
Telex 5101007850
(Monday–Friday, 7:30–4:00 pm Pacific Time)



(408) 434-3950

EUROPE

Parts and Service

Atari Games Corporation
European Customer Service Office
Tipperary Town, Ireland
Telex 28165
(Monday–Friday, 9:00–6:00 pm GMT)



062-52155

Road Runner* Operators Manual

with Illustrated Parts Lists



*Trademark of Warner Bros. Inc. used by Atari Games Corporation under license
TM Indicates Trademark of Warner Bros. Inc. © 1980

© 1986 by Atari Games Corporation

All rights reserved

No part of this publication may be reproduced by any mechanical, photographic, or electronic process, or in the form of a phonographic recording, nor may it be stored in a retrieval system, transmitted, or otherwise copied for public or private use, without permission from the publisher.

The game play, all graphic designs, this technical manual, its accompanying schematic diagrams, and the display manual are protected by the U.S. Copyright Act of 1976.

This Act provides for increased penalties for violating federal copyright laws. Courts *can impound* infringing articles while legal action is pending. If infringers are convicted, courts can *order destruction* of the infringing articles.

In addition, the Act provides for payment of statutory damages of up to \$250,000 in certain cases. Infringers may also have to pay costs and attorneys' fees and face an imprisonment of up to five years.

Atari Games Corporation will aggressively enforce its copyrights against any infringers. *We will use all legal means* to immediately halt any manufacture, distribution, or operation of a copy of video games made by us. Anyone who purchases such copies risks forfeiting such a game.

Published by: Atari Games Corporation
675 Sycamore Drive
P.O. Box 361110
Milpitas, California 95035

Printed in the U.S.A. 6Q

Notice Regarding Non-ATARI® Parts

▲ — WARNING — ▲

Use of non-ATARI parts or modifications of any ATARI game circuitry may adversely affect the safety of your game, and may cause injury to you and your players.

You may void the game warranty (printed on the inside back cover of this manual) if you do any of the following:

- Substitute non-ATARI parts in the game.
- Modify or alter any circuits in the game by using kits or parts *not* supplied by Atari Games Corporation.

NOTE

This equipment generates, uses, and can radiate radio frequency energy and if not installed and used in accordance with the instruction manual, may cause interference to radio communications. It has been tested and found to comply with the limits for a Class A computing device pursuant to Subpart J of Part 15 of Federal Communications Commission (FCC) Rules, which are designed to provide reasonable protection against such interference when operated in a commercial environment. Operation of this equipment in a residential area or modification to this equipment is likely to cause interference in which case the user, at his own expense, will be required to take whatever measures may be required to correct the interference. If you suspect interference from an ATARI® game at your location, check the following:

- All green ground wires in the game are properly connected as shown in the game wiring diagram.
- The power cord is properly plugged into a grounded three-wire outlet.
- The game printed-circuit boards (PCBs) are properly installed with the Electromagnetic Interference (EMI) ground plane.

If you are still unable to solve the interference problem, please contact Customer Service at Atari Games Corporation. See the inside front cover of this manual for service in your area.

Table of Contents

1	Installation	
	Vend-A-Ticket Kit Option	1-1
	How to Use This Manual	1-1
	Introduction	1-3
	Kit Parts Inventory	1-3
	Tools Required	1-3
	Conversion Instructions	1-3
	Setting the Coin and Game Options	1-5
	Operator Hints	1-5
2	Self-Test	
	RAM/ROM Test	2-2
	Switch Test	2-2
	Coin Options	2-2
	Game Options	2-3
	Statistics	2-3
	Histograms	2-4
	Playfield Test	2-5
	Motion Object Test	2-5
	Motion Object Height Test	2-5
	Alphanumerics Test	2-5
	Color Test	2-5
	Color Purity Test	2-6
	Convergence Test	2-6
	Sound Test	2-7
	Joystick Test	2-7
	Calibration Procedure	2-7
3	Maintenance	
	Preventive Maintenance	3-2
	Removing the Control Panel	3-2
	Cleaning the Pushbutton Leaf Switches	3-2
	Lubricating the Joystick	3-2
	Corrective Maintenance	3-3
	Removing the Pushbutton Leaf Switches	3-3
	Removing the Joystick	3-3
	Disassembling the Joystick	3-6
	Reassembling the Joystick	3-6
4	Game Play	
	Introduction	4-1
	Attract Mode	4-1
	Unique Features to Attract Players	4-2
	Play Mode	4-2
	High Score Mode	4-3
	Maximizing Earnings	4-3
	Self-Test Mode	4-5
5	Illustrated Parts List	
	See List of Illustrations that follows.	

List of Illustrations

Figure 1-1	Conversion Kit Part Locations	1-2
Figure 1-2	Attraction Film Replacement	1-4
Figure 1-3	Control Panel Replacement	1-4
Figure 1-4	Cartridge PCB Replacement	1-6
Figure 2-1	ROM Test Fails	2-2
Figure 2-2	RAM Test Fails	2-2
Figure 2-3	Switch Test	2-2
Figure 2-4	Coin Options	2-3
Figure 2-5	Game Options	2-3
Figure 2-6	Statistics	2-4
Figure 2-7	Histograms	2-4
Figure 2-8	Playfield Test	2-5
Figure 2-9	Motion Object Test	2-5
Figure 2-10	Motion Object Height Test	2-5
Figure 2-11	Alphanumerics Test	2-6
Figure 2-12	Color Test	2-6
Figure 2-13	Color Purity Test	2-6
Figure 2-14	Convergence Test	2-6
Figure 2-15	Sound Test	2-7
Figure 2-16	Joystick Test	2-7
Figure 3-1	Removing the Control Panel	3-3
Figure 3-2	Removing the Joystick and Pushbutton Leaf Switches	3-4
Figure 3-3	Joystick Disassembly and Lubrication	3-5
Figure 5-1	Control Panel Assembly	5-2
Figure 5-2	Hall-Effect Joystick Assembly	5-4
Figure 5-3	LSI Cartridge 3 PCB Assembly	5-6

List of Tables

Table 1-1	Kit Parts Inventory	1-3
Table 2-1	Faulty ROM Locations	2-2
Table 2-2	Coin Option Settings	2-3
Table 2-3	Game Option Settings	2-4
Table 4-1	Typical One-Week Road Runner Statistics	4-4
Table 4-2	Game Bonus Option Settings	4-5

Safety Summary

The following safety precautions apply to all game operators and service personnel. Specific warnings and cautions will be found throughout this manual where they apply.

▲ WARNING ▲

Properly Ground the Game. Players may receive an electrical shock if this game is not properly grounded! To avoid electrical shock, do not plug in the game until it has been inspected and properly grounded. This game should only be plugged into a grounded three-wire outlet. If you have only a 2-wire outlet, we recommend you hire a licensed electrician to install a grounded outlet. Players may receive an electrical shock if the control panel is not properly grounded! After servicing any parts on the control panel, check that the grounding wire is firmly secured to the inside of the control panel. Only then should you lock up the game.

AC Power Connection. Before connecting the game to the AC power source, verify that the game's power supply is properly configured for the line voltage in your location.

Disconnect Power During Repairs. To avoid electrical shock, disconnect the game from the AC power source before removing or repairing any part of the game. When removing or repairing the video display, extra precautions must be taken to avoid electrical shock because high voltages may exist within the display circuitry and cathode-ray tube (CRT) even after power has been disconnected. Do not touch internal parts of the display with your hands or with metal objects! Always discharge the high voltage from the CRT before servicing this area of the game. To discharge the CRT: Attach one end of a large, well-insulated, 18-gauge jumper wire to ground. Momentarily touch the free end of the grounded jumper to the CRT anode by sliding it under the anode cap. Wait two minutes and discharge the anode again.

Use Only ATARI Parts. To maintain the safety integrity of your ATARI game, do not use non-ATARI parts when repairing the game. Use of non-ATARI parts or other modifications to the game circuitry may adversely affect the safety of your game, and injure you or your players.

Handle the CRT With Care. If you drop the CRT and it breaks, it may implode! Shattered glass can fly six feet or more from the implosion.

Use the Proper Fuses. To avoid electrical shock, use replacement fuses which are specified in the parts list for this game. Replacement fuses must match those replaced in fuse type, voltage rating, and current rating. In addition, the fuse cover must be in place during game operation.

CAUTION

Properly Attach All Connectors. Make sure that the connectors on each printed-circuit board (PCB) are properly plugged in. Note that they are keyed to fit only one way. If they do not slip on easily, do not force them. A reversed connector may damage your game and void the warranty.

Ensure the Proper AC Line Frequency. Video games manufactured for operation on 60 Hz line power (i.e., United States) must not be operated in countries with 50 Hz line power (i.e., Europe). The fluorescent light ballast transformer will overheat, causing a potential fire hazard if 60 Hz games are operated on power lines using 50 Hz. Check the product identification label of your game for the line frequency required.

Installation

Vend-A-Ticket Kit Option

A ticket dispensing capability, the Vend-A-Ticket Kit option, has been added to the Road Runner* game software for increased player appeal and maximum earnings. Redemption equipment offers players a tangible reward for their playing skills and can enhance the long-term challenge and interest in a game.

By adding the Vend-A-Ticket Kit to your game, players see a yellow "Win" ticket appearing randomly on each level in the game. Skill is required to collect tickets since each ticket appears on the screen for only a few seconds. If the player reaches the displayed ticket picture before it disappears, an actual ticket is dispensed. Operators can adjust payout percentages by selecting options for a maximum number of tickets per game.

To add player incentive and new playing strategies to your Road Runner game, contact your nearest Atari Games Customer Service Office for more information regarding the Vend-A-Ticket Kit.

How to Use This Manual

This manual is written for game operators and service technicians and describes how to install, test, and maintain your Road Runner game.

Your Road Runner game uses the Atari Games System I™ cabinet, which is designed to accept the necessary hardware to easily convert the System I cabinet into a variety of games. Consequently, this manual contains information that applies to those parts of your existing System I cabinet that are added or replaced to convert the cabinet for the Road Runner game. (See Figure 1-1.) Information that applies to those parts of the System I cabinet that are common to all games is contained in a separate *System I Operators Manual* (TM-286), included with your System I cabinet. Where applicable, references are provided in this manual to the *System I Operators Manual*.

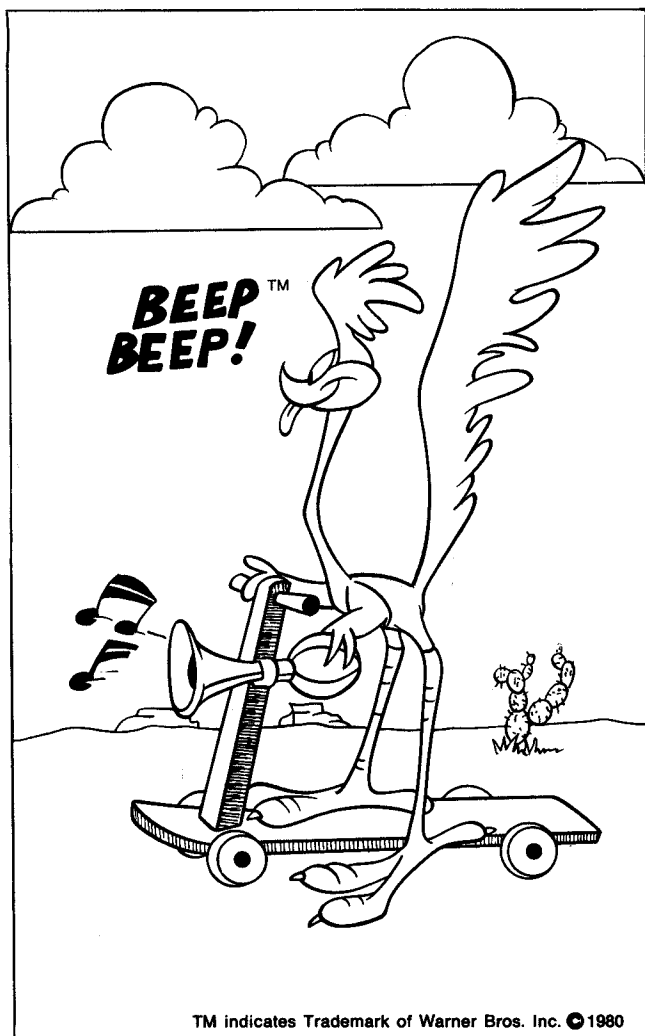

TM indicates Trademark of Warner Bros. Inc. © 1980

*Trademark of Warner Bros. Inc. used by Atari Games Corporation under license

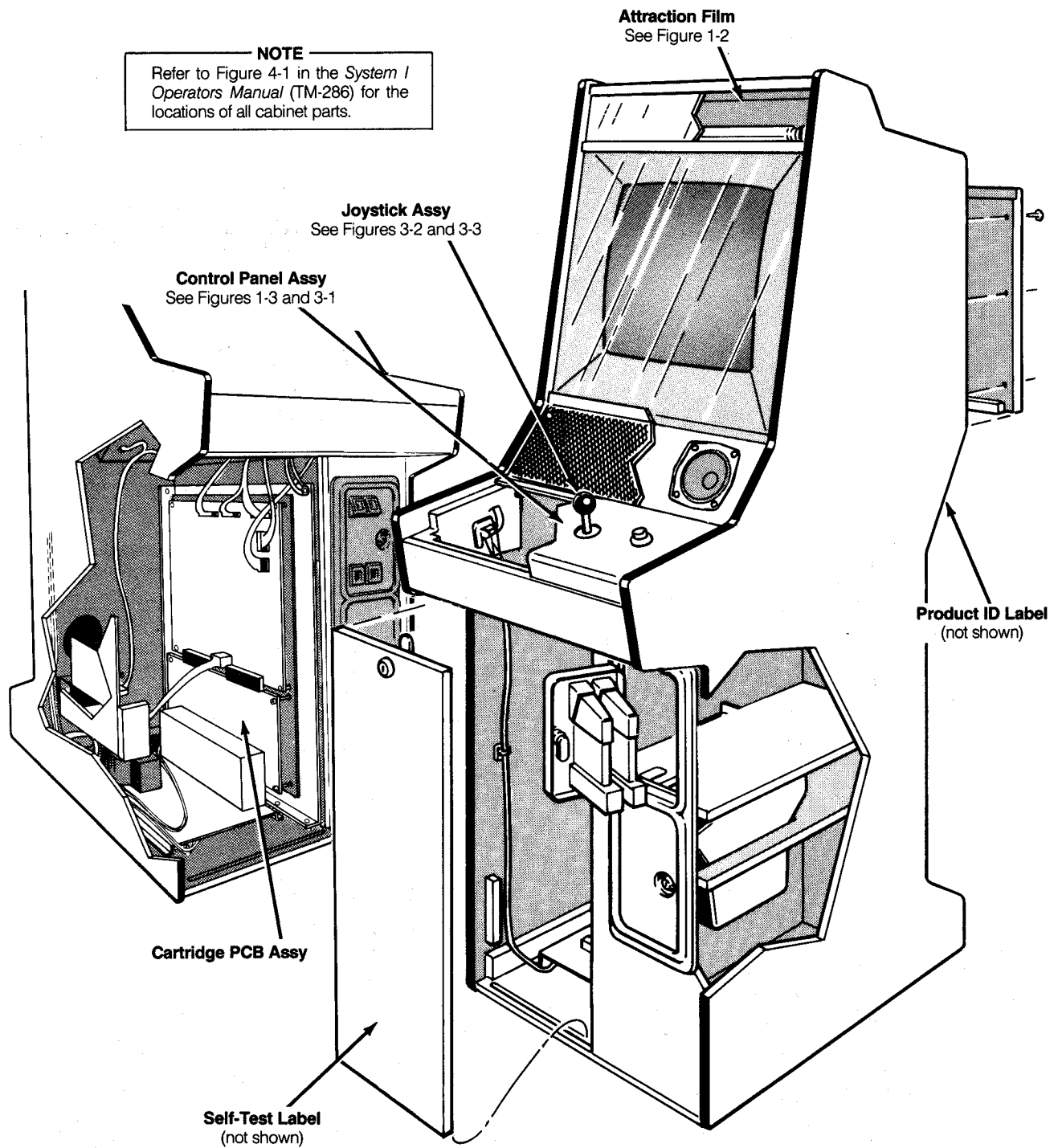

Figure 1-1 Conversion Kit Part Locations

This manual contains the following information on the Road Runner game:

- Chapter 1 provides a kit parts inventory, conversion instructions, inspection procedures, and option setting information.
- Chapter 2 provides self-test procedures, including procedures for setting the coin and game options.
- Chapter 3 provides maintenance information for the Joystick Assembly and the player start switches.
- Chapter 4 provides game play information.
- Chapter 5 provides illustrated parts lists for the Control Panel Assembly, Joystick Assembly, and Road Runner Cartridge Printed-Circuit Board (PCB).

Wiring and schematic diagrams for the Road Runner control panel and Cartridge PCB are contained in the SP-285 Schematic Package Supplement included with this manual. Refer to the Schematic Package Supplement included with the *System I Operators Manual* for the wiring and schematic diagrams that apply to the System I cabinet hardware.

Introduction

This chapter includes the instructions necessary for converting your existing System I game into a Road Runner game. The conversion instructions include: (1) removing the existing attraction film, control panel, and Cartridge Printed-Circuit Board (PCB); and (2) installing a Road Runner attraction film, Cartridge PCB, and control panel. Refer to Figure 1-1 for the locations of the parts of the System I cabinet that are replaced.

Kit Parts Inventory

The assemblies listed in Table 1-1 are included in the Road Runner Conversion Kit. Refer to Chapter 5, Illustrated Parts Lists, for a description of the component parts comprising the control panel and Cartridge PCB assemblies listed in Table 1-1.

Tools Required

The only tools required to perform a complete Road Runner conversion are a Phillips screwdriver, and a 1/8-inch hex driver.

Conversion Instructions

WARNING

To avoid electrical shock, unplug the game before performing the conversion procedures.

**Table 1-1 Kit Parts Inventory
A043476-xx**

Part No.	Quantity	Description
A043477-01	1	Control Panel Assembly
A043486-01	1	Cartridge PCB Assembly
038158-01	1	Product Identification Label
043187-01	1	Horizontal Bezel (optional). For games originally fitted with a horizontal bezel
043479-01	1	Attraction Film
SP-285	1	Road Runner Schematic Package Supplement
ST-285	1	Road Runner Self-Test Label
TM-285	1	Road Runner Operators Manual

NOTE

The following conversion should be performed by qualified service personnel.

The following procedures are arranged in the sequence recommended for performing the game conversion. The parts of your cabinet that are affected by the conversion are removed first and then replaced by the new Road Runner kit parts.

Replace the Attraction Film

Perform the following procedure to remove/replace the existing attraction film with the Road Runner attraction film. (See Figure 1-2.)

1. Turn off the game power.
2. Use a 1/8-inch hex driver to remove the three screws and washers holding the upper retainer to the top of the cabinet.
3. Grasp the top edge of the existing attraction film behind the attraction shield and slide it up to remove it.
4. Install the Road Runner attraction film. Make sure the film is fully inserted into the bottom slot.
5. Replace the upper retainer.

Replace the Control Panel

Perform the following procedure to remove/replace the existing control panel with the Road Runner control panel. (See Figure 1-3.)

1. Unlock and open the coin door on the front of the cabinet.

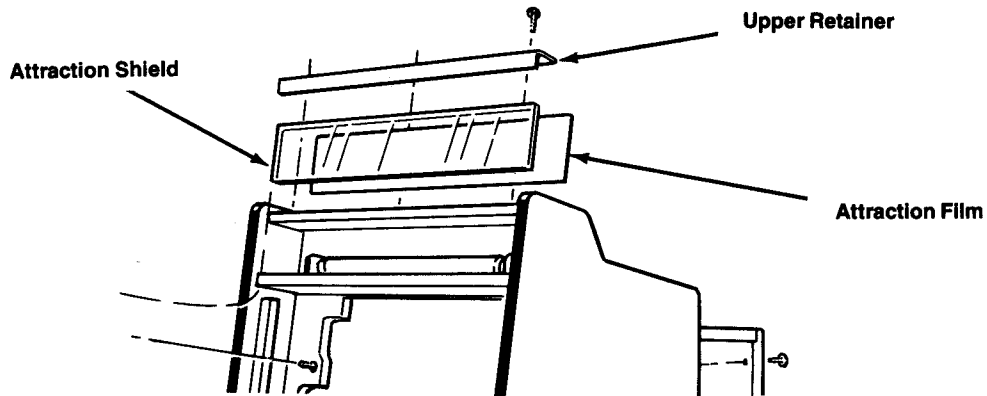

Figure 1-2 Attraction Film Replacement

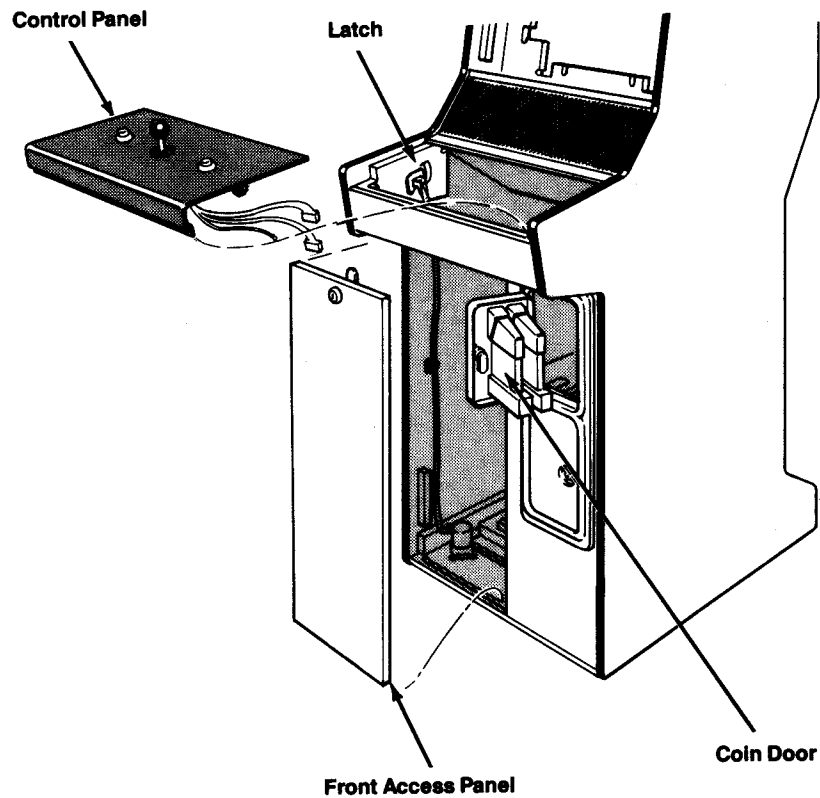

Figure 1-3 Control Panel Replacement

2. Carefully reach through the coin door opening and release the spring-draw latch located under the control panel on the right side of the cabinet.
3. Unlock and remove the front access panel.
4. Reach through the front access-panel opening and disconnect the control panel harness from the top of the Main PCB.
5. Carefully reach up under the top of the front access-panel opening and release the spring-draw latch lo-

- cated under the control panel on the left side of the cabinet.
- From underneath, push up on the front edge of the control panel to free the panel from the slot in the cabinet.
 - Disconnect the green ground wire from the control panel harness and remove the control panel from the cabinet.
 - Install the Road Runner control panel in the reverse order of removal. See Figure 3-1 for the proper control-panel harness connections to the Main PCB. Make sure the green ground wire is connected to the control panel harness.

Replace the Cartridge PCB

Perform the following procedure to remove/replace the existing game Cartridge PCB and replace with the Road Runner Cartridge PCB. (See Figure 1-4.)

- Turn the cabinet power off.
- Unlock and remove the front access panel from the cabinet.
- Turn the four thumbscrews that hold the existing Cartridge PCB to the ground plane. (Some System I games might have Phillips screws.)
- Gently disconnect the Cartridge PCB from the Main PCB.
- Connect the Road Runner Cartridge PCB to the Main PCB. Make sure that the Cartridge PCB is fully inserted into the Main PCB edge connectors.
- Replace the four thumbscrews on the Cartridge PCB. See Figure 1-4 for the locations of the printed-circuit boards. In order for this game to comply with Federal Communication Commission regulations, these thumbscrews must be tight. The Cartridge PCB must be securely connected to the ground plane.

NOTE

The procedure for removing the Main PCB is included in the Maintenance chapter of the *System I Operators Manual*.

Install the Self-Test Label

Staple or tape the Road Runner self-test label on the inside of the front access panel.

Install the Product Identification Label

Perform the following procedure to install the Road Runner product identification label.

- Remove the protective backing from the Road Runner product identification label.

- Place the Road Runner product identification label over the existing product identification label on the back of the cabinet.

Inspect the Game

Before applying power, perform the following inspection procedure.

- Carefully check that the Road Runner conversion kit parts have been properly installed. Make sure the control-panel harness connector is tightly connected and that the spring-draw latches under the control panel are securely fastened.
- Plug in the game power.
- Perform the self-test procedure as given in Chapter 2 of this manual. If the self-test indicates that the video display requires adjustment, perform the adjustment procedures described in the video display manual included with your game.
- Close and lock the front access panel.

Setting the Coin and Game Options

The Road Runner coin and game options are set in the Self-Test Mode. Refer to Chapter 2 for the recommended settings and the procedure for setting the options.

Operator Hints

Your System I cabinet with the Road Runner game uses more effective audio than previous games and results in more player involvement and enjoyment. The System I games use advanced, digital, sound-generation techniques to create realistic musical instrument sounds (such as clarinets, harmonicas, drums, and violins). Although a player may not be consciously aware of the music, it has a direct effect on the excitement and emotional experience of the game.

The Road Runner game creates ear-catching sound effects, which are designed to give feedback to make the player believe that the game is responding directly to his actions. To maximize the player's enjoyment of this enhanced audio, we are providing some hints for the operator:

- The game location should be a relatively dead acoustical environment. The goal is to minimize unnecessary sound reflection, so that the sounds from the Road Runner game won't be drowned out by the accumulation of other sounds that bounce around the room. Carpets help eliminate sound reflections from the floor. Acoustical tile is also useful, especially if you have low ceilings.
- If you use an environmental sound system or a stereo, consider lowering its volume or perhaps even turning it off. In the days when video games just made harsh beeps and boops, a central sound system helped make up for the lack of drive and excitement in a game's sounds. But your Road Runner game is very musical,

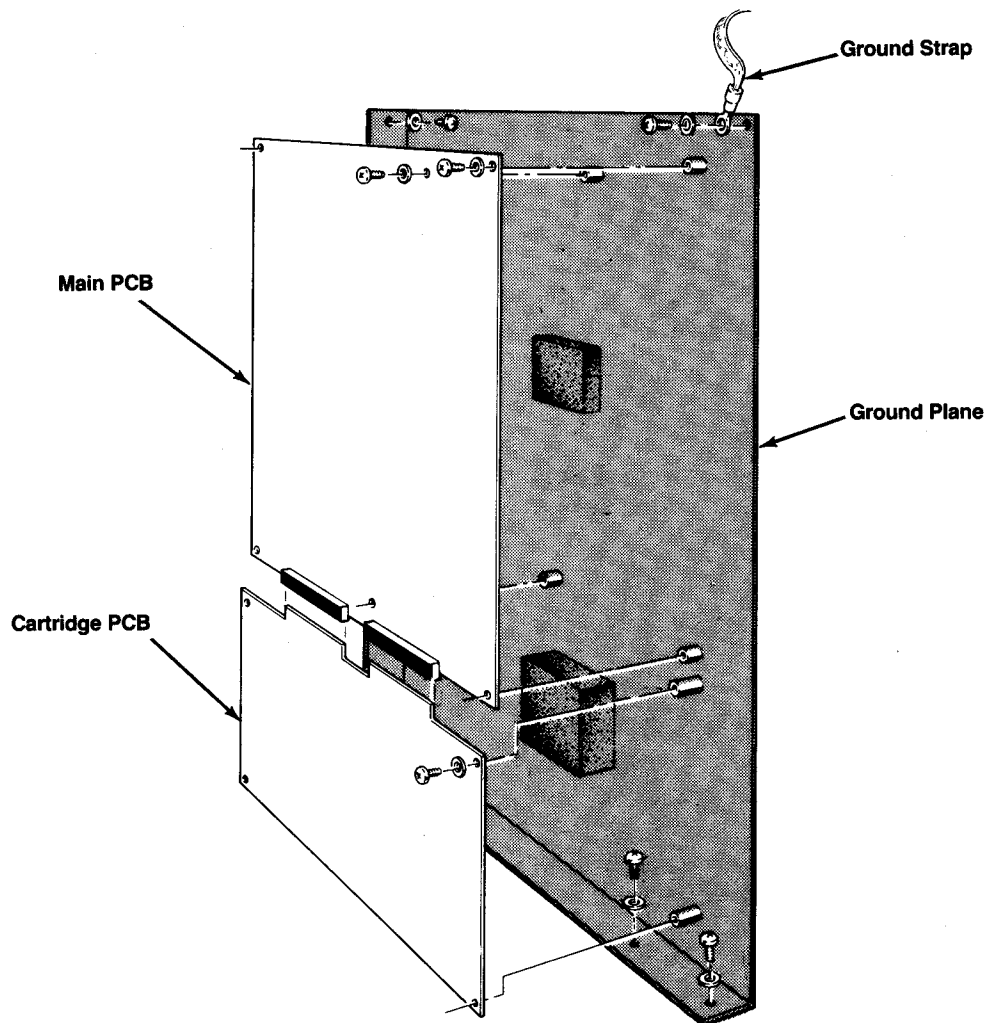

Figure 1-4 Cartridge PCB Replacement

and a sound system interferes with the game's ability to interest players and draw bystanders.

3. Be concerned with the overall volume levels in arcade environments. The goal is to involve the players' emotions, not to damage their hearing. To a certain point, raising the game volume helps add to player excitement, but above that level it creates hearing fatigue and the high volume starts to drive players away.

Rather than turning up the volume on the Road Runner games to cut through the background sound level, try lowering the volume of any neighboring games that have sounds which are not an attractive or important element. Careful placement of games and attention to unnecessary noise sources can also help increase the player's sense of game involvement and interaction.

Chapter 2

Self-Test

After the self-test switch is turned on, 16 self-test screens provide a visual and audible check of the Road Runner* game circuits. Refer to Chapter 1 in the *System I Operators Manual* (TM-286) for the location of the self-test switch.

When the self-test switch is turned on, and the power is then turned on, the game enters the full Self-Test Mode. If the self-test switch is turned on while pressing the 2-player start button, the game will enter a shorter Self-Test Mode. The following self-test screens are arranged in the sequence in which they occur after the self-test switch is first turned on. After the Joystick Test, the sequence starts over with the Switch Test. Turning the self-test switch off at any time during the Self-Test Mode causes the game to return to the Attract Mode.

NOTE

During any of the self-tests, press the 1-player start button to advance to the next screen.



* Trademark of Warner Bros. Inc. used by Atari Games Corporation under license

RAM/ROM Test

The RAM/ROM Test screens are shown in Figures 2-1 and 2-2. These tests provide a visual check of the game RAM, ROM, and associated circuitry. If the RAM and ROM test passes, the display advances to the Switch Test.

The RAM/ROM Test is divided into two sections. The condition of the RAM circuitry is displayed in the bottom half of the screen and, after about an eight-second delay, the condition of the ROM circuitry is displayed in the top half of the screen. An error message indicates that the RAM, ROM, or associated circuitry may be faulty.

If the ROM test fails, an error message appears in the top half of the screen as shown in Figure 2-1. Refer to Table 2-1 for the faulty ROM locations.

If the upper or lower main memory ROM circuits on the Main PCB fail, an *Upper or Lower Main ROM Error* message appears at the top of the screen. Press the 1-player start button to obtain any RAM or ROM error message(s)

Table 2-1 Faulty ROM Locations

Error Message	Location
ROM at 10000 error	U = 13E L = 13D
ROM at 18000 error	U = 14E L = 14D
ROM at 20000 error	U = 15E L = 15D

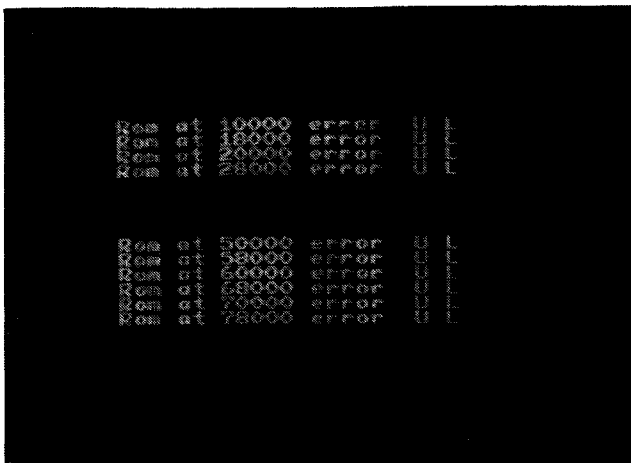

Figure 2-1 ROM Test Fails

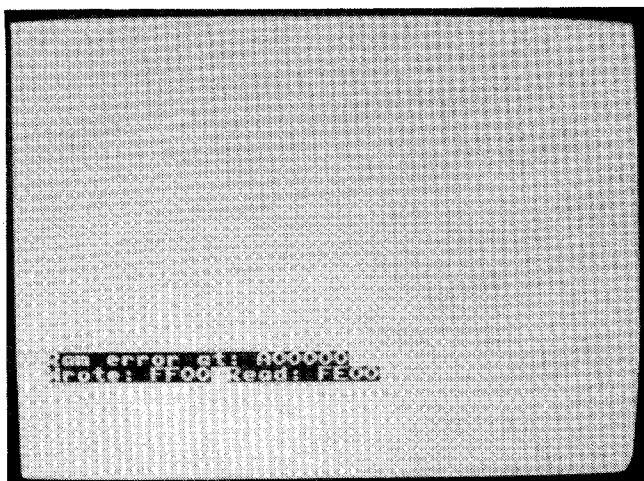

Figure 2-2 RAM Test Fails



Figure 2-3 Switch Test

from the Cartridge PCB RAM or ROM circuits. Press the 1-player start button again. If the bank switch ROM circuits on the Cartridge PCB are faulty, the message *Bank Switch Error* will appear.

If the RAM test fails, the error messages appear as shown in Figure 2-2. Refer to the memory maps and schematic diagrams in the schematic package supplements for this manual and for the *System I Operators Manual* to determine the location of the faulty RAM circuit.

Repair the faulty RAM or ROM circuit or press the 1-player start button to obtain the Switch Test.

Switch Test

The Switch Test screen is shown in Figure 2-3. This test indicates the condition of the 2-player start pushbutton switch. Press the 2-player start button, and note that the first number changes to a 1. Press the 1-player start button to obtain the next screen.

Coin Options

The Coin Options screen is shown in Figure 2-4. This screen indicates the current coin option settings and is used to change these settings. Refer to Table 2-2 for the available and recommended settings.

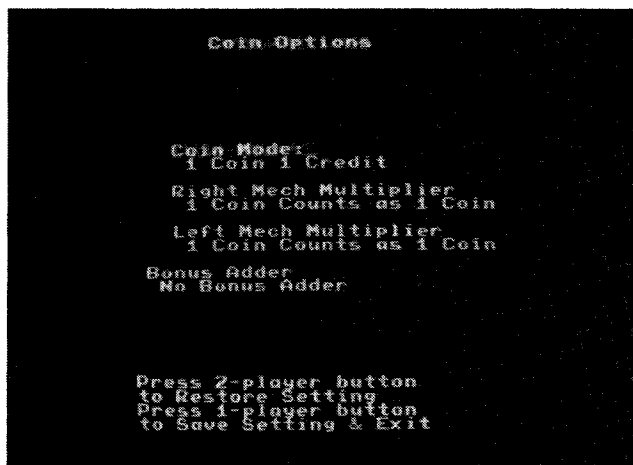

Figure 2-4 Coin Options

Table 2-2 Coin Option Settings

Option Name	Available Settings
Credit Mode	1 Coin 1 Credit ◀ 2 Coins 1 Credit 3 Coins 1 Credit 4 Coins 1 Credit
Right Mech Multiplier	1 Coin Counts as 1 Coin ◀ 1 Coin Counts as 4 Coins 1 Coin Counts as 5 Coins 1 Coin Counts as 6 Coins
Left Mech Multiplier	1 Coin Counts as 1 Coin ◀ 1 Coin Counts as 2 Coins
Bonus Adder	No Bonus Adder ◀ 2 Coins Give 1 Extra Coin 4 Coins Give 1 Extra Coin 4 Coins Give 2 Extra Coins 5 Coins Give 1 Extra Coin 3 Coins Give 1 Extra Coin Free Play

◀ *Manufacturer's recommended settings.*

NOTE

If you wish to try other than factory-recommended options, first change the *Restore Factory Options* setting to *no*.

Coin Mode should have a red box around it. Move the joystick right or left, and note that the coin mode values change. Select the desired value. Move the joystick down to move the red box to *Right Mech Multiplier*. Move the joystick right or left to cycle through all the available multiplier values. Select the desired value. Repeat this procedure for the remaining options.

If you wish to cancel the option changes and restore the original settings, press the 2-player start button.

Press the 1-player start button to set the selected coin options and to obtain the next screen.

Game Options

The Game Options screen is shown in Figure 2-5. This screen indicates the current game option settings and is used to reset the high score table and to change the game option settings. Refer to Table 2-3 for the available options and the default (recommended) settings. Note that the recommended settings are highlighted in green.

Move the joystick right or left and note that the settings for the option in the shaded block change. Select the desired value. Move the joystick up or down to move the desired option into the shaded block. Move the joystick right or left to cycle through all the available game option settings and select the desired value. Repeat this procedure for the remaining options.

If you want to cancel the option changes and restore the original settings, press the 2-player start button.

Press the 1-player start button to set the selected game options and to obtain the next screen.

Statistics

The Statistics screen is shown in Figure 2-6. This screen provides a visual check of the current game statistics. The statistics information is accumulated either from the first time the game was turned on or from the last time the statistics were reset. To reset the statistics information, press the 2-player start button.

The following information appears on the Statistics screen:

- *Aux coins* is not used in the Road Runner game.

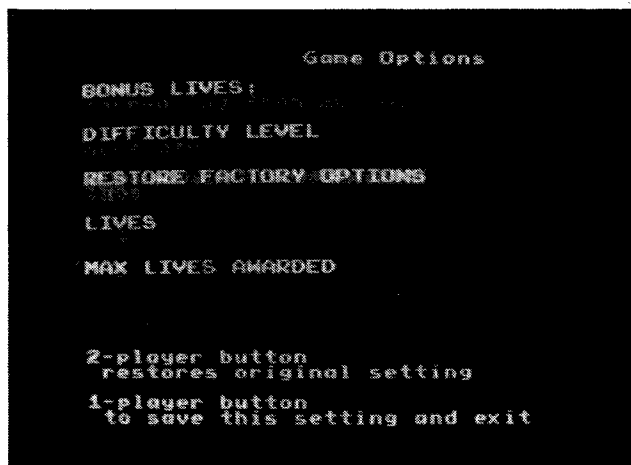

Figure 2-5 Game Options



Figure 2-6 Statistics

- *Left coins* shows the number of coins deposited in the left coin mechanism.
- *Right coins* shows the number of coins deposited in the right coin mechanism.
- *1 plyr Games* shows the number of 1-player games.
- *2 plyr Games* shows the number of 2-player games.
- *Mins played* shows the total time, in minutes, of all the games played.
- *Mins pwr up* shows the total time, in minutes, that the game has been turned on.
- *Aux. cntr 1* shows the total number of times the game continuation feature was used.
- *Aux. cntr 2* shows the total number of tickets dispensed.
- *Aux. cntr 3* is for manufacturing use only.
- *Error count* shows the number of EEPROM errors that were detected. Replace the EEPROM at location 15F on the Main PCB if the errors detected exceed approximately 75 per week.
- *Avg. Game Time* shows the average game time per play in seconds.

Press the 1-player start button to obtain the next screen.

Histograms

There are seven Histogram screens. One screen is shown in Figure 2-7. The screens are selected by pressing the 1-player start button. Each screen shows the lengths of the games from 0 to 540 or more seconds and the total number of players. The high score for each level is also displayed.

The Histograms for Levels 1 through 4 show the number of games that ended at that level (1-4). These are only games that were played without using the game continuation feature. The Histogram for Level 5 shows the number of games that ended on level 5 or above, for games not using the game continuation feature. The Histogram

Table 2-3 Game Option Settings

Option Name	Available Settings
Bonus Lives*	Increasing from 10,000 points Increasing from 20,000 points ◀ Increasing from 30,000 points Increasing from 50,000 points None Every 30,000 points Every 40,000 points Every 50,000 points
Difficulty Level	Easy Moderate ◀ Hard Hardest
Restore Factory Options	Yes ◀ No
Lives	3, 4 ◀, 5, 6
Max Lives Awarded	3, 5 ◀, 8, 10
Demo/Play Mode	Playable Game Mode ◀ Demonstration Only Mode
Ticket Dispenser—Max Per Game	None ◀, 2, 4, 6, 8, 10, 12, 14
Music in Attract	Yes ◀ No
Clear High Score Table	No ◀ Yes

◀ *Manufacturer's recommended settings.*

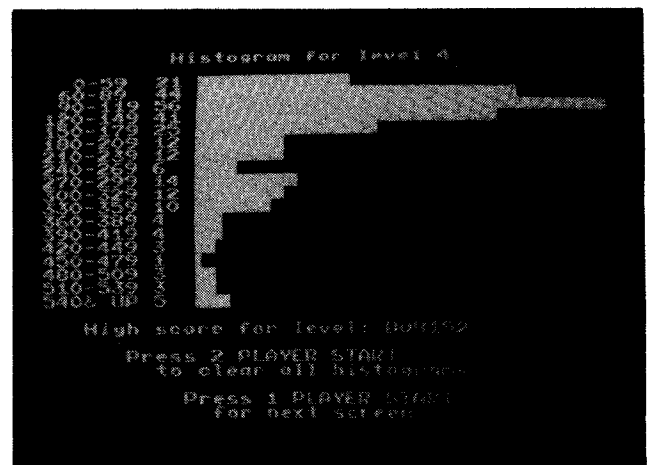

Figure 2-7 Histograms

for Level 6 shows the number of games that ended on the same level where they started. These are only games that were played using the game continuation feature. The Histogram for Level 7 shows the number of games that progressed to a higher level than the starting level, for games using the game continuation feature.

The game times information is accumulated either from the first time the game was turned on or from the last time

the game times were reset. To reset the Histograms, press the 2-player start button while displaying the Histogram for Level 7 screen.

Press the 1-player start button to obtain the next screen.

Playfield Test

The Playfield Test screen is shown in Figure 2-8. This screen indicates the condition of some of the graphics ROM, the vertical and horizontal playfield scrolling registers, and the joystick control.

Move the joystick to the left, and the playfield should slowly scroll to the left. Move the joystick up, and the playfield should scroll up—likewise for right and down.

Press the 1-player start button to obtain the next screen.

Motion Object Test

The Motion Object Test screen is shown in Figure 2-9. This test indicates the condition of the motion-object buffer circuit. The seven groups of eight motion objects should be identical and eight pixels high.

Press the 2-player start button to select any of the 56 motion objects. If the joystick is moved, the selected motion object should move in the same direction.

Press the 1-player start button to obtain the next screen.

Motion Object Height Test

The Motion Object Height Test screen is shown in Figure 2-10. This test indicates the condition of the motion object/playfield graphic address generator circuit.

Each successive column of motion objects should be eight pixels taller than the last. The top eight pixels of all the columns should be the same. The top 16 pixels of all the columns that are at least 16 pixels high should be the same. Each column should add a new 8×8 pixel stamp

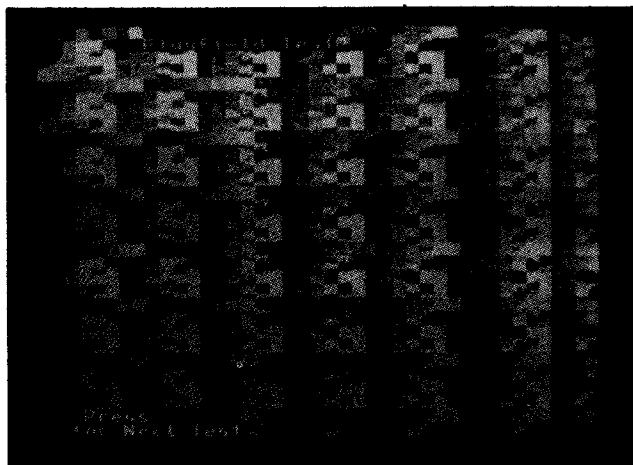

Figure 2-8 Playfield Test

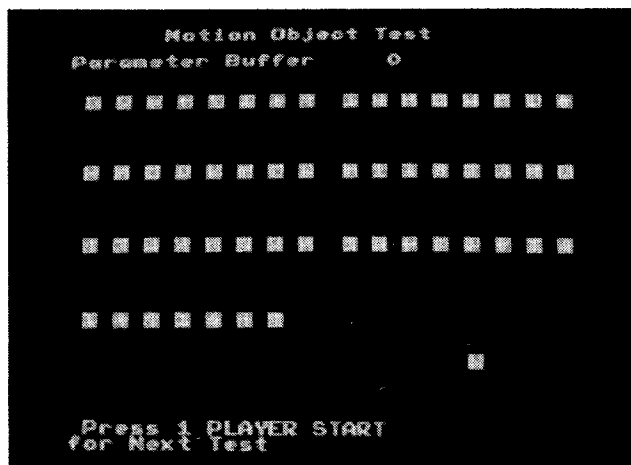

Figure 2-9 Motion Object Test

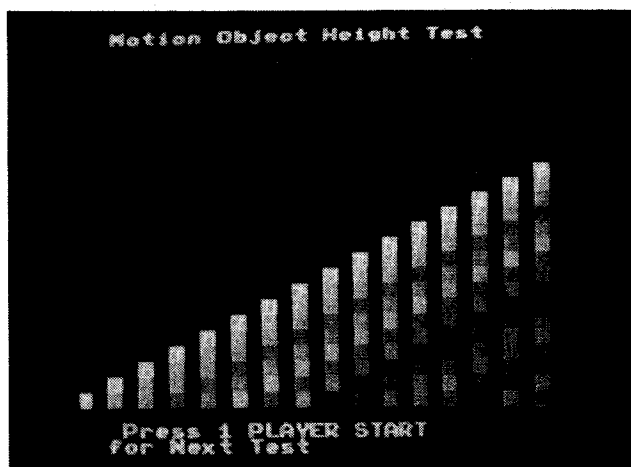

Figure 2-10 Motion Object Height Test

picture to the bottom and slide the old picture up by eight pixels.

Press the 1-player start button to obtain the next screen.

Alphanumeric Test

The Alphanumeric Test screen is shown in Figure 2-11. This test indicates the condition of the alphanumeric circuit.

Press the 1-player start button to obtain the next screen.

Color Test

The Color Test screen is shown in Figure 2-12. This test indicates the condition of the display color circuits.

There should be eight vertical gray-scale bars and three groups of eight horizontal bars with shades of red, green, and blue. The brightest bars should be on the left, and the darkest (black) bars should be on the right with a bright

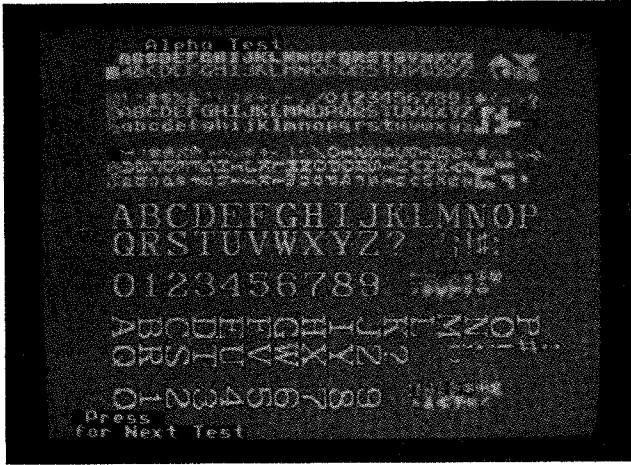

Figure 2-11 Alphanumeric Test

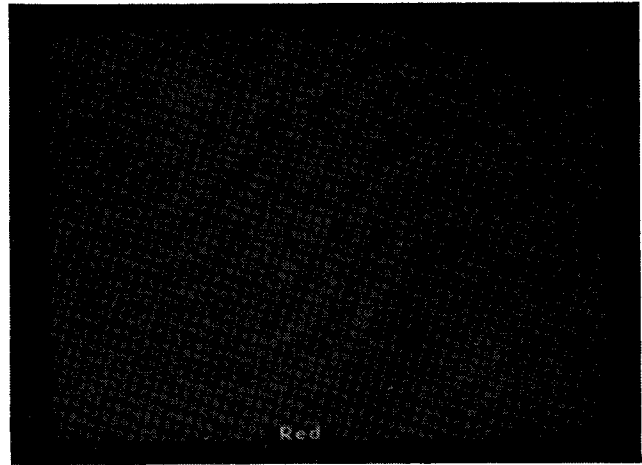

Figure 2-13 Color Purity Test

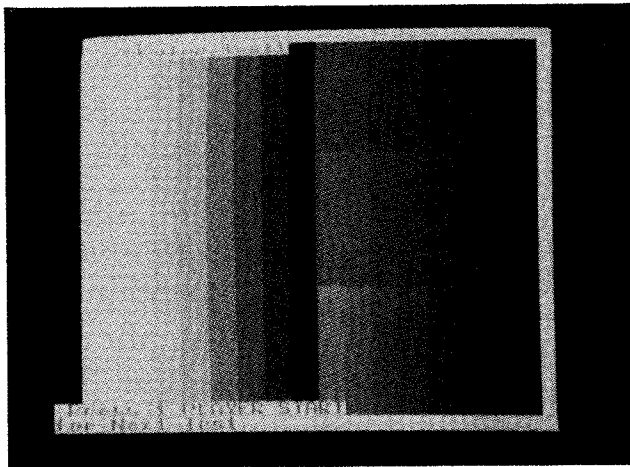

Figure 2-12 Color Test

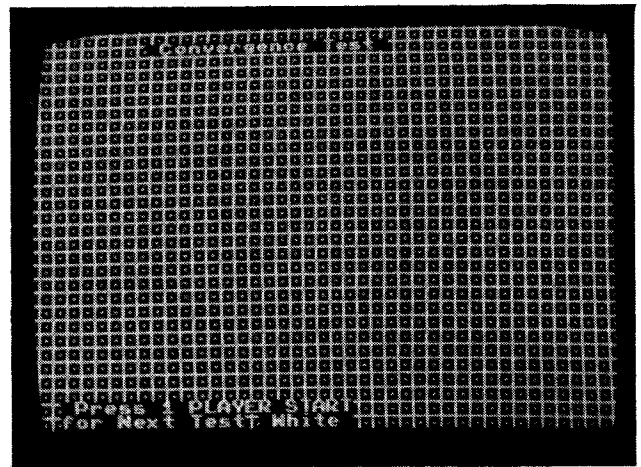

Figure 2-14 Convergence Test

white frame around the screen. This frame will help to identify the darkest color band. If the display characteristics are not correct, refer to the display manual for the color-gun adjustment procedure or to determine the possible cause of failure.

Press the 1-player start button to obtain the next screen.

Color Purity Test

The Color Purity Test consists of five color displays that indicate the condition of the display color-purity circuits. The first display to appear should be a red screen with the word *RED* displayed at the bottom of the screen as shown in Figure 2-13.

Press the 2-player start button and the next display to appear should be green with the word *GREEN* displayed at the bottom of the screen. Press the 2-player start button to obtain a blue, white, and finally a gray screen. After the gray screen the software repeats the cycle, beginning with the red screen.

If the display characteristics are not correct, refer to the video display manual for the color-purity adjustment procedure or the possible cause of failure.

Press the 1-player start button to obtain the next screen.

Convergence Test

The Convergence Test screen is shown in Figure 2-14. This test indicates the condition of the display size, centering, linearity, and convergence. The grid pattern should be white.

Press the 2-player start button, and the pattern should turn violet. Repeated pressing of the 2-player button should cause the screen to alternate between violet and white. Check the grid pattern for the following characteristics (the violet and white patterns are used to adjust the display convergence):

- The four corners of the frame around the grid pattern should touch all four corners of the screen.

- Grid lines should exhibit no pincushioning or barreling, and the lines should be straight within 3 mm.
- Violet and white pattern convergence should be within 2 mm.

If the display characteristics are not within these limits, refer to the display manual for the linearity and convergence adjustment procedures or to determine the possible cause of failure.

Move the joystick up, and the pattern should slowly scroll up the screen. Moving the joystick left or right should cause the pattern to scroll accordingly.

Press the 1-player start button to obtain the next screen.

Sound Test

The Sound Test screen is shown in Figure 2-15. This test indicates the condition of the coin mechanisms, the optional Vend-A-Ticket Kit, and the music and sound-effects circuits.

The sound microprocessor is reset at the beginning of this test; the reset can take several seconds. If the sound-microprocessor reset fails, the message *SOUND PROCESSOR NOT RESPONDING* should flash near the top of the screen. Move the joystick up to sequence through the sounds. Move the joystick down to sequence backwards through the sounds. The Sound Test provides the following sound information:

- *Current Coin Value* consists of three zeros. As coins are deposited in each of the coin mechanisms, the second and third zero should change to a 1 as the coin switch is held down and should change back to zero when the coin switch is released.
- *Number of Sounds* indicates the number of sounds used in the Road Runner game.

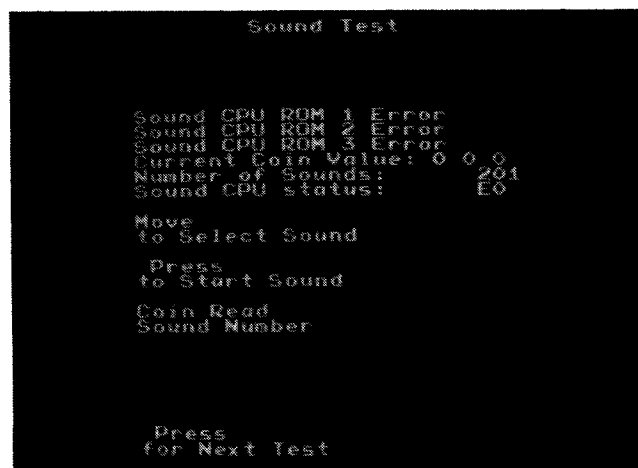

Figure 2-15 Sound Test

NOTE

The *Number of Sounds* software is also used to determine if your Vend-A-Ticket Kit is operating properly. If your game contains one of these kits, a ticket is dispensed when you select sound number 9.

- *Sound CPU Status* indicates the condition of the sound microprocessor. If the sound microprocessor is good, the word *Good* should appear. If the sound microprocessor is faulty, the message *Sound CPU ROM 1* or *2* appears at the top of the screen.
- *Music Chip Test* consists of eight tones in a major scale that alternate between sound channels (16 tones in all).
- *Effects Chip Test* consists of four tones in a major chord that come from both sound channels simultaneously.

Press the 1-player start button to obtain the next screen.

Joystick Test

The Joystick Test screen is shown in Figure 2-16. This test indicates the center position and range of the Hall-effect joystick. Horizontal and vertical set-up values in hexadecimal are displayed in the top left-hand corner of the screen. Both values should equal or be very close to 80 when the joystick is centered. If the joystick is not centered, calibrate it as follows.

Calibration Procedure

The joystick control is calibrated at the factory. However, if the joystick does not respond correctly, perform the following procedure first to ensure that the joystick is properly centered:

1. With the game turned on, remove the control panel and turn it upside down so that it rests on the front

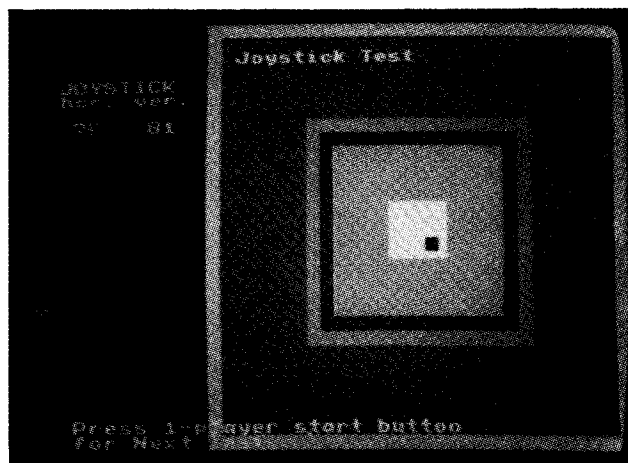

Figure 2-16 Joystick Test

edge of the cabinet with the bottom of the joystick facing up.

2. Using a screwdriver, adjust the two potentiometers located in the lower corners of the Hall-Effect Joystick PCB Assembly so that both horizontal and vertical set-up values equal or are very close to 80. The potentiometer in the left corner (R7) controls the horizontal value; the one in the right corner (R6) controls the vertical value. (See Figure 3-3.) Turning the inset screw of the potentiometer clockwise increases the set-up value. To decrease the set-up value, turn the inset screw of the potentiometer counterclockwise. (See Figure 3-3.)

CAUTION

Do *not* adjust either of the long metal spacer screws positioned perpendicular to the bottom of the joystick control or you might damage it. These screws should *only* be adjusted if you remove the Hall-Effect Joystick PCB. For instructions on how to adjust these screws, refer to "Reassembling the Joystick" in Chapter 3 of this manual.

3. The area within the white box displayed on the screen is used for centering. A small, black square cursor should be in the center of the white box. When the cursor moves out of the white box, it becomes a + sign.
4. Move the joystick to one of the following corners of the green box: upper left, upper right, lower left, or lower right. Release the joystick so that it returns to the center position.
5. If the + sign remains outside of the white box, adjust the joystick potentiometers.
6. Perform this procedure for each corner of the joystick until centering is achieved.

After centering the joystick, perform the following procedure to ensure that the joystick range is correct:

1. Move the joystick so that the + sign moves into the green area. If the + sign remains in the green area, the range of the joystick is correct. However, if the + sign extends beyond the green area, a hardware problem might exist. Contact your nearest Atari Customer Service office.
2. If the + sign does not have enough range to reach the green area, check the following:
 - a. After turning off the game power, locate the TTL Main PCB Assembly in the upper right-hand corner of the cabinet behind the front access panel.
 - b. Check to see if the integrated circuit at location 14/15D is manufactured by Texas Instruments.
 - c. If the integrated circuit is a Texas Instruments one, remove the TTL Main PCB Assembly from the cabinet. (For information on removing this assembly, refer to Chapter 2 in your *System I™ Operators Manual*.)

NOTE

Installing a resistor piggyback style is necessary on TTL Main PCBs only. LSI Main PCBs, used in System I games built from June 1986 on, do *not* require this piggyback modification.

- d. Then, solder a 2.2 k Ω resistor piggyback style across the 3.3 k Ω resistor at designator location R52 to correct the problem. If this does not increase the joystick range, contact your nearest Atari Customer Service office.

Press the 1-player start button to return to the Switch Test.

Maintenance

This chapter includes preventive and corrective maintenance procedures for the Road Runner* Hall-effect joystick control, and the player start buttons. The Hall-effect joystick provides your Road Runner game with more precise movement and speed control of the player's character. Therefore, it is important that the centering and the range of the joystick be correct. You can assure this by performing the joystick calibration procedure. For more information regarding this procedure, please refer to Chapter 2.

To assure maximum trouble-free operation of this game, we recommend that you perform preventive and corrective maintenance as described in this chapter and in the *System I™ Operators Manual*.

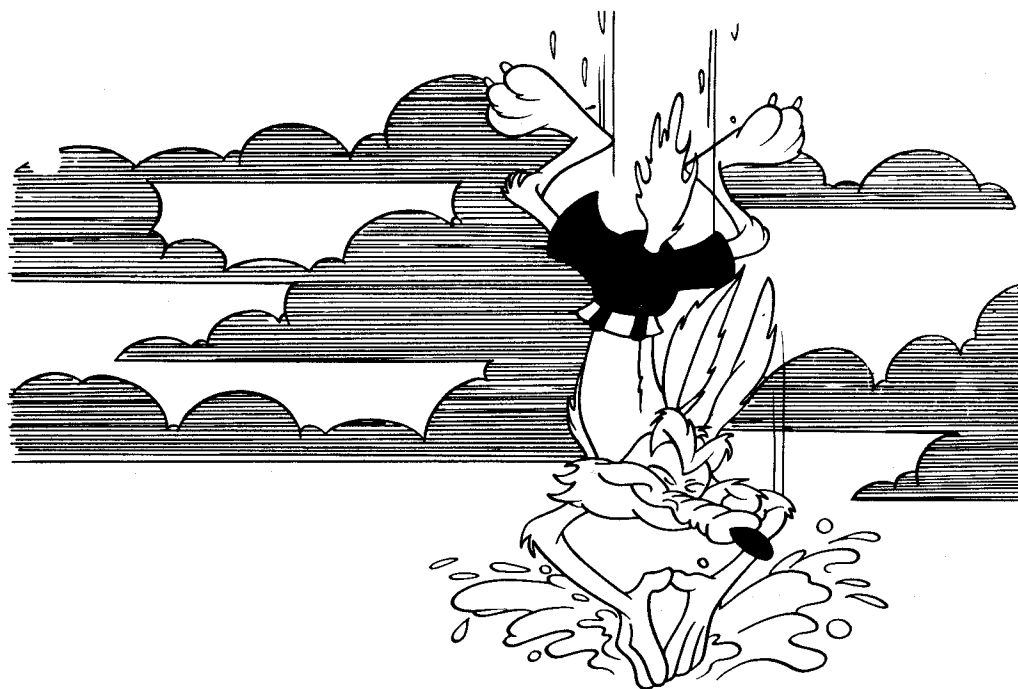

*Trademark of Warner Bros. Inc. used by Atari Games Corporation under license

Preventive Maintenance

Preventive maintenance for this game includes inspecting and cleaning the joystick control and pushbutton leaf switches. How often preventive maintenance is performed depends upon the game environment and frequency of play. However, we recommend that preventive maintenance be performed at least every three months.

WARNING

To avoid possible electrical shock, unplug the game before performing any corrective maintenance procedures.

Removing the Control Panel

Perform the following procedure to remove/replace the control panel. (See Figure 3-1.)

1. Unlock and open the coin door on the front of the cabinet.
2. Carefully reach through the coin door opening and release the spring-draw latch located under the control panel on the right side of the cabinet.
3. Unlock and remove the front access panel.
4. Reach through the front access panel opening and disconnect the control panel harness from the top of the Main PCB Assembly.
5. Carefully reach up under the top of the front access panel opening and release the spring-draw latch located under the control panel on the left side of the cabinet.
6. From underneath, push up on the front edge of the control panel to free the panel from the slot in the cabinet.
7. Disconnect the green ground wire from the control panel harness.
8. Carefully lift the control panel from the cabinet.
9. Replace the control panel in the reverse order of removal.

Cleaning the Pushbutton Leaf Switches

Perform the following procedure to clean the leaf switch contacts and tighten the securing hardware.

1. Remove the control panel as previously described.
2. Use electrical contact cleaner to clean the contacts. Do not burnish them. When the pushbutton is pressed, the wiping action of the cross-bar contacts provides a self-cleaning feature.

3. Using a 5/16-inch open-end wrench, tighten the stamped nut holding the pushbutton leaf switches to the control panel.

Lubricating the Joystick

Perform the following procedure to lubricate the joystick control and tighten the securing hardware.

1. Remove the control panel as previously described.
2. Using a 7/16-inch hex driver, tighten the four nuts holding the joystick control to the control panel. (See Figure 3-2.)
3. Disconnect the four-pin connector from the Hall-Effect Joystick Printed-Circuit Board (PCB)—see Figure 3-3.

CAUTION

Do *not* adjust either of the long metal spacer screws on the bottom of the joystick control or you might damage it. These screws should *only* be adjusted if you remove the Hall-Effect Joystick PCB. For instructions on how to adjust these screws, refer to "Reassembling the Joystick" in this chapter.

4. Using a ¼-inch hex driver, remove the two screws holding the Hall Effect PCB to the Hall-effect positioner plate. Be sure not to bend or damage the Hall-effect magnetic-sensor transistor located on the solder side of the PCB.
5. Using a Phillips screwdriver, remove the four screws holding the lower Hall-effect housing and positioner plate to the upper housing assembly.
6. Remove the actuator and the X- and the Y-direction slides.
7. Apply a small amount of lithium-base lubricant (Atari part no. 107027-001) to the actuator and the X- and the Y-direction slides.
8. Apply a small amount of lithium-base lubricant to the plunger, pivot ball, and actuator ball on the joystick shaft as shown. Press the joystick control knob down to compress the spring and expose the contact surfaces of the pivot ball and plunger.
9. Reassemble the joystick as described under *Reassembling the Joystick* in the Corrective Maintenance section of this chapter.

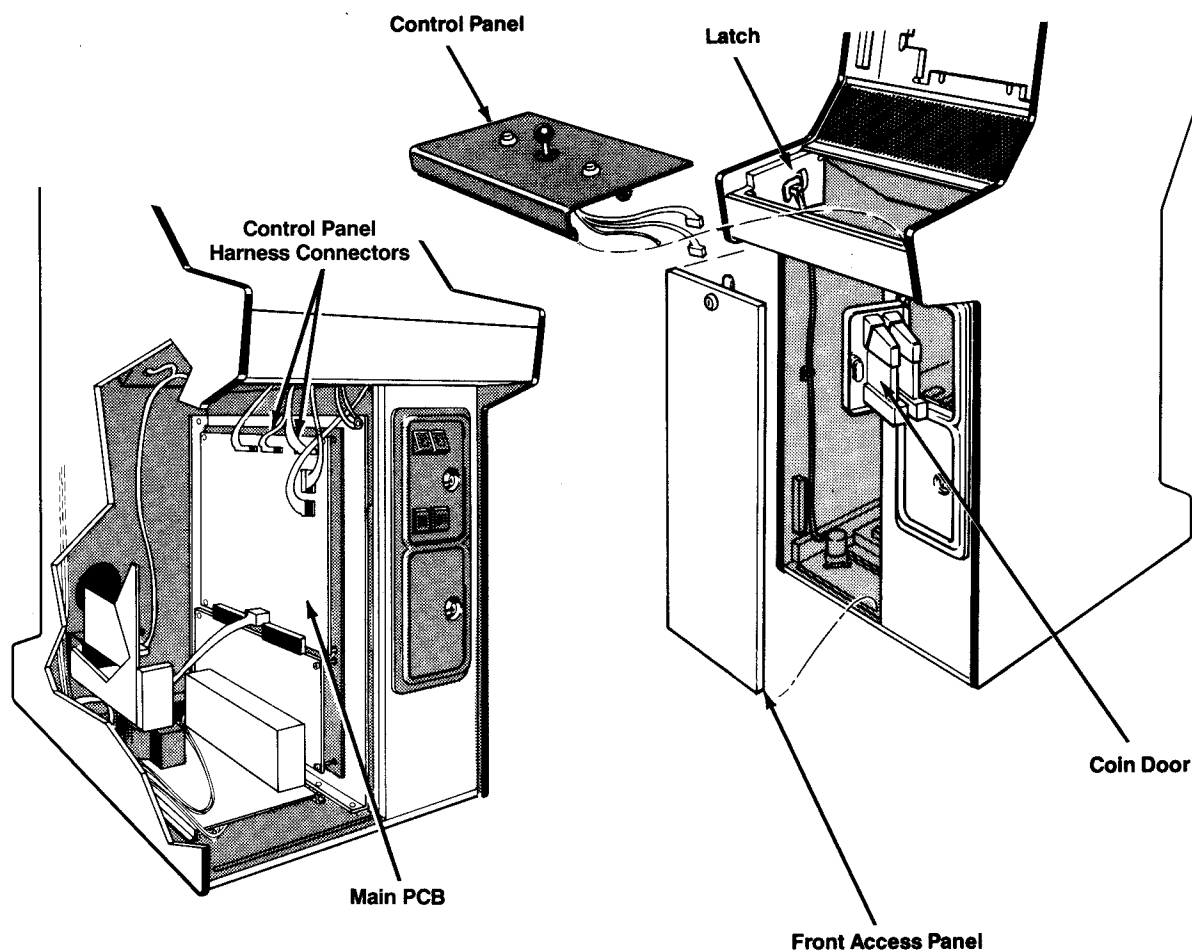

Figure 3-1 Removing the Control Panel

Corrective Maintenance

Corrective maintenance consists of removing, disassembling, reassembling, and replacing the joystick control, and pushbutton leaf switches.

Removing the Pushbutton Leaf Switches

Perform the following procedure to remove/replace the pushbutton leaf switches or contacts. (See Figure 3-2.)

NOTE

Pushbutton leaf switches can be checked for proper operation by using the Self-Test.

1. Open the control panel as described under *Preventive Maintenance*.
2. Using a 15/16-inch wrench, remove the stamped nut on the underside of the control panel. The button assembly on the top side of the control panel should not turn.
3. Install the pushbutton leaf switches in the reverse order of removal. Reconnect the harness wires to the switch terminals.

Removing the Joystick

Perform the following procedure to remove the joystick control from the control panel. (See Figure 3-2.) Refer to

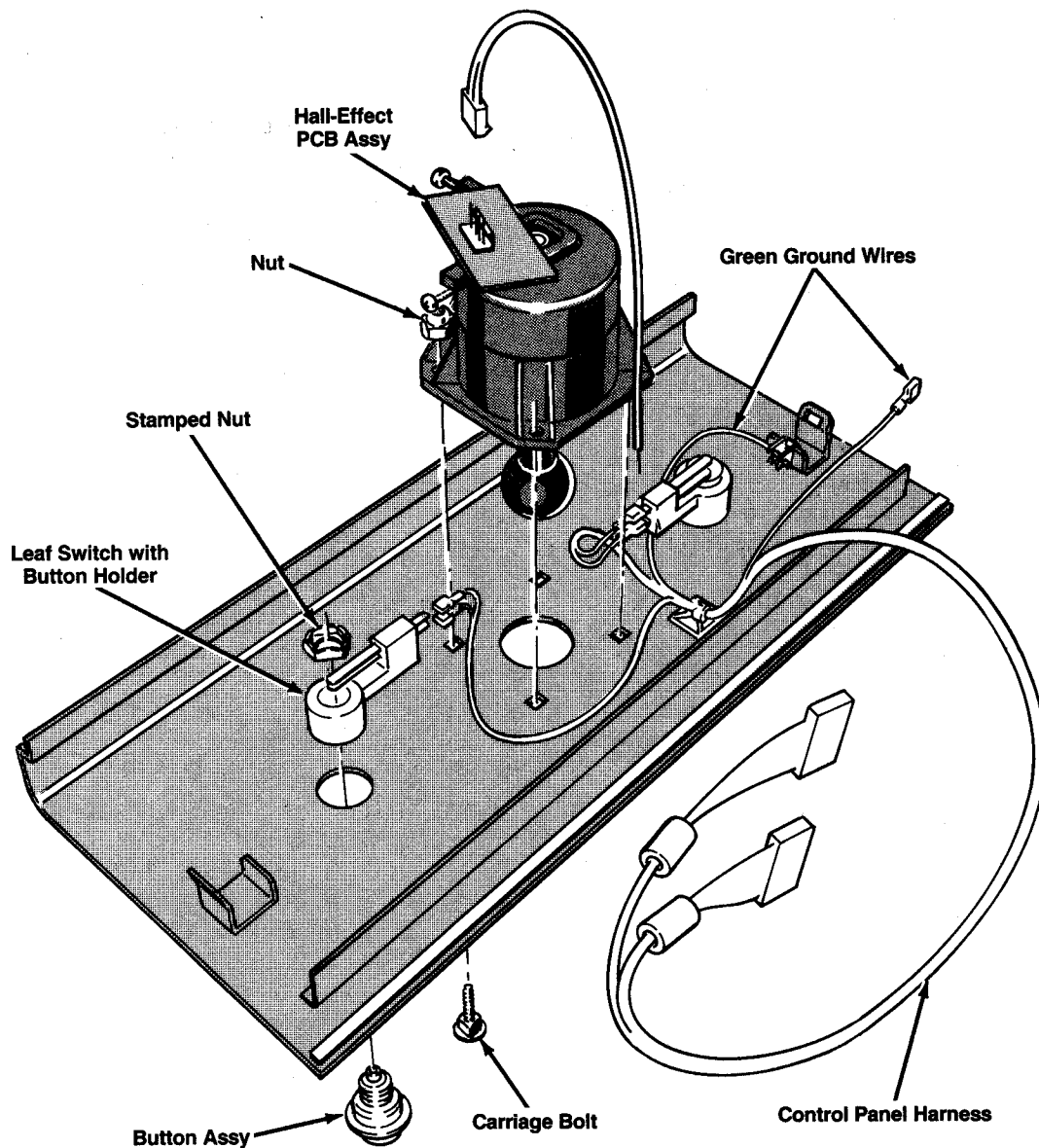

Figure 3-2 Removing the Joystick and Pushbutton Leaf Switches

Disassembling the Joystick for detailed disassembly procedures.

1. Remove the control panel as described under *Preventive Maintenance*.
2. Disconnect the four-pin connector from the Hall-Effect PCB.
3. Using a 7/16-inch hex driver, remove the four nuts holding the joystick control to the control panel.
4. Carefully lift the joystick control out of the control panel.
5. Replace the joystick control in the reverse order of removal.

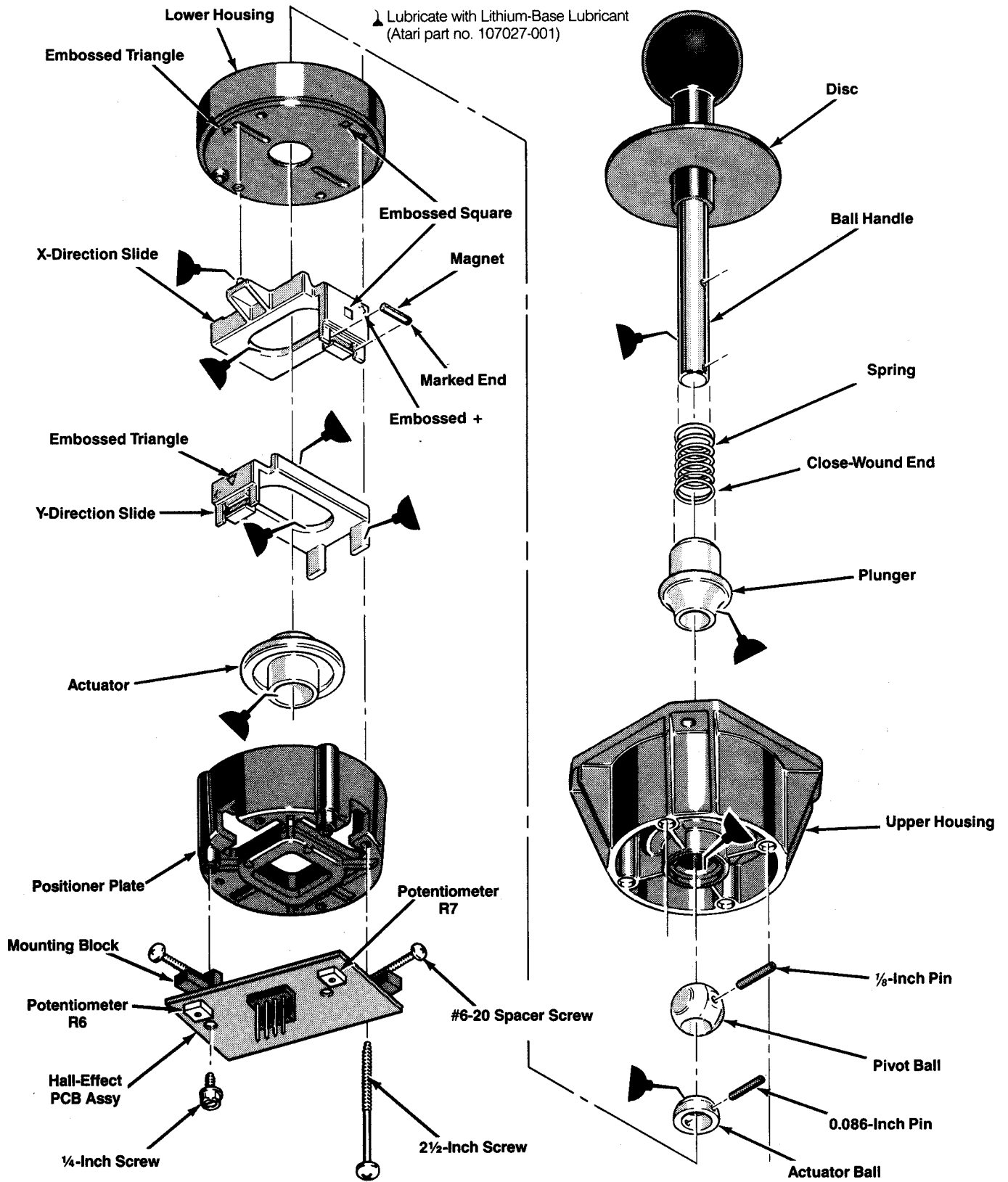

Figure 3-3 Joystick Disassembly and Lubrication

Disassembling the Joystick

Perform the following procedure to disassemble the joystick control. (See Figure 3-3.) If necessary, remove the joystick control from the cabinet as previously described.

1. Using a ¼-inch hex driver, remove the two screws holding the Hall-Effect PCB to the positioner plate.

CAUTION

The position of the Hall-effect sensors on the Hall-Effect PCB is critical. Avoid bending these sensors when handling the PCB.

2. Using a Phillips screwdriver, remove the four screws holding the Hall-effect positioner plate and lower Hall-effect housing to the upper housing assembly.
3. Separate the lower housing and the positioner plate from the upper housing assembly.
4. Remove the actuator and the X- and the Y-direction slides.
5. Gently press the magnets out of the clips in the X- and the Y-direction slides. Do not drop the magnets.

NOTE

The following steps describe the procedure for disassembling the upper housing assembly.

6. Using a metal punch, remove the 0.086-inch roll pin holding the actuator ball to the shaft.
7. Using a metal punch, remove the 1/8-inch roll pin holding the pivot ball to the shaft.
8. Slide the shaft out of the housing and remove the plunger and spring from the shaft.
9. Reassemble the joystick control as described in the following procedure.

Reassembling the Joystick

Perform the following procedure to reassemble the joystick control. (See Figure 3-3.)

NOTE

If the upper housing assembly was not previously disassembled, proceed to step 11.

1. Slide the disc onto the ball-handle shaft.
2. Slide the spring onto the ball-handle shaft.
3. With the bell-shaped end toward the end of the shaft, slide the plunger onto the ball-handle shaft and over the spring.

4. Slide the end of the ball-handle shaft through the top of the lower Hall-effect housing.
5. Slide the pivot ball onto the ball-handle shaft and align the hole in the shaft (nearest the lower housing) with the hole in the pivot ball.
6. Using a metal punch, insert the 1/8-inch roll pin through the pivot ball and the ball-handle shaft so that the roll pin protrudes equally from both sides of the ball.
7. With the beveled edge toward the pivot ball, slide the actuator ball onto the end of the ball-handle shaft.
8. Align the hole in the actuator ball with the hole in the end of the ball-handle shaft.
9. Using a metal punch, insert the 0.086-inch roll pin through the actuator ball and the ball-handle shaft.
10. Lift the disc, tilt the ball-handle shaft to one side, and apply a small amount of lithium-base lubricant (Atari part no. 107027-001) to the contact area between the plunger and the upper housing.
11. Place the lower Hall-effect housing over the ball-handle shaft and align the four screw holes in the upper housing with those in the lower housing.
12. With the marked end of the magnet toward the + embossed on the Hall-effect X-direction slide, insert the magnet into the slide clip.
13. Apply a small amount of lithium-base lubricant (Atari part no. 107027-001) to the two tab pins and the four corners of the X direction slide.
14. Place the X-direction slide on the lower Hall-effect housing. Make sure the two tab pins are aligned with the housing slots and that the magnet is facing the small *square* embossed in the outside edge of the housing.
15. With the marked end of the magnet toward the + embossed on the Hall-effect Y-direction slide, insert the magnet into the slide clip.
16. Apply a small amount of lithium-base lubricant (Atari part no. 107027-001) to the two tabs and edges of the Y-direction slide and to both sides of the actuator.
17. With the magnet facing the small *triangle* embossed on the edge of the lower housing, place the Y-direction slide on top of the X-direction slide.
18. With the beveled hole toward the lower housing, place the actuator over the ball-handle shaft and through the center of the X- and Y-direction slides. Make certain the actuator is inserted through both slides so that the end of the ball-handle shaft is flush with the end of the actuator.
19. Gently place the Hall-effect positioner plate over the slides so that the magnets and two tabs on the Y-direction slide are aligned with the corresponding slots in the positioner plate. Adjust the positioner plate until the four screw holes are aligned with those in the lower housing.

20. Insert the four 2½-inch screws into the four screw holes in the positioner plate.
21. Using a Phillips screwdriver, tighten the four screws until the head of each screw touches the plastic surface. Check that the ball handle returns freely to the centered position.
22. Check that the two Hall-effect magnetic-sensor transistors on the Hall-Effect PCB are perpendicular to the PCB. Place the PCB on the positioner plate so that the transistors are positioned in front of the two magnets installed in the slides.
23. Using a ¼-inch hex driver, tighten the two ¼-inch screws holding the Hall-Effect PCB to the positioner plate.
24. If necessary, adjust the long metal spacer screws on the bottom of the PCB to eliminate any air gap between the spacer screws and the Hall-effect transistors or between the Hall-effect transistors and the magnets. After the PCB has been tightly secured, the spacer screws should be physically touching the transistors but not exerting pressure on them.

N

O

T

E

S



Game Play

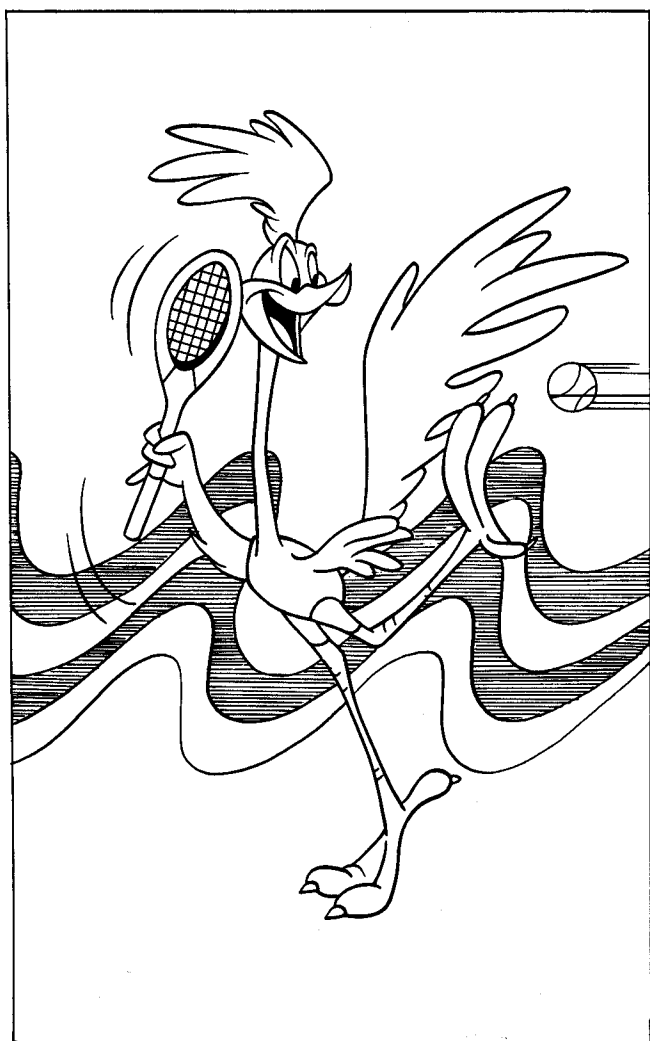

Introduction

Road Runner* is a one- or two-player game based on the ever-popular cartoon by the same name. The player portrays the Road Runner who must outmaneuver and outsmart Wile E. Coyote while eating seed along the way in order to stay alive.

Attract Mode

The Attract Mode begins when the game is powered up or after exiting the Play or Self-Test modes. The Attract Mode ends when coins or tokens are inserted and the start button is pressed. The Attract Mode continuously cycles through the following displays:

- Game play demonstration
- Audiovisual credits
- High score table
- Road Runner title screen

Unique Features to Attract Players

- The renowned cartoon chase theme with which players of all ages can identify.
- Graphic quality so realistic players will feel like they are directing their very own Saturday morning animated series.
- Numerous unforgettable stunts and gags from the Road Runner cartoon deliver unpredictable game play variety and comic relief.
- Several full-stereo music scores that players will recognize from the Road Runner and other Looney Tunes shows including:
 1. The Road Runner Theme Song
 2. "This Is It"
 3. "The Flight of the Bumblebee"
 4. "The William Tell Overture"
 5. "Merrily We Roll Along"
 6. "The Merry-Go-Round Broke Down"
 7. "Trepak" (from *The Nutcracker Suite*)
 8. "The Sabre Dance"

Play Mode

The player portrays the Road Runner who must avoid Wile E. Coyote and his tricks while eating seed along the way in order to stay alive. At the top of the screen is a seed meter, an animated reminder showing players the number of seed piles they have missed.

A new control, the Hall-effect joystick, guides both the Road Runner's speed and direction of movement. The Hall-effect device responds in all directions, not just the standard four or eight. The swiftness of the Road Runner increases as the joystick is moved to its extreme positions, giving the player a full range of speed and movement.

The two hop buttons located on either side of the joystick allow the player to jump over mines, oil slicks, crevices, and in later stages of the game, glasses of lemonade, and steel shot. The player must learn to time the use of the hop button in order to escape from the coyote.

On level one, Road Runner's game play is very easy to comprehend. The player is encouraged to learn the basic rules of the game before multiple objectives appear. In later game screens the player must dodge trucks, drink lemonade, eat steel shot, and use invisible paint.

The Road Runner scores points in several different ways: 1. Picking up the piles of seed, 2. Jumping over the mines, 3. Eating the steel shot, 4. Teasing Wile E. Coyote by allowing him to follow very closely, 5. Forcing the coyote's plans to backfire, and 6. Drinking lemonade.

The Road Runner can get an extra life by accumulating enough points to achieve the operator-selectable bonus threshold. (Refer to Chapter 2, Game Options, for more

information.) An extra life is also given as an incentive to players who use the mine entrance if it is open (the short-cut game continuation feature).

Some hints for high score seekers:

- Eating all the seed is the best strategy for achieving a high score. Passing five piles of seed will cause a loss of life. The value of the seed increases arithmetically up to a maximum of 1000 points for every consecutive pile that is eaten.
- The player can potentially achieve maximum scores by allowing Wile E. Coyote to follow as closely as possible. The closer Wile E. Coyote follows, the faster the points accumulate. Also, by allowing the coyote to follow closely behind, the player keeps Wile E. Coyote from scrolling off screen—a great advantage for the player because the coyote puts on his rocket skates or his super sneakers when he is off screen.
- In addition, points are awarded for forcing the coyote's plans to backfire. The player is given the incentive to trick Wile E. Coyote into falling off the cliff, getting squashed by a rock, running into a mine, being run over by a truck, etc.
- At the end of each level, the player is awarded bonus points for jumping over the mines, eating all the seed, and tricking Wile E. Coyote into falling victim to his own traps.
- In later levels of the game, drinking the glass of lemonade creates a risk factor for the Road Runner. Drinking lemonade temporarily stops the Road Runner in his tracks but is worth bonus points if he can still avoid Wile E. Coyote. The Road Runner can also lead the coyote and trick him into drinking lemonade; doing this gives the player a little time where he is safe from the coyote. Eating the steel shot causes the coyote to come



after the Road Runner with a magnet, slowing down the player's movement.

- As the game becomes more difficult in higher levels, using the invisible paint becomes especially advantageous. When the Road Runner uses the invisible paint, the coyote becomes confused as to the Road Runner's real location. By using the paint, the Road Runner prevents Wile E. Coyote from getting the paint and becoming invisible.
- The player is given a bonus of the points from the previous game if he uses the shortcut through the cave entrance (a game continuation feature). In two-player games, the higher score of the two is awarded the bonus of previous game points. To open the cave entrance, the player must complete at least one level, insert a coin, and press the start button before the end of the attract mode sequence.

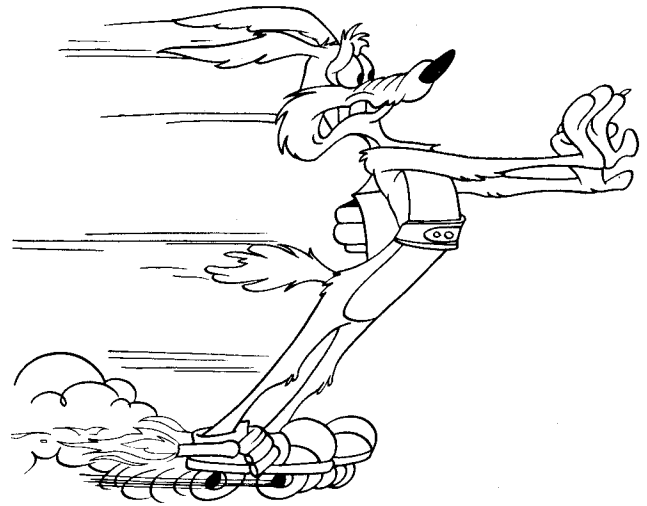

High Score Mode

Upon completing a game and if players are among the top ten scorers recorded on the game, they have 15 seconds to enter their first initial and 30 seconds for their next two initials. Players select their initials by moving the joystick and pressing the hop button when the proper initial is displayed. Players can correct their initials by selecting the arrow that points to the left and pressing the hop button, or by moving the joystick to the left, then repeating the procedure for entering their correct initials.

To encourage high score competitiveness among players, your Road Runner game automatically resets the high score table to the default list of players' initials and scores. During normal use (when the game is turned off at closing time), the top four scores are reset if more than 500 sequential games have elapsed and no players have entered their initials as one of the top four scores. This interval is about once a week; the reset occurs during power-up. Scores 5 through 10 are reset daily during power-up. With games that are used on a continuous 24-hour basis, all ten high scores are automatically reset after 500 games and no players have entered their initials anywhere in the table, or about once a week. This automatic high score reset function operates in all System I games containing either the TTL Main Printed-Circuit Board or the LSI Main PCB.

Maximizing Earnings

Operator options on this game have been kept very simple. You should thoroughly read Chapter 2, Self-Test, for the Coin Options, Game Options, Histograms, and Statistics screens so that you can effectively use the available options. Use the Self-Test screens showing Statistics and Histograms to evaluate game data, and the Game Options screen to make adjustments.

The key to maximum earnings is striking a midpoint on game times. Game times must be short enough so that

player turnover is high. Conversely, game times must be long enough to give a player a good value and ensure repeat play. (Repeat play is crucial to longevity.) The Road Runner software gives the operator the flexibility to tune game difficulty and enough statistics to intelligently make adjustments. Refer to Table 4-1 for a completed statistics form with typical data for one week of play.

If collections seem low or are dropping off, check all player controls and coin mechanisms for proper operation. If the average game time per quarter is under 120 seconds, try changing the bonus options to easier settings. These changes should be quite obvious to players and should encourage more game play. If game times are still too short after a few weeks on easier bonus settings, try changing the game difficulty to an easier setting.

For your convenience, Table 4-2 shows the game bonus option settings, ranked in order from easiest to hardest, based on initial game play difficulty. Note that the "increasing from" options are initially easier and become difficult more quickly than the "every" options. Therefore, if beginning players are getting frustrated by short game times, then try changing the bonus option from the factory recommended "increasing from 20,000" to "increasing from 10,000." If high-level players have found an impasse at a certain high level, then try the "every 30,000" option. (Your Road Runner histograms will indicate how far your players are getting in the game.) Refer to the Self-Test chapter for instructions on how to properly select the desired option and the order in which these options are found on your Road Runner game.

If the average game time is still too short after a few weeks on an easier bonus setting, try changing the game difficulty to an easier setting (e.g., from the factory setting of "moderate" to "easy").

Table 4-1 Typical One-Week Road Runner Statistics

Game Statistics

Aux Coins	0
Left Coins	596
Right Coins	540
1 Plyr Games	972
2 Plyr Games	82
Mins Played	2505
Mins Pwr Up	5586
Aux Cntr 1	218
Aux Cntr 2	0
Aux Cntr 3	350
Error Count	0
Avg. Game Time	132

Histograms

Seconds	Level						
	1	2	3	4	5	6	7
0-59	72					17	
60-89	199	1				75	
90-119	78	123				38	4
120-149	2	156				19	11
150-179	1	63				9	16
180-209		60	15			3	15
210-239		37	42				8
240-269		2	31	1			
270-299			5	7			1
300-329			1	5			
330-359				1	2		1
360-389				1			1
390-419					4		
420-449					5		
450-479					1		
480-509					1		
510-539							
540 and up					2		
High Score	65536	148992	188416	260352	540672	711936	641536

On the screen, zeroes appear where blank lines appear in this table.

Table 4-2 Game Bonus Option Settings*

Increasing from 10,000: one bonus life granted at 10,000, 30,000, 60,000, 100,000, 150,000, 200,000 points and every 100,000 thereafter

Increasing from 20,000 ◀: one bonus life granted at 20,000, 50,000, 100,000, 150,000, 200,000 points and every 100,000 thereafter

Every 30,000: one bonus life granted at 30,000, 60,000, 90,000, 120,000, etc. points

Increasing from 30,000: one bonus life granted at 30,000, 75,000, 150,000, 250,000 points and every 100,000 thereafter

Every 40,000: one bonus life granted at 40,000, 80,000, 120,000, 160,000, etc. points

Every 50,000: one bonus life granted at 50,000, 100,000, 150,000, 200,000, etc. points

Increasing from 50,000: one bonus life granted at 50,000, 125,000, 250,000, 400,000 points and every 200,000 thereafter

None

◀ *Manufacturer's recommended setting*

* *Settings in easiest to hardest difficulty order*

If the average game time per quarter is over 180 seconds, first try changing the game difficulty to a harder setting. If the average game time per quarter is still over 180 sec-

onds after a few weeks, try an even harder setting. The number of lives per coin can also be reduced; however, this change will be more obvious to players and is likely to discourage them.

NOTE

Be sure to change the factory default to "no" if you wish to try other than factory-recommended settings.

After changing the game difficulty settings, it is a good idea to reset the game statistics. The coin information should be cleared in self-test by pressing the 2-player start button; this resets the average game time statistic. In addition, the histograms should be cleared by pressing the 2-player start button in the last level Histogram screen.

Self-Test Mode

You can set the Road Runner game to the Self-Test Mode by turning on the Self-Test switch located on the Audio Printed-Circuit Board. (For the short version of self-test, consisting of the Switch Test, Coin Options, Game Options, Statistics, and Histogram screens, hold down the 2-player start button while turning on the self-test switch.) Refer to Chapter 2 of this manual for detailed self-test information.



N

O

T

E

S

☾

☾

☾

Illustrated Parts Lists

This chapter provides information you need to order parts for your game. Common hardware (screws, nuts, washers, etc.) has been deleted from most of the parts lists. Refer to the *Atari System I™ Operators Manual*, Chapter 4, for additional parts lists that describe the parts common to all System I games.

The PCB parts lists are arranged in alphabetical order by component. Each component subsection is arranged alphanumerically by reference designator or location.

Other parts lists are arranged alphanumerically by Atari part number. In these parts lists, all A-prefix numbers come first. Following these are numbers in sequence evaluated up to the hyphen, namely 00- through 99-, then 000598- through approximately 201000-.

When ordering parts, please give the part number, part name, number of this manual, and serial number of your game. This will help us fill your order rapidly and correctly. We hope the results will be less downtime and more profit from your game.

Atari Customer Service numbers are listed on the inside front cover of this manual.

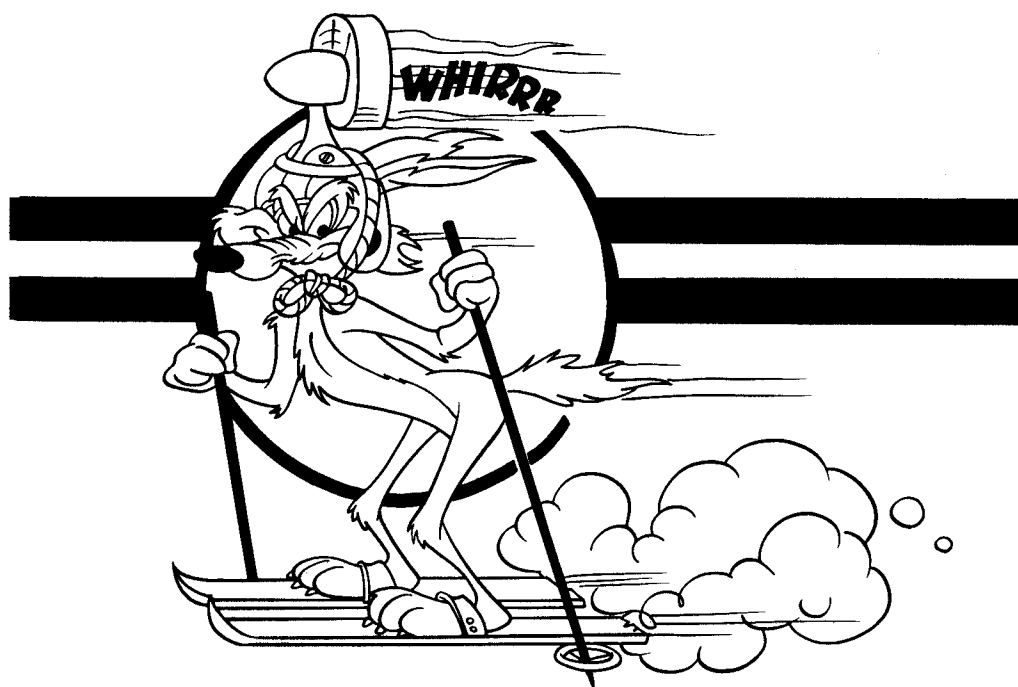

★ Part used only in US-built cabinets
 ✪ Part used only in Ireland-built cabinets

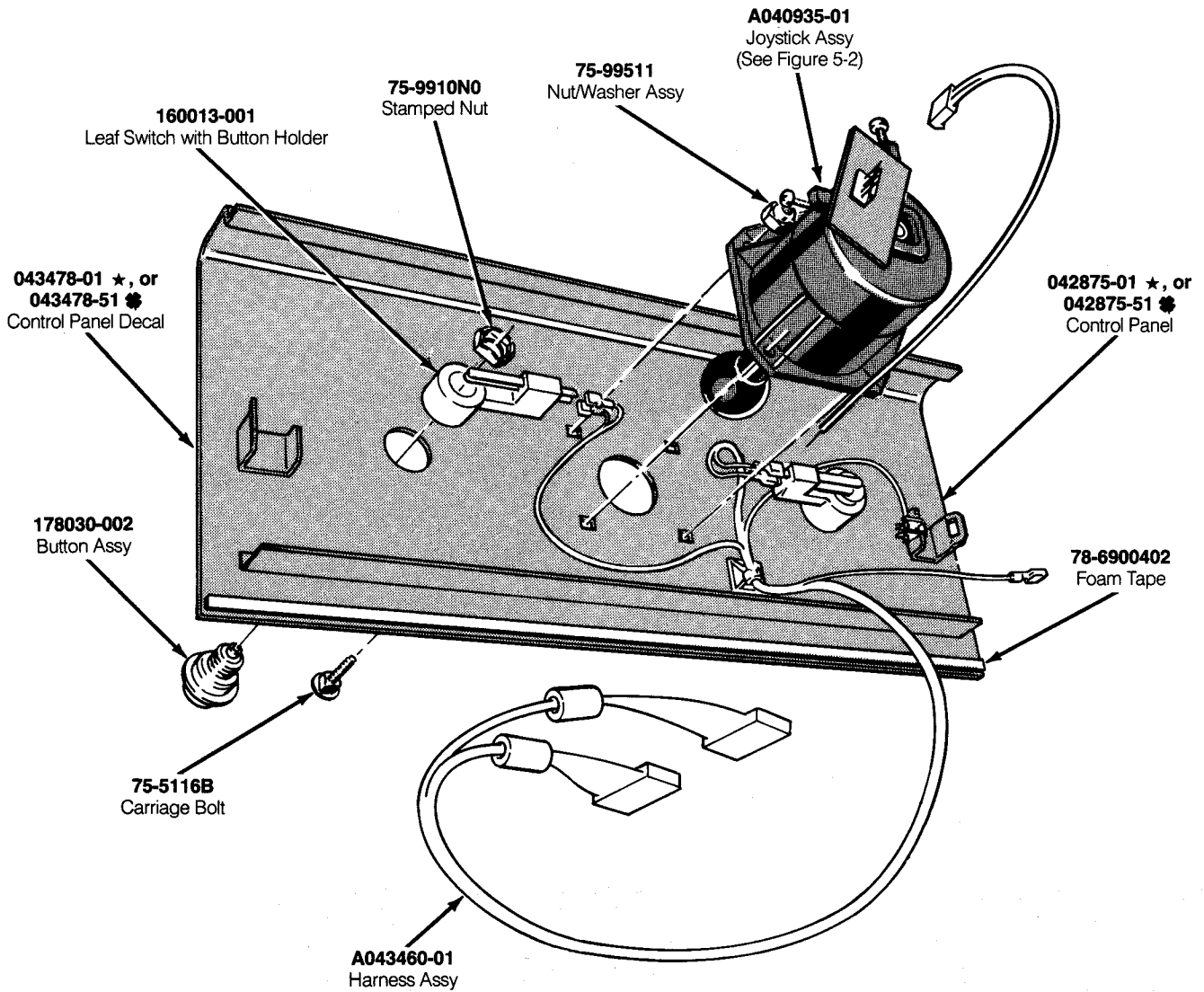

Figure 5-1 Control Panel Assembly
A043477-01 A (US)
and A043477-51 A (Ireland)

Control Panel Assembly Parts List

Part No.	Description
A040935-01	Hall-Effect Joystick Assembly—see Figure 5-2
A043460-01	Control Harness Assembly
75-5116B	#10-24 × 1-Inch-Long Black Carriage Bolt
75-9910N0	#11 5/8-Inch Stamped Nut
75-99511	#10-24 Nut/Washer Assembly
78-6900402	1/4-Inch × 1/8-Inch-Thick Foam Tape (24 inches required)
042875-01 ★	Control Panel (042875-51 ♣)
043478-01 ★	Control Panel Decal (043478-51 ♣)
160013-001	Leaf Switch with Button Holder
178030-002	Orange Button Assembly

★ Part used only in US-built cabinets

♣ Part used only in Ireland-built cabinets

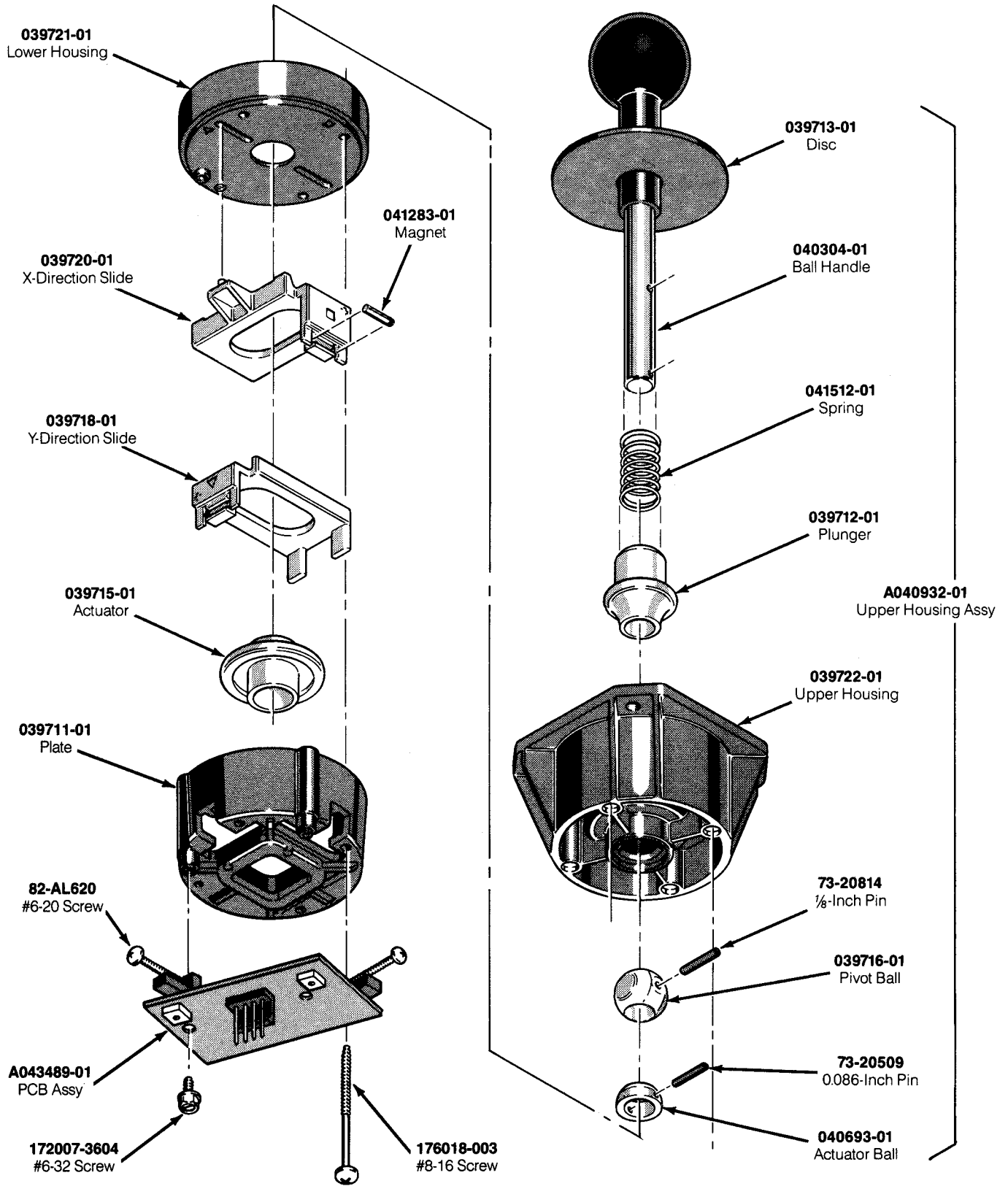

**Figure 5-2 Hall-Effect Joystick Assembly
A040935-01 D**

Hall-Effect Joystick Assembly Parts List

Designator	Description	Part No.
	Upper Housing Assembly includes:	A040932-01
	Plunger	039712-01
	Disc	039713-01
	Pivot Ball	039716-01
	Upper Housing	039722-01
	Ball Handle	040304-01
	Actuator Ball	040693-01
	Plunger Spring	043696-01
	0.086 × 0.563-Inch Roll Pin	73-20509
	0.125 × 1 ½ -Inch Roll Pin	73-20824
	Hall-Effect Joystick PCB Assembly includes:	A043489-01
C1	4.7 μF, 50 V Electrolytic Capacitor	24-500475
J1	4-Circuit Header Connector	79-58356
R1	10 Ω ± 5%, ¼ W Resistor	110000-100
R2, R3	2 kΩ ± 5%, ¼ W Resistor	110000-202
R4, R5	220 Ω ± 5%, ¼ W Resistor	110000-221
R6, R7	10 kΩ Horizontal Potentiometer	119002-103
Z1, Z2	Hall-Effect Magnetic-Sensor Transistor	133030-001
	Mounting Block	043487-01
	#4-24 × 1/4-Inch-Long Cross-Recessed Thread-Cutting Pan-Head Screw	82-AL404
	#6-20 × 1 ¼ -Inch-Long Thread-Cutting Cross-Recessed Pan-Head Screw	82-AL620
	Hall-Effect Positioner Plate	039711-01
	Actuator	039715-01
	Hall-Effect Y-Direction Slide	039718-01
	Hall-Effect X-Direction Slide	039720-01
	Lower Hall-Effect Housing	039721-01
	0.125 Diameter × 0.625-Inch-Long Magnet	041283-01
	Lithium Grease Lubricant	107027-001
	#8-16 × 2 ½ -Inch-Long Thread-Forming Cross-Recessed Pan-Head Screw	176018-003
	#6-32 × 1/4-Inch-Long Thread-Forming Type-C Hex Washer-Head Screw	172007-3604

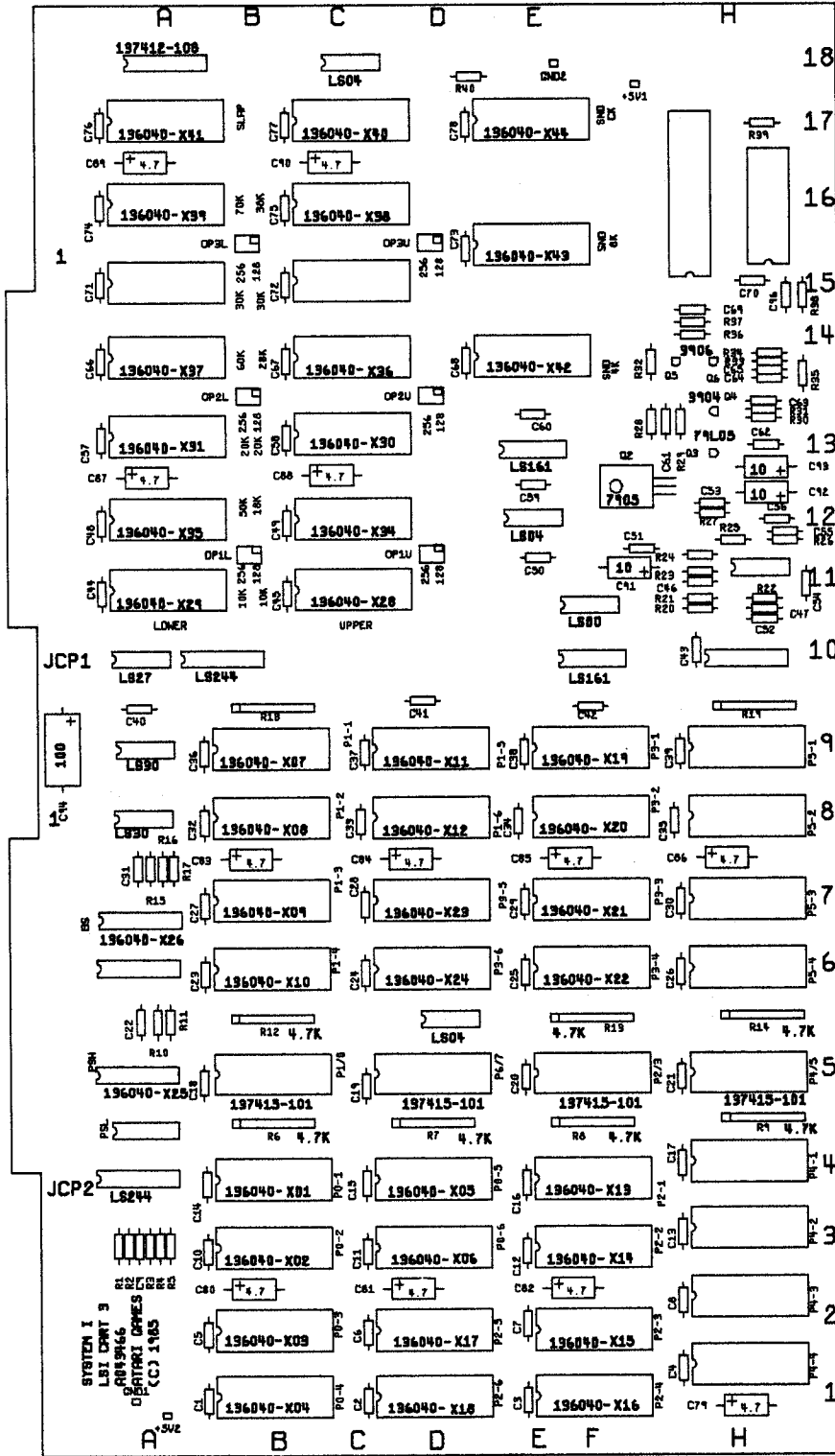

NOTES:

- 1. INSTALL OPTION JUMPERS ON OP11-OP18 AND OP11-OP18 AS SHOWN :

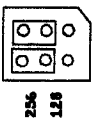

NOTICE TO ALL PERSONS RECEIVING THIS DRAWING
 CONFIDENTIAL: Reproduction forbidden without the specific written permission of Atari Games Corporation, Milpitas, CA. This drawing is only conditionally issued and neither receipt nor possession thereof confers or transfers any right in, or license to use, the subject matter of the drawing or any design or technical information shown thereon, nor any right to reproduce this drawing or any part thereof. Except for manufacture by vendors of Atari Games Corporation, and for manufacture under the corporation's written license, no right is granted to reproduce this drawing or the subject matter thereof, unless by written agreement with or written permission from the corporation.

Figure 5-3 LSI Cartridge 3 PCB Assembly
 A043486-01 A

LSI Cartridge 3 PCB Assembly Parts List

Designator	Description	Part No.
Integrated Circuits		
1B	Integrated Circuit, EPROM, Type-27256, 300 ns	136040-104
1D	Integrated Circuit, EPROM, Type-27256, 300 ns	136040-118
1F	Integrated Circuit, EPROM, Type-27256, 300 ns	136040-116
2B	Integrated Circuit, EPROM, Type-27256, 300 ns	136040-103
2D	Integrated Circuit, EPROM, Type-27256, 300 ns	136040-117
2F	Integrated Circuit, EPROM, Type-27256, 300 ns	136040-115
3B	Integrated Circuit, EPROM, Type-27256, 300 ns	136040-102
3D	Integrated Circuit, EPROM, Type-27256, 300 ns	136040-106
3F	Integrated Circuit, EPROM, Type-27256, 300 ns	136040-114
4A	Integrated Circuit, Type-74LS244	37-74LS244
4B	Integrated Circuit, EPROM, Type-27256, 300 ns	136040-101
4D	Integrated Circuit, EPROM, Type-27256, 300 ns	136040-105
4F	Integrated Circuit, EPROM, Type-27256, 300 ns	136040-113
5/6D	Integrated Circuit, Type-74LS04	37-74LS04
5A	Integrated Circuit, EPROM, Type-74S473	136040-125
5B	Integrated Circuit, SLAGS	137415-101
5D	Integrated Circuit, SLAGS	137415-101
5F	Integrated Circuit, SLAGS	137415-101
5H	Integrated Circuit, SLAGS	137415-101
6A	Integrated Circuit, Type-74LS244	37-74LS244
6B	Integrated Circuit, EPROM, Type-27256, 300 ns	136040-110
6D	Integrated Circuit, EPROM, Type-27256, 300 ns	136040-124
6F	Integrated Circuit, EPROM, Type-27256, 300 ns	136040-122
7A	Integrated Circuit, EPROM, Type-74S472	136040-126
7B	Integrated Circuit, EPROM, Type-27256, 300 ns	136040-109
7D	Integrated Circuit, EPROM, Type-27256, 300 ns	136040-123
7F	Integrated Circuit, EPROM, Type-27256, 300 ns	136040-121
8A	Integrated Circuit, Type-74LS30	37-74LS30
8B	Integrated Circuit, EPROM, Type-27256, 300 ns	136040-108
8D	Integrated Circuit, EPROM, Type-27256, 300 ns	136040-112
8F	Integrated Circuit, EPROM, Type-27256, 300 ns	136040-120
9A	Integrated Circuit, Type-74LS30	37-74LS30
9B	Integrated Circuit, EPROM, Type-27256, 300 ns	136040-107
9D	Integrated Circuit, EPROM, Type-27256, 300 ns	136040-111
9F	Integrated Circuit, EPROM, Type-27256, 300 ns	136040-119
10/11F	Integrated Circuit, Type-74LS00	37-74LS00
10A	Integrated Circuit, Type-74LS27	37-74LS27
10B	Integrated Circuit, Type-74LS244	37-74LS244
10F	Integrated Circuit, Type-74LS161	37-74LS161
11A	Integrated Circuit, EPROM, Type-27256, 200 ns	136040-129
11C	Integrated Circuit, EPROM, Type-27256, 200 ns	136040-128
12A	Integrated Circuit, EPROM, Type-27256, 200 ns	136040-135
12C	Integrated Circuit, EPROM, Type-27256, 200 ns	136040-134
12E	Integrated Circuit, Type-74LS04	37-74LS04

LSI Cartridge 3 PCB Assembly Parts List, Continued

Designator	Description	Part No.
13A	Integrated Circuit, EPROM, Type-27256, 200 ns	136040-131
13C	Integrated Circuit, EPROM, Type-27256, 200 ns	136040-130
13E	Integrated Circuit, Type-74LS161	37-74LS161
14A	Integrated Circuit, EPROM, Type-27256, 200 ns	136040-137
14C	Integrated Circuit, EPROM, Type-27256, 200 ns	136040-136
14E	Integrated Circuit, EPROM, Type-27128, 300 ns	136040-142
15/16E	Integrated Circuit, EPROM, Type-27128, 300 ns	136040-143
16A	Integrated Circuit, EPROM, Type-27256, 200 ns	136040-139
16C	Integrated Circuit, EPROM, Type-27256, 200 ns	136040-138
17A	Integrated Circuit, EPROM, Type-27128, 200 ns	136040-141
17C	Integrated Circuit, EPROM, Type-27128, 200 ns	136040-140
17E	Integrated Circuit, EPROM, Type-27128, 300 ns	136040-144
18A	Integrated Circuit, SLAPSTIC	137412-108
18C	Integrated Circuit, Type-74LS04	37-74LS04
Capacitors		
C1-C45	.1 μ F, 50 V, Ceramic Capacitor	122002-104
C46	.22 μ F, 25 V, Ceramic Capacitor	122004-224
C47	.0068 μ F, 50 V, Ceramic Capacitor	122015-682
C48-C52	.1 μ F, 50 V, Ceramic Capacitor	122002-104
C53	.22 μ F, 25 V, Ceramic Capacitor	122004-224
C54	.1 μ F, 50 V, Ceramic Capacitor	122002-104
C55	.22 μ F, 25 V, Ceramic Capacitor	122004-224
C56	.0039 μ F, 50 V, Ceramic Capacitor	122015-392
C57-C62	.1 μ F, 50 V, Ceramic Capacitor	122002-104
C63	.0012 μ F, 50 V, Ceramic Capacitor	122015-122
C64	.018 μ F, 50 V, Ceramic Capacitor	122015-183
C65	100 pF, 100 V, Ceramic Capacitor	122016-101
C66-C78	.1 μ F, 50 V, Ceramic Capacitor	122002-104
C79-C90	4.7 μ F, 50 V, Electrolytic Capacitor	24-500475
C91-C93	10 μ F, 35 V, Electrolytic Capacitor	24-350106
C94	100 μ F, 25 V, Electrolytic Capacitor	24-250107
C96	.0027 μ F, 50 V, Ceramic Capacitor	122015-272
Connectors		
OP1L-OP3L	6-Position Header Connector	179177-006
OP1U-OP3U	6-Position Header Connector	179177-006
OP1L-OP3L	2-Position Connector Receptacle	179178-002
OP1U-OP3U	2-Position Connector Receptacle	179178-002
Transistors		
Q3	Integrated Circuit, 79L05 (Acceptable substitute is part number 37-7905)	37-79L05
Q4	Transistor, 2N3904	34-2N3904
Q5, Q6	Transistor, 2N3906	33-2N3906
Resistors		
R1	330 Ω , \pm 5%, 1/4 W Resistor	110000-331
R2	220 Ω , \pm 5%, 1/4 W Resistor	110000-221
R3, R4	4.7 k Ω , \pm 5%, 1/4 W Resistor	110000-472
R5	2.4 k Ω , \pm 5%, 1/4 W Resistor	110000-242

LSI Cartridge 3 PCB Assembly Parts List, Continued

Designator	Description	Part No.
R6-R9	4.7 k Ω \times 9 Single-In-Line-Package Resistor	118010-472
R10, R11	2.4 k Ω , \pm 5%, 1/4 W Resistor	110000-242
R12-R14	4.7 k Ω \times 9 Single-In-Line-Package Resistor	118010-472
R15-R17	2.4 k Ω , \pm 5%, 1/4 W Resistor	110000-242
R20	10 k Ω , \pm 5%, 1/4 W Resistor	110000-103
R21	5.6 k Ω , \pm 5%, 1/4 W Resistor	110000-562
R22	10 k Ω , \pm 5%, 1/4 W Resistor	110000-103
R23	43 k Ω , \pm 5%, 1/4 W Resistor	110000-433
R24, R25	20 k Ω , \pm 5%, 1/4 W Resistor	110000-203
R26	43 k Ω , \pm 5%, 1/4 W Resistor	110000-433
R27	1.8 k Ω , \pm 5%, 1/4 W Resistor	110000-182
R28	3.3 k Ω , \pm 5%, 1/4 W Resistor	110000-332
R29	390 Ω , \pm 5%, 1/4 W Resistor	110000-391
R30	56 k Ω , \pm 5%, 1/4 W Resistor	110000-563
R31	12 k Ω , \pm 5%, 1/4 W Resistor	110000-123
R32	1 k Ω , \pm 5%, 1/4 W Resistor	110000-102
R33	10 k Ω , \pm 5%, 1/4 W Resistor	110000-103
R34	3.3 k Ω , \pm 5%, 1/4 W Resistor	110000-332
R35	8.2 k Ω , \pm 5%, 1/4 W Resistor	110000-822
R36	3.3 k Ω , \pm 5%, 1/4 W Resistor	110000-332
R37	10 k Ω , \pm 5%, 1/4 W Resistor	110000-103
R38	3.9 k Ω , \pm 5%, 1/4 W Resistor	110000-392
R39	10 k Ω , \pm 5%, 1/4 W Resistor	110000-103
R40	4.7 k Ω , \pm 5%, 1/4 W Resistor	110000-472
Miscellaneous		
GND1, GND2	Test Point	179051-002
+ 5V1, + 5V2	Test Point	179051-002
	14-Contact, Medium-Insertion-Force IC Socket	79-42C14
	16-Contact, Medium-Insertion-Force IC Socket	79-42C16
	20-Contact, Medium-Insertion-Force IC Socket	79-42C20
	28-Contact, Medium-Insertion-Force IC Socket	79-42C28
	40-Contact, Medium-Insertion-Force IC Socket	79-42C40

N

O

T

E

S



Road Runner*

Coin Information and Game Statistics

Date: _____

Aux Coins	_____	Not used in Road Runner game
Left Coins	_____	Number of coins deposited in left coin mechanism
Right Coins	_____	Number of coins deposited in right coin mechanism
1 Plyr Games	_____	Number of games played as a 1-player game
2 Plyr Games	_____	Number of games played as a 2-player game
Mins Played	_____	Total time, in minutes, of all games played
Mins Pwr Up	_____	Total time, in minutes, the game has been turned on
Aux Cntr 1	_____	Total number of times game continuation feature used
Aux Cntr 2	_____	Total number of tickets dispensed
Aux Cntr 3	_____	For manufacturing use only
Error Count	_____	EEPROM errors
Avg. Game Time	_____	Average game time per play in seconds

Histogram Information

Length of Game in Seconds	Number of Games That Reached Level						
	1	2	3	4	5	6	7
0-59	_____	_____	_____	_____	_____	_____	_____
60-89	_____	_____	_____	_____	_____	_____	_____
90-119	_____	_____	_____	_____	_____	_____	_____
120-149	_____	_____	_____	_____	_____	_____	_____
150-179	_____	_____	_____	_____	_____	_____	_____
180-209	_____	_____	_____	_____	_____	_____	_____
210-239	_____	_____	_____	_____	_____	_____	_____
240-269	_____	_____	_____	_____	_____	_____	_____
270-299	_____	_____	_____	_____	_____	_____	_____
300-329	_____	_____	_____	_____	_____	_____	_____
330-359	_____	_____	_____	_____	_____	_____	_____
360-389	_____	_____	_____	_____	_____	_____	_____
390-419	_____	_____	_____	_____	_____	_____	_____
420-449	_____	_____	_____	_____	_____	_____	_____
450-479	_____	_____	_____	_____	_____	_____	_____
480-509	_____	_____	_____	_____	_____	_____	_____
510-539	_____	_____	_____	_____	_____	_____	_____
540 and up	_____	_____	_____	_____	_____	_____	_____
High Score	_____	_____	_____	_____	_____	_____	_____

Histogram Levels 1-4:

Number of games that ended at that level (1-4). These are only games that were played without using the game continuation feature.

Histogram Level 5:

Number of games that ended on level 5 or above. These are only games not using the game continuation feature.

Histogram Level 6:

Number of games that ended on the level where started. These are only games that were played using the game continuation feature.

Histogram Level 7:

Number of games that progressed to a higher level than the starting level. These are only games that were played using the game continuation feature.

*Trademark of Warner Bros. Inc. used by Atari Games Corporation under license



Glossary

AC

Alternating current; from zero it rises to a maximum positive level, then passes through zero again to a maximum negative level.

ACTIVE STATE

The true state of a signal. For example: The active state for $\overline{\text{START}}$ is low.

ADDRESS

A value that identifies a specific location of data in memory; normally expressed in hexadecimal notation.

ANALOG

Measurable in an absolute quantity (as opposed to on or off). Analog devices are volume controls, light dimmers, stereo amplifiers, etc.

ANODE

The positive (arrow) end of a diode.

AMPLIFIER

A device used to increase the strength of an applied signal.

AMPLITUDE

The maximum instantaneous value of a waveform pulse from zero.

ASTABLE

Having no normal state. An astable device will free-run or oscillate as long as operating voltage is applied. The oscillation frequency is usually controlled by external circuitry.

AUXILIARY COIN SWITCH

A momentary-contact pushbutton switch with a black cap located on the utility panel. The auxiliary coin switch adds credits to the game without activating a coin counter.

BEZEL

A cut, formed, or machined retention device, such as the conical device used to mount a pushbutton switch to a control panel, or the formed device used to frame the video display screen.

BIDIRECTIONAL

Able to send or receive data on the same line (e.g., the data bus of a microprocessor).

BINARY

A number system that expresses all values by using two digits (0 and 1).

BIT

A binary digit; expressed as 1 or 0.

BLANKING

Turning off the beam on a cathode-ray tube during retrace.

BLOCK DIAGRAM

A drawing in which functional circuitry units are represented by blocks. Very useful during initial troubleshooting.

BUFFER

1. An isolating circuit designed to eliminate the reaction of a driven circuit on the circuits driving it (e.g., a buffer amplifier).

2. A device used to supply additional drive capability.

BUS

An electrical path over which information is transferred from any of several sources to any of several destinations.

CAPACITOR

A device capable of storing electrical energy. A capacitor blocks the flow of DC current while allowing AC current to pass.

CATHODE

The negative end of a diode.

CHIP

An integrated circuit comprising many circuits on a single wafer slice.

CLOCK

A repetitive timing signal for synchronizing system functions.

COINCIDENCE

Occurring at the same time.

COIN COUNTER

A 6-digit electromechanical device that counts the coins inserted in the coin mechanism(s).

COIN MECHANISM

A device on the inside of the coin door that inspects the coin to determine if the correct coin has been inserted.

COMPLEMENTARY

Having opposite states, such as the outputs of a flip-flop.

COMPOSITE SYNC

Horizontal and vertical synchronization pulses that are bused together into a single signal. This signal provides the timing necessary to keep the display in synchronization with the game circuitry.

COMPOSITE VIDEO

Complete video signal from the game system to drive the display circuitry, usually comprising H SYNC, V SYNC, and the video.

CREDIT

One play for one person based on the game switch settings.

CRT

Cathode-ray tube.

DATA

General term for the numbers, letters, and symbols that serve as input for device processing.

DARLINGTON

A two-transistor amplifier that provides extremely high gain.

DC

Direct current, meaning current flowing in one direction and of a fixed value.

DEFLECTION YOKE

Electromagnetic coils around the neck of a cathode-ray tube. One set of coils deflects the electron beam horizontally and the other set deflects the beam vertically.

DIAGNOSTICS

A programmed routine for checking circuitry. For example: the self-test is a diagnostic routine.

DIODE

A semiconductor device that conducts in only one direction.

DISCRETE

Non-integrated components, such as resistors, capacitors, and transistors.

DMA

Direct memory access. DMA is a process of accessing memory that bypasses the microprocessor logic. DMA is normally used for transferring data between the input/output ports and memory.

DOWN TIME

The period during which a game is malfunctioning or not operating correctly due to machine failure.

EAROM

Electrically alterable read-only memory (see ROM). The EAROM is a memory that can be changed by the application of high voltage.

FLYBACK

A step-up transformer used in a display to provide the high voltage.

GATE

1. A circuit with one output that responds only when a certain combination of pulses is present at the inputs.

2. A circuit in which one signal switches another signal on and off.

3. To control the passage of a pulse or signal.

HARNESS

A prefabricated assembly of insulated wires and terminals ready to be attached to a piece of equipment.

HEXADECIMAL

A number system using the equivalent of the decimal number 16 as a base. The symbols 0-9 and A-F are usually used.

IMPLODE

To burst inward; the inward collapse of a vacuum tube.

I/O

Input/Output.

IRQ

Interrupt request. IRQ is a control signal to the microprocessor that is generated by external logic. This signal tells the microprocessor that external logic needs attention. Depending on the program, the processor may or may not respond.

LED

The abbreviation for a light-emitting diode.

LOCKOUT COIL

Directs coins into the coin return box when there is no power to the game.

LOGIC STATE

The binary (1 or 0) value at the node of a logic element or integrated circuit during a particular time. Also called the logic level. The list below shows the voltage levels corresponding to the logic states (levels) in a TTL system.

Logic 0, Low = 0 VDC to +0.8 VDC
Grey Area (Tri-State Level) =

+0.8 VDC to +2.4 VDC

Logic 1, High = +2.4 VDC to +5 VDC

MULTIPLEXER

A device that takes several low-speed inputs and combines them into one high-speed data stream for simultaneous transmission on a single line.

NMI

Non-maskable interrupt. NMI is a request for service by the microprocessor from external logic. The microprocessor cannot ignore this interrupt request.

PAGE

A subsection of memory. A read-only memory device (see ROM) is broken into discrete blocks of data. These blocks are called pages. Each block has X number of bytes.

PCB

The abbreviation for a printed-circuit board.

PHOTOTRANSISTOR

A transistor that is activated by an external light source.

POTENTIOMETER

1. A resistor that has a continuously moving contact which is generally mounted on a moving shaft. Used chiefly as a voltage divider. Also called a *pot* (slang).

2. An instrument for measuring a voltage by balancing it against a known voltage.

RAM

Random-access memory. A device for the temporary storage of data.

RASTER-SCAN DISPLAY

A display system whereby images are displayed by continuously scanning the cathode-ray tube horizontally and vertically with an electron beam. The display system controls the intensity of the electron beam.

RETRACE

In a raster-scan display, retrace is the time during which the cathode-ray tube electron beam is resetting either from right to left or from bottom to top.

RESISTOR

A device designed to have a definite amount of resistance. Used in circuits to limit current flow or to provide a voltage drop.

ROM

Read-only memory. A device for the permanent storage of data.

SIGNATURE ANALYSIS

A process of isolating digital logic faults at the component level by means of special test equipment called signature analyzers. Basically, signature analyzers (e.g., the ATARI® CAT Box) convert lengthy bit streams into four-digit hexadecimal signatures. The signature read by the analyzer at each circuit node is then compared with the known good signature for that node. This process continues until a fault is located.

TROUBLESHOOT

The process of locating and repairing a fault.

VECTOR

A line segment drawn between specific X and Y coordinates on a cathode-ray tube.

WATCHDOG

A counter circuit designed to protect the microprocessor from self-destruction if a program malfunction occurs. If a malfunction does occur, the counter applies continuous pulses to the reset line of the microprocessor, which causes the microprocessor to keep resetting.

X-Y DISPLAY

A display system whereby images are displayed with vectors.

ZENER DIODE

A special diode used as a regulator. Its main characteristic is breaking down at a specified reverse-bias (Zener) voltage.

Warranty

Seller warrants that its printed-circuit boards and parts thereon are free from defects in material and workmanship under normal use and service for a period of ninety (90) days from date of shipment. Seller warrants that its video displays and laser video disc players (in games supplied with displays and video-disc players) are free from defects in material and workmanship under normal use and service for a period of thirty (30) days from date of shipment. None of the Seller's other products or parts thereof are warranted.

If the products described in this manual fail to conform to this warranty, Seller's sole liability shall be, at its option, to repair, replace, or credit Buyer's account for such products which are returned to Seller during said warranty period, provided:

- (a) Seller is promptly notified in writing upon discovery by Buyer that said products are defective;
- (b) Such products are returned prepaid to Seller's plant; and
- (c) Seller's examination of said products discloses to Seller's satisfaction that such alleged defects existed and were not caused by accident, misuse, neglect, alteration, improper repair, installation, or improper testing.

In no event shall Seller be liable for loss of profits, loss of use, incidental or consequential damages.

Except for any express warranty set forth in a written contract between Seller and Buyer which contract supersedes the terms herein, this warranty is expressed in lieu of all other warranties expressed or implied, including the implied warranties of merchantability and fitness for a particular purpose, and of all other obligations or liabilities on the Seller's part, and it neither assumes nor authorizes any other person to assume for the Seller any other liabilities in connection with the sale of products by Seller.

The use of any non-Atari parts may void your warranty, according to the terms of the warranty. The use of any non-Atari parts may also adversely affect the safety of your game and cause injury to you and others. Be very cautious in using non-Atari-supplied components with our games, in order to ensure your safety.

Atari distributors are independent, being privately owned and operated. In their judgment they may sell parts or accessories other than Atari parts or accessories. Atari Games Corporation cannot be responsible for the quality, suitability or safety of any non-Atari part or any modification including labor which is performed by such distributor.



Atari Games Corporation
675 Sycamore
P.O. Box 361110
Milpitas, California 95035
(408) 434-3950
Telex 5101007850

