



# RELIEF PITCHER



**Kit Installation  
Instructions**



## For technical assistance:

If reading through this manual does not lead to solving your game maintenance or repair problem, call TELE-HELP® at one of these Atari Games Customer Service offices:

### UNITED STATES

Atari Games Corporation  
California Customer Service Office  
737 Sycamore Drive  
Milpitas, CA 95036-1110

Fax (408) 434-3945  
Telex 5101007850

☎ (408) 434-3950

(Monday-Friday, 7:30 a.m.-4:00 p.m. Pacific time)

### EUROPE

Atari Games Ireland Limited  
European Customer Service Office  
Tipperary Town, Ireland

Fax 062-51702  
Telex 70665

☎ 062-52155

(Monday-Friday, 9:00 a.m.-5:30 p.m. GMT)



*This entire manual was  
printed on recycled paper*



# RELIEF PITCHER



Universal  
Conversion Kit  
for the Atari 2600

*Conversion kit for upright games*

**Copyright © 1992 by Atari Games Corporation. All rights reserved.**

No part of this publication may be reproduced by any mechanical, photographic or electronic process, or in the form of a phonographic recording, nor may it be stored in a retrieval system, transmitted, or otherwise copied for public or private use, without permission from the publisher.

The game play, all graphic designs, this technical manual, its accompanying schematic diagrams, and the display manual are protected by the U.S. Copyright Act of 1976.

This Act provides for substantial penalties for violating federal copyright laws. Courts can impound infringing arti-

cles while legal action is pending. If infringers are convicted, courts can order destruction of the infringing articles.

In addition, the Act provides for payment of statutory damages of up to \$50,000 per infringing transaction in certain cases. Infringers may also have to pay costs and attorneys' fees and face an imprisonment of up to five years as well as fines of up to \$250,000 in the case of individuals and up to \$500,000 in the case of corporations.

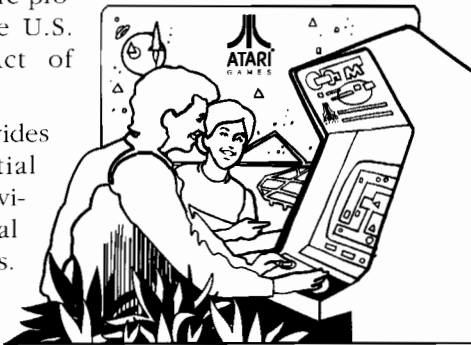
Atari Games Corporation will aggressively enforce its copyrights against infringers. We will use all legal means to immediately halt any manufacture, distribution, or operation of a copy of video games made by us. Anyone who purchases such copies risks forfeiting such a game.

Published by:  
Atari Games Corporation  
675 Sycamore Drive  
P.O. Box 361110  
Milpitas, California 95036

Printed in the U.S.A.    **03/92**

Produced by the Atari Games Technical Publications Department.

Writing and Editing: Andrea Dencker  
Illustration and Design: Mary Ohanessian Sumner



**NOTICE RE.  
NON-ATARI  
PARTS**

**WARNING**

*Use of non-Atari parts or modifications of any Atari game circuitry may adversely affect the safety of your game, and may cause injury to you and your players.*

You may void the game warranty (printed on the inside back cover of this manual) if you do any of the following:

- Substitute non-Atari parts in the game.
- Modify or alter any circuits in the game by using kits or parts *not* supplied by Atari Games Corporation.

**NOTE**

This equipment generates, uses, and can radiate radio frequency energy, and if not installed and used in accordance with the instruction manual, may cause interference to radio communications. It has been tested and found to comply with the limits for a Class A computing device pursuant to Subpart J of Part 15 of Federal Communications Commission (FCC) Rules, which are designed to provide reasonable protection against such interference when operated in a commercial environment. Operation of this equipment in a residential area or modification to this equipment is likely to cause interference, in which case the user, at his own expense, will be required to take whatever measures may be required to correct the interference. If you suspect interference from an Atari game at your location, check the following:

- All ground wires in the game are properly connected as shown in the game wiring diagram.
- The power cord is properly plugged into a grounded three-wire outlet.
- On games provided with an Electromagnetic Interference (EMI) ground plane, be sure that the game printed-circuit boards (PCBs) are properly installed on the EMI ground plane and that the end board is securely installed with **all** screws in place and tightened.

If you are still unable to solve the interference problem, please contact Customer Service at Atari Games Corporation. See the inside front cover of this manual for service in your area.

## S A F E T Y   S U M M A R Y

The following safety precautions apply to all game operators and service personnel. Specific warnings and cautions will be found in this manual whenever they apply.

### WARNING

**Properly Ground the Game.** Players may receive an electrical shock if this game is not properly grounded! To avoid electrical shock, do not plug in the game until it has been inspected and properly grounded. This game should only be plugged into a grounded three-wire outlet. If you have only a two-wire outlet, we recommend you hire a licensed electrician to install a three-wire grounded outlet. If the control panel is not properly grounded, players may receive an electrical shock! After servicing any part on the control panel, check that the grounding wire is firmly secured to the inside of the control panel. After you have checked this, lock up the game.

**AC Power Connection.** Before you plug in the game, be sure that the game's power supply can accept the AC line voltage in your location. The line voltage requirements are listed in the first chapter of this manual.

**Disconnect Power During Repairs.** To avoid electrical shock, disconnect the game from the AC power before removing or repairing any part of the game. If you remove or repair the video display, be very careful to avoid electrical shock. High voltages continue to exist even after power is disconnected in the display circuitry and the cathode-ray tube (CRT). Do not touch the internal parts of the display with your hands or with metal objects! Always discharge the high voltage from the CRT before servicing it. Do this after you disconnect it from the power source. First, attach one end of a large, well-insulated, 18-gauge jumper wire to ground. Then momentarily touch the free end of the grounded jumper wire to the CRT anode by sliding the wire under the anode cap. Wait two minutes and do this again.

**Use Only Atari Parts.** To maintain the safety of your Atari game, use only Atari parts when you repair it. Using non-Atari parts or modifying the game circuitry

may be dangerous, and could injure you and your players.

**Handle the CRT With Care.** If you drop the CRT and it breaks, it may implode! Shattered glass from the implosion can fly six feet or more.

**Use the Proper Fuses.** To avoid electrical shock, use replacement fuses which are specified in the parts list for this game. Replacement fuses must match those replaced in fuse type, voltage rating, and current rating. In addition, the fuse cover must be in place during game operation.

### CAUTION

**Properly Attach All Connectors.** Make sure that the connectors on each printed circuit board (PCB) are properly plugged in. The connectors are keyed to fit only one way. If they do not slip on easily, do not force them. If you reverse a connector, it may damage your game and void your warranty.

**Ensure the Proper AC Line Frequency.** Video games manufactured for operation on 60 Hz line power (used in the United States) must not be operated in countries with 50 Hz line power (used in Europe). If a 60 Hz machine operates on 50 Hz line

power, the fluorescent line ballast transformer will overheat and cause a potential fire hazard. Check the product identification label on your machine for the line frequency required.

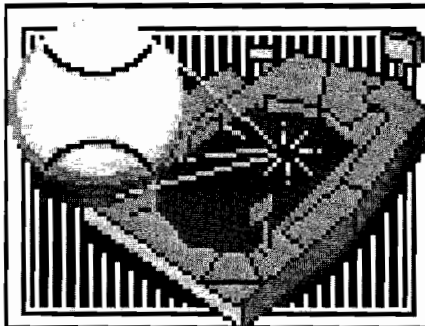
### ABOUT NOTES, CAUTIONS, AND WARNINGS

In Atari publications, notes, cautions and warnings have the following meaning:

**NOTE** — A highlighted piece of information.

**CAUTION** — Equipment and/or parts can be damaged or destroyed if instructions are not followed. You will void the warranty on Atari printed-circuit boards, parts thereon, and video displays if equipment or parts are damaged or destroyed due to failure of following instructions.

**WARNING** — Players and/or technicians can be killed or injured if instructions are not followed.



# CONTENTS

## 1 Installation

How to Use This Manual .....	1-1
Cabinet Equipment Requirements .....	1-2
Tools Required.....	1-2
Inspecting the Kit .....	1-4
Preparing the Cabinet for the Kit Installation .....	1-4
Assembling the Control Panel.....	1-4
Connecting the JAMMA Harness.....	1-6
Installing a Baseball Card Dispenser .....	1-7
Installing the Relief Pitcher Board Set .....	1-7
Installing the Bezel, Decals, Labels, and Attraction Assembly .....	1-8
Setting the Coin and Game Options.....	1-8
Maximizing Earnings .....	1-8
Game Play .....	1-9

## 2 Self-Test

Introduction .....	2-1
Entering and Exiting the Self-Test.....	2-2
Self-Test Menu.....	2-2
Adjust Volume.....	2-2
Statistics .....	2-2
Game Options.....	2-3
Regional Settings.....	2-3
Card Dispenser Options .....	2-3

Coin Options.....	2-4
Sound Board Test .....	2-5
Controls Test .....	2-5
RAM Tests.....	2-6
ROM Test.....	2-6
Alphanumeric Test.....	2-6
Motion Object Tests.....	2-7
Playfield Tests .....	2-7
Monitor Tests .....	2-7

## 3 Troubleshooting and Maintenance

Introduction .....	3-1
Video Display Sync Problems .....	3-3
Troubleshooting.....	3-3
Removing and Replacing the Joystick Control.....	3-3
ROMs and RAMs.....	3-4

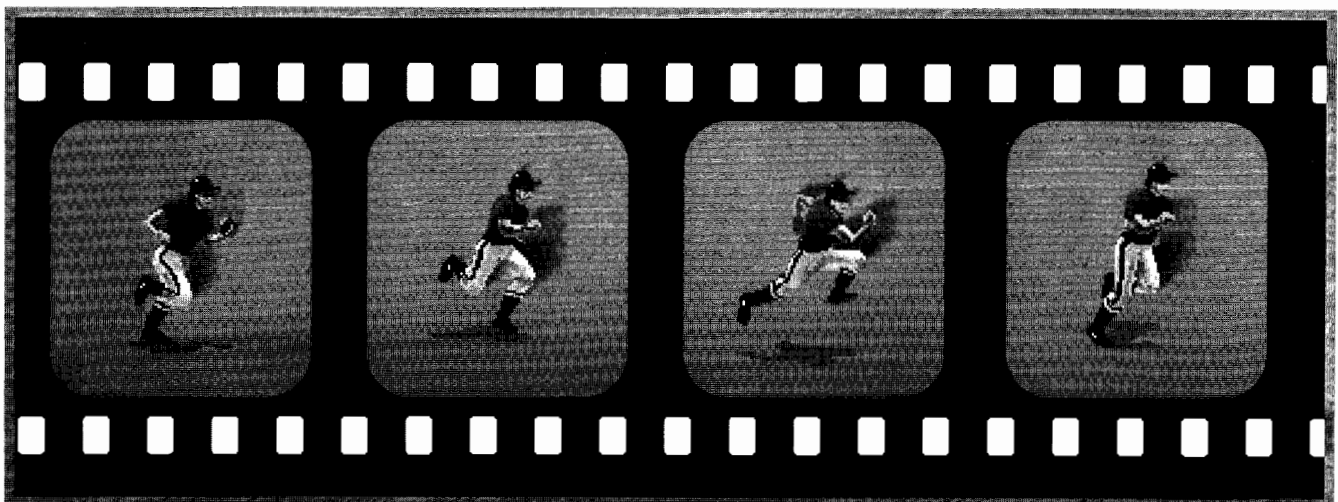
## 4 Parts Illustrations

See the List of Illustrations that follows.

## 5 Schematic Diagrams

See the List of Illustrations that follows.

## Statistics Sheet



## ILLUSTRATIONS

Figure 1-1	Installed Kit Parts.....	1-3
Figure 1-2	Locations of Control Panel Holes to be Drilled.....	1-6
Figure 1-3	Hole-Cutting Template for Relief Pitcher Kit Control Panel (Left Side)....	1-11
Figure 1-4	Hole-Cutting Template for Relief Pitcher Kit Control Panel (Right Side)...	1-13
Figure 2-1	Self-Test Menu Screen.....	2-2
Figure 2-2	Adjust Volume Screen.....	2-3
Figure 2-3	Game Statistics Screen.....	2-3
Figure 2-4	Game Options Screen .....	2-3
Figure 2-5	Regional Settings Screen .....	2-4
Figure 2-6	Coin Options Screen .....	2-4
Figure 2-7	Sound Test Screen .....	2-5
Figure 2-8	Controls Test Screen.....	2-5
Figure 2-9	RAM Tests Sub-Menu.....	2-6
Figure 2-10	ROM Test Screen .....	2-6
Figure 2-11	Alpha Test Screen.....	2-6
Figure 2-12	Motion Object Test Screen.....	2-7
Figure 2-13	Playfield Scrolling Test Screen.....	2-7
Figure 2-14	Color Test Screen.....	2-7
Figure 2-15	Convergence Test Screen.....	2-8
Figure 4-1	Parts of Relief Pitcher Universal Kit....	4-2
Figure 4-2	Control Panel Parts .....	4-3

Figure 4-3	8-Position, Gold-Contact Joystick Assembly .....	4-4
Figure 4-4	Relief Pitcher Game PCB Assembly .....	4-5
Figure 4-5	Relief Pitcher Audio PCB Assembly....	4-8
Figure 5-1	Relief Pitcher Game PCB Assembly Schematic Diagram.....	5-2
Figure 5-2	Relief Pitcher Audio PCB Assembly Schematic Diagram.....	5-6

## TABLES

Table 1-1	Equipment Requirements.....	1-2
Table 1-2	Contents of Relief Pitcher Kit.....	1-2
Table 1-3	JAMMA Pin and Wire Connections.....	1-5
Table 2-1	Summary of All Self-Test Screens.....	2-2
Table 2-2	Game Option Settings .....	2-4
Table 2-3	Coin Option Settings .....	2-5
Table 2-4	When to Run the RAM Tests .....	2-6
Table 3-1	Troubleshooting Table.....	3-2
Table 3-2	Voltage Inputs and Test Points on the PCBs.....	3-3
Table 3-3	What ROM Problems Look Like.....	3-3
Table 3-4	Atari Games Video Connector Pin Assignments.....	3-3

---

**N O T E S**

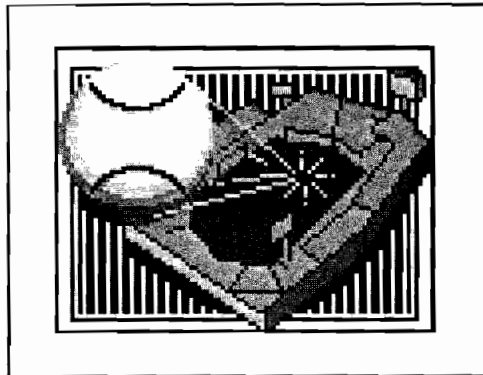




# Installation

## HOW TO USE THIS MANUAL

**T**he Relief Pitcher™ conversion kit is a two-player game for a standard upright cabinet. ☞ This manual provides information for installing, testing, and troubleshooting the Relief Pitcher™ conversion kit. ☞ Chapter 1 describes how to install the Relief Pitcher kit in your cabinet. This chapter also describes game play. ☞ Chapter 2 contains self-test procedures and additional diagnostic tests. The self-test is important in the Relief Pitcher game.



You can troubleshoot the PC boards, main circuits, and controls using the screens in the self-test. You should regularly test the boards and controls with the self-test to keep

your game in peak condition and at top earnings. ☞ Chapter 3 contains troubleshooting and maintenance procedures for the controls. ☞ Chapter 4 contains the kit parts list and parts illustrations. ☞ Chapter 5 contains the schematics for the Relief Pitcher printed-circuit boards.

**WARNING**

To avoid electrical shock, unplug the cabinet while installing the kit. After installation, plug the game only into a grounded 3-wire outlet.

**Cabinet Equipment Requirements**

Table 1-1 lists the equipment required in the cabinet into which you are installing the Relief Pitcher kit.

**CAUTION**

Do not unplug or plug in the Relief Pitcher game printed-circuit board (PCB) edge connector while the power is on. You could seriously damage the PCB.



Equipment	Specification
Video Display	Color RGB monitor Separate positive horizontal and vertical sync or negative composite sync Horizontal mounting Horizontal frequency: 15.750 KHz Vertical frequency: 60 Hz Video input: 1V to 3V peak-to-peak positive polarity
Control Panel	Metal only
Speaker	8 Ω, 10 W
Coin Counter	+5 VDC or +12 VDC
Power Cord	Three-conductor with ground
Power Supply	+5 VDC ± 0.25V @ 3.0 amps +12 VDC @ 1.0 amp -5 VDC @ 1.0 amp (optional)

**Table 1-1 Equipment Requirements**

**Tools Required**

- Drill with a 1/2-inch and 5/16-inch drill bits
- Phillips screwdriver
- Flat-blade screwdriver
- Socket wrench set and ratchet
- 5/32" hex wrench
- Wire cutters and strippers
- Straight edge
- Squeegee
- X-ACTO™ knife
- Insulated wire connectors (if you are installing a new JAMMA harness)
- Carbon paper
- Saber saw

Part No.	Description
72-6608S	#6 x 1/2"-Long, Type AB, Pan-Head, Cross-Recessed Screws (4)
75-5112B	#10-24 x 3/4"-Long Black Carriage Bolts (12)
038158-01	Product I.D. Label
039450-01	FCC Compliance Label
047205-01	Attraction Shield
047209-01	Control Panel Cover
049962-01	Side Panel Decals (2)
049963-01	Attraction Panel Film
049964-01	Control Panel Decal
049965-01	Monitor Bezel with Graphics
049967-01	Sheet of Control-Panel Labels
141026-001	1/2"-I.D. Ferrite Split Beads (4)
160044-001	Snap-Action Switch
171099-001	8-Position Black NO/NC Joystick Assembly with Gold-Plated Switch Contacts (2)
171104-001	Round Pushbutton Switch Assy. with Gold Contacts, in 3 Sections: Red, Yellow, and Green (2)
175014-1040	#10 Flat Washers (12)
177026-0040	#10-24 Zinc Nut/Washer Assemblies (12)
178032-002	#10 Wire & Cable Ties (2)
178283-011	"START" Indicator Plate
178237-004	White Start Button Assembly
178265-001	L-Style Nylon Standoffs (4)
TM-376	Relief Pitcher Universal Kit Installation Instructions (with control panel template)
A046501-01	JAMMA Harness Assembly (optional)
A050247-01	Relief Pitcher PC Board Set

Packaging materials are not listed. All parts are a quantity of 1, except as noted in parentheses.

**Table 1-2 Contents of Relief Pitcher Kit**

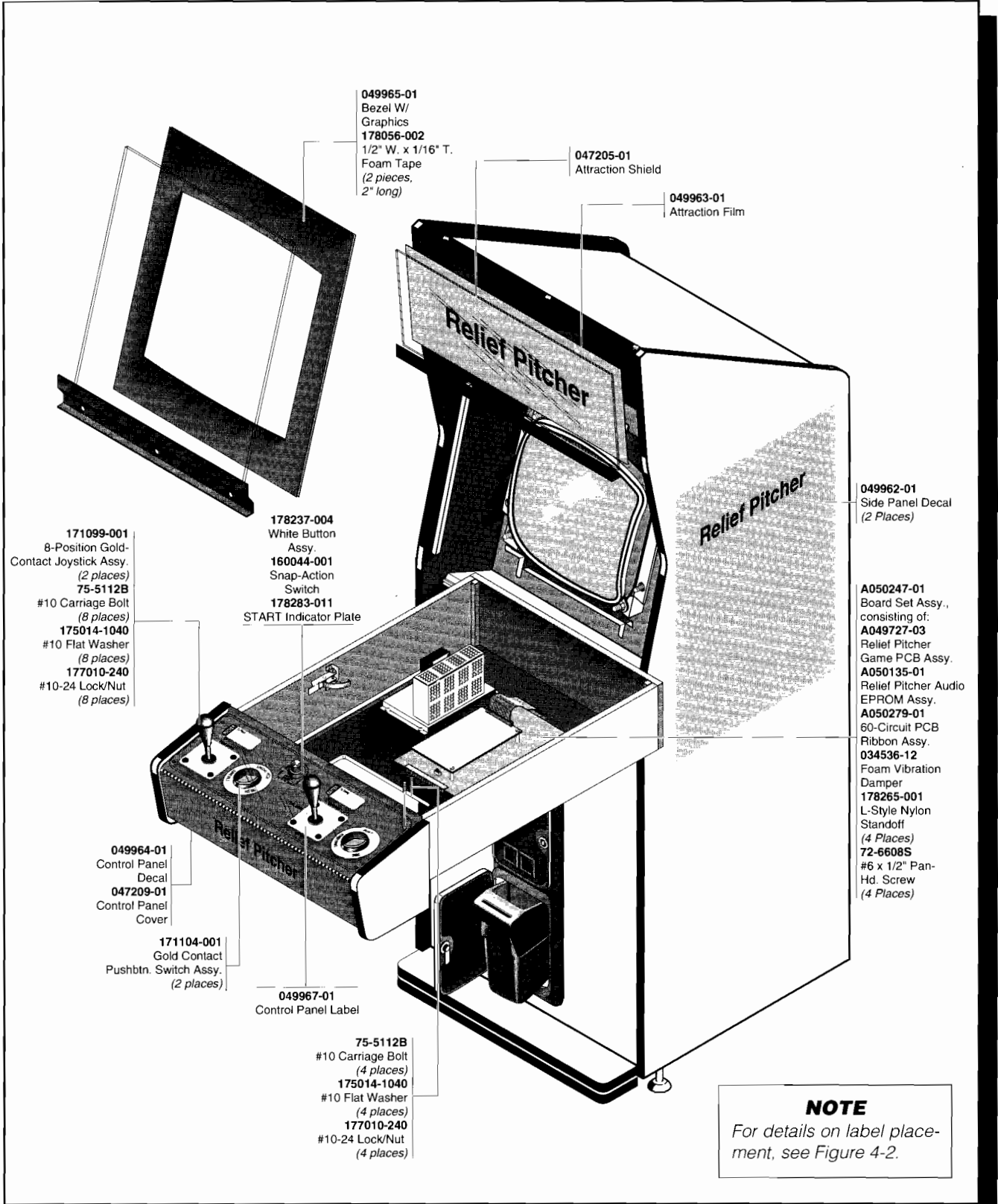


Figure 1-1 Installed Kit Parts

- File
- Bandsaw
- Tape or glue

## Inspecting the Kit

Check to see that you have all the parts listed in the kit parts list in Table 1-2. If any part is missing or damaged, contact your distributor with the Relief Pitcher kit serial number, part number, and description of the missing or damaged parts, and date received.

## Preparing the Cabinet for the Kit Installation

### WARNING

*To avoid electrical shock, unplug the cabinet while installing the kit. After installation, plug the game only into a grounded 3-wire outlet.*

Figure 1-1 shows almost all kit parts installed in a typical cabinet. Use this illustration as a guide while you install the parts.

1. Turn off power to the game, and unplug the power cord.
2. Remove the following from the cabinet:
  - Existing PCBs
  - Game harness, if it is not Japan Amusement Machinery Manufacturers Association (JAMMA)-compatible. Table 1-3 assumes you have an available game cabinet with a JAMMA harness installed in it.
  - Control panel decals, labels, and controls
  - Side decals, graphics, and adhesive. If the cabinet sides are damaged, repair them before putting on the new decals.
  - Video display (monitor) shield, display bezel, attraction shield, and marquee.
3. Wipe down and vacuum the cabinet. Paint the cabinet, if required.

## Assembling the Control Panel

### Parts Needed from this Kit

To assemble the control panel, you need the control panel hole-cutting template, which is printed in Figure

1-3. Cut out the template sheet from this manual. You will also need the following parts from the kit:

- Clear cover for the control panel
- Control-panel decal
- Start button assembly, snap-action switch, and “START” indicator plate
- Sheet of control-panel labels
- Two joystick assemblies
- Two pushbutton 3-color switches
- Twelve #10-24 x ¾"-long black carriage bolts, flat washers, and nut/washer assemblies — four for the corners of the control-panel cover and eight for the joysticks

### Installing the Parts

1. Using carbon paper, transfer the steering control mounting pattern from the template to the control panel. Save the template. Also refer to Figure 1-2 or 1-3 for the exact locations of all control-panel holes.
2. Using a saber saw, carefully cut out the large hole for the joystick controls and the smaller hole for the start button. Deburr the sharp edges with a file.
3. Lay the plastic cover over the top of the control panel and mark the outside shape of the panel on the plastic. Also mark the button holes as close as possible to the locations shown on the template.
 

Lastly, mark the positions of the four holes that will be used for securing the cover to the control panel. These four holes can be placed anywhere near the corners — wherever space permits.
4. Using a bandsaw, cut the control panel cover to its correct outside shape.

### WARNING

*Wear safety glasses when drilling the plastic control panel cover. Use care to avoid shattering or chipping the plastic.*

5. Tape or glue the template to the plastic cover. To start the saber saw cut, drill a 1/2" hole inside the joystick holes and the start button hole.
6. Saw out the large joystick holes and the start button hole.
7. Drill the four ¼" holes that will be used to mount the cover to the control panel and the holes to mount the joystick controls and start button.

**Solder Side****Component Side**

Color <sup>1</sup>	Signal	Pin	Pin	Signal	Color <sup>1</sup>
Brown	POWER GND	<b>A</b>	<b>1</b>	POWER GND	Brown
Brown <sup>2</sup>	POWER GND	<b>B</b>	<b>2</b>	POWER GND	Brown
Red	+5V DC	<b>C</b>	<b>3</b>	+5V DC	Red
Red	+5V DC	<b>D</b>	<b>4</b>	+5V DC	Red <sup>3</sup>
Orange <sup>4</sup>	-5V	<b>E</b>	<b>5</b>	-5V	Orange
Yellow <sup>5</sup>	+12V DC	<b>F</b>	<b>6</b>	+12V DC	Yellow
—	<b>Key</b>	<b>H</b>	<b>7</b>	<b>Key</b>	—
Violet/White <sup>6</sup>	COIN CTR 2	<b>J</b>	<b>8</b>	COIN CTR 1	Violet/White <sup>7</sup>
—	Not Used	<b>K</b>	<b>9</b>	Not Used	—
White	SPKR -	<b>L</b>	<b>10</b>	SPKR +	Brown
—	Not Used	<b>M</b>	<b>11</b>	Not Used	—
Green	VIDEO GREEN	<b>N</b>	<b>12</b>	VIDEO RED	Red
Brown	VIDEO NEG. SYNC	<b>P</b>	<b>13</b>	VIDEO BLUE	Blue
—	Not Used	<b>R</b>	<b>14</b>	VIDEO GND	Black
—	Not Used	<b>S</b>	<b>15</b>	SELF-TEST	White <sup>8</sup>
Orange	RT COIN	<b>T</b>	<b>16</b>	LT COIN	Yellow
—	Not Used	<b>U</b>	<b>17</b>	START	White/Black
Yellow/Brown	RT PLYR UP	<b>V</b>	<b>18</b>	LT PLYR UP	White/Brown
Yellow/Red	RT PLYR DOWN	<b>W</b>	<b>19</b>	LT PLYR DOWN	White/Red
Yellow/Orange	RT PLYR LEFT	<b>X</b>	<b>20</b>	LT PLYR LEFT	White/Orange
Yellow/White	RT PLYR RIGHT	<b>Y</b>	<b>21</b>	LT PLYR RIGHT	Yellow
Yellow/Green	SWING	<b>Z</b>	<b>22</b>	FAST BALL	White/Green
Yellow/Blue	POWER SWING	<b>a</b>	<b>23</b>	CURVE BALL	White/Blue
Yellow/Violet	BUNT	<b>b</b>	<b>24</b>	SPECIAL PITCH	White/Violet
—	Not Used	<b>c</b>	<b>25</b>	Not Used	—
—	Not Used	<b>d</b>	<b>26</b>	Not Used	—
Black/White	SWITCH GND	<b>e</b>	<b>27</b>	SWITCH GND	Black/White
Black/White	SWITCH GND	<b>f</b>	<b>28</b>	SWITCH GND	Black/White

**Footnotes**

<sup>1</sup> The colors listed are for reference only. They are the colors used on the JAMMA harness available from Atari.

<sup>2</sup> Connect to the 5V GND (RTN) terminal on the power supply. However, if you have 12V GND, connect *one* of the wires at pin 1, 2, A, or B to the 12V GND terminal.

<sup>3</sup> Connect to the +5V terminal on the power supply. However, if your power supply has a + Sense terminal, connect to the + Sense.

<sup>4</sup> Connect to the -5V terminal of the power supply. If -5V is not available, connect to the 12V GND or the 5V

GND. *NOTE: If you do not have or use -5V, the maximum power to the speaker will be reduced by half.*

<sup>5</sup> Connect to the +12V terminal of the power supply. If your coin counter(s) require 12V, also connect to the + side of the coin counter(s).

<sup>6</sup> If you want to install a second coin counter, connect this wire to one side of the right 12V coin counter. Then clip R26 on the game PCB. *Note: Do not use 24V counters.* Connect the + side to +5V or +12V on the power supply, as appropriate.

<sup>7</sup> Connect this wire to one side of the left 12V coin counter. *Note: Do not use 24V counters.* Connect the + side to +5V or +12V on the power supply, as appropriate.

<sup>8</sup> Use this wire if you want an external self-test switch. However, the kit already has a self-test switch on the game PCB. (If you connect an external self-test switch, turn off the switch on the PCB. Connect the wire to the N.O. terminal on the external self-test switch. Connect the common terminal of the switch to a GND wire.)

**Table 1-3 JAMMA Pin and Wire Connections**

8. To prevent injury, carefully deburr all the edges of the plastic cover.
9. Install the control panel decal on the control panel. Use a sharp X-ACTO knife to trim the outside edge and to cut out the holes for the controls.
10. Mount the two baseball batter decals on the control panel, around the joystick holes. Mount the circular decals around the three-button switch assemblies, and mount the two small instruction labels above the joysticks. Refer to Figure 4-2 for the correct placement of these decals.
11. Install the cover on the control panel with the four 3/4"-long carriage bolts, washers, and locknuts.
12. Install the joystick controls using the 3/4"-long carriage bolts and #10-24 nut/washer assemblies.
13. Install the start button assembly and the indicator plate as shown in Figure 1-1.

For maintenance and servicing information on the joystick control, refer to Chapter 3 of this manual.

## Connecting the JAMMA Harness

1. If your game cabinet does not already have a JAMMA harness, install a JAMMA harness in the cabinet (optional, Atari part no. A046501-01).
2. Install one pair of square split beads on the harness that runs to the power supply, and the other to the harness the runs to the control panel. In both cases, make sure you move the split beads as close to the PCB edge connector as possible. Hold the beads on the harnesses with the two tie wraps included in the kit.

### CAUTION

You must install the split beads on the JAMMA harness to meet FCC requirements.

3. Using Table 1-3 for wiring information, connect the JAMMA harness to existing component harnesses. Use crimp splices or butt soldering.

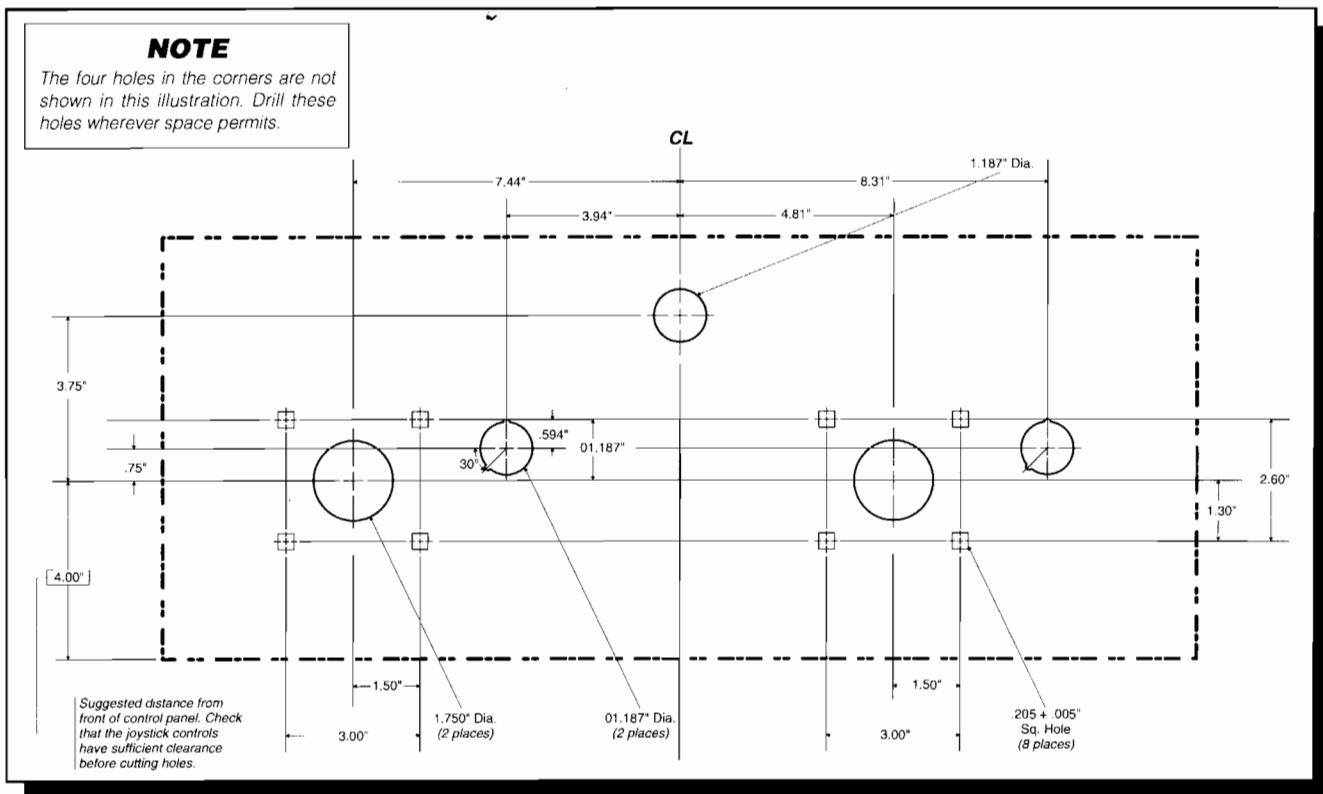


Figure 1-2 Locations of Control Panel Holes to be Drilled



**WARNING**

*Do not simply tie the wires together. If you do, you could cause intermittent problems, loose connections, oxidation, or a fire.*

**Connecting Power Wires**

1. Connect the wires on the JAMMA harness to the wires for the power supply, as shown in Table 1-3. The Relief Pitcher kit requires +5V and +12V. If -5V is available, it should be used, too.
2. Tie off any other voltage wires on the power supply besides +5V, -5V, and +12V.
3. There is more than one wire for each voltage in the JAMMA harness. Use more than one wire for each voltage (connecting them as described in Table 1-3) so that the power wiring does not overload and burn.

**Connecting Video Display Wires****NOTE**

*The JAMMA harness provides only negative composite sync. If your video display requires separate positive sync, see Chapter 3 for alternative wiring.*

Connect the wires designated for the red, green and blue video guns along with the sync and ground wires, according to Table 1-3.

**Connecting Coin Door Wires**

1. Connect the wires on the JAMMA harness to the coin switches and meter according to Table 1-3.
2. Connect one terminal of the door lamps to one of the GND wires. Connect the other terminal of the door lamps to the R wire supplying +5V.

**NOTE**

*Do not use -5V for the coin door lamps. The -5V is required for audio.*

Some games have separate power supply outputs for the coin door lamps. If you choose to use these outputs, make sure you connect both terminals of each lamp to the terminals on the power supply.

**Connecting the Control Wires**

Connect the joysticks and switches to the JAMMA harness using crimp splices or butt soldering. Follow the wiring instructions in Table 1-3.

**Grounding the Cabinet**

Find the ground lead (green) of the 115V input power line. Connect this lead in daisy-chain fashion to a bare metal part of the coin door, the control panel, the video display, and the power supply. This AC ground must be of #18 AWG wire or larger.

**WARNING**

*For the safety of players, you must connect the green ground wire as indicated above.*

**Checking the JAMMA Connections**

Before plugging in the game PCB, turn on the power to the game, and check for +5V on pins 3, 4, C, and D of the JAMMA connector; +12V on pins F and 6; and -5V on pins E and 5.

Check that the video display and the attraction lamp have power. Now turn off the power to the game.

**Installing a Baseball Card Dispenser**

To increase player appeal, this game is capable of accepting an optional baseball card dispenser. The self-test software has a special screen for setting several options related to a card dispenser.

Contact your distributor to purchase a baseball card dispenser. Using any secure connection method, connect JPL4 pin 3 (CCNTR-R on the Game PCB) to the ENABLE signal from the dispenser. Note: The NOTCH signal from the dispenser is not used and can be left unconnected.

Connect the power and ground wires from the dispenser to the power supply, using the dispenser manufacturer's instructions. Refer to the supplement to this manual (CO-376-01) for more information.

**Installing the Relief Pitcher Board Set**

After you have checked the power on the JAMMA connector (above), install the Relief Pitcher board set in

the cabinet. Follow these steps and referring to Figure 4-4:

1. Use the nylon standoffs and four #6 x ½" long screws in the kit.
2. Connect the JAMMA connector to the game PCB.
3. Secure the JAMMA harness away from the PCB with cable ties.
4. Turn on the power to the game. Check that the game PCBs function. If a video picture is not present, see Chapter 3.

## Installing the Bezel, Decals, Labels, and Attraction Assembly

The bezel, decals, labels, and attraction assembly are shown assembled in a cabinet in Figure 1-1.

### Installing the Display Bezel

Find the cardboard display bezel in the kit. This bezel can accommodate both 19-inch and 25-inch video displays. Follow the instructions on the back of the bezel, and cut the hole and outside edges as required.

### Installing the Product ID and FCC Label

Place the product ID label (part no. 038158-01) and FCC compliance label (part no. 039450-01) on the back of the cabinet.

### Installing the Side Panel Decals

Find the side panel decals in the kit. Wet the left and right side panels of the cabinet with slightly soapy water. Then position the decals as shown in Figure 1-1. Remove any wrinkles in the artwork using a squeegee. Allow the sides to dry.

### Installing the Attraction Assembly

Find the Relief Pitcher attraction shield and the attraction panel film in the kit. Using the existing shield as a template, cut the shield and film to size, if necessary. Install them on the cabinet as shown in Figure 1-1.

## Setting the Coin and Game Options

Set the coin and game options in the self-test. See Chapter 2 for information about the option settings.

## Maximizing Earnings

For maximum earnings, regularly maintain your Relief Pitcher game following the instructions in Table 3-1, in Chapter 3.

When you set up the game and when you collect money, perform the automated self-test and check the controls with the Controls Test in the self-test.

You should read Chapter 2, Self-Test, for information on the game options, statistics, regional settings, and coin options so you can effectively use the available options. Evaluate the game data by using the statistics and histograms screens, and make adjustments on the game options screen.

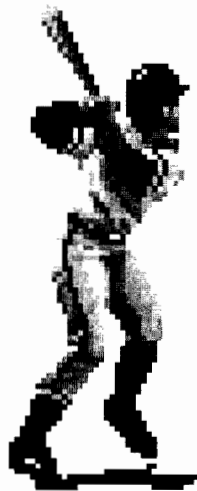
The key to maximizing earnings is striking a midpoint on game times. Game times must be short enough so that the player turnover is high. Conversely, game times must be long enough to give players a good value and ensure repeat play. Repeat play is *crucial* to longevity. The Relief Pitcher software gives the operator the flexibility to tune game difficulty and enough statistics to intelligently make adjustments.

One of the first settings you should make is the regional setting. To encourage regional rivalries, in the self-test select a popular city for each of the four Relief Pitcher teams. This game has 32 cities and regions to choose from.

If collections seem low or are dropping off, check all player controls and coin mechanisms for proper operation.

If earnings seem low, the game is technically sound, and the average game time per quarter is under 150 seconds, try changing the game difficulty option to an easier setting. The change will give players more game time for their money.

If the average game time per quarter is over 270 seconds, first try changing the game difficulty to a harder setting. If the average game time per quarter is still over 270 seconds after a few weeks, try an even harder setting.





After changing the game difficulty settings, you should reset the game statistics and the histograms. The game statistics and histograms can be cleared in the self-test by holding the start button and pressing any left button.

## Game Play

This section describes the features and play of the Relief Pitcher™ game.

### Introduction

Relief Pitcher is timed with the opening of the 1992 baseball season. The famous sports announcer Jack Buck calls all the play-by-play, as players control the action from the best seat in the house — right behind home plate.

### Game Play

Relief Pitcher is a one- or two-player simultaneous baseball game kit for upright cabinets. Controls in this game include a start button, two joysticks, and two special “cluster” buttons to give players ultimate control and secrecy for strategy.

Relief Pitcher has four ways to play:

- One-player in a 24-game season with a Stars and Playoff game

- One-player in a 9-inning game vs. the computer
- Two-player in a 7-game series
- Two-player in a 9-inning game

Four different teams with a variety of strengths and weaknesses create incredible battles of strategy. Operators can even select which cities players can choose from. This way players anywhere in the country can relive regional rivalries.

Players start with a minimum salary; they earn bonus dollars along the way for outstanding play. A new level of control gives players the ability to throw the widest variety of pitches in a coin-operated game. In addition to a traditional fast ball and curve ball, players can select a sinker, knuckle ball, screwball, or rising fast ball as their special pitch. Players also can mix up speed by throwing hard or off-speed pitches.

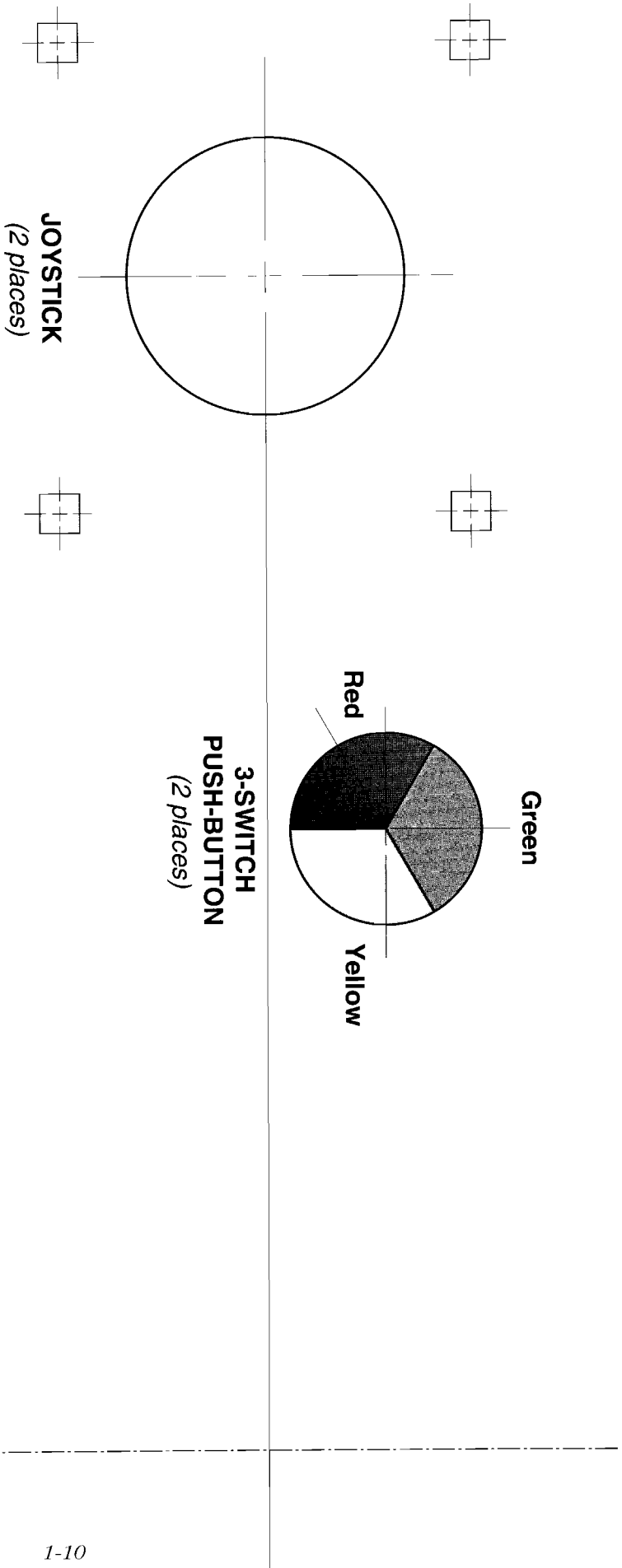
Players in the field can run and throw to all bases, hit the cutoff man, and even run down overly aggressive base runners. Batters can direct the ball by aiming the joystick towards left, center, or right field. Players determine if they want to bunt, swing, or “go for it” with a power swing. Base runners can even steal, stretch doubles into triples, and go for the “suicide squeeze.”

For added game play and visual variety, the game has four different ball parks and one special Stars park. It's like you're at the ball park as the home fans boo the visitors and cheer on their heroes.

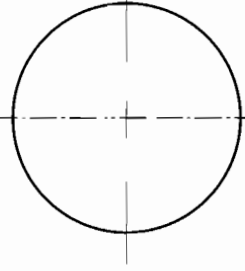


**Figure 1-3 Hole-Cutting Template for Relief Pitcher™ Kit Control Panel (Left Side)**

**NOTE:** Cut out this page and page 1-11 and overlap the centerlines (note there is only one START button). Then tape the pages together and use as a template. For more detailed information on hole-drilling refer to Figure 1-2.



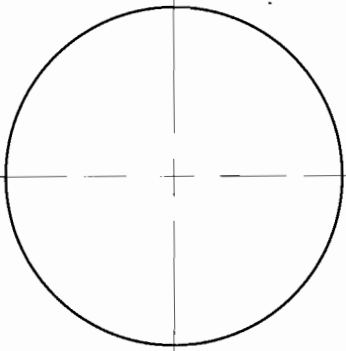
Centerline



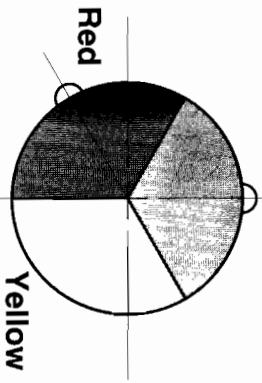
START BUTTON



Figure 1-4 Hole-Cutting Template for Relief Pitcher™ Kit Control Panel (Right Side)



JOYSTICK



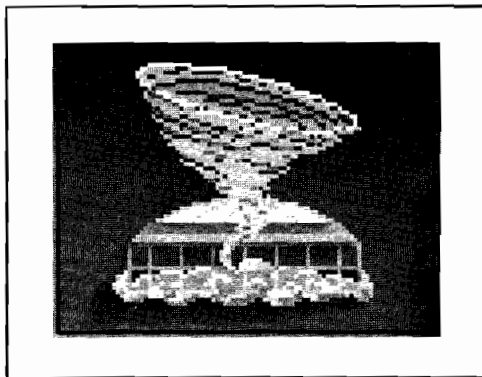
3-SWITCH  
PUSH-BUTTON

**N O T E S**

# Self-Test

## INTRODUCTION

Use the Relief Pitcher™ self-test to check the condition of the game circuitry and controls. You will see



the self-test information on the video display and hear the sound test information through the speakers. You do not need any additional equipment to perform the self-test. ♪ You should perform the self-test when you first

set up the game, each time you collect the money, or when you suspect game failure. ♪ This chapter shows the screens in the

self-test and explains each of the tests. The screens and explanations are arranged in the order they appear in the self-test. Table 2-1 lists all of the self-test screens and their purposes.

## Entering and Exiting the Self-Test

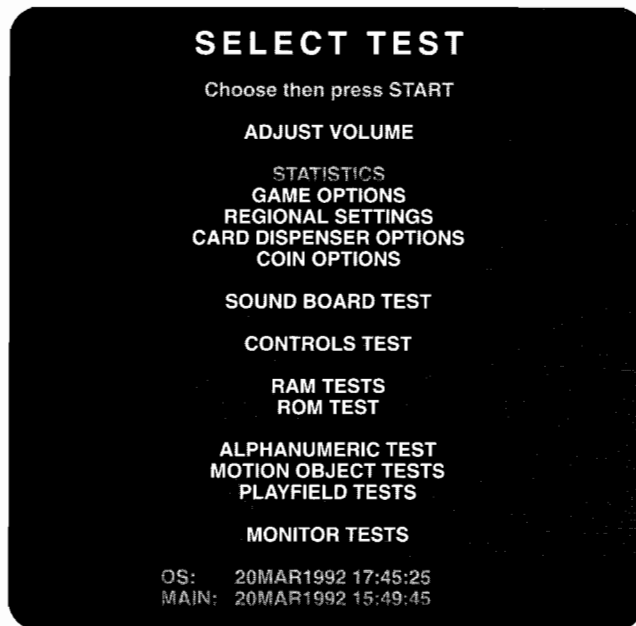
To enter the self-test, turn on the self-test switch on the bracket located inside the coin door (if you wired your kit that way). The Relief Pitcher Game PCB also has a self-test switch on it, near the edge connector. These two switches are wired in parallel, meaning that you can use either one independently. Exit the self-test by switching off any of the self-test switches.

## Self-Test Menu

Choose which test or screen you want to see from this menu, shown in Figure 2-1. Move up and down the list by pressing the left and right triggers; the corresponding test is highlighted in yellow. Choose the test by pressing the START button.

## Adjust Volume

Adjust the volume of the game using this screen, shown in Figure 2-2. Control the volume by moving the joystick right or left; the volume number increases or decreases. To restore the old volume level, push the



**Figure 2-1 Self-Test Menu Screen**

right red button. Save the new volume and return to the self-test menu by pressing any left button.

Screen	Use or Purpose
Adjust Volume	Adjusts the volume.
Statistics	Displays the game statistics.
Game Options	Use to set and check the game options settings.
Regional Settings	Use to set and check the city setting for each of the four teams.
Card Dispenser Options	Use to set the maximum number of cards per credit and how many bonus cards are dispensed after 9 innings.
Coin Options	Use to set and check the coin options settings.
Sound Board Test	Use to check the audio circuits.
Controls Test	Use to display the functioning of the game switches.
ROM Test	Use to check the program ROMs.
Alphanumeric Test	Use to test for clarity of characters.
Motion Object Tests	Use to test the movement and color of game objects.
Playfield Tests	Use to check the playfield displays.
Scrolling Test	Use to check the two video RAM chips.
Stamp Test	Use to check all the playfield stamps.
Monitor Tests	
Color Test	Use to check the video display color circuits.
Purity Test	Use to check red, green, blue, white, and grey purity.
Convergence Test	Use to check and adjust display convergence.

**Table 2-1 Summary of All Self-Test Screens**

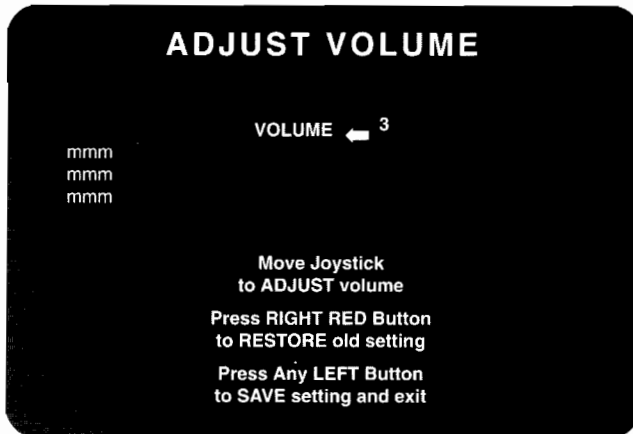


Figure 2-2 Adjust Volume Screen

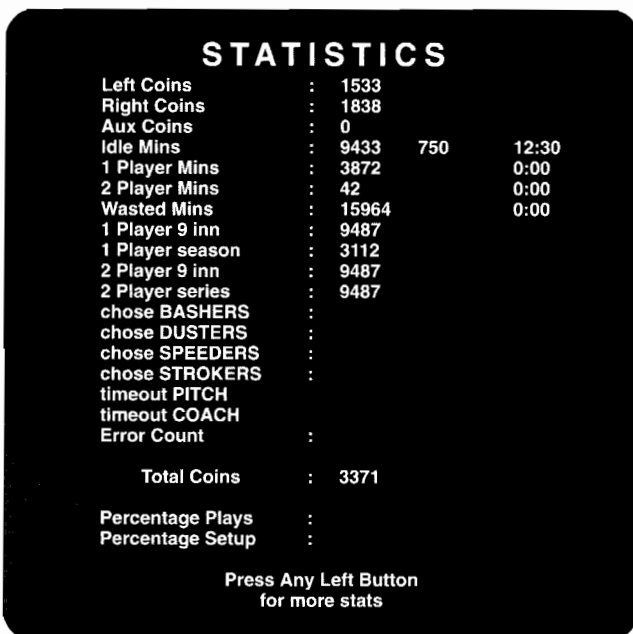


Figure 2-3 Game Statistics Screen

## Statistics

Use the information shown on the statistics screen, in Figure 2-3, and on the histogram screens to keep track of your game use and maximize your profits. Record the information on the Relief Pitcher statistics sheets in the back of this manual. The statistics are collected from the last time the statistics were cleared. You can clear the statistics by holding the start button and pressing any left button.

*Error Count* shows the number of errors counted in the erasable memory. If you have an error count, the statistics may be wrong. If you consistently have errors counted for several weeks, replace the EEROM at 14B on the Audio PCB.

## Game Options

Check and select the game options on this screen, shown in Figure 2-4.

To move through the options, move the joystick up or down. Change the option in yellow type. The factory default settings are shown in green. To change a setting, move the joystick left or right. To save the new settings, press any left button. This returns you to the select test screen. If you want to keep the original setting, although you have changed it, press the right red button. This brings back the original setting.

The game option settings with factory defaults are explained in Table 2-2.

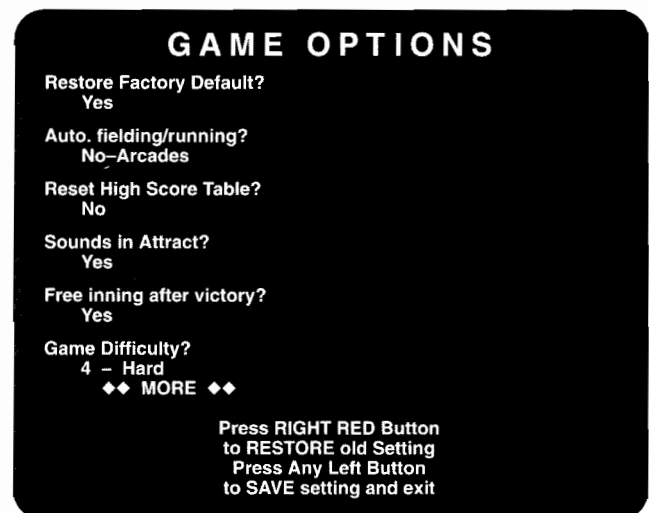


Figure 2-4 Game Options Screen

## Regional Settings

Check and select the regional game settings on this screen, shown in Figure 2-5. This screen lets you assign a city from the list shown to each of the four Relief Pitcher teams.

The list of available cities is displayed in the top half of the screen. Follow the directions at the bottom of the screen to select the team and the cities.

## Card Dispenser Options

To increase player appeal, this game is capable of accepting an optional baseball card dispenser. This screen has two options related to a card dispenser: one option sets the maximum number of cards per credit, and the other sets how many bonus cards are dispensed after nine innings. For more information on

Option	Settings	Explanation
<b>Restore Factory Default?</b>	Yes ✓ No	Clears high scores and sets options to defaults.
<b>Auto fielding/running?</b>	No–Arcades ✓ Yes–Taverns	If yes, the computer will run and throw for the player. The “no” setting is suitable for high-skill players. The “yes” setting is suitable for low-skill players.
<b>Reset High Score Table?</b>	No Yes ✓	Lets you clear the high score table.
<b>Sounds in Attract?</b>	Yes ✓ No	Lets you choose whether or not to hear the voice of announcer Jack Buck in the attract mode.
<b>Free inning after victory?</b>	Yes ✓ No	In a “season” 1-player game, allows one free inning after beating the computer.
<b>Game Difficulty?</b>	1–Easiest 2–Easy 3–Medium ✓ 4–Hard 5–Hardest	Establishes degree of game difficulty.
<b>Innings per credit</b>	1 ✓ 2 3	Sets the number of innings per credit.

✓ Manufacturer's recommended settings. These settings are shown in green on the screen.

**Table 2-2 Game Option Settings**

how to use these settings for maximum earnings, refer to the supplement to this manual, CO-376-01.

## Coin Options

Check and select the coin options on this screen, shown in Figure 2-6.

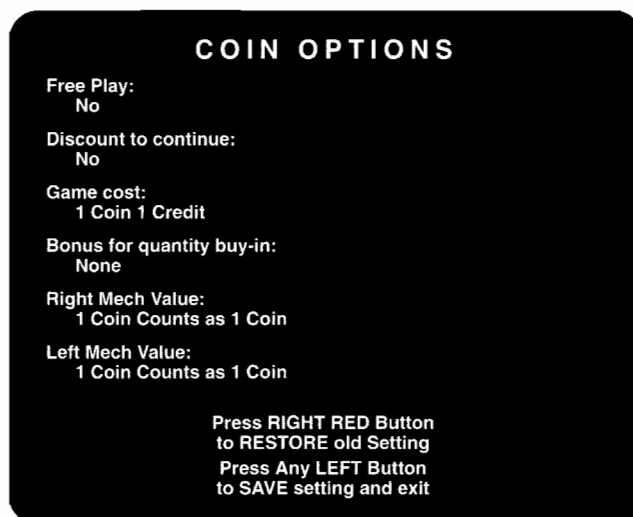
To move through the options, move the joystick up or down. Change the option in yellow type. The factory default settings are shown in green. To change a setting, move the joystick left or right. To save the new

settings, press any left button. This returns you to the select test screen. If you want to keep the original setting, although you have changed it, press the right red button. This brings back the original factory setting.

The coin option settings and factory defaults are explained in Table 2-3.



**Figure 2-5 Regional Settings Screen**



**Figure 2-6 Coin Options Screen**



Option	Settings	Explanation
<b>Free Play</b>	No ✓ Yes	Set this to “Yes” for demonstrating the game.
<b>Discount to Continue</b>	No ✓ Yes	Lets you offer a reduced price per credit when players want to continue a game.
<b>Game Cost</b>	1 coin 1 credit ✓ ... 8 coins 1 credit	Sets the number of coins required for one credit.
<b>Bonus for Quantity Buy-in</b>	None ✓ 2 coins give 1 (extra coin) 3 coins give 1 ... 9 coins give 3	Lets you choose various levels of bonus coins or no bonus.
<b>Right Mech Value</b>	1 coin counts as 1 coin ✓ ... 1 coin count as 8 coins	Is the number of coins each coin counts as in the right coin mechanism.
<b>Left Mech Value</b>	1 coin counts as 1 coin ✓ ... 1 coin count as 8 coins	Is the number of coins each coin counts as in the left coin mechanism.

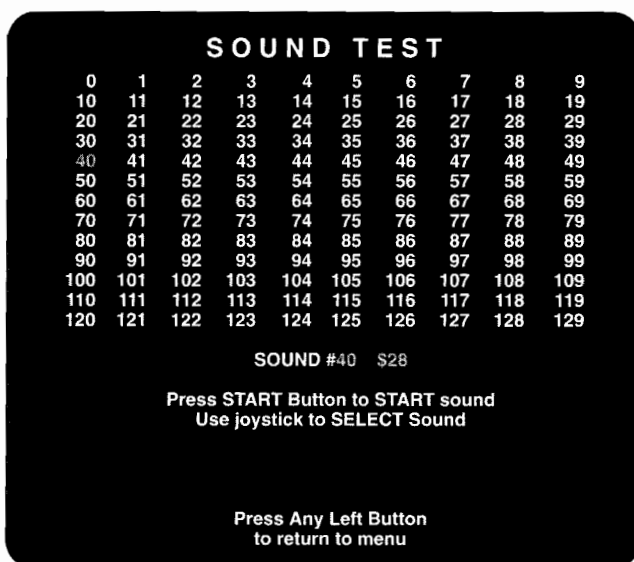
✓ Manufacturer's recommended settings. These settings are shown in green on the screen.

**Table 2-3 Coin Option Settings**

## Sound Board Test

The sound test indicates the condition of the sound effects circuit on the game PCB. The sound test screen appears in Figure 2-7.

Move the joystick left, right, up, or down to select the sound, and press the start button to listen to it. Pressing the right red button stops the sound from playing. Press any left button to return to the select test menu.

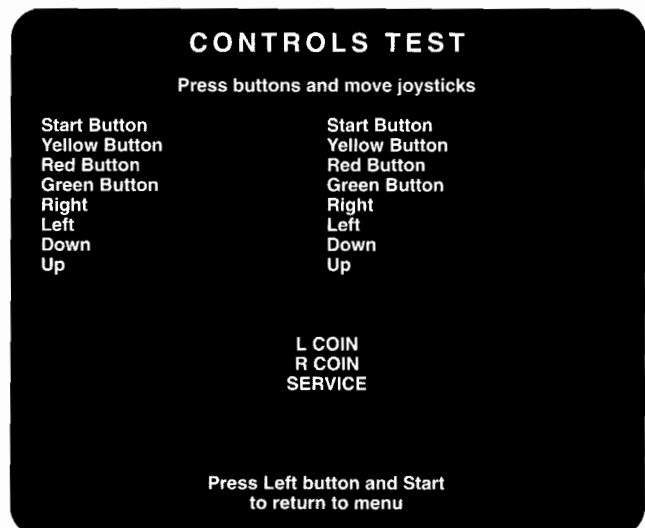


**Figure 2-7 Sound Test Screen**

## Controls Test

The controls test allows you to display the status of the game switches and controls. The switch test screen appears in Figure 2-8. The items tested are:

- Joystick left, right, up, and down movement
- All three switches in each “cluster” button
- Start switch
- Left and right coin switches



**Figure 2-8 Controls Test Screen**

- The auxiliary coin switch, if you installed one
- As you activate each switch or control, make sure the correct words are highlighted in yellow on the screen. To return to the select test menu, simultaneously press any left button and the start button.

## RAM Tests

Use this selection screen (shown in Figure 2-9) to choose which RAM test you want to perform. Use the different tests according to Table 2-4. If you have serious RAM problems, you may see only a colored screen.

Press the start button (and hold it, if the test is looping) to leave the individual RAM test and return to the Select RAM Test screen. Press the start button once more to return to the select test screen.

## ROM Test

The ROM test (see Figure 2-10) checks the read-only memory. If the test passes, you will see the location and checksum of each ROM and the message *All ROMS are OK*. If a ROM is bad, the location of the bad



Figure 2-10 ROM Test Screen

ROM is displayed. You need to replace that ROM. *Note: The OS (operating system) and program dates and times displayed in your game will be different from those shown in Figure 2-10.* Press any left button to return to the select test screen.

## Alphanumeric Test

The alphanumeric test screen lets you see the clarity of the characters. Figure 2-11 shows the first part of the alphanumeric test screen.

The screen displays all of the alphanumeric characters. If the characters are not clear, you have a problem. To scroll through the screen, move the joystick up or down. Press any left button to return to the select test screen.

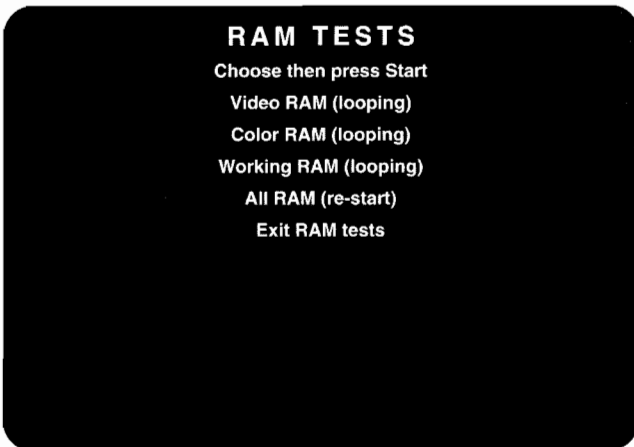


Figure 2-9 RAM Tests Sub-Menu

Problem	Type of Test	RAMs Tested
Playfield is erratic or looks wrong, motion objects are not working properly, or game play is erratic or game is locked up.	Video RAM	7K, 9K
Colors look wrong.	Color RAM	3E, 6E

Table 2-4 When to Run the RAM Tests



Figure 2-11 Alpha Test Screen

## Motion Object Tests

The motion object test screen, shown in Figure 2-12, tests the movement and color of various game objects.

Select the particular motion object test by pressing the start button. The seven tests, in sequence, are as follows:

- Move object position
- Change picture stamp
- Change object size
- Change object palette
- Toggle horizontal flip
- Toggle object priority
- Change object number

Within each test, use the joystick control to move objects, change pictures, and change object size. Simultaneously press the start button and any left button to return to the select test screen.

## Playfield Tests

Use the selection screen to choose which playfield test you want to perform — the playfield scrolling test or the playfield stamp test.

### Scrolling Test

This test, shown in Figure 2-13, checks the condition of the scrolling playfield. Move the joystick left, right, up, and down to see the screen move accordingly. Press any left button to exit to the playfield test sub-menu.

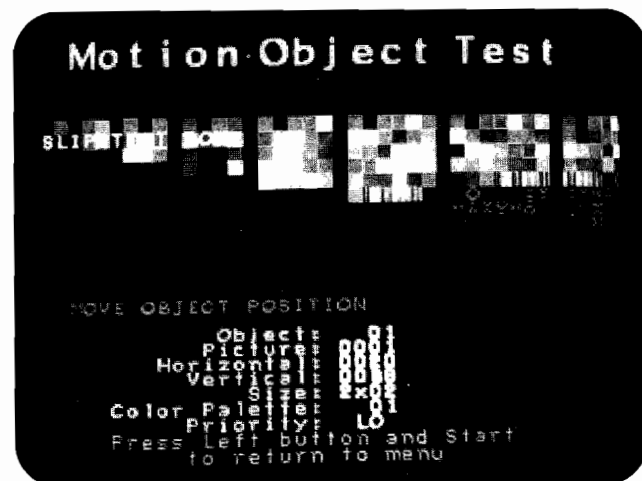


Figure 2-12 Motion Object Test Screen

## Stamp Test

This test checks the condition of the playfield stamp circuitry. Move the joystick up and down to see the all the stamps displayed on the screen. Press any left button to exit to the playfield test sub-menu.

## Monitor Tests

Use the selection screen to choose which monitor test you want to perform — the color, purity, or convergence test.

### Color Test

This test indicates the dynamic range of the video display color circuit. The color test screen is shown in



Figure 2-13 Playfield Scrolling Test Screen

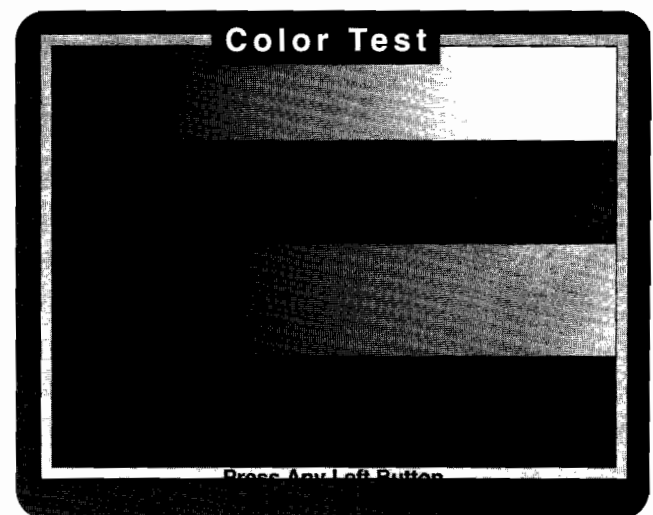


Figure 2-14 Color Test Screen

Figure 2-14. It should look as follows: white at the top, followed by red, green, and blue. The screen should also be black at the left, and pure color at the right.

## Purity Test

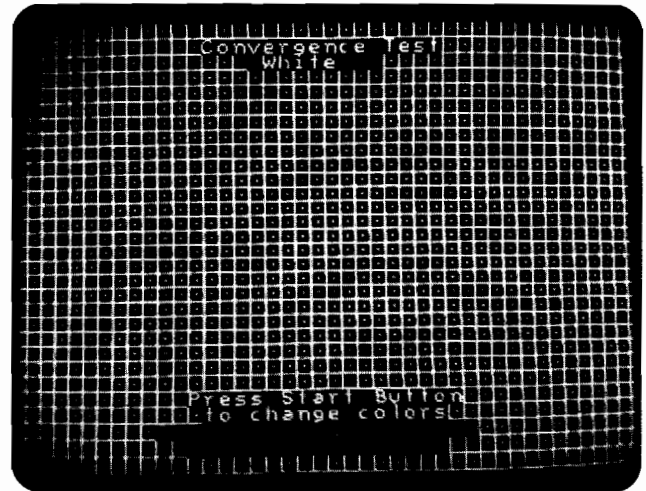
This test indicates the purity of the video display color circuit in a series of five screens. Advance to each screen by pressing the start button: the software cycles through all five screens and then starts over again. The screens are as follows:

1. Solid red
2. Solid green
3. Solid blue
4. Solid white
5. Solid gray

If the screens do not match this description, adjust the video display as described in the video display manual. Press any left button to exit.

## Convergence Test

The convergence test has three screens: first white, then violet, and finally green. The white screen is shown in Figure 2-15. To see the violet and green screens, press the start button. Press any left button to exit.

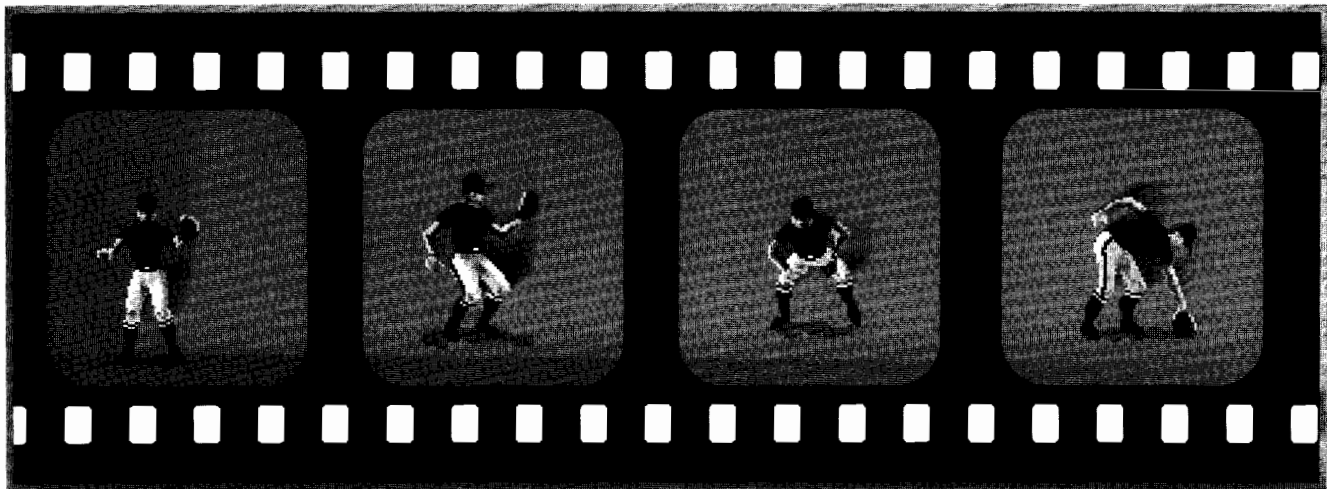


**Figure 2-15 Convergence Test Screen**

Check the following on the screens:

- The grid lines should be straight within 3 mm, and the lines should not pincushion or barrel.
- The convergence of the lines on the violet and white screens should be within 2 mm.

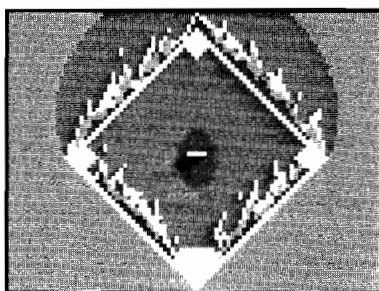
If the screens do not meet these criteria, adjust the video display as described in the video display manual.



# Troubleshooting and Maintenance

## INTRODUCTION

**T**his chapter contains troubleshooting tables and repair procedures for your Relief Pitcher™ game. The chapter has two parts. The first part contains three troubleshooting tables. The tables contain general troubleshooting information, the voltage levels and test points



on the printed-circuit boards, and a list of ROM-caused problems, with specific ROMs to check and replace. ☞ The last part of the chapter has information about connecting the video display (if it requires separate positive sync) and repair information for the joystick controls.

Problem	Suggested Action
<b>Coin Mechanism Problem</b>	<ol style="list-style-type: none"> <li>1. Check the wiring to the coin mechanism.</li> <li>2. Check the voltage to the + side of the mechanism.</li> <li>3. Test the coin mechanisms with the controls test screen in the self-test.</li> </ol>
<b>Game Play Problem</b>	<ol style="list-style-type: none"> <li>1. Check the harness and connectors.</li> <li>2. Perform the self-test.</li> <li>3. Check the voltage levels on the PCB. See Table 3-2, <i>Voltage Inputs and Test Points</i>.</li> <li>4. Check <i>What ROM Problems Look Like</i>, Table 3-3, for specific ROM problems.</li> </ol>
<b>Control Problems</b>	<ol style="list-style-type: none"> <li>1. Check the harnesses and connectors.</li> <li>2. Check the switches on the control.</li> <li>3. If you took the control apart, have you reassembled it correctly?</li> <li>4. Make sure all the parts on the control are in good repair. Repair or replace parts.</li> </ol> <p>NOTE: The joysticks and three-button switches do <i>not</i> require lubrication.</p>
<b>Sound Problem</b>	<ol style="list-style-type: none"> <li>1. Is the speaker volume turned up? (Volume is adjusted digitally in the self-test.)</li> <li>2. Check the voltage on the JAMMA connector.</li> <li>3. Check the wiring from the PCB to the speaker.</li> <li>4. Check the voltage level to the PCB. See Table 3-2, <i>Voltage Inputs and Test Points</i>.</li> <li>5. Replace the speaker.</li> </ol>
<b>Video Display Problem</b> Screen is dark.	<ol style="list-style-type: none"> <li>1. Is the game plugged in?</li> <li>2. Is the game turned on?</li> <li>3. Are the connections good?</li> <li>4. Is the line fuse good?</li> <li>5. Is the display brightness turned up?</li> <li>6. Are the solder connections on the line filter and transformer good?</li> <li>7. Is the JAMMA connector on the PCB tightly connected?</li> <li>8. Check all of the items below. If you answer <i>no</i> to any question, you have a problem with the video display, not with the game circuitry. See your video display service manual.             <ol style="list-style-type: none"> <li>a. Do you have power to the video display?</li> <li>b. Are the video display's filaments lit?</li> <li>c. Do you have high voltage to the video display?</li> </ol> </li> <li>9. Are the voltage levels to the video display PCB correct? (Power voltage is 100 VAC or 110 VAC, depending on the type of video display. Video signal voltage is 0.5 to 3.5 Volts.)</li> <li>10. If the level is not correct, check the connectors and the harness.</li> </ol>
Only a colored screen appears.	You probably have a serious RAM problem.
Display area wavers or is too small.	<ol style="list-style-type: none"> <li>1. Do you have correct power voltage to the video display PCB?</li> <li>2. Do you have correct high voltage to the video display?</li> </ol>
Picture is wavy.	<ol style="list-style-type: none"> <li>1. Is the monitor ground connected to the monitor?</li> <li>2. Are the sync inputs connected properly?</li> </ol>
Picture is upside down.	When you serviced the display, you connected the wires incorrectly. Switch the horizontal or vertical yoke wires on the display.
Convergence, purity or color problems.	Use the screens in the self-test to adjust the video display. Use the adjustment procedures in your video display manual.
Picture is not centered.	Use the centering procedures in your video display manual.

**Table 3-1 Troubleshooting Table**

Voltage	Test Point or LED	Source and Purpose
+5 ± 0.25 VDC	+5V1	Logic power from the switching power supply.
	CR5 LED (Game PCB)	Lights when 5 V is applied to the PCB and the reset (RST) jumper is open.
	CR4 (Audio PCB)	Lights when the +12 V supply is good.
	CR3 (Audio PCB)	Lights when the -5 V supply is good.

**Table 3-2 Voltage Inputs and Test Points on the PCBs**

Problem	ROM Causing the Problem	Check the ROM at:
Program works, but motion objects or playfield is wrong.	Graphics ROMs	14S, 18S (Game PCB) 4D, 8D, 10D (Audio PCB)
Garbage on screen; program doesn't work.	Processor	13F (Game PCB)
Game program is erratic.	Program ROMs	17E, 17J, 19E, 19J (Game PCB)
No sound or erratic sound.	ADPCM ROMs	9B, 10B, 12B (Audio PCB)

**Table 3-3 What ROM Problems Look Like**

## Video Display Sync Problems

This game board provides separate positive horizontal and vertical sync on a separate connector, for monitors that will not work with the composite negative sync signal provided at the JAMMA edge connector.

This connector (labeled “Sync”) is located near the edge connector. Pin 1 is horizontal sync, Pin 2 is vertical sync, and Pin 3 is ground.

## Troubleshooting

The tables in this chapter (3-1, 3-2, and 3-3) can help you troubleshoot problems in your game. The troubleshooting table lists possible sources of problems in various parts of the game. The voltage inputs and test points can help you troubleshoot PCB problems. The ROM problems table can help determine exactly which ROM might be causing game play problems.

## Removing and Replacing the Joystick Control

The joystick control is shown in Figure 4-2. If you have trouble with the joystick, make sure you have assembled it properly. Refer to the instructions included with the joystick or see Figure 4-2.

If you need to repair the joystick, first remove it from the control panel. Disassemble it by removing the retaining ring at the bottom of the shaft. To replace any of the four switches, remove the two screws that secure each switch.

## ROMs and RAMs

If you think you have bad ROMs or RAMs, perform the ROM or RAM test in the self-test procedure. If you have a ROM problem, see Table 3-3. For the location of all the ROMs and RAMs on the game PCB, see Figure 4-4.

# NOTES



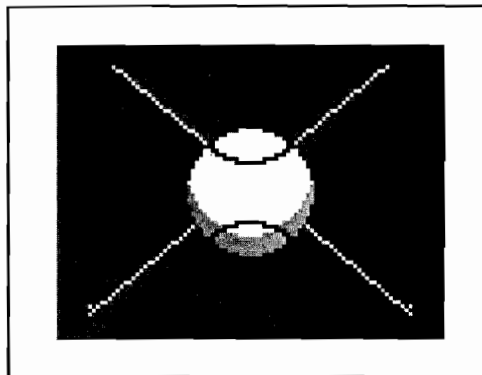


# Parts Illustrations

## INTRODUCTION

**T**his chapter provides information you need to order replacement parts for your kit. Common hardware parts, such as screws, nuts, washers, and so on, are included in these parts illustrations.

❖ When you order parts, give the part number, part name, the number of this manual,



and the serial number of your game. With this information, we can fill your order rapidly and correctly. We hope this will create less downtime and more profit from your games. Atari Games Customer Service phone numbers are listed on the inside front cover of this manual.

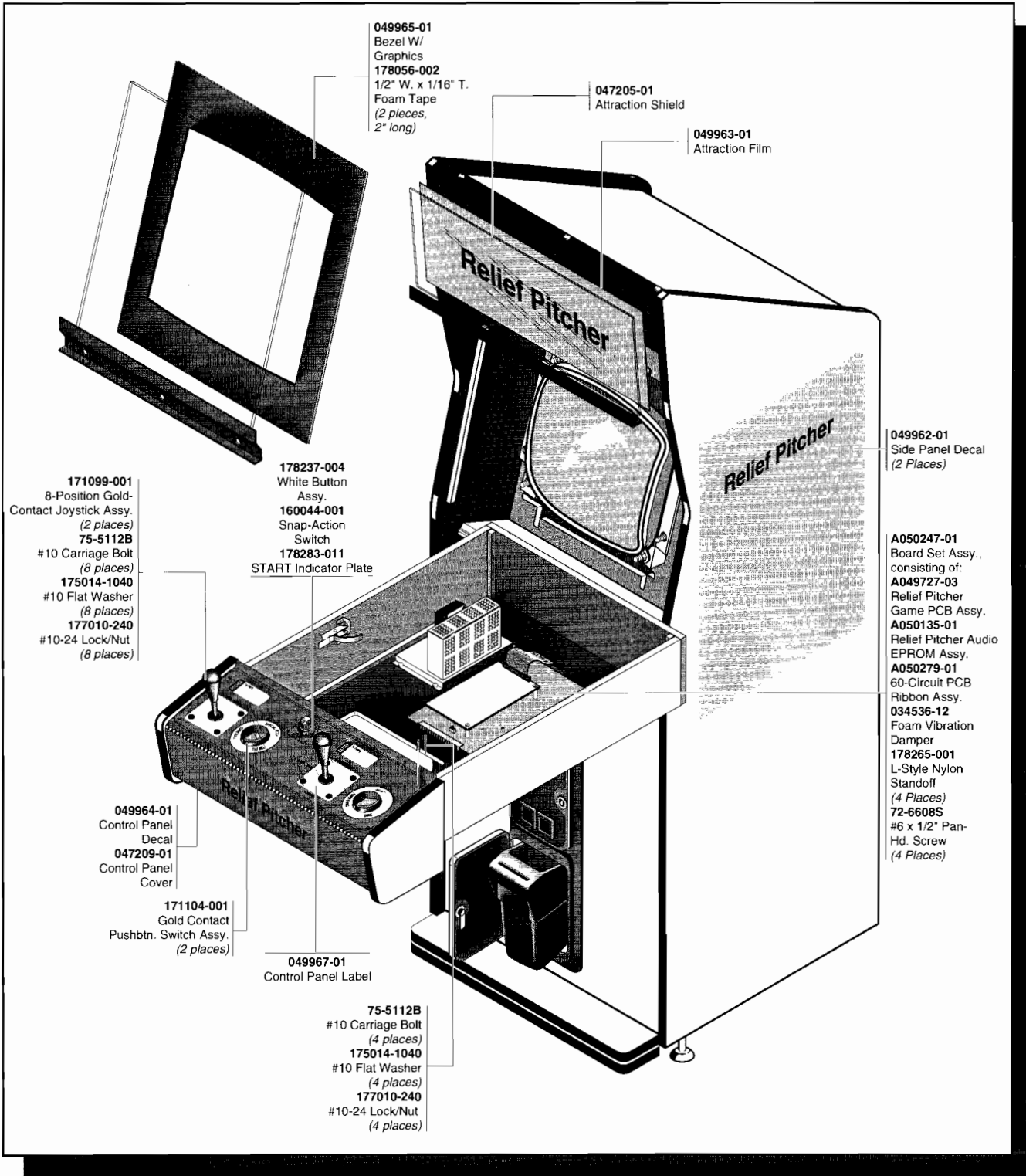
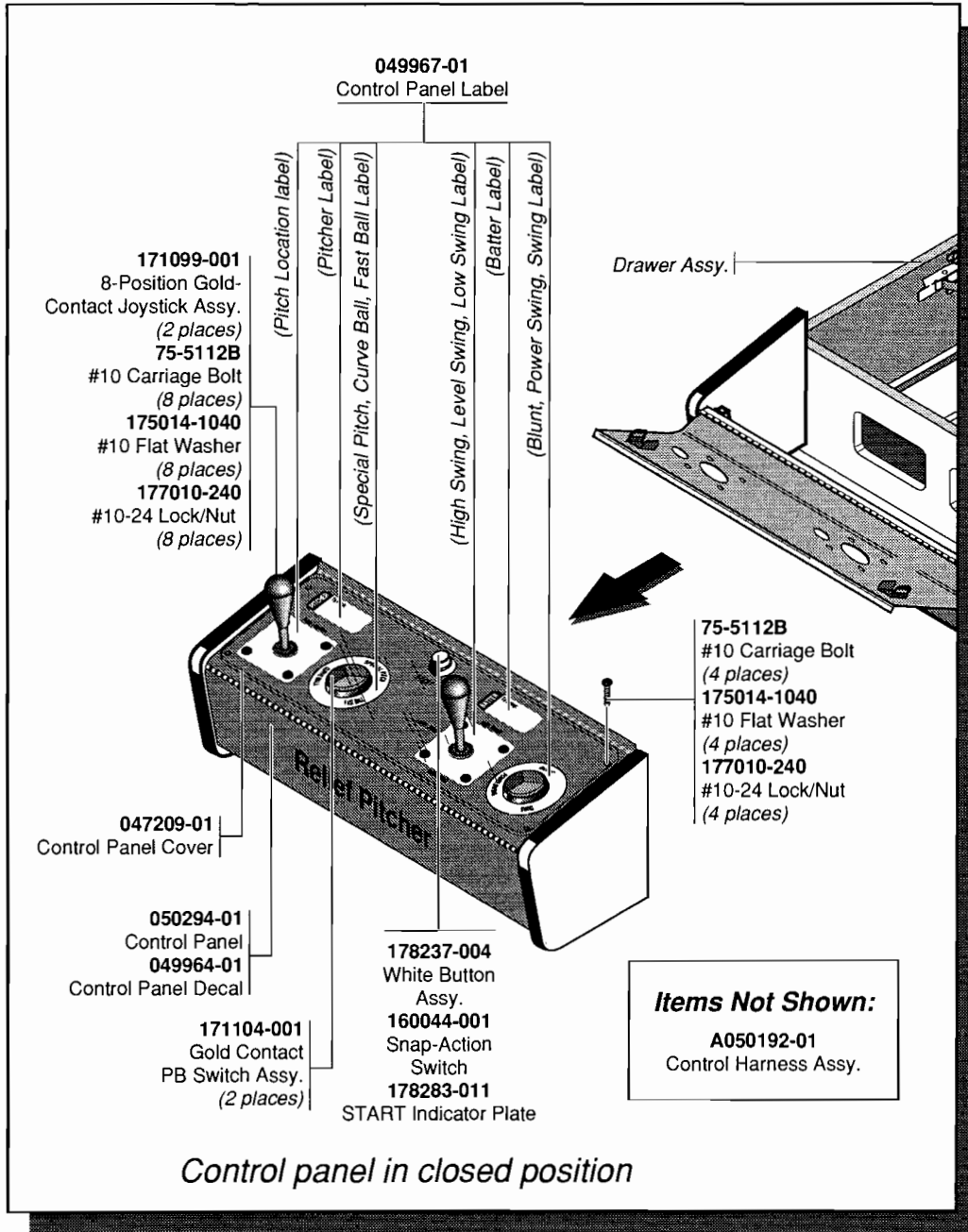
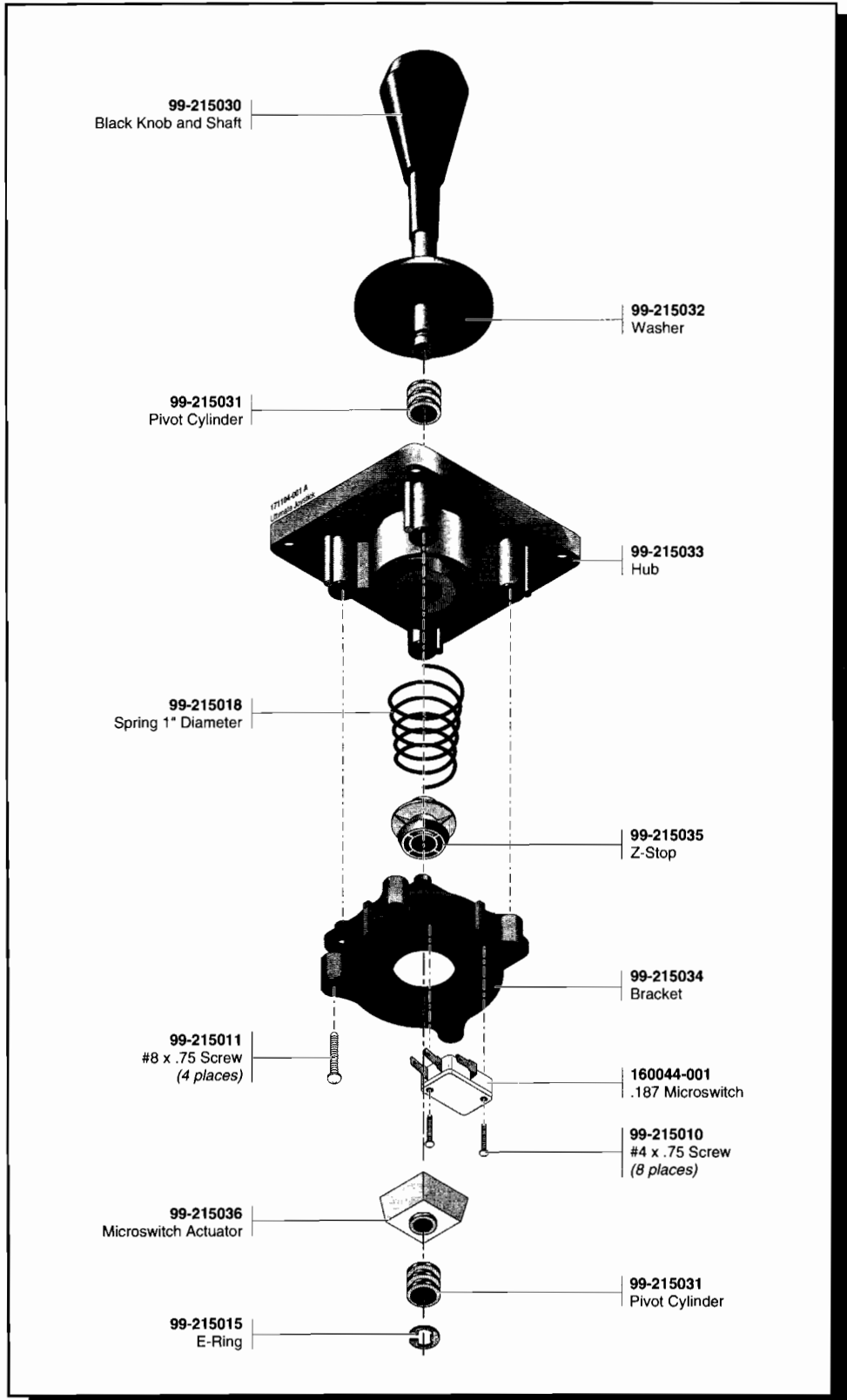


Figure 4-1 Parts of Relief Pitcher Universal Kit

A04960-01 A



**Figure 4-2 Control Panel Parts**



**Figure 4-3 8-position, Gold-contact Joystick Assembly**  
171099-001

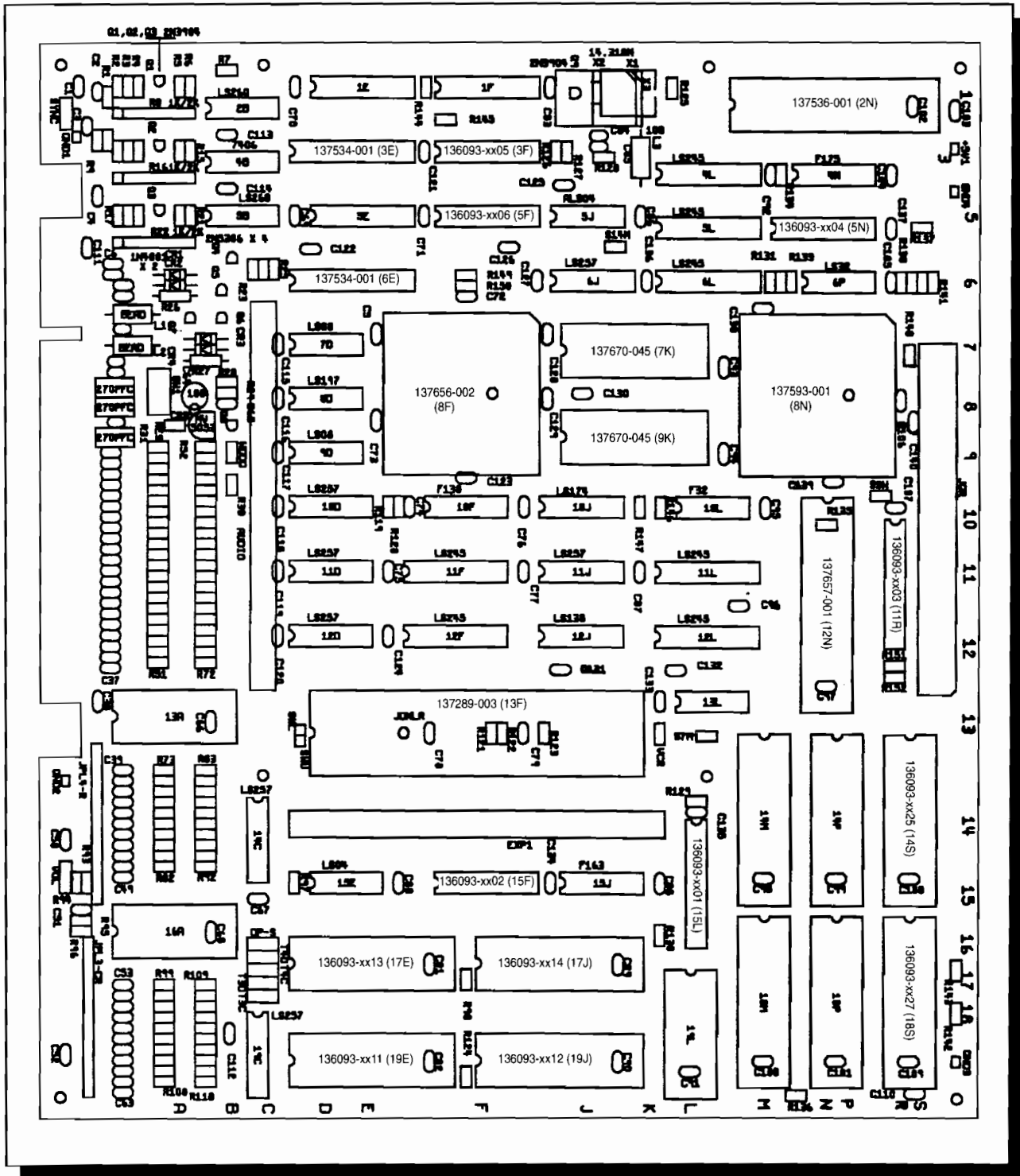


Figure 4-4 Relief Pitcher Game PCB Assembly

A049726-XX H

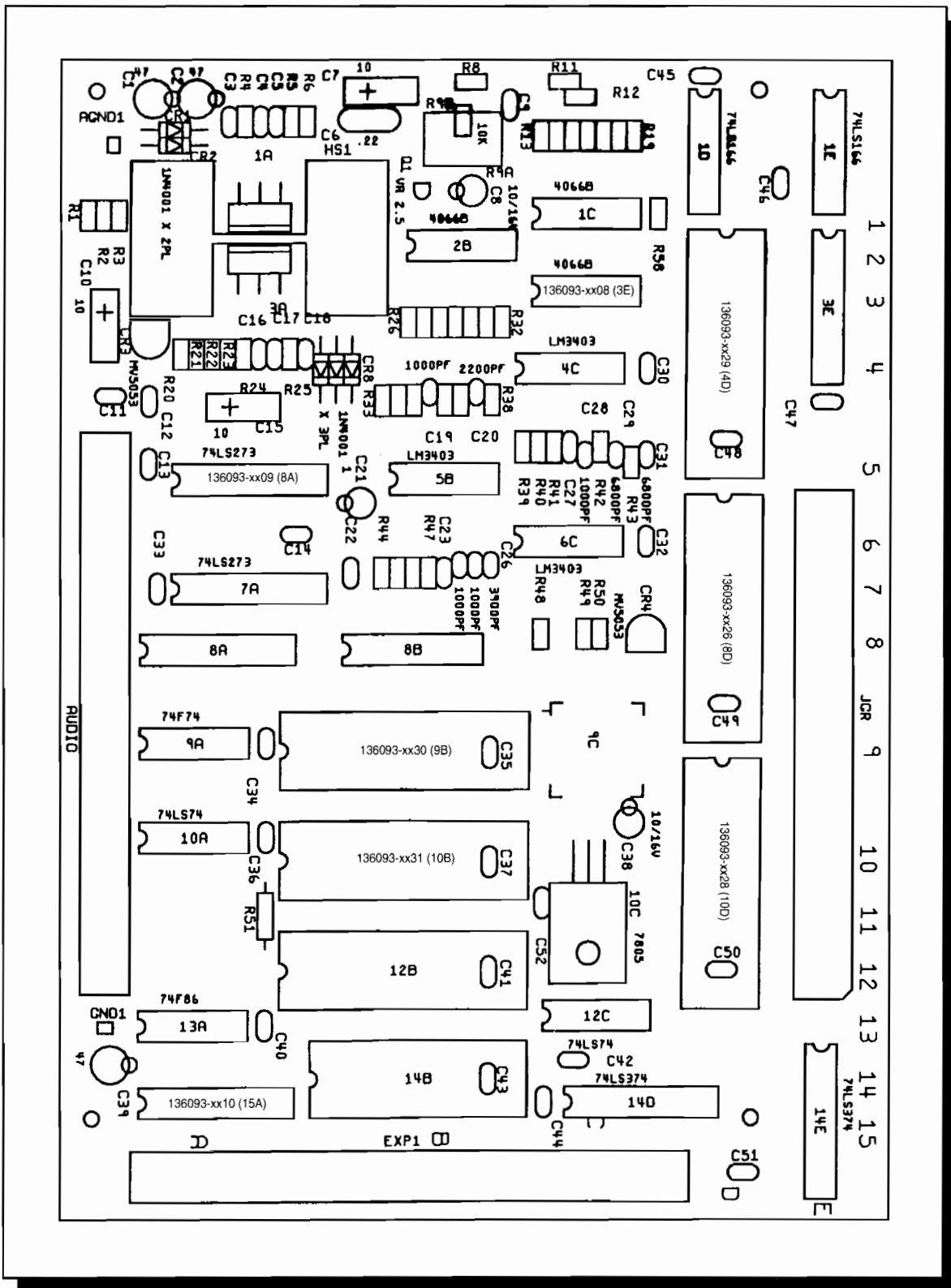


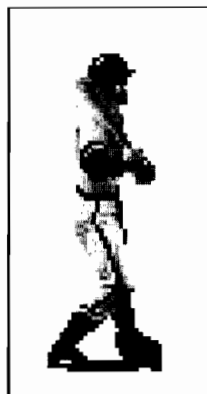
Figure 4-5 Relief Pitcher Audio PCB Assembly

A050134-XX B

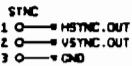
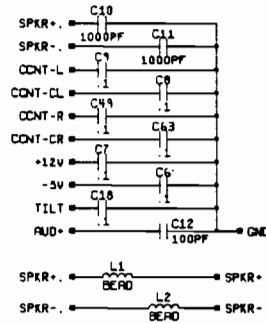
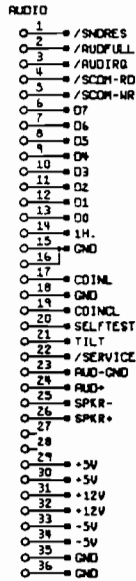
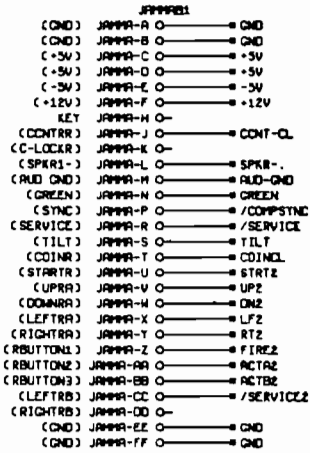
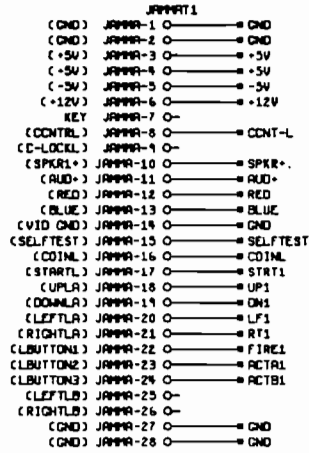
# Schematic Diagrams

## INTRODUCTION

**T**his chapter contains partial schematic diagrams for the Relief Pitcher™ game PCB and the



Audio PCB. The game PCB and Audio PCB *assembly drawings* are illustrated in Chapter 4, Parts Illustrations.





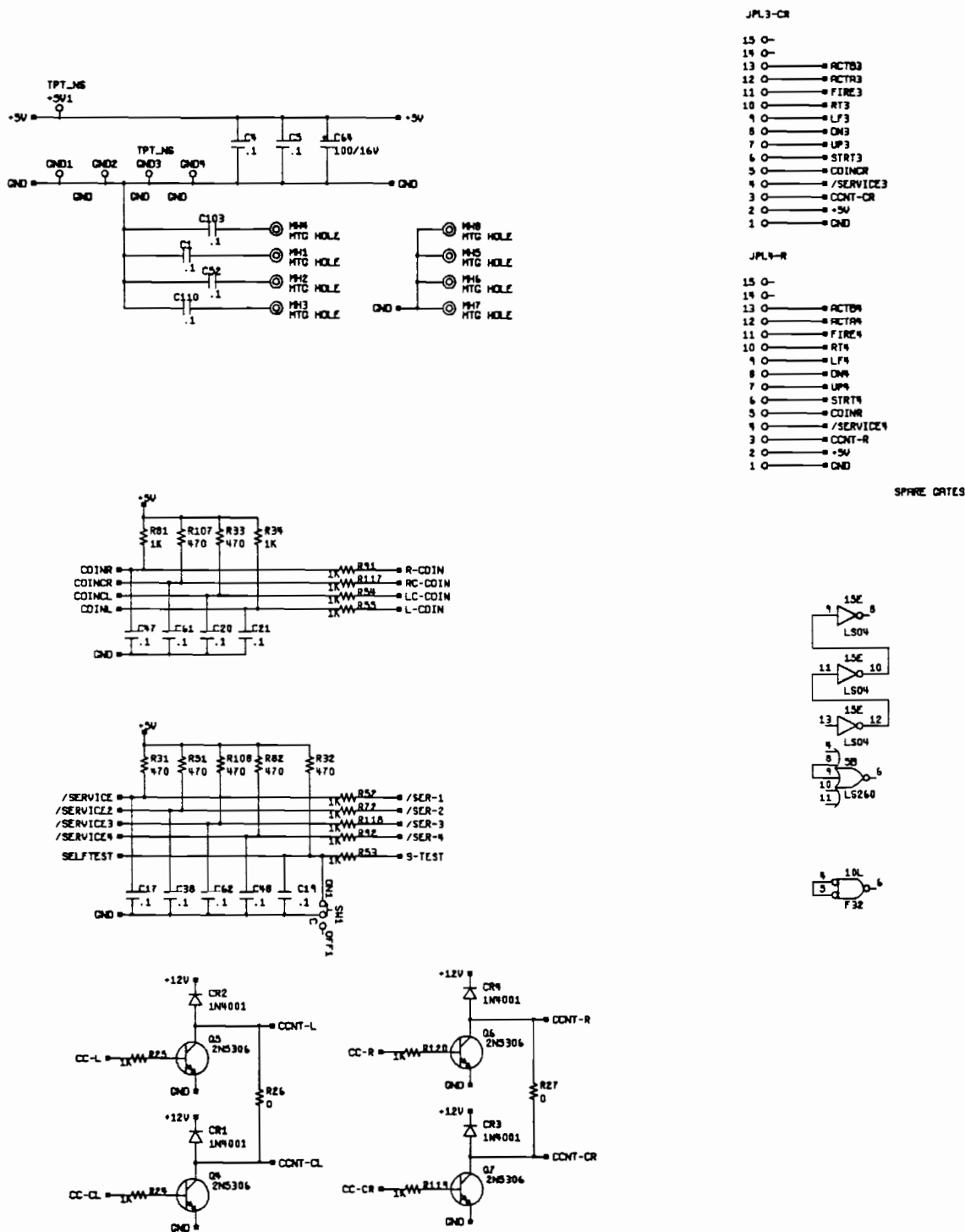
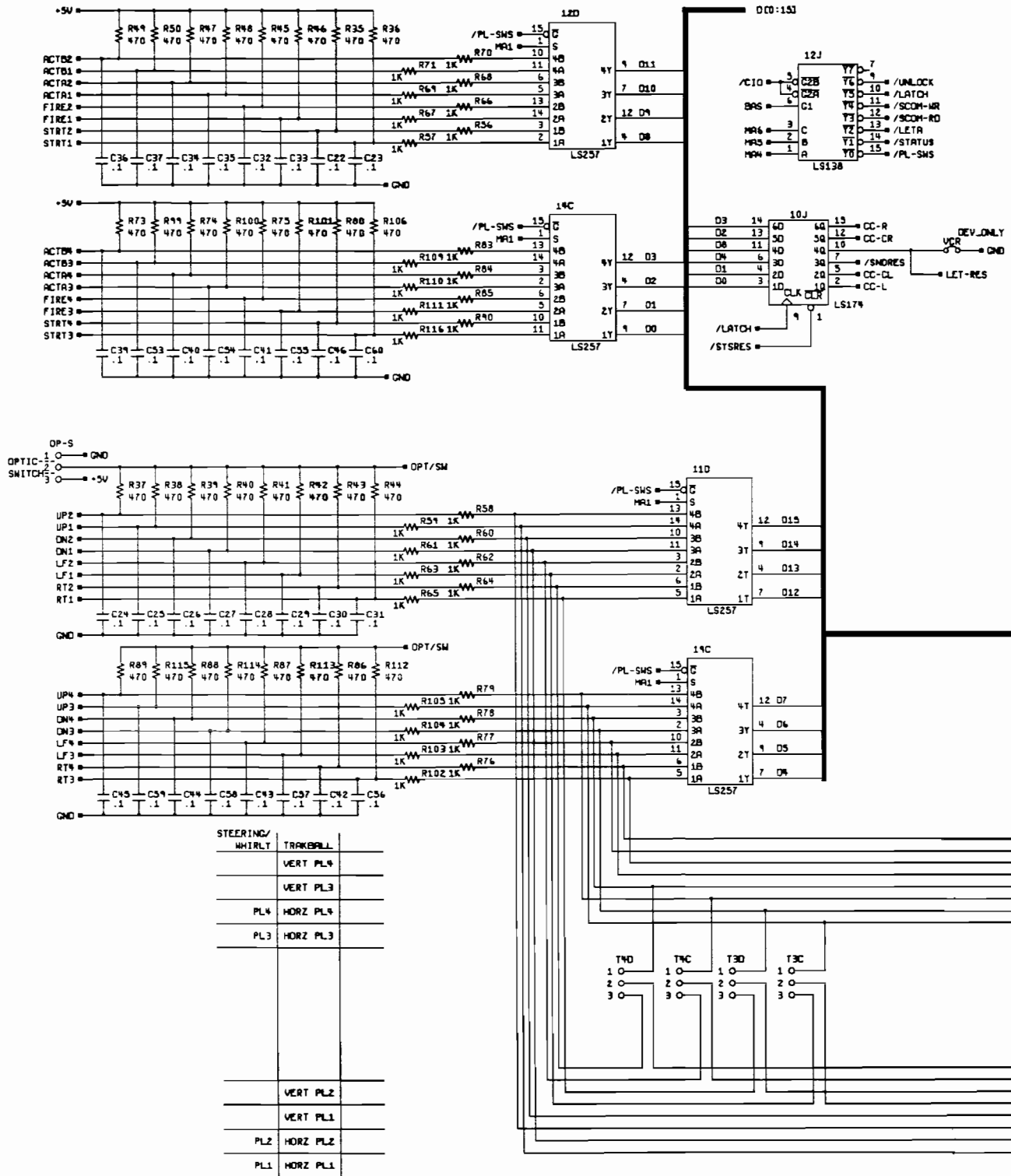


Figure 5-1 Relief Pitcher Game PCB Assembly Schematic Diagram

049726-01 H



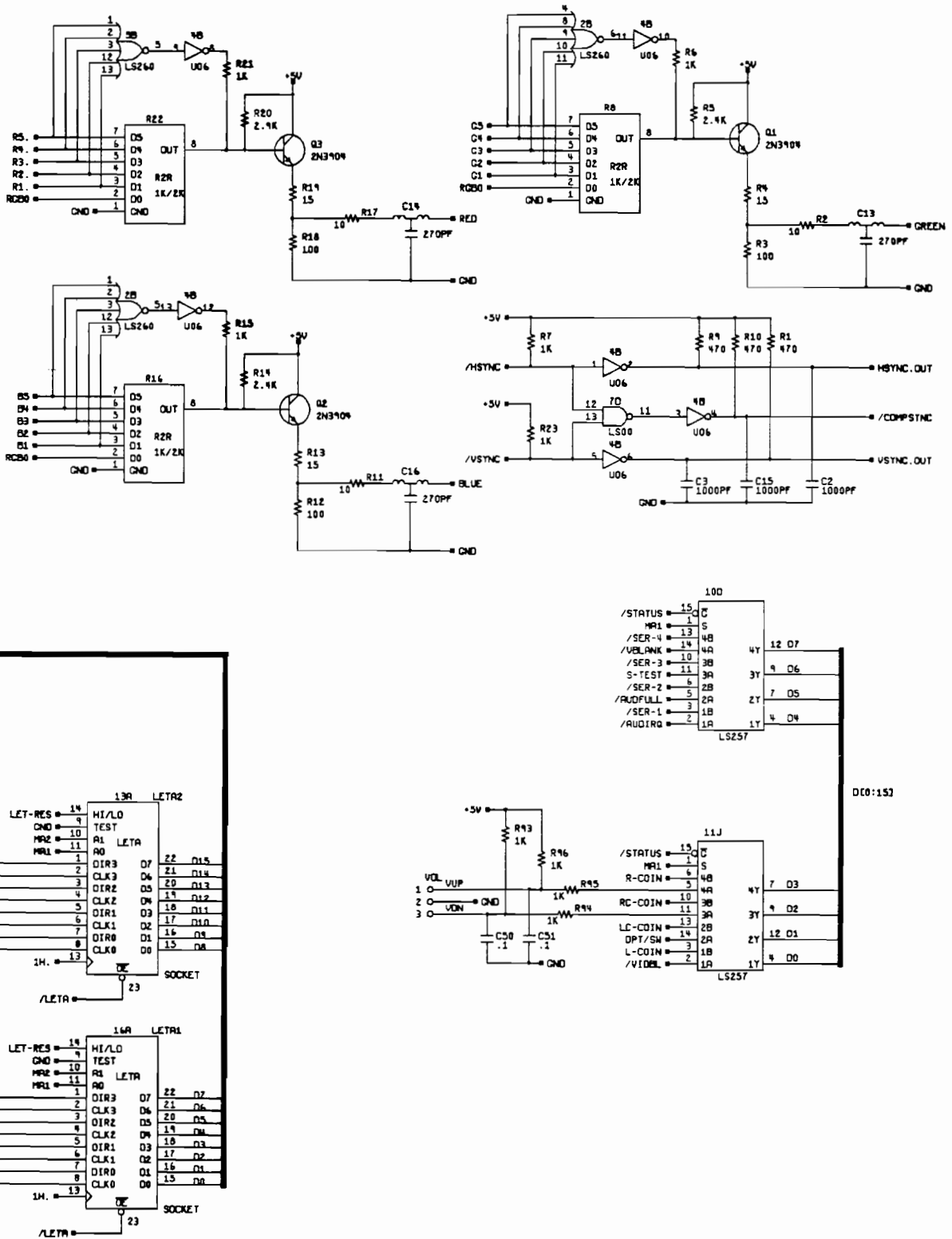
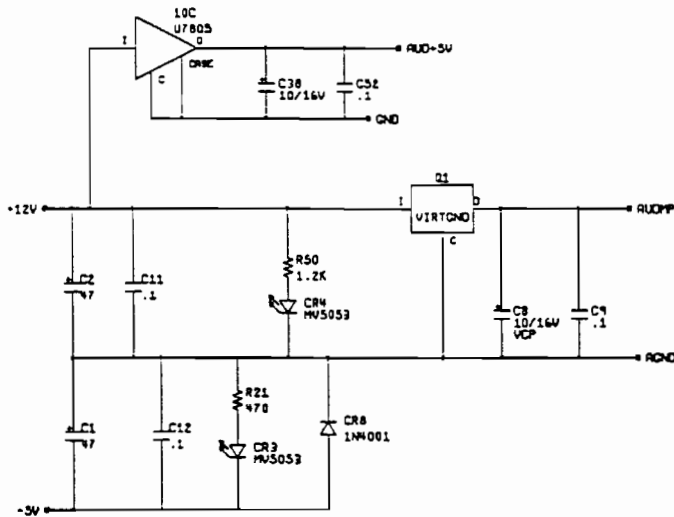
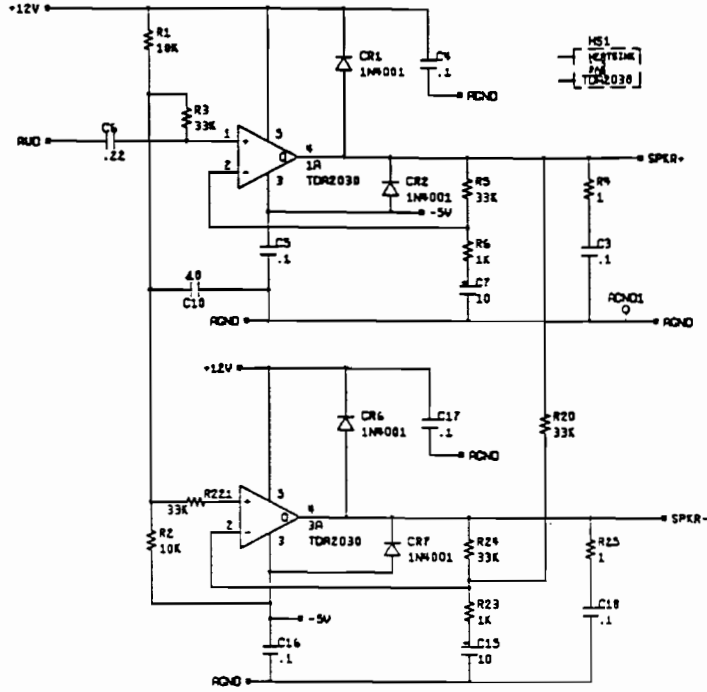
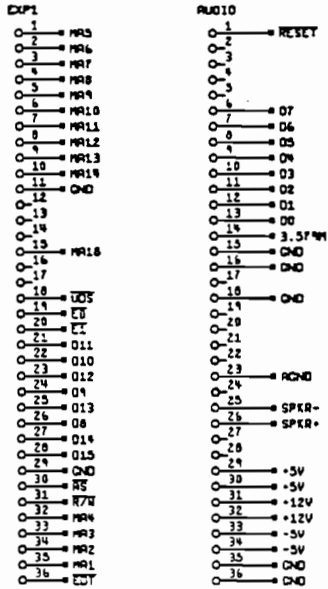
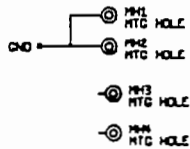
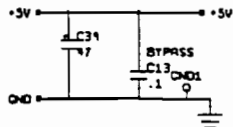
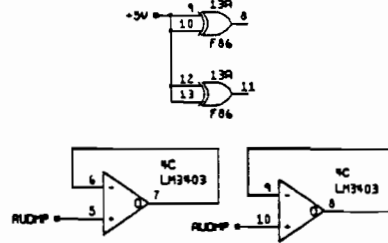


Figure 5-1 Relief Pitcher Game PCB Assembly Schematic Diagram

049726-01 H



SPARE GATES



GND AND RCHND TIED INTERNALLY NEAR MSM6295

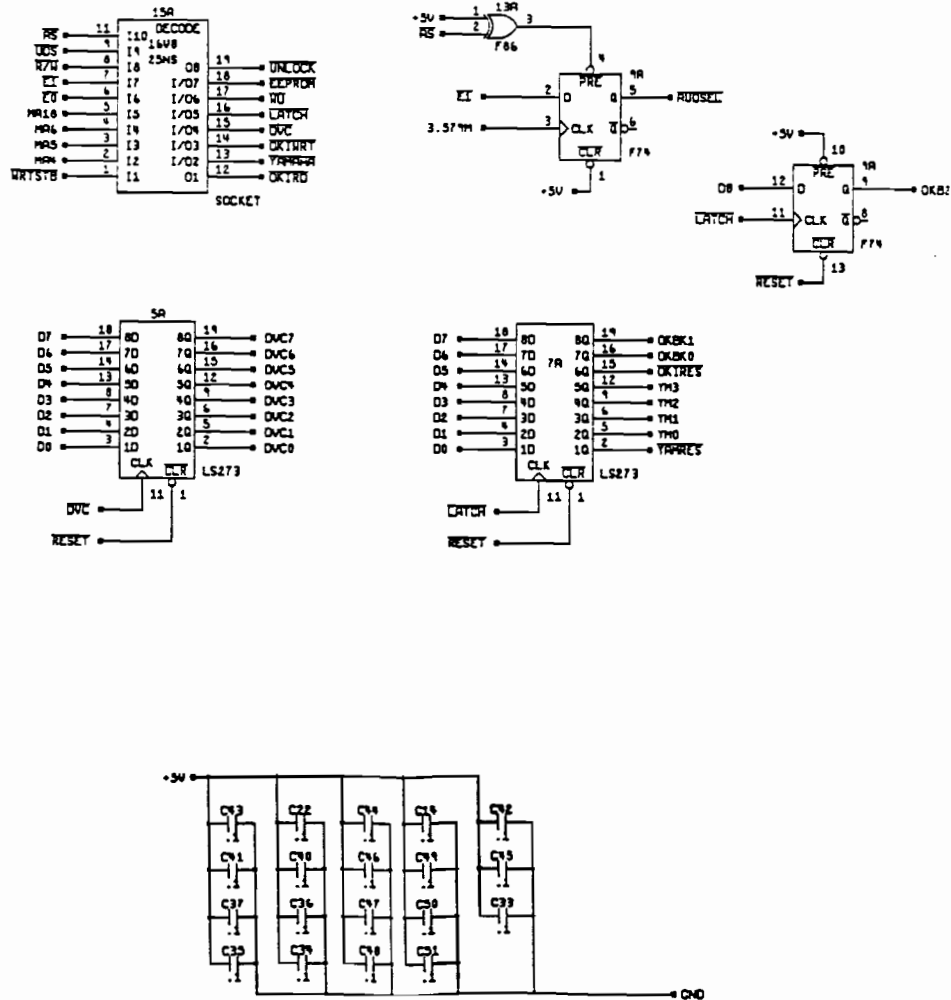
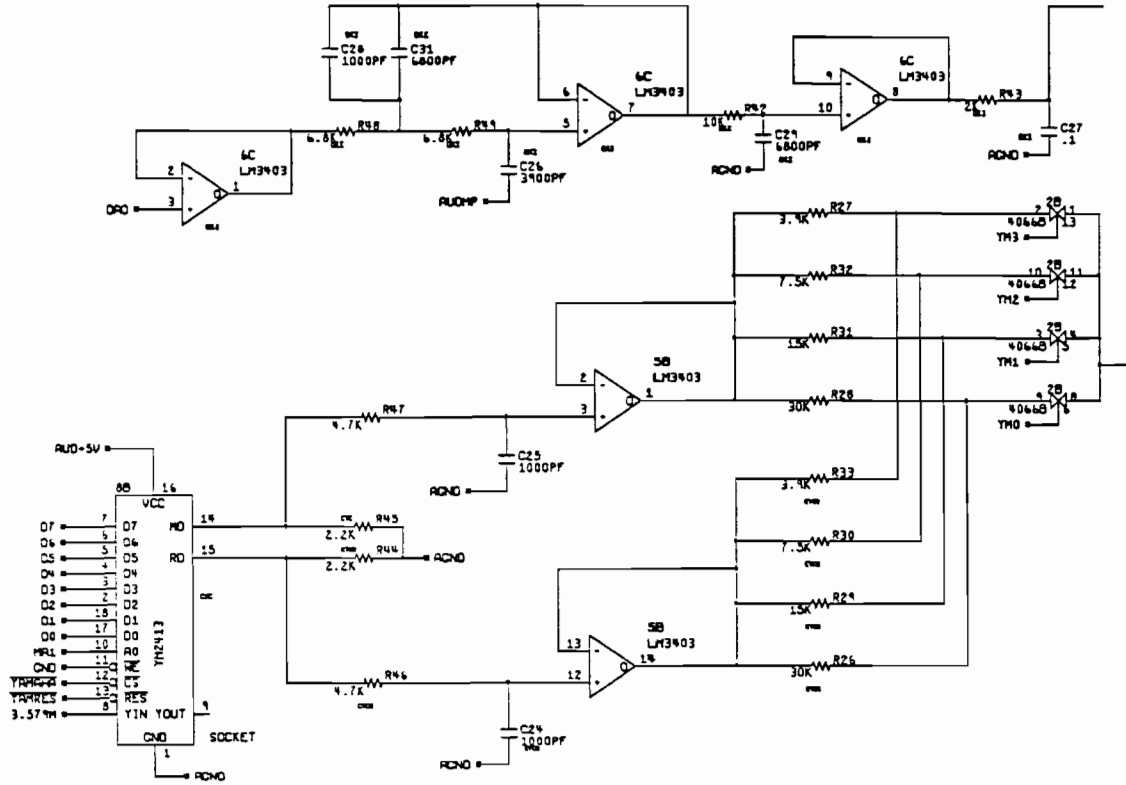
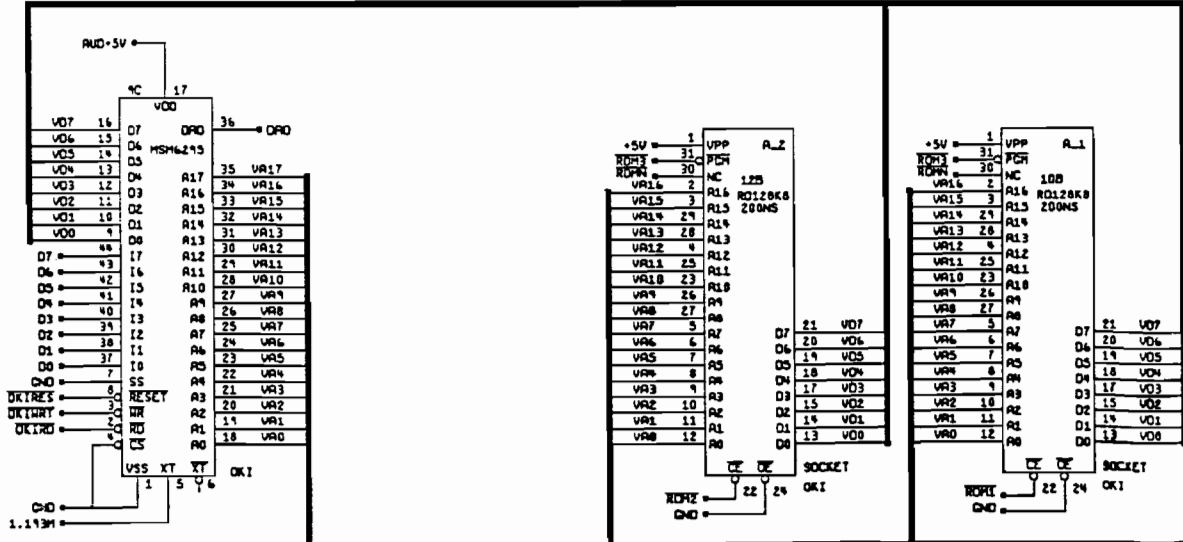


Figure 5-2 Relief Pitcher Audio PCB Assembly Schematic Diagram

A050134-XX B



VD (8:7)



VA (8:17)

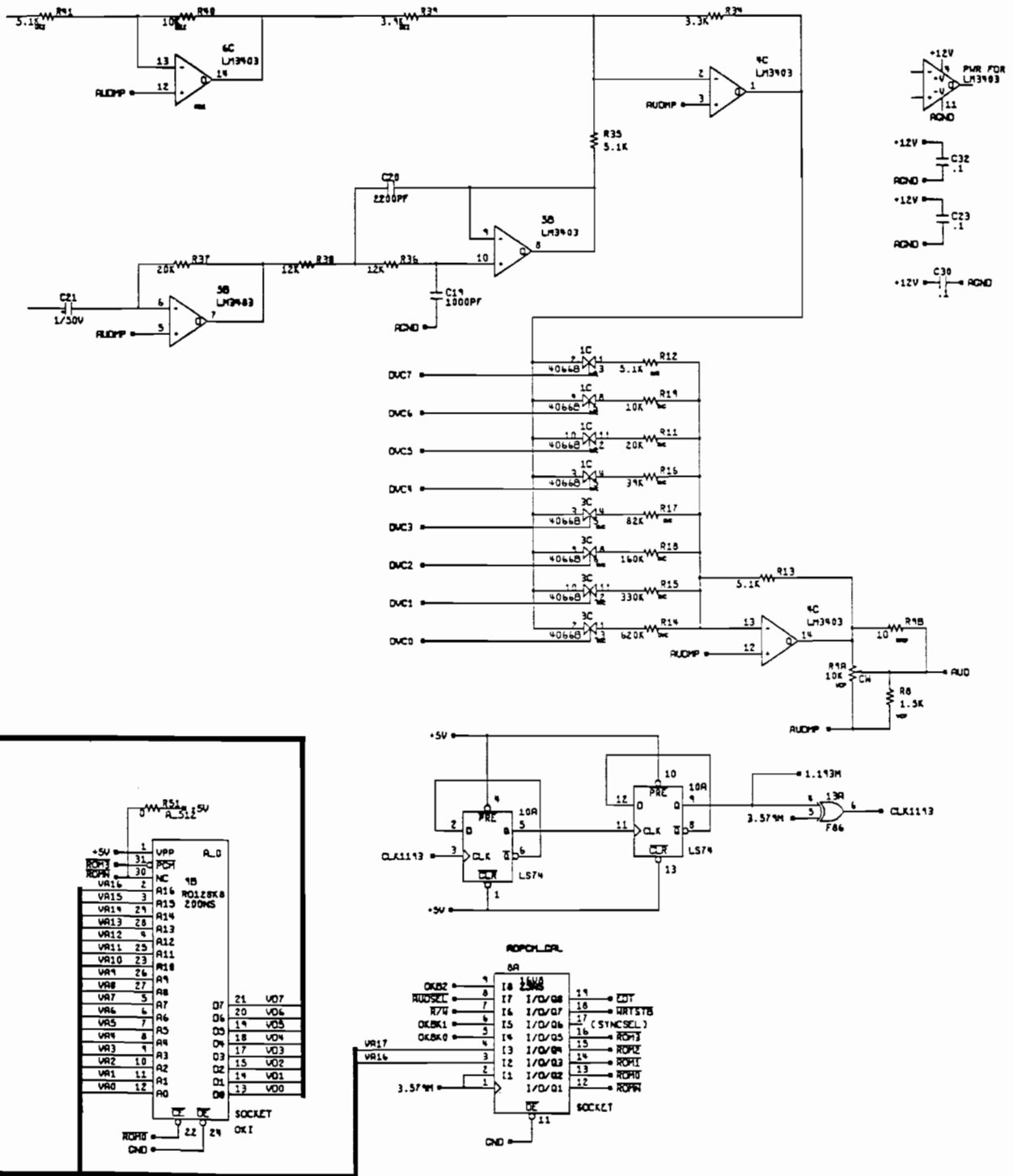


Figure 5-2 Relief Pitcher Audio PCB Assembly Schematic Diagram

A050134-XX B

**N O T E S**





# Relief Pitcher™ Kit Statistics Sheet

Date Recorded: \_\_\_\_\_ Location: \_\_\_\_\_

Meter: \_\_\_\_\_

## *1st Screen — Statistics*

Left Coins	_____		
Right Coins	_____		
Auxiliary Coins	_____		
Idle Minutes	_____	_____	_____
1-Player Minutes	_____	_____	_____
2-Player Minutes	_____	_____	_____
Wasted Minutes	_____	_____	_____
1-Player 9-inning game	_____		
1-Player 24-game season	_____		
2-Player 9-inning game	_____		
2-Player 7-game series	_____		
Chose BASHERS	_____		
Chose DUSTERS	_____		
Chose SPEEDERS	_____		
Chose STROKERS	_____		
Timeout PITCH	_____		
Timeout COACH	_____		
Error Count	_____		
Total Coins	_____	_____	_____
Percentage Play	_____		
Percentage Setup	_____		





# Relief Pitcher™ Kit Statistics Sheet

Date Recorded: \_\_\_\_\_ Location: \_\_\_\_\_

Meter: \_\_\_\_\_

## 2nd Screen — Statistics for Each Player Position

	Coins Used	Total Minutes	Average
1-Player NEW	_____	_____	_____
1-Player CONT	_____	_____	_____
2-Player NEW	_____	_____	_____
2-Player CONT	_____	_____	_____

## 3rd Screen — Performance Statistics

At Bats	_____	Avg	_____
Hits	_____	Slugging %	_____
Runs Scored	_____	Total Bases	_____
Homers	_____		
Triples	_____		
Doubles	_____		
Walks	_____		
Sacrifices	_____		
Pitches Thrown	_____		
Strikeouts	_____	ERA	_____
Runs Allowed	_____	Pitch/At Bat	_____
Allowed Hits	_____		
Walks Given Up	_____		
Batters Hit	_____		
Hitters Faced	_____		
Outs Made	_____		
Double Plays	_____		



# Warranty

Seller warrants that its printed-circuit boards and parts thereon are free from defects in material and workmanship under normal use and service for a period of ninety (90) days from date of shipment. Seller warrants that its video displays and laser-video disc players (in games supplied with displays and video-disc players) are free from defects in material and workmanship under normal use and service for a period of thirty (30) days from date of shipment. None of the Seller's other products or parts thereof are warranted.

If the products described in this manual fail to conform to this warranty, Seller's sole liability shall be, at its option, to repair, replace, or credit Buyer's account for such products which are returned to Seller during said warranty period, provided:

- (a) Seller is promptly notified in writing upon discovery by Buyer that said products are defective;
- (b) Such products are returned prepaid to Seller's plant; and
- (c) Seller's examination of said products discloses to Seller's satisfaction that such alleged defects existed and were not caused by accident, misuse, neglect, alteration, improper repair, installation, or improper testing.

In no event shall Seller be liable for loss of profits, loss of use, incidental or consequential damages.

*Except for any express warranty set forth in a written contract between Seller and Buyer which contract supersedes the terms herein, this warranty is expressed in lieu of all other warranties expressed or implied, including the implied warranties of merchantability and fitness for a particular purpose, and of all other obligations or liabilities on the Seller's part, and it neither assumes nor authorizes any other person to assume for the Seller any other liabilities in connection with the sale of products by Seller.*

The use of any non-Atari parts may void your warranty, according to the terms of the warranty. The use of any non-Atari parts may also adversely affect the safety of your game and cause injury to you and others. Be very cautious in using non-Atari-supplied components with our games, in order to ensure your safety.

Atari distributors are independent, being privately owned and operated. In their judgment they may sell parts or accessories other than Atari parts or accessories. Atari Games Corporation cannot be responsible for the quality, suitability or safety of any non-Atari part or any modification including labor which is performed by such distributor.

