



## SEGA AMUSEMENTS U.S.A., INC.

800 ARTHUR AVENUE, ELK GROVE VILLAGE, IL 60007-5215  
Phone: 888-877-2669 Facsimile: 847-427-1065  
WEB: WWW.SAU.SEGA.COM

© SEGA

All manufacturers, cars, names, brands and associated imagery featured in this game are trademarks and/or copyrighted materials of their respective owners. All rights reserved.



## OWNER'S MANUAL

# RAMBO™



### IMPORTANT

- Before using this product, read this manual carefully to understand the contents herein stated.
- After reading this manual, be sure to keep it near the product or in a convenient place for easy reference when necessary.

# TABLE OF CONTENTS

BEFORE USING THE PRODUCT, BE SURE TO READ THE FOLLOWING:

TABLE OF CONTENTS .....	i
INTRODUCTION .....	iv
<b>1</b> HANDLING PRECAUTIONS .....	1
<b>2</b> PRECAUTIONS REGARDING INSTALLATION LOCATION .....	3
2-1 LIMITATIONS OF USAGE .....	3
<b>3</b> PRECAUTIONS REGARDING PRODUCT OPERATION .....	4
<b>4</b> ASSEMBLY AND INSTALLATION .....	7
4-3 FIXATION TO INSTALLATION SITE .....	10
4-4 TURNING ON THE POWER .....	12
4-5 CHECKING ASSEMBLY (SETUP) .....	14
<b>5</b> PRECAUTIONS WHEN MOVING THE MACHINE .....	18
<b>6</b> GAME DESCRIPTION .....	20
6-1 HOW TO PLAY .....	20
6-2 HINTS FOR PLAYING THE GAME .....	25

**7 TEST MODE ..... 26**

    7-1 SWITCH UNIT AND COIN METER .....28

    7-2 SYSTEM TEST MODE .....29

    7-3 GAME TEST MODE .....31

        7-3-1 GAME TEST MODE Menu.....31

        7-3-2 INPUT TEST .....33

        7-3-3 OUTPUT TEST .....34

        7-3-4 GAME ASSIGNMENTS .....35

        7-3-5 GUN ADJUSTMENT.....36

        7-3-6 BOOKKEEPING .....41

        7-3-7 BACKUP DATA CLEAR .....44

**8 COIN SELECTOR..... 46**

**9 PERIODIC INSPECTION..... 47**

**10 TROUBLESHOOTING ..... 49**

**11 GAME BOARD ..... 51**

    11-1 REMOVING THE LINDBERGH .....51

    11-2 CLEANING THE LINDBERGH RED EX.....52

    11-3 COMPOSITION OF THE GAME BOARD.....55

**12 PARTS LIST..... 56**

**13 WIRING DIAGRAM..... 60**

■

■

# INTRODUCTION

This manual is intended to provide detailed descriptions together with all the necessary information covering the general operation of electronic assemblies, electro-mechanicals, servicing control, spare parts, etc. for the product, "PRIMEVAL HUNT DX."

This manual is intended for the owners, personnel and managers in charge of operation of the product. Operate the product after carefully reading and sufficiently understanding the instructions.

In the unlikely event that the product does not function correctly, DO NOT allow anyone other than a technician to touch the internal system. Turn off the power to the machine, making sure to unplug the electrical cord from the outlet, and contact the office listed below or the point of purchase for this product.

Use of this product is unlikely to cause physical injuries or damage to property. However, points that require special attention are indicated by bold text, the word "IMPORTANT" and the symbol below.



**Indicates important information that, if ignored, may result in the mishandling of the product and cause faulty operation or damage to the product.**

## Sega Amusements U.S.A., Inc.

800 Arthur Avenue, Elk Grove Village, IL 60007-5215, U.S.A.

TEL: 1-847-364-9787

TOLL FREE: 1-888-877-2669

FAX: 1-847-427-1065

## Definition of 'Site Maintenance Personnel or Other Qualified Individuals'

### WARNING

Procedures not described in this manual or marked as 'to be carried out by site maintenance personnel or other qualified professionals' should not be carried out by personnel without the necessary skill or technology. Work carried out by unqualified persons may cause serious accidents, including electrocution.

Parts replacement, maintenance inspections and troubleshooting should be carried out by site maintenance personnel or other qualified professionals. This manual includes directions for potentially dangerous procedures which should only be carried out by professionals with the appropriate specialized knowledge.

The site maintenance personnel or other qualified professionals mentioned in this manual are defined as follows:

#### **Site maintenance personnel:**

Individuals with experience in maintaining amusement equipment, vending machines, etc., working under the supervision of the owner/operator of this product to maintain machines within amusement facilities or similar premises by carrying out everyday procedures such as assembly, maintenance inspections, and replacement of units/expendable parts.

#### **Activities to be carried out by site maintenance personnel:**

Amusement equipment/vending machine assembly, maintenance inspection and replacement of units/expendable parts.

#### **Other qualified professionals:**

Persons employed by amusement equipment manufacturers, or involved in design, production, testing or maintenance of amusement equipment. The individual should have either graduated from technical school or hold similar qualifications in electrical/electronics/mechanical engineering.

#### **Activities to be carried out by other qualified professionals:**

Amusement equipment/vending machine assembly, repair/adjustment of electrical/electronic/mechanical parts.



# 1 HANDLING PRECAUTIONS

When installing or inspecting the machine, be very careful of the following points and pay attention to ensure that the player can enjoy the game safely.

Non-compliance with the following points or inappropriate handling running counter to the cautionary matters herein stated can cause personal injury or damage to the machine.

## WARNING

- Before performing work, be sure to turn the power off. Performing the work without turning the power off can cause an electric shock or short circuit. In the case work should be performed in the status of power on, this manual always states to that effect.
- To avoid an electric shock or short circuit, do not plug in or unplug quickly.
- To avoid an electric shock, do not plug in or unplug with a wet hand.
- Do not expose power cords or earth wires on the surface, (floor, passage, etc.). If exposed, the power cords and earth wires are susceptible to damage. Damaged cords and wires can cause an electric shock or short circuit.
- To avoid causing a fire or an electric shock, do not put things on or damage the power cords.
- When or after installing the product, do not unnecessarily pull the power cord. If damaged, the power cord can cause a fire or an electric shock.
- In case the power cord is damaged, ask for a replacement through where the product was purchased from or the office herein stated. Using the cord as is damaged can cause fire, an electric shock or leakage.
- Be sure to perform grounding appropriately. Inappropriate grounding can cause an electric shock.
- Be sure that connections such as IC BD are made properly. Insufficient insertion can cause an electric shock.
- Specification changes, removal of equipment, conversion and/or addition, not designated by SEGA are not permitted.
  - Failure to observe this may cause a fire or an electric shock. Non-compliance with this instruction can have a bad influence upon physical conditions of the players or the onlookers, or result in injury during play.
  - SEGA shall not be held responsible for damage, compensation for damage to a third party, caused by specification changes not designated by SEGA.
- Do not perform any work or change parts not listed in this manual. Doing so may lead to an accident.

If you need to perform any work not listed in this manual, request work from the office indicated in this manual or the point of purchase, or inquires for details.
- Be sure to perform periodic maintenance inspections herein stated.

**STOP**

## **IMPORTANT**

- For the IC board circuit inspections, only the logic tester is allowed. The use of a multiple-purpose tester is not permitted, so be careful in this regard.
- Static electricity from your body may damage some electronics devices on the IC board. Before handling the IC board, touch a grounded metallic surface so that the static electricity can be discharged.
- This product uses a DLP projector. DLP projector screens scratch easily, so be careful when cleaning the screen.
- Some parts are not designed and manufactured specifically for this game machine. The manufacturers may discontinue, or change the specifications of such general-purpose parts. If this is the case, SEGA cannot repair or replace a failed game machine whether or not a warranty period has expired.

### **CONCERNING THE STICKER DISPLAY**

This SEGA product has stickers attached describing the product manufacture No. (Serial No.) and Electrical Specifications. It also has a Sticker describing where to contact for repair and for purchasing parts.

When inquiring about or asking for repairs, mention the Serial No. and Name of Machine indicated on the Sticker.

The Serial Number indicates the product register. Identical machines could have different parts depending on the date of production. Also, improvements and modifications might have been made after the publication of this manual. In order to ensure you order the correct parts, mention the Serial No. when contacting the applicable places.

### **CONCERNING WARNING DISPLAYS**

This SEGA product has warning displays on stickers, labels and/or printed instructions adhered/attached to or incorporated in the places where a potentially hazardous situation could arise. The warning displays are intended for accident prevention for customers and for avoiding hazardous situations relating to maintenance and servicing work. Some portions of the cabinet contain high voltage and may cause accidents if touched. When performing maintenance, be very careful of the warning displays. It is especially important that any complex repair and replacement work not mentioned herein should be performed by those technical personnel who have knowledge of electricity and technical expertise.

In order to prevent accidents, caution any customer ignoring the warnings to cease and desist immediately.



## 2 PRECAUTIONS REGARDING INSTALLATION LOCATION

### WARNING

This product is an indoor game machine. Do not install it outside. Even indoors, avoid installing in places mentioned below so as not to cause a fire, electric shock, injury and/or malfunction.

- Places subject to rain or water leakage, or places subject to high humidity in the proximity of an indoor swimming pool and/or shower, etc.
- Places subject to direct sunlight, or places subject to high temperatures in the proximity of heating units, etc.
- Places filled with inflammable gas or vicinity of highly inflammable/volatile chemicals or hazardous matter.
- Dusty places.
- Sloped surfaces.
- Places subject to any type of violent impact.
- Vicinity of anti-disaster facilities such as fire exits and fire extinguishers.
- Areas where the temperature exceeds the applicable temperature (ambient temperature) range of 10 to 30 degrees centigrade.

### 2-1 LIMITATIONS OF USAGE

### WARNING

- Be sure to check the Electrical Specifications. Ensure that this product is compatible with the location's power supply, voltage, and frequency requirements. A plate describing Electrical Specifications is attached to the product. Non-compliance with the Electrical Specifications can cause a fire and electric shock.
- This product requires a breaker and earth mechanism as part of the location facilities. Using the product without these can cause a fire and electric shock.
- Ensure that the indoor wiring for the power supply is rated at 15 A or higher (AC single phase 100 V ~ 120 V area), and 7 A or higher (AC 220 V ~ 240 V area). Non-compliance with the Electrical Specifications can cause a fire and electric shock.
- Be sure to use an independent power supply equipped with an earth leakage breaker. Using a power supply without an earth leakage breaker can cause an outbreak of fire if a power surge occurs.
- Putting many loads on one electrical outlet can cause generation of heat and a fire resulting from overload.
- When using an extension cord, ensure that the cord is rated at 15 A or higher (AC 100 V ~ 120 V area) and 7 A or higher (AC 220 V ~ 240 V area). Using a cord rated lower than the specified rating can cause a fire and electric shock.

### 3 PRECAUTIONS REGARDING PRODUCT OPERATION

To avoid injury and trouble, be sure to pay attention to the behavior of visitors and players.

#### 3-1 BEFORE OPERATION

##### WARNING

In order to avoid accidents, check the following before starting the operation:

- To ensure maximum safety for the players and the customers, ensure that where the product is operated has sufficient lighting to allow any warnings to be read. Operation under insufficient lighting can cause bodily contact with each other, hitting accident, and/or trouble between customers.
- Be sure to perform appropriate adjustment of DLP projector. For operation of this machine, do not leave monitor's flickering or deviation as is. Failure to observe this can have a bad influence upon the players' or the customers' physical conditions.
- It is suggested to ensure a space allowing the players who feel sick while playing the game to take a rest.
- Check if all of the adjusters are in contact with the surface. If they are not, the cabinet can move and cause an accident.



Ensure that all of the adjusters are in contact with the floor.

## 3-2 DURING OPERATION (PAYING ATTENTION TO CUSTOMERS)

To avoid injury and trouble, be sure to pay attention to the behavior of visitors and players.

### WARNING

- For safety reasons, do not allow any of the following people to play the game.
  - Those who need assistance such as the use of apparatus when walking.
  - Those who have high blood pressure or a heart problem.
  - Those who have experienced muscle convulsion or loss of consciousness when playing video games, etc.
  - Those who have neck or spinal cord problems.
  - Those who are intoxicated or under the influence of drugs.
  - Pregnant women.
  - Those who are not in good health.
  - Those who do not follow the attendant's instructions.
  - Those who cannot grasp the Control Unit securely because of immobility in fingers, hands or arms.
  - Persons who disregard the product's warning displays.
- Even players who have never been adversely affected by light stimulus might experience dizziness or headache depending on their physical condition when playing the game. Small children are especially likely to experience these symptoms. Caution guardians of small children to keep watch on their children during play.
- Instruct those who feel sick during play to have a medical examination.
- To avoid injury from falls and electric shocks due to spilled drinks, instruct the player not to place heavy items or drinks on the product.
- To avoid electric shocks and short circuits, do not allow customers to put hands and fingers or extraneous matter in the openings of the product or small openings in or around the doors.
- To avoid falls and resulting injury, immediately stop the customer from leaning against or climbing on the product, etc.
- To avoid electric shock and short circuit, do not allow customers to unplug the power plug without a justifiable reason.
- Be sure to instruct the adult responsible for their children to watch them. Children cannot sense danger. Approaching the player during play may result in accidental contact, collisions or falls. If the Control Unit is pulled from the Controller Net and dropped on the head, it may cause injury.
- Caution the player not to wrap the Control Unit (Gun) cord around his/her wrist or neck, as this can lead to serious injury.

**⚠ CAUTION**

- Immediately stop such violent acts as hitting and kicking the product. Such violent acts can cause parts damage or cause the cabinet to fall over, resulting in injury.
- Immediately stop users from leaning or sitting on the Controller Net. Such acts can lead to injury or damage to parts or the shape of the cabinet.
- Immediately stop users from swinging or reloading the Control Unit in a violent manner. Such acts may hurt the user or other people around them.
- Playing too close to the cabinet may cause the Control Unit to hit the cabinet and cause damage. Make sure that players understand to play at a safe distance from the cabinet.
- Make sure that players understand not to stand too close together when playing a two player game. Swinging the Control Unit could lead to a player getting hit and may cause injury.
- Instruct players to hold the Control Unit securely while playing. If the Control Unit is dropped, it could cause injury to the player.
- Items such as large finger rings can cause injury to the fingers while playing. Instruct players to remove all accessories that could cause an accident before playing.
- Instruct players that a single Control Unit is never to be held by two or more people during play. Otherwise there could be dangerous contact or a collision.

**STOP****IMPORTANT**

The Control Units for use on 1P side (left side) and 2P side (right side) are different. Ensure that players do not confuse the right and left side guns when starting play.

## 4 ASSEMBLY AND INSTALLATION

### WARNING

- This work should be carried out by site maintenance personnel or other qualified professionals. Work performed by non-technical personnel can cause a severe accident such as electric shock. Failing to comply with this instruction can cause a severe accident such as electric shock to the player during operation.
- Perform assembly work by following the procedure herein stated. Failure to comply with the instructions can cause electric shock.
- Perform assembling as per this manual. Since this is a complex machine, incorrect assembling can cause an electric shock, machine damage and/or improper functioning as per specified performance.
- When assembling, more than one person is required. Depending on the assembly work, there are some cases in which working by one person alone can cause personal injury or parts damage.
- Ensure that connectors are properly connected. Improper connections can cause electric shock.
- Provide sufficient space so that assembling can be performed. Performing work in places with narrow space or low ceiling may cause an accident and assembly work to be difficult.
- To perform work safely and avoid serious accident such as the cabinet falling down, do not perform work in places where step-like grade differences, a ditch, or slope exist.
- Be careful not to damage the wires. Damaged wires may cause electric shock or short circuit or present a risk of fire.
- Do not leave power cords, ground wires, or network cables exposed in areas of heavy foot traffic. Doing so may cause them to become damaged, possibly resulting in electric shock and/or short circuits. When laying wiring across the floor, always use safety covers to protect the wires. (Wiring diameter: power cable - approx. Ø 8.)

**⚠ CAUTION**

- Wear appropriate work clothing so that work can be performed safely. Use gloves and safety shoes to prevent accidents or injuries.
- When installing a wire protection cover over a floor, use a material shaped so that no one passing by will stumble over it. Using a material that could be stumbled over might lead to an accidental fall.
- Be careful in handling plastic parts. Be sure not to tighten screws or nuts too tightly. If such parts are exposed to excessive loads or impact, they might become damaged, resulting in fragments or cracks that could cause accidental injury.
- When attaching or removing doors or lids, be careful that your hand or finger does not get caught in anything.
- To perform work safely and securely, be sure to prepare a step which is in a secure and stable condition. Performing work without using the step can cause accidents such as falling down.

**STOP IMPORTANT**

Be very careful when handling the DLP projector screen. The screen is easily damaged but cannot be repaired. If damaged the entire screen must be replaced.

Installation and assembly of this product should take place in the following sequence.

4-1 Attaching the Billboard

4-2 Connecting the Rear Cabinet to the DLP Base

4-3 Fixation to Installation Site

4-4 Turning on the Power

4-5 Assembling Check

**Tools necessary for work**

- MASTER KEYS (Accessory)



- Phillips screwdrivers (for M4, M5 screws)

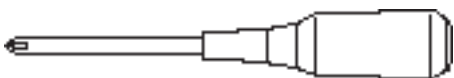

- Sockets for hexagon bolts and nuts (for M8 hexagon bolts)

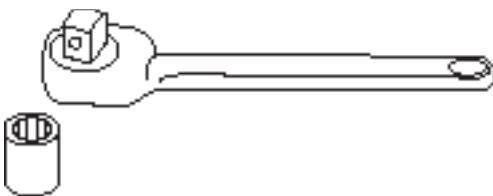

- Spanner with measuring distance of 24 mm to opposite side (for M16 hexagon bolts)

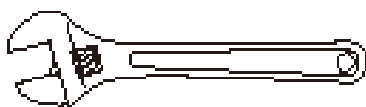

- Step

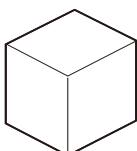

## 4-3 FIXATION TO INSTALLATION SITE

### **⚠️ WARNING**

**Make sure that all the adjusters contact the floor. Otherwise the cabinet could move, causing an accident.**

This product has 3 casters and 4 adjusters. After determining the installation location, have the adjusters contact the floor directly, and adjust them so the machine will remain in a level position keeping a space of about 5 mm between the floor and the casters.



- 1** Move the product to the installation site.  
Secure a 200 mm space between the back wall and the back of the cabinet for ventilation.



**2** Bring the adjusters into direct contact with the floor. Use a wrench to align the height of the adjusters until the cabinet is perfectly level.

**3** After setting, turn adjuster nuts upwards to tighten them and secure adjuster heights.

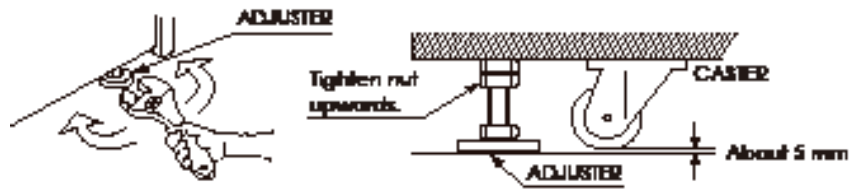

6-7 FIG. 03

## 4-4 TURNING ON THE POWER

### WARNING

- Be careful not to damage the DVD wire by getting it caught between objects, etc. Doing so may cause a short circuit or fire.
- The following explanation assumes that the product has been assembled properly as explained above. If there is an error or if the product operates in a manner other than as indicated below, cut off the power supply immediately. Failure to do so may result in a fire or electrical shock.
- If you look directly at the laser beam in the DVD DRIVE, you could suffer vision impairment. Do not look inside the DVD DRIVE.

**STOP**

### IMPORTANT

- Do not use or store the DVD DRIVE or DVD wire in any of the following locations, as this may result in serious damage.

[Do not use or store in these locations]

- Anywhere which may vibrate or shock the equipment
- In direct sunlight
- In damp or dusty places
- In places with a sharp change in temperature
- Close to anything that gives off heat (a heater, etc.)
- Close to anything with a strong magnetic field (magnets, monitor, speakers, radio, etc.)
- Anywhere that is likely to get wet (kitchen, etc.)
- Anywhere with a slope or incline
- Anywhere with corrosive gas in the air (chlorine, hydrogen sulfide, ammonia, sulfur dioxide, etc.)
- Anywhere with strong static electricity

[Do not use in these locations]

- Close to anything that is highly retentive of heat (carpet, sponge, cardboard, etc.)
- Anywhere that blocks the DVD DRIVE air vent.
- The DVD DRIVE is a delicate piece of equipment. Avoid the following.
  - Dropping or shaking it violently.
  - Getting water or other liquids on it, or placing small items on top of it.
  - Placing large or heavy items on top of it.
  - Drinking or smoking close to the DVD DRIVE.

- Do not turn off the power to the DVD DRIVE when its access lamp is on or flashing, as this could cause damage to the device.
- Do not allow any foreign materials, such as liquids, metals or smoke inside the DVD DRIVE.
- Use a soft, dry cloth to wipe off any dirt or marks on the DVD DRIVE.
  - If you need to use a cleaning agent, always use a “neutral” agent diluted in water.
  - Never use products or cleaning agents containing benzene, alcohol, thinners, etc.
- Do not touch the lens inside the DVD DRIVE. Doing so may prevent it from reading accurately.
- The chip components on IC boards can be damaged by electrostatic discharge from the human body. Before handling an IC board, always neutralize any static charge in the body by touching a grounded metal surface.
- Some parts are not designed and manufactured specifically for the kit. The manufacturers may discontinue, or change the specifications of such general purpose parts. If this is the case, SEGA cannot repair or replace a failed kit whether or not a warranty period has expired.

## 4-5 ASSEMBLING CHECK

Refer to 9-1 and start the Test Mode.

Using Test Mode, verify points such as the proper assembly of the machine. Also verify normal operation of the LINDBERGH RED EX, boards which have been connected, and the product's various input and output devices. In Test Mode, conduct the tests described below.

### (1) MONITOR TEST

When MONITOR TEST is chosen from System Test Menu Screen, a screen to test the Monitor will be displayed. Though the Monitor is pre-adjusted at the time of shipment from the factory, view the test screen to determine whether or not adjustment is necessary. If so, refer to Chapter 11 and adjust the Monitor.

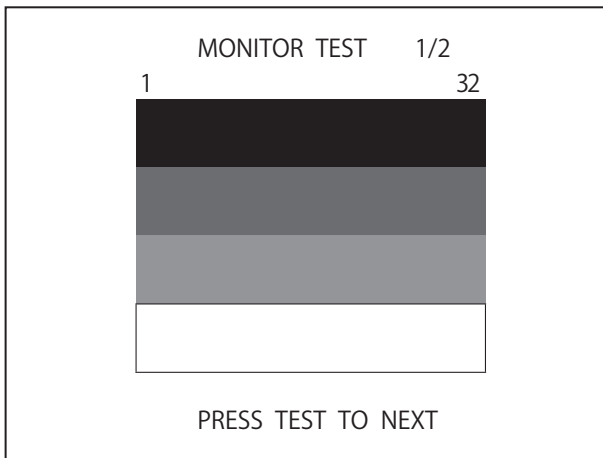

6-11 FIG. 01

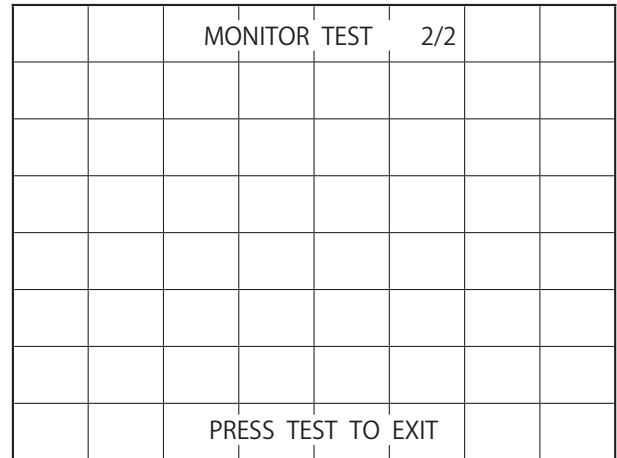

6-11 FIG. 02

### (2) SPEAKER TEST

When SPEAKER TEST is chosen from System Test Menu Screen, a screen to test each of the speakers will be displayed.

The RIGHT SPEAKER and the LEFT SPEAKER are the only speakers which can be checked by just changing their respective settings to ON and OFF.

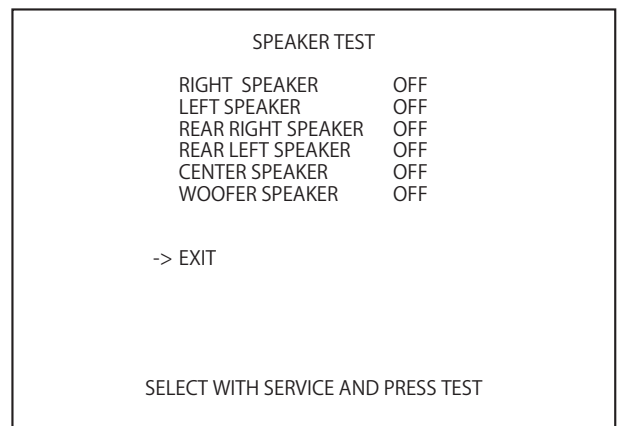

6-11 FIG. 03

### (3) INPUT TEST

When INPUT TEST is chosen from Game Test Menu Screen, a screen to test the game's switches will be displayed.

Flip each switch. If the display that appears to the right of the switch changes to "ON", the switch and its wiring are normal.

Refer to 9-5-2 and verify that it is operating normally.

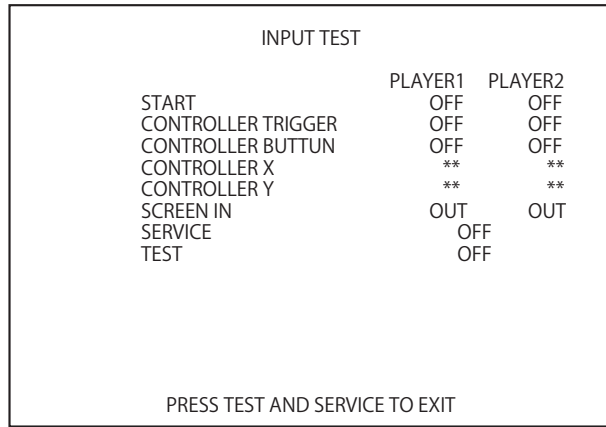

6-11 FIG. 04

### (4) OUTPUT TEST

When OUTPUT TEST is chosen from Game Test Menu Screen, a screen to test lamps and their wiring connections will be displayed. Refer to 9-3-3 and verify that the lamps illuminate correctly.

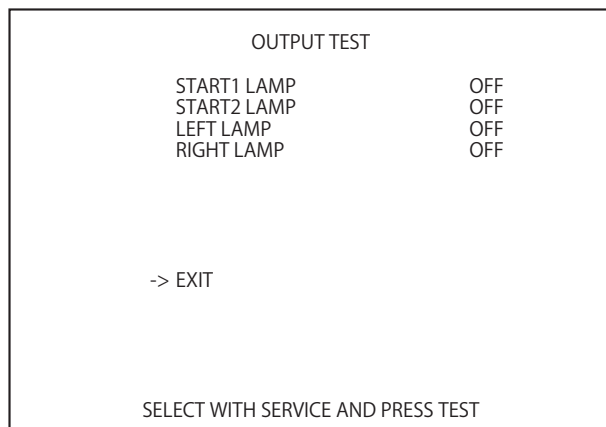

6-11 FIG. 05

### (5) CONTROLLER ADJUSTMENT

When CONTROLLER ADJUSTMENT is chosen from Game Test Menu Screen, a screen for adjusting the Control Unit crosshair will be displayed.

Before operating the product, always play the game to verify that there are no irregularities during play and that the crosshair does not require adjustment. (See 9-3-5.) Though the crosshair is adjusted at the factory, adjustment may be required in some situations because the product is disassembled for shipment.

*NOTE: Strong lighting located near the monitor, other machines in the surrounding area, and other objects may have an effect on the controller adjustment.*

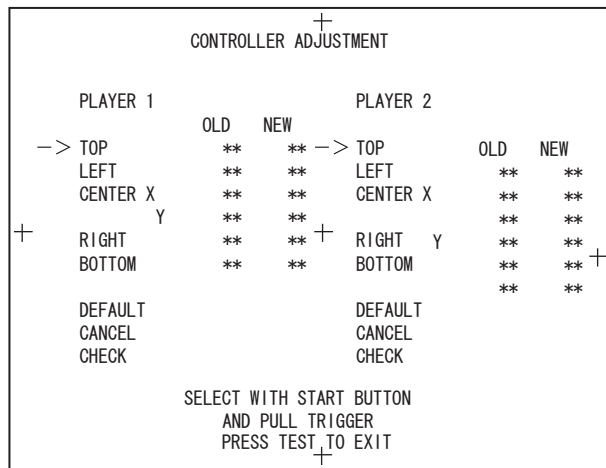

6-11 FIG. 06

The above inspections (1) – (4) should be conducted regularly as part of a monthly inspection. However, (5) CONTROLLER ADJUSTMENT should be conducted once per week.

## The Interference Prevention Wiring

### WARNING

- **This work should be performed by the site maintenance individual or other skilled professional. Work performed by non-technical personnel can cause malfunctioning.**
- **In order to prevent electric shock and short circuit hazards, be sure to turn power off before performing work.**
- **Be careful not to damage the wires. Damaged wires may cause electric shock or short circuit or present a fire risk.**

When the game machines of a same or similar type are installed side by side, their sensors may interfere with each other. To reject the interference, follow the procedure below.

The following game machines employ a same or similar type of sensor. If interference happens to the sensors, operation of the games may be mutually disturbed.

- THE HOUSE OF THE DEAD 2, U/R type, DX type and Super DX type
- DEATH CRIMSON, U/R type and DX type
- THE LOST WORLD, U/R type, DX type and Super DX type
- BRAVE FIRE FIGHTERS
- SAMBA DE AMIGO
- CONFIDENTIAL MISSION, U/R type and DX type
- SHAKATTO TAMBOURINE
- LUPIN THE 3RD THE SHOOTING, U/R type and DX type
- THE MAZE OF THE KINGS, U/R type and DX type
- THE HOUSE OF THE DEAD 3, U/R type and DX type
- VIRTUA COP 3, U/R type and DX type
- GHOST SQUAD, U/R type and DX type
- THE HOUSE OF THE DEAD 4 DX type and SPECIAL type
- 2SPICY
- RAMBO

---

**1** Turn the power off.

---

**2** Unlock the back door with the master key, and take it off.

- 
- 3** There is an interference prevention wire on the lower level inside the left side front door.

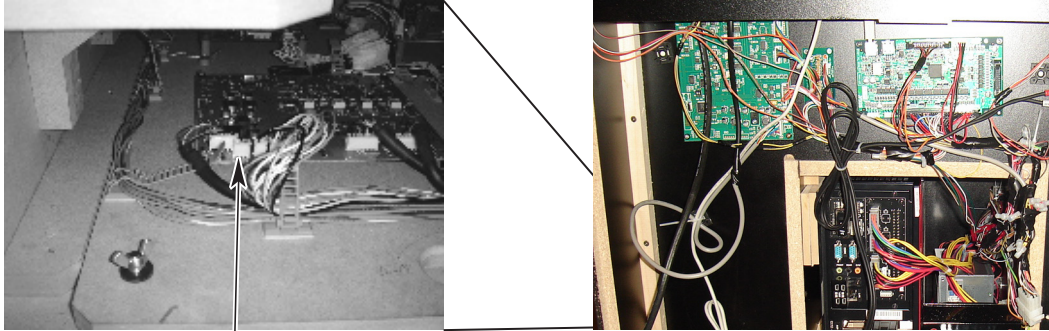

INTERFERENCE PREVENTION WIRE

6-11 FIG. 09

- 
- 4** Disconnect the connector from CN1 and remove the interference prevention wire (RMB-60047).

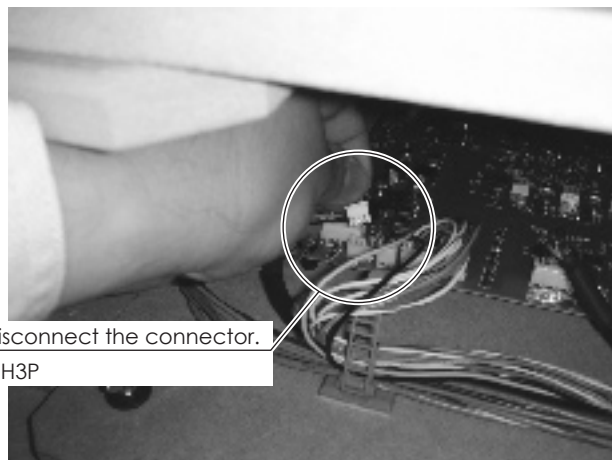

Disconnect the connector.  
XH3P

6-11 FIG. 10

- 
- 5** If several of the same type of game machines are to be installed beside each other, they should be lined up alternating between ones with the interference prevention wire connected and ones that with the wire removed. Be sure to keep the removed interference prevention wire.

## 5 PRECAUTIONS WHEN MOVING THE MACHINE

### WARNING

- When moving the machine, be sure to pull out the plug from the power supply. Moving the machine with the plug still inserted can cause the power cord to be damaged, resulting in a fire and/or electric shock.
- When moving the machine on the floor, retract the adjusters, and ensure that the casters make contact with the floor. Pay careful attention so that the casters do not run over power cords and earth wires. Damaging the power cords can cause an electric shock and/or short circuit.
- When lifting the cabinet, be sure to hold the handles and the bottom part. Lifting the cabinet by holding other portions may damage parts and installation portions due to the empty weight of the cabinet, and may cause personal injury.
- When moving the DLP projector, do not push it from the rear side. Push it from sideways. Pushing the DLP projector from the rear side can have the DLP projector fall down, causing personal injury, etc. In case the floor has slanted surfaces or step-like differences, be sure to move the machine by 2 or more persons.

### CAUTION

Do not hold or press the plastic parts as indicated by the Figure. Failure to observe this instruction may break the parts, and eventually the broken pieces may cause a personal injury.

### STOP IMPORTANT

- If the machine is going to be moved somewhere on a different level, disassemble it into the individual units before doing so. If the machine is tilted or the cabinet is set on an uneven surface the joints may break.
- Do not allow ropes to come in contact with the surface of the machine directly or they may scratch it. Put some kind of protective material under the rope where it will touch the machine.
- When moving the cabinet, do not hold it by the control unit or pull on the control unit. Doing so could damage the parts or cause them to become deformed.



To move the unit over the floor, pull in the adjustors and have the casters contact the floor.

Do not push the product holding the shaded areas.

## 6 GAME DESCRIPTION

### 6-1 HOW TO PLAY

- 1 When you insert coins, they will be counted in the credit display at the bottom of the screen. When you insert enough coins for a game, the message at the bottom will change from “INSERT COIN (S)” to “PRESS START BUTTON,” and the start buttons on either side will flash.  
Up to 9 credits can be counted at once. Coins inserted after 9 credits are recorded will not be counted or returned. However, the number of coins inserted will be counted in the data display and the coin meter.
- 2 Which start button you press will determine which side you will play on. Once you press the start button, the game will begin.
- 3 Once the game starts, the video demonstration will play, followed by the stage title, and then it will go to the actual game.

#### Game Screen

The LIFE, ammo remaining, RAGE GAUGE and Medals of the player playing on the left (Player 1) are shown at the bottom left of the screen, while those of the player playing on the right (Player 2) are shown at the bottom right of the screen. When there are no players playing, the number of credits is displayed.

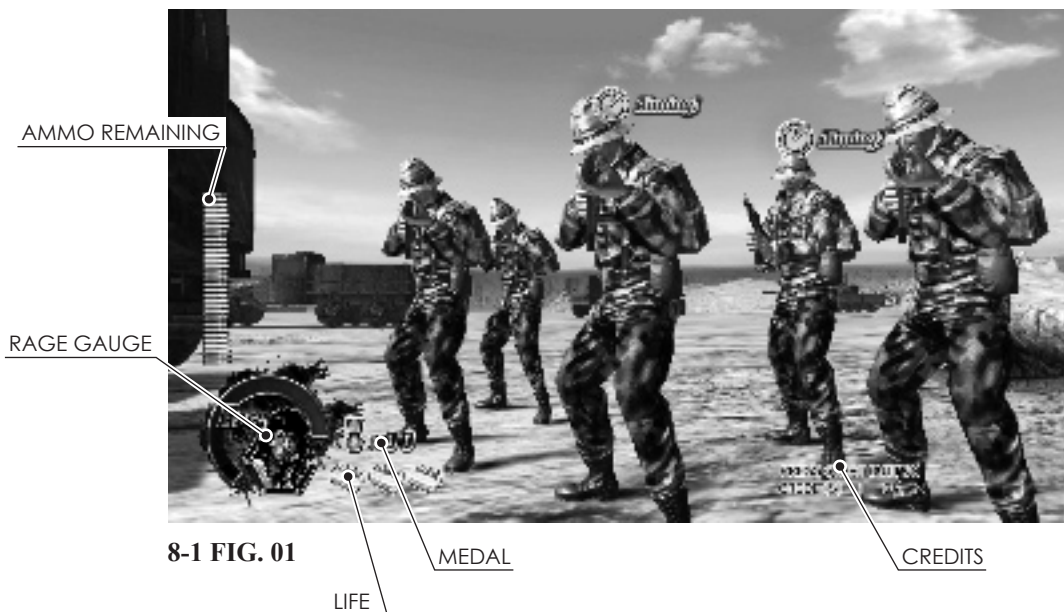

8-1 FIG. 01

## Reload

When the player fires all ammo remaining, the gun will be empty, and the “RELOAD” message will appear on the screen. The player can then reload the weapon by aiming it outside the screen. The player can reload this way even if there are still bullets left. The weapon is also reloaded automatically once a certain period of time has passed.



8-1 FIG. 02

## RAGE MODE

The player enters RAGE MODE after pressing the RAGE activation button. The player can use RAGE MODE for a set amount of time depending on the level displayed in the RAGE GAUGE. When RAGE MODE is activated, the power of the bullets and the automatic firing speed increase. If it is activated when the RAGE GAUGE is on MAX, the player will become invincible for a brief period of time.



8-1 FIG. 03

*NOTE: The Rage Gauge fills up quicker when the player defeats enemies efficiently. The gauge also fills when the player is hit by an enemy attack or through items.*

## Defense

Players can defend themselves from enemy hand grenades and missiles by shooting them down.

## Items

Items sometimes appear when the player shoots wooden boxes and drums in the background. The player can acquire the items by shooting them. The items fill the RAGE GAUGE, increase the player's Medals or recover LIFE.



**8-1 FIG. 04 First-aid kit (large)**

Adds two LIFE(s).



**8-1 FIG. 05 First-aid kit (small)**

Adds one LIFE.

However, it will not increase the number of LIFE past the MAX.  
(See 9-3-4 for details on the MAX LIFE setting.)



**8-1 FIG. 06 Medals (2)**

Adds two Medals.



**8-1 FIG. 07 Medal (1)**

Adds one Medal.

The more Medals a player collects, the higher the grade at the end of the stage.  
Medals are obtained by completing tasks or shooting items.



**8-1 FIG. 08 Rambo's Headband**

Fills the RAGE GAUGE completely.

## Tasks

As the game progresses, Rambo is faced with various tasks, such as defeating enemies with a knife or running away from bombs dropped from the air. Follow the on-screen instructions to complete the task.



8-1 FIG. 09

The instructions will vary depending on the task, such as shooting a target within a designated time limit or pressing the START button repeatedly. If the player fails at the task, the player's health may be damaged, possibly to the point of losing LIFE, or the player may be diverted to a path of the game where a large number of enemies appear and launch a massive attack.



8-1 FIG. 10

## Battles with Bosses

A unique boss awaits the player at the end of each stage.  
The way to defeat them varies and will be revealed in the form of on-screen instructions.



8-1 FIG. 11

The boss's life gauge will decrease when the player attacks according to the instructions. The player defeats the boss by successfully carrying out all of the instructions.

When the boss begins an attack, sometimes a cancel gauge will appear. The boss's attack can then be avoided by forcing the cancel gauge down to zero.



8-1 FIG. 12

## Game Over

If both players run out of LIFE, the game will end. LIFE is shown as first-aid kits.



- 
- 4** If you want to join the game during play, insert coins and press the START button at any time. If there are enough credits remaining to play, the START button on the side with no one playing will continue to flash. Joined the game by pressing the flashing START button.
- 
- 5** When all LIFE is lost, the CONTINUE message will be displayed. If you wish to CONTINUE, insert the required number of coins and press the START button again. If there are enough credits remaining to CONTINUE, you can join again by pressing the START button.
- 
- 6** If your total points are within the top 10 after completing all the stages in the game, you will be able to enter your name.

## 6-2 HINTS FOR PLAYING THE GAME

- **Aim and shoot at the weapons!**

If you shoot the enemies' weapons, they can be defeated with a single shot. Even the large enemies with lots of strength can be quickly eliminated if you aim at their weapons.

- **Defeat enemies with SUPERSHOTS**

When you defeat enemy with a SUPERSHOT, your Rage Gauge will fill quicker, and you will receive a higher grade at the end of the stage. There are three types of SUPERSHOTS: CRACK SHOTS, which are when you shoot an enemy's weapon, FAST SHOTS, which are when you defeat an enemy soon after he/she appears on the screen, and HEROIC SHOTS, which are when you defeat an enemy soon after he/she appears on the screen by shooting his/her weapon. You'll get through the game like a pro by making these SUPERSHOTS in succession.

- **Complete the tasks!**

Various tasks will arise within the stages. If you fail at a task, your health may be damaged or you may be diverted to a more difficult path. Successfully completing the tasks is the key to better performance.

- **If you are low on LIFE, shoot items that will give you more!**

When you are hit by enemy attacks, you will lose LIFE, but there are items within the stage that can increase your LIFE. You will also get more LIFE based on your performance after you clear a stage. Play often to improve your skills at getting more LIFE. Note that you will not be able to increase your LIFE past the MAX. (See 9-3-4 for details on the MAX LIFE setting.)

- **Make effective use of RAGE MODE!**

If you press the RAGE activation button when you have something in your RAGE GAUGE, you will enter RAGE MODE for the amount of time corresponding to what is left in your RAGE GAUGE. While in RAGE MODE, the power of your bullets and the automatic firing speed will increase, and you will not need to reload. Use RAGE MODE if you get surrounded by a large number of enemies or come up against an enemy that you are not good at defeating.

If you enter RAGE MODE after filling your RAGE GAUGE completely, you will be invincible.

You can fill your RAGE GAUGE quicker by defeating your enemies with SUPERSHOTS. The gauge will also fill when you are hit by enemy fire or acquire items.

- **Follow the instructions for defeating bosses carefully!**

The way to defeat the boss varies for each stage. Some of them can be defeated by hitting a target with a single shot, while others have to be shot with a large number of bullets within a certain amount of time. Remember the way to defeat them and fight them accordingly.

## 7 EXPLANATION OF TEST AND DATA DISPLAY

### WARNING

Do not touch any parts that are not specified in these directions. Touching unspecified locations may lead to electric shock or cause short circuits.

### CAUTION

Be careful that a finger or hand does not get caught when opening/closing the coin chute door.

### STOP IMPORTANT

- When you enter the Test Mode, fractional coin and bonus adder data is erased.
- Adjust the sound to the optimum volume, taking into consideration the environmental requirements of the installation location.
- Removing the coin meter circuitry renders the game inoperable.



Perform tests and data checks periodically by manipulating the TEST Button and SERVICE Button in the cabinet. Follow the instructions in this chapter to conduct checks when the game machine is first installed, when money is being collected, or when the game machine does not operate properly.

Shown below are the tests and screens to be used for different problems.

This product uses a LINDBERGH RED EX game board and a DVD DRIVE. In the system, a different game can be played by putting a different DVD ROM in the DVD DRIVE.

For this reason, the product's Test Mode consists of two modes: a System Test Mode for systems in which coin settings, for instance, are made for products that use the same system, and a Game Test Mode for setting of difficulty level, etc., and for input/output test of operational units used exclusively with this product.

*NOTE: "S/M" in the table denotes LINDBERGH RED EX service manual, which is provided with the product.*

**9 TABLE 01**

ITEMS	DESCRIPTION	REFERENCE SECTIONS
Game machine installation	1. Confirm that the Information Display Screen appears in normal fashion.	7-2
	2. Investigate each input device on the Input Test Screen.	7-3
	3. Investigate each output device on the Output Test Screen.	7-3
Periodic maintenance	1. Check settings.	7-3
	2. Test each input device on the Input Test Screen.	7-3-2
	3. Test each output device on the Output Test Screen.	7-3-3
Control problem	1. Investigate each input device on the Input Test Screen.	7-3-2
	2. Adjust or replace each input device.	7-3-2,
	3. If the problem persists, examine the mechanical components of each input device.	7-3,
Monitor problem	On the Monitor Adjustment Check Screen, check to be sure the monitor has been adjusted properly.	
IC board problem	1. Information Display Screen.	
	2. Speaker Test.	
Date check	Check data on game play times, histograms, etc., and adjust the level of difficulty.	7-3

## 7-1 SWITCH UNIT AND COIN METER

### Switch Unit

In Test Mode, the switch unit in the coin chute door is operated. Unlock and open the coin chute door. Inside is a switch unit.

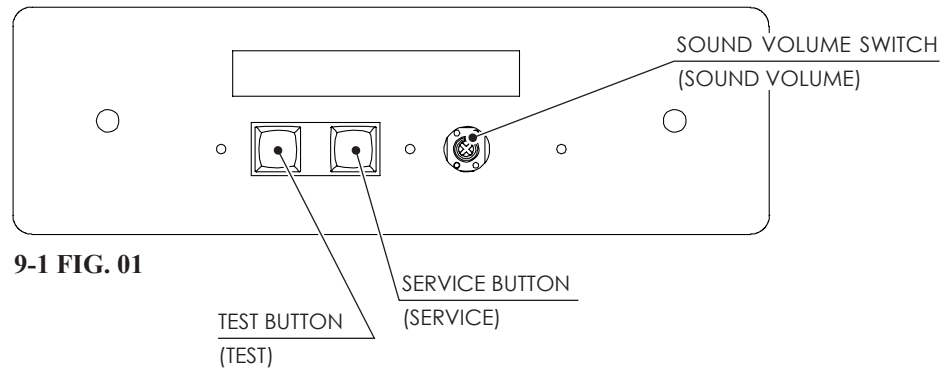

TEST Button (TEST)	Establishes Test Mode. Becomes the button to confirm selections in Test Mode.
SERVICE Button (SERVICE)	Makes it possible to enter credits for service without increasing the coin meter. Becomes the button to select items in Test Mode.
Sound Volume Switch (SOUND VOLUME)	This is the volume knob for speakers at the left and right of the control panel. Turn the knob to the right to increase speaker volume.

### Coin Meter

After using a special-purpose key to unlock the cashbox door, the coin meter can be found at the bottom of the cashbox.



COIN METER

9-1 FIG. 02

## 7-2 SYSTEM TEST MODE

### STOP IMPORTANT

- The details of changes to Test Mode settings are saved when you exit from Test Mode by selecting EXIT from the system Test Mode menu. Be careful because if the power is turned off before that point, changes to the settings will be lost.
- Use with the specified settings. If settings other than those specified are used, inappropriate operations or malfunction may occur.
- Go to BOOKKEEPING in GAME TEST MODE to access this product's data.
- Read the LINDBERGH RED EX service manual that comes with the product for details on the System Test Mode. However, you should perform the settings for this product according to the manual you are reading.

In the System Test Mode, the main activities include checking LINDBERGH RED EX information and actions and the setting of coin/credit. Also, a screen appears for checking screen adjustments. For details, see the LINDBERGH RED EX service manual, which is provided with the product.

Use the following settings with this product. If the settings are not as specified, error messages might appear and operations might not be normal.

*NOTE: If you proceed to the game screen using different settings, you will get an "Error 200" message on the screen. If that happens, go back to the SYSTEM TEST MENU and change the settings to the following:*

#### COIN ASSIGNMENTS

COIN CHUTE TYPE	COMMON
SERVICE TYPE	COMMON

- 1 When the TEST Button is pressed, the System Test Menu Screen (SYSTEM TEST MENU) appears.

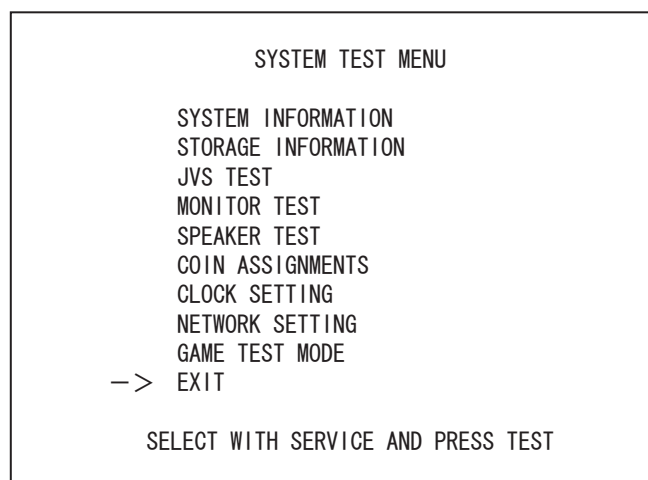

9-2 FIG. 01 System Test Menu Screen

- 
- 2** Use the SERVICE Button to move the cursor to the desired test item.

---

  - 3** Press the TEST Button to confirm selection of the item.

---

  - 4** When testing and checking are completed, select EXIT and press the TEST Button. The System Test Menu Screen reappears.

---

  - 5** When all tests are completed, select EXIT and press the TEST Button. The Game Screen reappears.

## 7-3 GAME TEST MODE

### STOP IMPORTANT

- To change settings in the Game Test Mode, simply making changes on the setting screen will not be effective. Complete the Test Mode in normal fashion.
- Use with the specified settings. If settings other than those specified are used, inappropriate operations or malfunction may occur.

### 7-3-1 GAME TEST MODE

- 1 Select GAME TEST MODE from the System Test Menu Screen to display the Game Test Mode Screen as follows.

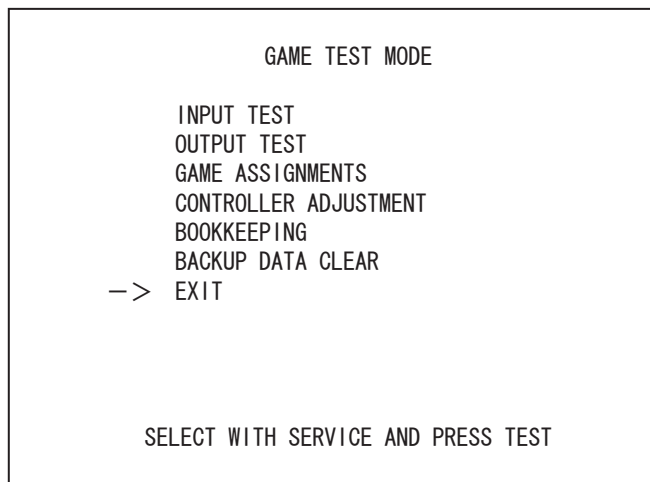

9-3-1 FIG. 01

- 2 For each following item, a test or setting is implemented, or data is displayed.

INPUT TEST	Tests each input device used for game.
OUTPUT TEST	Tests each output device used for game.
GAME ASSIGNMENTS	Adjusts all game settings.
CONTROLLER ADJUSTMENT	Adjusts aim settings for Control Unit (Gun).
BOOKKEEPING	Displays all recorded game data.
BACKUP DATA CLEAR	Erases all types of game records.

- 3 Press the SERVICE Button and move the cursor to select an item.

- 4 Press the TEST Button to execute the item. The test or setting screen of the selected item appears.

- 
- 5** The test or setting adjustment, etc., is performed.
- 
- 6** When testing or setting adjustment, etc. is completed, select EXIT and press the TEST Button, etc. to have the GAME TEST MODE screen reappear.
- 
- 7** On the GAME TEST MODE screen, select EXIT and press the TEST Button. The SYSTEM TEST MENU screen reappears.
- 
- 8** On the SYSTEM TEST MENU screen, select EXIT and press the TEST Button. The game screen reappears.

### 7-3-2 INPUT TEST

Select INPUT TEST to display the following screen and check the status of input devices. This test should be used periodically to check that each input device is functioning correctly.

- 1 On the GAME TEST MODE screen, select INPUT TEST and press the TEST Button. The INPUT TEST screen appears.

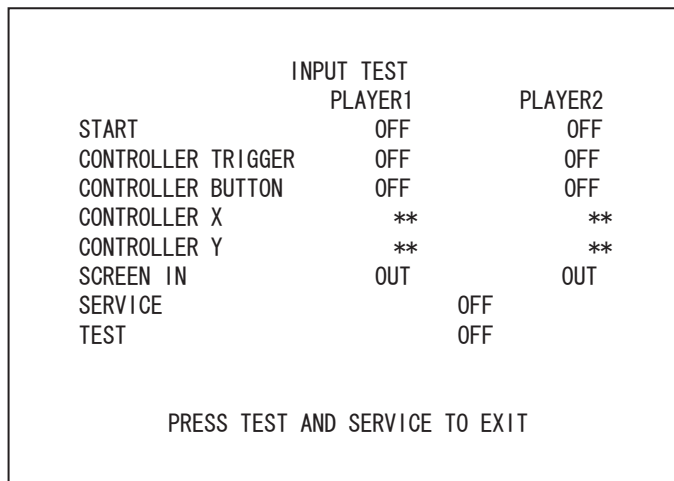

9-3-2 FIG. 01

- 2 Manipulate each switch, etc., to check screen display.

START	This will say ON when the START buttons are being pressed and OFF when they are released.
CONTROLLER TRIGGER	This will say ON when the triggers on the controllers are being pulled and OFF when they are released.
CONTROLLER BUTTON	This will say ON when the buttons on the controllers are being pressed and OFF when they are released.
CONTROLLER X	This shows the aim location for the X direction on the controllers.
CONTROLLER Y	This shows the aim location for the Y direction on the controllers.
SCREEN IN	This will say IN when the controllers are aimed inside the screen and OUT when they are aimed outside the screen.
SERVICE	This will say ON when the SERVICE button is being pressed and OFF when it is released.
TEST	This will say ON when the TEST button is being pressed and OFF when it is released.

- 3 When all checks are completed, press the TEST Button and the SERVICE Button simultaneously. The GAME TEST MODE screen reappears.

### 7-3-3 OUTPUT TEST

This screen is for confirming the proper operation of each output device used by the game. Periodically use this screen to check the status of each output device.

- 1 On the GAME TEST MODE screen, select OUTPUT TEST and press the TEST Button. The OUTPUT TEST screen appears.

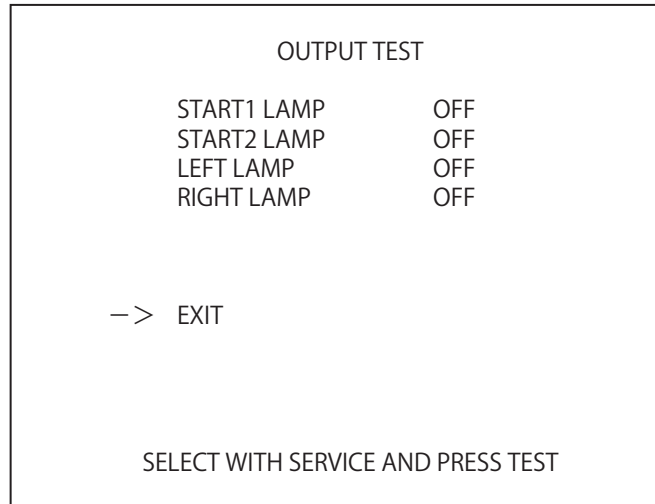

9-3-3 FIG. 01

- 2 Press the SERVICE Button and move the cursor to select the item (output device).



### 7-3-4 GAME ASSIGNMENTS

All settings such as level of game difficulty are adjusted.

Setting changes do not become effective until EXIT has been selected on the GAME TEST MODE screen. After a setting has been changed, be sure to always exit the GAME TEST MODE.

- 1 On the GAME TEST MODE screen, select GAME ASSIGNMENTS and press the TEST Button. The GAME ASSIGNMENTS screen appears.

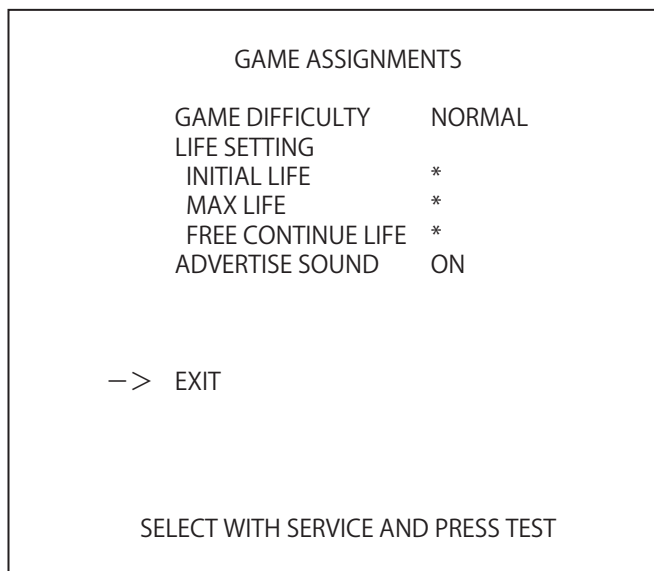

9-3-4 FIG. 01

- 2 Press the SERVICE Button and move the cursor to select an item.
- 3 When the TEST Button is pressed, the display to the item's right changes and the setting, itself, changes.

GAME DIFFICULTY		Set the level of difficulty to one of five levels; VERY EASY -> MEDIUM EASY ->NORMAL -> MEDIUM HARD -> VERY HARD.
LIFE SETTING	INITIAL LIFE	The number of LIFE(s) the player will start the game with. Can be set between 1 and 9. However, cannot be set higher than the MAX LIFE setting.
	MAX LIFE	The maximum number of LIFE(s) a player may have. Can be set between 1 and 9.
	FREE CONTINUE LIFE	The number of LIFE(s) the player will have to CONTINUE. Can be set between 0 and 4. The total value for INITIAL LIFE and FREE CONTINUE LIFE cannot exceed the MAX LIFE setting.
ADVERTISE SOUND		Set the sound level for the advertisements to one of five levels: "ON"-> "7/10"->"5/10"->"3/10"->"OFF". The closer you get to OFF, the lower the volume.

- 4 When all setting adjustments are completed, select EXIT and press the TEST Button. The GAME TEST MODE screen reappears.

### 7-3-5 CONTROLLER ADJUSTMENT

This screen allows for the adjustment of the controller's crosshair settings which are used during game play.

- 1 On the GAME TEST MODE screen, select CONTROLLER ADJUSTMENT and press the TEST Button. The CONTROLLER ADJUSTMENT screen appears.

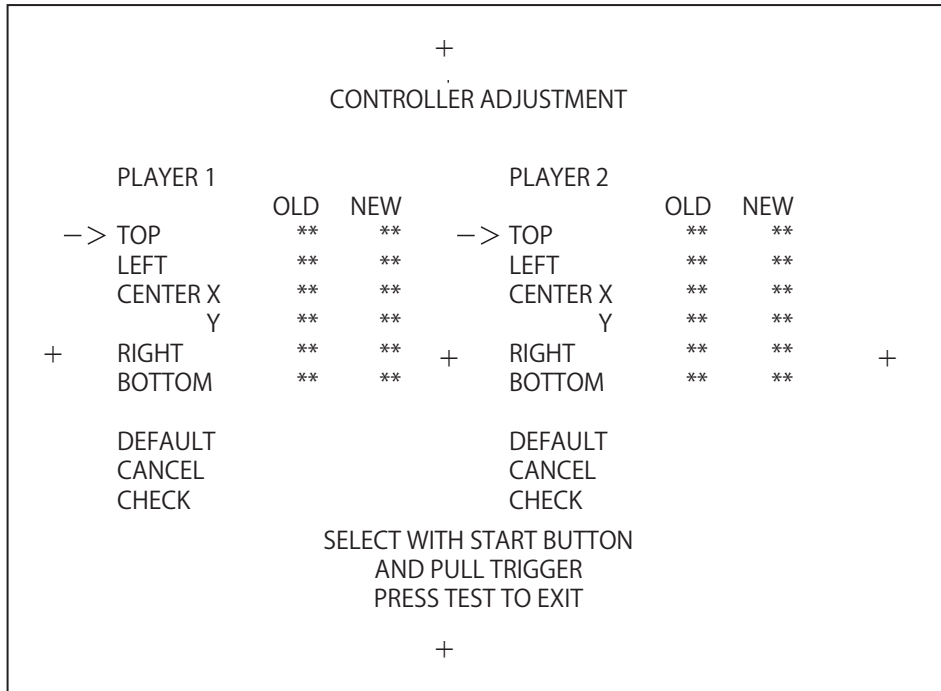

9-3-5 FIG. 01

- 2 Press each player's START button and move the cursor to select an item, then press the TEST Button to test the item.

- 3 Each item is explained below.

TOP	Sets the top correction value for the up and down direction.
LEFT	Sets the left side correction value for the left and right direction.
CENTER	Sets the center correction value. CENTER X is for the left and right direction, and CENTER Y is for the up and down direction.
RIGHT	Sets the right side correction value for the left and right direction.
BOTTOM	Sets the bottom correction value for the up and down direction.
DEFAULT	Sets the value for the player detection position to the default setting.
CANCEL	Returns the values to the previous settings.
CHECK	Checks the detection position.

- 4 When all setting adjustments are completed, select EXIT and press the TEST Button. The GAME TEST MODE screen reappears.

## How to Aim

- 1 Align the top of the groove on the controller's rear sight with the horizontal line of the plus sign on the screen.
- 2 Align the top of the controller's front sight with the horizontal line as well.
- 3 Pull the trigger when the top of the rear sight and top of the front sight line up with the center of the plus sign on the screen.

## EXPLANATION OF TOP, LEFT, CENTER, RIGHT and BOTTOM

These are used to correct the aim position of the controllers.

- 1 Select TOP, LEFT, CENTER, RIGHT or BOTTOM on the CONTROLLER ADJUSTMENT screen to correct the detection position.

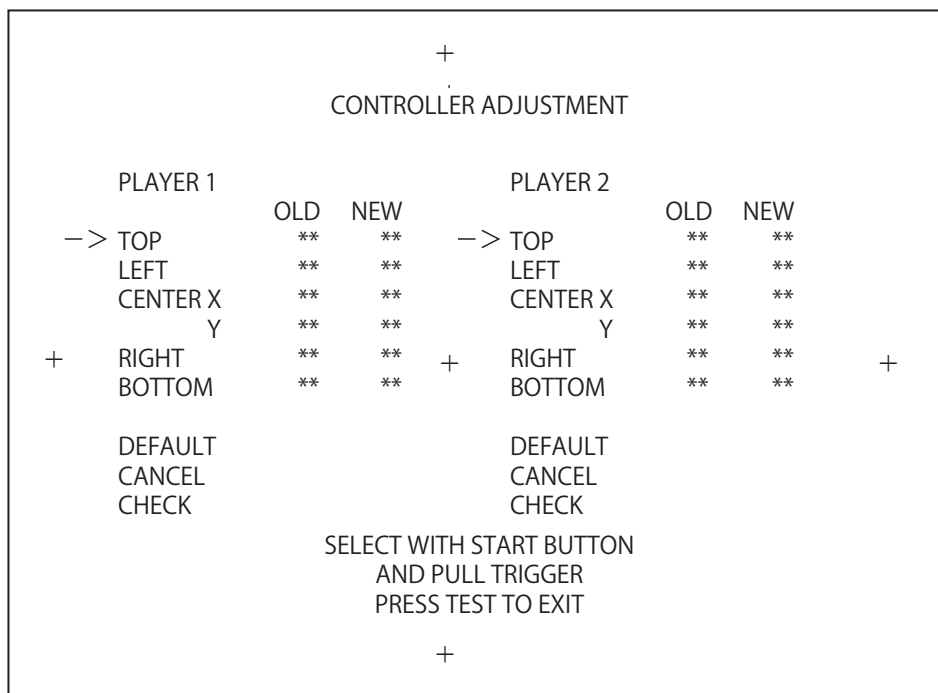

9-3-5 FIG. 02

**2** The adjustment method is explained below.

TOP adjustment	Select TOP, aim at the top mark, and pull the trigger. The new value will appear in the NEW column. The previous value will be shown in the OLD column.
LEFT adjustment	Select LEFT, aim at the left side mark, and pull the trigger. The new value will appear in the NEW column. The previous value will be shown in the OLD column.
CENTER adjustment	Select CENTER, aim at the center mark, and pull the trigger. The new values for X and Y will appear in the NEW column. The previous X and Y values will be shown in the OLD column.
RIGHT adjustment	Select RIGHT, aim at the right side mark, and pull the trigger. The new value will appear in the NEW column. The previous value will be shown in the OLD column.
BOTTOM adjustment	Select BOTTOM, aim at the bottom mark, and pull the trigger. The new value will appear in the NEW column. The previous value will be shown in the OLD column.

**3** Use the CHECK option to check the detection position.

**4** When all checks are completed, press the TEST Button. The GAME TEST MODE screen reappears after saving the setting data.

## EXPLANATION OF DEFAULT

Sets the value for the player detection position to the default.

- 1 Pull the trigger on the controller after selecting DEFAULT on the CONTROLLER ADJUSTMENT screen to set the detection position to the default settings.

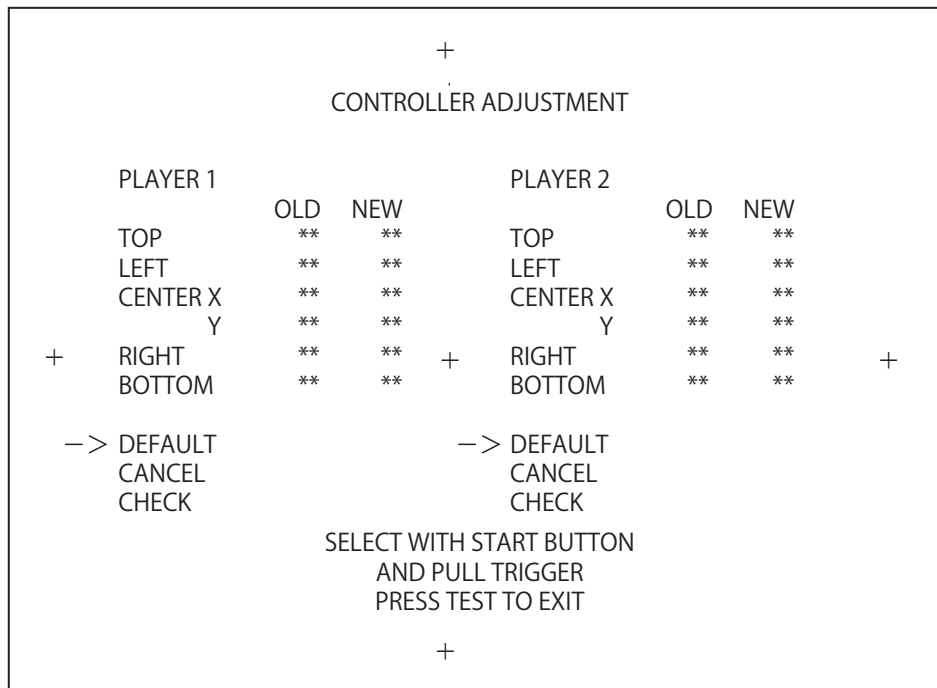

9-3-5 FIG. 03

- 2 Use the CHECK option to check the detection position.
- 3 When all checks are completed, press the TEST Button. The GAME TEST MODE screen reappears after saving the setting data.

## EXPLANATION OF CHECK

Checks the detection position of the controller.

- 1 Select CHECK on the CONTROLLER ADJUSTMENT screen to check the detection position.

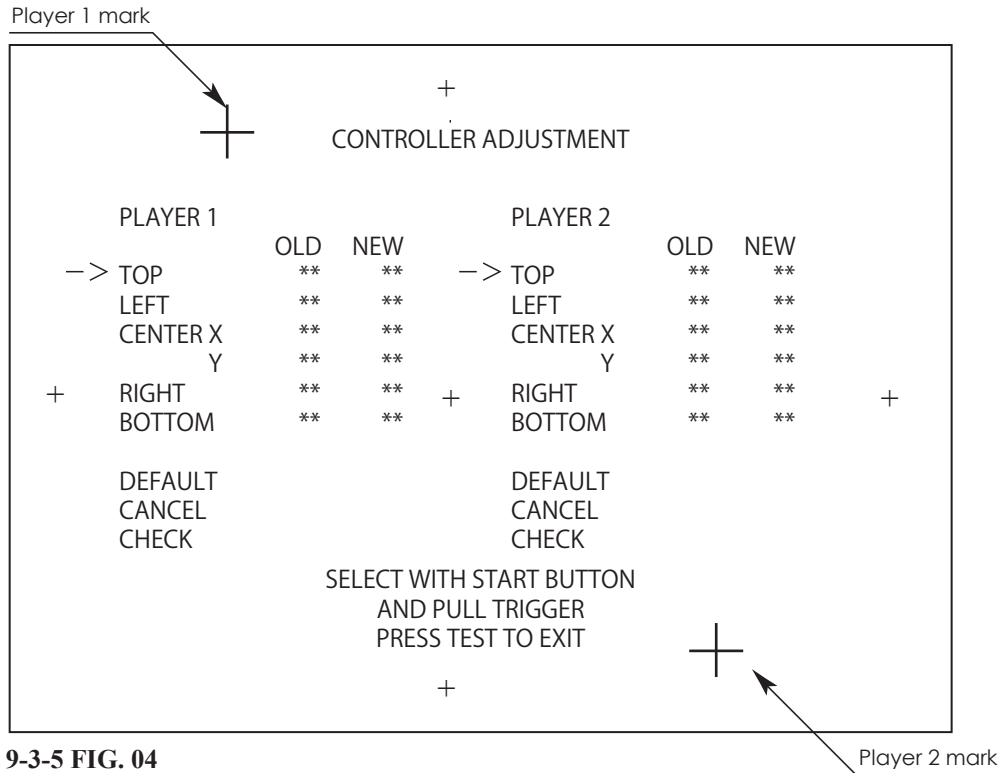

9-3-5 FIG. 04

PLAYER 1 Gun Mark	This is displayed when the controller is pointed at the screen.
PLAYER 2 Gun Mark	This is displayed when the controller is pointed at the screen.

- 2 If you point the controller at the screen, the gun mark (crosshairs) for each of the players will be shown on the screen. Use this screen to check whether or not the detection position is correct.
- 3 When all checks are completed, press the TEST Button. The GAME TEST MODE screen reappears.

### 7-3-6 BOOKKEEPING

Each game record can be viewed.

The BOOKKEEPING screen is comprised of 3 pages. The next page appears each time the TEST Button is pressed. If the TEST Button is pressed while the third page is being shown, the GAME TEST MODE screen reappears.

- 1 On the GAME TEST MODE screen, select BOOKKEEPING and press the TEST Button. The BOOKKEEPING PAGE 1/3 screen appears.

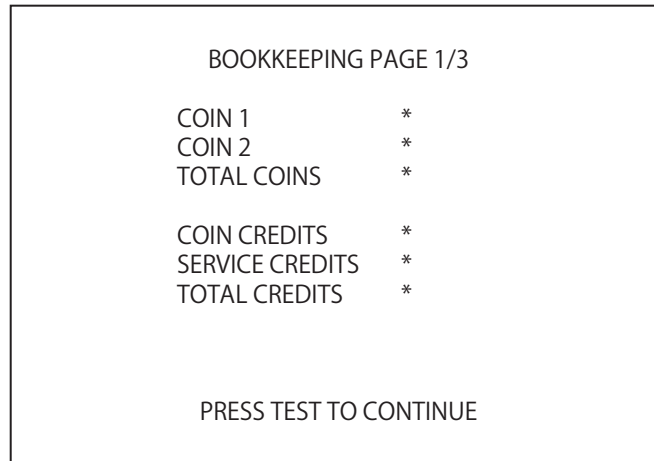

9-3-6 FIG. 01

- 2 Each item is explained below.

COIN 1	Number of coins inserted in coin chute 1.
COIN 2	Number of coins inserted in coin chute 2.
TOTAL COINS	Total number of coins inserted in all coin chutes.
COIN CREDITS	Number of credits for coins inserted.
SERVICE CREDITS	Number of credits entered with the SERVICE Button.
TOTAL CREDITS	Total number of all credits.

**3**

Press the TEST button on BOOKKEEPING PAGE 1/3 to move to BOOKKEEPING PAGE 2/3.

```

          BOOKKEEPING PAGE 2/3

NUMBER OF GAMES          *
  FIRST PLAY              *
  CONTINUE PLAY          *
TOTAL TIME               ****D **H **M **S
PLAY TIME                 ****D **H **M **S
AVERAGE PLAY TIME       **M **S
LONGEST PLAY TIME        **M **S
SHORTEST PLAY TIME      **M **S

          PRESS TEST TO CONTINUE

```

**9-3-6 FIG. 02****4**

Each item is explained below.

NUMBER OF GAMES	Total number of games played by Player 1 and Player 2.
FIRST PLAY	Total number of first time plays by Player 1 and Player 2.
CONTINUE PLAY	Total number of times Player 1 and Player 2 opted to continue.
TOTAL TIME	Amount of time the cabinet has been in operation. (Does not count TEST MODE.)
PLAY TIME	Amount of time game has been played.
AVERAGE PLAY TIME	Average play time for one game.
LONGEST PLAY TIME	Longest play time for one game.
SHORTEST PLAY TIME	Shortest play time for one game.



**5** Press the TEST button on BOOKKEEPING PAGE 2/3 to move to BOOKKEEPING PAGE 3/3. The GAME HISTOGRAM displays how many times a play ended at a certain time on that cabinet. Use this as a reference when determining settings such as difficulty level.

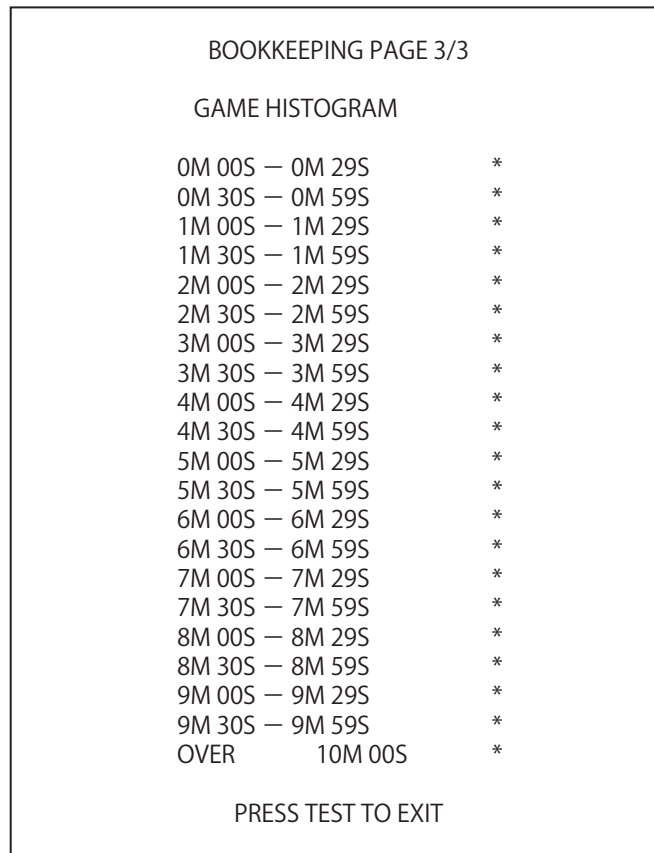

9-3-6 FIG. 03

**6** This displays play times on a scale from 0M00S to 9M59S based on 30-second intervals. All play times 10 minutes or over are included in the item OVER 10M00S.

**7** Press the TEST Button to return to the GAME TEST MODE Screen.

### 7-3-7 BACKUP DATA CLEAR

This deletes the various game data (ranking data, BOOKKEEPING data from GAME TEST MODE, and remaining credits).

- 1 On the GAME TEST MODE screen, select BACKUP DATA CLEAR and press the TEST Button. The BACKUP DATA CLEAR screen appears.

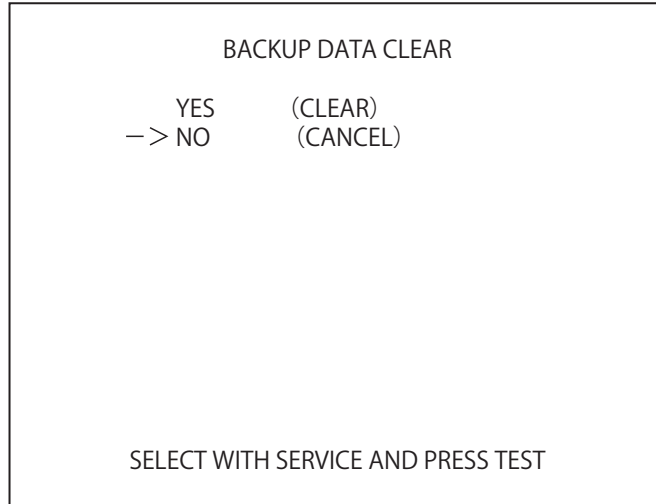

9-3-7 FIG. 01

- 2 Select item to either clear data or to cancel the function, and then confirm with the TEST Button.

YES (CLEAR)	All game records are cleared. After clearing, "COMPLETED" is displayed.
NO (CANCEL)	All game records are not cleared.

- 3 When YES (CLEAR) has been selected and the TEST Button pressed, all data is cleared. Then "COMPLETED" is displayed and press the TEST Button to return to the GAME TEST MODE screen.

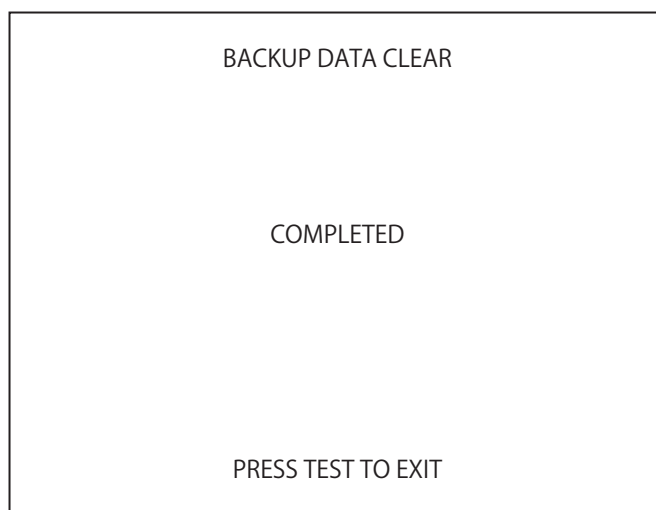

9-3-7 FIG. 02

- 4 Move the cursor to NO (CANCEL) and press the TEST Button to return to the GAME TEST MODE screen without clearing the data.

## 8 COIN SELECTOR

### 8-1 Cleaning the Coin Selector

#### STOP IMPORTANT

- Remove and clean smears using a soft cloth dipped in water or diluted chemical detergent which is then wrung dry.
- Never apply machine oil, etc. to the coin selector.
- After cleaning the coin selector, properly insert a standard coin to ensure that the selector functions correctly.

The coin selector should be cleaned once per month. When cleaning, follow the procedures below:

- 1 Turn the power off. Open coin chute door.
- 2 Open gate and wipe away dirt with animal hairbrush or other soft brush.

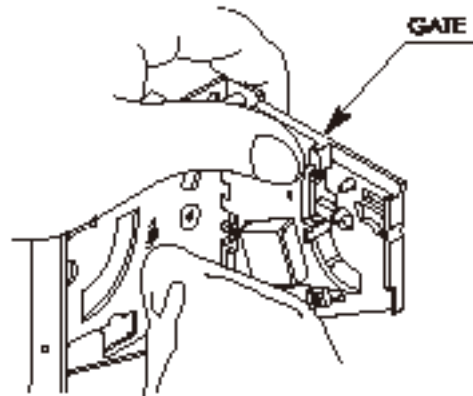

13-1 FIG. 01

- 3 Soak a soft cloth in water or in a neutral cleaning agent diluted with water, wring it tightly and wipe away dirt.

- 4** Remove cradle.  
When removing the retaining ring (E ring), be careful not to bend the rotary shaft.

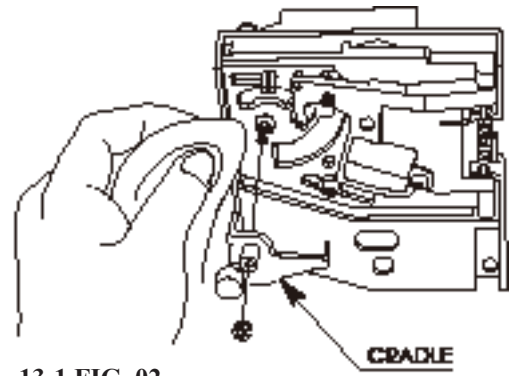

13-1 FIG. 02

- 5** Use soft cloth to wipe dirt from rotary shaft and bearing.
- 6** After wiping off dirt, wipe away moisture with a dry cloth and make sure that the coin selector is completely dry.

## 8-2 Removing a Jammed Coin

When the REJECT button fails to refund coins, open the coin chute door and open the selector gate. Once the jammed coin is removed, insert a standard coin to ensure that the selector is working properly.

## 8-3 Coin Insertion Test

Carry out a coin insertion test once per month. At the same time, check the following points:

- Does the coin meter count properly?
- Do coins drop into the cashbox correctly?
- Are coins rejected when inserted while holding down the REJECT button?
- Are extra coins and incorrect coins properly returned?

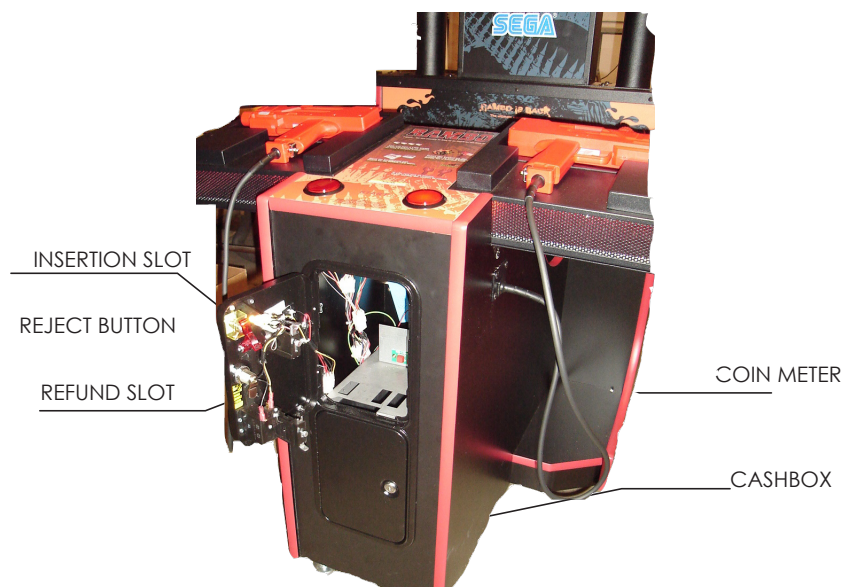

13-3 FIG. 01

## 9 PERIODIC INSPECTION

The items listed below require periodic check and maintenance to retain the performance of this machine and to ensure safe business operation.

Players operate the control unit by touching it and holding it with their hands. Clean the control unit on a regular basis and have hand wipes, etc. available to ensure that players will always fully enjoy the game.

### WARNING

- Be sure to check once a year to see whether power cords are damaged, the plug is securely inserted, dust has accumulated between the socket outlet and the power plug, etc. Using the product with accumulated dust can cause fire and electric shock.
- Never use a water jet, etc. to clean inside and outside the cabinet. If the machine gets wet for any reason, do not use it until it has completely dried.
- Periodically, around once a year, get in touch with the place of contact herein stated or the distributor, etc. where the product was purchased from, regarding internal cleaning. Using the product with accumulated dust in the interior can cause a fire or accident. Note that professional cleaning will require a fee.
- There is the danger of accidents involving electrical shorts circuits or fire caused by factors such as the deterioration of insulation in electrical and electronic equipment over time. Check that there are no abnormalities such as odors from burning.

15 TABLE 01

ITEMS	DESCRIPTION	PERIOD	REFERENCE
CABINET	Confirm that adjusters contact floor	Daily	3
CONTROL UNIT	Cleaning	As appropriate	—
	Aim test	Weekly	7-3
	Microswitch test	Monthly	-
COIN SELECTOR	Coin switch inspection	Monthly	8
	Coin insertion test	Monthly	8
	Cleaning	Monthly	8
DLP projector	Screen cleaning	Weekly	-
	Check screen adjustment	Monthly or when moving	-
LINDBERGH RED EX	Memory test	Monthly	-
	Settings check	Monthly	-
	Cleaning	Every 3 months	11-2
POWER CABLE	Inspection, Cleaning	1 year	-
CABINET INTERIOR	Cleaning	1 year	As above
CABINET SURFACES	Cleaning	As appropriate	See next page

## Cleaning the Cabinet Surfaces

When the cabinet surfaces become dirty, remove stains with a soft cloth soaked in water or diluted (with water) chemical detergent and then wrung dry. To avoid damaging the finish, do not use such solvents as thinner, benzene, etc. (other than ethyl alcohol) or abrasives (bleaching agent and chemical dust-cloth).

Some general-purpose household, kitchen, and furniture cleaning products may contain strong solvents that degrade plastic parts, coatings, and print. Before using any cleaning product, read the product's cautionary notes carefully and test the product first on a small area that is not highly visible.

# 10 TROUBLESHOOTING

## 10-1 TROUBLESHOOTING TABLE

**⚠ WARNING**

- The work described below should be carried out by the site maintenance personnel or other qualified professional. Work carried out by personnel without the necessary skill or technology can cause accident.
- If no improvements can be noted even after the following measures have been taken, disengage the power and contact the point of purchase or the office indicated in these instructions. If the power is left on while there is an abnormality, a fire, electric shock or other serious accident can occur.
- When working with the product, be sure to turn the power off. Working with the power on may cause an electric shock or short circuit.
- Be careful not to damage the wires. Damaged wires may cause an electric shock, short circuit or present a risk of fire.
- Once the reason that the breaker or circuit protector activated has been removed, restore the breaker or circuit protector to its original condition. If the product is used while the reason for activation has not yet been removed, heat and/or fire could be generated.

If a problem occurs, first inspect the connection of any wiring connectors.

16-1 TABLE 01

PROBLEMS	CAUSE	COUNTERMEASURES
With main switch ON, no activation.	Power is not supplied.	Securely insert the power plug into the plug socket.
	Power supply/voltage is not correct.	Make sure that power supply/voltage is correct.
	The circuit protector functioned due to the momentary overload.	After eliminating the cause of overload, reinstate the AC unit's circuit protector. <See 6-9, see below>
No sound is generated from the speaker.	Faulty adjustment of sound volume.	Adjust the sound volume. <See 9-1>
	Board and Amplifier malfunctioning.	Perform the sound test and confirm. <See LINDBERGH RED EX Service Manual, 4>
The color on the DLP projector screen is incorrect.	Faulty screen adjustment.	Perform appropriate adjustments. <See 6-11>

PROBLEMS	CAUSE	COUNTERMEASURES
The Control Unit (Gun) sighting is not satisfactory.	Sights are not aligned due to changes in the surrounding environment.	Perform sighting adjustment in the test mode. <See 6-11>
	LED board malfunctioning.	Check to ensure that the LED lights up. If it does not light up, replace. <See 16-2>
	Sensor unit malfunctioning.	Replace the sensor unit. <See 12-3>
	LED board and LED board cover are contaminated.	Wipe off soiled surfaces.
	Sensor interference caused by another like machine.	Make sure that the interference prevention wire is attached properly. <See 6-11>
	Malfunction caused by ambient lighting.	Change product installation location if strong lighting is positioned near the monitor.
The Control Unit (Gun) does not appear to be operating correctly.	A fault with the microswitches.	Use an Input Test to make sure they change between ON and OFF. If they do not, exchange the faulty microswitches. <See 12-2>
	A fault with the LED board.	Check that the LEDs are on. If not, exchange them. <See 16-2>
	The sensor unit is broken.	Exchange the sensor unit. <See 12-3>
Fluorescent lamp does not illuminate.	Lamp life expired.	Replace lamp/glow lamp. <See chapter 14>

**CIRCUIT PROTECTOR**

Functions due to the activation of bimetal. To restore the function, wait for approximately 1 minute or longer until the bimetal cools off. (Press the button.)

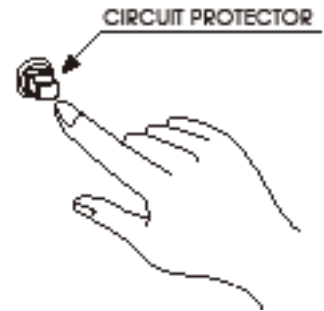

16-1 FIG. 01



## 11 GAME BOARD (LINDBERGH RED EX)

### WARNING

- The work described below should be carried out by the site maintenance personnel or other qualified professional. Work carried out by personnel without the necessary skill or technology can cause accident.
- In order to prevent electric shock and short circuit hazards, be sure to turn power off before performing work.
- Be careful not to damage the wires. Damaged wires may cause electric shock or short circuit or present a fire risk.
- Do not use this product with connectors other than those that were connected and used with the LINDBERGH RED EX at the time of shipping. Do not carelessly connect wires to connectors that were not used at the time of shipping, as this may cause overheating, smoke or fire damage.
- When connecting the connectors, be sure to attach them correctly. There is only one correct way in which they must be connected. Attempting to connect them incorrectly may cause damage to the pins on the connectors, and cause electric shock, short circuit or fire.

### CAUTION

In this product, setting changes are made during the Test Mode. The LINDBERGH RED EX need not be operated. Use the LINDBERGH RED EX, etc. as is with the same setting made at the time of shipment so as not to cause electric shock and malfunctioning.

### IMPORTANT

Static electricity from your body may damage some electronics devices on the IC board. Before handling the IC board, touch a grounded metallic surface so that the static electricity can be discharged.

## 11-1 REMOVING THE LINDBERGH RED EX

The LINDBERGH RED EX is inside the front door of the cabinet on the left side when facing the screen. Remove the entire wooden board (ASSY MAIN BD) on which the LINDBURGH RED EX is placed.

- 1 Turn the power off.
- 2 Unlock the back door with the master key, and take it off.

17-1 FIG. 01

17-1 FIG. 02

- 3 Release the cord clamps.

CORD CLAMP

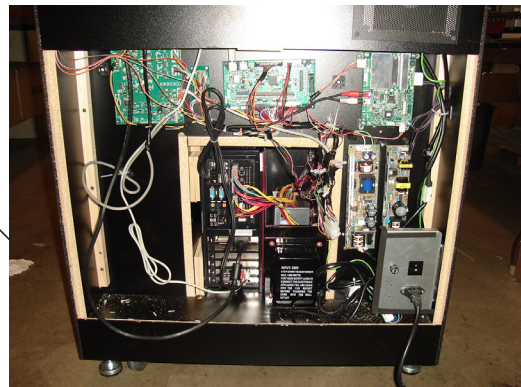

- 4 Detach the 5 connectors.

Detach connectors  
D-SUB15P,  
JVS CONNECTORS

Detach connectors  
SM4P, SM8P, YL3P

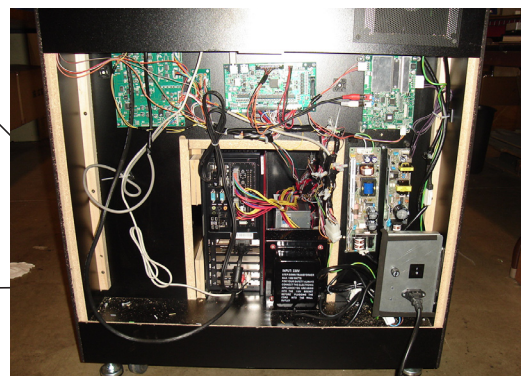

17-1 FIG. 04

**5** Pull lindbergh from the base. Make sure you do not damage the wires when doing so.

**6** Place the base on a flat surface.

**7** Release the cord clamps and detach the 4 connectors.

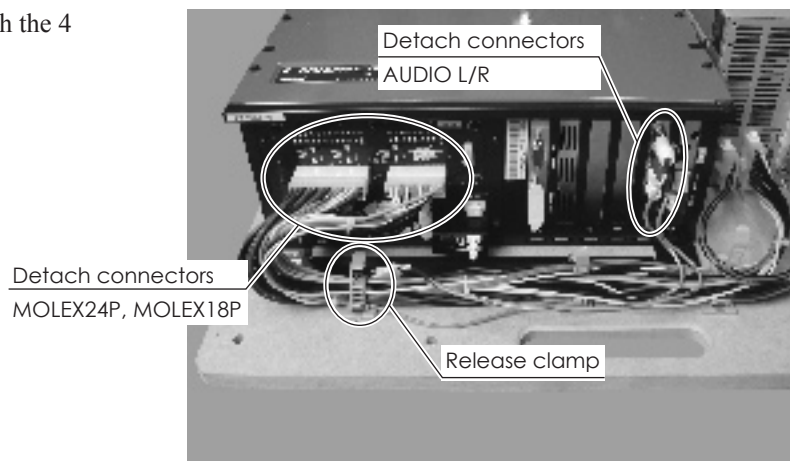

17-1 FIG. 07

**8** Remove the 4 screws and remove the LINDBERGH RED EX.

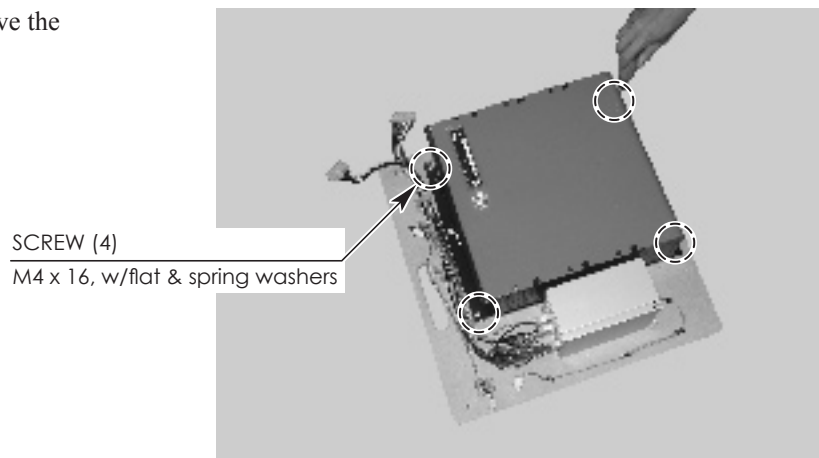

17-1 FIG. 08

## 11-2 CLEANING THE LINDBERGH RED EX

### **STOP** IMPORTANT

Be sure to clean the LINDBERGH RED EX once in 3 months. Dust accumulating in game boards may not function properly.

Take the LINDBERGH RED EX out of the cabinet to vacuum around its air vents and around the mounting once every 3 months.

**1** Refer to 17-1, and remove the LINDBERGH RED EX from the cabinet.

**2** Clean around the air vent of the LINDBERGH RED EX with a vacuum cleaner.

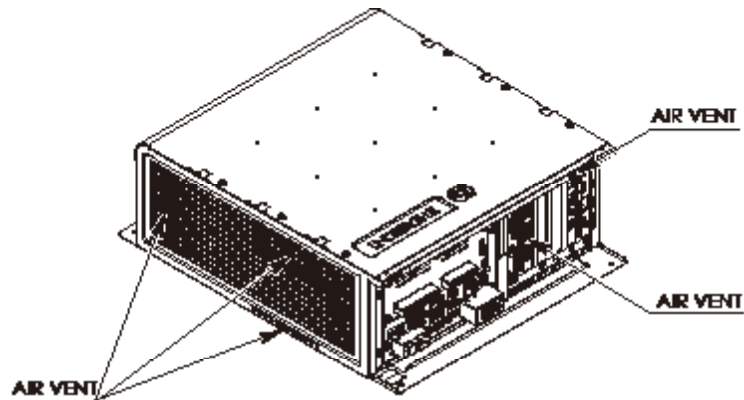

17-2 FIG. 01

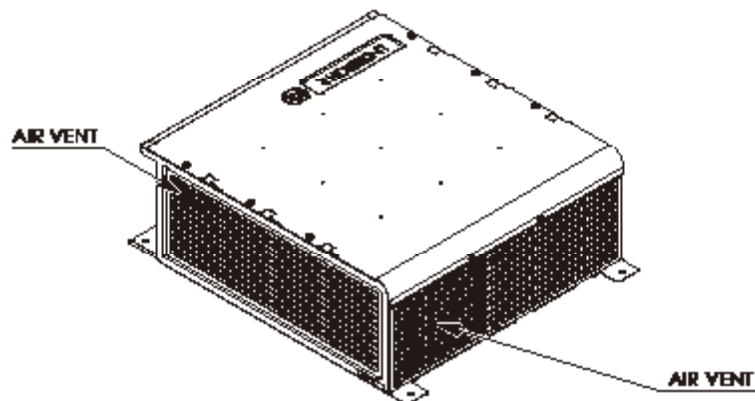

17-2 FIG. 02

**3** Clean around installment parts of the LINDBERGH RED EX in the cabinet with a vacuum cleaner. Be sure not to damage wirings and boards. Electronic devices on boards may damage by static electricity, and be sure not to vacuum electronic devices by a vacuum cleaner.

**4** Set the LINDBERGH RED EX you removed by the reverse method.

## 11-3 COMPOSITION OF THE LINDBERGH RED EX

STOP

### IMPORTANT

- The LINDBERGH RED EX becomes the LINDBERGH RED EX for this product once the key chip is inserted.
- The DIP SW (dip switches) on the LINDBERGH RED EX must be set as specified below. If set incorrectly for this product, an error will be displayed and the game will not run.

ASSY CASE LBJ L 1GB RMB EXP (845-0011D-02)

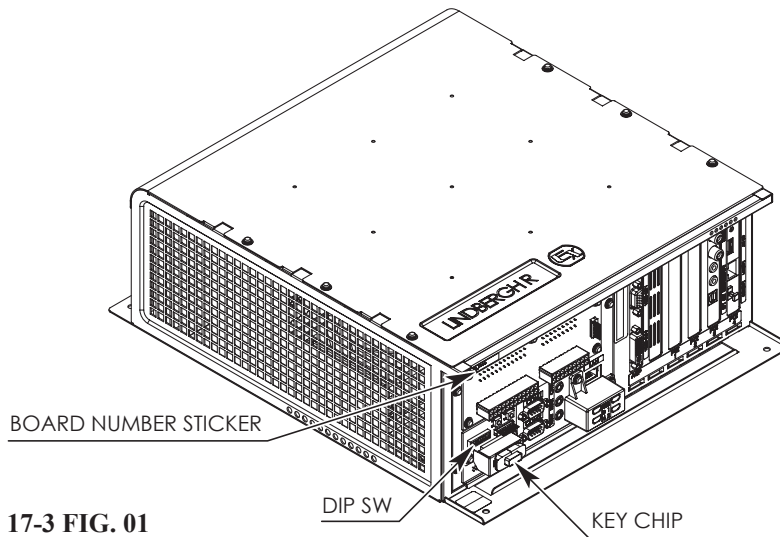

17-3 FIG. 01

### DIP SW Setting

Use this product with the DIP SW settings shown in the figure below.

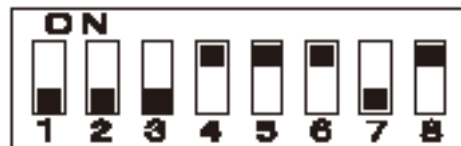

17-3 FIG. 02



## 12 PARTS LIST



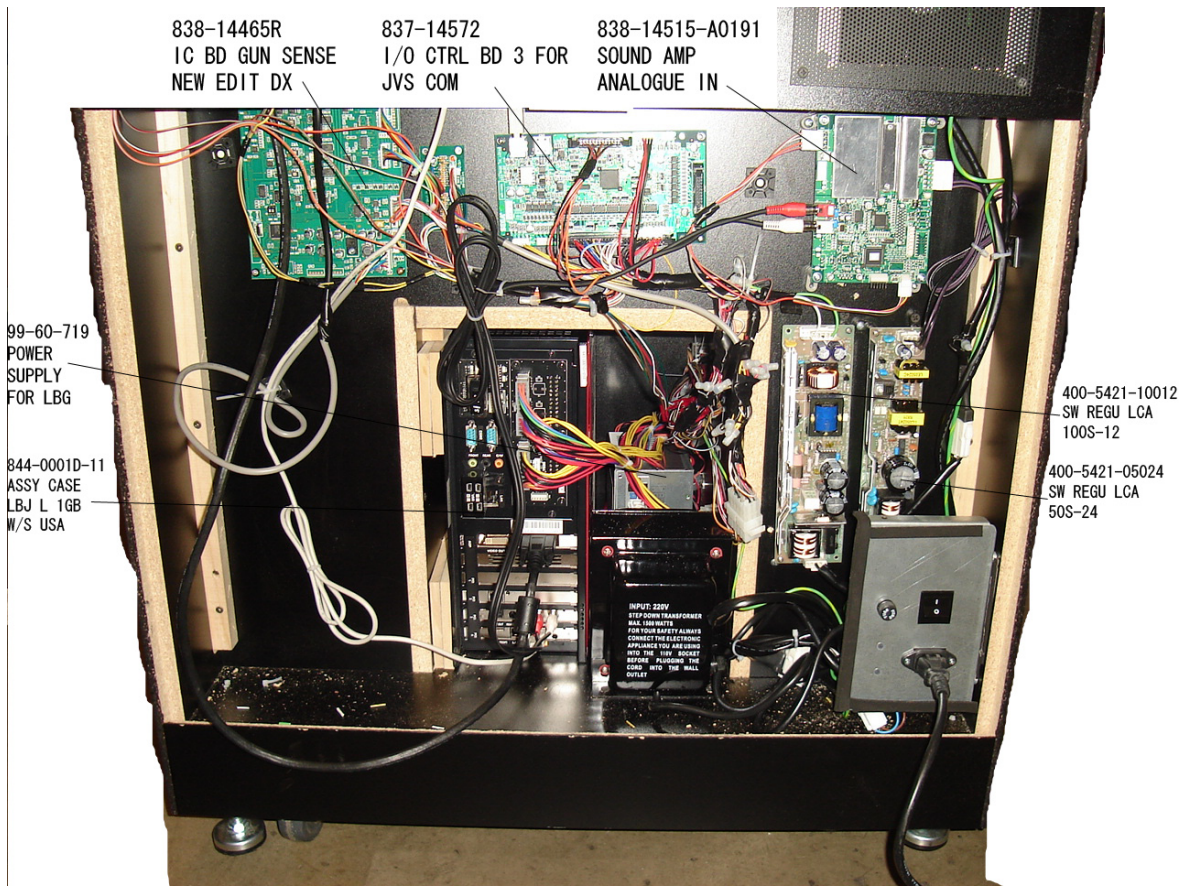

838-14465R  
IC BD GUN SENSE  
NEW EDIT DX

837-14572  
I/O CTRL BD 3 FOR  
JVS COM

838-14515-A0191  
SOUND AMP  
ANALOGUE IN

99-60-719  
POWER  
SUPPLY  
FOR LBG

844-0001D-11  
ASSY CASE  
LBJ L 1GB  
W/S USA

400-5421-10012  
SW REGU LCA  
100S-12

400-5421-05024  
SW REGU LCA  
50S-24

INPUT: 220V  
STEP-DOWN TRANSFORMER  
RMS 100 WATTS  
FOR YOUR SAFETY ALWAYS  
CONNECT THE ELECTRONIC  
APPLIANCE YOU ARE USING  
BETW THE HOLES  
BEFORE PLUGGING THE  
CORD INTO THE WALL  
OUTLET

CONTROL UNIT (HDF-2100)

(D-1/2)

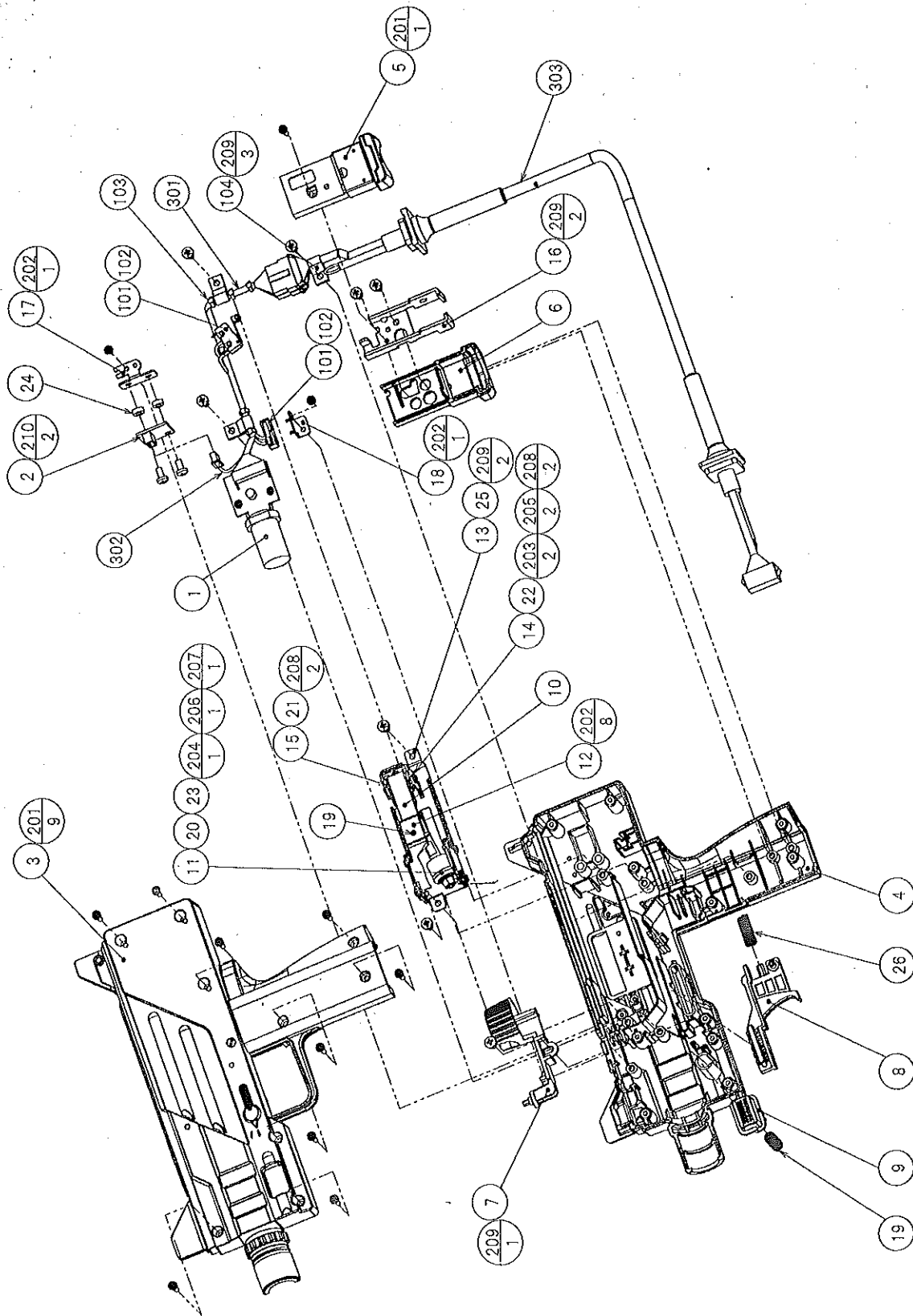



## CONTROL UNIT (HDF-2100)

(D-2/2)

ITEM NO.	PART NO.	DESCRIPTION	NOTE
1	JPT-2030	SENSOR UNIT	
2	839-1280	XY ACCELERATION BD	
3	HDF-2101	COVER L	
4	HDF-2102	COVER R	
5	HDF-2103	GRIPEND L	
6	HDF-2104	GRIPEND R	
7	HDF-2105	BOLT KNOB	
8	HDF-2106	TRIGGER	
9	HDF-2107	BUTTON	
10	HDF-2108	SPRING ARM	
11	HDF-2109	KNOCK ROLLER	
12	HDF-2110	KNOCK FRAME L	
13	HDF-2111	KNOCK FRAME R	
14	HDF-2112	JOINT BASE	
15	HDF-2113	JOINT	
16	HDF-2114	CORD FRAME	
17	HDF-2115	SENSOR BRKT	
18	HDF-2116	SWITCH BRKT	
19	HDF-2117	BUTTON SPRING	
20	HDF-2118	KNOCK SHAFT	
21	HDF-2119	JOINT PIN S	
22	HDF-2120	JOINT PIN L	
23	HDF-2121	KNOCK WEIGHT	
24	HDF-2124	SPACER COLLAR	
25	HDF-2125	MASK SEAL	
26	CTF-2123	TRIGGER SPRING	
101	509-5080	SW MICRO TYPE (SS-5GL2)	
102	310-5029-D20	SUMITUBE F D 20MM	
103	601-0460	PLASTIC TIE BELT 100 MM	
104	280-5124-04	NYLON CLAMP NK04	
201	FAS-000100	M SCR PH W/SMALL FS BLK M3 × 12	
202	FAS-000045	M SCR PH W/S BLK M3 × 6	
203	FAS-000153	M SCR PH W/S M3 × 4	
204	050-H00500	HEX NUT M5	
205	060-F00400	FLT WSHR M4	
206	060-F00500	FLT WSHR M5	
207	060-S00500	SPR WSHR M5	
208	065-E00300	E RING 3MM	
209	FAS-120029	TAP SCR P-TITE PH 4 × 8	
210	000-P00408	M SCR PH M4 × 8	
301	HDF-60036X	WH SENSE BD	
302	HDF-60037	WH XY ACCEL BD	
303	HDF-60038X	WH CONTROLLER	

