

**KAWAI**

DIGITAL DRUM MACHINE

**R-1000**

*Owner's Manual*

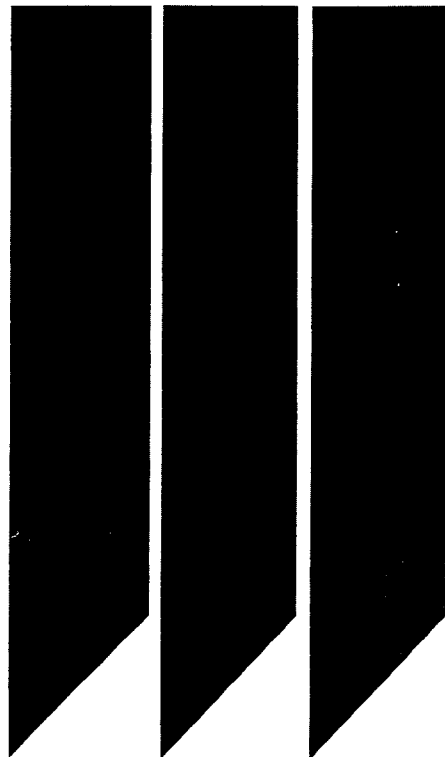

# Introduction

Thank you for purchasing a Kawai R-100 Digital Drum Machine! This Owner's Manual contains valuable information that will help you make full use of this instrument's many capabilities. Read it carefully and keep it handy for future reference.

---

## FEATURES

### ■ Professional Quality PCM Sound Recordings

The R-100's 24 separate drum and percussion sounds have all been recorded in a professional level 12 bit PCM format with a sampling rate of 32 kHz. The sound quality is suitable for any recording situation, even for Compact Disc recording.

### ■ Touch response

Touch response is fast becoming a standard feature for synthesizers. The R-100 now brings the same feature to drum machines, providing volume control over a wide dynamic range — from pp to ff. Each of the 24 sound sources has its own touch sensitivity control for full control over the touch response.

### ■ Programming ease

The sound sources each have their own LEVEL, SENSITIVITY, TUNE, and PAN controls. The parameter settings are displayed in groups of eight voices each as a bar graph on the LCD screen. Pressing the corresponding COMMAND SELECT key changes the value for that particular source and parameter.

### ■ Programmable TUNE and PAN

The R-100 also allows you to vary the TUNE and PAN settings for each note when recording a pattern.

### ■ Variety of line outputs

The R-100 provides eight individual channel outputs as well as stereo or mono outputs.

### ■ Detailed editing functions

Kawai's advanced editing features make the R-100 much more powerful than other drum machine. Such features include a choice of real-time or step recording, PUNCH IN/OUT at the bar level, and REPEAT and JUMP functions for song and chain editing.

### ■ Memory cartridge slot

The RC-16 cartridge (available separately) stores backup copies of all information currently in the R-100's internal memory.

### ■ Full MIDI implementation

The R-100's MIDI implementation not only allows you to do such things as record a pattern from an external keyboard, but also includes such advanced features as Song Position Pointer and system exclusive messages for control of additional R-100's as well as loading and storage of memory to MIDI peripherals.

# Care and Maintenance

---

## Protect your R-100 from:

- Direct sunlight and exposure to the elements
- Temperature and humidity extremes
- Unstable or "noisy" AC power
- Dust and sand
- Vibration during transport

## Power Supply

- Use a supply within the stated voltage limits.
- Make sure that all power switches are off before changing equipment connections.
- Connect the unit as shown on p. 6.

## Cleaning

- Clean the instrument with a soft cloth, a mild detergent, and lukewarm water.
- Never use harsh or abrasive cleansers or organic solvents.

## Helpful Hints

### ■ Battery Backup

The lithium battery protecting the memory contents while the power supply is off is good for more than five years of normal use. We recommend, however, that you have your nearest authorized service representative replace it promptly after five years have passed.

### ■ Line Noise Reset

In the unlikely event of a "lockup" due to line interference, simply turn the R-100 off for a few seconds and then reapply the power.

### ■ Repairs

Always save your valuable internal data to a cassette tape or RC-16 memory cartridge (available separately) before taking your drum machine in for repairs or servicing. Otherwise, it may be lost during testing.

# Table of Contents

Introduction .....	1	7. Editing Patterns .....	29
Care and Maintenance		7.1 REFAME Command .....	29, 30
Table of Contents .....	2, 3	7.2 SWING Command .....	31, 32
1. Controls .....	3	7.3 BAR PUNCH IN/OUT Command – Description .....	33
1.1 Names of Parts .....	4, 5	7.4 BAR PUNCH IN/OUT Command – Example .....	34
1.2 Connections .....	6	7.5 EXCHANGE Command .....	35
1.3 Jacks .....	7	7.6 COPY Command .....	36
2. Overview .....	8	8. Playing Songs and Chains .....	37
2.1 Sound Sources .....	8	8.1 Selecting a Song or Chain for Playback .....	37
2.2 Structuring Rhythm Patterns .....	9	8.2 Specifying the Starting Point .....	37
2.3 Commands .....	9	9. Erasing a Song or Chain .....	38
2.4 Selecting Commands .....	10	9.1 Types of Erasures .....	38
2.5 Entering a Parameter .....	11	9.2 Erasing a Particular Song or Chain .....	38
3. Tempo and MULTI Programming Functions .....	12	9.3 Erasing All Songs or Chains .....	39
3.1 Changing the Tempo (Method 1) .....	12	10. Songs and Chains — General .....	40
3.2 Changing the Tempo (Method 2) .....	13	10.1 BUILD Commands .....	40
3.3 MULTI Programming Functions .....	13	10.2 BUILD — Parameters .....	40
3.4 Accessing the MULTI Programming Functions .....	14, 15	10.3 Example: Building a Song .....	41
3.5 Changing the Parameter Value .....	16	10.4 Example: Editing a Song with BUILD .....	42
3.6 Tempo/Multi Control Availability List .....	16	11. Songs and Chains — Additional Commands .....	43
4. Playing a Rhythm Pattern .....	17	11.1 INSERT Commands .....	43
4.1 Basic Command .....	17	11.2 DELETE Commands .....	44, 45
4.2 Playing the Pattern .....	17	11.3 LEVEL CHANGE Commands .....	46, 47
4.3 Changing the Pattern Number .....	18	11.4 TEMPO CHANGE Commands .....	47, 48
4.4 Changing the Bar Number .....	18	11.5 REPEAT/JUMP Commands — Description .....	49, 50
5. Erasing a Pattern .....	19	11.6 REPEAT/JUMP Commands — Example .....	51, 52
5.1 Types of Erasures .....	19	11.7 COPY Commands .....	52
5.2 Erasing a Pattern .....	19	12. Editing a Song or Chain with the OVERDUB COMMAND .....	53
5.3 Erasing a Particular Instrument .....	20	12.1 OVERDUB Command — Description .....	53
5.4 Erasing One Bar of a Pattern .....	20	12.2 OVERDUB Command — Example .....	54, 55
5.5 Erasing All Data .....	21	12.3 Erasing the OVERDUB Track .....	56
5.6 Checking Available Memory .....	21	13. MIDI Operation .....	57
6. Recording Rhythm Patterns .....	22	13.1 The MIDI Interface .....	57
6.1 Recording Methods .....	22	13.2 Setting the MIDI IN Channel .....	57, 58
6.2 REAL TIME REC. — Parameters .....	22	13.3 Setting the MIDI OUT Channel .....	58, 59
6.3 REAL TIME REC. — Recording .....	23	13.4 MIDI IN and MIDI OUT Commands .....	60
6.4 STEP REC. — Parameters .....	24	13.5 MIDI IN Key Numbers — Description .....	61
6.5 STEP REC. — Recording .....	25	13.6 MIDI IN Key Numbers — Example .....	61, 62
6.6 Using MULTI Programming During Recording .....	26	13.7 MIDI OUT Key Numbers .....	63
6.7 Actual Recordings — Sample I .....	26, 27		
6.8 Actual Recordings — Sample II .....	28		

---

13.8 MIDI OUT Key Numbers (Factory Settings) . . . . .	64
13.9 Sample MIDI Applications . . . . .	65, 66
<b>14. SYNC Command</b> . . . . .	<b>67</b>
14.1 Introduction . . . . .	67
14.2 INT – Internal Clock . . . . .	67
14.3 MIDI SYNC . . . . .	68
14.4 TAPE SYNC . . . . .	69
14.5 CLOCK SYNC . . . . .	70
14.6 DIN SYNC . . . . .	70
14.7 TIMING ADJUST Feature . . . . .	71
<b>15. SYSTEM EXCLUSIVE Commands</b> . . . . .	<b>72</b>
15.1 SYSTEM EXCLUSIVE . . . . .	72
15.2 Remote MULTI Programming . . . . .	73
15.3 MIDI DATA DUMP . . . . .	74
<b>16. ASSIGN Command</b> . . . . .	<b>75</b>
16.1 Introduction . . . . .	75
16.2 ASSIGN OUTPUT . . . . .	76
16.3 TRIG. OUT . . . . .	77
<b>17. Storing Data</b> . . . . .	<b>78</b>
17.1 SAVE/LOAD Command . . . . .	78
17.2 Cartridge . . . . .	79, 80
17.3 Cassette . . . . .	81, 82
<b>18. MIDI Data Format</b> . . . . .	<b>83 ~ 85</b>
<b>19. Specifications</b> . . . . .	<b>86</b>

# 1. Controls

## 1.1 Names of Parts

### ■ Front Panel

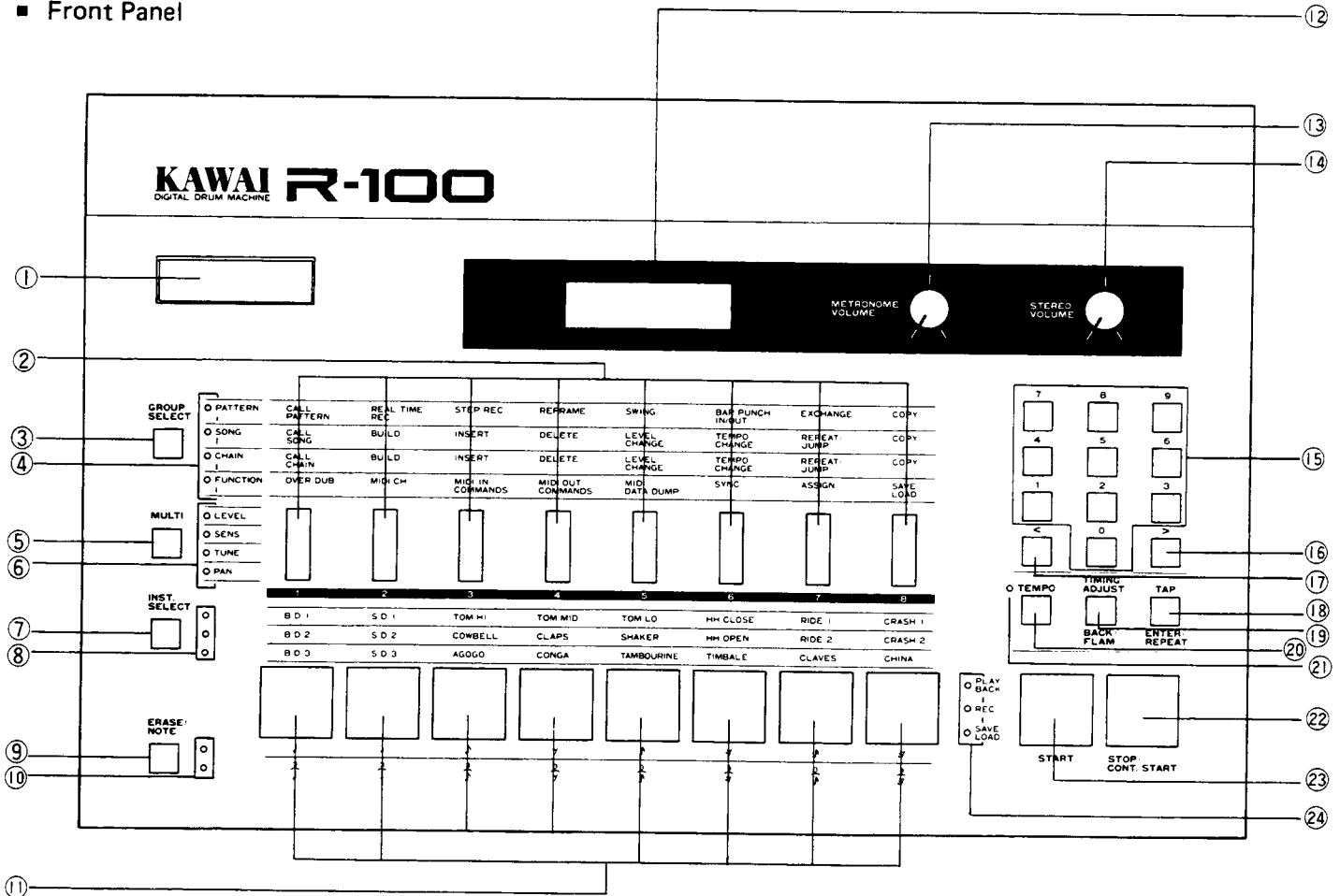

### ■ Rear Panel

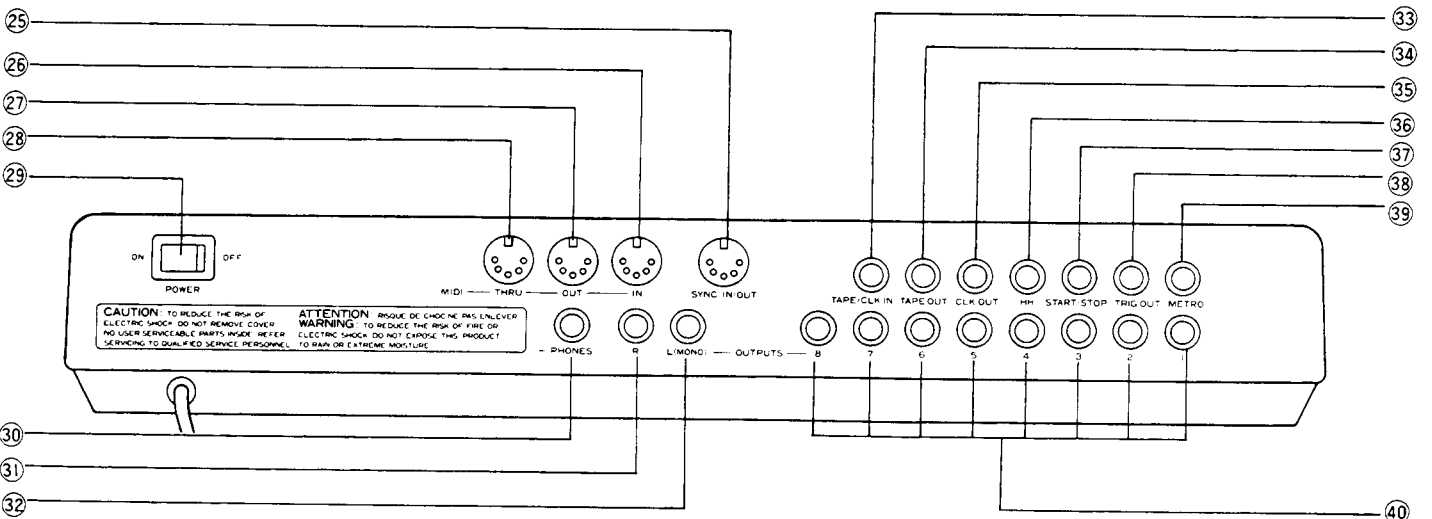



■ Front Panel

- 1 Memory cartridge slot
- 2 COMMAND SELECT keys (#1 ~ #8)
- 3 GROUP SELECT key
- 4 GROUP SELECT indicators
- 5 MULTI SELECT key
- 6 MULTI SELECT indicators
- 7 INST. SELECT key
- 8 INST. SELECT indicators
- 9 ERASE/NOTE SELECT key
- 10 NOTE SELECT indicators
- 11 Instrument pads
- 12 LCD display
- 13 Metronome volume knob
- 14 STEREO volume knob
- 15 KEYPAD
- 16 INCREMENT key
- 17 DECREMENT key
- 18 TAP/ENTER/REPEAT key
- 19 TIMING ADJUST/BACK/FLAM key
- 20 TEMPO key
- 21 TEMPO indicator
- 22 STOP/CONTINUE key
- 23 START key
- 24 Job indicator

■ Rear Panel

- 25 SYNC IN/OUT jack
- 26 MIDI IN jack
- 27 MIDI OUT jack
- 28 MIDI THRU jack
- 29 POWER switch
- 30 Headphone jack
- 31 Stereo output jack (R)
- 32 Stereo output jack (L/MONO)
- 33 TAPE/CLOCK IN jack
- 34 TAPE OUT jack
- 35 CLOCK OUT jack
- 36 HH (Hi-hat) foot switch jack
- 37 START/STOP foot switch jack
- 38 TRIG (Trigger output) jack
- 39 METRONOME output jack
- 40 INDIVIDUAL output jacks

## 1.2 Connections

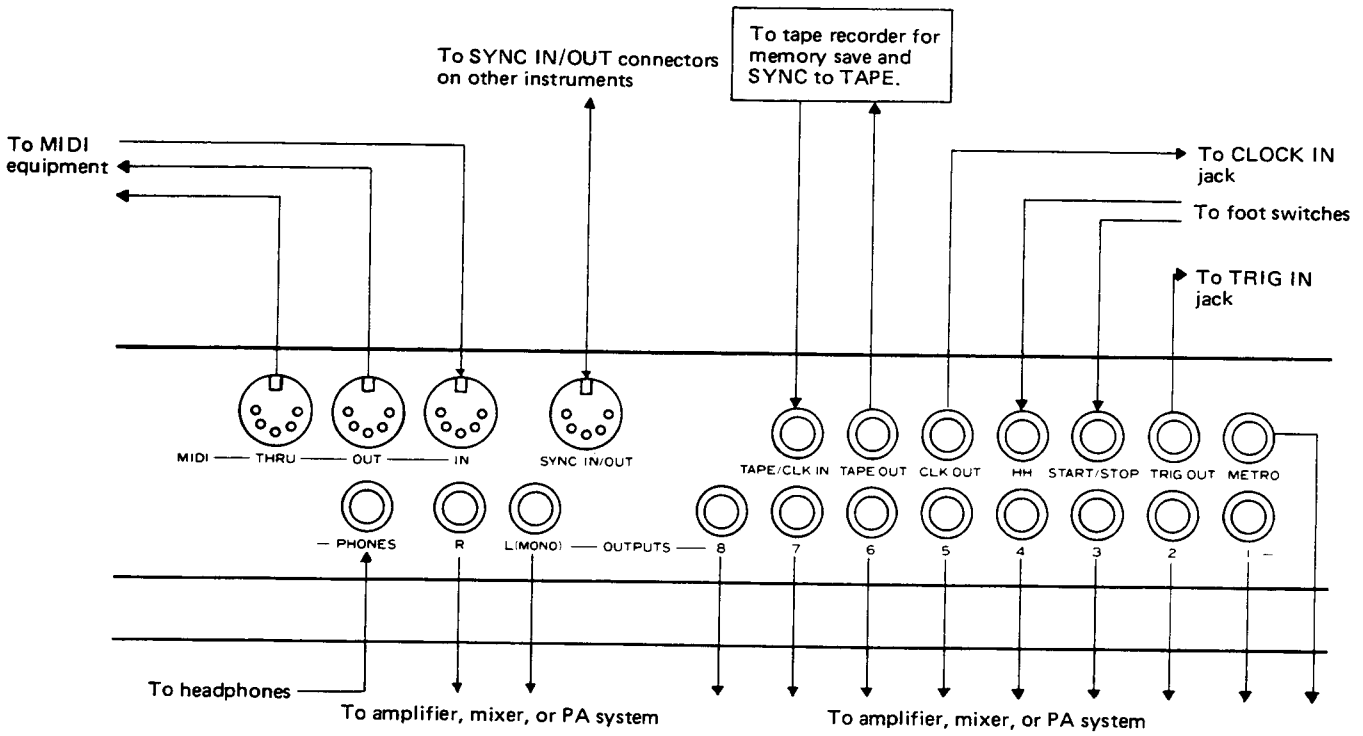



## 13 Jacks

### ■ OUTPUTS

The R-100 does not include a power amplifier or speaker. To hear the output, you must use a set of headphones, or connect the R-100 to a sound system using the appropriate jack or jacks.

### ■ METRO. (METRONOME)

This jack provides the metronome signal.

### ■ TRIG. OUT

This jack provides regular 5-volt, 20 ms trigger pulses. To assign the instrument, see Section 16.3 "TRIG. OUT ASSIGN."

### ■ START/STOP

This jack accepts the optional F-1 foot switch for control of playback and recording.

### ■ HH (HH CLOSE/OPEN)

This jack accepts a foot switch for switching between the open and closed high hat.

### ■ CLK OUT (CLOCK OUT)

This jack provides a clock signal (24 pulses per quarter note) for synchronizing sequencers and other instruments with the drum machine.

### ■ TAPE OUT

This jack provides a tape synchronization signal or data signal.

### ■ TAPE/CLK IN

This jack accepts a tape synchronization signal, data signal or a clock signal from other external equipment.

### ■ SYNC IN/OUT

This DIN jack provides or accepts external synchronization signals at 24 pulses per quarter note.

### ■ MIDI IN/OUT/THRU

These jacks accept and transmit MIDI signals.

# 2. Overview

## 2.1 Sound Sources

The R-100 features the following twenty-four built-in sound sources arranged in three groups of eight instrument each:

1	2	3	4	5	6	7	8
BD 1	SD 1	TOM HI	TOM MID	TOM LO	HH CLOSE	RIDE 1	CRASH 1
BD 2	SD 2	COWBELL	CLAPS	SHAKER	HH OPEN	RIDE 2	CRASH 2
BD 3	SD 3	AGOGO	CONGA	TAMBOURINE	TIMBALE	CLAVES	CHINA

(These groups are listed in three rows above the respective drum pad.)

**Note:** BD = Bass Drum, SD = Snare Drum

All eight instruments in the current group can be played from the eight large keys in the lowermost row. Pressing the INST.SELECT key cycles among the three groups.

**Note:** The LED to the right of the INST.SELECT key indicates the current group.

The R-100's twenty-four instruments are divided into eight groups of three instrument each. Since the three instruments in a group share the same voice channel, it is impossible to play them simultaneously. (It is, however possible to play up to eight different voices together — each with a different instrument when that voice is already playing, the new instrument replaces the old. This also occurs when the same instrument is played over itself: the new velocity, tuning and pan replace the the original.)

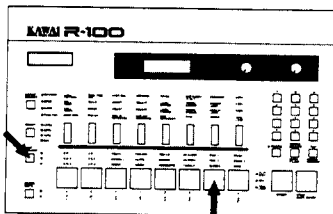

INST.SELECT indicator

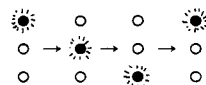

Pressing the INST.SELECT key shifts to the next row of instruments as shown by the LED indicator.

## 2.2 Structuring Rhythm Patterns

The R-100 allows you to combine the 24 instruments in a virtually limitless number of ways. To help you keep track, however, it adopts a hierarchical approach using "patterns", "songs", and "chains" – three units which build upon one another:

### ■ PATTERN

The minimal unit of drum machine operation, a "pattern" consists of combinations of the 24 instruments arranged to form a rhythm up to 99 bars long. The R-100 has a capacity of 100 "patterns".

### ■ SONG

A "song" links up to 999 "patterns" together into a longer unit for continuous playing. The R-100 has a capacity of 100 "songs".

### ■ CHAIN

The largest unit of all, a "chain" links up to 999 "songs" together into one extended percussion accompaniment. The R-100 has a capacity of 10 "chains".

Listed in four rows above the eight COMMAND SELECT keys are the 32 commands available to control recording, playback, and other drum machine operations. The first three rows contain the various commands for the three organizational levels: Patterns, Songs, and Chains; The fourth is primarily for MIDI, and synchronization function.

#### Group 1. PATTERN

- CALL PATTERN
- REALTIME REC.
- STEP REC.
- REFRAME
- SWING
- BAR PUNCH IN/OUT
- EXCHANGE
- COPY

#### Group 2. SONG

- CALL SONG
- BUILD
- INSERT
- DELETE
- LEVEL CHANGE
- TEMPO CHANGE
- REPEAT/JUMP
- COPY

#### Group 3. CHAIN

- CALL CHAIN
- BUILD
- INSERT
- DELETE
- LEVEL CHANGE
- TEMPO CHANGE
- REPEAT/JUMP
- COPY

#### Group 4. FUNCTION

- OVER DUB
- MIDI CH
- MIDI IN COMMANDS
- MIDI OUT COMMANDS
- MIDI DATA DUMP
- SYNC
- ASSIGN
- SAVE/LOAD

## 2.4 Selecting Commands

When the power is first applied, the LCD screen reads \*KAWAI R-100\* DRUM MACHINE for a few seconds and then switches to the CALL PATTERN command — the first command in the first row on the front panel.

Pressing the GROUP SELECT key changes the row. The changes are cyclic:

PATTERN → SONG → CHAIN → FUNCTION  
→ PATTERN

The LEDs at the left show the current row.

**Note:** You cannot change rows when you are recording or playing back a rhythm pattern.

Press one of the eight COMMAND SELECT keys to access the desired command in that row. The name of that command then appears in the upper left-hand corner of the screen. The rest of the screen contains data fields for that command's parameters. Press the ENTER or BACK key to change fields. The cursor underline shows the current field.

### Example:

The CALL PATTERN command asks for two numbers: the pattern number and the number of the bar to start from. When first activated, it displays a small underline — called the "Cursor" — at the right end of the pattern number field. Pressing the ENTER key shifts the cursor to the second line, to the bar number field. Pressing the ENTER key a second time or the BACK key returns the cursor to the pattern number field.

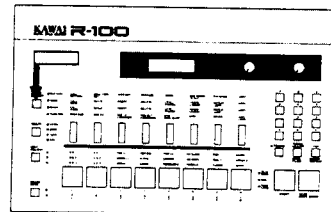

```
* KAWAI R-100 *
DRUM MACHINE
```

Press the GROUP SELECT key to change the display.

```
CALL PTN 00.
BAR 02 04/04
```

```
CALL SONG 00
DANCIN' FOO'
```

```
CALL CHAIN 0
KAWAI R-100 DEMO
```

```
OVERDUB SONG **
```

```
CALL PTN 00.
BAR 02 04/04
```

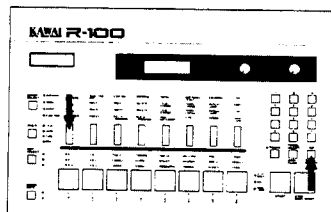
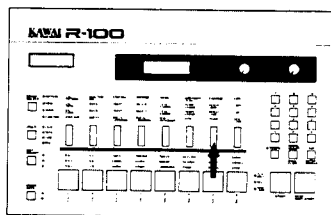

Pressing a COMMAND SELECT key (#7) also changes the display.

```
EXCHANGE
PTN ** ←→ PTN **
```

Press COMMAND SELECT key (#1).

```
CALL PTN 00.
BAR 02 04/04
```

Press the ENTER key.

```
CALL PTN 00.
BAR 02-01 04/04
```

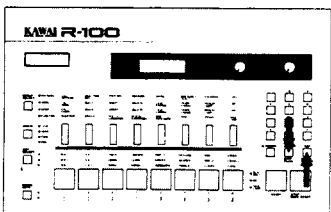

```
CALL PTN 00.
BAR 02-01 04/04
```

Press the ENTER or BACK key.

```
CALL PTN 00.
BAR 02 04/04
```

## 2.5 Entering a Parameter

Pattern numbers, bar numbers, and other parameters can be entered using the keypad located toward the upper right hand corner of the front panel and the INCREMENT (" $>$ ") or DECREMENT (" $<$ ") keys next to it.

**Note:** Always prefix a single-digit number with a zero.

8 → "0" "8"

Certain commands – STEP REC, REFRAME, and SWING, for example – require an instrument name. Select the instrument by pressing the pad for the appropriate instrument. Use the instrument select key if necessary.

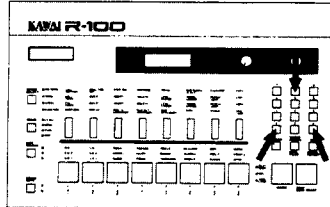

```
CALL PTN 00.
BAR 0 2 0 4 / 0 4
```

Press the "0" and "8" keys.

```
CALL PTN 08
BAR 0 1 0 4 / 0 4
```

Press the ">" key.

```
CALL PTN 10
BAR 0 2 0 4 / 0 4
```

```
STEP: DUB PTN. 00
BAR 0 1 0 4 / 0 4
```

Press the "SD1" pad.

```
STEP: SD1 PTN. 00
BAR 0 2 0 4 / 0 4
```

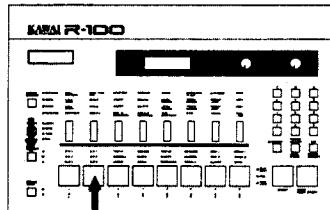

# 3. Tempo and MULTI Programming Functions

## 3.1 Changing the Tempo (Method 1)

Press the TEMPO key, which is located under the keypad, to light the LED next to it and display the current tempo ♪ = 120.

**Note:** Certain commands ignore the TEMPO key. See the chart in Section 3.6.

The INCREMENT (">") or DECREMENT ("<") keys raise and lower the tempo over the range 40-250.

**Note:** The tempo remains on the display until you press the TEMPO key a second time, start or stop the R-100, or press another COMMAND SELECT key.

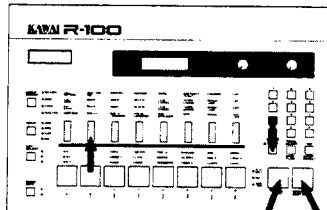
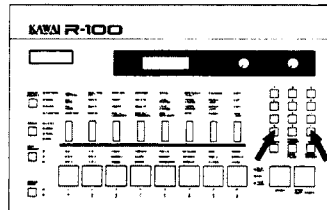
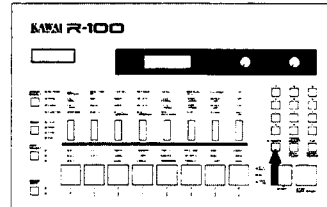

CALL	PTN	00
BAR	02	04 / 04

Press the TEMPO key.

♪ =	120	PTN	00
BAR	02	04 / 04	

Hold down the ">".

♪ =	130	PTN	00
BAR	02	04 / 04	

Hold down the "<".

♪ =	116	PTN	00
BAR	02	04 / 04	

Press the COMMAND SELECT key (#2).

REAL : DUB	PTN	00
BAR	02	04 / 04

Press the TEMPO key.

CALL	PTN	00
BAR	02	04 / 04

Press the START or CONT.START key.

PLAY	PTN	00
BAR	02-01	04 / 04

### 3.2 Changing the Tempo (Method 2)

The TAP/ENTER key provides a faster way to change the tempo on the display. Simply tap this key several times at the desired tempo. The R-100 measures the intervals between taps, calculates the tempo in beats per minute, and displays the result.

- Notes:**
- This mode is also available in playback.
  - You must hit the TAP key at least twice.
  - The R-100 interprets a tap that arrives 1.5 seconds or more after the preceding one as the first of a new series.

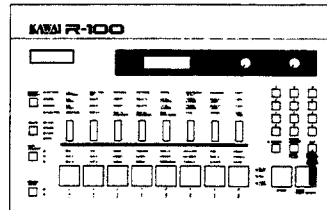

J = 120 PTN 00.  
BAR 02 04 / 04

J = 180 PTN 00.  
BAR 02 04 / 04

J = 96 PTN 00.  
BAR 02 04 / 04

### 3.3 MULTI Programming Functions

Each of the 24 instruments has four parameters, accessed from the MULTI key.

- **LEVEL** – The maximum output level.
- **SENS. (sensitivity)** – The response to key velocity, or dynamic range (This actually sets the minimum output level. The larger the value, the greater the range between minimum and maximum dynamic. At zero they are the same.)
- **TUNE** – The sound's pitch.
- **PAN** – The balance between left and right stereo output.

**Note:** The last two, TUNE and PAN, may also be edited for each note in a sequence stored with the REALTIME or STEP REC commands.

LEVEL

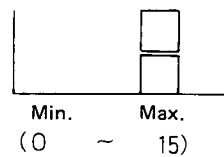

TUNE

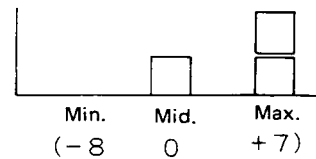

SENS

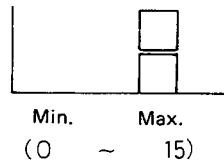

PAN

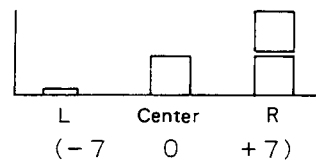

### 3.4 Accessing the MULTI Programming Functions

To access the MULTI programming functions, press the MULTI SELECT key. The LED next to the LEVEL label then lights.

**Note:** Certain commands ignore the MULTI key. See the chart in Section 3.6.

The multi selector key cycles through the parameters. The LED shows the current parameters.

LEVEL → SENS → TUNE → PAN → LEVEL

To change the instrument group, press the INST. SELECT key. As confirmation, the display always gives the two-character abbreviations (See chart.) for the instruments currently selected.

To change the value of the parameter for a particular instrument, press the corresponding COMMAND SELECT key. (See next section.)

BD1 = B1    BD2 = B2    BD3 = B3  
SD1 = S1    SD2 = S2    SD3 = S3

TOM HI = TH/TOMH  
COWBELL = CB/COWB  
AGOGO = AG/AGOG  
TOM MID = TM/TOMM  
CLAPS = CP/CLPS  
CONGA = CO/CONG  
TOM LO = TL/TOML  
SHAKER = SH/SHAK  
TAMBOURINE = TB/TAMB  
HHCLOSE = HC/HHCL  
HH OPEN = HO/HHOP  
TIMBALE = TL/TMBL  
RIDE1 = R1/RID1  
RIDE2 = R2/RID2  
CLAVES = CV/CLVS  
CRASH1 = C1/CRS1  
CRASH2 = C2/CRS2  
CHINA = CH/CHNA

**Note:** The parameters remain on the display until you press the GROUP SELECT key or begin or end recording or playback.

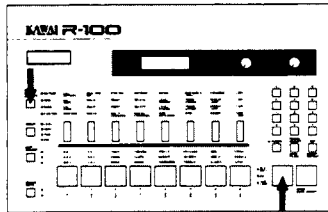
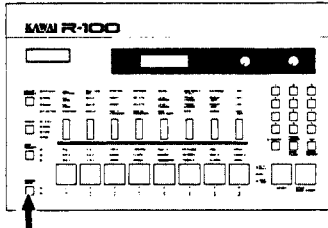
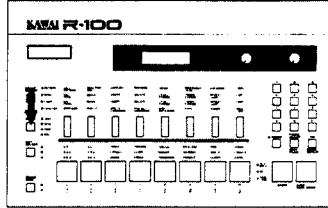

CALL PTN 00.  
BAR 01 04/04

Press the MULTI SELECT key.

B S T T T H R C  
1 1 H M L C 1 1

● LEVEL ○ LEVEL ○ LEVEL ○ LEVEL  
○ SENS ● SENS ○ SENS ○ SENS  
○ TUNE → TUNE → ● TUNE → TUNE  
○ PAN ○ PAN ○ PAN ● PAN

B S T T T H R C  
1 1 H M L C 1 1

Press the INST. SELECT key.

B S C C S H R C  
2 2 B P H O 2 2

To exit, press either GROUP SELECT or START key.

B S A C T T C C  
3 3 G O B L V H

Press the GROUP SELECT key.

CALL PTN 00.  
BAR 01 04/04

Press the START or CONT. START key.

PLAY PTN 00.  
BAR 01-01 04/04



The R-100 allows you to change TUNE and PAN value of instruments with MANUAL CONTROL after recording.

**MANUAL CONTROL command:**

- (1) Press MULTI key to access TUNE or PAN.
- (2) Press ENTER key.
- (3) Press the "<" or ">" key to select OFF or ON. ("<" for OFF, ">" for ON, default: OFF)
- (4) Press ENTER or START key. (ENTER key for bar-graph display, START key for playback)

**Notes:**

1. You can access MANUAL CONTROL only while stopped.
2. Even when MANUAL CONTROL is ON, you can record a rhythm pattern with current value.

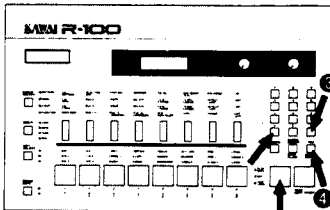
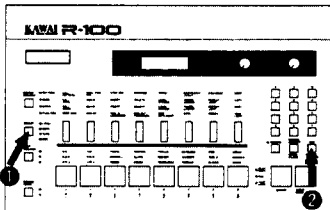
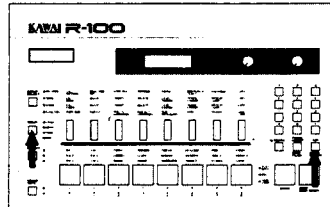

**MANUAL CONTROL (TUNE)**

MANUAL CONTROL  
TUNE ON

**MANUAL CONTROL (PAN)**

MANUAL CONTROL  
PAN OFF

CALL PTN 00.  
BAR 02 04/04

Press MULTI key.

B S T T T H R C  
1 1 H M L C 1 1

☀ LEVEL → ☀ TUNE

Press ENTER key.

MANUAL CONTROL  
TUNE OFF

Press ">" key to select "ON".

MANUAL CONTROL  
TUNE ON

Press ENTER key.

B S T T T H R C  
1 1 H M L C 1 1

Press START key.

PLAY PTN 00.  
BAR 02-01 04/04

### 3.5 Changing the Parameter Value

Press the upper end of the command select key to raise the value of the corresponding instrument, press the other end to lower it.

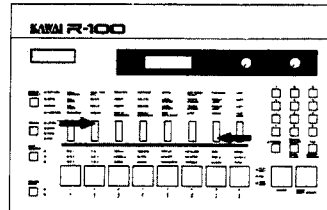

B S T T T H R C  
1 ■ 1 ■ H ■ M ■ L ■ C ■ 1 ■ 1 ■

Press the upper end of the  
COMMAND SELECT key (#2).

B S T T T H R C  
1 ■ 1 ■ H ■ M ■ L ■ C ■ 1 ■ 1 ■

Press the lower end of the  
COMMAND SELECT key (#7).

B S T T T H R C  
1 ■ 1 ■ H ■ M ■ L ■ C ■ 1 ■ 1 ■

### 3.6 Tempo/Multi Control Availability List

Group	Command	Availability	Group	Command	Availability
PATTERN	CALL PTN	Y1	FUNCTION	OVERDUB	Y2
	REALTIME REC	Y2		MIDI CH	N
	STEP REC	Y3		MIDI IN COMMANDS	Y5
	REFRAME	Y4		MIDI OUT COMMANDS	N
	SWING	Y4		MIDI DATA DUMP	N
	BAR PUNCH IN/OUT	Y2		SYNC	N
	EXCHANGE	N		ASSIGN	N
	COPY	N		SAVE/LOAD	N
SONG/CHAIN	CALL SONG/CHAIN	Y1	Y1 Both always available.		
	BUILD	Y2	Y2 Both available in select No. field and during recording/playback.		
	INSERT	Y4	Y3 Both available in select No. field and Only Multi available during recording.		
	DELETE	Y4	Y4 Available only during Initial Mode Selection.		
	LEVEL CHANGE	Y4	Y5 Only MULTI available for the KEY NO. setting mode.		
	TEMPO CHANGE	Y4	N Neither available.		
	REPEAT/JUMP	Y4			
	COPY	N			

# 4. Playing a Rhythm Pattern

## 4.1 Basic Command

The CALL PATTERN command is used to play back a previously recorded pattern. It appears when you first apply power or when you select the PATTERN group.

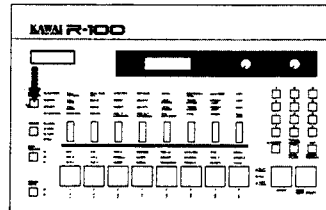

\* KAWAI R-100 \*  
DRUM MACHINE

CALL PTN 00.  
BAR 02 04/04

## 4.2 Playing the Pattern

Pressing the START key changes the display from "CALL" to "PLAY", lights the PLAYBACK LED, and starts the playback. The pattern then repeats endlessly. You can select another pattern while playing, which will be played after the current pattern.

**Note:** You cannot change to another command while a pattern is playing.

On the left side of the lower line of the display, the total number of bars in the pattern and the number of the current bar, respectively are shown; on the right side is the time signature.

Pressing the STOP key suspends the playback. You can then resume playing the same pattern by pressing either the START key, plays from the beginning of the pattern, or the STOP/CONT. START key, which resumes where it left off.

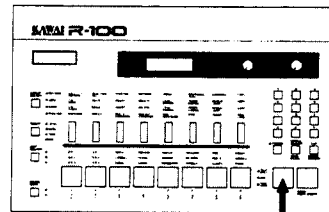

CALL PTN 00.  
BAR 02 04/04

Press the START key.

PLAY PTN 00.  
BAR 02-01 04/04

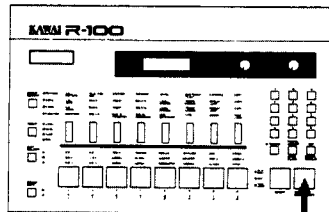

PLAY PTN 00.  
BAR 02-01

Press the STOP key.

PLAY PTN 00.  
BAR 02-01 04/04

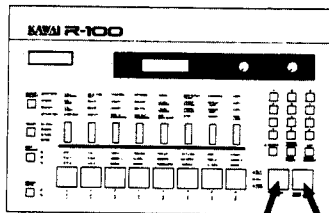

PLAY PTN 00.  
BAR 02-01 04/04

Press the START or STOP/CONT. START key.

PLAY PTN 00  
BAR 02-01 04/04

Note the position of the cursor.

### 4.3 Changing the Pattern Number

The keypad, the "<" key, and the ">" key change the pattern number. The <, > change the pattern number as long as they are held down.

**Note:** These two keys no longer produce any effects when the number reaches either end point ("00" or "99").

If the machine is playing, the new pattern number appears to the right of the current one and plays after the machine reaches the end of the current pattern.

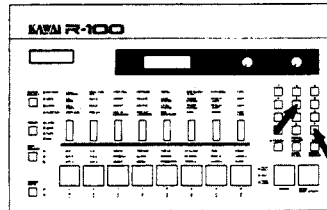

When the machine is not playing  
Press the ">" key.

```
CALL PTN 01.
BAR 02 04/04
```

Press the "1" and "2" keys.

```
CALL PTN 12.
BAR 01 04/04
```

When the machine is playing

```
PLAY PTN 00.
BAR 02-01 04/04
```

Press the ">" key.

```
PLAY PTN 00. 01
BAR 02-01 04/04
```

```
PLAY PTN 01.
BAR 02-01 04/04
```

### 4.4 Changing the Bar Number

Pressing the ENTER key shifts the cursor to the current bar number field, the second number in the second line. Use the "<" or ">" key to change this number and then press the CONT. START key.

**Note:** Do not press the START key. It always takes you back to the beginning of the pattern.

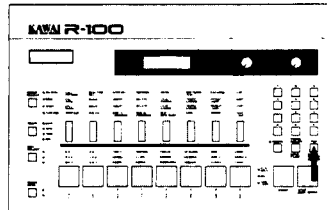

```
CALL PTN 01.
BAR 02 04/04
```

You may now change the starting bar number.

```
CALL PTN 01.
BAR 02-01 04/04
```

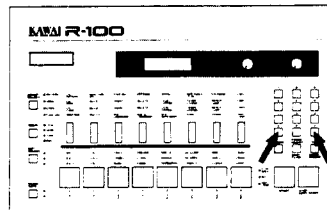

```
CALL PTN 01.
BAR 02-01 04/04
```

Use the "<" or ">" key to change the number.

```
CALL PTN 01.
BAR 02-02 04/04
```

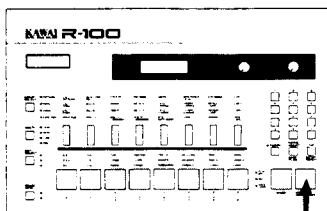

```
CALL PTN 01.
BAR 02-02 04/04
```

Press the CONT.START key to start playing at that point.

```
PLAY PTN 01.
BAR 02-02 04/04
```

# 5. Erasing a Pattern

## 5.1 Types of Erasures

The R-100 allows you to erase:

- (1) One particular pattern,
- (2) A particular instrument from a pattern,
- (3) A particular bar from a multi-bar pattern, and
- (4) All data – patterns, songs, and chains.

\* (1) You can also erase particular instruments during recording, see Section 6.4.

\* (2) Erase functions for song and chains are discussed in Section 9.

```
PTN 00
ERASE  READY
```

```
PTN 00      BDI
ERASE  READY
```

```
PTN 00-01
ERASE  READY
```

```
ALL MEMORY
ERASE  READY
```

## 5.2 Erasing a Pattern

Press any of the first five COMMAND SELECT keys (not BAR PUNCH IN/OUT, EXCHANGE or COPY) in the PATTERN group to display the pattern number entry field on the first line. Press the ERASE key to display the message ERASE READY on the second. Press the ENTER key to complete the erasure, the BACK key to cancel.

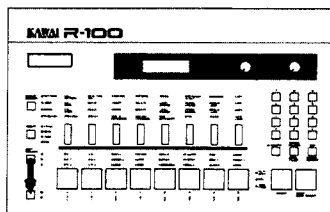

```
CALL  PTN 00
BAR 02      04 / 04
```

Press the ERASE key.

```
PTN 00
ERASE  READY
```

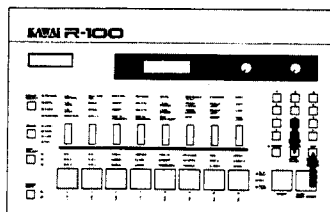

Press the BACK key.

```
PTN 00
ERASE  CANCEL
```

```
CALL  PTN 00
BAR 01      04 / 04
```

### 5.3 Erasing a Particular Instrument

With the message ERASE READY on the screen, hit the desired instrument pad. The instrument's three- or four-letter abbreviation will appear on the right half of the first line on the display. If this is the correct instrument, press the ENTER key to complete the erasure. Otherwise, press the BACK key to cancel.

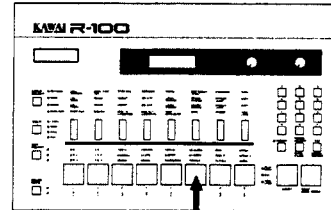

```
PTN 00
ERASE READY
```

Press the HiHat instrument pad.

```
PTN 00   HHCL
ERASE READY
```

Press the BACK key.

```
PTN 00   HHCL
ERASE CANCEL
```

Press the ENTER key to execute and return to the CALL PATTERN command.

```
CALL   PTN 00.
BAR 02   04/04
```

### 5.4 Erasing One Bar of a Pattern

Use the CALL PATTERN command to select the pattern number and the bar number then press the ERASE key to shift the two numbers to the first line. Press the ENTER key to complete the erasure, the BACK key to cancel.

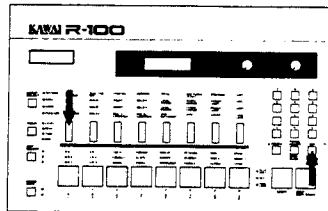

Specify the bar number.

```
CALL   PTN 01.
BAR 02-02 04/04
```

Press the ERASE key.

```
PTN 01-02
ERASE READY
```

Press the BACK key.

```
PTN 01-02
ERASE CANCEL
```

Press the ENTER key to execute and return to the CALL PATTERN command.

```
CALL   PTN 01
BAR 01-01 04/04
```

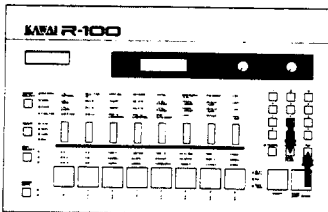

## 5.5 Erasing All Data

Simultaneously press the first COMMAND SELECT key and the ERASE key to display the message ALL MEMORY/ERASE READY. Press the ENTER key once to display the confirmation message ERASE SURE? and a second time to complete the erasure. Press the BACK key to cancel.

**Note:** Before you erase the memory contents, Kawai strongly recommends that you make a backup copy on an RC-16 memory cartridge (available separately) or cassette tape.

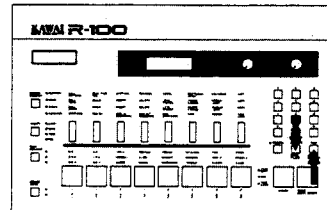
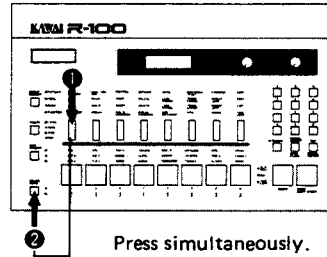

```
CALL PTN 00.
BAR 02 04/04
```

Simultaneously press the first COMMAND SELECT key and the ERASE key.

```
ALL MEMORY
ERASE READY
```

Press the ENTER key and wait for confirmation message.

```
ALL MEMORY
ERASE SURE ?
```

Press the BACK key.

```
ALL MEMORY
ERASE CANCEL
```

Press the ENTER key to execute and return to the CALL PATTERN command.

```
CALL PTN 00.
BAR 01 04/04
```

## 5.6 Checking Available Memory

Simultaneously pressing the first COMMAND SELECT key and the GROUP SELECT key displays the percentage of memory available for storing new rhythm patterns, songs and chains. The display automatically clears after a few seconds.

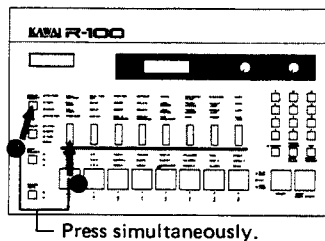

```
CALL PTN 00.
BAR 02 04/04
```

Simultaneously press the first COMMAND SELECT key and the GROUP SELECT key.

```
Memory Available
98 %
```

The display automatically clears after a few seconds.

```
CALL PTN 00.
BAR 02 04/04
```

# 6. Recording Rhythm Patterns

## 6.1 Recording Methods

The R-100 offers a choice of two recording methods:

### (1) REALTIME REC.

The R-100 records the rhythm exactly as played on the instrument pads.

### (2) STEP REC.

You sequentially play the beats and rests for each instrument one at a time.

Both allow you complete access to all 24 instruments available.

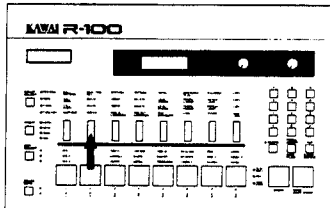

REALTIME REC.

```
REAL: NEW   PTN 08
BAR 01     04/04
```

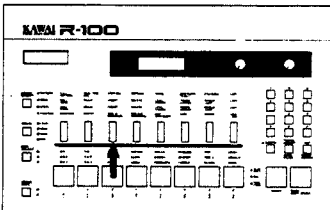

STEP REC.

```
STEP: BD1  PTN 08
BAR 01     04/04
```

**Note:** DUB indicates that the pattern already contains data; NEW, that it is completely blank.

## 6.2 REALTIME REC. – Parameters

The REALTIME REC. command has six parts, used to set the recording parameters:

Parameter	Range	Default	<, >	Keypad?
Pattern number	00 ~ 99	/	Y	Y
Length in bars	01 ~ 99	01	Y	Y
Beats per bar *1	01 ~ 99	04	Y	Y
Beat value *1	04, 08, 16	04	Y	N
Metronome value	OFF, 1/4, 1/6, 1/8, 1/12, 1/16, 1/24, 1/32	1/4	Y	N
ERROR CORRECT*2	1/4, 1/6, 1/8, 1/12, 1/16, 1/24, 1/32, 1/48, 1/64, 1/96, 1/192	1/16	Y	N

### Notes:

1. These can only be set for a NEW pattern.
2. The ERROR CORRECT function automatically corrects your playing to this note value.

The ENTER and BACK keys switch through the steps in the order indicated. Remember that you cannot change the length or time signature of a pattern after recording even a single note.

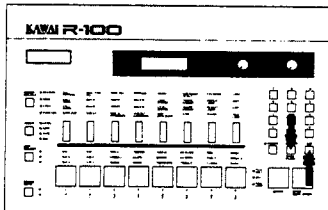

Select the pattern number.

```
REAL: NEW   PTN 99
BAR 01     04/04
```

Select the number of bars.

```
REAL       PTN 99
BAR 01     04/04
```

Select the time signature beats per bar.

```
REAL       PTN 99
BAR 01     04/04
```

Select the time signature beat value.

```
REAL       PTN 99
BAR 01     04/04
```

Select the metronome beat value.

```
METRONOME SELECT
1/4
```

Select the note value for error correction.

```
ERROR CORRECT
1/16
```

```
REAL: NEW   PTN 99
BAR 01     04/04
```



## 6.3 REALTIME REC. — Recording

Once you have specified the parameters, press the START or CONT. START key to start recording. The metronome will beat in time and what you play on the instrument pads will be recorded.

### ■ Erasing notes while recording

To erase a note from the pattern, hold down the ERASE key and press the appropriate instrument pad at that particular moment. Holding down the instrument pad erases all notes played by that particular instrument. Check the INST. SELECT indicator to make sure that you are erasing the correct instrument.

### ■ Recording repeated notes

Holding down the ENTER/REPEAT key and an instrument pad produces repeated notes. The interval between notes is determined by the ERROR CORRECT parameter. (1/4 ~ 1/96 available) A setting of 1/16, for example, produces a sequence of sixteenth notes.

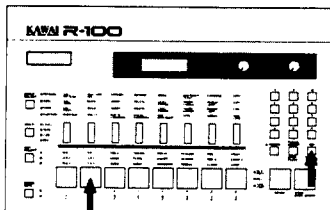
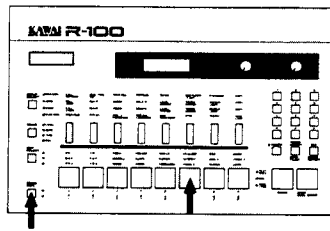
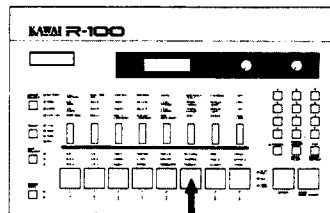
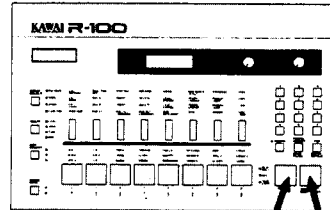

Press simultaneously.

REAL	PTN 99
BAR 01-01	04/04

Both the PLAYBACK and REC LEDs next to the start key will light.

Press the instrument pads to record.

REAL	PTN 99
BAR 01-01	04/04

The TEMPO indicator flashes on the down beat of each bar.

○ TEMPO    ● TEMPO    ○ TEMPO  
● REC    ● REC    ● REC

Simultaneously pressing the ERASE key and an instrument pad erases that instrument at that point.

ERROR CORRECT = 1/16



The instrument repeats as long as both keys are pressed.

## 6.4 STEP REC. — Parameters

The STEP REC. command has five parts to set the recording parameters:

Parameter	Range	Default	<,>	Keypad?
Parameter number	00 ~ 99	/	Y	Y
Length (in Bars)	01 ~ 99	01	Y	Y
Beats per bar	01 ~ 99	04	Y	Y
Beat value	04, 08, 06	04	Y	N
BAR CORRECT ON/OFF	ON, OFF	ON	Y	N

**Note:** The BAR CORRECT function automatically cuts short any note values that would otherwise sustain across a bar. In this mode, the first note (or rest) programmed will always start at the beginning of the bar.

Before starting the actual recording, move the cursor to a parameter other than BAR CORRECT and select the first instrument by pressing the appropriate pad. (The default is BD1.)

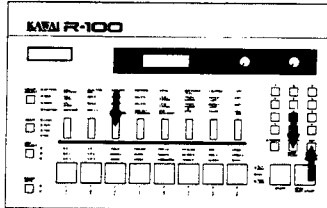

The ENTER and BACK keys go through the steps in the order indicated.

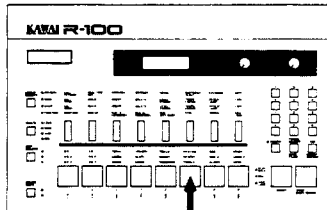

STEP REC.

```
STEP: NEW PTN 9 9
BAR 01 04 / 04
```

Select the time signature beats per bar.

```
STEP: BD1 PTN 9 9
BAR 01 04 / 04
```

Select the time signature beat value.

```
STEP: BD1 PTN 9 9
BAR 01 04 / 04
```

Specify the BAR CORRECT parameter: "<" = OFF; ">" = ON.

```
BAR CORRECT ON
```

```
STEP: BD1 PTN 9 9
BAR 01 04 / 04
```

Press the sixth instrument pad.

```
STEP: HHCL PTN 9 9
BAR 01 04 / 04
```

## 6.5 STEP REC. – Recording

Once you have specified the parameters, press the START or CONT. START key to start step recording. The REC. LED in the job indicator section will light.

**Note:** The TEMPO indicator also lights because you are currently at the first beat of a bar.

The instrument pads now represent notes and rests for the current instrument as shown by notes printed in orange.

**Note:** The rest pads produce a metronome sound when pressed.

The ERASE/NOTE key switches between quarters and triplets. The LEDs next to this key show which of the two sets of labels below the instrument pads is currently in effect.

The "<" and ">" keys change to the preceding or next bar, respectively.

The touch response feature remains active during recording so the harder you hit a note, the louder the output.

Pressing the STOP key terminates the recording for the current instrument. You may now repeat the above procedure for another instrument or use the CALL PATTERN command to play the pattern.

During recording, holding down the BACK/FLAM key while you strike a note produces two notes instead of one. This function automatically adjusts the relative levels so that the second is a little louder than the first and also adjusts the interval so that shorter notes are closer together creating a true flam.

The time between the flammed note and the main note is determined by the note value used to play the note, i.e. the flam is farther apart for a quarter note than for a sixteenth note.

**Note:** Simultaneously press the INST. SELECT key and INST. pad, you can overdub desired note.

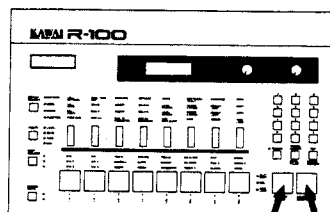

STEP: BD1 PTN 05  
BAR 02 04/04

Press the START or CONT. START key.

STEP: BD1 PTN 05  
BAR 02-01 04/04

● TEMPO ○ TEMPO ● TEMPO

● REC. ● REC. ● REC.

STEP: BD1 PTN 05  
BAR 02-02 04/04

Press the "<" key.

STEP: BD1 PTN 05  
BAR 02-01 04/04

STEP: BD1 PTN 05  
BAR 02-02 04/04

Press the STOP key.

STEP: BD1 PTN 05  
BAR 02-02 04/04

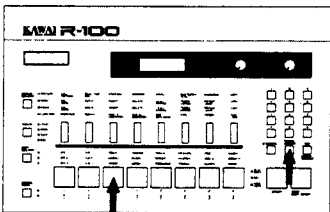
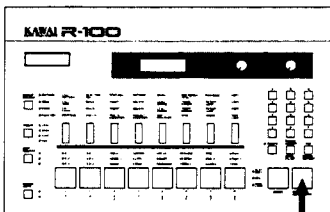
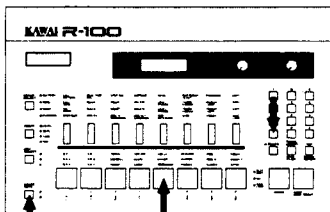

Hold down the FLAM key as you strike the note.

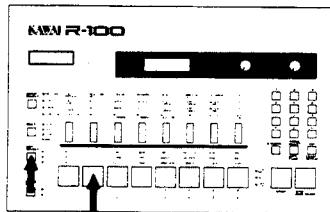

Playing the instrument pad alone.	With FLAM key.
♪	♪♪

## 6.6 Using MULTI Programming During Recording

You can change the pitch (TUNE) or stereo balance (PAN) of any instrument during either REALTIME or STEP recording. Simply press the MULTI key, change the parameter values, and press the instrument pad. (For further details, see Section 6.8 "Actual Recordings – Sample II".)

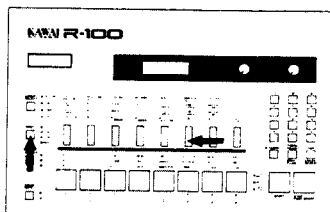

REAL PTN 00  
BAR 02-01 04/04

Press the MULTI key.

B S T T T H R C  
1 1 H M L C 1 1

## 6.7 Actual Recordings – Sample I

This section takes you step-by-step through the procedure for recording the rhythm pattern shown at the right.

First, since it may be difficult to record the sixteenth notes for the high hat pattern with the REALTIME command, use the STEP REC. command:

- (1) Press the STEP REC. command key. If the word DUB appears on the display, either press the ERASE key or change to a pattern with the word NEW. This pattern is one bar in 4/4 time – the defaults – so it is not necessary to change any other part of the display.
- (2) Select the instrument by pressing the appropriate instrument pad (HH CLOSE).
- (3) Press the START or CONT. START key to start recording.
- (4) Press the instrument pads for the rhythm pattern: a sixteenth rest followed by 15 sixteenth notes. Hit the fourth and twelve notes harder to add accents.
- (5) Press the STOP key to end the recording.

**Note:** If, at this point, you would like to review what you have recorded, select the pattern number with the CALL PATTERN command and press the START key.

### Sample I

CRASH 1  
HH CLOSE

SD  
BD

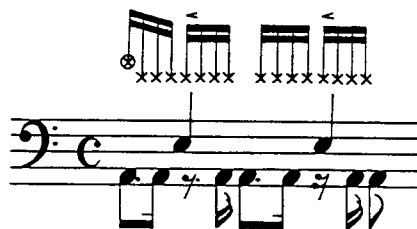

### STEP REC.

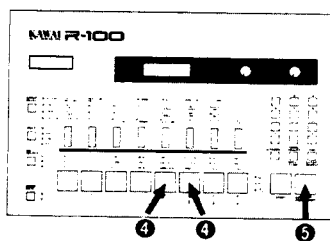
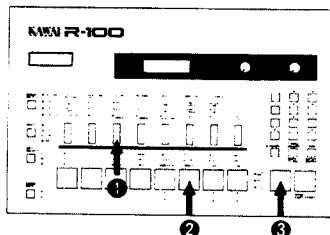

STEP: NEW PTN 20  
BAR 01 04/04

Press the HiHat instrument pad.

STEP: HHCL PTN 20  
BAR 01 04/04

Press the START key.

STEP: HHCL PTN 20  
BAR 01-01 04/04

● TEMPO ○ TEMPO ● TEMPO

● REC ● REC ● REC

STEP: HHCL PTN 20  
BAR 01-01 04/04

Press the STOP key.

STEP: HHCL PTN 20  
BAR 01-01 04/04

The CRASH 1 and snare drum (SD) parts of the pattern are simpler, so use the REALTIME REC. command:

- (1) Press the REALTIME REC. command key.
- (2) To prevent timing errors, use the "<" and ">" keys to change the ERROR CORRECT parameter to 1/4.
- (3) Press the START key to start recording.
- (4) Strike the CRASH 1 and SD instrument pads at the appropriate points of the hi-hat rhythm.
- (5) Press the STOP key to end the recording.

All that remains is the bass drum (BD). Perhaps the STEP REC. command is better for such a complex pattern:

- (1) Set up for step recording using the same first three steps that you used for the high hat part.
- (2) Play the rhythm on the instrument pads.

**Note:** For the dotted eighth notes (  $\text{♩}.$  ) and eighth rest (  $\text{♩} \times$  ), substitute a eighth note followed by a sixteenth rest.

- (3) Press the STOP key to end the recording.

The recording is now complete. To listen to the result, select the pattern number with the CALL PATTERN command and press the START key to see how the R-100 can make you a real drummer!

#### REALTIME REC.

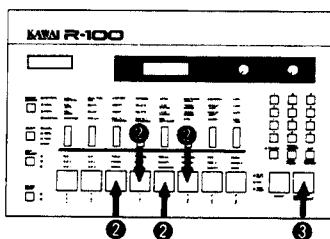
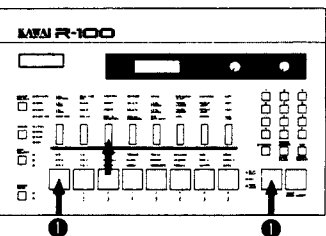
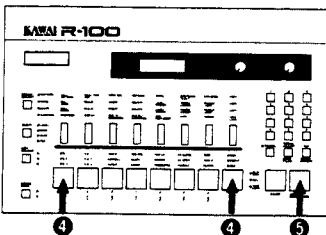
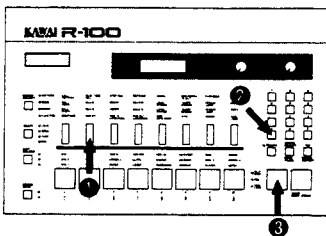

```
REAL: DUB   PTN 20
BAR 01     04/04
```

Use the "<" and ">" keys to set the ERROR CORRECT parameter to 1/4.

```
ERROR CORRECT
1/4
```

Press the START key.

```
REAL       PTN 20
BAR 01-01 04/04
```

```
REAL       PTN 20
BAR 01-01 04/04
```

Press the STOP key.

```
REAL       PTN 20
BAR 01-01 04/04
```

```
STEP: DUB   PTN 20
BAR 01     04/04
```

Press the BD instrument pad.

```
STEP: BD1   PTN 20
BAR 01     04/04
```

Press the START key.

```
STEP: BD1   PTN 20
BAR 01-01 04/04
```

●TEMPO ○TEMPO ●TEMPO

→ →

●REC ●REC ●REC

```
STEP: BD1   PTN 20
BAR 01-01 04/04
```

## 6.8 Actual Recordings – Sample II

This second example is the well-known samba rhythm pattern. The key point of interest is that it uses two different conga lines with a total of four different pitches. Although the R-100 only has one conga sound source, the MULTI programming function allows you to vary the pitch for individual notes and therefore produce the desired results. First use the procedures demonstrated in the preceding section to record the SHAKER, COWBELL, and AGOGO lines as two bars in 2/4 time. The following steps show the MULTI programming function for step recording. MULTI programming is also available during REALTIME recording.

- (1) Set up to record the conga line with the STEP REC. command.
- (2) At each step, set the TUNE parameter to the value shown in the accompanying chart and press the appropriate instrument pad (usually a sixteenth note).
- (3) While you are at it, why not change the stereo balance (PAN) to provide further separation of the two lines? The number of keystrokes involved might make it seem like a lot of work, but once you are accustomed to the procedure, you will find the results well worth the effort.
- (4) When you have finished entering all the notes, press the STOP key to end the recording.

The recording is now complete. To listen to the results, select the pattern number with the CALL PATTERN command and press the START key.

**Note:** You might also want to speed up the tempo to the 130-140 range and add a TIMBALE fill-in to create an even more authentic latin rhythm.

### Sample II. Samba Rhythm

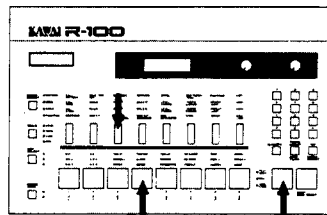

STEP: DUB PTN 09  
BAR 02 02/04

Select CONGA with the conga (& Tom Mid) instrument pad.

STEP: CONG PTN 09  
BAR 02 02/04

### Sample III. Conga Rhythm

TUNEの値	0	+7	0	+7	-8	+4	+7	0	+7	0	+7	-8	-8	+4	+7
PANの値	+2	-7	+2	-7	+7	-2	-7	+2	-7	+2	-7	+7	+7	-2	-7

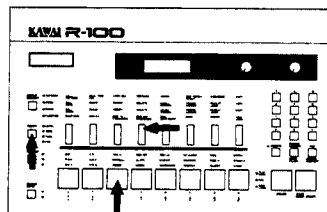

B S A C T T C C  
3 3 3 G O B L V H

Press the ends of the COMMAND SELECT key (#4) to adjust the height of the bar.

B S A C T T C C  
3 3 3 G O B L V H

# 7. Editing Patterns

## 7.1 REFRAME Command

The REFRAME command allows you to ERROR CORRECT a previously recorded pattern. There are five steps.

Parameter	Range	Default	<.>	Keypad?
Pattern number	00 ~ 99	/	Y	Y
ALL/EACH *1	ALL (<), EACH (>)	ALL	Y	N
REFRAME parameter	1/4, 1/6, 1/8, 1/12 1/16, 1/24, 1/32, 1/48, 1/64, 1/96	1/96	Y	N
Instrument (EACH only)	BD1 ~ CHINA Any of the 24 built-in sound sources	BD1		Instrument pads 1-8
READY	Press the ENTER key to proceed, the BACK key to cancel.			

**Note:** ALL reframes all instruments in the pattern; EACH restricts the function to one instrument.

### Example:

Reframing the snare drum (SD) pattern in Sample IV. (Stored as No. 08.)

### ■ Procedure

- (1) Press the COMMAND SELECT (#4) key to access the REFRAME command and type "0" and "8".
- (2) Press the ">" key for EACH (reframing for an individual instrument).
- (3) Press the SD instrument pad to specify the instrument (SD1).
- (4) Use the "<" and ">" keys to change the REFRAME parameter to 1/4.

**Note:** You can do preceding two steps in either order.

- (5) Press the ENTER key when the message READY appears.

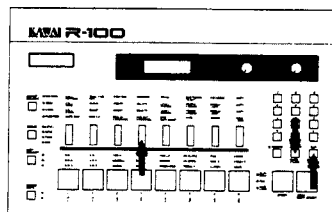

The ENTER and BACK keys go through the steps in the order indicated.

Select the pattern number.

REFRAME PTN 00

Select ALL or EACH.

REFRAME PTN 00  
ALL/EACH ALL

Select the REFRAME parameter.

REFRAME PTN 00  
ALL 1/96

Select the instrument.

REFRAME PTN 00  
EACH: BD1 1/96

Sample IV. (Pattern No. 08)

HH  
SD  
BD

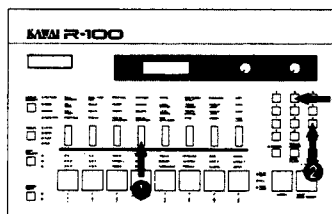

Type 08 on the keypad.

REFRAME PTN 08

Press ">" for EACH.

REFRAME PTN 08  
ALL/EACH EACH

Press the SD1 instrument pad.

REFRAME PTN 08  
EACH: SD1 1/96

Use the "<" and ">" keys to change the parameter to 1/4.

REFRAME PTN 08  
EACH: SD1 1/4

Press the ENTER key to complete the command.

REFRAME PTN 08  
EACH: SD1 READY

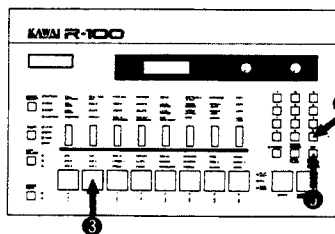

The ENTER and BACK keys go through the steps in the order indicated.

After reframing, the display automatically changes to the CALL PATTERN command. To listen to the results, simply press the START key.

**Note:** If the pattern is empty, pressing the ENTER key produces the error message EMPTY PATTERN. The command waits a few seconds and then asks you for a different pattern number.

**Sample V.**

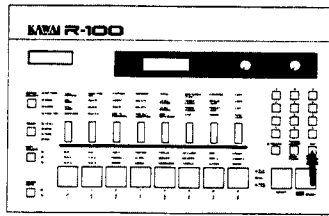
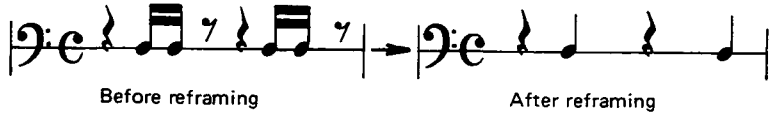

Select an empty pattern.

REFRAME      PTN 9 9

Press the ENTER key.

EMPTY PATTERN!

Return to the starting point.

REFRAME      PTN 9 9



## 7.2 SWING Command

The SWING command produces a shuffle feeling by introducing delays for the even notes in the pattern. There are six steps.

Parameter	Range	Default	<,>	Keypad?
Pattern number	00 ~ 99	/	Y	Y
ALL/EACH *1	ALL (<), EACH (>)	ALL	Y	N
SWING NOTE value	1/8, 1/16, 1/32	1/8	Y	N
SWING percentage	1/8 50, 54, 58, 63, 67 (1/16) 71, 75% 1/32 50, 58, 67, 75%	50%	Y	N
Instrument (EACH only)	BD1 ~ CHINA Any of the 24 built-in sound sources	BD1		Instrument pads 1-8
READY	Press the ENTER key to proceed, the BACK key to cancel.			

**Note:** Specifying ALL reframes all instruments in the pattern; EACH restricts the function to a single instrument.

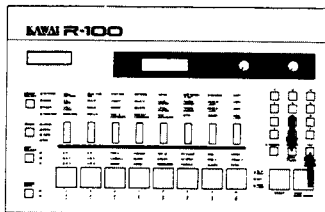

The ENTER and BACK keys switch through the steps in the order indicated.

Select the pattern number.

SWING PTN 00

Select ALL or EACH.

SWING PTN 00  
ALL/EACH ALL

Select the SWING NOTE value.

SWING PTN 00  
ALL 1/8

Press ">" for EACH.

SWING PTN 00  
ALL 50%

Select the instrument. (EACH only)

SWING PTN 00  
EACH: BD1 50%

Press ENTER to proceed.

SWING PTN 00  
EACH: BD1 READY

**Example:**

Changing the high hat quarter notes in Sample VI (assumed to be stored as No. 09) to a swing pattern.

**Procedure**

- (1) Press the fifth COMMAND SELECT key to activate the SWING command.
- (2) Type "0" and "9" on the keypad.
- (3) Press the "<" key for ALL.
- (4) Use the "<" and ">" keys to change the SWING NOTE value to 1/8.
- (5) Use the "<" and ">" keys to change the SWING Percentage to 67%.
- (6) Press the ENTER key when the message READY appears.

As with the REFRAME command, the SWING command automatically changes to the CALL PATTERN command. To listen to the results (See Sample VII.), simply press the START key. The SWING command not only produces shuffle effects, but also allows you to vary the swing rate between instruments to produce more authentically human effects.

**Note:** If the pattern is empty, pressing the ENTER key produces the error message EMPTY PATTERN. The command waits a few seconds and then asks you for a different pattern number.

Sample VI. (Pattern No. 09)

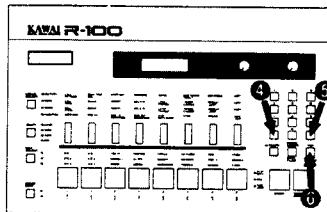
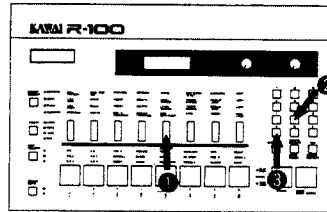
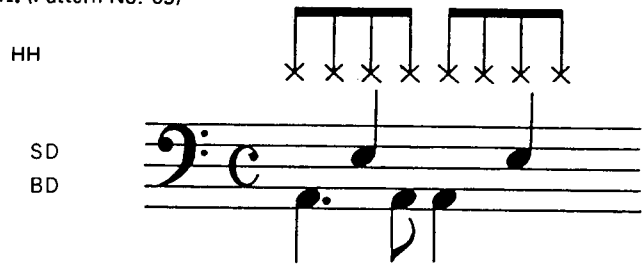

Type 09 on the keypad.

SWING PTN 09

Press "<" for ALL.

SWING PTN 09  
ALL/EACH ALL

Use the "<" and ">" keys to change the SWING NOTE value to 1/8.

SWING PTN 09  
ALL 1/8

Use the "<" and ">" keys to change the SWING percentage to 67%.

SWING PTN 09  
ALL 67%

Press the ENTER key to complete the command.

SWING PTN 09  
ALL READY

CALL PTN 09  
BAR 01 04/04

Sample VII.

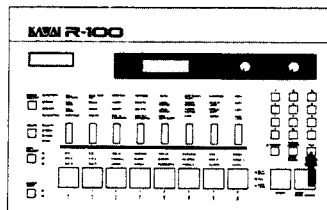
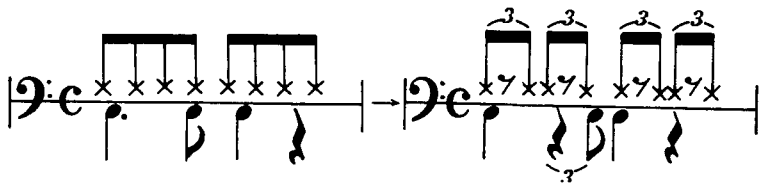

Select an empty pattern

SWING PTN 99

Press the ENTER key.

EMPTY PATTERN!

Return to the starting point.

SWING PTN 99

### 7.3 BAR PUNCH IN/OUT Command – Description

The BAR PUNCH IN/OUT command allows you to change part of a long pattern or add instruments using real-time recording. It takes you through six steps.

Parameter	Range	Default	<,>	Keypad?
Pattern number	00 ~ 99	/	Y	Y
PUNCH IN bar *1	01 ~ Last bar in pattern	**	Y	N
PUNCH OUT bar *1	PUNCH IN bar ~ Last bar in pattern	**	Y	N
Starting bar	01 ~ PUNCH IN bar	01	Y	N
Metronome note value	OFF, 1/4, 1/6, 1/8, 1/16, 1/24, 1/32	1/4	Y	N
ERROR CORRECT	1/4, 1/6, 1/8, 1/12, 1/16, 1/24, 1/32, 1/48, 1/64, 1/96, 1/192	1/16	Y	N

**Note:** Pressing the ERASE key instead of numbers for the PUNCH IN or PUNCH OUT bar changes the field to “\*\*\*”.

Once you have set the parameters, press the START key to begin recording.

**Note:** As with REALTIME recording, the BAR PUNCH command allows you to use the MULTI programming function to alter the TUNE and PAN settings for individual notes.

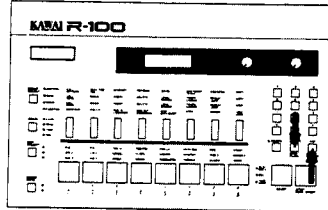

The ENTER and BACK keys switch through the steps in the order indicated.

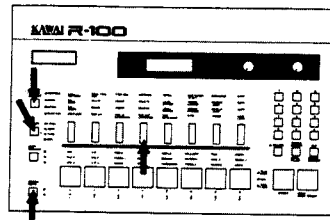

Select the pattern number.

```
PUNCH      PTN 20
BAR ***->*** 08-01
```

Select the PUNCH IN bar.

```
PUNCH      PTN 20
BAR **->*** 08-01
```

Select the PUNCH OUT bar.

```
PUNCH      PTN 20
BAR 04->04 08-01
```

Select the starting bar.

```
PUNCH      PTN 20
BAR 04->06 08-01
```

Select the metronome value.

```
METRONOME SELECT
1/4
```

Select the ERROR CORRECT value.

```
ERROR CORRECT
1/16
```

BAR PUNCH IN/OUT display

```
PUNCH      PTN 20
BAR 04->06 08-01
```

Press the MULTI key.

```
B S T T T H R C
1 1 1 H M L C 1 1
```

Adjust the parameters with the COMMAND SELECT keys.

```
B S T T T H R C
1 1 1 H M L C 1 1
```

Change instrument groups with the INST. SELECT key.

```
B S C C S H R C
2 2 B P H O 2 2
```

Press the GROUP SELECT key to return to recording.

```
PUNCH      PTN 20
BAR 04-06 08-05
```

## 7.4 BAR PUNCH IN/OUT Command — Example

To illustrate the procedure, add a fill-in to an eight-bar pattern stored as pattern No. 20.

- (1) Press the COMMAND SELECT (#6) key to activate the PUNCH IN/OUT command and type the pattern number (20).
- (2) Use the "<" and ">" keys to change the PUNCH IN bar to "04".
- (3) Use the "<" and ">" keys to change the PUNCH OUT bar to "05".
- (4) Use the "<" and ">" keys to change the starting bar to "04".
- (5) Turn the metronome off because the recorded pattern is sufficient to provide the timing.
- (6) Use the "<" and ">" keys to change the ERROR CORRECT parameter to 1/32.
- (7) Press the CONT. START key to start recording.

**Note:** Pressing the START key will take you to the very beginning of the pattern.

- (8) Press the STOP key to stop recording.

**Note:** As with the REALTIME REC. command, the BAR PUNCH IN/OUT command automatically returns to the beginning when you reach the end of the bar.

### An 8-bar pattern

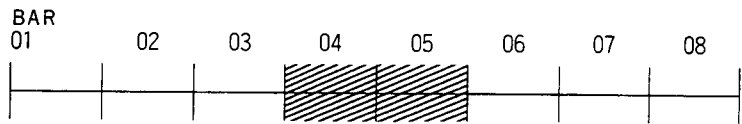

Add a fill-in here.

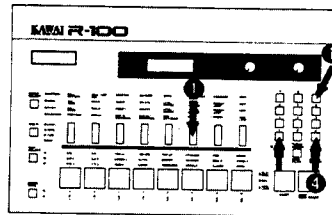

Access the PUNCH IN/OUT command.

```
PUNCH            PTN 20
BAR **→**      08-01
```

Use the "<" and ">" keys to change the PUNCH IN bar.

```
PUNCH            PTN 20
BAR 04→04      08-01
```

Use the "<" and ">" keys to change the PUNCH OUT bar.

```
PUNCH            PTN 20
BAR 04→05      08-01
```

Use the "<" and ">" keys to change the starting bar.

```
PUNCH            PTN 20
BAR 04→05      08-04
```

Use the "<" and ">" keys to turn the metronome off.

```
METRONOME SELECT
                  OFF
```

Use the "<" and ">" keys to change the ERROR CORRECT value to 1/32.

```
ERROR CORRECT
                  1/32
```

BAR PUNCH IN/OUT display

```
PUNCH            PTN 20
BAR 04-05      08-01
```

## 7.5 EXCHANGE Command

The EXCHANGE command allows you to exchange the contents of two patterns – for organizational purposes, for example. There are three steps.

Parameter	Range	Default	<,>	Keypad?
First pattern number	00 ~ 99	**	Y	Y
Second pattern number	00 ~ 99	**	Y	Y
READY				ENTER: Proceed, BACK:Cancel

**Note:** The only way to proceed from the first step to the second is to enter a number.

### Example:

- Press the COMMAND SELECT key (#7) to activate the EXCHANGE command.
- Select the pattern numbers with the keypad or the "<" and ">" keys next to it.
- Press the ENTER key to complete the command. (Press the BACK key to cancel.)

When the exchange is complete, the display automatically changes to the CALL PATTERN command. To listen to the results, simply press the START key.

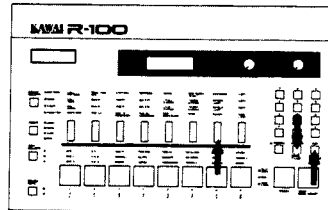

Select the first pattern number.

```
EXCHANGE
PTN 00 ↔ PTN **
```

Select the second pattern number.

```
EXCHANGE
PTN 00 ↔ PTN 50
```

Check specifications.

```
EXCHANGE READY
PTN 00 ↔ PTN 50
```

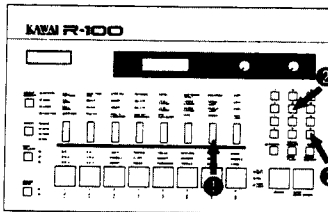

Select the EXCHANGE command.

```
EXCHANGE
PTN ** ↔ PTN **
```

Select the pattern numbers.

```
EXCHANGE
PTN 01 ↔ PTN **
```

```
EXCHANGE
PTN 01 ↔ PTN 55
```

Check specifications.

```
EXCHANGE READY
PTN 01 ↔ PTN 55
```

Press the ENTER key to complete.

```
CALL PTN 01
BAR 01 04 / 04
```

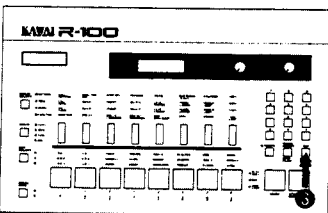

## 7.6 COPY Command

The COPY command allows you to copy and join patterns so that you can edit the result rather than starting from scratch. There are four steps.

Parameter	Range	Default	<, >	Keypad?
First pattern number	00 ~ 99	**	Y	Y
Second pattern number	00 ~ 99	**	Y	Y
Third pattern number	00 ~ 99	**	Y	Y
READY				ENTER: Proceed, BACK:Cancel

**Note:** The only way to proceed from the first step to the second is to enter a number. This restriction does not apply between the second and third steps because you are allowed to give a null specification ("\*\*") for the second field.

### Error Messages

In certain cases, the copy will fail and produce an error message instead:

**ILLEGAL INPUT** – In linking two patterns, you have either (1) specified two with different time signatures or (2) tried to create a pattern that is more than 99 bars long.

**MEMORY OVERFLOW** – There is not enough memory space left to store the result.

The message remains on the display for a few seconds.

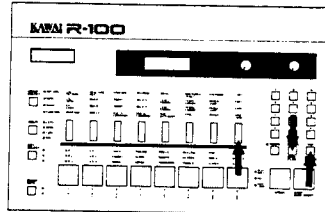

The ENTER and BACK keys switch through the steps in the order indicated.

You can double the length of a pattern by linking two copies onto the original. (See illustration.)

```
COPY
PTN 00 + 00 = 00
```

Example: Simple copy

```
COPY
PTN 00 + ** = 55
```

Example: Linking operation

```
COPY
PTN 00 + 01 = 03
```

Select the first pattern number.

```
COPY
PTN 00 + ** = **
```

Select the second pattern number.

```
COPY
PTN 00 + 01 = **
```

Select the third pattern number.

```
COPY
PTN 00 + 01 = 02
```

Check specifications.

```
COPY READY
PTN 00 + 01 = 02
```

End in CALL PATTERN command.

```
CALL PTN 02.
BAR 04 04/04
```

```
ILLEGAL INPUT!!
```

```
MEMORY OVERFLOW
```

# 8. Playing Songs and Chains

## 8.1 Selecting a Song or Chain for Playback

The CALL commands, CALL SONG and CALL CHAIN, allow you to specify what is to be played. As with the CALL PATTERN command, they are automatically activated when you change the group with the GROUP SELECT key.

To play a song or chain, first change the number with the keypad or the "<" and ">" keys and then press the START key.

The second line of the display gives four pieces of information: the total number of segments – patterns or songs, respectively, for songs and chains – in the sequence, the sequence number of the current segment, the name of the segment (PTN/SONG), and the storage number of the current unit.

If you use the STOP key to interrupt the playback, pressing the CONT. START key will resume where playback was interrupted; pressing the START key will play from the beginning of the entire sequence. You can also change the current segment before continuing.

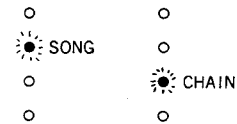
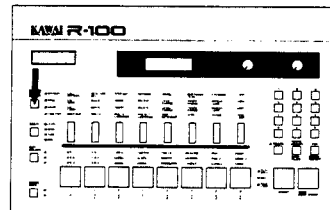

Example: CALL SONG

```
CALL SONG 00
DANCIN' FOO'
```

Example: CALL CHAIN

```
CALL CHAIN 0
KAWAI R-100 DEMO
```

Typical display during SONG playback:

```
PLAY SONG 00
013-002 = PTN 13
```

Typical display during CHAIN playback:

```
PLAY CHAIN 0
005-002 = SONG 01
```

```
PLAY SONG 00
013-008 = PTN 17
```

```
PLAY CHAIN 0
005-003 = SONG 02
```

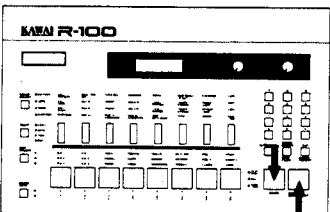
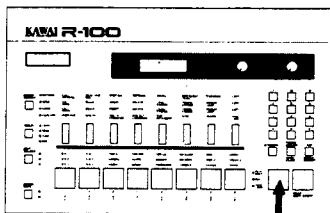

## 8.2 Specifying the Starting Point

The CALL commands allow you to specify the starting point relative to the entire sequence. Simply press the ENTER KEY once to shift the cursor to the second field in the second line and then use the "<" and ">" to change the number. To start the playback, press the CONT. START key.

**Note:** Do not press the START key as it starts at the beginning of the entire sequence.

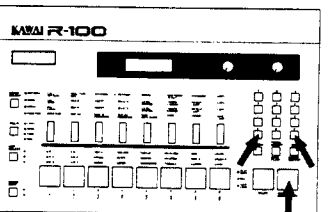
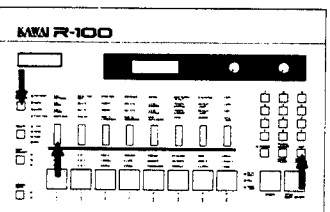

Select the starting pattern for the song.

```
CALL SONG 00
013-001 = PTN 10
```

Select the starting song for the chain.

```
CALL CHAIN 0
005-001 = SONG 00
```

Use the "<" and ">" to change the number. Press the CONT. START key to start the playback.

```
PLAY SONG 00
013-002 = PTN 13
```

# 9. Erasing a Song or Chain

## 9.1 Types of Erasures

The R-100 offers you a choice of two types of erasures at both the song and chain levels:

- (1) Erase one particular song or chain.
- (2) Erase all songs or chains.

Confirmation messages:

```
SONG 00  
ERASE  READY
```

```
CHAIN 0  
ERASE  READY
```

```
ALL SONG  
ERASE  READY
```

```
ALL CHAIN  
ERASE  READY
```

## 9.2 Erasing a Particular Song or Chain

- (1) Activate any command except COPY.
- (2) Specify the song or chain number.
- (3) Press the ERASE key.
- (4) When the message ERASE READY appears on the second line of the display, press the ENTER key to complete. (Press the BACK key to cancel.)

**Note:** A few seconds later, the original display reappears.

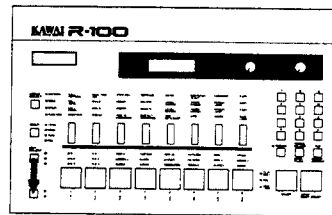

```
CALL  SONG 00  
DANCIN' FOO'
```

Press the ERASE key.

```
SONG 00  
ERASE  READY
```

Press the BACK key.

```
SONG 00  
ERASE  CANCEL
```

```
CALL  SONG 00
```



### 9.3 Erasing All Songs or Chains

- (1) Simultaneously press the first COMMAND SELECT key and the ERASE key.
- (2) When the message ERASE READY appears, press the ENTER key to complete. (Press the BACK key to cancel.)

**Note:** A few seconds later, the display reverts to the corresponding CALL command.

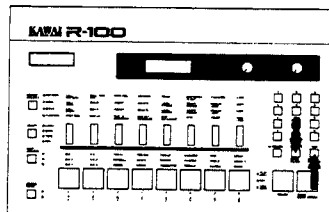
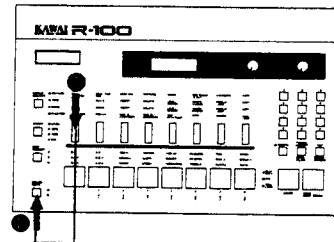

CALL CHAIN 0  
KAWAI R-100 DEMO

Simultaneously press the first  
COMMAND SELECT key and the  
ERASE key.

ALL CHAIN  
ERASE READY

Press the BACK key.

ALL CHAIN  
ERASE CANCEL

CALL CHAIN 0

# 10. Songs and Chains – General

## 10.1 BUILD Commands

The BUILD commands, BUILD SONG and BUILD CHAIN, allow you to join up to 999 smaller units to form longer playback sequences and to edit the sequences.

### SONG BUILD

```
BUILD SONG 00
DANCIN' FOO'
```

### CHAIN BUILD

```
BUILD CHAIN 0
KAWAI R-100 DEMO
```

## 10.2 BUILD – Parameters

They have four steps:

Parameter	Range	Default	<>	Keypad?
Song/chain number	Song : 00 ~ 99 Chain : 0 ~ 9	/	Y	Y
Title	A~Z, 0~9, ., , " ' : ; , * + , - / , α , β , ? , ! , π , # , \$ , % , & , ¥ , < , > , → , ← , = , ↓	/	Y	Y Only digits are available. At this point, the ERASE key yields a space.
Tempo (Chain only)	OFF, 40 ~ 250	OFF	Y	N
Pattern/chain numbers *1	Pattern } 00 ~ 99 Song }	**	Y	Y

- Notes:**
- The CHAIN BUILD ignores a song if it is empty. Pressing the ENTER key after the number only produces the warning message EMPTY SONG.
  - When you erase any of the song in a chain, it stops playback at that point.

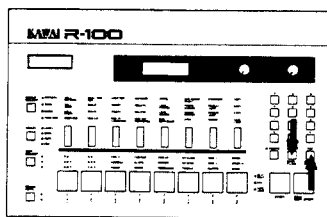

The ENTER and BACK keys switch through the steps in the order indicated. They also change the cursor position in the title.

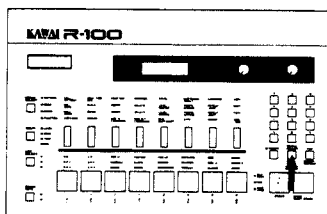

At this point, the BACK key skips the tempo and title entry steps and takes you right back to the first step.

Select the song or chain number.

```
BUILD SONG 10
```

Enter the title using <&> keys to select the characters.

```
BUILD SONG 10
```

Select the tempo. (Chain only)

```
BUILD CHAIN 0
      = OFF
```

Select the segment number (pattern or song).

```
BUILD SONG 09
001-001 = PTN **
```

```
BUILD CHAIN 0
KAWAI R-100 DEMO
```

Press the BACK key.

```
BUILD CHAIN 0
005-001 = SONG 00
```

### 10.3 Example: Building a Song

The following procedure builds an eight-bar song by combining four different single-bar patterns:

- (1) Select the SONG group and press the BUILD COMMAND SELECT key.
- (2) Enter (keypad) or change (" $<$ " and " $>$ " keys) the song number (09). Press ENTER to store.
- (3) Enter the title, using the " $<$ " and " $>$ " keys. Press ENTER to advance to the next character.
- (4) Enter or change the pattern number. Press ENTER to store.

**Note:** At this point, you can press the START key to check the pattern. To return to the BUILD command, simply press the STOP key.

- (5) Repeat step 4 until you reach the end of the song.
- (6) To edit the BUILD command, press the CALL SONG command key.

At this point, you can press the START key to review the results.

SONG 09 「NORMAL 8 BEAT」

PART

001	002	003	004	005	006	007	008
00	01	00	02	00	03	00	01

PTN

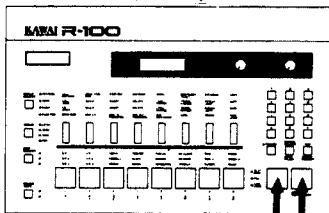
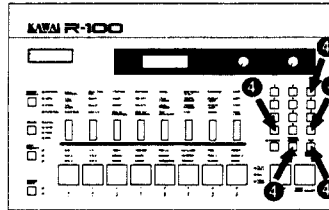
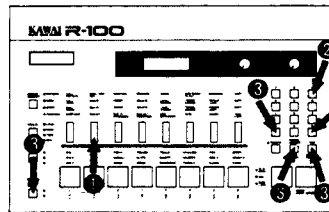

Select the song number.

```
BUILD SONG 09
```

Enter the title.

```
BUILD SONG 09
NORMAL 8 BEAT
```

Select a pattern number.

```
BUILD SONG 09
001-001 = PTN **
```

Use the " $<$ ", " $>$ ", and digital keys.

```
BUILD SONG 09
004-004 = PTN 02
```

Press the ENTER key to store.

```
BUILD SONG 09
008-008 = PTN 03
```

Press the ENTER key a second time to terminate the BUILD command.

```
BUILD SONG 09
009-009 = PTN **
```

```
BUILD SONG 09
NORMAL 8 BEAT
```

Press the START key.

```
PLAY SONG 09
008-001 = PTN 00
```

## 10.4 Example: Editing a Song with BUILD

The following procedure changes part of the SONG No. 09 stored in the preceding section.

(1) Activate the SONG BUILD command and press the BACK key to jump immediately to the pattern number entry step.

(2) Press the ENTER key until the second number on the second line is "004".

**Note:** Holding down the ENTER key will provide continuous updating, but be careful not to go past the "\*" at the end and terminate the command.

(3) Enter (10-key digital pad) or change ("<" and ">" keys) the song number (04).

(4) Press ENTER to store.

**Note:** It is not necessary to advance to the end of the song. Simply press another COMMAND SELECT key to terminate the BUILD command.

SONG 09 「NORMAL 8 BEAT」

PART

001	002	003	004	005	006	007	008
00	01	00	02	00	03	00	01

PTN

Change this to "04".

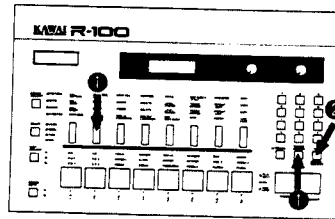

Press the second COMMAND SELECT key.

```
BUILD SONG 09
NORMAL 8 BEAT
```

Press the BACK key.

```
BUILD SONG 09
008-001 = PTN 00
```

Press the ENTER key until the "004" appears.

```
BUILD SONG 09
008-004 = PTN 02
```

```
BUILD SONG 09
008-004 = PTN 04
```

Don't forget to press the ENTER key to store the new value!

```
BUILD SONG 09
008-005 = PTN 00
```

You may now switch to another command.

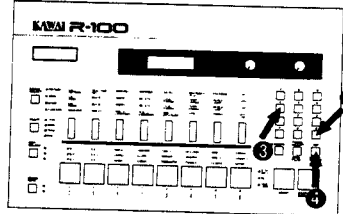

# 11. Songs and Chains

## – Additional Commands

### 11.1 INSERT Commands

The INSERT commands, INSERT SONG and INSERT CHAIN, allow you to splice a new segment (pattern or song) into an existing sequence. To activate, select the appropriate group and press the third COMMAND SELECT key (INSERT). The command then takes you through three steps:

Parameter	Range	Default	<>	Keypad?
Song/chain number	Song : 00 ~ 99 Chain : 0 ~ 9	/	Y	Y
Insert location	000^001~nnn-1^nnn nnn= Last segment in sequence.	000^001	Y	N
Insert pattern/chain number **	Song } 00 ~ 99 Chain }	**	Y	Y At this point, the ERASE key yields "**", the signal to cancel the insertion.

#### Example:

The following procedure inserts pattern No. 10 between the fifth and sixth patterns of song No. 09:

- (1) Access the command and enter (10-key digital pad) or change (" $<$ " and " $>$ " keys) the song number (09). Press ENTER.
- (2) Select the location with the " $<$ " and " $>$ " keys.
- (3) Enter or change the pattern number.
- (4) Press ENTER to complete the insertion and return to the beginning of the command.

**Note:** Check the total (the first number in the second row).  
It is now one greater than before.

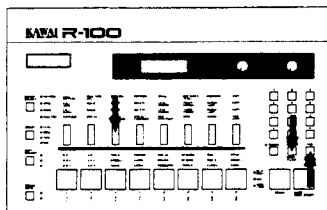

The ENTER and BACK keys switch through the steps in the order indicated.

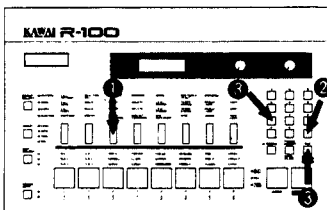

Select the song or chain number.

```
INSERT SONG 00
013-001 = PTN 10
```

```
INSERT CHAIN 0
005-001 = SONG 00
```

Select the location.

```
INSERT SONG 00
000^001 = PTN **
```

Select the pattern or song.

```
INSERT SONG 00
002^003 = PTN **
```

```
INSERT CHAIN 0
003^004 = SONG **
```

Select the song number (09).

```
INSERT SONG 09
008-001 = PTN 00
```

Select the location (005^006).

```
INSERT SONG 09
005^006 = PTN **
```

Select the pattern (10).

```
INSERT SONG 09
005^006 = PTN 10
```

Press the ENTER key.

```
INSERT SONG 09
009-001 = PTN 00
```

## 11.2 DELETE Commands

The DELETE commands, DELETE SONG and DELETE CHAIN, allow you to remove segments (patterns or songs) from an existing sequence. To access, select the appropriate group and press the COMMAND SELECT key (#4). The command takes you through four steps:

Parameter	Range	Default	<,>	Keypad?
Song/chain number	Song : 00 ~ 99 Chain : 0 ~ 9		Y	Y
Starting location	001 ~ Last segment	...	Y	N
End location	Starting location ~ Last segment	...	Y	N
READY	Press the ENTER key to proceed, the BACK key to cancel.			

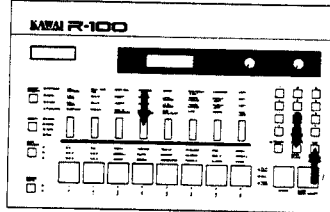

The ENTER and BACK keys switch through the steps in the order indicated.

Select the song or chain number.

```
DELETE SONG 00
013-001 = PTN 10
```

```
DELETE CHAIN 0
005-001 = SONG 00
```

Select the starting location.

```
DELETE SONG 00
001:10 - 001:10
```

Select the end location.

```
DELETE SONG 00
001:01 - 004:13
```

Check the specifications.

```
DELETE READY 00
001:10 - 004:13
```

Press BACK to cancel.

```
DELETE CANCEL 00
001:10 - 004:13
```

**Example:**

The following procedure deletes four patterns (in locations 003-006) from song No. 09:

- (1) Activate the command and enter (with the key pad) or change ("<" and ">" keys) the song number (09). Press ENTER.
- (2) Select the starting location (003) with the "<" and ">" keys.
- (3) Select the ending location (006) with the same keys.
- (4) When the message DELETE READY appears, press ENTER to complete the deletion or BACK to cancel.

**Note:** A few seconds later, the display returns to the beginning of the DELETE command. If you pressed the ENTER key, the total (the first number in the second row) should now be smaller than before.

<SONG 09>

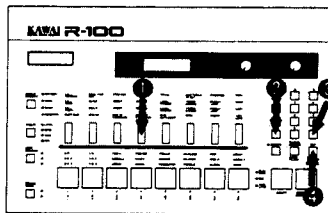
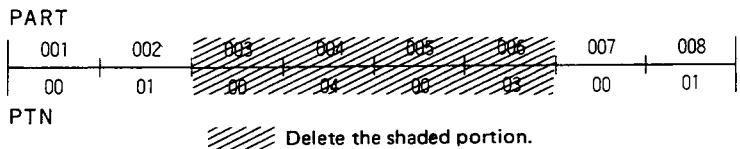

Select the song number (09).

```
DELETE SONG 09
008-001 = PTN 00
```

Select the starting location (003).

```
DELETE SONG 09
003:00 - 003:00
```

Select the end location (006).

```
DELETE SONG 09
003:00 - 006:03
```

```
DELETE READY 09
003:00 - 006:03
```

Press the ENTER key.

```
DELETE SONG 09
004-001 = PTN 00
```

Song No. 09 after the deletion:

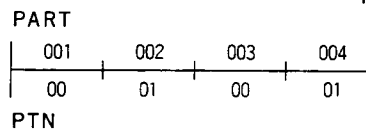

Note that the total number of patterns in the song has decreased from 8 to 4.

### 11.3 LEVEL CHANGE Commands

The LEVEL CHANGE commands, LEVEL CHANGE SONG and LEVEL CHANGE CHAIN, allow you to change the output levels between segments (patterns or songs) in a sequence. To activate, select the appropriate group and press the fifth COMMAND SELECT key (LEVEL CHANGE). The command takes you through three steps:

Parameter	Range	Default	<,>	Keypad?
Song/chain number	Song : 00 ~ 99 Chain : 0 ~ 9	/	Y	N
Location	Location:		Press the ENTER key for next bar, the BACK key for the previous one.	
Change in level	00 ~ Last ± 50	001 0	Y	N

#### Example:

The following procedure introduces level changes between the four patterns left in song No. 09:

- (1) Activate the command and enter (keypad) or change (" $<$ " and " $>$ " keys) the song number (09). Press ENTER.
- (2) Use the arrow keys to lower the level to " $-30$ " at the beginning of the sequence.
- (3) Similarly, increase the level to " $+10$ " for the other three patterns.
- (4) Press ENTER to complete the command.

**Note:** After you specify a level change for the last pattern, the display automatically returns to the beginning of the LEVEL CHANGE command. You may now press the START key to review the results.

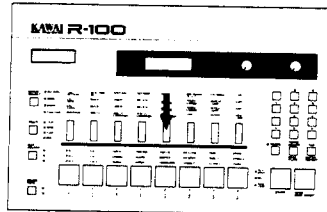

Select the song number.

L. CHANGE SONG 09  
013-001 = PTN 10

Select the chain number.

L. CHANGE CHAIN 0  
005-001 = SONG 00

The ENTER and BACK keys switch through the steps in the order indicated and then through the segments.

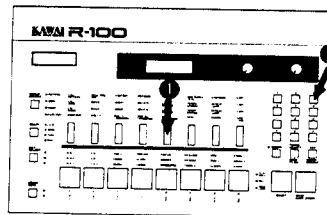

Select the song number (09).

L. CHANGE SONG 09  
004-001 = PTN 00

Select a change of " $-30$ " for the first segment.

L. CHANGE SONG 09  
004-001 = -30

Select a change of " $+10$ " for the second segment.

L. CHANGE SONG 09  
004-002 = +10

Select a change of " $+10$ " for the third segment.

L. CHANGE SONG 09  
004-003 = +10

Select a change of " $+10$ " for the fourth segment.

L. CHANGE SONG 09  
004-004 = +10

Press the ENTER key.

L. CHANGE SONG 09  
004-001 = PTN 00

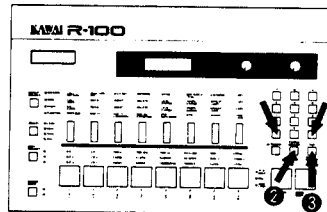

<SONG 09>

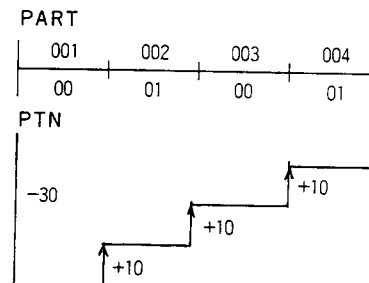



**Note:**

Certain situations limit the full range of the LEVEL CHANGE function:

- (a) A repeating increasing or decreasing sequence,
- (b) Instruments that are already at their maximum levels, and
- (c) A sequence recorded with maximum velocity or with the touch sensitivity set to zero.

One way to ensure adequate room for maneuvering is to add a drop before any series of rises.

### 11.4 TEMPO CHANGE Commands

The TEMPO CHANGE commands, TEMPO CHANGE SONG and TEMPO CHANGE CHAIN, allow you to change the tempo between segments (patterns or songs) in a sequence. The one for chains also allows you to specify the initial tempo — for even more pronounced effects. At each point, you can slow down (retardando) or speed up (accelerando) the tempo by up to 99 beats per minute. To activate the command, select the appropriate group and press the COMMAND SELECT key (#6). The command takes you through three (four for a chain) steps:

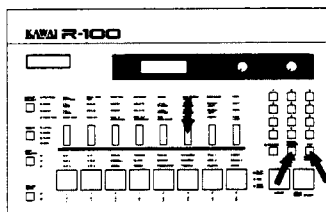

Select the song number.

T. CHANGE SONG	00
013-001 =	PTN 00

Select the chain number.

T. CHANGE CHAIN	0
004-001 =	SONG 00

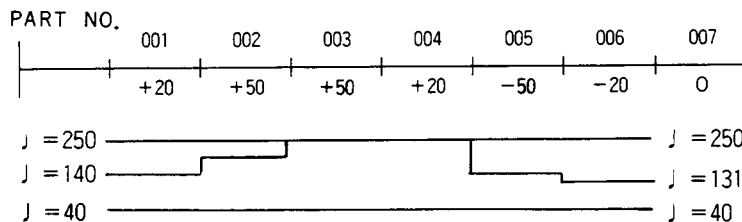

Parameter	Range	Default	<,>	Keypad?
Song/chain number	Song : 00 ~ 99 Chain : 0 ~ 9		Y	Y
Initial tempo (Chain only)	= OFF, 40 ~ 250		Y	N
Location	001 ~ Last	001	Y	N
Change in tempo	± 50 b.p.m.	0	Press the ENTER key for next bar, the BACK key for the previous one.	

**Example:**

The following procedure introduces tempo changes between the four patterns in song No. 09:

- (1) Access the command and enter (keypad) or change (" $<$ " and " $>$ " keys) the song number (09). Press ENTER.
- (2) Press the ENTER key until the second number on the second line reads "003".
- (3) Use the arrow keys to lower the tempo to "-20" for both "003" and "004".
- (4) Press ENTER to complete the command.

**Note:** The display automatically returns to the beginning of the TEMPO CHANGE command. You may now press the START key to review the results.

**Note:** The TEMPO CHANGE function cannot change the tempo beyond the R-100's range of 40-250 bpm.

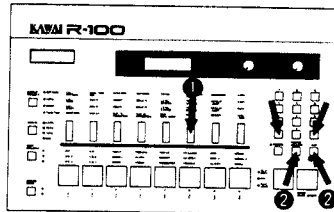

Select the song number (09).

```
T. CHANGE SONG 09
004-001 = PTN 00
```

Select a change of "-20" for the third segment.

```
T. CHANGE SONG 09
004-003 = -20
```

Select a change of "-20" for the fourth segment.

```
T. CHANGE SONG 09
004-004 = -20
```

Press the ENTER key.

```
T. CHANGE SONG 09
004-001 = PTN 00
```

## 11.5 REPEAT/JUMP Commands — Description

The REPEAT/JUMP commands, REPEAT/JUMP SONG and REPEAT/JUMP CHAIN, allow you to repeat or skip over certain sections in a sequence. As such, they expand the musical notation available to you to include the repeat signs (||: and :||), D.S. (dal segno), and coda. You may use up to ten of each (labelled R0-R9 and J0-J9) per song or chain. To access the command, select the appropriate group and press the COMMAND SELECT key (#7). The command takes you through five steps:

Parameter	Range	Default	<.>	Keypad?
Song/chain number	Song : 00 ~ 99 Chain : 0 ~ 9		Y	Y
REPEAT or JUMP	REPEAT, JUMP	RE-PEAT	Y	N
			Press the "<" key for REPEAT, the ">" key for JUMP.	
REPEAT	Starting point ("FROM")	001 ~ Last	***	Y
	Ending point ("TO")	Starting point ~ Last Last	***	Y
	Count	01 ~ 99	**	Y
JUMP	Starting point ("FROM")	001 ~ Last	***	Y
	Ending point ("TO")	001 ~ Last	***	Y
	Count	01 ~ 99	**	Y

In all steps except the first two, pressing the ERASE key clears the field to "\*\*\*". It used to cancel value or commands.

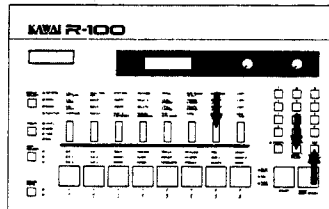

### Notes:

- The REPEAT command requires that the number in the "TO" field be greater than the one in the "FROM" field. There is no such restriction for the JUMP command.
- The count for the REPEAT command sets the number of repeats for the specified section after playing it the first time. A count of n therefore plays the n+1 section times. A count of "00" plays once through only.
- The count for the JUMP command, on the other hand, sets which playing of the "from" segment will the jump occur. This is useful when a section including the "from" segment is repeated a number of times before the jump is to occur. A count of "φ1" means the jump will occur the first time it is encountered. A count of "φ2" means the jump will be ignored the first time through.
- To eliminate a REPEAT/JUMP command, clear the count field to "\*\*\*" by pressing the ERASE key and then press the ENTER key. The command automatically renumbers the subsequent REPEAT or JUMP sections.
- In case the same ending point is used for two or more REPEAT commands, the R-100 works as the example shown at the right.
- When the REPEAT and JUMP commands appear at the same segment, the R-100 ignores the latter one.

Select the song number.

```
REP/JUMP SONG 00
013-001 = PTN 10
```

Select the chain number.

```
REP/JUMP CHAIN 0
005-001 = SONG 00
```

Select REPEAT or JUMP.

```
REP/JUMP SONG 00
REPEAT
```

Select the starting point (01) for the REPEAT command.

```
REPEAT SONG 00
R0: Fr 001 To 001: **
```

Select the ending point (04) for the REPEAT command.

```
REPEAT SONG 00
R0: Fr 001 To 004: **
```

Select the count (01) for the REPEAT command.

```
REPEAT SONG 00
R0: Fr 001 To 004: 01
```

Select the starting point (09) with the cursor on the "count" parameters, for the JUMP command.

```
JUMP SONG 00
J0: Fr 009 To ***: **
```

Select the ending point (01) for the JUMP command.

```
JUMP SONG 00
J0: Fr 009 To 001: **
```

Select the count (02) for the JUMP command.

```
JUMP SONG 00
J0: Fr 009 To 001: 02
```

```
REPEAT SONG 00
R0: Fr 004 To 005: 03
```

```
REPEAT SONG 00
R1: Fr 004 To 005: 05
```

Playback  
003 ~ 005: three times  
004 ~ 005: three times

```
REPEAT SONG 00
R0: Fr 003 To 005: 02
```

```
JUMP SONG 00
J0: Fr 005 To 001: 01
```

**ELIMINATING A REPEAT OR JUMP.**

```
REPEAT SONG 00
R0:Fr009To001:02
```

Press the ERASE key.

```
REPEAT SONG 00
R0:Fr009To001:**
```

Press the ENTER key to eliminate the current REPEAT (R0).

```
REPEAT SONG 00
R1:Fr***To***:**
```

The displays change as follows:

```
REPEAT SONG 00
R0:Fr***To***:**
```

R1 becomes blank:

```
REPEAT SONG 00
R0:Fr004To010:03
```

The old R1 moves to R0.

**Example (REPEAT):**

The REPEAT shown at the right changes the original 8-pattern song into a 13-pattern one: 001, 002, 003, 004, 005, 006, 002, 003, 004, 005, 006, 007, 008.

**Example (JUMP):**

The JUMP shown at the right adds an alternate ending to the above REPEAT; 001, 002, 003, 004, 005, 006, 002, 003, 004, 007, 008.

```
REPEAT SONG 05
R0:Fr002To006:01
```

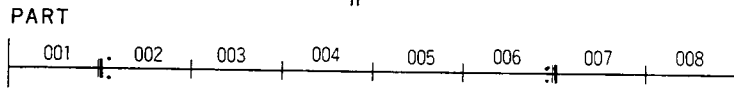

```
JUMP SONG 05
J0:Fr004To007:02
```

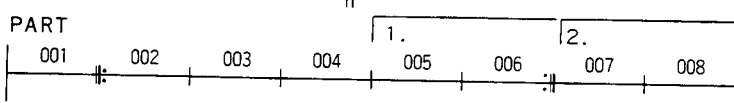

## 11.6 REPEAT/JUMP Commands – Example

The following example uses the REPEAT and JUMP commands to create the rhythm pattern shown at the right as Song No. 10:

- (1) Use the BUILD SONG command to link the thirty patterns into a linear sequence.
- (2) Access the REPEAT/JUMP command with the COMMAND SELECT key (#7) and enter the specifications for the three repeated sections.

Repeat #	FROM	TO	Count
R0	001	002	3
R1	011	022	1
R2	027	028	4

(See displays at right.)

**Remember:** The section always plays at least once, so the count is the number of repeats, after the initial playing.

Jump #	FROM	TO	Count
J0	026	015	01

(See displays at right.)

- (3) Next, create the D.S. after pattern 026, using a JUMP from 026 to 015.
- (4) Finally, create the coda. The only problem here is the count. You want the machine to play pattern 019 once for the repeat and again for the D.S. The jump therefore must not occur until the third time through.

Jump #	FROM	TO	Count
J1	019	027	03

(See displays at right.)

At this example shows, the REPEAT/JUMP commands allow you to handle even the most complicated rhythm combinations.

SONG 10  
PART NO.  
R0

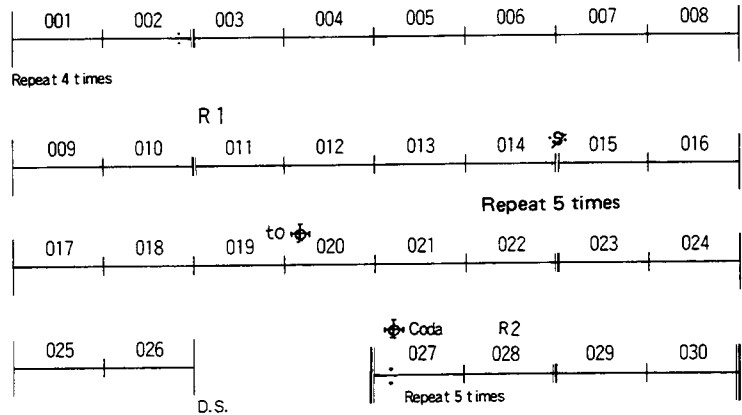

"Play XX times" means play the number of times specified.

D.S. (dal segno) means continue from the sign ♯.

"To (to)" means finish with the coda (Coda).

R 0

```
REPEAT SONG 10
R0:Fr001To002:03
```

R 1

```
REPEAT SONG 10
R1:Fr011To022:01
```

R 2

```
REPEAT SONG 10
R2:Fr027To028:04
```

J 0

```
JUMP SONG 10
J0:Fr026To015:01
```

J 1

```
JUMP SONG 10
J1:Fr019To027:03
```

**Notes:**

1. Clearing only one of the "FROM" or "TO" fields is sufficient to cancel the REPEAT/JUMP command.
2. The machine automatically adjusts the "FROM" and "TO" fields whenever you use the INSERT or DELETE commands.
3. The repetition covers not only the individual segments (patterns or songs), but also any LEVEL CHANGE or TEMPO CHANGE specifications associated with them. You must therefore check the results carefully to make sure that such combinations do not produce undesirable side-effects.
4. If you press the CONT. START key, the machine continues from the first repetition of the particular segment.

**11.7 COPY Commands**

The COPY commands, COPY SONG and COPY CHAIN, allow you to copy a song or chain to another location so that you can edit the result rather than starting from scratch. To access, select the appropriate group and press the COMMAND SELECT key (#8). The command takes you through three steps:

Parameter	Range	Default	<.>	Keypad?
Song/chain number (source)	Song : 00 ~ 99 Chain : 0 ~ 9	** (*).	Y	Y
Song/chain number (destination)	Song : 00 ~ 99 Chain : 0 ~ 9	** (*).	Y	Y
READY	Press the ENTER key to proceed, the BACK key for the previous field.			

**Error Message**

In certain cases, the copy will fail and produce the error message MEMORY OVERFLOW instead. This message tells you that there is not enough memory space left to store the result. Free some space by deleting unnecessary chains or songs.

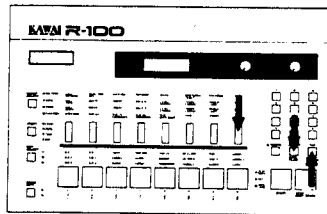

The ENTER and BACK keys switch through the steps in the order indicated. In particular, pressing the BACK key when the message COPY READY appears takes you back to the destination specification step.

Select the source.

```
COPY
SONG  *_ = **
```

Select the source.

```
COPY
CHAIN * = *
```

Select the destination.

```
COPY
SONG 00 = **
```

Check the specifications.

```
COPY
CHAIN 0 = *
```

Check the specifications.

```
COPY READY
SONG 00 = 90
```

```
COPY READY
CHAIN 0 = 9
```

Return to CALL command.

```
CALL CHAIN 9
ROCK' N ROLLS
```

# 12. Editing a Song or Chain with the OVERDUB Command

## 12.1 OVERDUB Command – Description

The OVERDUB command allows you to record one instrument as part of the song or chain – this is very useful for creating variations in an otherwise repeating pattern. To access, select the FUNCTION group and press the COMMAND SELECT key (#1). The command takes you through five steps:

Parameter	Range	Default	<,>	Keypad?
SONG or CHAIN	SONG/CHAIN	SONG	Y	N
Song/chain number	Song : 00 ~ 99 Chain : 0 ~ 9		Y	Y
Starting location	001 ~ Last	001	Y	N
Instrument	SD1 ~ CHINA (One of the 24 instruments)	CRS1		Instrument pads 1-8
ERROR CORRECT	1/4, 1/6, 1/8, 1/12 1/16, 1/24, 1/32, 1/48 1/64, 1/96, 1/192	1/16	Y	N

After completing the specifications, press either the START key (to start at the beginning of the song or chain) or the CONT. START (to start at the “starting location”).

**Note:** At this point, all eight instrument pads are connected to the same sound source. To delete a note, however, you must use the one with the appropriate label.

The recording stops automatically when the song or chain reaches the end and the message END SONG or END CHAIN appears on the display. You can also stop at an intermediate point simply by pressing the STOP key. In either case, the command then returns you to the first step: choosing SONG or CHAIN.

As with REALTIME recording, you can set tuning and panning for each note in the OVERDUB track.

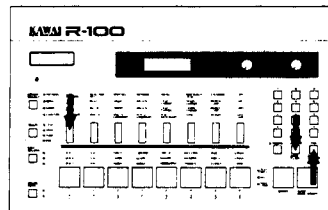
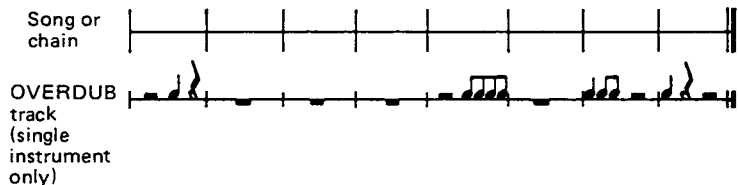

The ENTER and BACK keys switch through the steps in the order indicated.

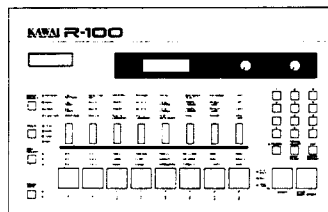

You can use all eight instrument pads to record.

The values of TUNE and PAN automatically depend upon each instrument pad.

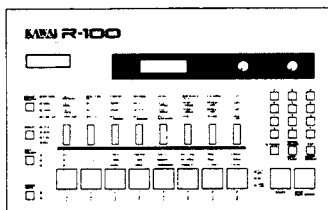

To erase, however, you must use the ERASE key and the one with the label for that instrument.

Select SONG or CHAIN.

OVERDUB SONG \*\*

Select the song number.

OVERDUB SONG 00  
DANCIN' FOO'

Select the starting location.

OVERDUB SONG 00  
013-001 CRS1

Select the instrument.

OVERDUB SONG 00  
013-001 CRS1

OVERDUB SONG 00  
E. CORRECT 1/16

Begin overdubbing.

OVERDUB SONG 00  
013-001 CRS1

Reach the end.

END SONG

Return to the first step.

OVERDUB SONG \*\*

## 12.2 OVERDUB Command – Example

The following procedure shows how you can use the OVERDUB command to simplify song construction.

You may find yourself using the drum machine for a rhythm sequence such as the one shown at the right. Each bar uses the same basic pattern for the snare drum, bass drum, high hat, etc., and only the position of the cymbal crashes changes. Although the COPY command makes it easy to develop the variations from the original, the process still takes time, and you have to then combine the individual patterns into a song. The OVERDUB command provides an alternative: First, you record the basic sequence and then you add the cymbal crashes as a separate track. (See second score at right.)

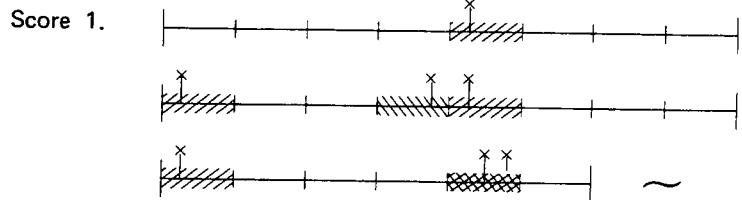

The three shaded bars share the same basic rhythm pattern as the others and differ only in the placement of the cymbal crashes. One approach would be to construct separate a pattern for each. Alternatively, you can use the OVERDUB command to separate the basic rhythm from the cymbal crashes.

Score 2.

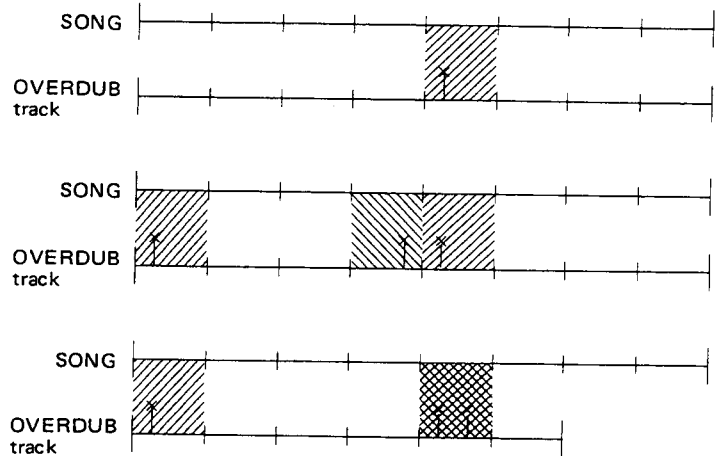



If the basic rhythm remains constant throughout, the REPEAT/JUMP command allows you to repeat the basic sequence for the bulk of the song – in this example, 15 times – and a second one for the last bar. (See third score and display at right.) You can then use the OVERDUB command to add the cymbal crashes.

**Note:** The OVERDUB track is linear and completely separate from the song (or chain). It gets longer with every repetition in the original, so the net effect is the same as if the original were completely linear – that is, without repetitions or jumps.

**WARNING:**

Notes recorded using the OVERDUB command use twice as much memory as those recorded in a PATTERN. Excessive use of the OVERDUB command can limit the amount of space to store other patterns, songs, and chains.

**Score 3.**

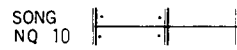

15 times  
Repeat  
↓

This song produces  
this result:

```
CALL      SONG 10
002-001 = PTN 00
```

```
REPEAT   SONG 10
R0:Fr001To001:14
```

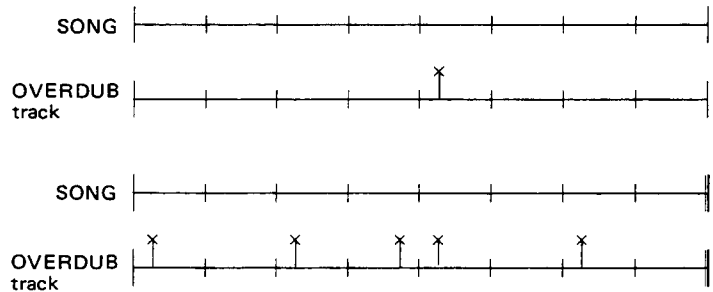

## 12.3 Erasing the OVERDUB Track

The ERASE key erases the entire OVERDUB track.

### Procedure:

- (1) Access the OVERDUB command.
- (2) Select whether SONG or CHAIN, then the song or chain number.
- (3) Press the ERASE key.
- (4) When the message ERASE READY appears, press the ENTER key to proceed, the BACK key to cancel.

- Notes:**
- In either case, you return to the first step of the OVERDUB command.
  - You can change instruments, without erasing the OVERDUB track. The track will now be played by the new instrument.

### WARNING:

The R-100 automatically erases the OVERDUB track if you use any command – INSERT, DELETE, or REPEAT/JUMP – that changes length and therefore destroys the synchronization.

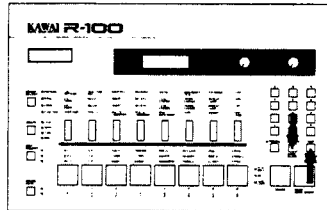
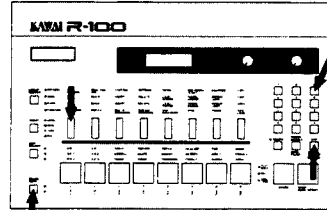

Select SONG or CHAIN.

```
OVERDUB  SONG  **
```

Select song or chain number.

```
OVERDUB  SONG  09
NORMAL 8 BEAT
```

Press the ERASE key.

```
OVERDUB  SONG  09
ERASE  READY
```

Press the ENTER key.



Return to the start of the OVERDUB command.

```
OVERDUB  SONG  **
```

# 13. MIDI Operation

## 13.1 The MIDI Interface

The letters MIDI stand for the Musical Instrument Digital Interface, an internationally recognized standard interface for electronic musical instruments, personal computers, and other equipment. You can connect equipment from various manufacturers provided that each complies with the MIDI standard.

## 13.2 Setting the MIDI IN Channel

To play your R-100 from a keyboard, synthesizer, personal computer, or other suitably equipped MIDI device, you must first use the MIDI CH command to make sure that the R-100's receiving (MIDI IN) channel is the same as the device's sending (MIDI OUT) channel. (See Section 13.3 for the MIDI OUT channel.) The command takes you through three steps:

Parameter	Range	Default	<.>	Keypad?
Direction (IN/OUT)	IN, OUT	IN	Y	N
OMNI mode (ON/OFF) *1	ON, OFF	ON	Y	N
MIDI IN channel *2	1 ~ 16	1	Y	N

**Note:** These settings remain in effect even after the power is removed.

**Notes:**

1. When the OMNI mode is ON, the R-100 receives on all channels. There is therefore no need to specify a MIDI IN channel.
2. This step tells the R-100 which channel to receive on when the OMNI mode is OFF.

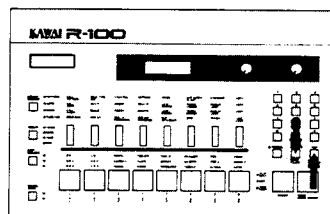
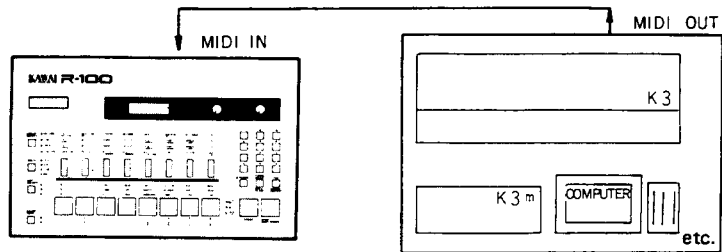

The ENTER and BACK keys switch through the steps in the order indicated.

Select MIDI IN or OUT.

MIDI CHANNEL IN

Select OMNI ON or OFF.

MIDI CHANNEL IN  
OMNI ON

If OMNI is OFF, select MIDI channel number.

MIDI CHANNEL IN  
OMNI OFF : 1

**Example:** Set the MIDI IN channel to "3".

- (1) Press the GROUP SELECT key until the LED next to FUNCTION lights. Then press the COMMAND SELECT key (#2).
- (2) Press the ENTER key to select MIDI IN.
- (3) Press the "<" or ">" key to set the OMNI mode to OFF. (When OMNI mode is ON, the R-100 receives on all channels.)
- (4) Use the "<" and ">" keys to change the channel number to "3". Press the ENTER key to store the change.

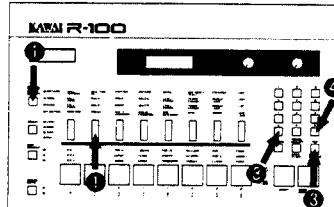

Access the MIDI CH command.

MIDI CHANNEL OUT

Use the "<" or ">" key to change to MIDI CHANNEL IN.

MIDI CHANNEL IN

Use the "<" or ">" key to turn the OMNI mode OFF.

MIDI CHANNEL IN  
OMNI OFF

Use the "<" and ">" keys to change the channel number.

MIDI CHANNEL IN  
OMNI OFF : 3

Press the ENTER key.

CALL PTN 00.  
BAR 02 04/04

### 13.3 Setting the MIDI OUT Channel

To send data from your R-100 to a personal computer, synthesizer, or other suitably equipped MIDI device, you must first use the MIDI CH command to make sure that the R-100's sending (MIDI OUT) channel is the same as the device's receiving (MIDI IN) channel. The command takes you through three (POLY mode) or four (MONO mode) steps.

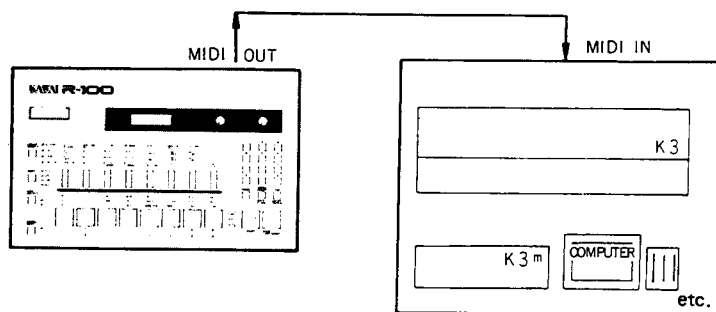

Parameter	Range	Default	<,>	Keypad?
Direction (IN/OUT)	IN, OUT	IN	Y	N
POLY/MONO select *1	POLY, MONO	POLY	Y	N
POLY OUT channel	1 ~ 16	1	Y	N
Instrument (MONO mode)	BD1 ~ CHINA			Instrument pads
MONO OUT channel	1 ~ 16	1	Y	N

**Note:** These settings remain in effect even after the power is removed.

**Note:** The MONO mode allows you to specify different channel for individual instrument. The POLY mode sends all instrument signals over the same channel.

**Procedure:**

- (1) Press the GROUP SELECT key until the LED next to FUNCTION lights. Then press the COMMAND SELECT key (#2).
- (2) Use the "<" or ">" key to select MIDI OUT.
- (3) Use the "<" or ">" key to switch between POLY and MONO modes.
- (4) **(MONO only)**  
Press the pad for the instrument.  
Use the "<" and ">" keys to change the channel number. Press the ENTER key to store the change.
  - Repeat steps (3) for the other instruments.

**(POLY only)**

Use the "<" and ">" keys to change the channel number. Press the ENTER key to store the change.

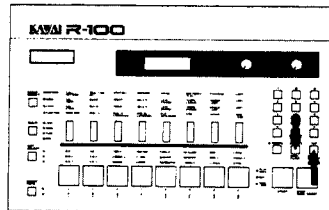

The ENTER and BACK keys switch through the steps in the order indicated.

Select MIDI IN or OUT.

MIDI CHANNEL OUT

Select POLY or MONO mode.

MIDI CHANNEL OUT  
POLY/MONO MONO

Select POLY channel number.

MIDI CHANNEL OUT  
POLY : 1

Select instrument for MONO mode.

MIDI CHANNEL OUT  
MONO COWB : 1

Select MONO channel number.

MIDI CHANNEL OUT  
MONO COWB : 1

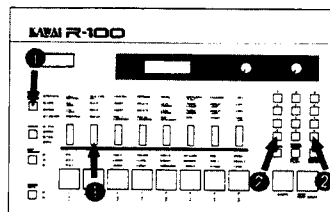

Access the MIDI CH command.

MIDI CHANNEL IN

Use the "<" or ">" key to change to MIDI CHANNEL OUT.

MIDI CHANNEL OUT

Use the "<" or ">" key to switch between POLY and MONO modes.

MIDI CHANNEL OUT  
POLY/MONO MONO

(MONO mode)

Select the instrument with a pad.

MIDI CHANNEL OUT  
MONO AGOG : 1

Use the "<" and ">" keys to change the channel number.

MIDI CHANNEL OUT  
MONO AGOG : 5

(POLY mode)

Use the "<" and ">" keys to change the channel number.

MIDI CHANNEL OUT  
POLY : 2

[MONO mode]

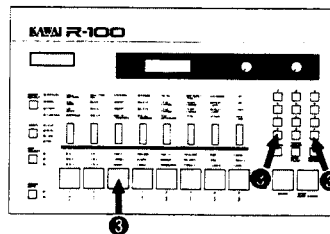

[POLY mode]

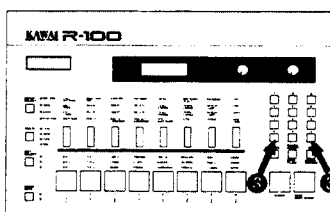

## 13.4 MIDI IN and MIDI OUT Commands

The MIDI IN and MIDI OUT commands allow you to control the types of information sent or received through the MIDI interface. You can, for example, turn the send or receive functions ON and OFF and change the KEY NO. assignments. (See Sections 13.5-13.8 for the latter.) The commands take you through four (MIDI OUT) or five (MIDI IN) steps:

Parameter	Range	Default	<>	Keypad?
Key information	ON/OFF	ON	Y	N
Velocity	ON/OFF	ON	Y	N
Volume *1	ON/OFF	ON	Y	N
Program No.	ON/OFF	ON	Y	N
Key No.	See Sections 13.5 – 13.8.			

**Note:** These settings remain in effect even after the power is removed.

**Note:** The R-100 cannot send VOLUME data. It can only receive it.

### (MIDI IN COMMANDS)

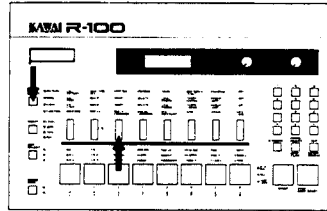

### (MIDI OUT COMMANDS)

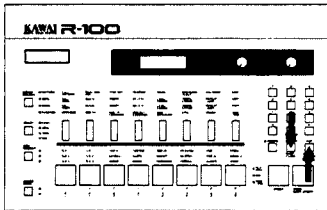
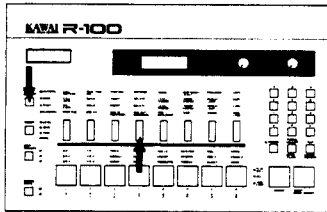

The ENTER and BACK keys switch through the steps in the order indicated.

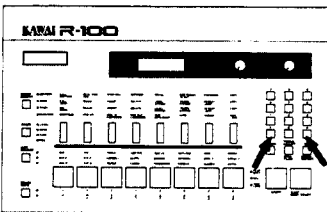

The "<" and ">" keys switch between ON and OFF.

Turn KEY INFORMATION ON and OFF.

MIDI IN  
KEY INFO. ON

Turn VELOCITY ON and OFF.

MIDI IN  
VELOCITY ON

Turn VOLUME ON and OFF.

MIDI IN  
VOLUME ON

Turn PROGRAM NO. ON and OFF.

MIDI IN  
PROGRAM ON

Adjust key numbers.  
(See Sections 13.5-13.8.)

MIDI IN  
KEY NO 0 : \* \* \* \*

### 13.5 MIDI IN Key Numbers – Description

The final step of the MIDI IN command allows you to assign the key numbers 0-127 to various instruments. You can also assign separate numbers to different TUNE and PAN combinations for the same instrument – in which case, you might want to group the numbers together. When it leaves the factory, your R-100 contains the assignments shown in the chart in Section 13.6.

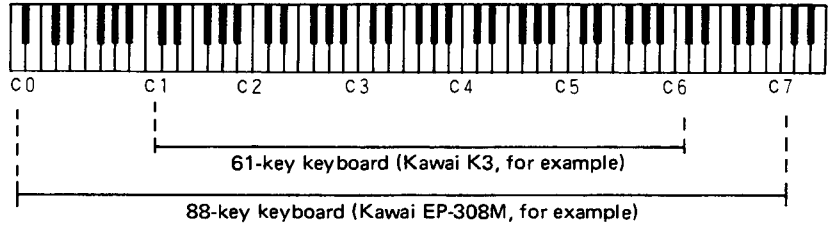

### 13.6 MIDI IN Key Numbers – Example

TUNE	-8	/	-8	-3	/	+7	-3	+2	/	0	0	/	0	0	0	/	0	0	/	0	0	0																																															
PAN	+3	/	0	0	/	0	0	0	/	0	0	/	0	+7	+7	/	+2	-4	/	-4	7	0																																															
	20	22		25	27		30	32	34		37	39		42	44	46		49	51		54	56	58																																														
			CRASH 1, LO		BD3	BD3		SD3 HI	SD2 LO	SD2 HI		BD3	SD3		CLAPS	HI CLOSE	HI OPEN		CRASH 1	CRASH 2		RIDE 1	RIDE 2	CHINA																																													
		BD2 LO	BD2 LO	BD2 LO	BD1 LO	BD1 LO	BD1 LO	SD1 LO	SD1 LO	SD1 HI		BD2	BD1	SD1	SD2	TOM HI	TOM HI	TOM MID		TOM MID	TOM LO	TOM LO		CONGA HI	CONGA LO	CONGA LO																																											
	19	21	23	24	26	28	29	31	33	35	36	38	40	41	43	45	47	48	50	52	53	55	57																																														
TUNE	-8	-6	-3	-8	-6	-3	-3	-2	+1	0	0	0	0	0	+5	0	+4	0	+4	0	+3	0	-4																																														
PAN	0	0	0	0	0	0	0	0	0	0	0	0	0	0	-7	-4	-2	+2	+4	+7	-2	0	+2																																														
SCALE	C 0																							C 1																							C 2																						

TUNE	0	0	/	+7	0	/	+7	0	-5	/	-2	-8	/	-6	-4	-2	/	+1	+3	/	+6	/
PAN	-7	0	/	0	0	/	-2	0	+2	/	+2	+2	/	0	0	0	/	0	0	/	0	/
	56	58		61	63		66	68	70		73	75		78	80	82		85	87		90	92
	RIDE	CH 1		AGOGO	AGOGO		TIMBALE	TIMBALE	TIMBALE		CRASH	CRASH		CLAVES	CLAVES	CLAVES		CLAVES	CLAVES		CLAVES	
	2	-NA		HI			HI		LO		1, LO	1, LO		LO	LO	LO		HI	HI		HI	
	CONGA	SHAKER	SHAKER	SHAKER	COMBL	COMBL	CLAPS	CLAPS	CLAPS	TAHB	TAHB	CLAVES	CLAVES	CLAVES	CLAVES	CLAVES	CLAVES	CLAVES	CLAVES	CLAVES	CLAVES	CLAVES
	LO	HI		LO	HI		HI		LO	HI	LO	LO	LO	LO	LO	LO	LO	HI	HI	HI	HI	
	57	59	60	62	64	65	67	69	71	72	74	76	77	79	81	83	84	86	88	89	91	93
TUNE	-4	+2	0	-2	+5	0	+2	0	-1	0	+2	-8	-7	-5	-3	-1	0	+2	+4	+5	+7	
PAN	+2	0	0	0	0	0	0	0	0	+2	+2	0	0	0	0	0	0	0	0	0	0	0

SCALE..... C3 ..... C4 ..... C5

- (1) Press the MIDI IN COMMANDS key and then use the ENTER key to reach the MIDI IN KEY NUMBER DISPLAY.
  - (2) Use the ENTER and BACK keys to change the key number.
  - (3) Press the pad for the desired instrument.  
Press the MULTI key and adjust the TUNE and PAN parameters for the instrument.
  - (4) Press the instrument pad again to store the new assignment.
- Repeat steps (2) through (4) for other combinations.

**Note:** To cancel an assignment, press the ERASE key — to change the field to "\*\*\*\*" — instead of an instrument pad at step (3).

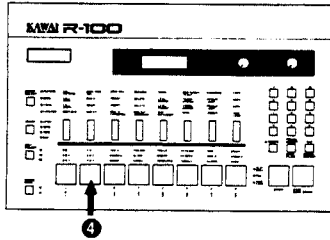
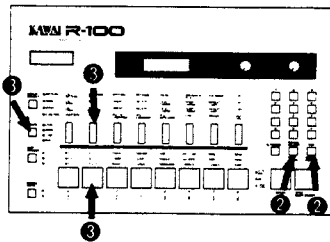
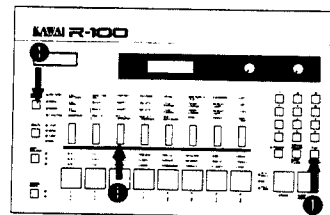

MIDI IN command key assignment display:

MIDI IN  
KEY. NO 1 : \*\*\*\*

Use the ENTER and BACK keys to change the key number.

MIDI IN  
KEY. NO 12 : \*\*\*\*

Select the desired instrument with the appropriate pad and adjust with the MULTI programming function.

MIDI IN  
KEY. NO 12 : SD3

Press the instrument pad second time to store.

MIDI IN  
KEY. NO 13 : \*\*\*\*



## 13.7 MIDI OUT Key Numbers

The final step of the MIDI OUT command allows you to assign a key number to each of the R-100's twenty-four instruments. This facility is handy for sending data to a sequencer, personal computer, or other similar MIDI device. Unlike the MIDI IN command, however, it does not allow you to assign separate numbers to different TUNE and PAN combinations for the same instrument.

When it leaves the factory, your R-100 contains the assignments shown in the chart in Section 13.8.

### Example:

- (1) Press the MIDI OUT COMMANDS key, then use the ENTER key to reach the MIDI OUT KEY NUMBER display.
- (2) Press the pad for the desired instrument.
- (3) Use the "<" and ">" keys to change the key number.

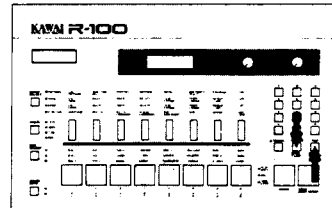

The ENTER and BACK keys switch through the steps in the order indicated.

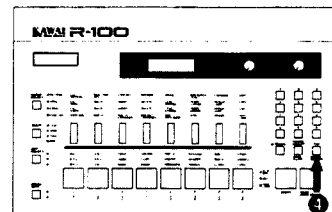
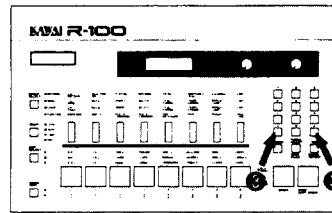
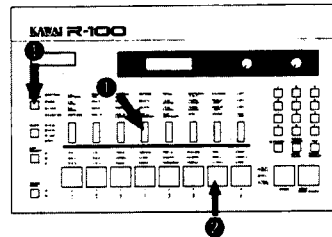

MIDI OUT command key assignment display:

```
MIDI OUT
KEY. NO   BD1 37
```

Select the instrument with the appropriate pad.

```
MIDI OUT
KEY. NO   RID1 54
```

Use the "<" and ">" keys to change the key number.

```
MIDI OUT
KEY. NO   RID1 53
```

Press the ENTER key to store.

```
CALL   PTN 00.
BAR 01   04 / 04
```

### 13.8 MIDI OUT Key Numbers (Factory Settings)

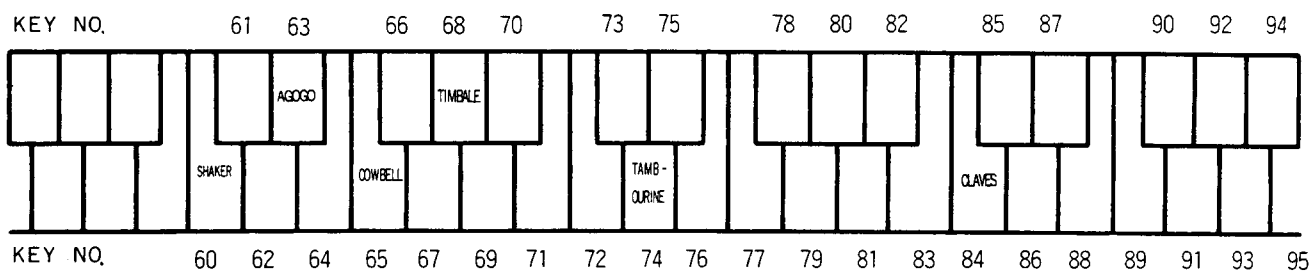
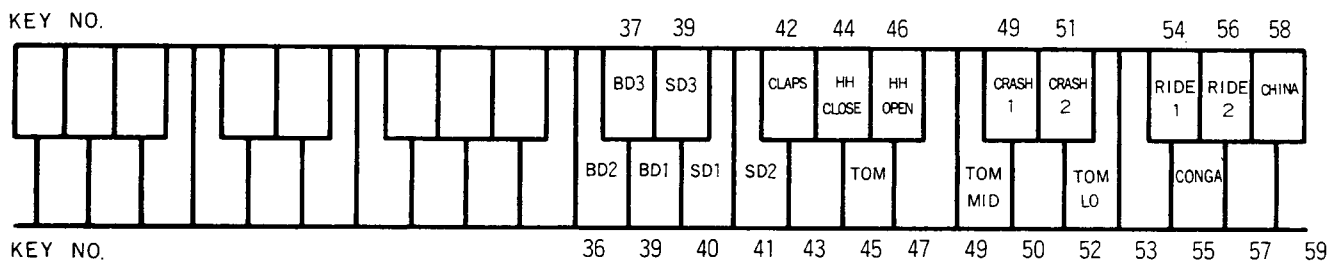

## 13.9 Sample MIDI Applications

### Using the R-100 as a Slave

- (1) Connect the MIDI OUT jack of the synthesizer, sequencer, or similar device to the R-100's MIDI IN jack with a MIDI cable.
- (2) Set the R-100's MIDI IN channel to the same number as the sending device's MIDI OUT channel.

### REALTIME Recording From a MIDI Keyboard

- (1) Connect the R-100 to the MIDI keyboard and make sure that both are set to the same MIDI channel.
- (2) Use the R-100's GROUP SELECT and second COMMAND SELECT keys to activate the REALTIME REC. command.
- (3) Use the keypad as well as the "<" and ">" keys to specify the pattern number, number of bars, time signature, metronome speed, and ERROR CORRECT parameter.
- (4) Press the START key and begin recording. (See Section 13.6 MIDI IN Key Number – Description for the key assignments.)

**Note:** If you use a Kawai K-3 or other keyboard with touch sensitivity, the R-100 also records the key velocity of each note.

**Note:** Never use drumsticks to play the synthesizer or the R-100! However you can play the R-100 from MIDI drumpads.

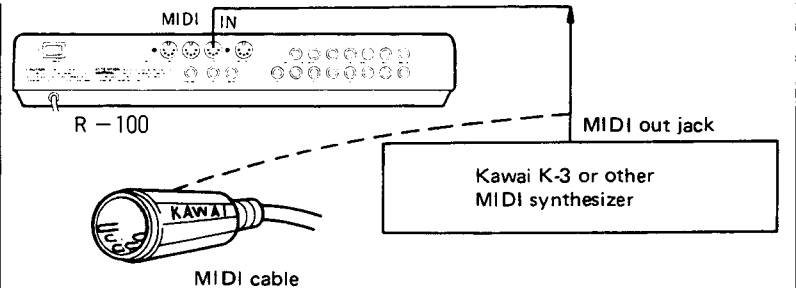

### <REALTIME recording>

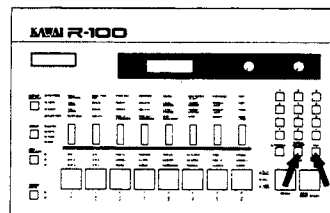

The ENTER and BACK keys switch through the steps in the order indicated.

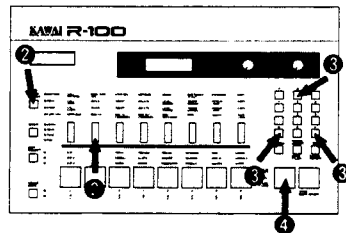

Access the REALTIME REC. command.

```
REAL : NEW PTN 8 8
BAR 0 1 0 4 / 0 4
```

Set the parameters. (See Section 6.2 REALTIME REC. Command.)

```
REAL : NEW PTN 2 8
BAR 0 4 0 3 / 0 4
```

Press the START key.

```
REAL PTN 2 8
BAR 0 4 - 0 1 0 3 / 0 4
```

See Section 13.6 MIDI IN Key Numbers – Description for the relationships between keys and R-100 instruments.

### STEP Recording From a MIDI Keyboard

- (1) Connect the R-100 to the MIDI keyboard and make sure that they are using the same MIDI channel.
- (2) Use the R-100's GROUP SELECT and third COMMAND SELECT keys to activate the STEP REC. command.
- (3) Use the keypad as well as the "<" and ">" keys to select the pattern number, number of bars, time signature, and BAR CORRECT parameter.
- (4) Press the pad for the instrument.
- (5) Press the START key.
- (6) Use keys 36-48 and 60-72 on the MIDI keyboard to record the rhythm pattern.

**Note:** If you use a keyboard with touch sensitivity, the R-100 also records the key velocity.

**Note:** These keys assignments cannot be changed.

#### <STEP recording>

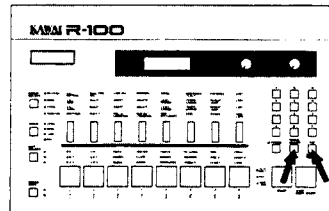

The ENTER and BACK keys switch through the steps in the order indicated.

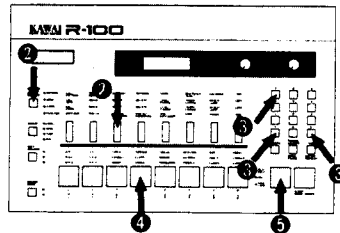

Access the STEP REC. command.

```
STEP: NEW PTN 12
BAR 01 04/04
```

Set the parameters. (See Section 6.4 STEP REC. Command.)

```
STEP: CONG PTN 27
BAR 04 06108
```

Press the START key.

```
STEP: CONG PTN 27
BAR 04-01 06108
```

The notes values are assigned to the following keys on the MIDI keyboard.

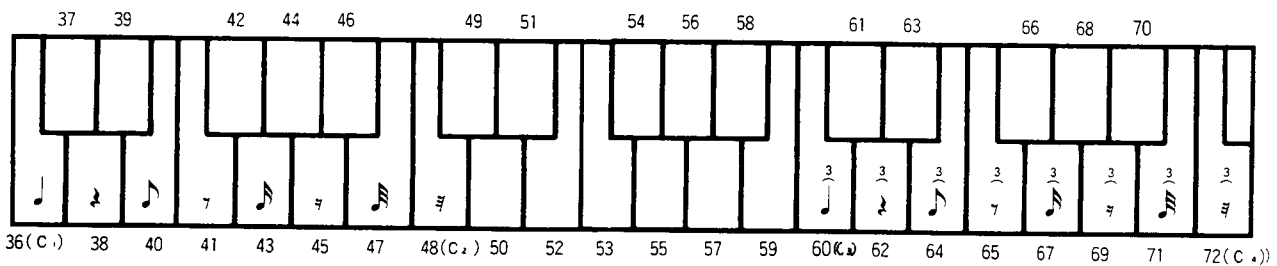

# 14. SYNC Command

## 14.1 Introduction

The SYNC command enables a choice of synchronization sources: the internal clock (INT) or one of four types of external sources (EXT): MIDI, TAPE, DIN, or CLOCK. There are three steps:

Parameter	Range	Default	<>	Keypad?
Internal or external	INT, EXT	INT	Y	N
[EXT] Type of synchronization	MIDI, TAPE, DIN, CLOCK	MIDI	Y	N
[EXT CLOCK] Time base	= 24, 48, 96	24	Y	N

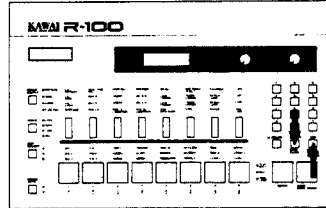

The ENTER and BACK keys switch through the steps in the order indicated.

Internal or external

```

SYNC  INT/EXT
      INT
    
```

[EXT] Type of synchronization

```

SYNC  EXT
      MIDI
    
```

[EXT CLOCK] Time base

```

SYNC  EXT
TIME BASE = 24
    
```

## 14.2 INT – Internal Clock

Choosing INT tells the R-100 to use its internal clock for timing. The R-100 can also provide synchronization signals from its internal clock to external devices.

### Procedure:

- (1) Connect the device to one of the three output jacks provided: MIDI OUT, DIN OUT, or CLK OUT.
- (2) Select internal synchronization (INT).
- (3) Adjust the external device that it accepts external synchronization signals.
- (4) Press the R-100 START key.

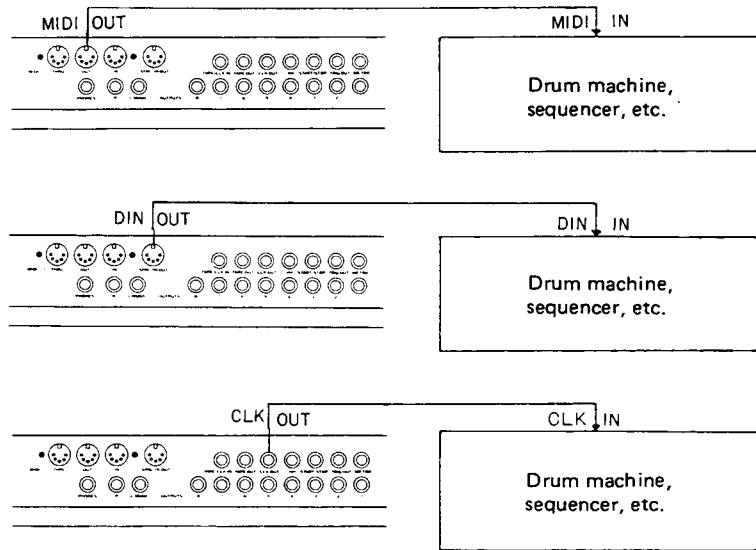

## 14.3 MIDI SYNC

Choosing EXT allows the R-100 to accept synchronization signals from external devices. One possible signal is MIDI timing clock messages from a sequencer, personal computer, or similarly equipped MIDI device.

### Procedure:

- (1) Connect the device to the R-100 in the manner shown at the right.
- (2) Select external synchronization (EXT).
- (3) Select a MIDI source.  
The R-100 starts playing when the external device does.

**Note:** The external device can also tell the R-100 which rhythm pattern to use and where to start.

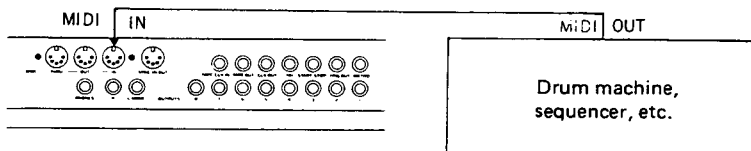

## 14.4 TAPE SYNC

The R-100 can record sync tone onto tape for subsequent synchronized playback. Choosing TAPE selects synchronization to this tone.

### Recording the Timing Signal:

- (1) Connect the tape recorder to the R-100 in the manner shown at the right.
- (2) Select a pattern, song, or chain.
- (3) Select internal synchronization (INT).
- (4) Make sure that the R-100 is not playing back, then set the tape recorder to RECORD and PAUSE.
- (5) Adjust the tape recorder's recording level. (about +3 dB)
- (6) Start the tape recorder, wait a few seconds, and then press the R-100's START key.
- (7) When the R-100 finishes, stop the tape recorder.

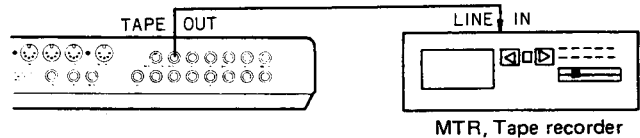

### Synchronizing with the Tape:

- (1) Connect the tape recorder to the R-100 in the manner shown at the right.
- (2) Select external synchronization (EXT) and TAPE input.
- (3) Start the tape recorder playback.
- (4) Press the R-100 START key after the steady tone appears, but before it turns into an alternating one.  
The R-100 starts playing when the tone changes.

**Note:** It may take some trial & error to get the levels adjusted for proper operation.

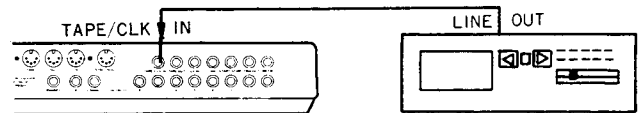

### Sample setup

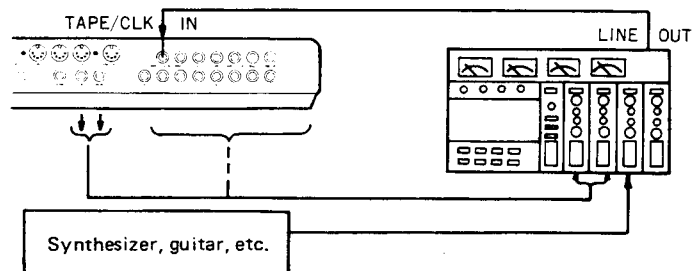

## 14.5 CLOCK SYNC

Choosing CLOCK synchronizes the R-100 to an external clock source.

### Procedure:

- (1) Connect the device to the R-100 in the manner shown at the right.
- (2) Select external synchronization (EXT) and CLOCK input.
- (3) Select the time base (24/48/96). Consult the manuals for your other equipment to determine which setting is best.  
The R-100 starts playing when the external device does.

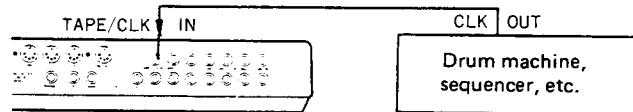

## 14.6 DIN SYNC

Choosing DIN synchronizes the R-100 to any external device using DIN SYNC timing.

### Procedure:

- (1) Connect the device to the R-100 in the manner shown at the right.
- (2) Select external synchronization (EXT).
- (3) Select a DIN source.  
The R-100 starts playing when the external device does.

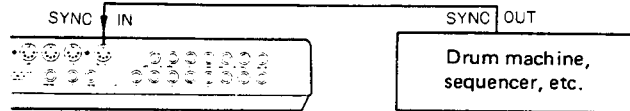



## 14.7 TIMING ADJUST Feature

The TIMING ADJUST feature allows you to adjust the R-100's timing relative to the external device (MIDI, TAPE, DIN, or CLOCK). Each step corresponds to 1/24 note.

	Range	Default	<,>	Keypad?
TIMING ADJUST	-9 ~ 0 ~ +9	0	Y	N

### Procedure:

- (1) Connect the two instruments using one of the procedures in Sections 14.2-14.6.
- (2) Start the controlling instrument.
- (3) Press the TEMPO key, then TIMING ADJUST/BACK key.
- (4) Use the "<" and ">" keys to adjust the relative timing.

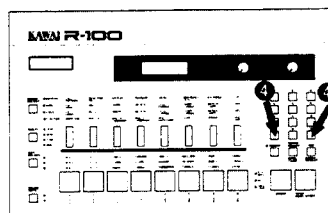
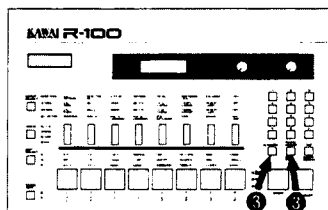

Start the two instruments playing together.

```
PLAY      SONG 12
012-001 = PTN 03
```

Press the TEMPO key, then TIMING ADJUST key.

```
J=120     SONG 12
012-001 = PTN 03
```

5

```
ADJ 0     SONG 12
012-001 = PTN 03
```

Use the "<" and ">" keys to adjust the relative timing.

```
ADJ -6    SONG 12
012-001 = PTN 03
```

# 15. SYSTEM EXCLUSIVE Commands

## 15.1 SYSTEM EXCLUSIVE

The R-100's MIDI implementation includes SYSTEM EXCLUSIVE messages which allow you to use one R-100 ("A" in the diagram at the right) to control another ("B"): (1) change the MULTI programming parameters (LEVEL, TUNE, SENS., and PAN.), (2) change the MIDI IN key numbers, and (3) send or receive the data in memory. These SYSTEM EXCLUSIVE functions are accessed from the MIDI DATA DUMP command. The MIDI DATA DUMP command takes you through three steps:

Parameter	Range	Default	<,>	Keypad?
SYSTEM EXCLUSIVE	ON/OFF	OFF	Y	N
DATA DUMP channel	1 ~ 16	1	Y	N
READY	Press the ENTER key to proceed; the BACK key to cancel.			

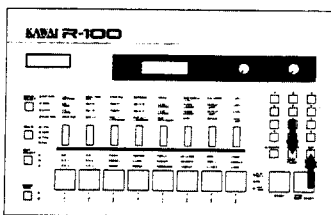
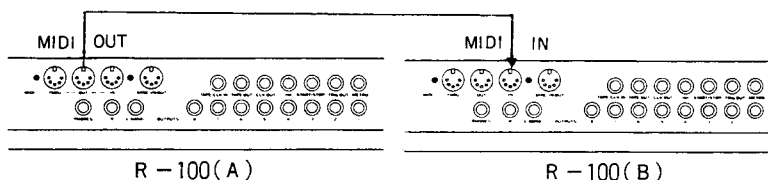

The ENTER and BACK keys switch through the steps in the order indicated.

Switch the SYSTEM EXCLUSIVE feature ON or OFF.

SYSTEM OFF  
EXCLUSIVE

Select the DATA DUMP channel.

DATA DUMP CH: 1

Check the specifications.

DATA DUMP CH: 1  
READY

## 15.2 Remote MULTI Programming

One SYSTEM EXCLUSIVE message allows you to use the MULTI programming feature on one "A" to change the LEVEL, TUNE, SENS., and PAN. parameters on the other "B".

### Procedure:

- (1) Connect the two R-100s in the manner shown at the right.
- (2) Press the COMMAND SELECT key (#5) and the "<" or ">" key to access the SYSTEM EXCLUSIVE feature.
- (3) Press the ENTER key and select the DATA DUMP channel.
- (4) Use the GROUP SELECT and MULTI keys to select the instrument and parameter.
- (5) Use the COMMAND SELECT keys to change the parameter values on the "A" display – and simultaneously in "B".

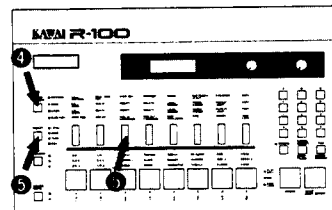
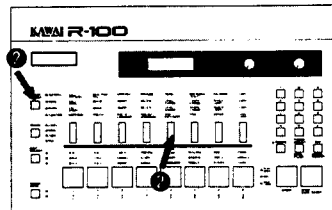
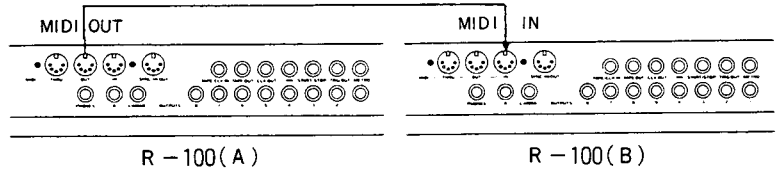

Access the MIDI DATA DUMP command on both R-100s.

```
SYSTEM      OFF
EXCLUSIVE
```

Use the "<" or ">" key to access the SYSTEM EXCLUSIVE feature.

```
SYSTEM      ON
EXCLUSIVE
```

Set the same DATA DUMP channel on both.

```
DATA DUMP  CH: 2
```

Press the GROUP SELECT key.

```
CALL      PTN 04
BAR 01      04 / 04
```

```
B S T T T H R C
1 1 H M L C 1 1
```

R - 100 ( A )

```
B S T T T H R C
1 1 H M L C 1 1
```

R - 100 ( B )

### 15.3 MIDI DATA DUMP

Another SYSTEM EXCLUSIVE message allows you to transfer all data from "A" to "B".

**Procedure:**

- (1) Connect the two R-100s in the manner shown at the right.
- (2) Press the COMMAND SELECT key (#5) and the "<" or ">" key to access the SYSTEM EXCLUSIVE feature.
- (3) Press the ENTER key and specify the DATA DUMP channel.
- (4) Press the ENTER key.
- (5) Press the START key.

**Note:** Remember that copying process replaces the memory contents of "B" with those of "A".

**Note:** The R-100's MIDI DATA DUMP may be able to be used to store data onto computers or other devices.

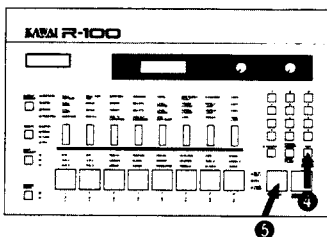
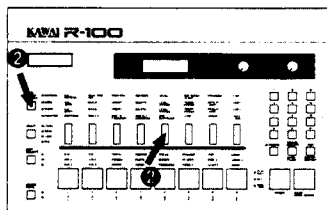
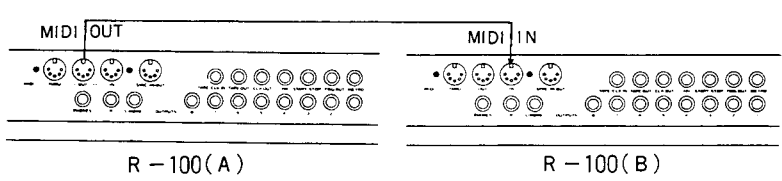

Access the MIDI DATA DUMP command on both R-100s.

SYSTEM EXCLUSIVE OFF

Use the "<" or ">" key to access the SYSTEM EXCLUSIVE feature.

SYSTEM EXCLUSIVE ON

Set the same DATA DUMP channel on both.

DATA DUMP CH: 2

Press the ENTER key.

DATA DUMP CH: 2  
READY

Press the START key.

DATA DUMP CH: 2  
BUSY

# 16. ASSIGN Command

## 16.1 Introduction

The ASSIGN command allows you to select the output jacks for each instrument and also which instrument controls the trigger. It takes you through three steps:

Parameter	Range	Default	<,>	Keypad?
Subcommand	TRIG.OUT/OUTPUT	OUT-PUT	Y	N
[OUTPUT] Instrument	BD1 ~ CHINA			Instrument pads
Jacks	BOTH/STEREO/INDIV	BOTH	Y	N
[TRIG.OUT] Instrument	BD1 ~ CHINA			Instrument pads

**Note:** These settings remain in effect even after the power is removed.

**Note:** You can hear "both" and "STEREO" setting sound with headphone.

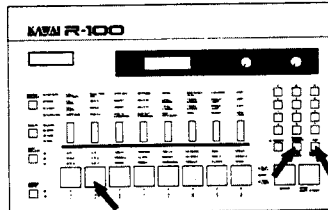

The ENTER and BACK keys switch through the steps in the order indicated.

Use the instrument pads to select instruments, the "<" and ">" key to select output jacks.

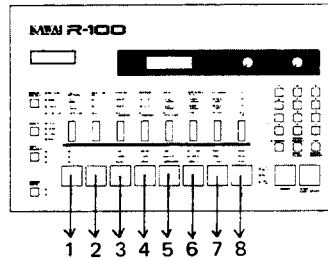

Choose TRIG. OUT or OUTPUT.

ASSIGN OUTPUT

Select trigger instrument.

ASSIGN OUTPUT

Select output instrument.

ASSIGN OUTPUT  
TOMM BOTH

Select output jack.

ASSIGN OUTPUT  
SD1 BOTH

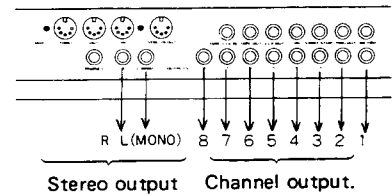

Stereo output Channel output.

## 16.2 ASSIGN OUTPUT



This (OUTPUT) subcommand allows you to select whether an instrument's output goes to the individual channel jacks (INDIV), the stereo output jacks (STEREO), or both (BOTH).

Setting	Connected	
	Individual channel jacks	Stereo jacks
BOTH	Y	Y
STEREO	N	Y
INDIV	Y	N

### Example:

The chart below shows one possible setup. The diagram at the right shows the effects that these settings have on the outputs.

	1	2	3	4	5	6	7	8
BD1	SD1	TOMHI	TOMMID	TOMLO	HHCLOSE	RIDE1	CRASH1	
BD2	SD2	COWBELL	CLAPS	SHAKER	HHOPEN	RIDE2	CRASH2	
BD3	SD3	AGOGO	CONGA	TAMBOURINE	TIMBALE	CLAVES	CHINA	

- INDIV**  
 ..... These go to the individual channel outputs only.
- STEREO**  
 ..... These go to the stereo outputs only.
- BOTH**  
 ..... These go to both outputs.

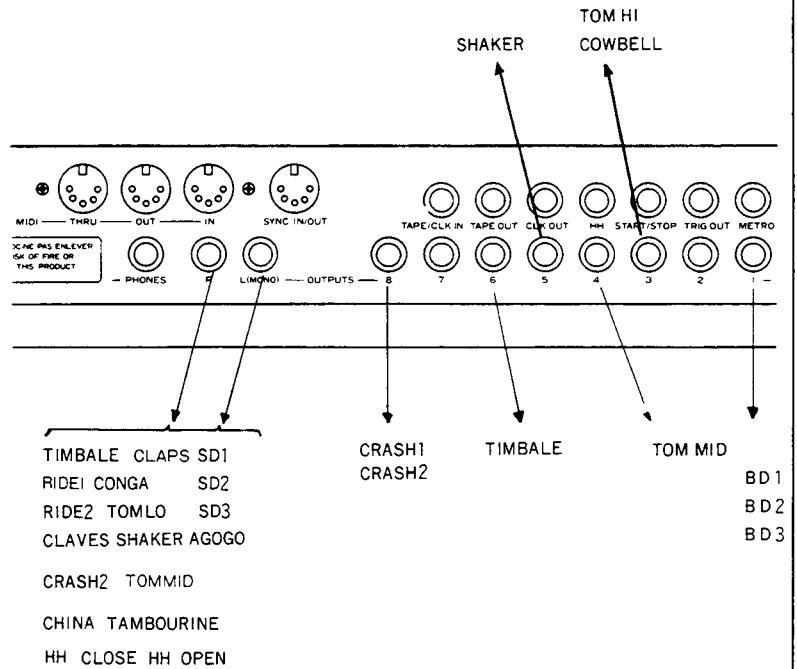

TIMBALE CLAPS SD1  
 RIDE1 CONGA SD2  
 RIDE2 TOMLO SD3  
 CLAVES SHAKER AGOGO  
 CRASH2 TOMMID  
 CHINA TAMBOURINE  
 HH CLOSE HH OPEN

CRASH1  
 CRASH2

TIMBALE

TOM MID

BD 1  
 BD 2  
 BD 3

### 16.3 TRIG. OUT

The TRIG. OUT subcommand allows you to select an instrument to trigger an external sound source.

**Procedure:**

- (1) Connect the R-100 and the sound source in the manner shown at the right.
- (2) Press COMMAND SELECT key (#7) and the "<" or ">" key to access the TRIG. OUT subcommand.
- (3) Press the pad to specify the instrument.
- (4) Press the ENTER key to store the setting.
- (5) Press the START key to start playback and listen to the rhythm on the external sound source.

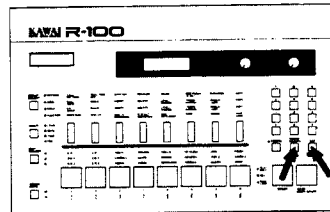
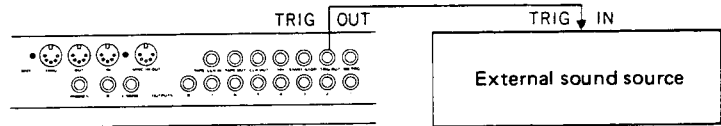

The ENTER and BACK keys switch through the steps in the order indicated.

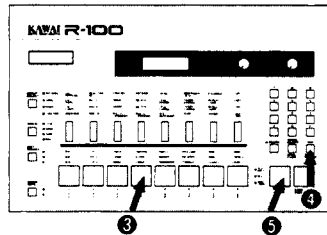
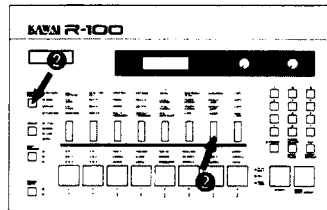

Choose TRIG. OUT or OUTPUT.

ASSIGN      OUTPUT

Switch to TRIG. OUT.

ASSIGN TRIG. OUT

Select instrument.

ASSIGN TRIG. OUT  
CONG

Press the ENTER key.

CALL    PTN 00.  
BAR 01      04 / 04

# 17. Storing Data

## 17.1 SAVE/LOAD Command

The SAVE/LOAD command allows you to transfer the pattern, song, and chain data from the R-100's memory to cassette tape or an RC-16 memory cartridge (available separately). The command takes you through three steps:

Parameter	Range	Default	<, >	Keypad?
Medium	CARTRIDGE/ CASSETTE	CAR- TRIDGE	Y	N
Subcommand	SAVE/LOAD/VERIFY	SAVE	Y	N
READY	Press the ENTER key to proceed; the BACK key to cancel.			

- SAVE** Copy data from R-100 to cartridge or cassette.
- VERIFY** Compare data in R-100 with that in the cartridge or cassette.
- LOAD** Copy data from cartridge or cassette to R-100.

**Note:** Remember that the LOAD operation erases the current contents of the R-100's memory.

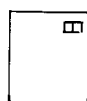

RC-16 Cartridge  
available from  
your KAWAI  
dealer



Cassette tape

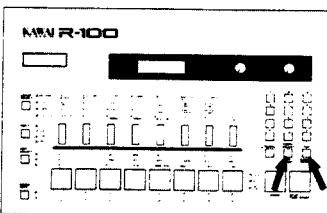

The ENTER and BACK keys switch through the steps in the order indicated.

Choose CARTRIDGE or CASSETTE.

SAVE/LOAD  
CARTRIDGE

Choose subcommand.

SAVE/LOAD/VERIFY  
CARTRIDGE

Check settings.

SAVE READY  
CARTRIDGE



## 17.2 Cartridge

### Save to Cartridge

- (1) Shift the PROTECT switch on the cartridge to the OFF position and insert the cartridge in the slot provided.
- (2) Press COMMAND SELECT key (#8) to access the SAVE/LOAD command.
- (3) Use the "<" or ">" key to select CARTRIDGE and press the ENTER key.
- (4) Use the "<" or ">" key to select SAVE and press the ENTER key.
- (5) Press the START key.
- (6) Wait for the message "SAVE END".

### Verify Cartridge Contents

- (1) Shift the PROTECT switch on the cartridge to the ON position and insert the cartridge in the slot provided.
- (2) Press COMMAND SELECT key (#8) to access the SAVE/LOAD command.
- (3) Use the "<" or ">" key to select CARTRIDGE and press the ENTER key.
- (4) Use the "<" or ">" key to select VERIFY and press the ENTER key.
- (5) Press the START key.
- (6) Wait for the message "VERIFY OK".

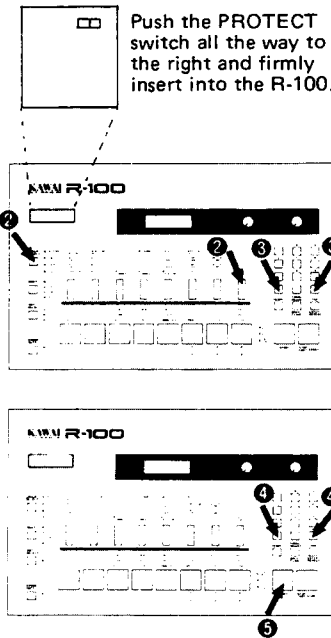

### [Save to Cartridge]

Access the SAVE/LOAD command.

```
SAVE/LOAD
CARTRIDGE
```

Use the "<" or ">" key to select CARTRIDGE.

```
SAVE/LOAD
CARTRIDGE
```

Use the "<" or ">" key to select SAVE.

```
SAVE/LOAD/VERIFY
CARTRIDGE
```

Press the ENTER key.

```
SAVE          READY
CARTRIDGE
```

Press the START key.

```
SAVE          END
CARTRIDGE
```

### [Verify Cartridge Contents]

Access the SAVE/LOAD command.

```
SAVE/LOAD
CARTRIDGE
```

Use the "<" or ">" key to select CARTRIDGE.

```
SAVE/LOAD
CARTRIDGE
```

Use the "<" or ">" key to select VERIFY.

```
SAVE/LOAD/VERIFY
CARTRIDGE
```

Press the ENTER key.

```
VERIFY          READY
CARTRIDGE
```

Press the START key.

```
VERIFY          OK
CARTRIDGE
```

### Load from Cartridge

- (1) Shift the PROTECT switch on the cartridge to the ON position and insert the cartridge in the slot provided.
- (2) Press COMMAND SELECT key (#8) to access the SAVE/LOAD command.
- (3) Use the "<" or ">" key to select CARTRIDGE and press the ENTER key.
- (4) Use the "<" or ">" key to select LOAD and press the ENTER key.
- (5) Press the START key.
- (6) Wait for the message "LOAD END".

### Errors

If a SAVE, VERIFY, or LOAD operation produces the message ERROR, double-check and then repeat the procedure. Things to check include the position of the cartridge's PROTECT switch and the connection between the cartridge and the R-100.

### [Load from Cartridge]

Access the SAVE/LOAD command.

```
SAVE/LOAD
CARTRIDGE
```

Use the "<" or ">" key to select CARTRIDGE.

```
SAVE/LORD
CARTRIDGE
```

Use the "<" or ">" key to select LOAD.

```
SAVE/LOAD/VERIFY
CARTRIDGE
```

Press the ENTER key.

```
LOAD          READY
CARTRIDGE
```

Press the START key.

```
LOAD          END
CARTRIDGE
```

```
SAVE          ERROR
CARTRIDGE
```

## 17.3 Cassette

### Save to Cassette

- (1) Connect the R-100 and the tape recorder in the manner shown at the right.
- (2) Press COMMAND SELECT key (#8) to access the SAVE/LOAD command.
- (3) Use the "<" or ">" key to select CASSETTE and press the ENTER key.
- (4) Use the "<" or ">" key to select SAVE and press the ENTER key.
- (5) On the tape recorder, adjust the recording level.
- (6) Start recording on the tape recorder.
- (7) Wait a few seconds and press the R-100 START key.
- (8) Wait for the message "SAVE END".

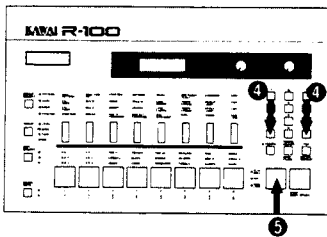
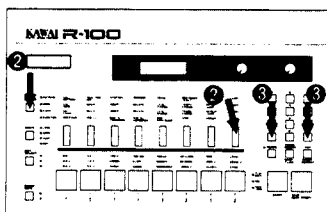
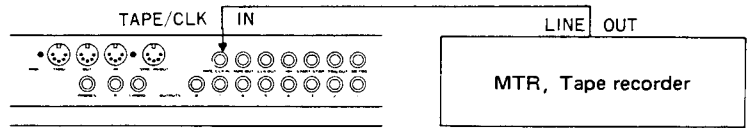
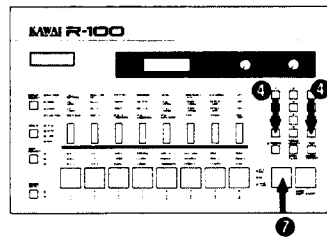
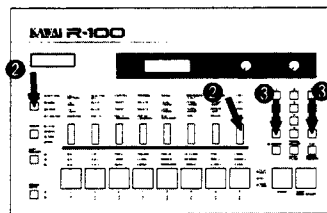
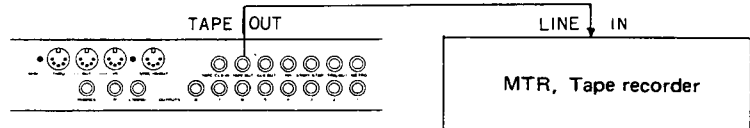

### Verify Cassette Contents

- (1) Connect the R-100 and the tape recorder in the manner shown at the right.
- (2) Press COMMAND SELECT key (#8) to access the SAVE/LOAD command.
- (3) Use the "<" or ">" key to select CASSETTE and press the ENTER key.
- (4) Use the "<" or ">" key to select VERIFY and press the ENTER key.
- (5) Press the R-100 START key and start the tape recorder playback.
- (6) Wait for the message "VERIFY OK".

### Load from Cassette

- (1) Connect the R-100 and the tape recorder in the manner shown at the right.
- (2) Press COMMAND SELECT key (#8) to access the SAVE/LOAD command.
- (3) Use the "<" or ">" key to select CASSETTE and press the ENTER key.
- (4) Use the "<" or ">" key to select LOAD and press the ENTER key.
- (5) Press the R-100 START key and start the tape recorder playback.
- (6) Wait for the message "LOAD END".

**Note:** Remember that the LOAD operation erases the current contents of the R-100's memory.

### Errors:

If you get an error message during cassette LOAD or VERIFY, you may need to readjust your record or playback level.

If you are using data recorder with an invert switch, try setting the switch to the opposite position.

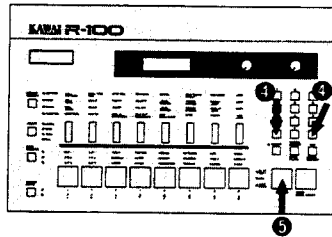
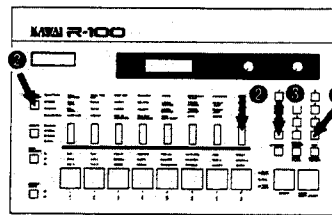
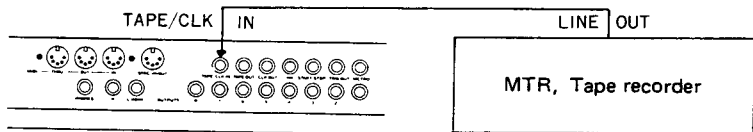

# MIDI Data Format

## 1. RECOGNIZED AND TRANSMITTED DATA

### 1.1 RECOGNIZED

1st	2nd	3rd	Description
1001nnnn	0kkkkkkk	0vvvvvvv	Note on kkkkkkk=0~127 vvvvvvv=1~127
1100nnnn	0ppppppp	-----	Program change ppppppp=0~99 : song no. 100~109 : chain no.
11110010	01111111	0hhhhhhh	Song position pointer 1111111=0~127 least signification hhhhhhh=0~127 most signification
11110011	0sssssss	-----	Song select sssssss=0~99 : song no. 100~109 : chain no.
11111000	-----	-----	Real time clock
11111010	-----	-----	Start
11111011	-----	-----	Continue
11111100	-----	-----	Stop

nnnn=0~15 Channel no.

### 1.2 TRANSMITTED

1st	2nd	3rd	Description
1001nnnn	0kkkkkkk	0vvvvvvv	Note on/off kkkkkkk=0~127 vvvvvvv=0 off vvvvvvv=1~127 on
1100nnnn	0ppppppp	-----	Program change ppppppp=0~99 : song no. 100~109 : chain no.
11110011	0sssssss	-----	Song select sssssss=0~109 : song no. 100~109 : chain no.
11111000	-----	-----	Real time clock
11111010	-----	-----	Start
11111011	-----	-----	Continue
11111100	-----	-----	Stop

nnnn=0~15 Channel no.

## 2. RECEIVE AND TRANSMITTED EXCLUSIVE DATA

### 2.1 ALL DATA DUMP

Status	11110000	F0H	System exclusive	
Kawai ID	01000000	40H		
Channel no.	0000nnnn	0nH	0~15	
Function no.	00100001	21H	All data dump	
Group no.	00000010	02H	Drum machine group	
Machine ID	00000001	01H	R-100 ID no.	
Data	00010000	10H	Pattern data start mark	} pattern data block
Data	0000xxxx		1st data low	
Data	0000xxxx		high	
Data	0000xxxx		2nd data low	
Data	0000xxxx		high	
Data	00100000	20H	Pattern data end mark	} song data block
Data	00010001	11H	Song data start mark	
Data	0000xxxx			
Data	0000xxxx			
(Data)	(00110001)	31H	Song skip mark *note 1	}
(Data)	(0ppppppp)		Song no.	
Data	00100001	21H	Song data end mark	} chain data block
Data	00010010	12H	Chain data start mark	
Data	0000xxxx			
Data	0000xxxx		Last data low	
Data	0000xxxx		high	
Data	00100010	22H	Chain data end mark	
EOX	11110111	F7H	End of exclusive	

\*note 1: If song data do not exist, the R-100 sends song skip mark (31H) before the song no.

\*note 2: If chain data do not exist, the R-100 sends chain skip mark (32H) before the chain no.

## 2.2 PARAMETER CHANGE

### 2.2.1 MULTI MODE PARAMETER

Status	11110000	F0H	System exclusive
Kawai ID	01000000	40H	
Channel no.	0000nnnn	0nH	0~15
Function no.	00010000	10H	Parameter change
Group no.	00000010	02H	Drum machine group
Machine ID	00000001	01H	R-100 ID no.
Data	00000000	00H	Sub status (multi mode parameter)
Data	0mmddddd		Parameter no.
Data	0000vvvv		Value
EOX	11110111	F7H	End of exclusive

mm=0~3 Mode no.

0 Level  
1 Sens  
2 Tune  
3 Pan

dddd=0~23 Instrument no.

0	BD1	8	BD2	16	BD3
1	SD1	9	SD2	17	SD3
2	TOM HI	10	COWBELL	18	AGOGO
3	TOM MID	11	CLAPS	19	CONGA
4	TOM LO	12	SHAKER	20	TAMBOURINE
5	HH CLOSE	13	HH OPEN	21	TIMBALE
6	RIDE 1	14	RIDE 2	22	CLAVES
7	CRASH 1	15	CRASH 2	23	CHINA

vvv=0~15 Parameter value

Value	0	.....	8	.....	15
Mode					
Level	min	.....		.....	max
Sens	min	.....		.....	max
Tune	low	.....	0	.....	high
Pan	left	.....	center	.....	right

\*Parameter value of Pan ranges from "1" to "15".

### 2.2.2 MIDI IN KEY NO.

Status	11110000	F0H	System exclusive
Kawai ID	01000000	40H	
Channel no.	0000nnnn	0nH	0~15
Function no.	00010000	10H	Parameter change
Group no.	00000010	02H	Drum machine group
Machine ID	00000001	01H	R-100 ID no.
Data	00000001	01H	Sub status (MIDI in key information)
Data	0kkkkkkk		Key no. (0~127)
Data	000ddddd		Instrument no. See 2.2.1
EOX	11110111	F7H	End of exclusive

### 3. PATTERN, SONG AND CHAIN DATA FORMAT

#### 3.1 PATTERN DATA

1	0ppppppp	Pattern no.	ppppppp	0~99	
2	0nnnnnnn	Bar count	nnnnnnn	0~99	total bar number
3	0ttttttt	Beat	ttttttt	1~99	
4	000TTTTT	Measure	TTTTT	4, 8 or 16	
5	00000000				
6	00000001				
7	xxxxxxx	Pattern length low	xxxxxxx	0~255	
8	xxxxxxx	Pattern length high	xxxxxxx	0~255	
9	ttttttt	Timing data	ttttttt	0~191	] a sound data
10	0vvvvvvv	Volume data	vvvvvvv	0~127	
11	000ddddd	Instrument no.	ddddd	0~23 See 2.2	
12	tttppppp	Tune & Pan data	tttpp	0~15 See 2.2	
	.				
	110000xx	Timing count mark			
	.				
	110000xx	Bar end mark			
	.				
	11000100	Pattern end mark			

Sound data include four data bytes, timing data, volume data, instrument no., and tune & pan data, and are arrayed in timing order.

**Pattern length**  
Pattern length counted by a unit of one sixteenth note.

**Timing data**  
A value counted by a unit of one 192nd note from every head of the bar.  
In case the value exceeds 191 "timing data overflow count (C1H)" will be placed for easier counting.

**Volume data**  
A data processed in the R-100 system and not always correspond to the MIDI velocity data.

**Bar end mark (C2H)**  
This mark (C2H) is placed at the end of the bar. If "timing data overflow count" appears at the end of the bar, "C3H" will be placed instead of "C1H" and "C2H".

**Pattern end mark (C4H)**  
This mark (C4H) is placed at the end of the pattern data.

If sound data do not exist in a pattern, the pattern data include following ten bytes.

1	0ppppppp	Pattern no.	ppppppp	0~99
2	00000000	00H Bar count		0
3	00000100	04H Beat		
4	00000100	04H Measure		
5	00000000	00H		
6	00000001	01H		
7	00010000	10H Pattern length low		
8	00000000	00H Pattern length high		
9	11000011	C3H Bar end mark		
10	11000100	C4H Pattern end mark		

Each data is divided into high and low nibbles when transmitted.

#### 3.2 SONG DATA

1	0sssssss	Song no.	sssssss	0~99	
2	pppppppp	Total part count low	pppppppp	0~999	
3	000000pp	high			
4	ffffffff	First pattern no.	ffffffff	0~99	
5	aaaaaaaa	] Song title by ASCII code			
	.				
	.				
	.				
20	aaaaaaaa				
21	xxxxxxx		xxxxxxx	39 FFH : over dub data exist. 0 : not exist.	
22	00100111				
23	rrrrjjjj	Repeat & Jump data count	rrrr jjjj	0~10 repeat count 0~10 jump count	
	ssssssss	Start part low		] one repeat data	
	000000ss	high	ssssssss		0~999
	eeeeeeee	End part low			
	000000ee	high	eeeeeeee		0~999
	0000cccc	Repeat count	cccc	1~10	
	.				
	ssssssss	Start part low		] one jump data	
	000000s	high	ssssssss		0~999
	eeeeeeee	Destination part low			
	000000ee	high	eeeeeeee		0~999
	0000cccc	Jump count	cccc	1~10	
	.				
	0ppppppp	Pattern no.	ppppppp	0~99	
	zvvvvvvv	Level change value	z=1:- z=0:+ vvvvvvv	0~127	
	zttttttt	Tempo change value	z=1:- z=0:+ ttttttt	0~127	
	0000000x	Over dub flag	x:1 over dub data exist. x:0 not exist.		
	.				
	.				
	1101000x	Song end mark	x:1 followed by over dub data x:0 data end		
	000ddddd	Instrument no.		Over dub instrument	
	tttttttt	Timing data		See 3.1	
	000xxxxx	Timing data overflow count		] one over dub data	
	0xxxxxxx	Bar count			
	xxxxxxx	Part count low			
	xxxxxxx	high			
	11111111				
	11111111				
	0vvvvvvv	Volume data			
	tttppppp	Tune & pan data			
	11010x10	Over dub end mark	x:1 followed by next over dub data x:0 data end		

Over dub data (one instrument only)

An absolute trigger timing of the instrument in SONG is expressed by "timing data", "timing data overflow count", "bar count" and "part count".  
("Part count" is a total part number including repeat or jump.)

Each data is divided into high and low nibbles when transmitted.

### 3.3 CHAIN DATA

1	0sssssss	Chain no.	sssssss	0-99		
2	pppppppp	Total step count low	pppppppppp	0-999		
3	00000pp	high				
4	fffffff	First song no.	fffffff	0-99		
5	aaaaaaaa	Chain title by ASCII code				
.	.					
.	.					
20	aaaaaaaa					
21	xxxxxxx		xxxxxxx	FFH: over dub data exist. 0: not exist.		
22	ttttttt		ttttttt	39: initial tempo off 40-250: initial tempo value		
23	rrrrjjjj		Repeat & Jump data count	rrrr jjj	0-10 0-10	
	sssssss		Start step low	sssssss	0-999	one repeat data
	00000s		high			
	eeeeeee		End step low	eeeeeee	0-999	
	00000ee	high				
	0000ccc	Repeat count	ccc	1-10		
	.					
	sssssss	Start step low	sssssss	0-999	one jump data	
	00000s	high				
	eeeeeee	Destination step low	eeeeeee	0-999		
	00000ee	high				
	0000ccc	Jump count	ccc	1-10		
	.					
	0pppppp	Song no.	ssssss	0-99	one step data	
	zvzzvvvv	Level change value	z=1:- z=0:+ vvvvvv	0-127		
	ztttttt	Tempo change value	z=1:- z=0:+ tttttt	0-127		
	000000x	Over dub flag	x:1 over dub data exist. x:0 not exist.			
	.					
	.					
	110100x	Chain end mark	x:1 followed by over dub data x:0 data end			
	0000000	Instrument no.	Over dub instrument			
	ttttttt	Timing data	See 3.1		one over dub data	
	000xxxxx	Timing data overflow count				
	0xxxxxxx	Bar count				
	xxxxxxx	Part count low				
	xxxxxxx	high				
	xxxxxxx	Step count low				
	xxxxxxx	high				
	0vvvvvv	Volume data				
	ttttpppp	Tune & pan data				
	11010x10	Over dub end mark	x:1 followed by next over dub data x:0 data end			

**Over dub data (one instrument only)**

An absolute trigger timing of the instrument in SONG is expressed by "timing data", "timing data overflow count", "bar count", "part count" and "step count".  
("Part count/step count" is a total part/step number including repeat or jump respectively.)

Each data is divided into high and low nibbles when transmitted.

# 19. Specifications

## ■ R-100 DIGITAL DRUM MACHINE

- **Storage capacity (max.)**

Patterns      100  
Songs        100  
Chains        10

- **Sound sources: 24**

BD 1/2/3, SD 1/2/3  
TOM HI/MID/LO, HH CLOSE/OPEN  
RIDE 1/2, CRASH 1/2, CHINA,  
COWBELL, CLAPS, SHAKER, AGOGO,  
CONGA, TAMBOURINE, TIMBALE,  
CLAVES

- **Control and Indicators**

Stereo volume  
Metronome volume  
GROUP SELECT key and LED indicators  
MULTI key and LED indicators  
INST. SELECT key and LED indicators  
ERASE/NOTE SELECT key  
NOTE SELECT LED indicators  
Instrument pads (1) ~ (8)  
Keypad (0 ~ 9)  
INCREMENT key (>)  
DECREMENT key (<)  
ENTER/TAP/REPEAT key  
BACK/TIMING ADJUST/FLAM key  
TEMPO key and LED indicator  
START key  
STOP/CONT. START key  
Job LED indicators

- **Memory cartridge slot (for RC-16)**

- **Rear Panel**

Phones  
Stereo outputs (L/MONO & R)  
Individual channel outputs      1 ~ 8  
MIDI                                  IN/OUT/THRU  
SYNC                                  IN/OUT  
TAPE/CLOCK                          IN  
TAPE                                    OUT  
CLOCK                                  OUT  
Foot switch jacks                    HH CLOSE/OPEN  
    START/STOP  
  
TRIG. OUT  
METRONOME

- **Power consumption**              10W

- **Overall dimensions**              436 (W) x 251 (D) x 74 (H) mm  
    [17 1/8" (W) x 9 7/8" (D) x 2 15/16" (H)]

- **Weight**                                4.0 kg (9 lbs.)

- **Accessories**                        Owner's Manual  
    Warranty certificate  
    Data cassette

- **Options**                                F-1 Foot switch  
    RC-16 Memory cartridge









**KAWAI**