

MIDWAYS **OMEGA RACE**

Parts and Operating Manual

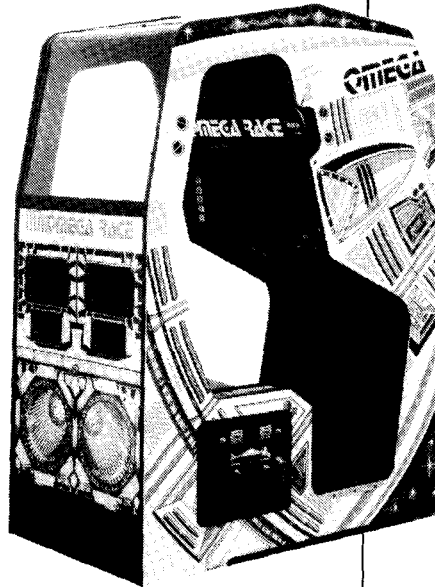

NO. 929 UPRIGHT



NO. 894 SITDOWN

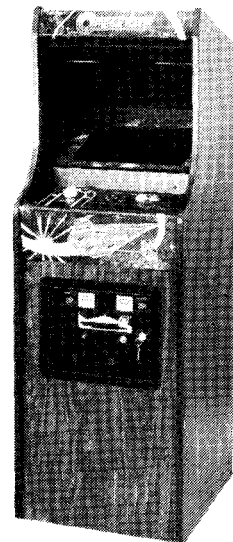

NO. 931 MINI

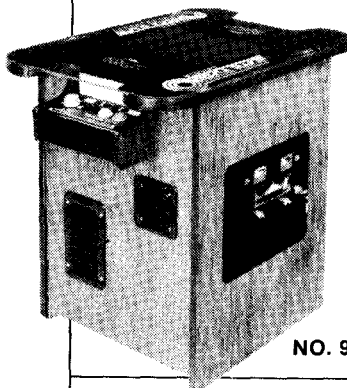

NO. 930 COCKTAIL



MIDWAY MFG. CO.

A BALLY COMPANY

10750 W. GRAND AVENUE
FRANKLIN PARK, ILLINOIS 60131
USA

Phone: (312) 451-1360 Cable Address: MIDCO Telex No.: 72-1596

TABLE OF CONTENTS

	PAGE
I. INTRODUCTION	1
II. LOCATION AND SETUP	3
A. MAJOR DIFFERENCES	3
B. INSPECTION	3
C. INSTALLATION	13
D. SELF TEST	14
E. GAME VOLUME ADJUSTMENT CONTROLS	14
F. OPTION SWITCH SETTINGS	15
G. PICTURE SIZE — HORIZONTAL AND VERTICAL	15
H. GAME OPERATION	17
III. MAINTENANCE AND REPAIR	31
A. CLEANING	31
B. FUSE REPLACEMENT	31
C. OPENING THE CONTROL PANEL	34
D. REMOVAL OF MAIN DISPLAY GLASS AND T.V. BEZEL	39
E. T.V. MONITOR REPLACEMENT	43
F. PRINTED CIRCUIT BOARD REPLACEMENT	47
G. OPENING THE ATTRACTION PANEL	51
H. COIN DOOR MAINTENANCE	54
I. REPLACING ULTRAVIOLET TUBE	59
IV ILLUSTRATED PARTS LIST	
OMEGA RACE — CONTROL KNOB ASSY.	61
OMEGA RACE — CONTROL KNOB ASSY. — PARTS LIST	61
NO. 929 — OMEGA RACE UPRIGHT — FRONT	62
NO. 929 — OMEGA RACE UPRIGHT — FRONT — PARTS LIST	63
NO. 929 — OMEGA RACE UPRIGHT — REAR ACCESS	64
NO. 929 — OMEGA RACE UPRIGHT — REAR ACCESS — PARTS LIST	65
NO. 929 — OMEGA RACE UPRIGHT — FLUORESCENT FIXTURE ASSYS.	66
NO. 929 — OMEGA RACE UPRIGHT — FLUORESCENT FIXTURE ASSYS. — PARTS LIST	67
NO. 894 — OMEGA RACE SIT DOWN	68
NO. 894 — OMEGA RACE SIT DOWN — PARTS LIST	69
NO. 894 — OMEGA RACE SIT DOWN — FRONT INTERIOR ACCESS	70
NO. 894 — OMEGA RACE SIT DOWN — FRONT INTERIOR ACCESS — PARTS LIST	71
NO. 894 — OMEGA RACE SIT DOWN — REAR INTERIOR ACCESS	72
NO. 894 — OMEGA RACE SIT DOWN — REAR INTERIOR ACCESS — PARTS LIST	73
NO. 894 — OMEGA RACE SIT DOWN — CONSOLE & FLUORESCENT FIXTURE ASSYS.	74
NO. 894 — OMEGA RACE SIT DOWN — CONSOLE & FLUORESCENT FIXTURE ASSYS. — PARTS LIST	75
NO. 931 — OMEGA RACE MINI	76
NO. 931 — OMEGA RACE MINI — PARTS LIST	77
NO. 931 — OMEGA RACE MINI — REAR ACCESS	78
NO. 931 — OMEGA RACE MINI — REAR ACCESS — PARTS LIST	79

TABLE OF CONTENTS (cont'd)

	PAGE
NO. 930 — OMEGA RACE COCKTAIL	80
NO. 930 — OMEGA RACE COCKTAIL — PARTS LIST	81
NO. 930 — OMEGA RACE COCKTAIL — INTERIOR ACCESS	82
NO. 930 — OMEGA RACE COCKTAIL — INTERIOR ACCESS — PARTS LIST	82
OMEGA RACE — TRANSFORMER BOARD ASSY.	84
OMEGA RACE — TRANSFORMER BOARD ASSY. — PARTS LIST	85
OMEGA RACE — FILTER ASSY.	86
OMEGA RACE — FILTER ASSY. — PARTS LIST	87
OMEGA RACE — ALL VERSIONS — FRONT DOOR ASSY.	88
OMEGA RACE — ALL VERSIONS — FRONT DOOR ASSY. — PARTS LIST	89
OMEGA RACE — VECTOR MOTHER BOARD	90
OMEGA RACE — GAME BOARD	91

V. SCHEMATICS & WIRING DIAGRAMS

WIRING DIAGRAM — UPRIGHT	91
WIRING DIAGRAM — MINI	92
WIRING DIAGRAM — COCKTAIL	93
WIRING DIAGRAM — SIT DOWN	94
POWER SUPPLY P.C.B. — COMPONENT LAYOUT	95
POWER SUPPLY P.C.B. — SCHEMATIC	96
MOTHER BOARD — COMPONENT LAYOUT	97
MOTHER BOARD — SCHEMATIC	98
GAME BOARD (DAUGHTER BOARD) — COMPONENT LAYOUT	100
GAME BOARD (DAUGHTER BOARD) — SCHEMATIC	101

OMEGA RACE

IMPORTANT NOTE

DO NOT plug in your new game yet. Before you do anything to your game, we recommend that you read sections I. and II. of this manual completely. It will not take more than a few minutes and it may be very helpful.

I. INTRODUCTION

OMEGA RACE is a one or a two player game with one exception; the "SIT DOWN" model. This model is for one player at a time ONLY. The other models are the "UPRIGHT", "MINI", and "COCKTAIL TABLE". When the two player mode is selected on one of these, the players take turns at the controls to fly their space ship(s) through the game course. If you have purchased the cocktail table model of this game, the rules of play are the same. The only **difference** is that in the two player mode of the cocktail table game, the picture flips to face you when it is your turn.

When playing this game, you are the pilot of an **Omegan Space Fighter** in training to defend **Omega's Star Colonies**. You are stationed in space to destroy as many waves of attacking enemy droid ships as possible.

You begin your training with a small number of droid ships in the first wave of attackers and gradually build your skill until there is a maximum number of 12 attacking droid ships per wave. These attacking ships not only move independently and fire at you, they also drop two different kinds of space mines to block your path and your shots at them.

As your skill level increases, the speed with which the droid ships attack is gradually increased and their shots at you become more accurate.

Bonus ships are awarded to you periodically throughout the game as you reach or pass certain preselected point values. Each enemy ship and mine has a point value as listed in Figure 1.





PHOTON MINE		350 POINTS
VAPOR MINE		500 POINTS
DROID SHIP		1000 POINTS
COMMAND SHIP		1500 POINTS
DEATH SHIP		2500 POINTS

FIGURE 1

The object of the game is to survive as long as possible while destroying as many attacking droid ships and space mines as you can. As you do this, each following wave of attackers will be harder to destroy.

II. LOCATION AND SETUP

A. MAJOR DIFFERENCES:

A major new feature of your OMEGA RACE game is the addition of an accounting mode. This mode provides the owner/operator with coin and credit information, numbers of one and two player games played, free ships given, average score per game, highest score, average seconds per game, maximum seconds per game, and current credits on the game.

Your OMEGA RACE game will remember this information even if the power to it is turned off for a period of time.

B. INSPECTION

1. Remove the game from its shipping crate.
2. Inspect the entire outside of it for any signs of damage.
 - a. Any scratches?, dents?, cracks?
 - b. Any broken controls?
 - c. Any broken glass or plastic?
 - d. Just look it over closely and make a note of any signs of damage.
3. Remove the shipping cleats from the bottom of the cabinet. See Figure 2.
4. Install the four levelers, one at each corner of the cabinet. See Figure 2.
 - a. Level the cabinet.
5. Open the cabinet and inspect the inside of the game for any signs of damage. See Figure 3.
 - a. Also check to make sure all plug-in connectors on the wire harness are firmly seated.

NOTE: All connectors or plugs are keyed so they will only go together when all pins are properly lined up.
 - b. Replug any connectors found unplugged. **DO NOT FORCE PLUGS ONTO CONNECTORS. DO NOT FORCE PLUGS TOGETHER.** If it won't go on easily, assuming the keys are lined up, it either does not belong there or is damaged.
 - c. Make sure all printed circuit boards (P.C.B.'s) are firmly seated in their connectors. See Figure 3. These connectors are also keyed. The P.C.B.'s will only go into them one way without being damaged.
 - d. Note the location of the game's serial number. See Figure 3.
 - e. Check all major sub assemblies to be sure they are mounted securely. These are called out in Figure 4.
 - i. Power supply.
 - ii. Control panel(s).
 - iii. T.V. monitor.
 - iv. Other P.C.B.'s and/or P.C.B. rack, etc.
 - v. Power supply filter assembly.
 - vi. Transformer board assembly.

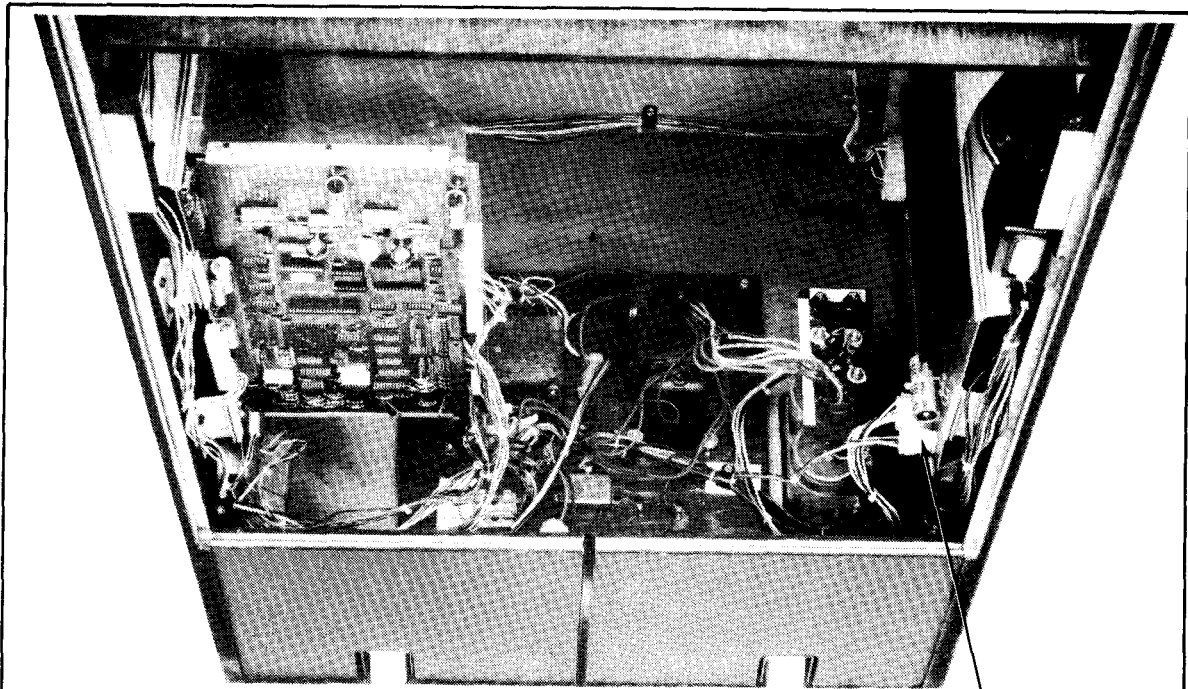

UPRIGHT

**CHECK THAT ALL
PLUG IN CONNECTORS
ARE SEATED FIRMLY**

SERIAL NUMBER

**ON/OFF
SWITCH**

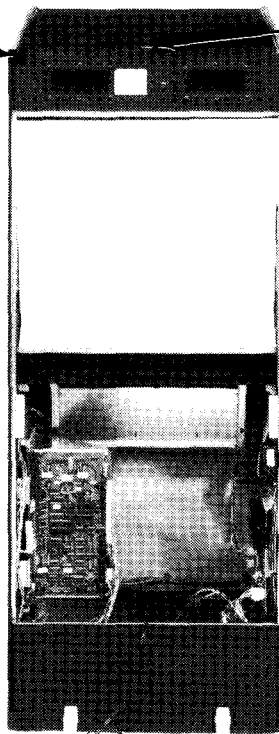

UPRIGHT

FIGURE 3

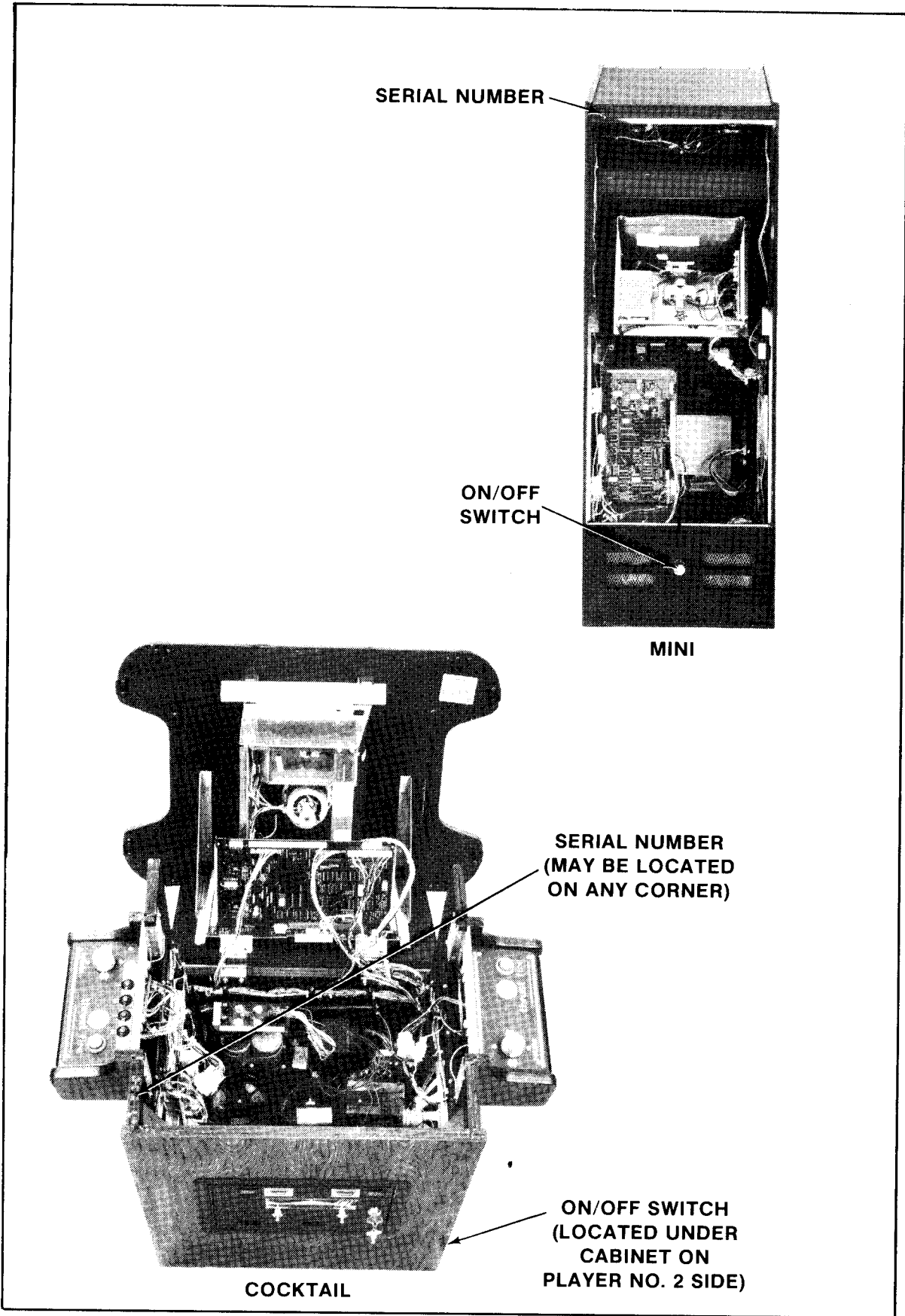

FIGURE 3 (cont'd)

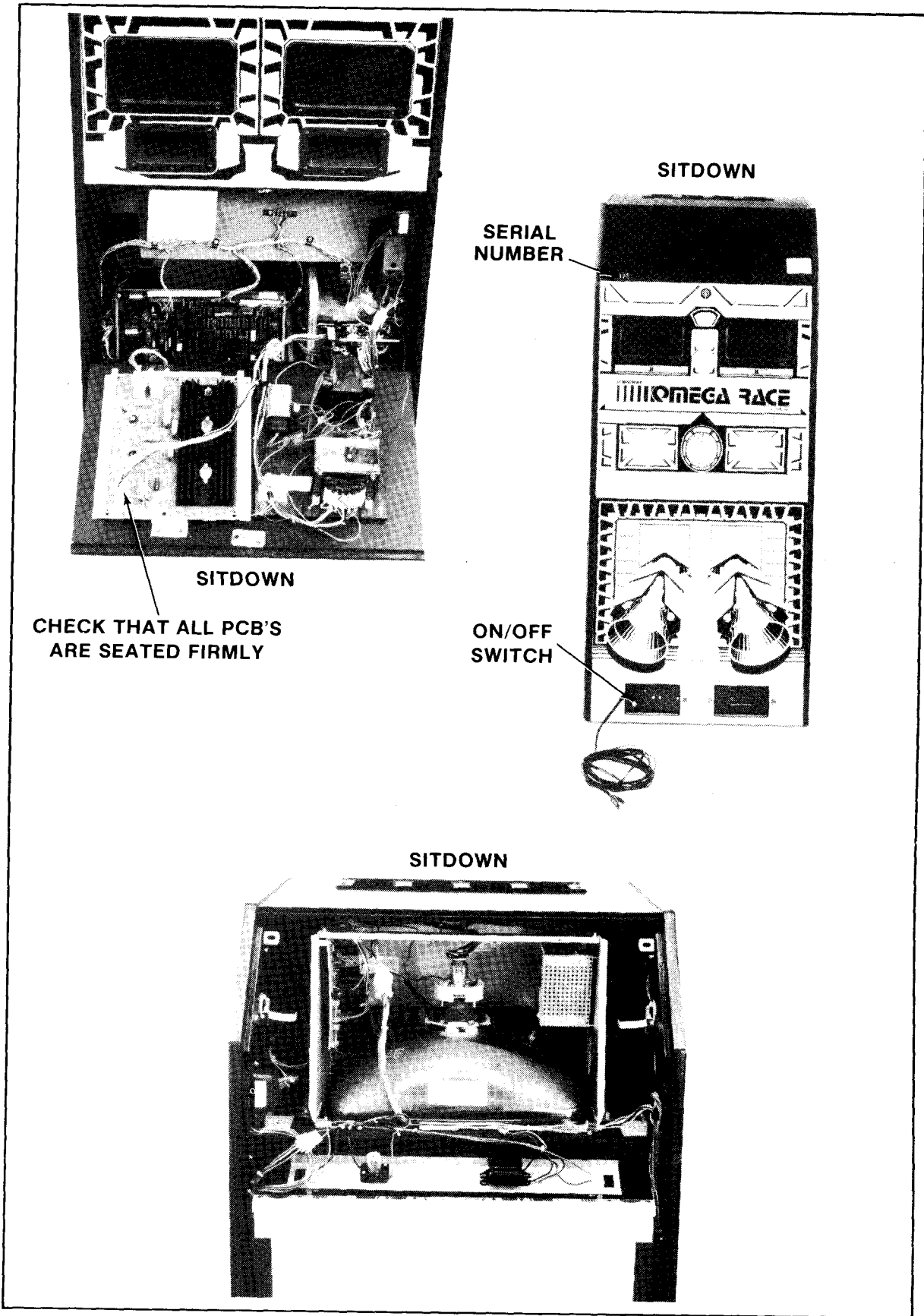

FIGURE 3 (cont'd)

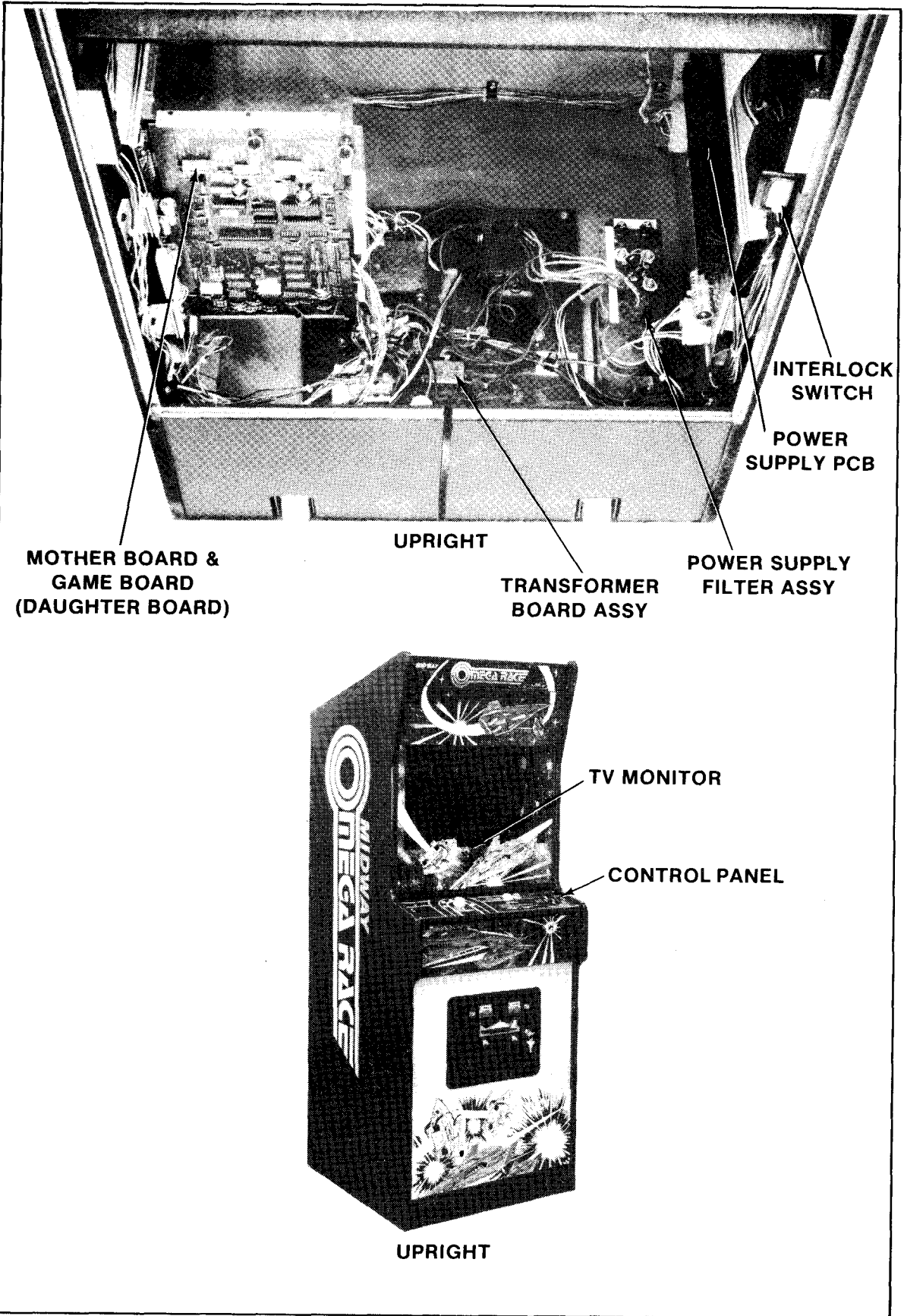

FIGURE 4

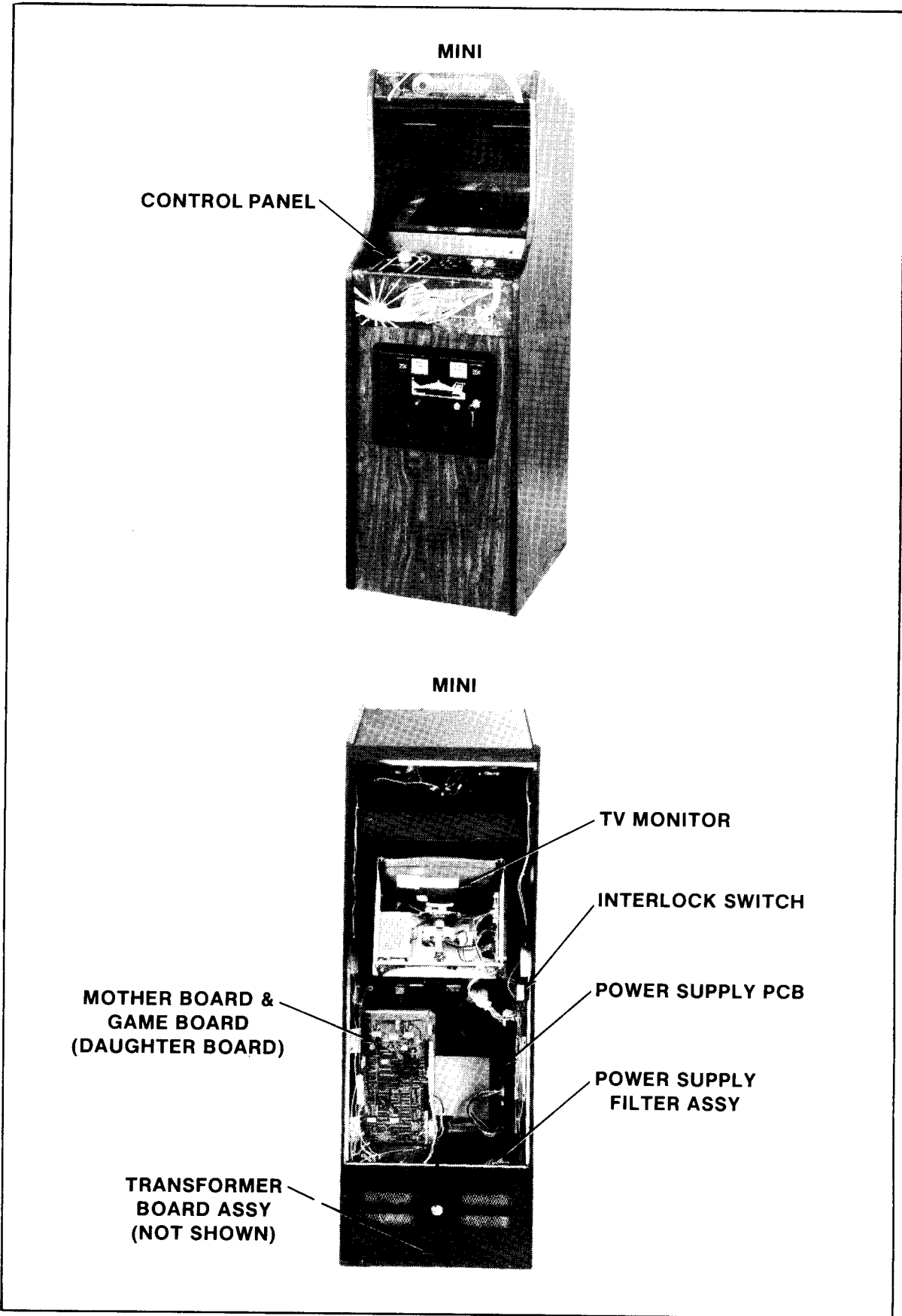
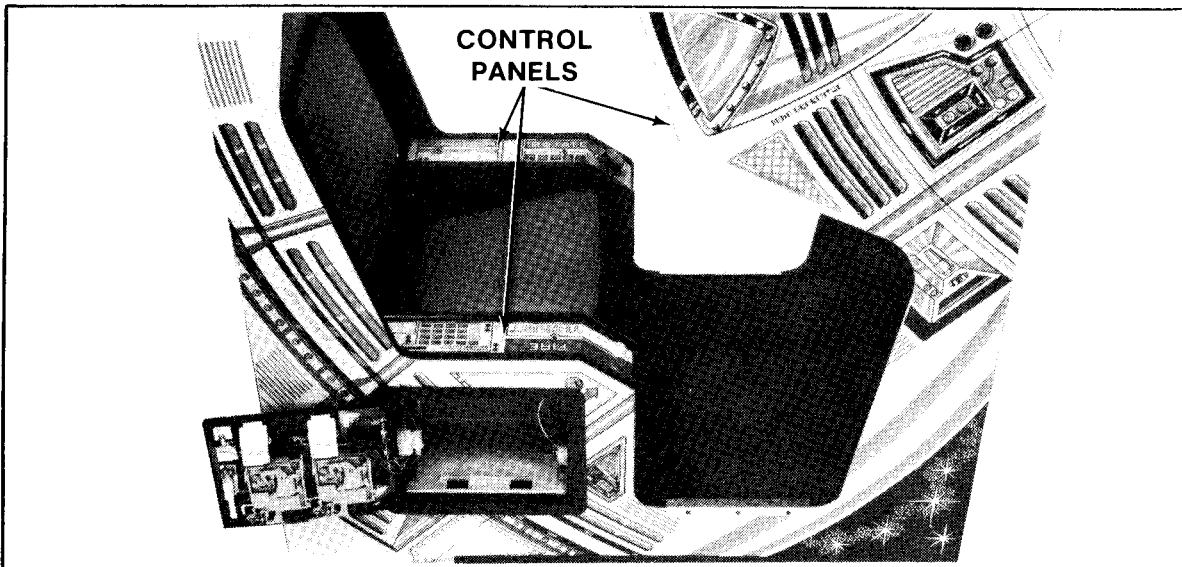
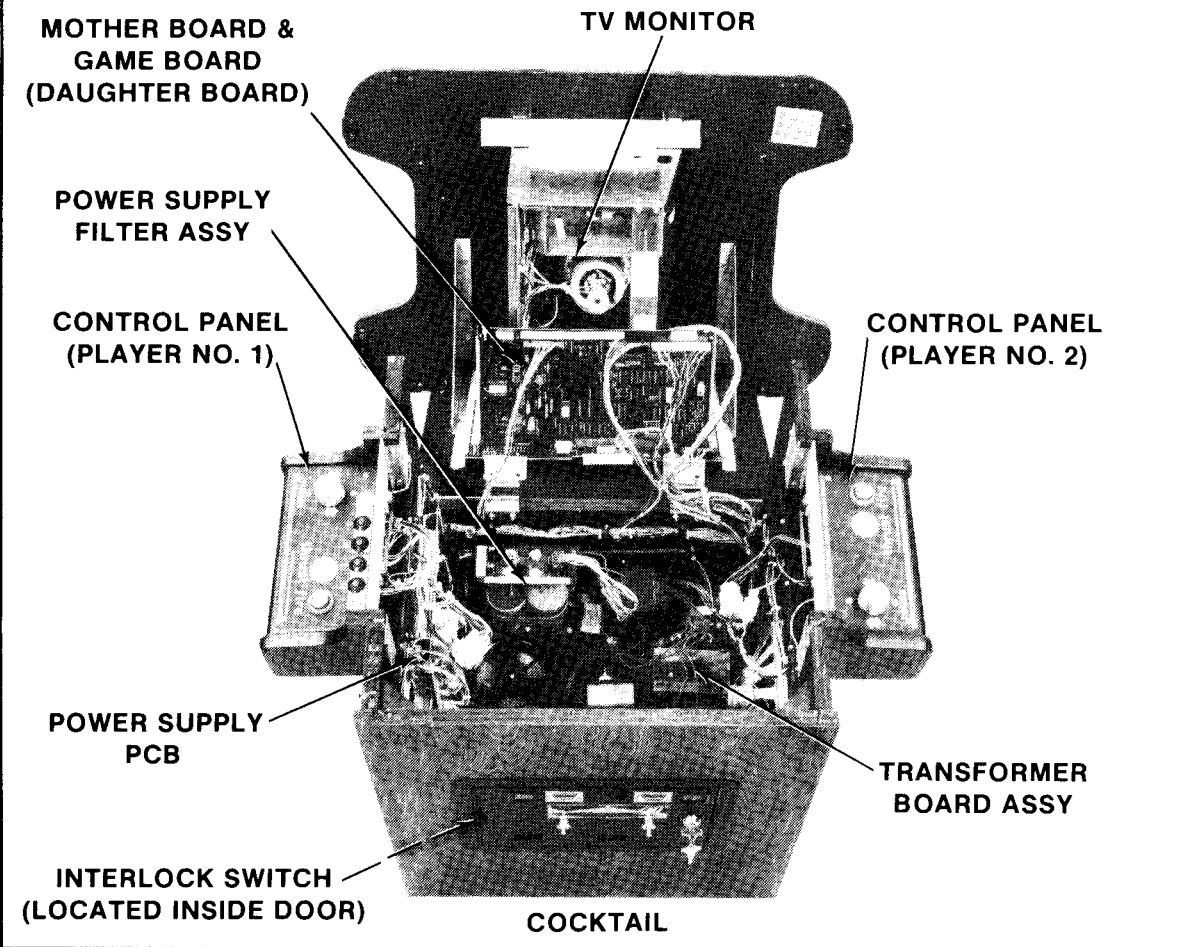

FIGURE 4 (cont'd)



**CONTROL
PANELS**

SITDOWN



**MOTHER BOARD &
GAME BOARD
(DAUGHTER BOARD)**

TV MONITOR

**POWER SUPPLY
FILTER ASSY**

**CONTROL PANEL
(PLAYER NO. 1)**

**CONTROL PANEL
(PLAYER NO. 2)**

**POWER SUPPLY
PCB**

**TRANSFORMER
BOARD ASSY**

**INTERLOCK SWITCH
(LOCATED INSIDE DOOR)**

COCKTAIL

FIGURE 4 (cont'd)

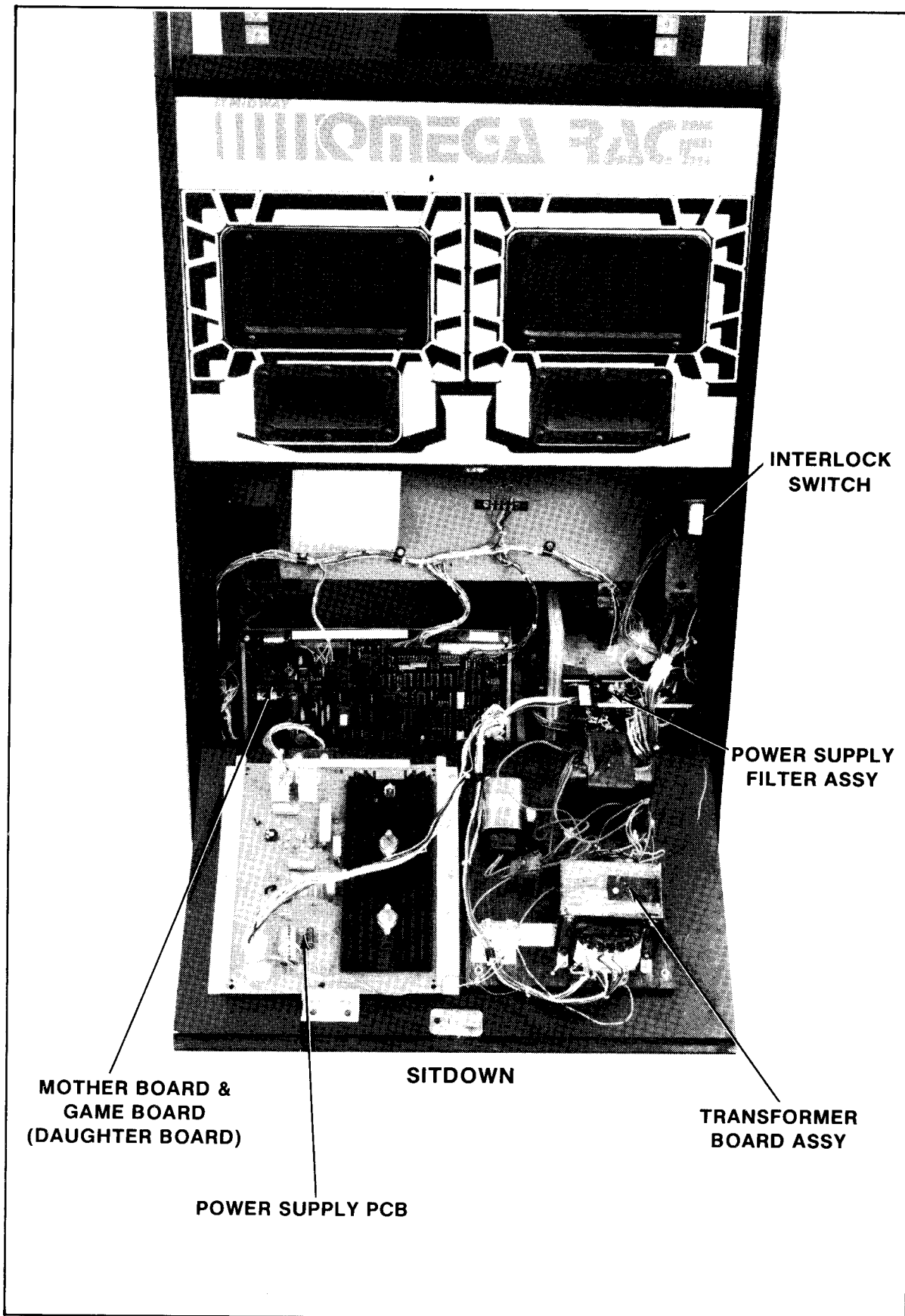

FIGURE 4 (cont'd)

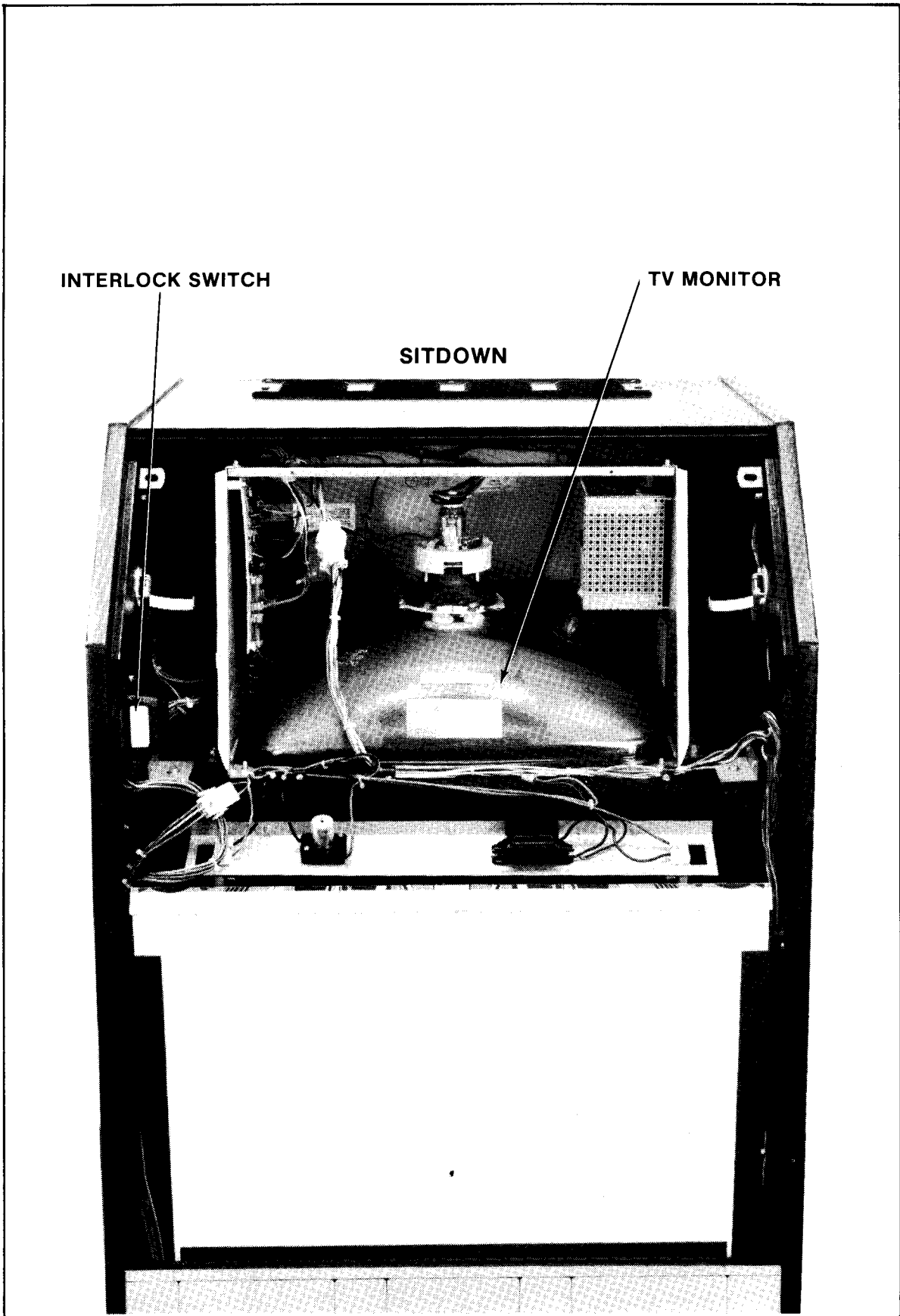

FIGURE 4 (cont'd)

6. Make a note of any problems that can't be easily corrected.
7. Call your distributor and/or service man about your problem list.

C. INSTALLATION

1. Location requirements

- a. Power
 - i. Domestic 110V @ 60 Hz
 - ii. Foreign 200 to 240V @ 50 Hz
- b. Temperature - 32° to 100°F (0° to 38°C)
- c. Humidity - Not over 95% relative
- d. Space required:
 - i. Upright 25-1/2"W x 30"D (64 x 75 cm)
 - ii. Mini 20"W x 24"D (50 x 60 cm)
 - iii. Cocktail 32"W x 22"D (80 x 55 cm)
 - iv. Sit down 26-1/2"W x 48"D (67 x 120cm)
- e. Game height:
 - i. Upright 70" (175 cm)
 - ii. Mini 59" (148 cm)
 - iii. Cocktail 29" (73 cm)
 - iv. Sit down 64-1/2" (164 cm)

2. Voltage Selection

Your game is designed to work properly on the line voltage where you are located. Check your line voltage with a meter to determine what its value is. Then check the power input wires to the main power supply transformer on your game to be sure they are connected to taps which correspond to your line voltage value.

If the power input wires to the main power supply transformer are not connected to taps which correspond to your local line voltage, move them to the proper taps.

If the line voltage in your area falls outside the upper or lower limits of the range of inputs covered by the main power supply transformer, **DO NOT PLUG YOUR GAME IN** until you have talked with your distributor and/or service man and obtained a solution to this problem. Otherwise you could damage your game.

3. Interlock and power On/Off switches - See Figure 4.

- a. To help prevent the possibility of getting an electric shock while working inside the game cabinet, interlock switches have been installed at each cabinet access door (this **DOES NOT** include the coin door in the Upright, Mini, and Sit Down models).
- b. When any access door is opened, the interlock switch installed there turns off all power to the game.
- c. Check each interlock switch for proper operation.
 - i. After checking the line voltage in your area and determining that the input wires to the main power supply transformer of your game are connected

properly — or — after obtaining a solution to your over or under voltage problem from your distributor and/or your service man, plug the game into your A.C. wall outlet.

- ii. The game On/Off switches for all four models are located as shown in Figure 3. Turn the game on and allow it to warm up for a few minutes.
- iii. Slowly open each access door to the game (this does not include the coin door on the Upright, Mini, and Sit Down models).
 - As the door is opened approximately 1" (2.54 cm) the power to the game should go off (the T.V. monitor, all the lights, and all sounds will stop).
 - If this does not happen, check the interlock switch by this door to see if it has broken loose from its mounting or if it is stuck in the "ON" position.
 - If the switch is found to be bad, turn the game off, unplug it, and replace the interlock switch.
 - Plug the game back into the wall outlet, close the access door, and turn it on.
 - After the game has warmed up, repeat the above interlock switch test.
- iv. When the interlock switch is working properly and turns the power to the game off, power may be restored to the game with the access door(s) open. Take hold of the interlock switch plunger and **gently** pull it out. **THIS IS TO BE USED ONLY FOR SERVICING THE GAME.**

D. SELF-TEST

Your new game will Self-Test itself to see if it has any bad parts. The information it receives while testing itself will be shown on the T.V. monitor. Some information can also be heard through the game's speaker system. See Step H. GAME OPERATION for a more detailed discription of this function.

When there is a bad result according to the Self-Test, call your distributor and/or service man to have the trouble fixed unless it is something you can do yourself (such as replace a bad RAM or ROM chip).

E. GAME ADJUSTMENT CONTROLS: See Figure 5.

The game volume control pots are located on the left hand side of the daughter board as you face it. There are only two pots, one above the other. For adjustment, they may be reached through the rear access door on the Upright and Mini models, and through the front access door on the Sit Down models. On the Cocktail Table model, you will need to open the table top to reach them.

As you face them, the right pot controls the right speaker sounds and the left pot controls the left speaker sounds.

To make the sounds louder, turn the wheels on the pots in this direction → as you face them.

To make the sounds **less** loud, turn the wheels on the pots in this direction ← as you face them.

F. OPTION SWITCH SETTINGS

To change the option switch settings, you DO NOT have to take the daughter board out of the game. They can be easily reached through the rear access door on the Upright and Mini models, and through the front access door on the Sit Down models. On the Cocktail Table model, you have to open the table top to reach them.

When changing any options, ALWAYS perform the Self-Test to be sure the display on the T.V. monitor indicates your new selections. (It is a good idea to actually change the option switches while the game is in the Self-Test mode so you can see the result of the change right then on the screen.) This assures you the switches have worked properly and that no switches were accidentally moved that were not meant to be. (These switches are small and this can happen.)

The option switch settings and what they will make the game do are shown in Figure 6. See Figure 5 for option switch locations.

G. PICTURE SIZE — HORIZONTAL AND VERTICAL

The picture on the monitor may be expanded or contracted in either the horizontal or vertical direction. This function is controlled by two pots on the mother board located directly behind the daughter board. They are marked "H" for horizontal and "V" for vertical. You will have to reach around behind the daughter board to make this adjustment.

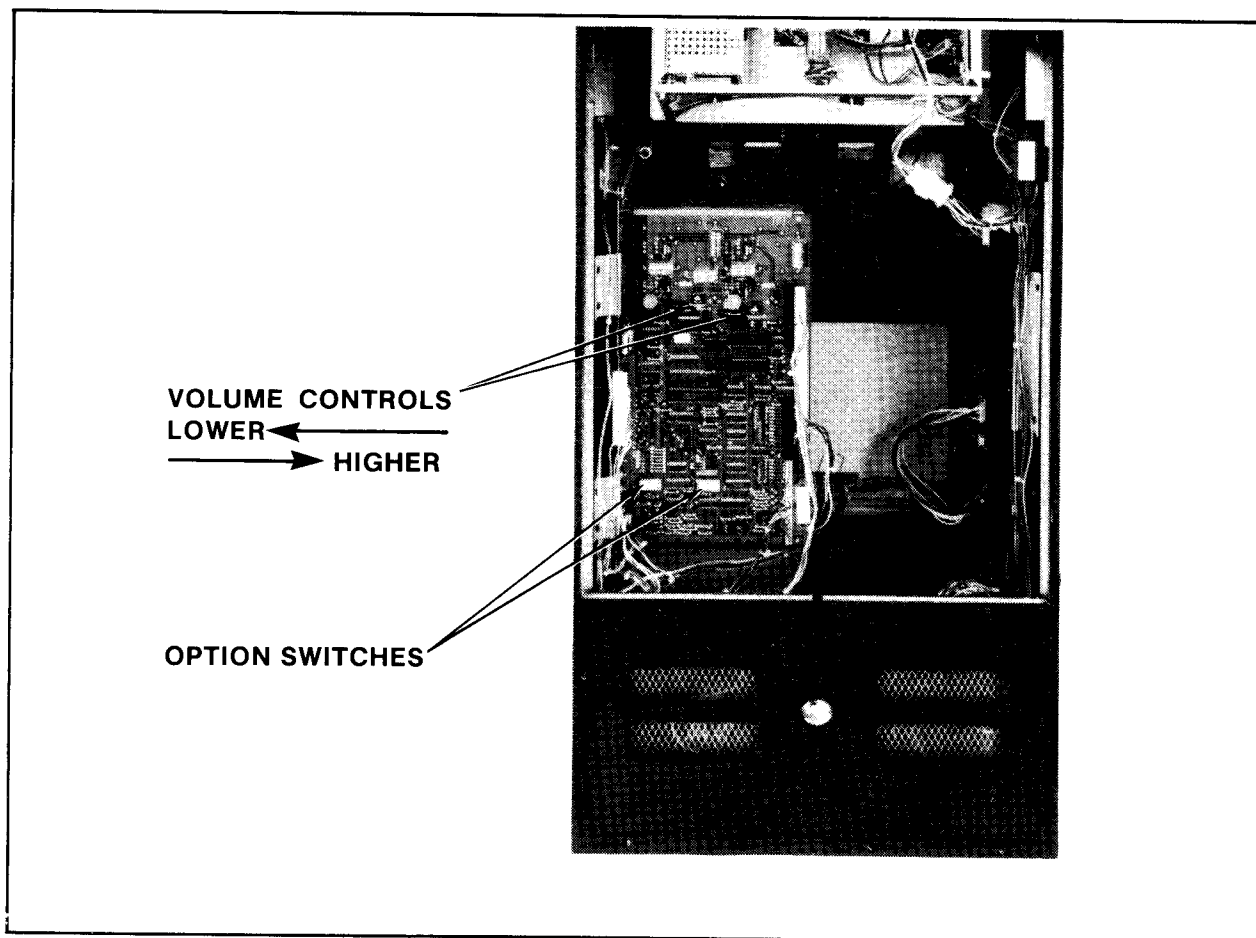

FIGURE 5

//////////////////////////////////// DIP SWITCH #1 //////////////////////////////////////					
1st BONUS SHIP AWARDED AT:					
SW#1	SW#2				
ON	ON	40,000	POINTS		
OFF	ON	50,000	POINTS		
ON	OFF	70,000	POINTS		
OFF	OFF	100,000	POINTS		
2nd AND 3rd BONUS SHIPS AWARDED AT:					
SW#3	SW#4	2nd BONUS SHIP		3rd BONUS SHIP	
ON	ON	150,000	POINTS	250,000	POINTS
OFF	ON	250,000	POINTS	500,000	POINTS
ON	OFF	500,000	POINTS	750,000	POINTS
OFF	OFF	750,000	POINTS	1,500,000	POINTS
SHIPS PER CREDIT					
SW#5	SW#6				
ON	ON	1 CREDIT = 2 SHIPS /	2 CREDITS = 4 SHIPS		
OFF	ON	1 CREDIT = 2 SHIPS /	2 CREDITS = 5 SHIPS		
ON	OFF	1 CREDIT = 3 SHIPS /	2 CREDITS = 6 SHIPS		
OFF	OFF	1 CREDIT = 3 SHIPS /	2 CREDITS = 7 SHIPS		
- - - NOT USED - - -					
SW#7 / SW#8					
//////////////////////////////////// DIP SWITCH #2 //////////////////////////////////////					
COINS PER CREDIT					
COIN SWITCH #1 IS CONTROLLED BY SW#1,2,&3					
SW#1	SW#2	SW#3			
OFF	OFF	OFF	1 COIN	1 CREDIT	
ON	OFF	OFF	2 COINS	1 CREDIT	
OFF	ON	OFF	2 COINS	3 CREDITS	
ON	ON	OFF	3 COINS	4 CREDITS	
OFF	OFF	ON	4 COINS	5 CREDITS	
ON	OFF	ON	1 COIN	5 CREDITS	
OFF	ON	ON	1 COIN	3 CREDITS	
ON	ON	ON	1 COIN	2 CREDITS	
COIN SWITCH #2 IS CONTROLLED BY SW#4,5,&6					
SW#4	SW#5	SW#6			
OFF	OFF	OFF	1 COIN	1 CREDIT	
ON	OFF	OFF	2 COINS	1 CREDIT	
OFF	ON	OFF	2 COINS	3 CREDITS	
ON	ON	OFF	3 COINS	4 CREDITS	
OFF	OFF	ON	4 COINS	5 CREDITS	
ON	OFF	ON	1 COIN	5 CREDITS	
OFF	ON	ON	1 COIN	3 CREDITS	
ON	ON	ON	1 COIN	2 CREDITS	
PLAY MODE					
SW#7					
OFF	FREE PLAY (CREDIT REMAINS AT 4)				
ON	COIN PLAY				
COCKTAIL TABLE MODELS					
SW#8					
ON	THIS IS THE <u>NORMAL</u> POSITION FOR THIS SWITCH IN THE UPRIGHT, MINT, AND SIT DOWN MODELS.				
OFF	THIS IS THE <u>NORMAL</u> POSITION FOR THIS SWITCH IN THE COCKTAIL TABLE MODELS. (IT ENABLES THE GAME TO FLIP THE PICTURE WHEN IT IS THE OTHER PLAYERS TURN AND TO RECEIVE INSTRUCTIONS FROM THE SECOND SET OF CONTROLS.)				

FIGURE 6

H. GAME OPERATION

OMEGA RACE, with the exception of the Sit Down model, is a one or a two player game with a black and white T.V. monitor. The game gives a display which has all the parts shown in Figure 7.

The game has six possible modes of operation: ATTRACT, READY-TO-PLAY, PLAY, HIGH SCORE INITIAL, SELF-TEST, and RECORD KEEPING.

1. Record Keeping Mode:

The Record Keeping mode is a unique mode to give the owner/operator research information about game play activity.

You may enter the Record Keeping mode at any time after the game has been turned on by sliding the Self-Test switch to the "ON" position. See Figure 8. When this is done, the game will react as follows:

- a. If the game is in the Attract mode or the Ready-To-Play mode when the Self-Test switch is moved to the "ON" position, several seconds (5 to 10) will go by and then it will display the Record Keeping ledger.
- b. If the game is in the Play mode when the Self-Test switch is moved to the "ON" position, it will **NOT** go into the Record Keeping mode until **AFTER** the last omegan defender has been destroyed (the game must be over). At this point, several seconds (5 to 10) will go by and then it will display the Record Keeping ledger.

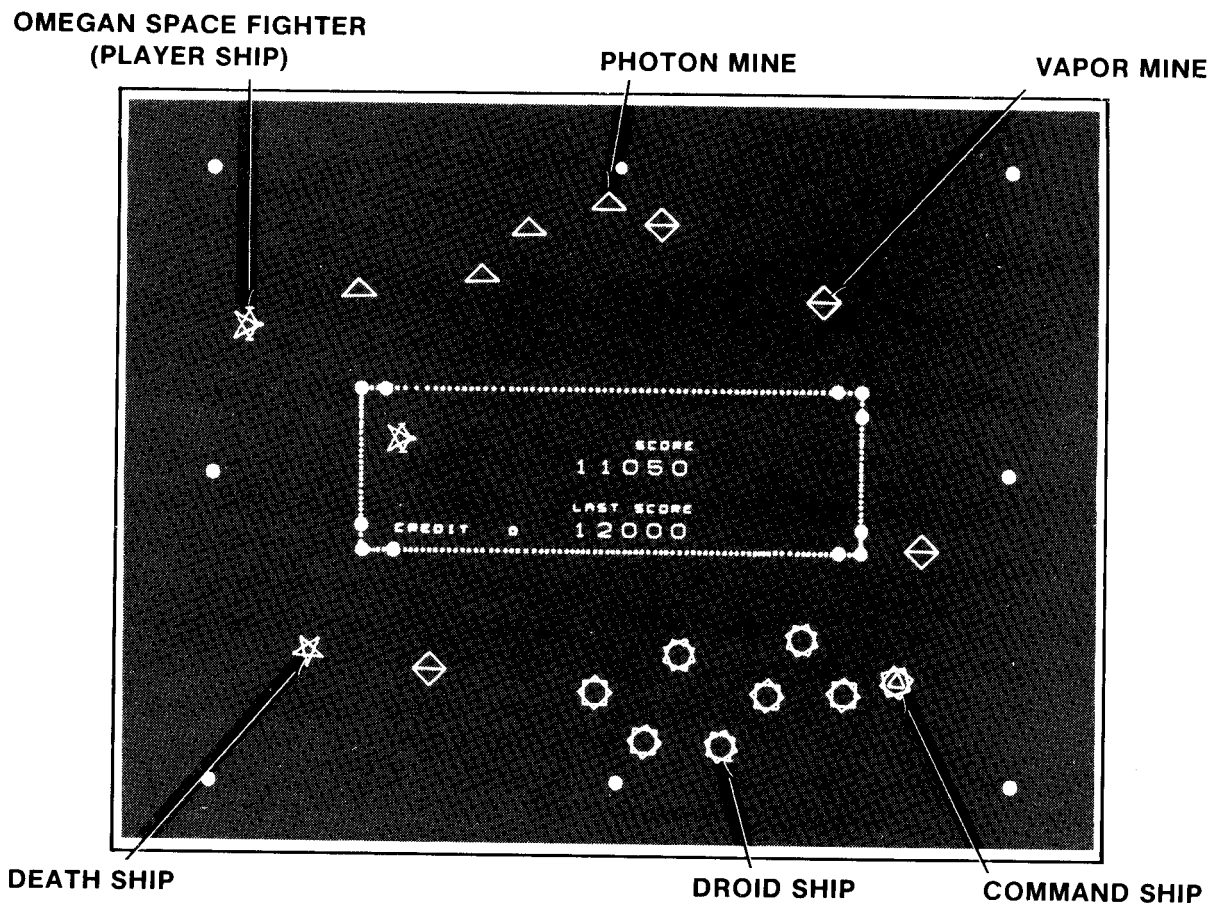

FIGURE 7

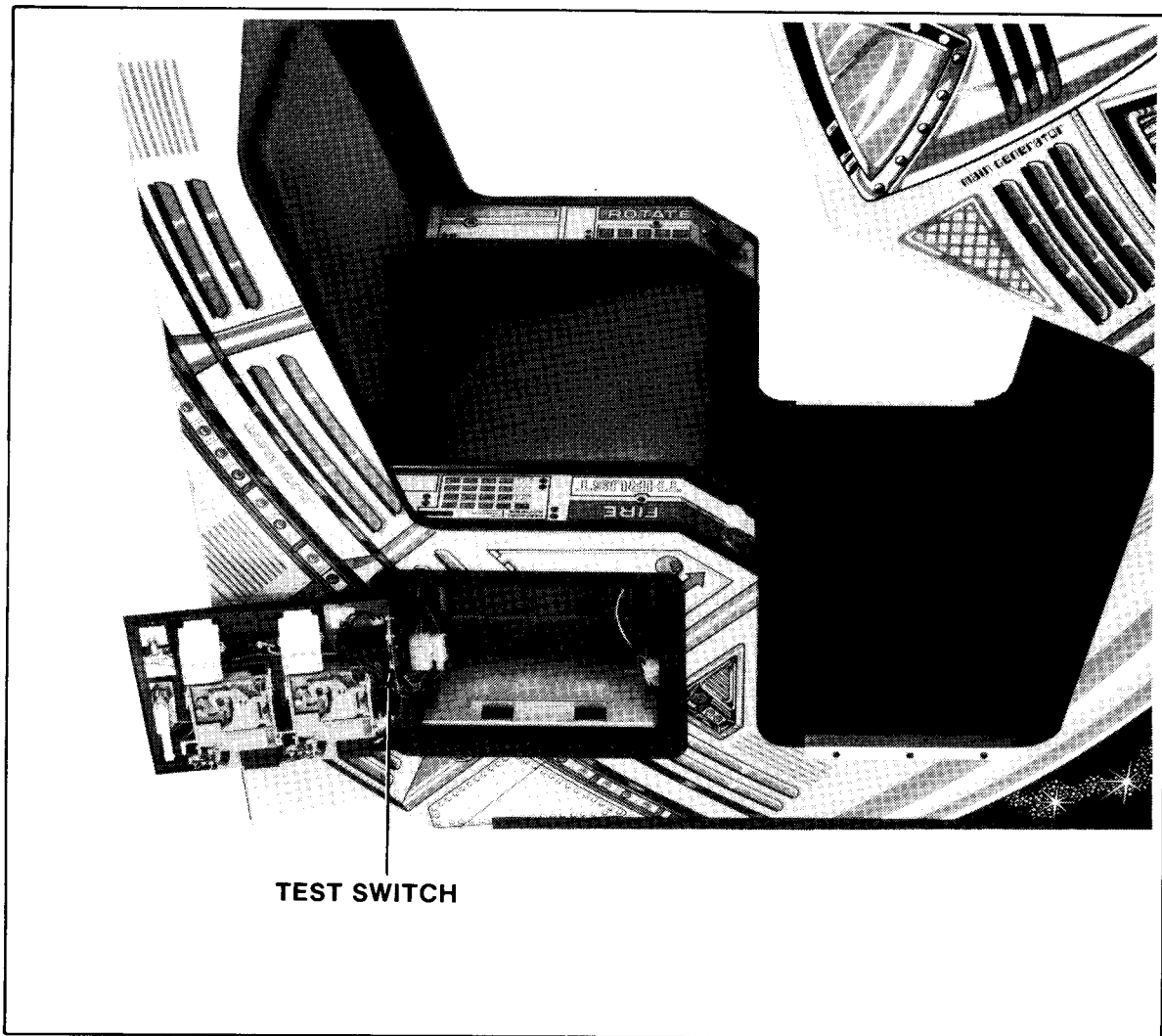

FIGURE 8

- c. When in the Record Keeping mode:
 - i. The T.V. monitor will give the following display: See Figure 9.
 - ii. Anytime a coin acceptor switch is tripped, the game will register a "TEST CREDIT" in the Record Keeping ledger but will not advance the coin counting meter on the coin door.
 - iii. Pushing the "THRUST" button will set the "CURRENT CREDIT" count to zero "0". (This is the last line on the ledger display.)
 - iv. Pushing the "FIRE" button will set the 1 and 2 player high score values to 38,250 points at the same time.
 - v. Holding in the "1 PLAYER 1 CREDIT" button while at the same time pressing the "1 PLAYER 2 CREDIT" button will set **all information** in the Record Keeping ledger to zero "0".
- d. To go from the Record Keeping mode back to the game's other modes (ATTRACT, READY-TO-PLAY, etc.) simply slide the Self-Test switch back to the "OFF" position.

**FIGURE 9
RECORD KEEPING DISPLAY**

COIN CHUTE 1	___	
COIN CHUTE 2	___	
TOTAL CREDITS	___	
TEST CREDITS	___	
	1 CREDIT	2 CREDIT
1 PLAYER GAMES	___	___
*2 PLAYER GAMES	___	___
FIRST FREE SHIP	___	___
SECOND FREE SHIP	___	___
THIRD FREE SHIP	___	___
AVERAGE SCORE	___	___
HIGHEST SCORE	___	___
AVERAGE SEC. PER GAME	___	___
MAXIMUM SEC. PER GAME	___	___
CURRENT CREDIT	___	
*THIS WILL ALWAYS READ ZERO "0" ON THE SIT DOWN MODEL		

2. Self-Test Mode:

The Self-Test mode is a special mode made up of 4 test displays for checking game switches and computer functions. It is the easiest and best way to check for proper operation of the entire game.

You may begin a Self-Test at any time by turning the power to the game off. See Figure 3 for the location of the game ON/OFF switches on all four models. Slide the Self-Test switch to the "ON" position as shown in Figure 8, and turn the power to the game back on. When this is done, the game will react as follows:

- a. The game displays a ROM/RAM check list as shown in Figure 10.

The entire ROM/RAM check list shown in Figure 10 flashes off and on at regular intervals every few seconds.

If a bad ROM or RAM chip is found by the game's internal check system: it is indicated visually by the letters "NG" on the display in place of the letters "OK", and phonically by "BEEPING" at you from the moment you turn it on.

For instance: if the 7th chip down from the top is found to be bad, "NG" will appear in front of this chip (P RAM 3 NG) and the game will "BEEP" at you 7 times from the moment you turn it on. It will wait a few seconds (10 to 15) after the 7th "BEEP" and repeat the 7 "BEEPS" again.

If you have two chips that were found to be bad by the game's internal check system, they would both be shown on the display with the letters "NG" in front of them and the game would "BEEP" at you in a slightly different manner.

FIGURE 10 — ROM/RAM CHECK LIST AND MOTHER BOARD LOCATION COORDINATES

*	P	ROM 1	OK	-----	M-7
	P	ROM 2	OK	-----	L-7
	P	ROM 3	OK	-----	K-7
	P	ROM 4	OK	-----	J-7
	P	RAM 1	OK	-----	S-3 and/or S-2
	P	RAM 2	OK	-----	R-3 and/or (R/S)-2
	P	RAM 3	OK	-----	P-3 and/or (P/R)-2
	BBU	RAM	OK	-----	S-4
**	V	RAM 1	OK	-----	H-1 and/or (M/N)-1
	V	RAM 2	OK	-----	J-1 and/or (L/M)-1
	V	RAM 3	OK	-----	L-1 and/or (K/L)-1
	V	RAM 4	OK	-----	(J/K)-1 and/or (N/P)-1
	V	ROM 1	OK	-----	E-1
	V	ROM 2	OK	-----	F-1
*	If completely bad, no picture and no "BEEP" sound.				
**	If completely bad, no picture.				

For instance: if the 7th and the 12th chips down from the top are found to be bad, they would look like this (P RAM 3 NG) and (V RAM 4 NG). In the above case, the "BEEPING" sequence would be as follows:

**7 "BEEPS",
 PAUSE (2 to 5 seconds),
 THEN 12 MORE "BEEPS",
 LONGER PAUSE (10 to 15 seconds),
 THEN REPEATS ABOVE SEQUENCE.**

NOTE: In addition to the "BEEPING", the game will also flash its 1 and 2 credit LED lit push buttons at you in sequence with the "BEEPS" - 7 "BEEPS", 7 "flashes" - 12 more "BEEPS", 12 more "flashes" - and so on.

These "BEEPING" and "**FLASHING**" sequences are repeated until the game is turned off and the bad chip(s) are replaced or until the Self-Test switch is turned off.

When there is a bad chip, the game **will not** advance to the next Self-Test display by pressing the "FIRE" button. All bad chips must be replaced **BEFORE** the game will advance to the next Self-Test display.

The meaning of each part of this test display is explained in Figure 11.

- b. When in the Self-Test mode, you advance to the next display by pressing the "FIRE" button one time. Do so now. Figure 12 shows you what the next display in the Self-Test series (SWITCH OPERATION TEST) looks like.

As you move each of the switches indicated above you will observe that the indications change from "HI" to "LOW" or from "LOW" to "HI". If you move a switch and its indication on the monitor fails to change, the switch is either not working, miswired, or disconnected. Check it out thoroughly.

The meaning of each part of this test display is explained in Figure 13.

**FIGURE 11
DISPLAY EXPLANATION**

P	ROM 1	OK	The "P" stands for PROGRAMMABLE. The "ROM" stands for READ ONLY MEMORY. The "1, 2" etc. is the number of that particular chip.
P	ROM 2	OK	
P	ROM 3	OK	
P	ROM 4	OK	
P	RAM 1	OK	The "OK" means this particular chip is good. "BBU" stands for BATTERY BACK UP. The "RAM" stands for RANDOM ACCESS MEMORY. The "V" stands for VECTOR.
P	RAM 2	OK	
P	RAM 3	NG	
BBU	RAM	OK	
V	RAM 1	OK	The "NG" stands for NO GOOD.
V	RAM 2	OK	
V	RAM 3	OK	
V	RAM 4	NG	
V	ROM 1	OK	
V	ROM 2	OK	

NOTE: An indication of "HI" means that that particular switch is in the "OFF" condition or is a "normally open" switch. An indication of "LOW" means that that particular switch is in the "ON" condition or is a "normally closed" switch.

After having tested all the switches in your game, you are ready to advance to the third display of the series.

- c. Press the "FIRE" button one time. Figure 14 shows you what the next display should look like.

NOTE: This pattern and the one that will follow are for use in adjusting or checking the monitor's brightness and linearity.

- d. Press the "FIRE" button one time. Figure 15 shows you what the next and last display should look like.
- e. Pressing the "FIRE" button one more time will cause the monitor screen to go blank and a tone to begin coming from first one of the game's speakers and then the other.

The tone is high in pitch to begin with and goes lower over a 2 to 3 second period. When the tone stops at the end of the 2 to 3 second period, the game switches speakers and repeats the tone through this speaker.

The game will continue alternating back and forth between speakers to aid you in adjusting the volume level heard through each.

- f. To get out of the Volume Adjustment mode and advance to the beginning of the Self-Test mode, proceed in either one of the two following ways:
 - i. At least four beeps of tone must be heard to come from the game's speakers before you do anything. At any time after those first four beeps of tone are heard, **depress and hold down** the "FIRE" button. You will hear another two

FIGURE 12 SWITCH OPERATION TEST

COIN 1		HI
COIN 2		HI
TILT		HI
P 1 THRU S		HI
P 1 FIRE		HI
TEST		LOW
P 2 THRU S		HI
P 2 FIRE		HI
2 P 1 CR		HI
2 P 2 CR		HI
1 P 1 CR		HI
1 P 2 CR		HI
ANGLE 1	2	LOW
ANGLE 1	3	HI
ANGLE 1	4	HI
ANGLE 1	5	LOW
ANGLE 1	6	LOW
ANGLE 1	7	LOW
ANGLE 2	0	HI
ANGLE 2	1	HI
ANGLE 2	2	HI
ANGLE 2	3	HI
ANGLE 2	4	HI
ANGLE 2	5	HI
DIPSW1	0	LOW
DIPSW1	1	LOW
DIPSW1	2	LOW
DIPSW1	3	LOW
DIPSW1	4	HI
DIPSW1	5	LOW
DIPSW1	6	LOW
DIPSW1	7	LOW
DIPSW2	0	HI
DIPSW2	1	HI
DIPSW2	2	HI
DIPSW2	3	HI
DIPSW2	4	HI
DIPSW2	5	HI
DIPSW2	6	LOW
DIPSW2	7	LOW

to three beeps of tone while you're **holding down** the "FIRE" button and then the game will return to the beginning of the Self-Test mode (the ROM/RAM check list).

- ii. The second way to get out of the Volume Adjustment mode and return to the beginning of the Self-Test mode is to quickly turn the game "OFF" and back "ON" again.
- g. Slide the Self-Test switch to the "OFF" position. The game functions and display will now return to the T.V. monitor.

FIGURE 13 DISPLAY EXPLANATION

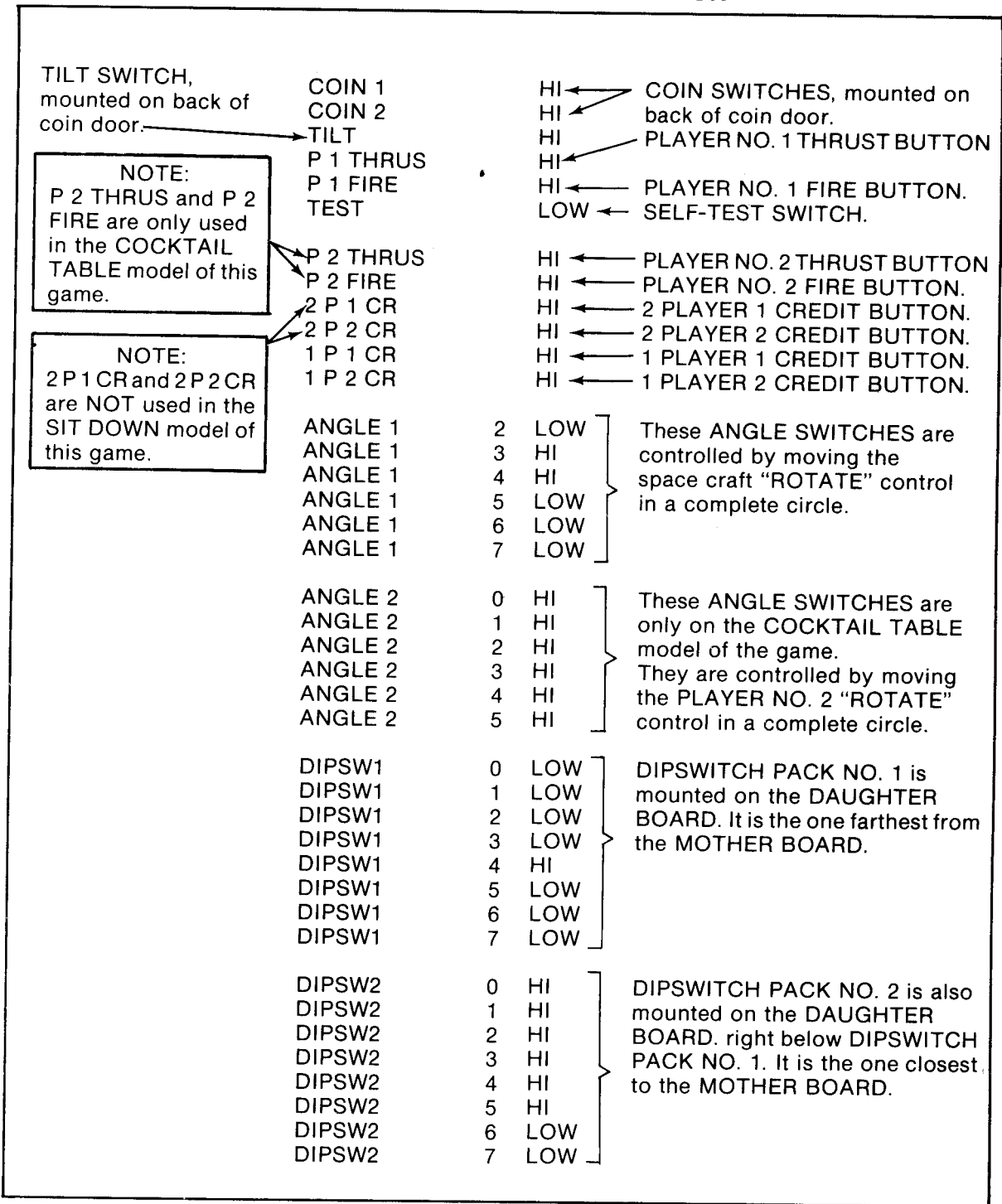

NOTE: While in the Self-Test mode, the game functions and display **WILL NOT** reappear (come back) by just sliding the Self-Test switch to the "OFF" position. You **MUST** be in the ROM/RAM portion of the displays **BEFORE** you can get out of Self-Test and back into game play. Just push the "FIRE" button to cycle through any remaining displays. When you reach the ROM/RAM display portion of the Self-Test mode, (**assuming the Self-Test switch is already in the "OFF" position**), the game will pop out of Self-Test and into normal game functions.

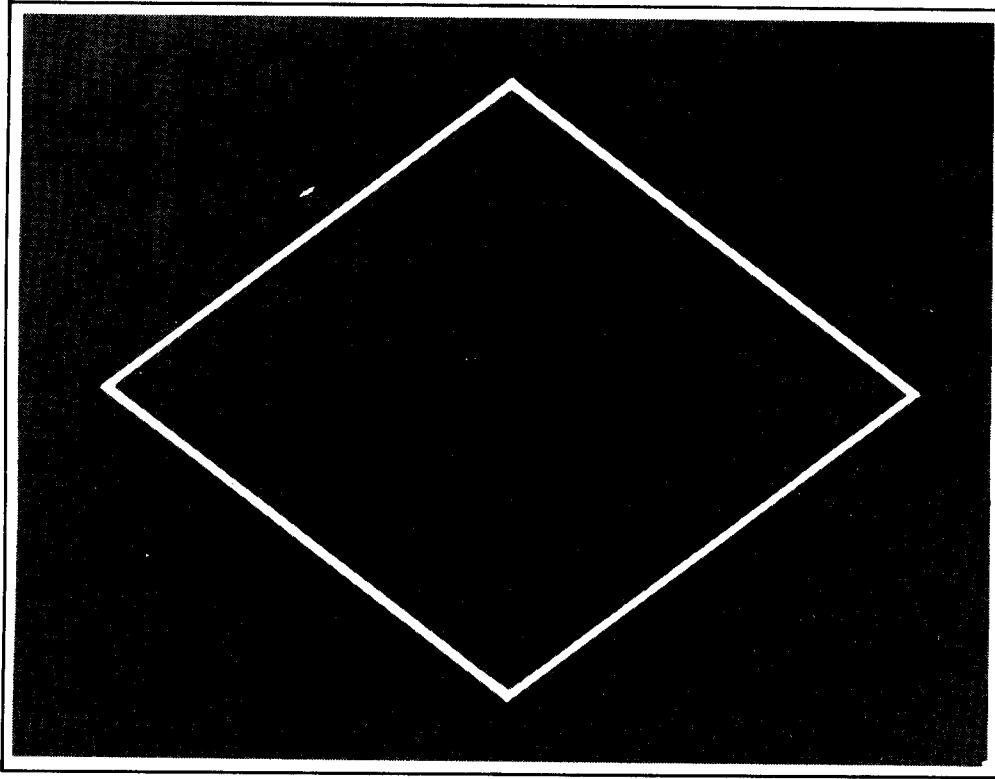
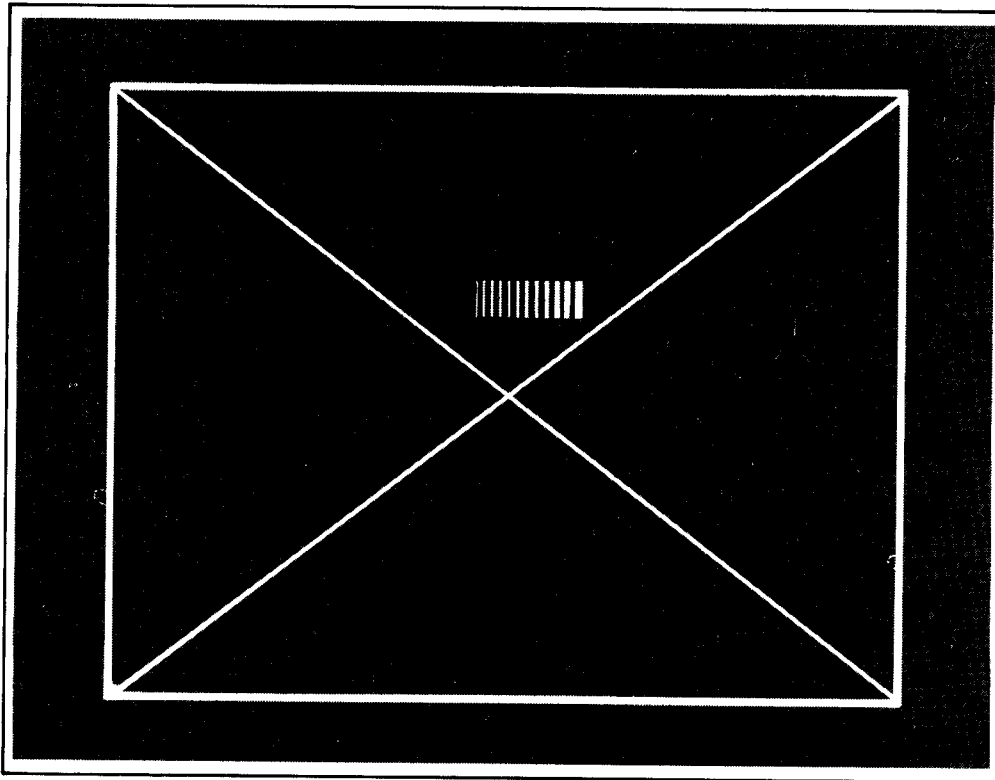

FIGURE 14 SINGLE DIAMOND PATTERN WHICH FILLS THE MONITOR SCREEN

FIGURE 15 BOX WITH CROSS AND BRIGHTNESS SCALE IN THE CENTER



ABOVE DISPLAY FILLS THE MONITOR SCREEN

3. Attract Mode:

The Attract mode starts:



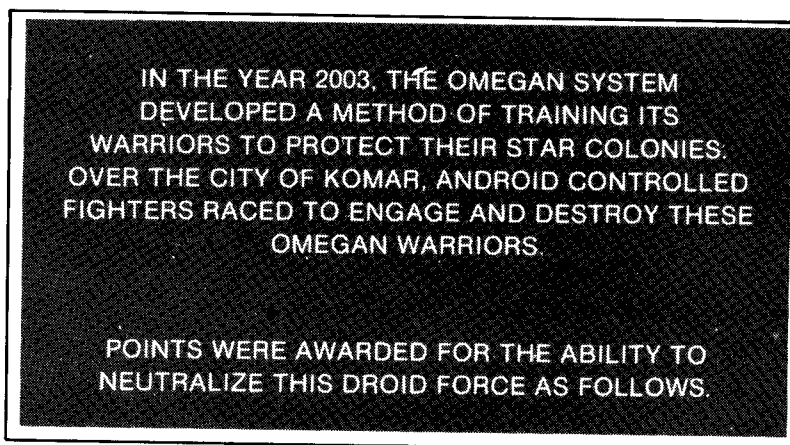

- a. As soon as power has been turned on to the game. (Self-Test switch is in the "OFF" position.)
- b. After play has been finished, the score was not high enough to put the game into the High Score/Initial mode, there are still credits left in the game memory but no one pushes one of the flashing "1 PLAYER 1 CREDIT", "1 PLAYER 2 CREDIT", etc. push buttons. (It will take one minute and then the Attract mode will begin.)
- c. After a play has been finished, the score was not high enough to put the game into the High Score/Initial mode, and there are no more credits left in its memory.
- d. After the High Score/Initial mode when there are no more credits left in its memory.
- e. The Attract mode is on all the time and is only stopped when a game has been paid for and the Record Keeping or Self-Test modes have not been started.
- f. In the Attract mode, the game will give the following displays **centered** on the monitor screen:

NOTE: With regard to the lettering shown in each "display": When the lettering is **ALL CAPITALS**, it is the lettering actually shown on the T.V. monitor screen. When the lettering is **all lower case**, it does not actually appear on the T.V. monitor screen.

display #1



display #2

photon mine		350 POINTS
vapor mine		500 POINTS
droid ship		1000 POINTS
command ship		1500 POINTS
death ship		2500 POINTS

display #3

THE OMEGAN METHOD IS SO SUCCESSFUL
IT COMMANDS FEAR AND RESPECT FROM ALL
THROUGHOUT THE GALAZIES. THE METHOD IS CODE NAMED . . .

OMEGA RACE

display #4

1 CREDIT GAME
ALL TIME HIGH
10650 MFG

DAILY HIGHS

70650	DDK
31350	DLM
30950	HHS
30500	MIC
23350	LRS

© 1981 HIGHWAY MFG. CO.

display #5

2 CREDIT GAME
ALL TIME HIGH
38250 AE

DAILY HIGHS

31350	DLM
30500	MIC
23350	LRS
22400	JAC
19550	RDH

© 1981 HIGHWAY MFG. CO.

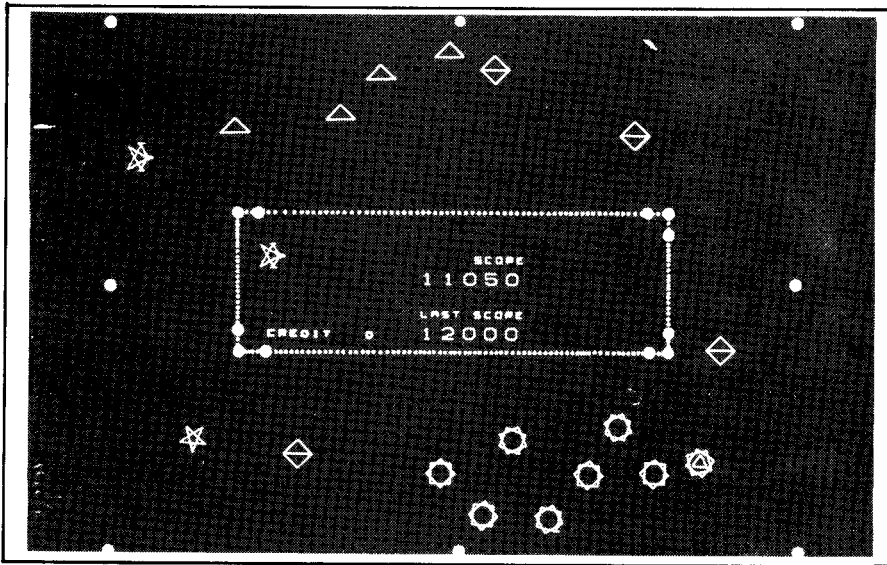

display #6

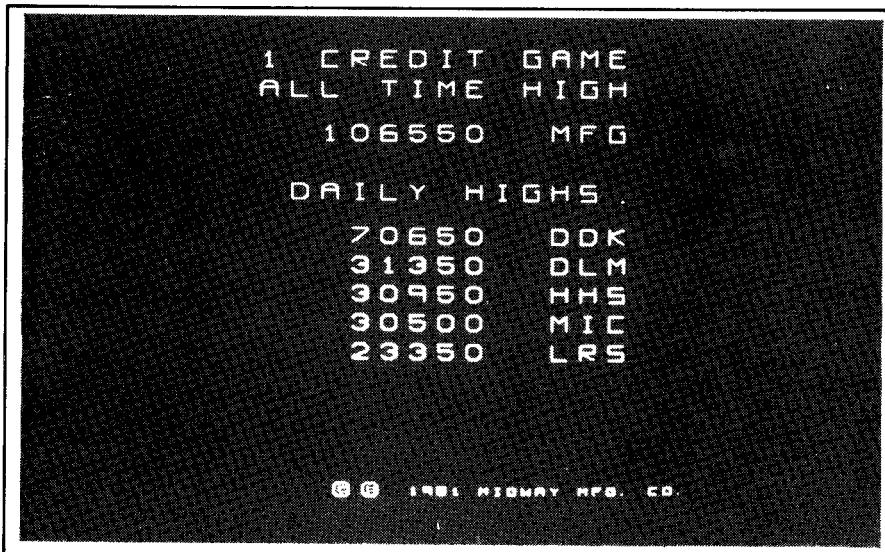

display #7

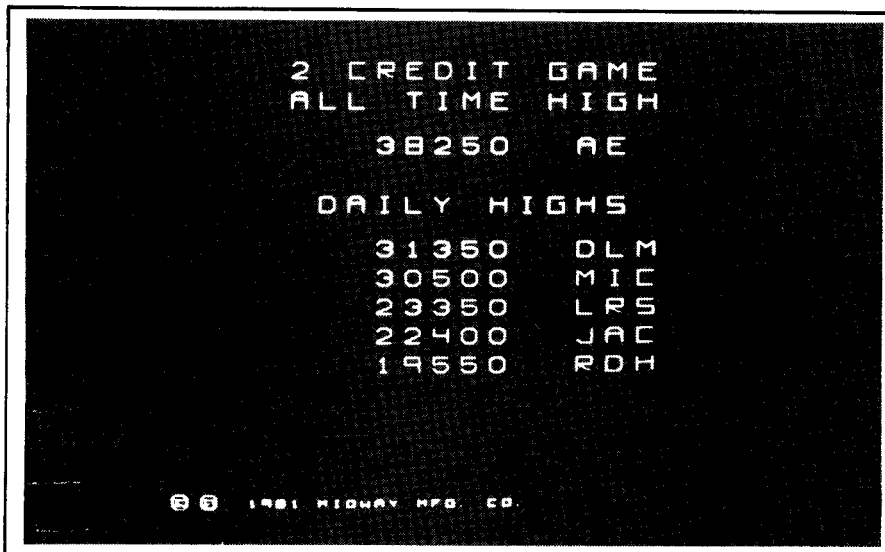

display #8

display #9

switch selectable

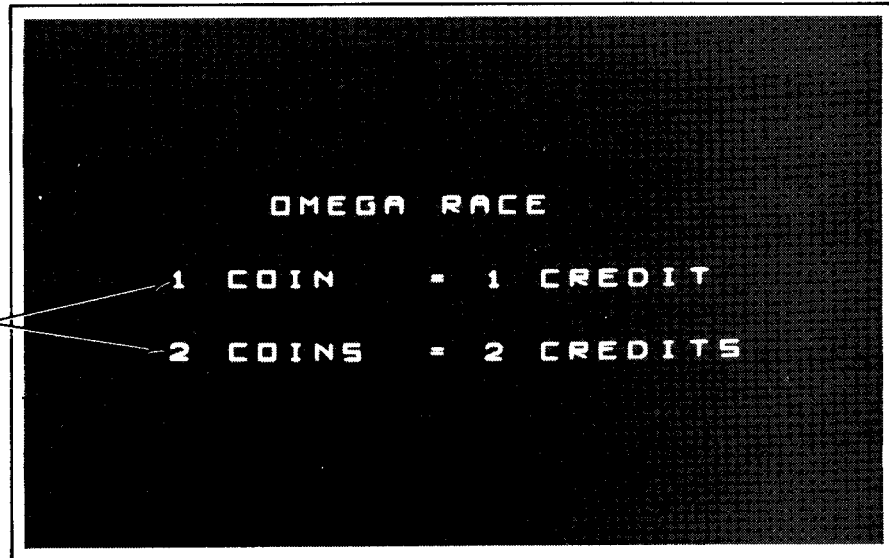

display #10

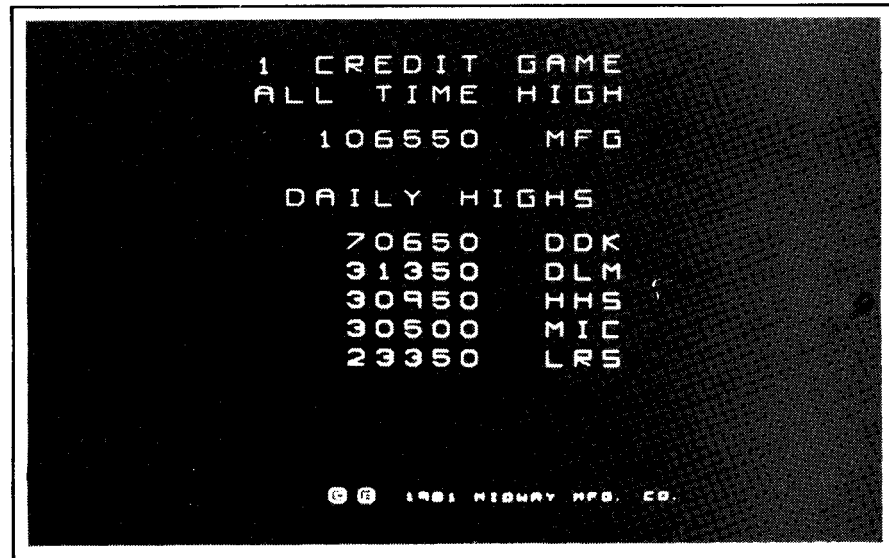

display #11

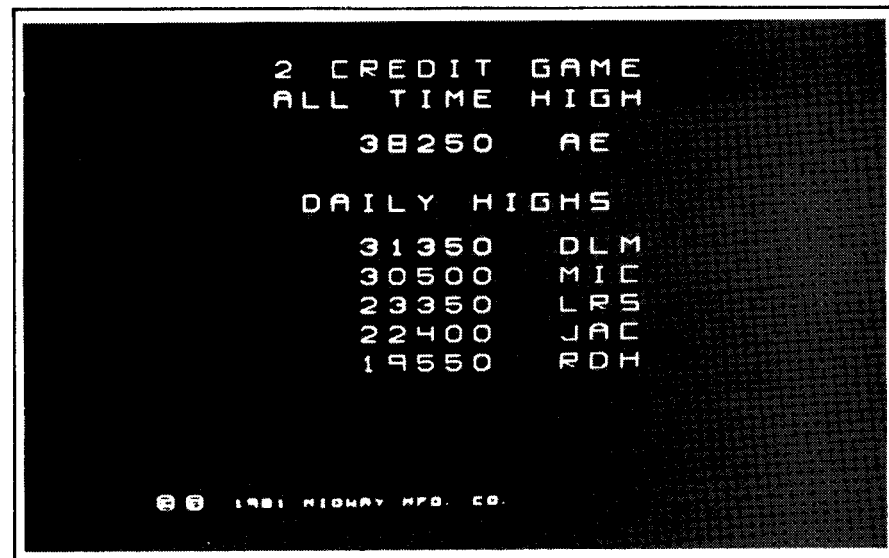

- g. No matter where the game is in the 11 display Attract mode sequence, it will immediately go to display #12 as soon as a game has been paid for. It will hold this display on the monitor screen for a minute. If, at the end of that minute, the player has not pushed one of the flashing "1 PLAYER 1 CREDIT", "1 PLAYER 2 CREDIT", etc. start buttons, the game will go back to the beginning of the Attract mode sequence.

switch selectable

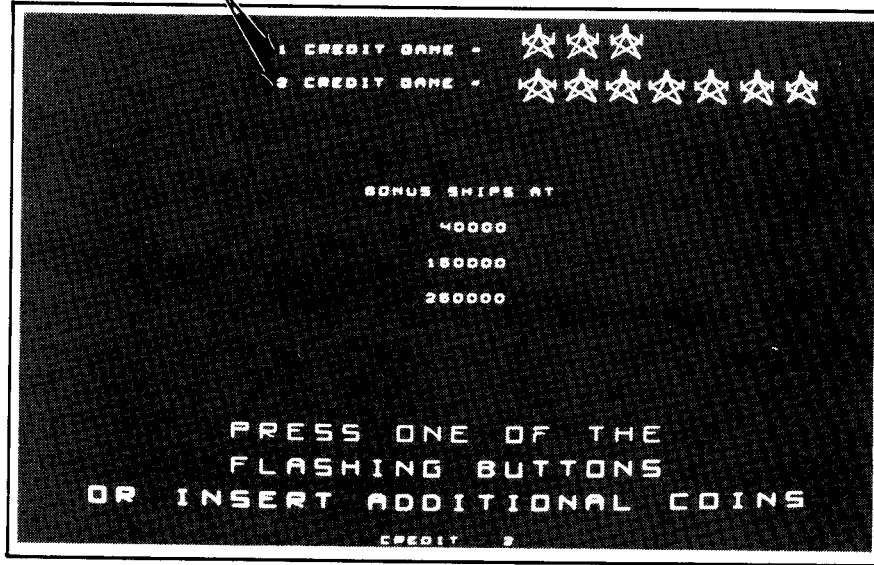

display #12

4. Ready-To-Play Mode:

- The Ready-To-Play mode starts when enough coins have been accepted for a 1 or a 2 player game.
- The Ready-To-Play mode ends when one of the flashing "1 PLAYER 1 CREDIT", "1 PLAYER 2 CREDIT", etc. pushbuttons is pressed.
- In the Ready-to-Play mode, the game will give the above "display #12" **centered** on the monitor screen.
- If no START button is pressed, the game will hold the above display on the screen for one minute before going back to the beginning of the Attract mode sequence.

5. Play Mode:

- The Play mode begins when one of the flashing "1 PLAYER 1 CREDIT", "1 PLAYER 2 CREDIT", etc. start buttons is pressed.
- The Play mode ends when all of your Omegan fighters have been destroyed. When this happens, all the enemy driods and mines disappear and "GAME OVER" is written across the top center of the screen.
- The game is made up of an energy field through which the Omegan 'pilot' flies his space fighter to attack and destroy the invading enemy droid forces. (See Figure 7 for a sample display and an explanation of all its components.)

- i. There are four initial waves of enemy droids in the first droid force. These waves are made up of:

1st WAVE = 6 ENEMY DROID SHIPS

2nd WAVE = 8 ENEMY DROID SHIPS

3rd WAVE = 10 ENEMY DROID SHIPS

4th WAVE = 12 ENEMY DROID SHIPS

- ii. If one of your Omegan space fighters is hit by the enemy or runs into an enemy mine **BEFORE** the last enemy ship of that wave is destroyed; when play begins again, you will have to re-destroy **ALL** of that **SAME** wave of enemy droids all over again **BEFORE** you can advance to the next wave.

If, however, one of your omegan space fighters is hit by a stray enemy ray or runs into an enemy mine **AFTER** the last enemy ship of that wave has been destroyed, you are advanced to the next wave of enemy droids even though you lost a ship.

- iii. When you destroy the last enemy ship of the fourth wave of attackers, the T.V. monitor will give the following display **centered** on the screen:

**FIRST DROID FORCE ELIMINATED
5000 BONUS POINTS**

- iv. Each wave of enemy droids after the fourth wave is made up of 12 ships.
- v. Each droid force after the 1st is made up of 4 waves of enemy ships.
- vi. You are awarded an additional 5000 BONUS POINTS for each and every droid force you eliminate.
- vii. As you destroy ever larger numbers of enemy droids, they move faster and their aim gets even better.

d. Two Player Operation

- i. The Upright, Mini, and Cocktail Table models are the **ONLY** ones that have two player operation.
- ii. In the two player mode, the rules of play are the same as in the single player mode. There are some additional rules, however.
 - In the Upright and Mini models, the players must take turns at the controls.
 - In the Cocktail Table model, each player has his own set of individual controls. The picture will flip to face you when it is your turn. (When it is not your turn, your set of controls will have no effect on the game.)
 - When a bonus ship is awarded to a player in a two player game, it is played immediately following the destruction of the ship he is currently piloting. (This enables the game to **END** at the **SAME TIME** for **BOTH** players. One player does not have to stand around after all his ships have been destroyed and watch the other qne play.)

III. MAINTENANCE AND REPAIR

Your OMEGA RACE game needs certain types of maintenance to keep it in good working order. Clean, well maintained games attract players and earn more profits.

The most important thing for you to remember is to run the Self-Test EVERY TIME you collect money from the coin box. **JUST LOOKING** at your game **WILL NOT** tell you if all its controls and inside parts are working correctly. The Self-Test will inform you whether or not your game is working the way it should.

The second most important thing you should remember is to clean the outside of the game and coin acceptor mechanisms on a regular basis.

A. CLEANING

The outside of the game cabinet plus the metal can be cleaned with any non-abrasive household cleaner. However, the front of the T.V. monitor tube and **both sides** of all other glass and plastic on or in the game **MUST** be cleaned with anti-static cleaner **ONLY**. For cleaning the coin acceptors, hot soapy water may be used on the plastic ones and any household cleaner may be used on the metal ones. If you wish, special coin machine cleaners that leave no residue may be purchased from your distributor.

DO NOT dry-wipe any of the plastic panels. This is because any dust that was on them can scratch their surfaces. If this has happened, anyone looking through this type of damaged plastic would feel he was looking at the game through a fog. This fogging damage CAN NOT be repaired or reversed. The **ONLY** solution is to **replace** the damaged piece of plastic.

B. FUSE REPLACEMENT

This game contains several fuses located as shown in Figure 16.

1. Upright model:

As viewed from the back, facing the cabinet, with the rear access door removed, the fuses are located on the Mech. Panel, the Linear Power Supply Board, and on the Power Supply Filter Assembly.

2. Mini model:

As viewed from the back, facing the cabinet, with the rear access door removed; the fuses are located on the Mech. Panel, the Linear Power Supply Board, and the Power Supply Filter Assembly.

3. Cocktail Table model:

As viewed from the coin door side of the cabinet, with the monitor tilted open to one side; the fuses are located on the Mech. Panel, the Linear Power Supply Board, and the Power Supply Filter Assembly.

4. Sit Down model:

As viewed from the front, facing the cabinet, with the front access door open; the fuses are located on the Mech. Panel, the Linear Power Supply Board, and on the Power Supply Filter Assembly.

As viewed from the rear, facing the cabinet, there is one fuse by the ON/OFF switch.

Replace fuses ONLY with the type and size listed in the Illustrated Parts Breakdown Section of this manual.

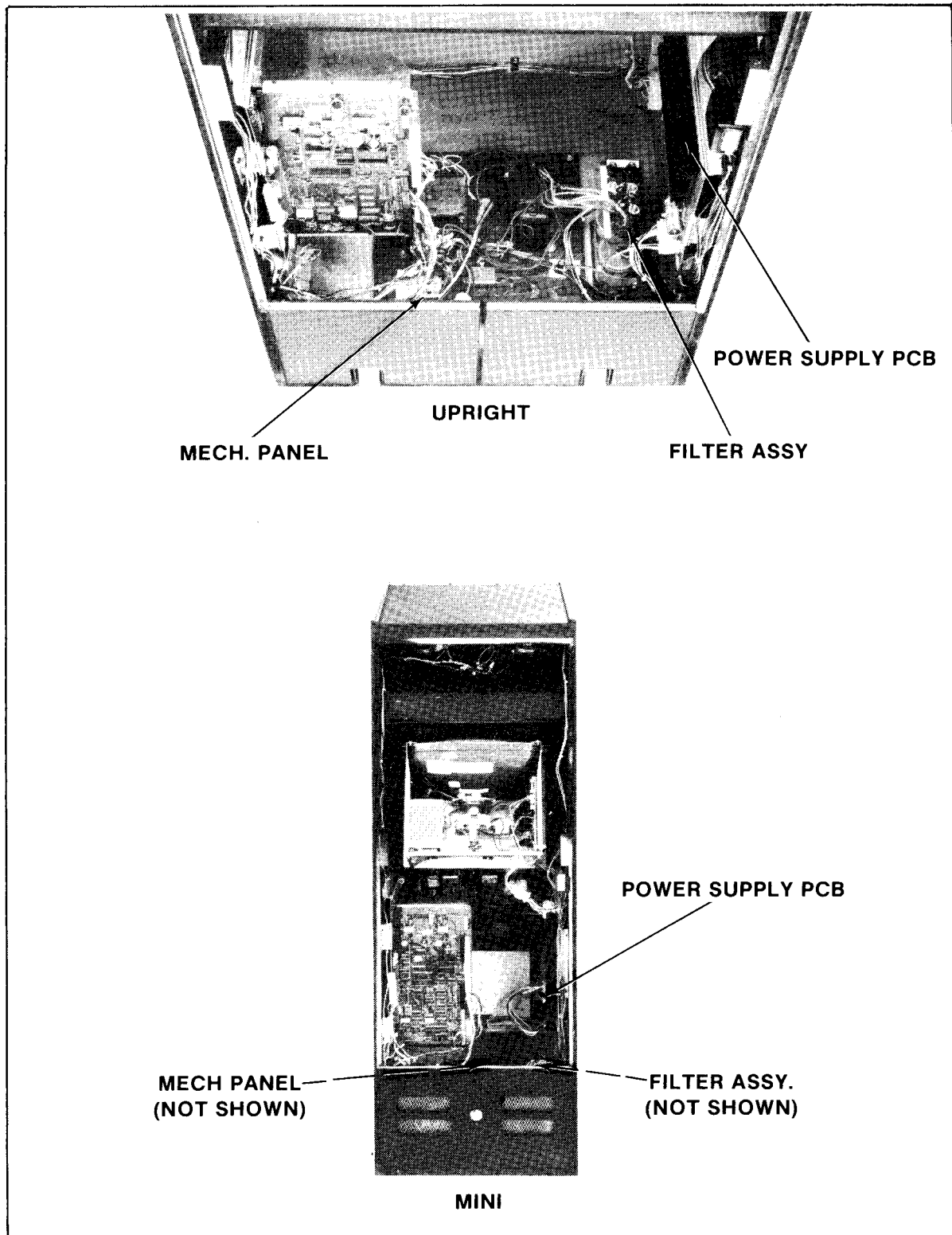

FIGURE 16

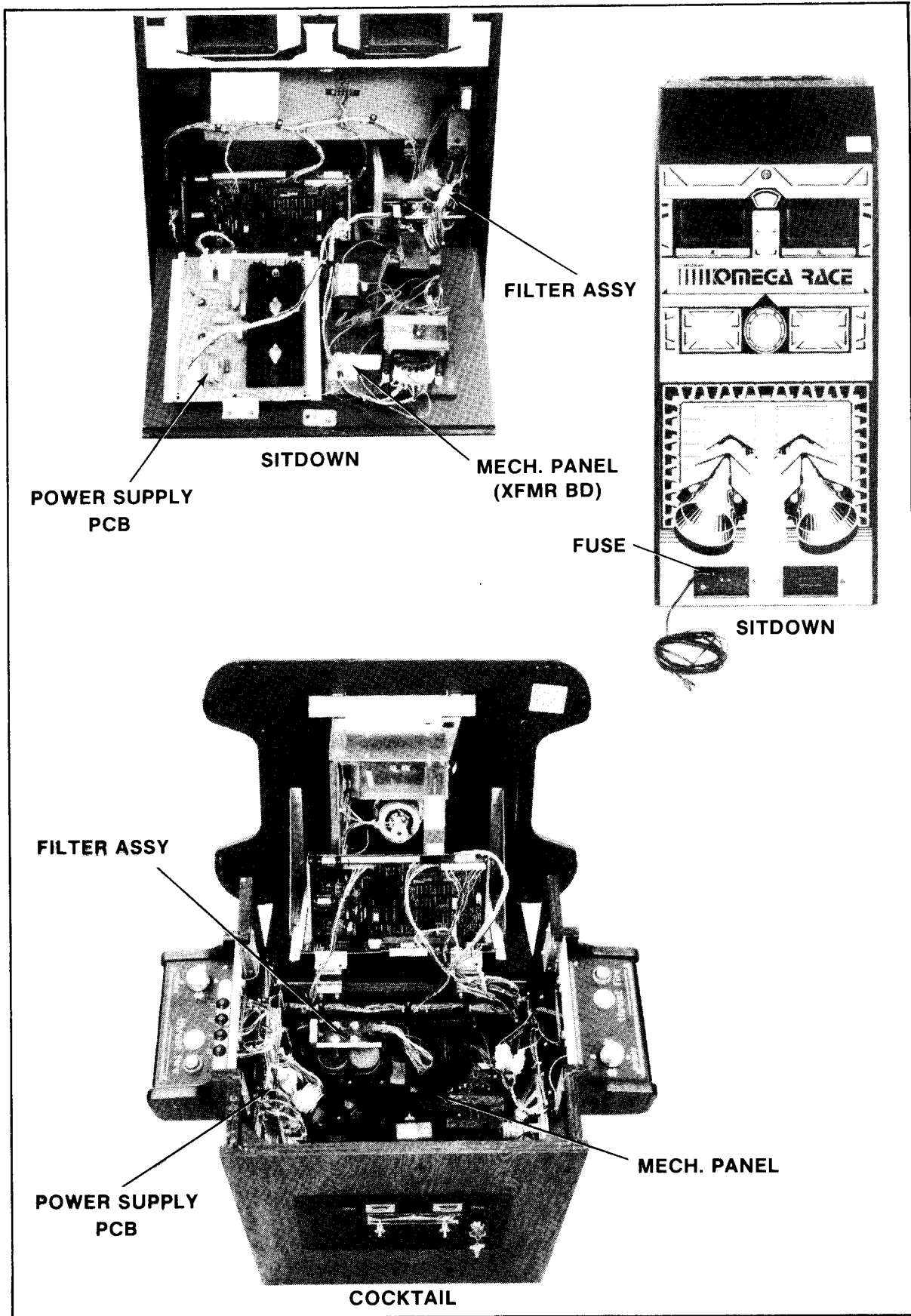

FIGURE 16 (cont'd)

C. OPENING THE CONTROL PANEL — See Figure 17.

1. Upright model:

- a. The control panel is held in place by two latches, one on the left side and one on the right side of the cabinet.
 - i. They are spring loaded to provide constant positive pressure on their latch plates.
 - ii. They can be reached through the coin door **AFTER** turning power to the game off.
 - iii. To release the latches, lift up and toward the center of the control panel.
 - Once they are released, unhook them from their latch plates.

b. To remove the control panel:

- i. Raise it up and tilt it toward you until you can see the cable behind it.
 - ii. Cradling the control panel between yourself and the cabinet, disconnect it from its cabling.
 - iii. The control panel is now free and can be removed.
- c. To reinstall the control panel, reverse this procedure.

2. Mini model:

- a. The control panel is held in place by two latches, one on the right side and one on the left side of the cabinet.
 - i. They are spring loaded to provide constant positive pressure on their latch plates.
 - ii. They can be reached through the coin door **AFTER** turning power to the game off.
 - iii. To release the latches, lift up and toward the center of the control panel.
 - Once they are released, unhook them from their latch plates.

b. To remove the control panel:

- i. Raise it up and tilt it toward you until you can see the cable behind it.
 - ii. Cradling the control panel between yourself and the cabinet, disconnect it from its cabling.
 - iii. The control panel is now free and can be removed.
- c. To reinstall the control panel, reverse this procedure.

3. Cocktail Table model:

- a. Each control panel is held in place by several screws, two on the inside of the cabinet and three along the bottom edge of the control panel.
 - i. Turn power to the game off.
 - ii. Open the coin box door and release the two latches indicated in Figure 18.

CAUTION: The left hand latch is very close to the sharp metal edge on the monitor chassis. Be careful not to cut yourself when working the latch.

 - Once they're released, unhook them from their latch plates.
 - iii. Grasp the table top at "A" and open it as indicated in Figure 18.

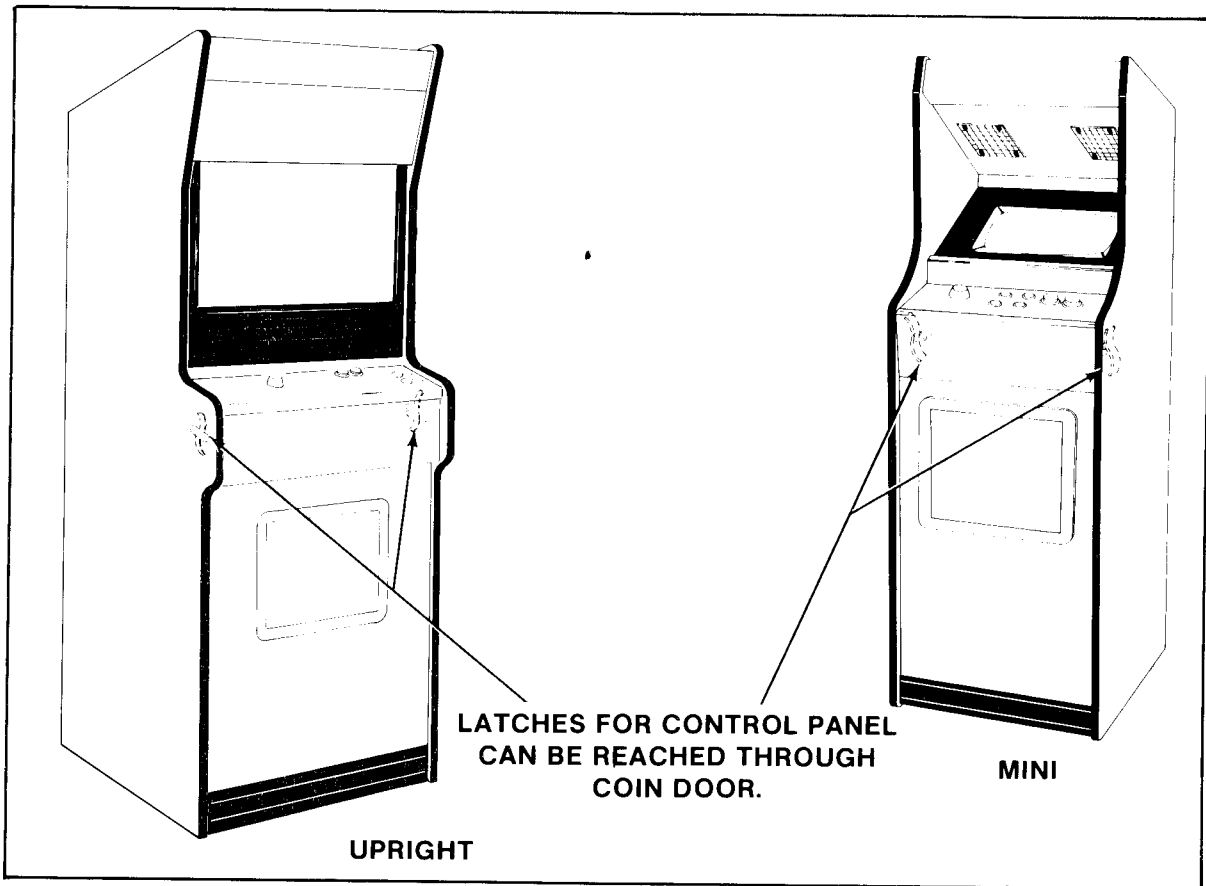

FIGURE 17

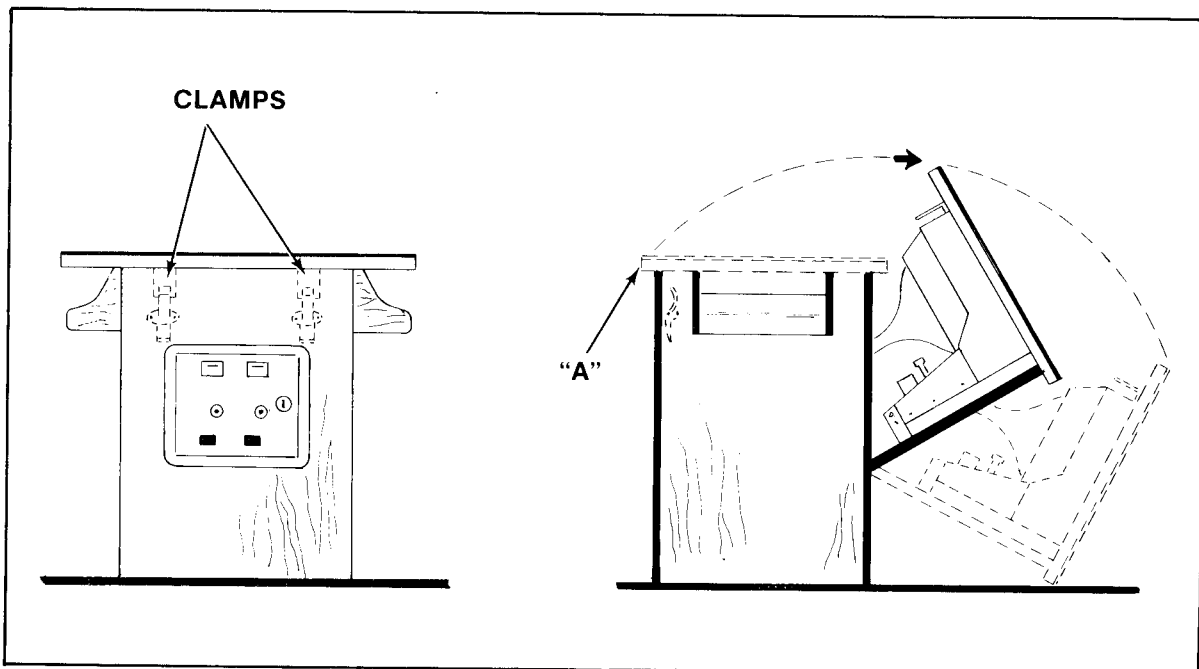

FIGURE 18

CAUTION: Due to the weight of the monitor, **EXTREME CASE MUST** be taken when opening the cabinet.

- iv. Remove the screws which secure the control panel in place. See Figure 19.
- b. To remove the control panel(s):**
- i. Disconnect it from its cabling.
 - ii. The control panel is now free and can be removed.

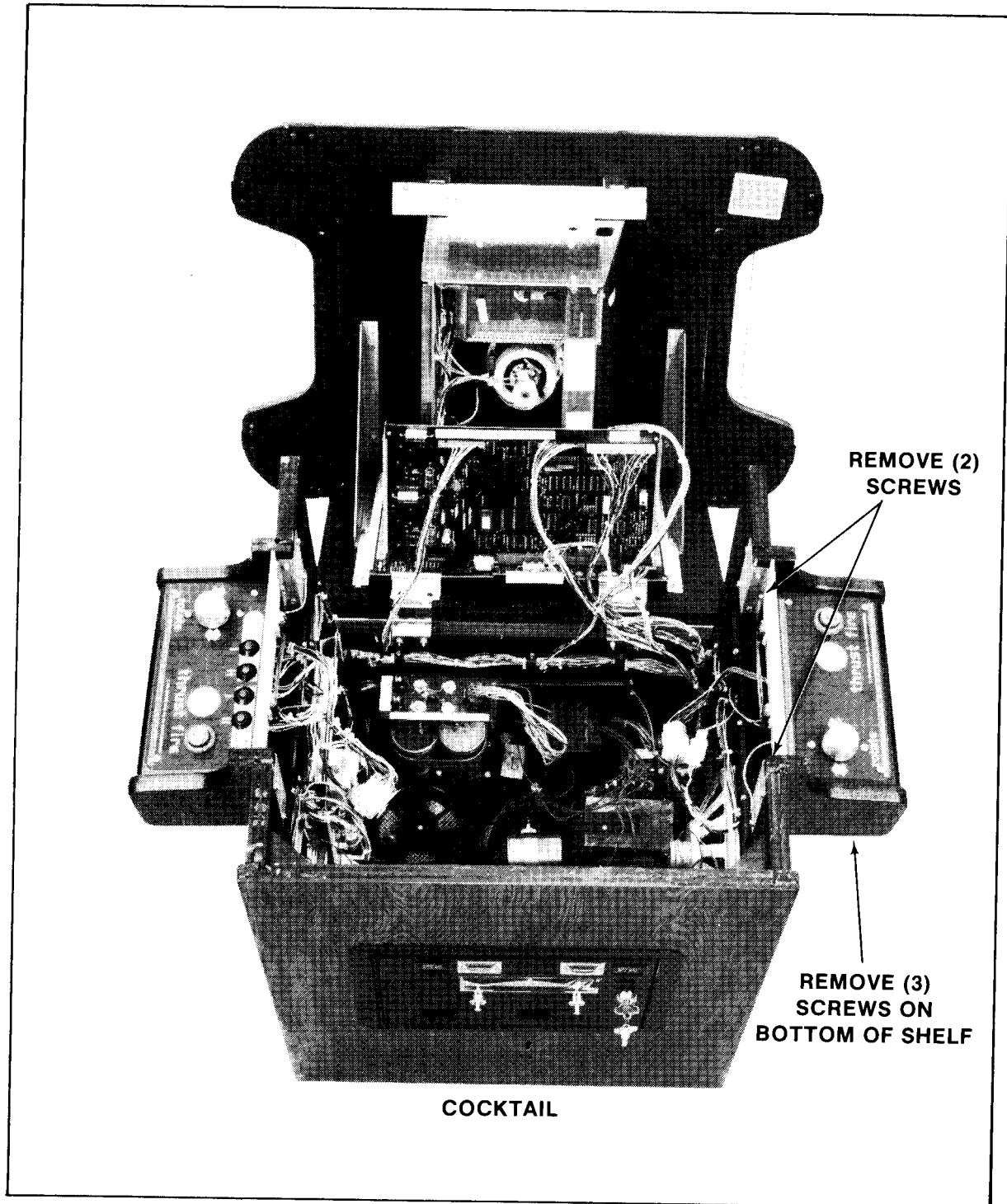

FIGURE 19

4. Sit Down model:

There are three control panels on a Sit Down model, one at the bottom of the screen which contains the "START GAME" "1 CREDIT" and "2 CREDIT" buttons, one in the right hand arm rest which contains the "THRUST" and "FIRE" buttons, and one in the left hand arm rest which contains the "ROTATE" control.

- a. These control panels are held in place by semi-tamper-proof screws.
- b. Turn the power off to the game.
- c. To remove **either** arm rest control panel: (See Figure 20.)
 - i. Remove the three screws which secure it.
 - ii. Grasping it at its bottom front edge, lift it up and tilt it to the side until you can see its cable plug.
 - iii. Unplug it from its cable.
 - iv. The armrest control panel is now free and can be removed.
 - v. To reinstall these control panels, reverse this procedure.

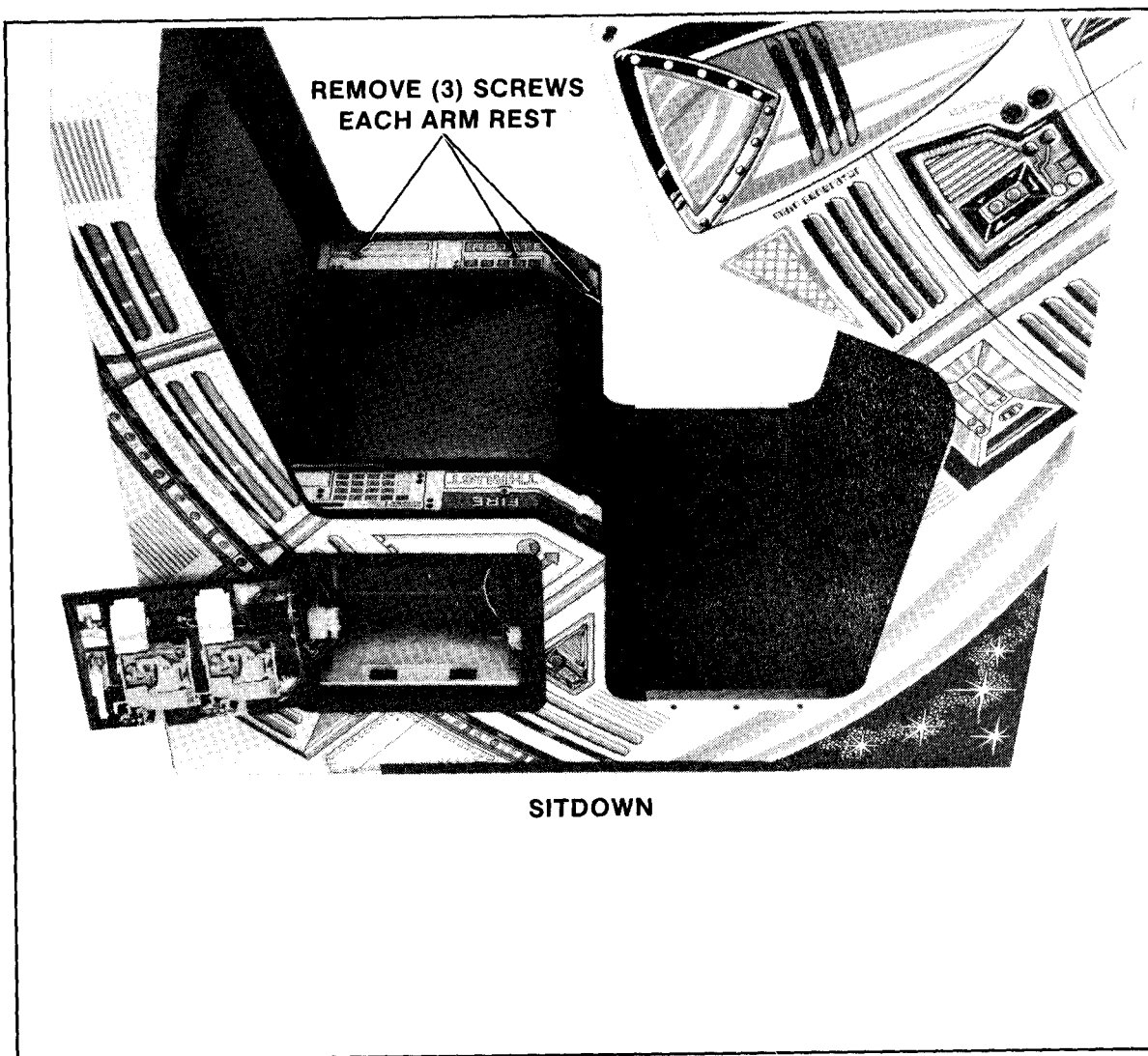

FIGURE 20

d. To remove the control panel at the bottom of the screen: (See Figure 21.)

NOTE: This control panel **CAN NOT** be disconnected from its wire harness except by unsoldering the wire harness from the switches.

For trouble-shooting purposes, however, the control panel can be lowered slightly so that the pins on the back side of the switches can be reached. To do this, proceed as follows:

- i. Remove the three screws which secure it. (**Make sure** you support it as you remove the last of the three screws.)
- ii. Lower the left hand end of this control panel and support it on your knees while tilting it toward you to expose the pins at the back of the two switches for trouble-shooting or replacement purposes.

CAUTION: DO NOT pull on the panel to better expose the pins at the backs of the switches. THERE IS NO SLACK IN THIS CABLE!!

- iii. To reinstall this control panel, reverse this procedure.

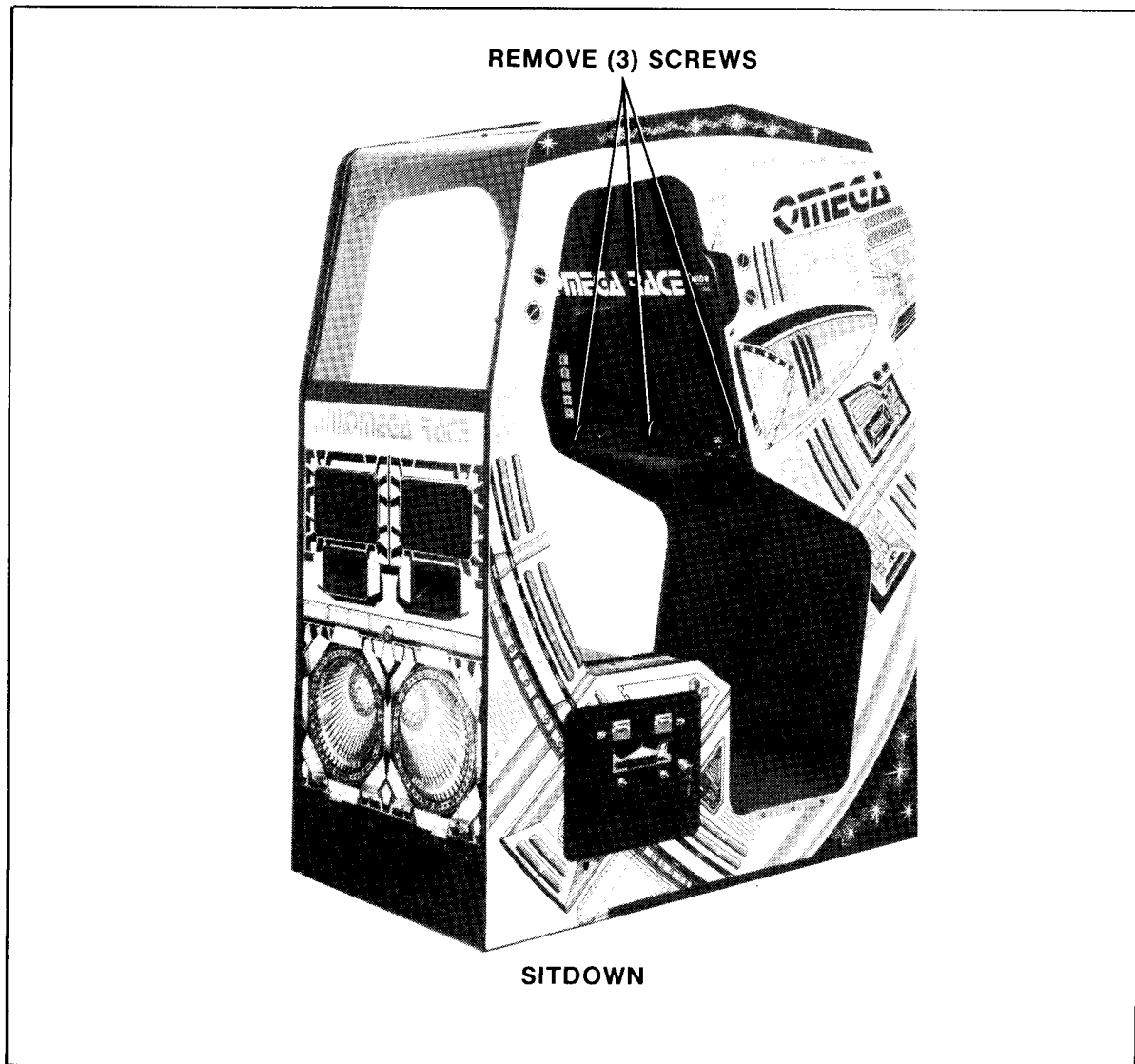

FIGURE 21

D. REMOVAL OF THE MAIN-DISPLAY-GLASS AND/OR THE T.V. BEZEL ASSEMBLY:

1. Upright model:

NOTE: In order to do this, the control panel **MUST** be removed first. See the "Upright model" procedure.

- a. Turn the power to the game off and remove the control panel. This frees the main-display-glass so it can be lifted up.
- b. Grasp the main-display-glass in the bottom center, lift up slightly and pull it toward you about an inch, let it down just far enough so you can get hold of its top edge with your other hand and lift it out of the game. See Figure 22.
- c. Remove the triangular shaped pieces of scenery from the left and right hand sides of the cabinet. See Figure 23.
- d. Remove the screws which secure the T.V. bezel assembly in place.
- e. The T.V. bezel assembly is now free and can be slid out of the cabinet. See Figure 23.
- f. To reinstall the T.V. bezel assembly and the main-display-glass, reverse this procedure.

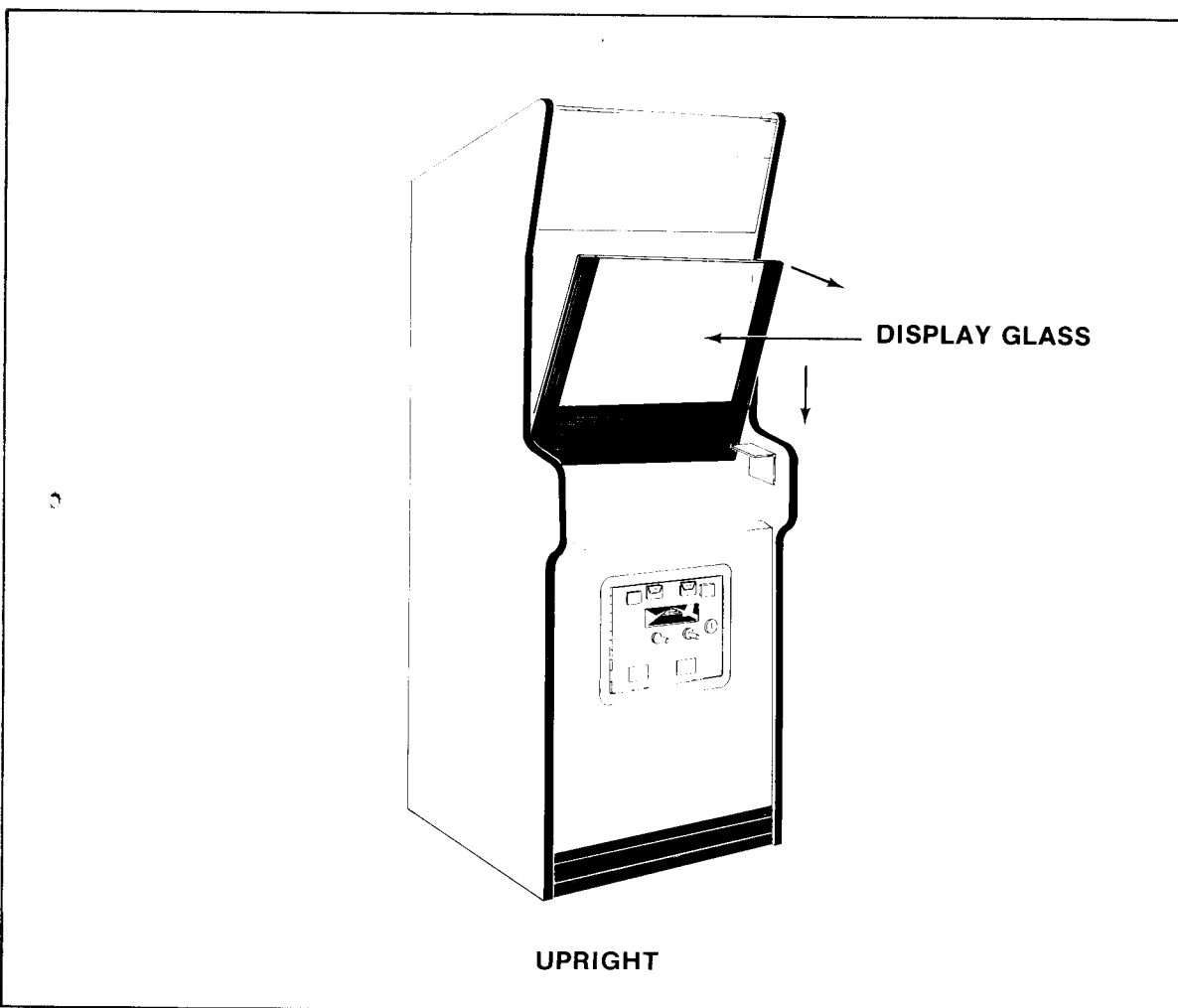

FIGURE 22

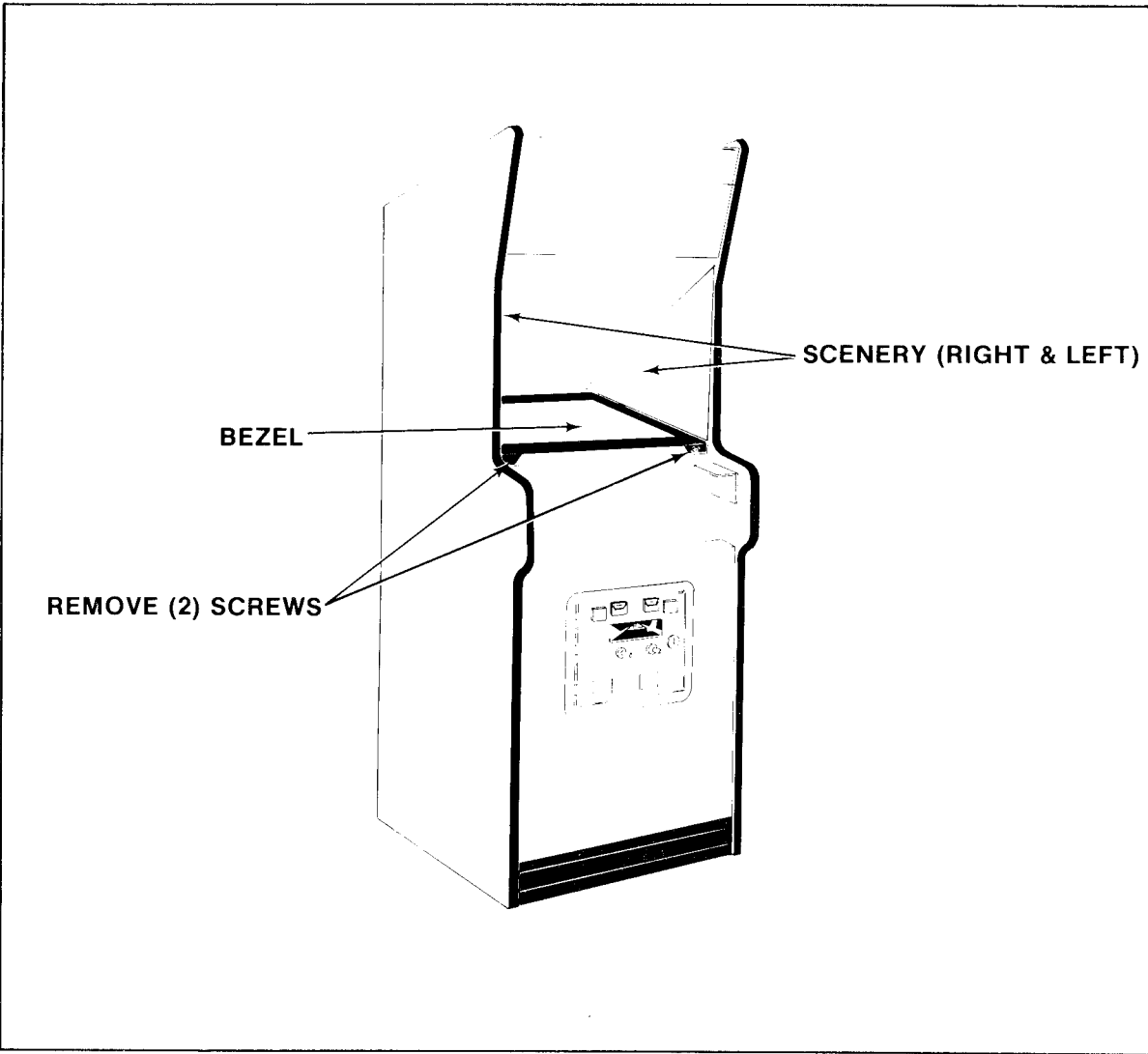

FIGURE 23

2. Mini model:

NOTE: In order to do this, the control panel **MUST** be removed first. See above "Mini model" procedure.

- a. Turn the power off to the game and remove the control panel.
- b. Remove the screws which secure the glass clamping plate. See Figure 24.
- c. Lift out the glass clamping plate. This frees the main-display-glass so it can be lifted up.
- d. By putting your finger in the hole in the middle of the main-display-glass support, you can lift it up and out. See Figure 24.
- e. Remove the screws which secure the T.V. bezel assembly, see Figure 25, and lift it out.

NOTE: Use the hole in the center of the main-display-glass support to grasp it.

- f. Reverse this procedure to reinstall the T.V. bezel assembly and the main-display-glass.

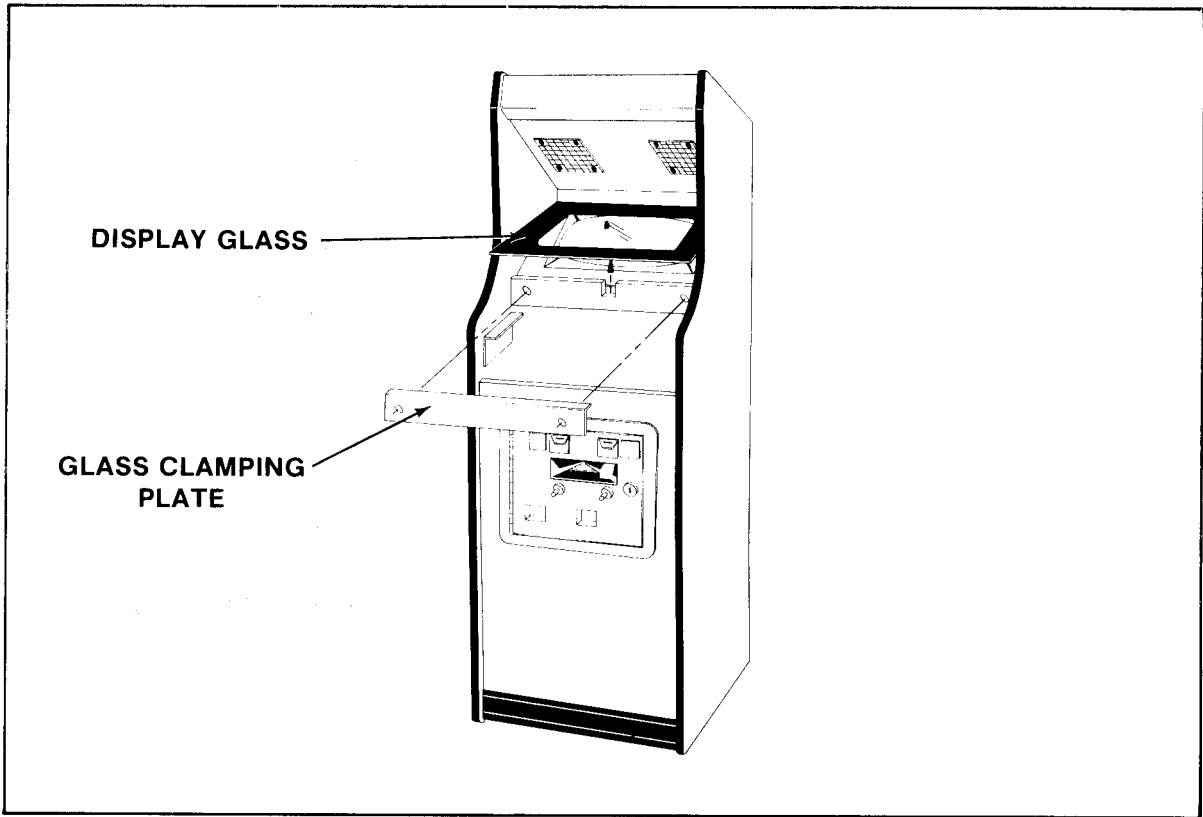
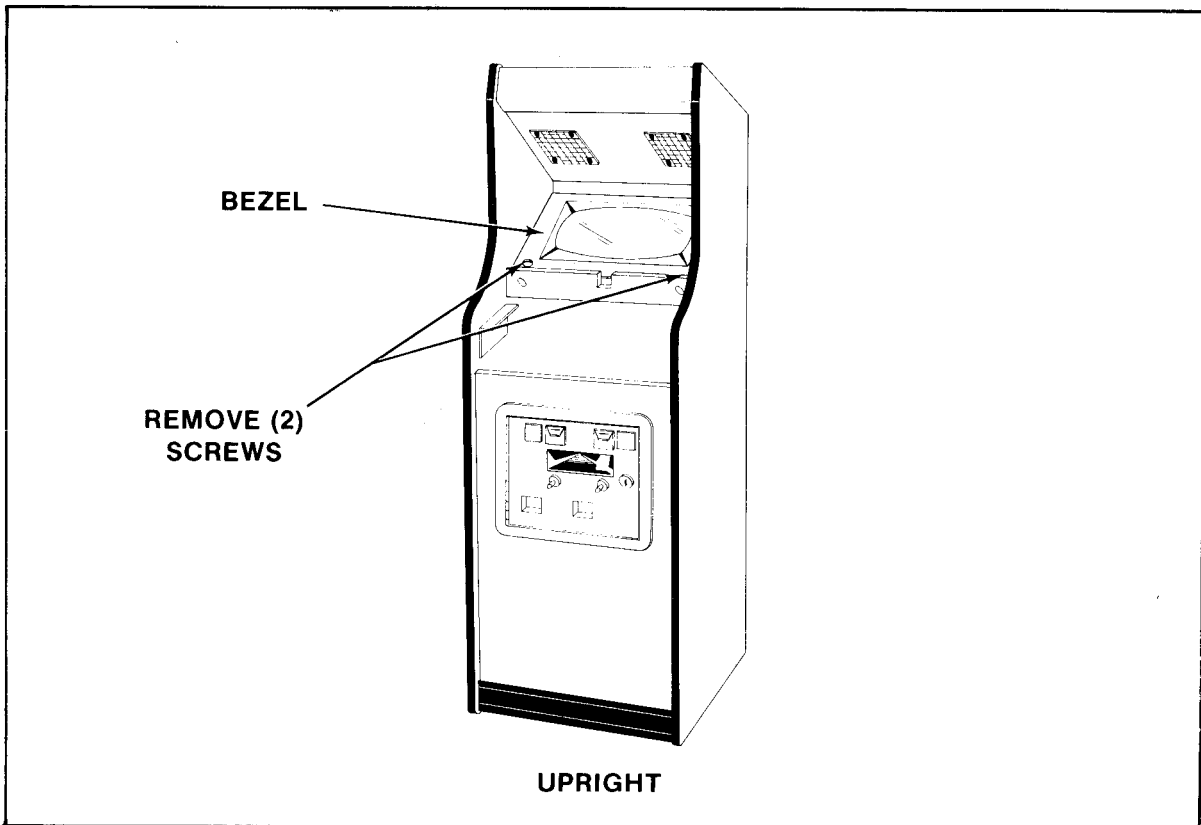

FIGURE 24



UPRIGHT

FIGURE 25

3. Cocktail Table model:

NOTE: This may be done with the table top in the closed or the open position. If you decide to open the table top, **TURN THE POWER TO THE GAME OFF FIRST.**

- a. Remove the screws which secure the table top glass clamps in place.
- b. Remove the table top glass.
- c. Lift out the T.V. bezel assembly.
- d. To reinstall the T.V. bezel assembly, simply reverse this procedure.

4. Sit Down model:

- a. Turn the power off to the game.
- b. Loosen the three screws in the control panel at the bottom of the main-display-glass. See Figure 26.
- c. Loosen **and remove** the three screws at the top of the main-display-glass. See Figure 26.

CAUTION: DO NOT let the main-display-glass fall forward. Hold it in place with one hand.

- d. Grasp the top edge of the main-display-glass with both hands and lift up until its bottom edge is free of the control panel at its bottom.
- e. Now slide the glass straight down and onto your lap.
- f. Reverse this procedure to reinstall the main-display-glass.

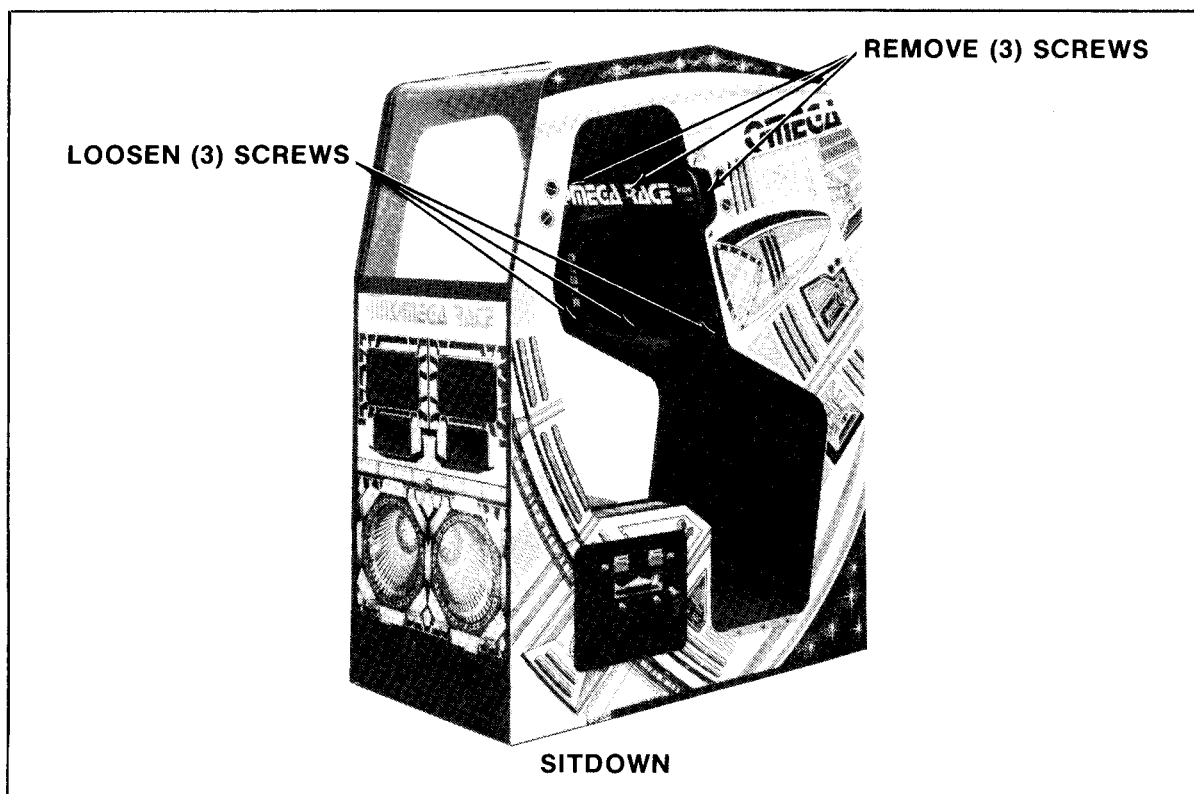

FIGURE 26

E. T.V. MONITOR REPLACEMENT

CAUTION: High voltages may exist in any television unit, even with power disconnected. Use **EXTREME CAUTION** and do not touch electrical parts or the T.V. yoke area with your hands or with metal objects in your hands!

In addition, **BE SURE TO USE HEAVY GLOVES** when handling the monitor. You could cut your hands on the metal T.V. chassis without such protection.

DANGER: The T.V. monitor **DOES NOT** contain an isolation transformer on its chassis (it is mounted instead on the floor of the cabinet). When servicing the monitor on a test bench, **YOU MUST ISOLATE THE MONITOR FROM AC VOLTAGE WITH AN ISOLATION TRANSFORMER.**

1. Upright model — See Figure 27.

- a. Turn power off to the game.
- b. Open the rear access door.
- c. Completely disconnect the T.V. monitor from all its cabling. **DON'T FORGET THE CHASSIS GROUND WIRE.**
- d. Unplug the mother board and daughter board from all their cabling. Remove the short P.C.B. supports indicated in Figure 27 and slide the mother and daughter board assembly out the back of the cabinet. Set them aside. (Otherwise the T.V. monitor chassis would hit the daughter board as it was being slid out the back of the cabinet.)
- e. Before removing the T.V. monitor, the main-display-glass and bezel must be removed. See above "Upright model" procedure.
- f. With the removal of only four bolts, the T.V. monitor and its mounting board will be loose.
- g. The monitor mounting board slides on top of and against two wooden guides mounted to the cabinet's right and left sides. The monitor is removed by sliding it out the back of the cabinet. See Figure 27.
- h. To reinstall the T.V. monitor, reverse this procedure.
- i. After replacing the T.V. monitor, be sure to run the game Self-Test.

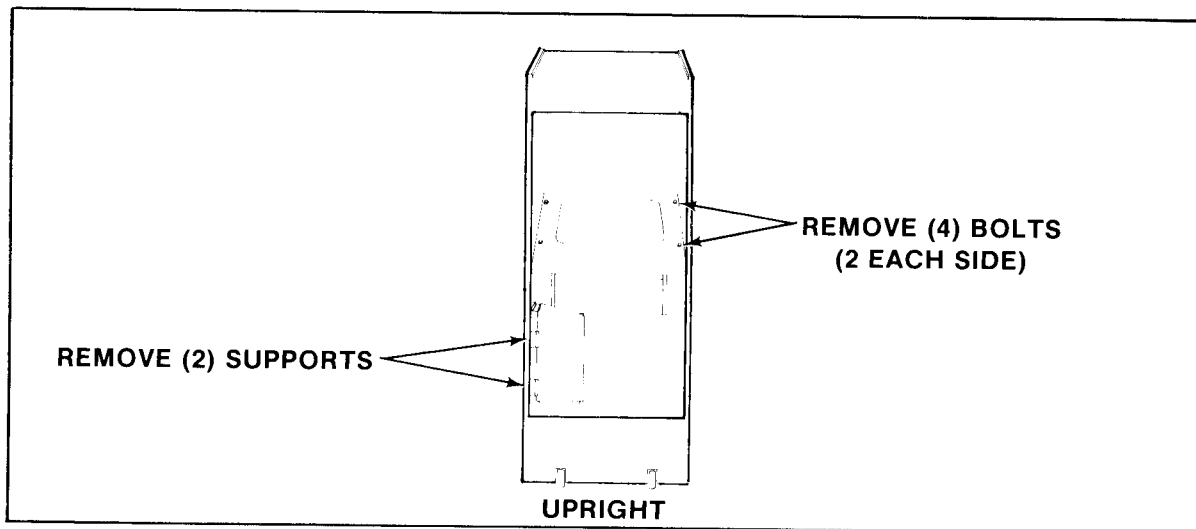

FIGURE 27

2. Mini model — See Figure 28.

- a. Turn the power to the game off.
- b. Open the rear access door.
- c. Completely disconnect the T.V. monitor from all its cabling. **DON'T FORGET THE CHASSIS GROUND WIRE.**
- d. Before removing the T.V. monitor, the main-display-glass and bezel must be removed. See above "Mini model" procedure.
- e. With the removal of only four nuts, the T.V. monitor will be loose.

CAUTION: BE SURE to support the T.V. monitor from the rear while removing the four bolts so it will not fall out of the cabinet.

- f. The monitor is removed by supporting it and pulling straight back.
- g. To reinstall the T.V. monitor, reverse this procedure.
- h. After replacing the T.V. monitor, be sure to run the game Self-Test.

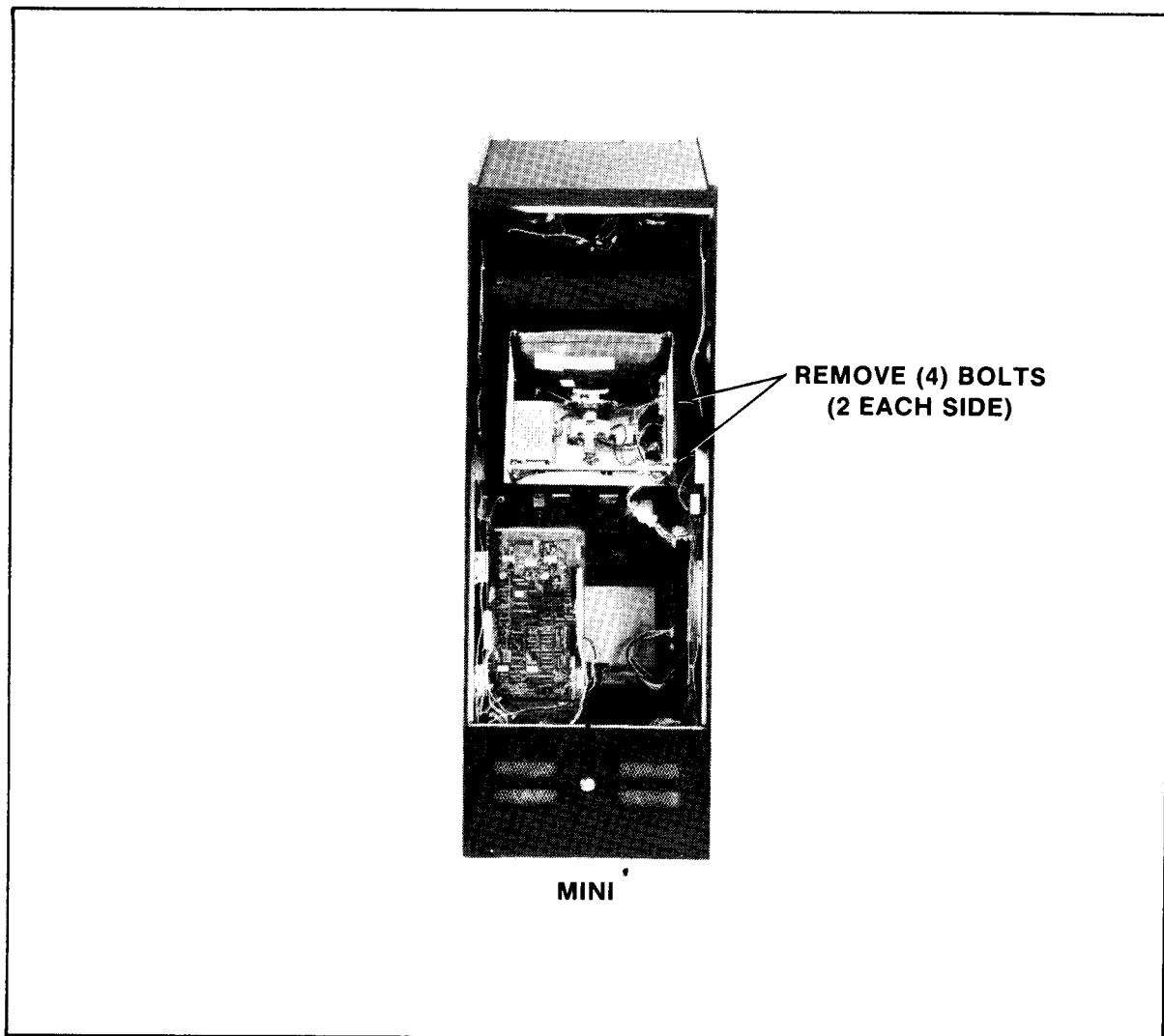

FIGURE 28

3. Cocktail Table model — See Figure 29.

- a. Turn the power off to the game.
- b. Open the coin box door and release the two latches indicated in Figure 18.

CAUTION: The left hand latch is very close to the sharp metal edge on the monitor chassis. Be careful not to cut yourself when working the latch.

- i. Once the latches are released, unhook them from their latch paltes.
- c. Grasp the table top at "A" and open it as indicated in Figure 18.

CAUTION: Due to the weight of the monitor, EXTREME CARE MUST be taken when opening the cabinet.

- d. Remove the screws which hold the table top glass clamps in place.
- e. Remove the table top glass.
- f. Lift out the T.V. bezel assembly.
- g. Completely disconnect the T.V. monitor from all its cabling. **DON'T FORGET THE CHASSIS GROUND WIRE.**
- h. Completely disconnect the mother and daughter boards from all their cabling and slide them out of their supports.
- i. Remove the screws holding the T.V. monitor chassis to its mounting brackets while at the same time supporting it so it can't move.
- j. After the last screw is removed, the T.V. monitor may be lifted straight away from the table top's back side.
- k. To reinstall the T.V. monitor, reverse this procedure.
- l. After replacing the T.V. monitor, be sure to run the game Self-Test.

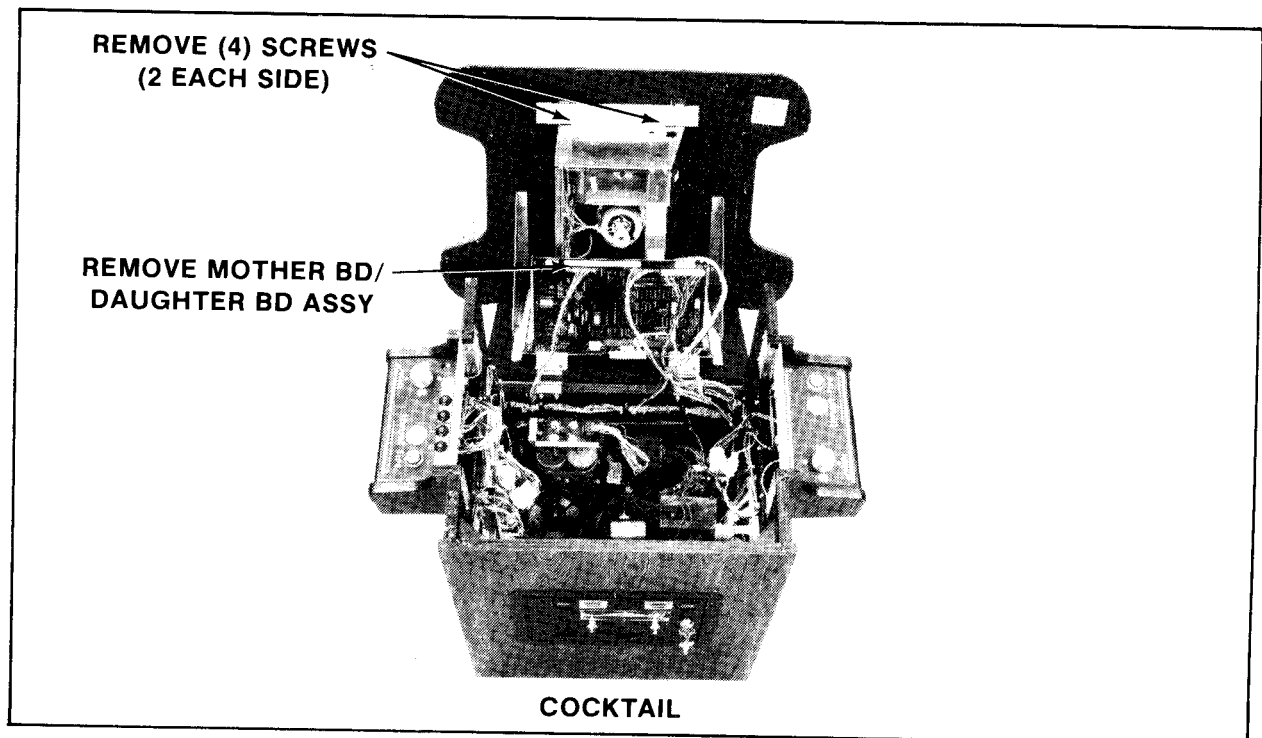

FIGURE 29

4. Sit Down model — See Figure 30.

- a. Turn the power off to the game.
- b. Remove the upper and lower rear access doors:
 - i. Unlock and open the lower rear access door.
 - ii. Release the latches which secure the upper rear access door and unhook them from their latch plates.
 - iii. The upper rear access door is now free and can be removed.
- c. Lift out the scenery.
- d. Disconnect the power cable from the lighting tube fixture.
- e. Remove the screws which secure the lighting fixture and its mounting bracket in place.
 - i. Remove the lighting fixture and mounting bracket assembly and set it aside.
- f. Completely disconnect the T.V. monitor from all its cabling. **DON'T FORGET THE CHASSIS GROUND WIRE.**
- g. Remove the cable clamps at the front edge of the monitor mounting board. See Figure 30.
- h. With the removal of the two securing screws, the T.V. monitor and its mounting board will be loose.
- i. The monitor mounting board slides on top of and against two wooden guides mounted to the cabinet's right and left sides. The monitor is removed by sliding it out the back of the cabinet.
- j. To reinstall the T.V. monitor, reverse this procedure.
- k. After replacing the T.V. monitor, be sure to run the game Self-Test.

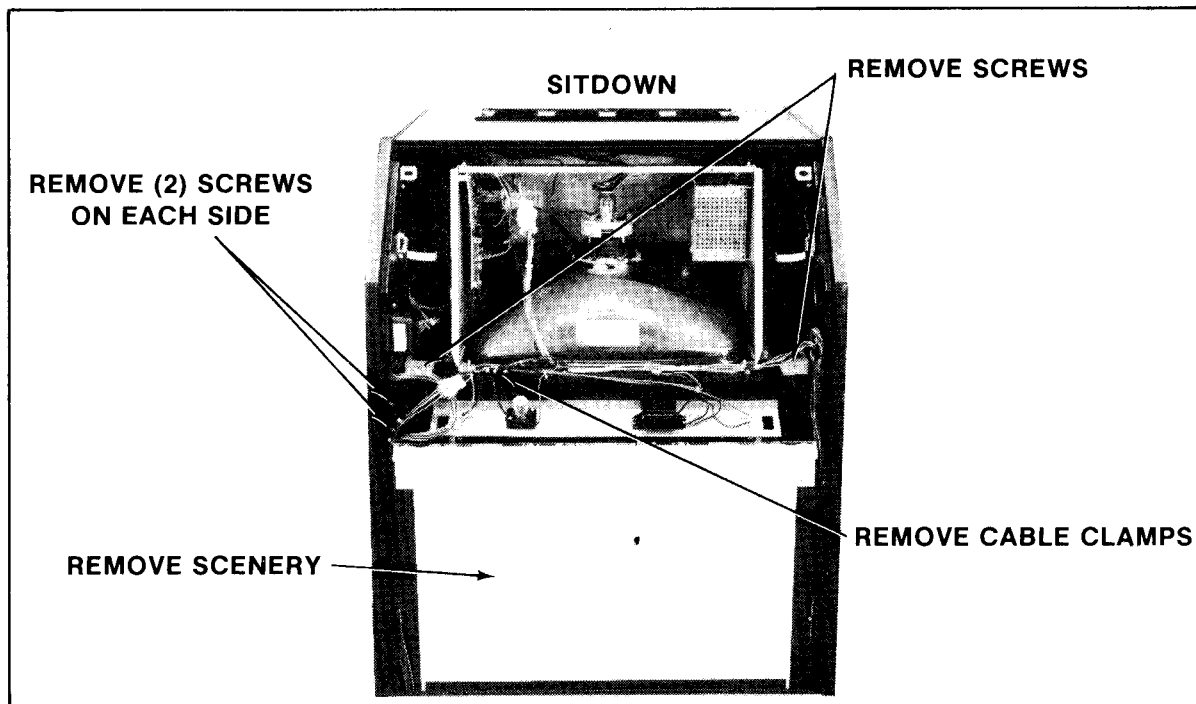

FIGURE 30

F. PRINTED CIRCUIT BOARD (P.C.B.) REPLACEMENT:

1. Upright model — See Figure 31.

- a. Turn the power to the game off.
- b. Unlock and open the rear access door.
- c. Disconnect the daughter board from all its cabling and unplug it from the mother board.
- d. Disconnect the mother board from all its cabling, remove the P.C.B. supports indicated in Figure 31, and slide the mother board out the back of the cabinet.
- e. Disconnect the linear power supply board from all its cabling, remove the P.C.B. supports indicated in Figure 31, and slide the linear power supply board out the back of the cabinet.
- f. To reinstall the above P.C.B.'s, reverse this procedure.

NOTE: P.C.B.'s are all keyed and will **ONLY** fit into their connectors one way without forcing them. The plugs on the cable harness which connect it to the P.C.B.'s are also keyed and will **ONLY** go onto their connectors one way without forcing them.

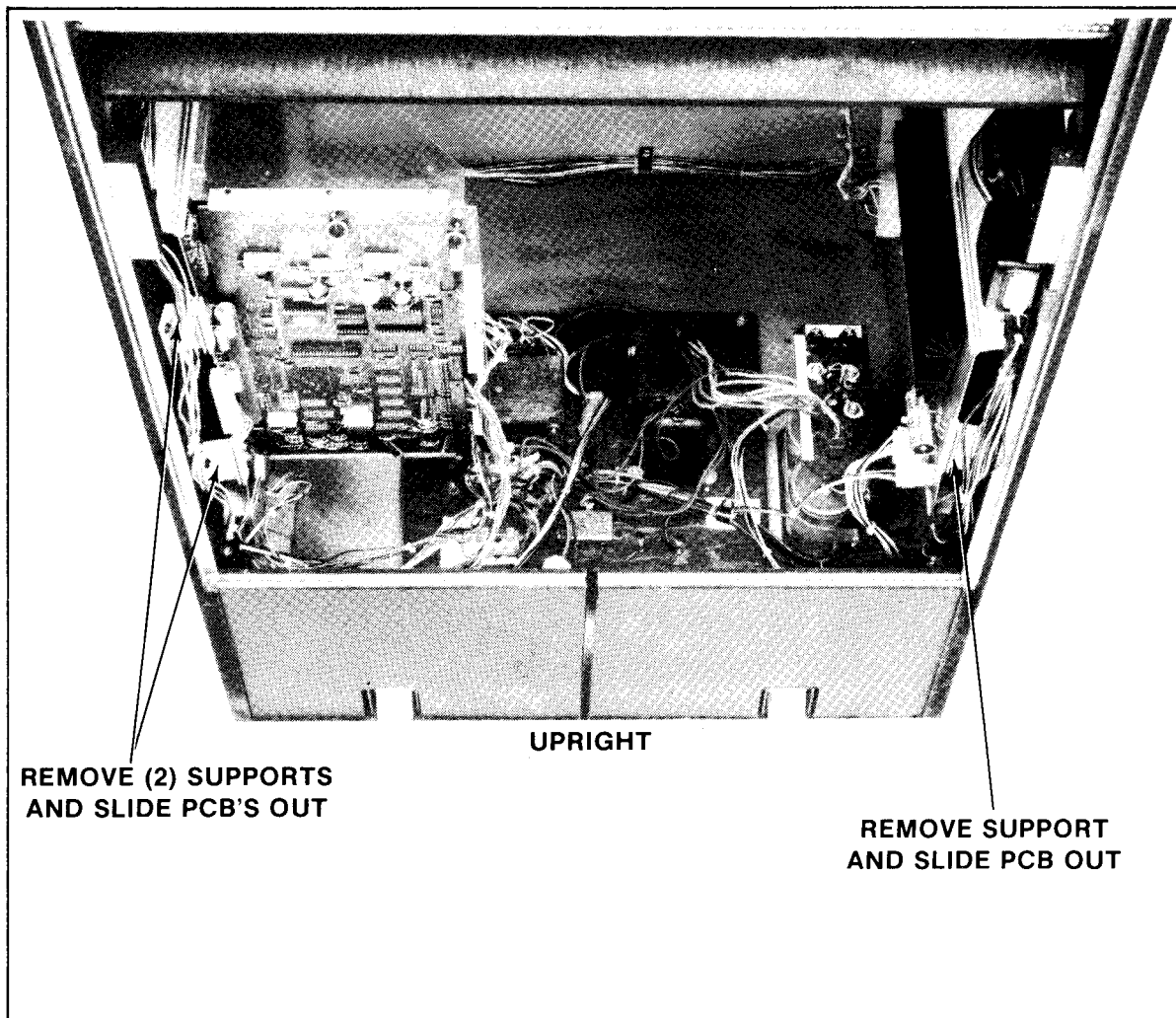

FIGURE 31

2. Mini model — See Figure 32.

- a. Turn the power off to the game.
- b. Unlock and open the rear access door.
- c. Disconnect the daughter board from all its cabling and unplug it from the mother board.
- d. Disconnect the mother board from all its cabling, remove the P.C.B. supports indicated in Figure 32, and slide the mother board out the back of the cabinet.
- e. Disconnect the linear power supply board from all its cabling, remove the P.C.B. supports indicated in Figure 32, and slide the linear power supply board out the back of the cabinet.
- f. To reinstall the above P.C.B.'s, reverse this procedure.

NOTE: P.C.B.'s are all keyed and will **ONLY** fit into their connectors one way without forcing them. The plugs on the cable harness which connect it to the P.C.B.'s are also keyed and will **ONLY** go onto their connectors one way without forcing them.

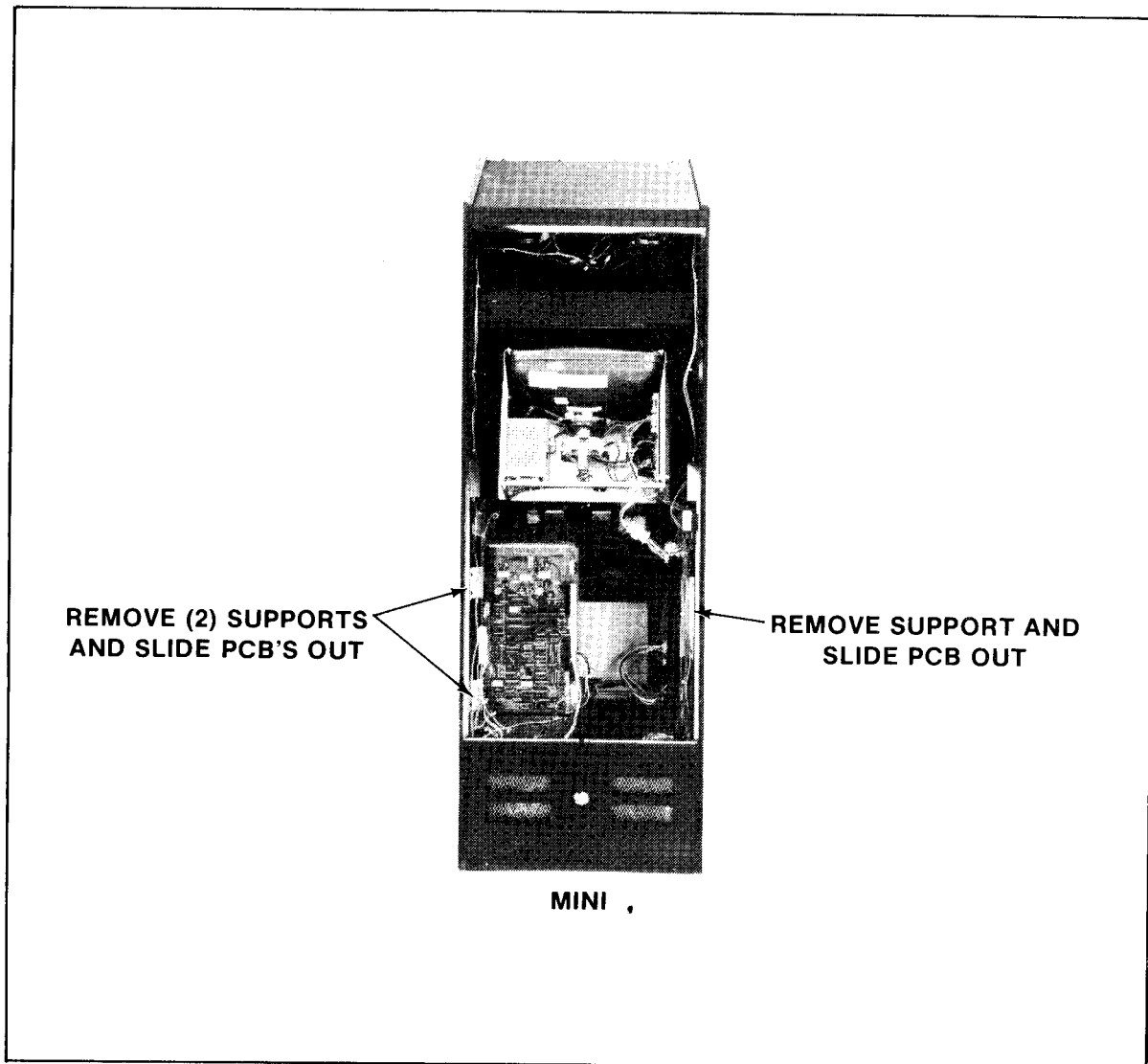

FIGURE 32

3. Cocktail Table model —

- a. Turn the power off to the game.
- b. Open the cabinet:
 - i. Open the coin box door and release the two latches indicated in Figure 18.

CAUTION: The left hand latch is very close to the sharp metal edge on the monitor chassis. Be careful not to cut yourself when working the latch.

- Once they're released, unhook them from their latch plates.

- c. Grasp the table top at "A" and open it as indicated in Figure 18.

CAUTION: Due to the weight of the monitor, EXTREME CARE MUST be taken when opening the cabinet.

- d. To remove the linear power supply board — See Figure 33.
 - i. Disconnect it from all its cabling.
 - ii. Remove the two smallest P.C.B. supports.
 - iii. Once these are removed, the linear power supply can be lifted out of the cabinet.
 - iv. To reinstall the linear power supply board, reverse this procedure.

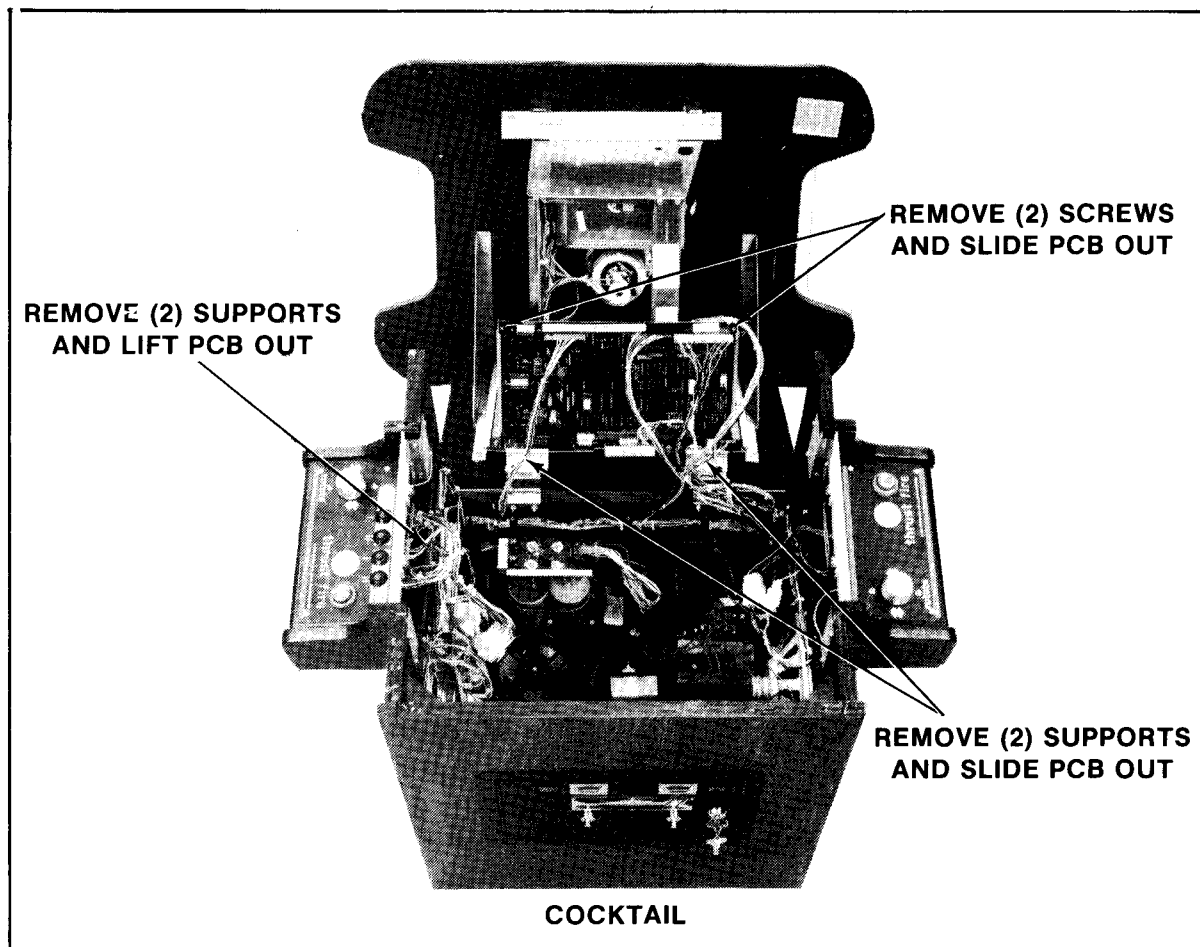

FIGURE 33

- e. To remove the mother and daughter boards — See Figure 33.
 - i. Disconnect the daughter board from all its cabling.
 - ii. Remove the nylon retainer screws at its upper right and left hand corners.
 - iii. The daughter board is now free and can be slid from its bracket.
 - iv. Disconnect the mother board from all its cabling.
 - v. Remove the screws from the P.C.B. supports indicated in Figure 33 and then remove the supports.
 - vi. The mother board is now free and can be slid from its P.C.B. supports.
 - vii. To reinstall the mother and daughter boards, reverse this procedure.

4. Sit Down model — See Figure 34.

- a. Turn the power off to the game.
- b. Unlock and open the front access door.
- c. Disconnect the daughter board from all its cabling and unplug it from the mother board.
- d. Disconnect the mother board from all its cabling.
- e. Remove the screws indicated in Figure 34 and the mother board plus its mounting assembly are now free to be slid out of the cabinet.
- f. Disconnect the linear power supply from all its cabling.
- g. Remove the screws from the P.C.B. supports indicated in Figure 34 and then remove the supports.
- h. The linear power supply is now free and can be slid from its P.C.B. supports.
- i. To reinstall the above mother, daughter, and linear power supply boards, reverse this procedure.

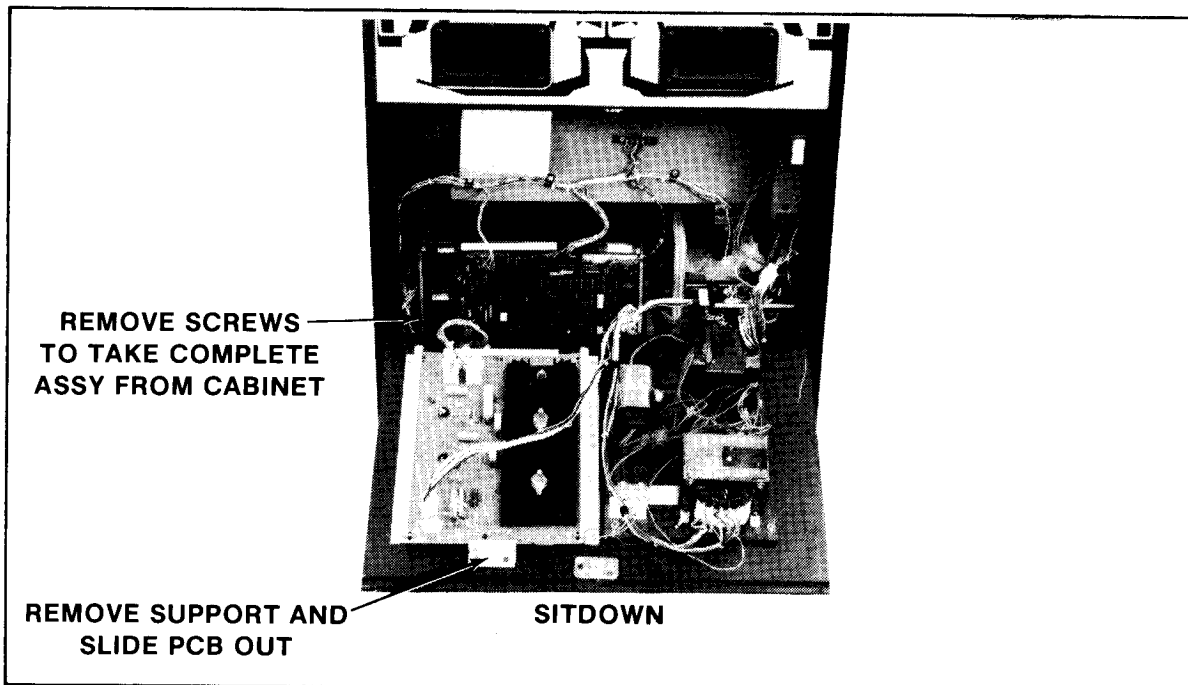

FIGURE 34

G. OPENING THE ATTRACTION PANEL(s):

1. Upright model:

The upright model has two attraction panels, one at the very top of the cabinet and one in the middle just below the control panel.

- a. Turn the power off to the game.
- b. Opening the attraction panel at the top of the cabinet — See Figure 35:
 - i. Remove the screws which secure the top bracket in place. (They are on its top side.)
 - ii. Remove the top bracket and slide up the attraction panel. This exposes the attraction panel light bulbs and their mounting board.

- **To service the light bulbs and their mounting board:**

- Turn the power to the game back on so you can see which bulbs are burnt out.
- Mark the burnt out bulbs and turn the power to the game back off again.
- To replace the burnt out bulbs, grasp them gently and pull straight out. The new bulbs are gently pushed into the empty sockets.

- **To completely remove the light bulb mounting board:**

- Remove the control panel and main-display-glass as described previously and unplug the mounting board from its power cable.
- Remove the screws that hold the mounting board to the cabinet.
- Gently slide the mounting board out the front of the cabinet being careful not to catch its cable on anything.

- c. Replacing the Speakers — See Figure 35:
 - i. Be sure the power is off to the game.
 - ii. Remove the control panel and main-display-glass and disconnect the speakers from their cabling.
 - iii. Remove the screws which secure the speaker grill in place and set the speaker grill aside.
 - iv. The bolts which secure the speakers in place are now accessible.
 - v. Once the bolts which secure the speakers in place are removed, the speakers may be removed through opening where the main-display-glass was.
- d. Servicing the light behind the attraction panel in the center of the cabinet below the control panel.
 - i. Remove the control panel as described previously. This exposes the attraction panel fluorescent light tube and its mounting bracket assembly.
 - ii. The fluorescent light tube may be replaced at this time by reaching through the space where the control panel was before you removed it and around the light tubes mounting bracket assembly.

WARNING: If you drop a fluorescent tube and it breaks, IT WILL IMplode! Shattered glass can fly six (6) feet or more from the implosion. Use care when replacing any fluorescent tube.

iii. Replacing the fluorescent tube starter —

- Grasp the starter (it is on the back of the mounting bracket), give it a quarter turn, and remove it from its socket.

iv. Replacement of the fluorescent tube mounting bracket assembly -

- Be sure the power is off to the game.
- Disconnect it from its power cable.
- Remove the screws along its base which secure it to the cabinet and remove it.

e. To reinstall any of the items removed above, reverse this procedure.

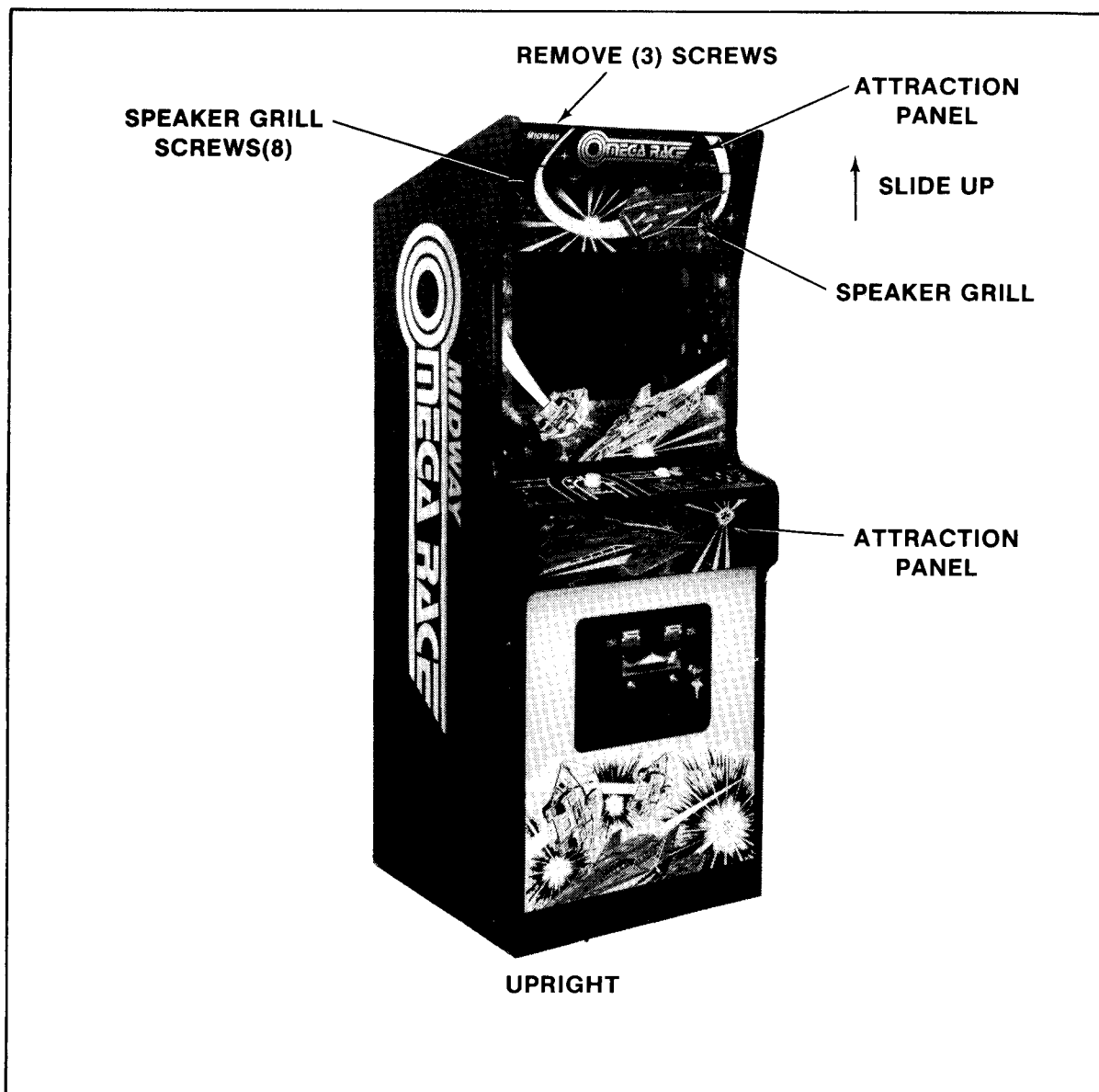

FIGURE 35

2. Mini model — See Figure 36:

- a. Turn the power off to the game.
- b. Remove the screws from the top of the top bracket.
- c. Remove the top bracket and slide up the attraction panel. This exposes the attraction panel light bulbs and their mounting board.
- d. To service the light bulbs and their mounting board:
 - i. Turn the power to the game back on so you can see which bulbs are burnt out.
 - ii. Mark the burnt out bulbs and turn the power to the game off again.
 - iii. To replace the burnt out bulbs, grasp them gently and pull straight out.
 - The new bulbs are gently pushed into the empty sockets.

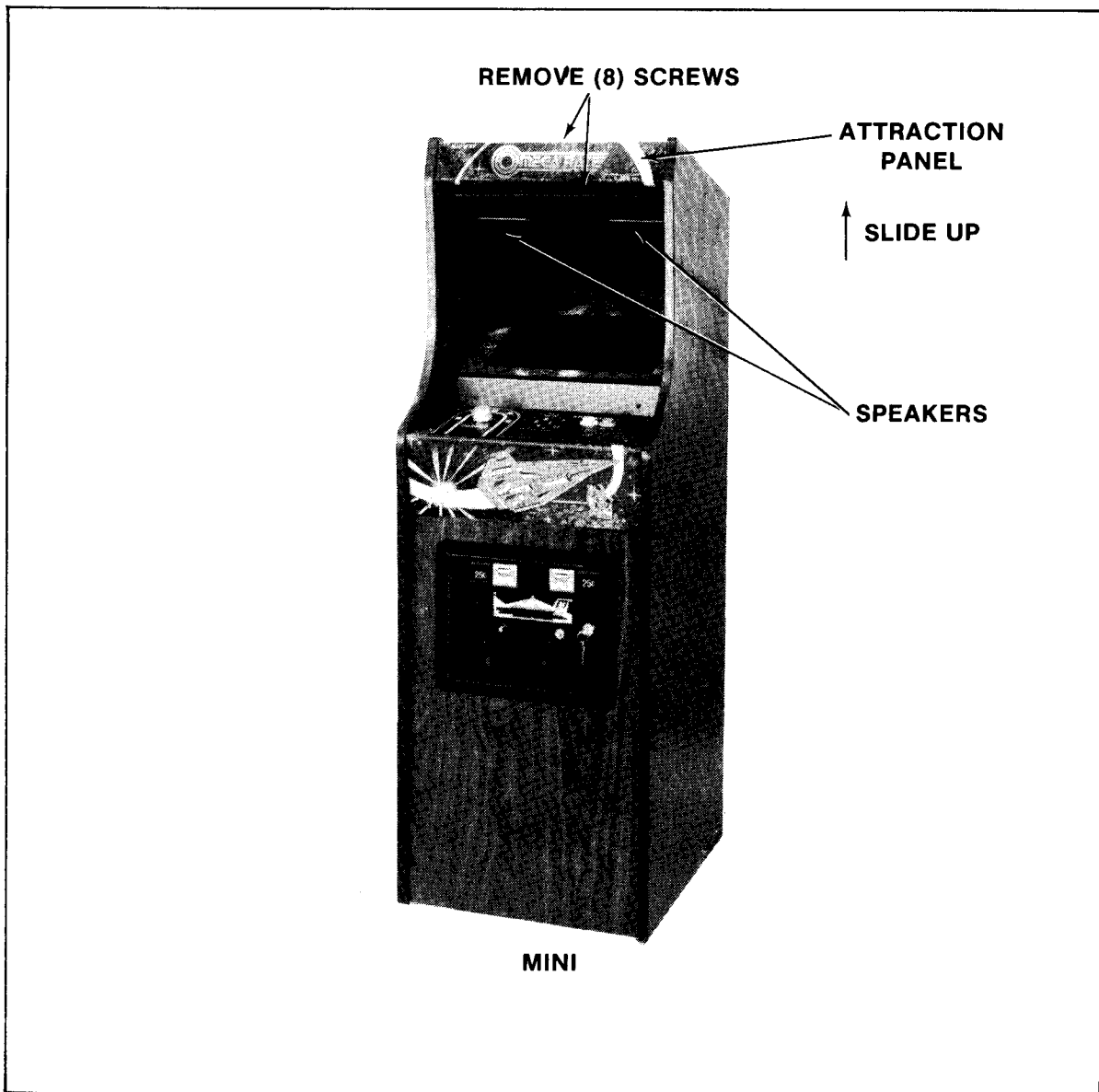

FIGURE 36

- iv. To completely replace the light bulb mounting board:
 - Open the cabinet rear access door and unplug the mounting board from its power cable.
 - Remove the screws that hold the mounting board to the cabinet.
 - Gently slide the mounting board out the front of the cabinet being careful not to catch its cable on anything.
 - e. To replace the speaker(s) —
 - i. Be sure the power is off to the game.
 - ii. Disconnect the speaker(s) from its cabling.
 - iii. Remove the nuts and bolts securing the speaker(s) to be replaced.
 - iv. Slide the speaker(s) out through the rear access door.
 - f. To reinstall any of the items removed above, reverse this procedure.
3. The Cocktail Table model and the Sit Down model have no back lit attraction panels.

H. COIN DOOR MAINTENANCE

1. Periodically, the metal coin acceptor mechanism(s) must be removed from the coin door and cleaned.
 - a. Make sure the power to the game is off.
 - b. Unlock and open the coin door.
 - d. Remove the coin acceptor mechanism(s) as shown in Figure 37.
 - i. Push down on the two spring loaded latches.
 - ii. While holding the latches down, pull the top of the coin acceptor mechanism toward you.
 - iii. Release the latches and lift out the coin acceptor mechanism.
 - d. Clean the magnet of all foreign particles. See Figure 38.
 - i. This may be accomplished by swinging the gate open as shown in the above figure.
 - e. Remove the cradles and undersize levers and clean the bushings. (A pipe cleaner makes a good bushing cleaner.)
 - i. Also clean the pivot pin.
 - f. Whenever needed, the coin acceptor should be cleaned with hot water and cleanser in the following manner.
 - i. Place the coin acceptor in boiling water for about ten minutes.

CAUTION: BE CAREFUL NOT TO BURN YOURSELF.
 - ii. Next, use a brush and kitchen cleaner to remove all remaining foreign matter from the unit.
 - iii. Rinse the coin acceptor in clean boiling water.
 - iv. Dry the coin acceptor thoroughly by using filtered compressed air to blow it dry.

NOTE: The reason we recommend using boiling water is that it evaporates faster than cold water and speeds drying time.

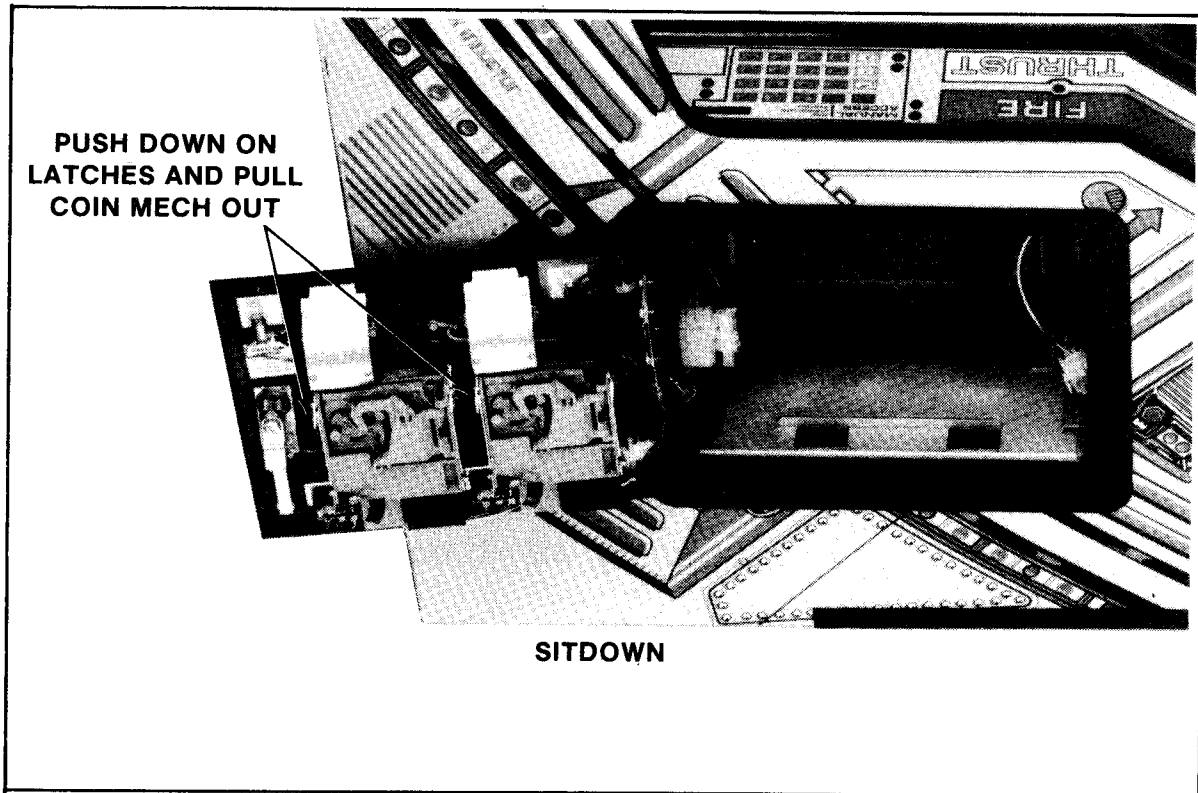

FIGURE 37

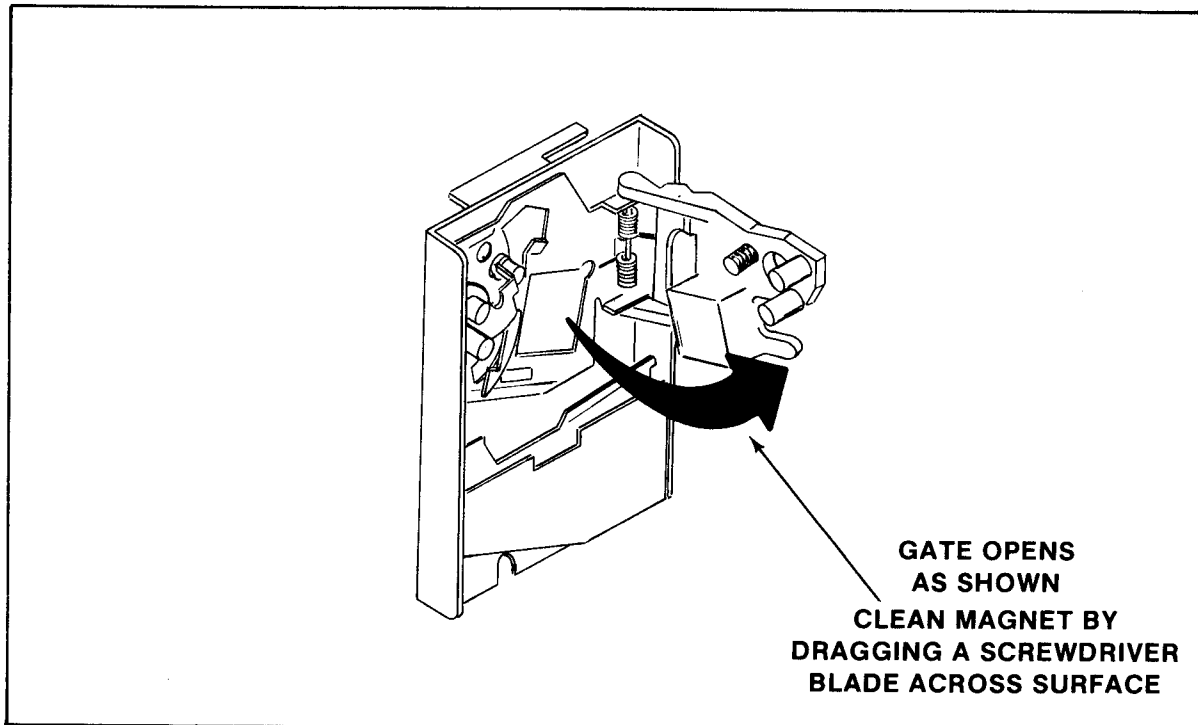

FIGURE 38

- g. To lubricate the coin acceptor:
 - i. Use **ONLY** powdered graphite and put it **ONLY** on the moving parts of the coin Acceptor. These parts are called out in Figure 39.
 - ii. Be extremely careful to keep the powdered graphite away from paths that are traveled by the coins.

WARNING
DO NOT USE OIL
TO LUBRICATE THE
COIN ACCEPTOR.

- h. Check the coin chute for obstructions such as: paper, gum, etc.
 - i. Reinstall the coin acceptor to the coin door.
 - i. Place the two pegs at the coin acceptor's base into their retaining slots.
 - ii. Now push the top of the coin acceptor toward the coin door until it snaps in place and is held there by the two spring loaded latches.
 - j. Close and lock the coin door.
2. The plastic coin acceptor mechanisms must be removed periodically from the coin door and cleaned.
- a. Make sure the power to the game is off.
 - b. Unlock and open the coin door.
 - c. Remove the coin acceptor mechanism(s) as shown in Figure 37.
 - i. Push down on the two spring loaded latches.
 - ii. While holding the latches down, pull the top of the acceptor mechanism toward you.
 - iii. Release the latches and lift out the mechanism.

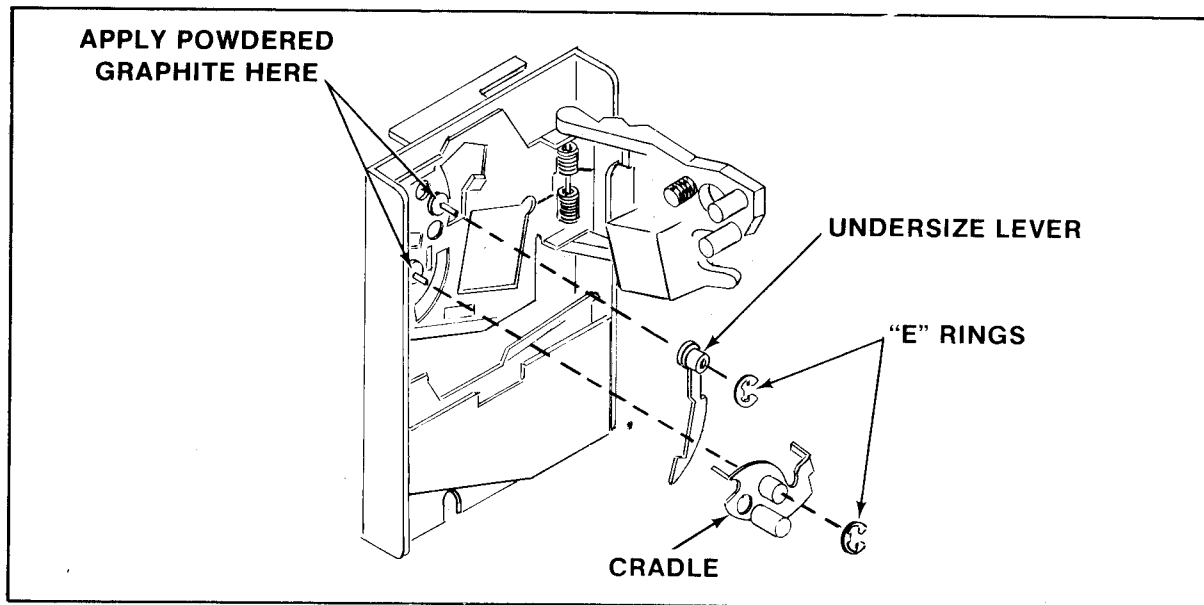

FIGURE 39

- d. Squeeze the two pins indicated in Figure 40 together to open the mechanism and break it down into its three basic parts.
 - i. Clean the mechanism in hot soapy water. It never rusts.
 - ii. Rinse the mechanism in clean hot water and allow it to dry.
 - iii. Reassemble the mechanism (it never needs lubrication).
- e. Check the coin chute for obstructions such as: paper, gum. etc.

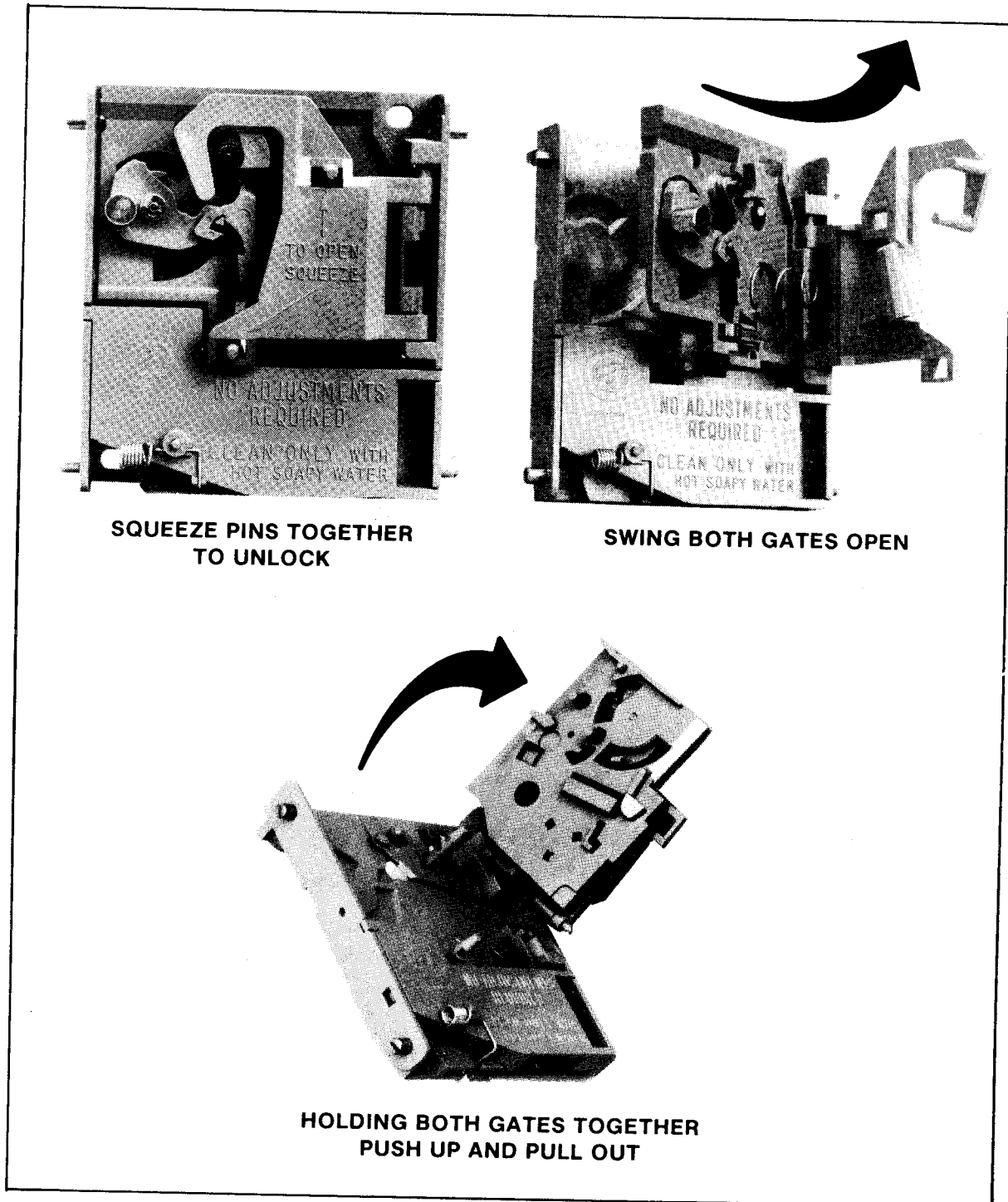

FIGURE 40

- f. Reinstall the coin acceptor to the coin door.
 - i. Place the two pegs at the coin acceptor's base into their retaining slots.
 - ii. Now push the top of the coin acceptor toward the coin door until it snaps in place and is held by the two spring loaded latches.
- g. Close and lock the coin door.

NOTE: See Figure 41 for instructions on how to set the plastic coin acceptor mechanisms to either accept or reject Canadian quarters.

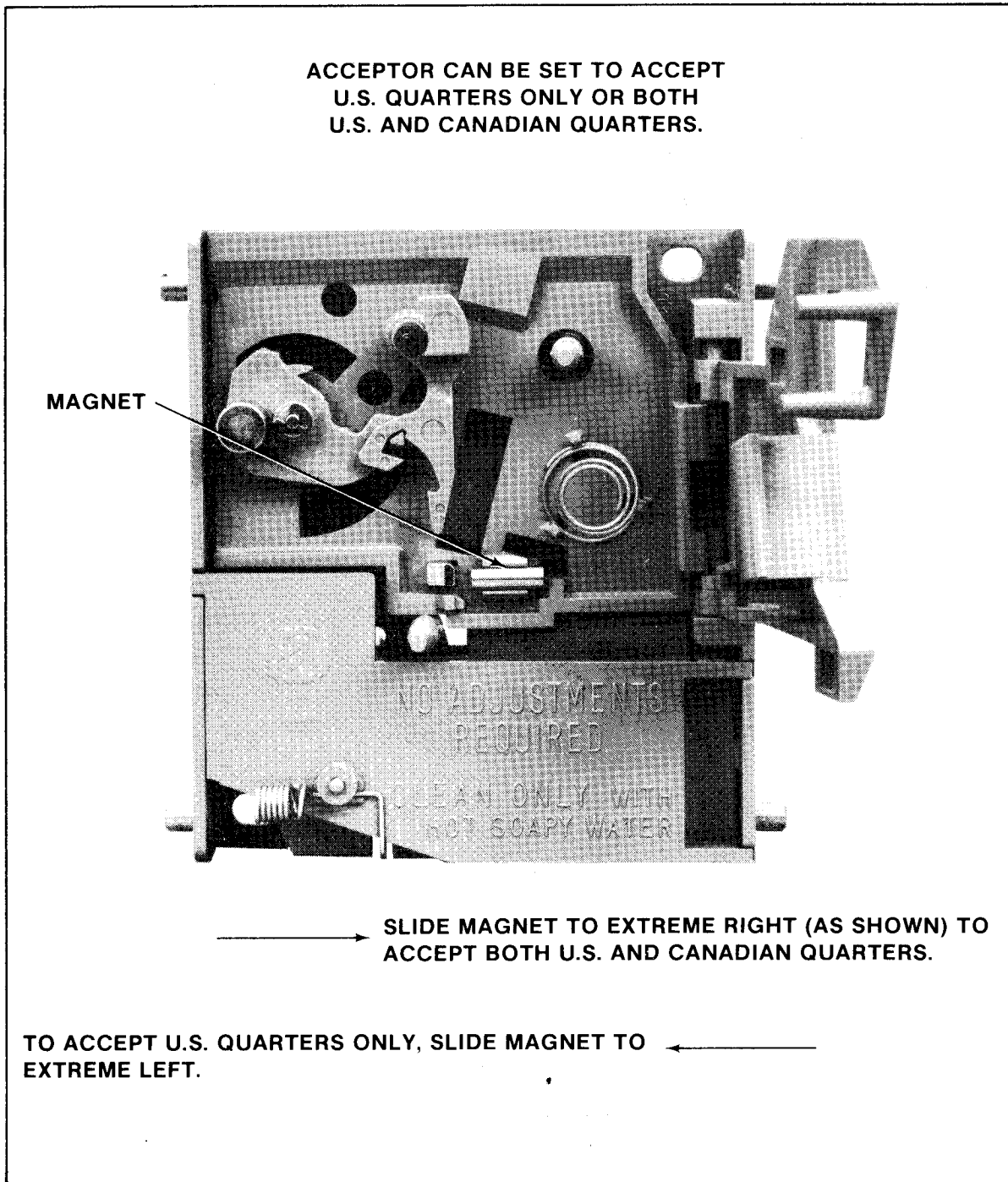

FIGURE 41

I. REPLACING THE ULTRAVIOLET LIGHT TUBE; STARTER; AND THE MOUNTING BRACKET ASSEMBLY.

1. Upright model

- a. Turn the power to the game off.
- b. Remove the rear access door.
- c. Remove the scenery .
- d. The ultraviolet light tube may now be removed and replaced in the same manner you would any ordinary fluorescent tube.

WARNING: If you drop an ultraviolet light tube and it breaks, IT WILL IMplode! Shattered glass from the implosion can fly six (6) feet or more. Use care when replacing any ultraviolet light tube.

- e. Replacing the ultraviolet light tube starter —
 - i. Be sure the power is off to the game.
 - ii. Grasp the starter (it is on the back side of the mounting bracket), give it a quarter turn, and remove it from its socket.
 - iii. To reinstall the starter, reverse this procedure.
- f. Replacement of the ultraviolet light tube mounting bracket assembly —
 - i. Be sure the power to the game is off.
 - ii. Disconnect the power cable leading to the mounting bracket assembly.
 - iii. Remove the screws which hold the mounting bracket assembly to the right and left hand sides of the cabinet. BE SURE to support it as you remove the last two screws so it does not fall.
 - iv. The ultraviolet light tube mounting bracket assembly is now free and can be removed.
 - v. To reinstall the above assembly, reverse this procedure.

2. Sit Down model

- a. Turn the power off to the game.
- b. Remove the lower rear access door.
- c. Remove the scenery .
- d. The ultraviolet light tube may now be removed and replaced in the same manner you would any ordinary fluorescent tube.

WARNING: If you drop an ultraviolet light tube and it breaks, IT WILL IMplode! Shattered glass from the implosion can fly six (6) feet or more. Use care when replacing any ultraviolet light tube.

- e. Replacing the ultraviolet light tube starter —
 - i. Be sure the power to the game is off.
 - ii. Grasp the starter , give it a quarter turn, and remove it from its socket.
 - iii. To reinstall the starter, reverse this procedure.

- f. Replacement of the ultraviolet light tube mounting bracket assembly —
 - i. Be sure the power to the game is off.
 - ii. Disconnect the power cable leading to the mounting bracket assembly.
 - iii. Remove the screws which hold the mounting bracket assembly to the right and left hand sides of the cabinet. BE SURE to support it as you remove the last two screws so it does not fall.
 - iv. The ultraviolet light tube mounting bracket assembly is now free and can be removed.
 - v. To reinstall the above assembly, reverse this procedure.

3. The Mini and Cocktail Table models have no ultraviolet lighting.

OMEGA RACE — CONTROL KNOB ASSY.

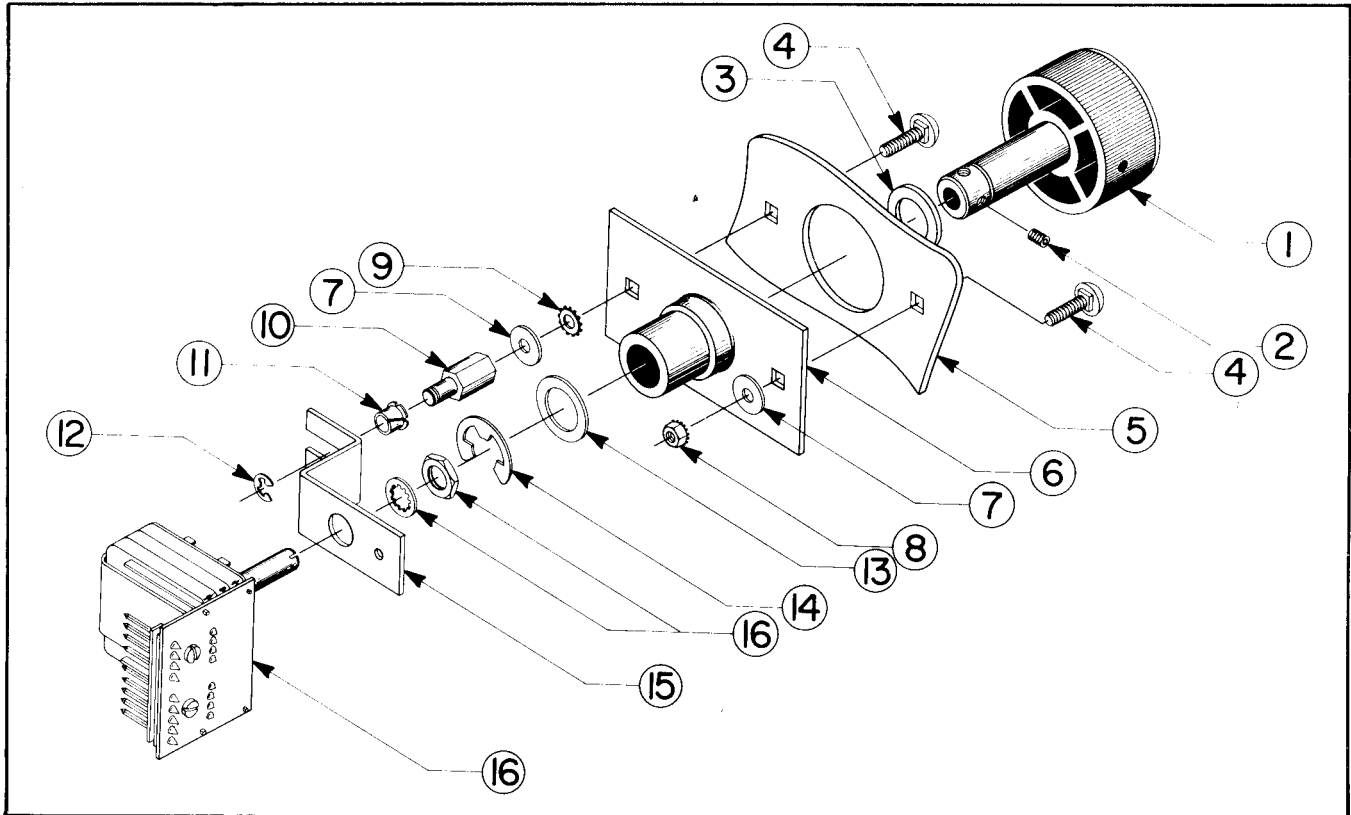

OMEGA RACE — CONTROL KNOB ASSY. — PARTS LIST

ORDER BY PART NUMBER ONLY

ITEM	PART NO.	DESCRIPTION
1	A894-00008-0000	KNOB & SHAFT ASSY. — S.D. ONLY
1	A929-00021-0000	KNOB & SHAFT ASSY. — U.R., C.T., MINI ONLY
2	0017-00101-0308	#8-32 x 3/16 SET SCREW
3	0017-00104-0109	NYLON WASHER
4	0017-00101-0620	#8-32 x 1/2 CARRIAGE BOLT (2 REQ'D.)
5	A894-00022-0000	LEFT CONSOLE/OVERLAY ASSY. — S.D.
5	0929-00102-00XF	CONTROL PANEL — U.R.
5	0930-00100-00XF	CONTROL PANEL — PLYR. #1 — C.T.
5	0930-00100-01XF	CONTROL PANEL — PLYR. #2 — C.T.
5	0931-00102-0000	CONTROL PANEL — MINI
6	A894-00010-0000	BEARING & PLATE ASSY.
7	0017-00104-0062	#8 FLAT WASHER (2 REQ'D.)
8	0017-00103-0061	#8-32 HEX NUT W/SEMS
9	0017-00104-0010	#8 EXT. LOCKWASHER
10	0894-00701-00XF	STABILIZER POST NUT
11	0017-00042-0173	3/16 NYLINER
12	0017-00100-0018	3/16 E-RING
13	0017-00104-0045	1/2 I.D. FLAT WASHER
14	0017-00100-0050	1/2 E-RING
15	0894-00112-00XF	ENCODER STABILIZER
16	A082-91110-A000	P.C. ENCODER ASSY. W/HARDWARE CONSISTING 3/8 INT. LOCK-WASHER & 3/8-32 NUT.

NO. 929 — OMEGA RACE UPRIGHT — FRONT

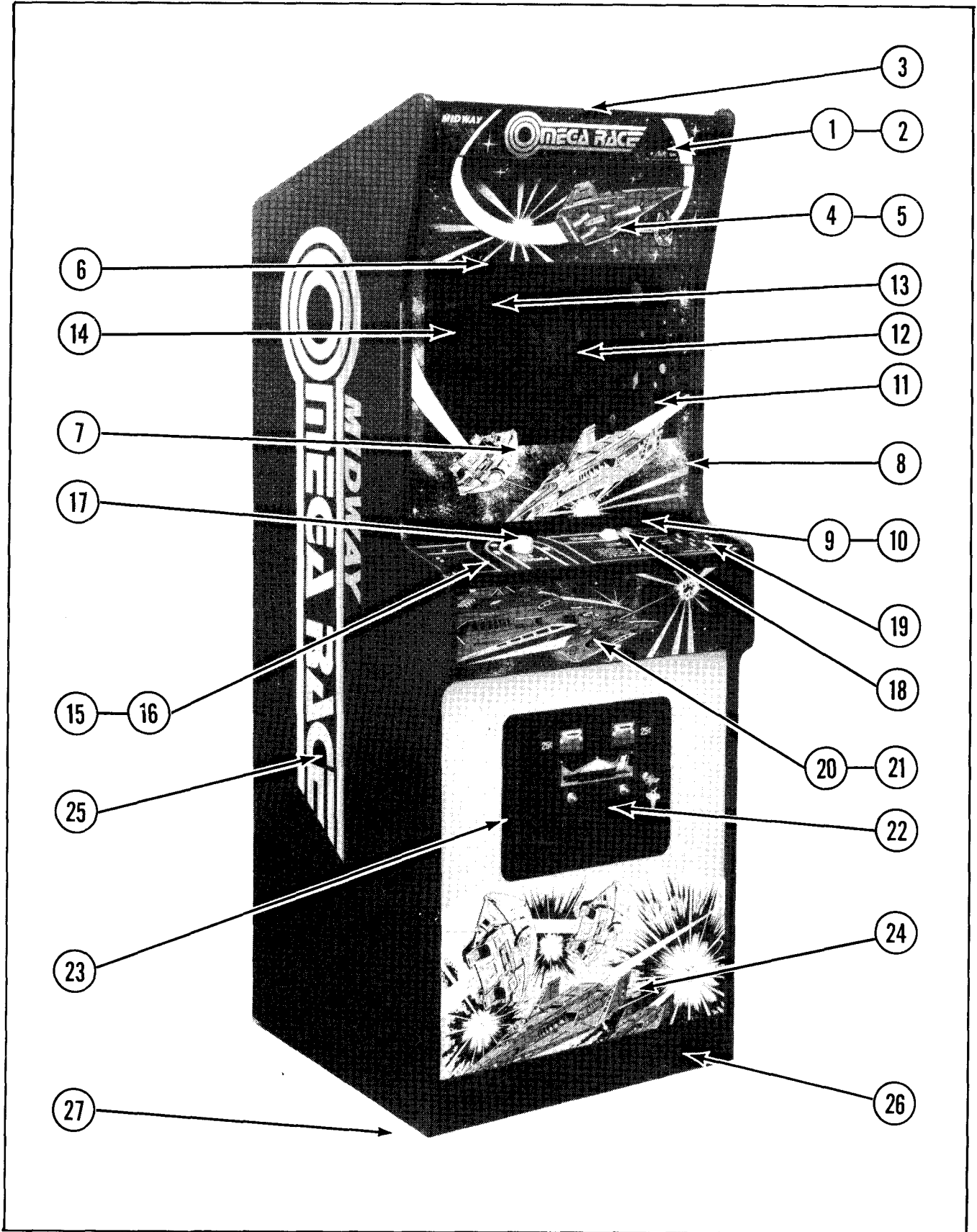

NO. 929 — OMEGA RACE UPRIGHT — PARTS LIST

ORDER BY PART NUMBER ONLY

ITEM	PART NO.	DESCRIPTION
1	0929-00904-00XF	DECORATIVE LEXAN PANEL — 23-7/8" x 4-3/32" x 3/16"
2	A929-00013-0000	LIGHT TRAY INSERT ASSY.
	0929-00909-0000	LIGHT TRAY BEZEL
	0017-00003-0219	#194 WEDGE LAMP 14V., .27A. (7 REQ'D.)
	0017-00031-0002	S11 LAMP HOLDER ASSY. (7 REQ'D.)
3	0929-00100-00XF	INSERT BRKT.
	0017-00101-00117	#8 x 5/8 PHIL TRS. HD. SCR. (3 REQ'D.)
4	0929-00105-00XF	SPEAKER PANEL GRILL
	0017-00101-00117	#8 x 5/8 PHIL. TRS. HD. SCR. (8 REQ'D.)
5	0017-00003-0187	6" x 9" SPEAKER 8 OHM, 9W (2 REQ'D.)
	0017-00101-0118	#8-32 x 1-1/8 CARRIAGE BOLT (8 REQ'D.)
	0017-00103-0061	#8-32 HEX NUT W/SEMS (10 REQ'D.)
6	A929-00011-0000	FLUORESCENT BRKT. ASSY — NOT SEEN
7	0929-00901-00XF	MAIN VIEWING GLASS — 23-13/16" x 20-5/8" x 3/16"
8	0537-00903-0049	GLASS CHANNEL — 17-3/4" LG. (2 REQ'D.)
9	0537-00903-0034	GLASS CHANNEL — 23" LG. (2 REQ'D.)
10	0629-00902-0800	GLASS LIFT CHANNEL — 20" LG.
11	0929-00916-0100	RIGHT FRONT SIDE SCENERY
12	0929-00912-0100	RIGHT SIDE SCENERY
13	0929-00907-00XF	BACK SCENERY CARD
	0929-00912-0200	LEFT SIDE SCENERY — (NOT SEEN)
	0929-00916-0200	LEFT FRONT SIDE SCENERY — (NOT SEEN)
14	0929-00902-0000	MIRROR — 23-27/32" x 19-3/4" x 1/4"
15	0929-00102-00XF	CONTROL PANEL
16	0929-00908-0000	CONTROL OVERLAY — DECORATIVE
	0017-00101-0341	#6 x 1/4 PHIL. TRS. HD. SCR. (4 REQ'D.)
	0961-00115-00XF	STRIKE (2 REQ'D.)
	0017-00101-0607	#8-32 x 3/8 HEX HD. BUTTON SCR. (4 REQ'D.)
	0017-00103-0041	#8-32 LOCK NUT (4 REQ'D.)
17	A929-00021-0000	KNOB & SHAFT ASSY.
18	0017-00042-0256	PUSH BUTTON ASSY. — RED
	0017-00042-0257	PUSH BUTTON ASSY. — YELLOW
	0017-00032-0093	P.B. SWITCH W/HOLDER (2 REQ'D.)
19	0017-00032-0092	LIGHTED RED P.B. SWITCH (4 REQ'D.)
	0929-00905-00XF	SWITCH BEZEL (4 REQ'D.)
20	0929-00903-00XF	LOWER HEADER — DECORATIVE
21	A929-00022-0000	LOWER FLUOR. BRKT. ASSY. — NOT SEEN
22	A090-00300-06BK	DOUBLE ENTRY COIN DOOR ASSY.
23	0090-00002-02BK	LARGE COIN DOOR FRAME
	0017-00101-0121	#6-32 x 5/16 PHIL. TRS. HD. SCR. (3 REQ'D.) (MOUNTS COIN DOOR TO FRAME)
24	0929-00915-0000	DECAL — FRONT
25	0929-00913-0000	DECAL — CABINET SIDES (2 REQ'D.)
26	0935-00906-0300	KICK PLATE 23-7/8" LG.
27	0017-00102-0048	3/8-16 x 2" LEG LEVELERS (4 REQ'D.)
	0017-00103-0026	3/8-16 LEG LEVELER HEX NUTS (4 REQ'D.)
	A929-00031-0000	NOT SHOWN LIST T.V. BEZEL ASSY.
	0929-00906-0000	BEZEL
	0929-00914-0000	TRANSPARENT VINYL OVERLAY — 20" x 13-1/2"
	0929-00106-01XF	CONTROL SHELF BRKT. SUPPORT — RIGHT
	0929-00106-02XF	CONTROL SHELF BRKT. SUPPORT — LEFT
	0017-00009-0033	BASSICK CLAMP (2 REQ'D.)

NO. 929 — OMEGA RACE UPRIGHT — REAR ACCESS

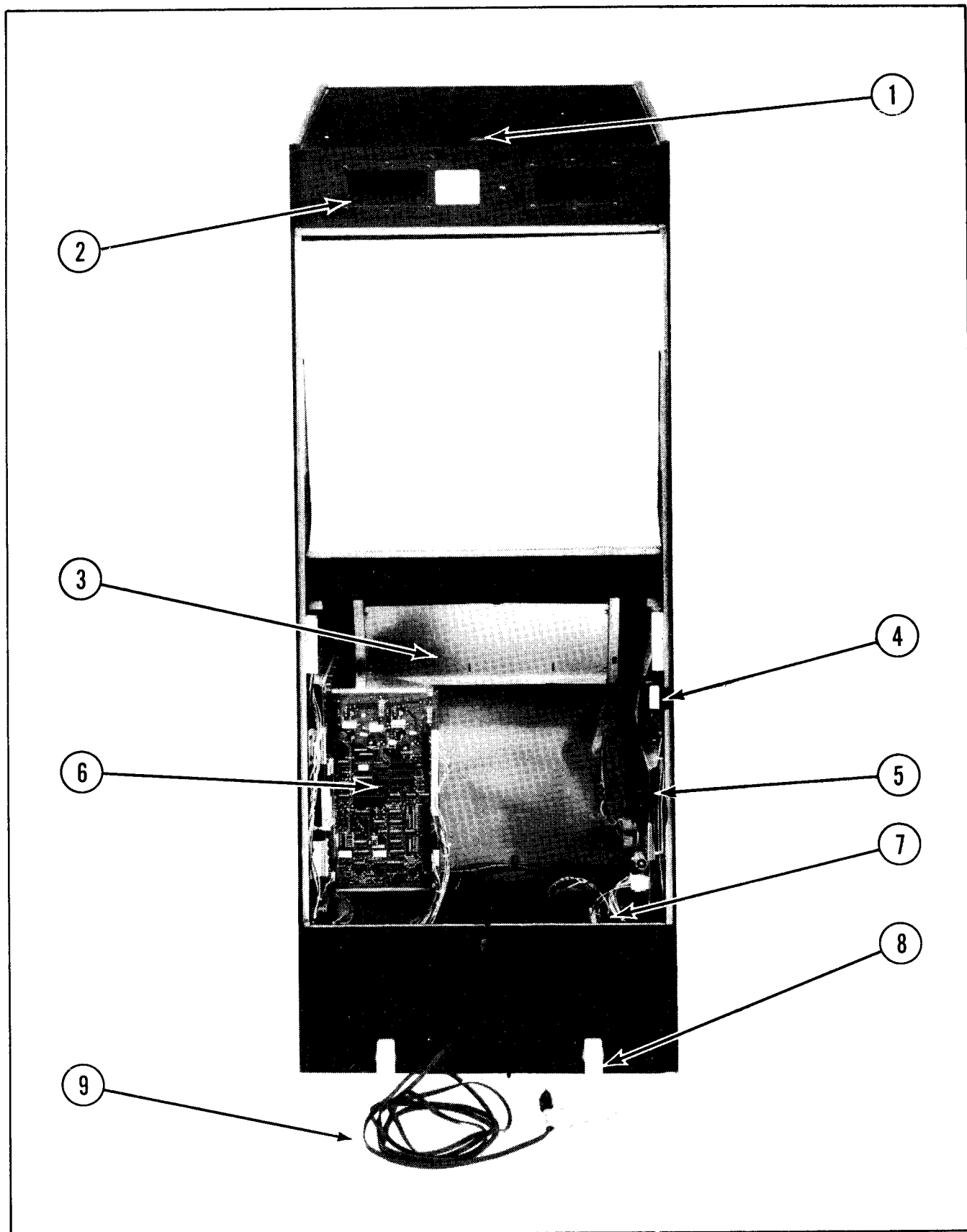

NO. 929 — OMEGA RACE UPRIGHT — REAR ACCESS PARTS LIST
ORDER BY PART NUMBER ONLY

ITEM	PART NO.	DESCRIPTION
1	A627-00066-0000	ON/OFF SWITCH ASSY.
2	0894-00913-0000	RECESSED HAND LIFT (2 REQ'D.)
	0017-00101-0117	#8 x 5/8 PHIL. TRS. HD. SCR. (12 REQ'D.)
3	0017-00003-0324	ELECTROHOME — 19" B&W MONITOR & CHASSIS (OR)
3	0017-00003-0325	WELLS-GARDNER — 19" B&W MONITOR & CHASSIS
	0017-00102-0012	1/4-20 x 1-1/4 UNSLT. HEX BOLT. (4 REQ'D.)
	0017-00104-0046	FLAT WASHER (4 REQ'D.)
	0017-00104-0014	DISH WASHER (4 REQ'D.)
	0017-00103-0018	1/4-20 HEX NUT (4 REQ'D.)
	0929-00910-0000	FORMED MONITOR FISHPAPEDED SHIELD
4	A151-00027-0000	INTERLOCK SWITCH ASSY.
5	A082-90413-D000	LINEAR POWER SUPPLY ASSY.
	0624-00902-0100	P.C. SUPPORT BRKT. — 12" LG. (3 REQ'D.)
	0624-00902-0300	P.C. SUPPORT BRKT. — 2-1/2" LG. (3 REQ'D.)
	0624-00902-0500	P.C. SUPPORT BRKT. — 6" LG. (4 REQ'D.)
	0017-00101-0025	#8 x 1/2 SLT. HEX HD. SCR. (20 REQ'D.)
	0017-00104-0037	#8 FLAT WASHER (20 REQ'D.)
6	A084-91372-G929	GAME LOGIC BRD. ASSY. (DAUGHTER BRD.)
	A084-90007-H929	MOTHER BRD. ASSY.
	A597-00012-0100	P.C. SUPPORT BRKT. ASSY.
	A597-00012-0200	P.C. SUPPORT BRKT. ASSY.
	0017-00101-0096	#6 x 3/8 SLT. HEX HD. SCR. (6 REQ'D.)
7	A945-00002-0000	125V — FILTER ASSY.
	A929-00006-0000	TRANSFORMER BRD. ASSY — LOCATED NEXT TO FILTER ASSY.
8	A961-00007-0000	CASTER ASSY. (2 REQ'D.)
	0961-00109-0000	WHEEL BRKT. (2 REQ'D.)
	0017-00042-0255	PLASTIC WHEEL (2 REQ'D.)
	0894-00702-00XF	SHAFT (2 REQ'D.)
	0017-00100-0037	3/8" E-RING (2 REQ'D.)
9	0017-00003-0064	16 FT. LINE CORD
	ADDITIONAL PARTS LIST	
	A031-00004-0000	TERMINAL STRIP ASSY.
	0017-00009-0477	CASH BOX — MOLDED
	A961-00008-0000	CASH BOX COVER ASSY.
	A894-00024-0000	CASH BOX SIDE CHANNEL ASSY.
	0894-00121-0000	CASH BOX SIDE CHANNEL — LONG
	0017-00101-0628	#8-32 x 3/4 CARRIAGE BOLT (4 REQ'D.)
	0017-00104-0022	#8 FLAT WASHER (4 REQ'D.)
	0017-00103-0061	#8-32 HEX NUT W/SEMS (4 REQ'D.)
	A151-00029-0000	BACK DOOR LOCK ASSY.
	0017-00009-0490	5-5/8" SQ. VENT GRILL (4 REQ'D.)
	A929-00028-0000	HIGH VOLTAGE CABLE ASSY.
	A929-00027-0000	LOW VOLTAGE SIGNAL CABLE ASSY.
	A929-00026-0000	MASTER CABLE ASSY.
	A894-00035-0000	COIN DOOR CABLE ASSY.
	A929-00023-0000	CONTROL SHELF CABLE ASSY.
	A894-00031-0000	MOTHER & DAUGHTER BRDS. BRKT. ASSY.

NO. 929 — OMEGA RACE UPRIGHT — FLUORESCENT FIXTURE ASSYS.

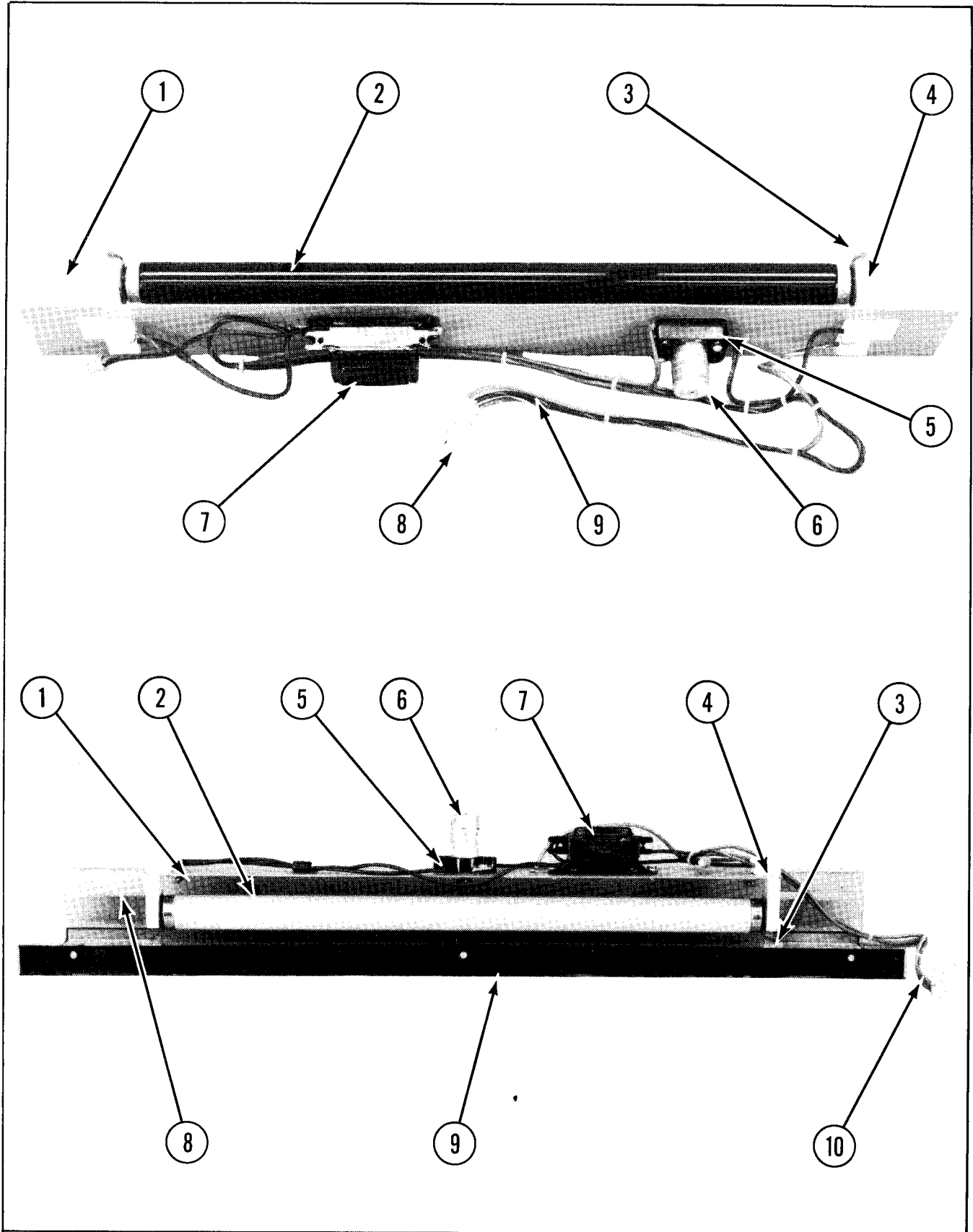

NO. 929 — OMEGA RACE UPRIGHT — FLUORESCENT FIXTURE ASSYS. — PARTS LIST

ORDER BY PART NUMBER ONLY

ITEM	PART NO.	DESCRIPTION
		UPPER FLUORESCENT BRKT. ASSEMBLY
1	0929-00101-0000	FLUORESCENT BRKT. — UPPER
2	0017-00003-0095	18" BLACK LIGHT LAMP — F15T8
3	0017-00021-0005	FLUORESCENT LOCKS (2 REQ'D.)
4	0017-00031-0036	FLUORESCENT SOCKET (2 REQ'D.)
5	0017-00021-0079	FLUOR. STARTER HOLDER
	0017-00101-0573	#6-32 x 1/2 PHIL. R.H.M.S. (4 REQ'D.)
6	0017-00003-0019	STARTER
7	0017-00003-0026	BALLAST
	0017-00101-0593	#8-32 x 1/4 SLT. PAN HD. M.S. (2 REQ'D.)
8	0017-00021-0096	2 PIN SOCKET CONNECTOR
9	A929-00030-0000	FLUOR. CABLE ASSY.
		LOWER FLUORESCENT BRKT. ASSEMBLY
1	0929-00107-0000	FLUORESCENT BRKT. — LOWER
2	0017-00003-0043	18" COOL WHITE LAMP
3	0017-00021-0005	FLUORESCENT LOCKS (2 REQ'D.)
4	0017-00031-0036	FLUORESCENT SOCKET (2 REQ'D.)
5	0017-00003-0412	FLUOR. STARTER HOLDER W/LEADS
	0017-00101-0573	#6-32 x 1/2 PHIL R.H.M.S. (4 REQ'D.)
	0017-00104-0009	#6 EXT. WASHER (4 REQ'D.)
6	0017-00003-0019	STARTER
7	0017-00003-0026	BALLAST
	0017-00101-0598	#8-32 x 5/16 SLT. HEX. HD. SCR. (2 REQ'D.)
8	0929-00104-0000	RETAINER BRKT.
	0017-00101-0025	#8 x 1/2 SLT. HEX HD. SCR. (3 REQ'D.)
9	0929-00903-00XF	LOWER HEADER — DECORATIVE
10	A929-00032-0000	CABLE ASSY.

NO. 894 — OMEGA RACE SIT DOWN

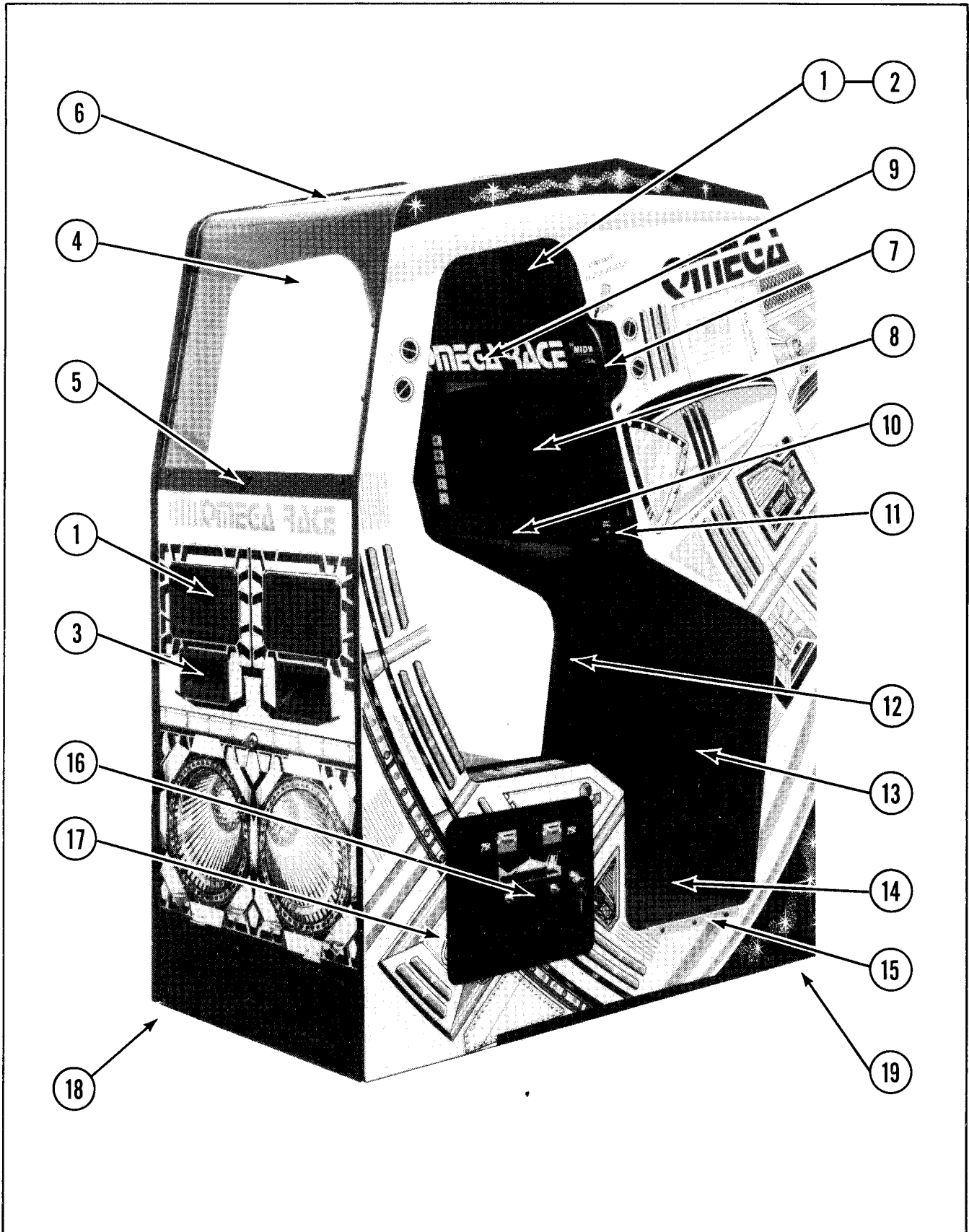

NO. 894 — OMEGA RACE SIT DOWN — PARTS LIST

ORDER BY PART NUMBER ONLY

ITEM	PART NO.	DESCRIPTION
1	0017-00009-0393	BLACK SPEAKER GRILL W/SLOTS (6 REQ'D.)
2	0017-00003-0187	6" x 9" SPEAKERS 8 OHM, 9W (2 REQ'D.)
	0017-00101-0127	#8-32 x 1-1/2 CARRIAGE BOLT (80 REQ'D.)
	0017-00101-0126	#10-32 x 3/4 HEX HD. BUTTON SCR. (4 REQ'D.)
	0017-00104-0062	#8 FLAT WASHER (20 REQ'D.)
	0017-00103-0061	#8-32 HEX NUT W/SEMS (20 REQ'D.)
3	0894-00913-00XF	RECESSED HAND LIFT (2 REQ'D.)
	0017-00101-0117	#8 x 5/8 PHIL. TRS. HD. SCR. (12 REQ'D.)
4	0894-00900-0000	CANOPY — ACRYLIC
5	0894-00103-00XF	PLEXI RETAINING STRAP — LOWER
6	0894-00104-00XF	PLEXI RETAINING STRAP — UPPER
	0017-00100-0114	BLACK NYLON FINISHING WASHER (9 REQ'D.)
	0017-00101-0029	#8 x 1" PHL. OVAL HD. SCR. — BLK. (6 REQ'D.)
	0017-00101-0126	#10-32 x 3/4 HEX HD. BUTTON SCR. (6 REQ'D.)
7	0894-00113-00XF	HANDLE — EXIT/ENTRY ASSIST (2 REQ'D.)
	0017-00101-0126	#10-32 x 3/4 HEX HD. BUTTON SCR. (4 REQ'D.)
8	0894-00909-00XF	MAIN VIEWING GLASS — 24-13/16" x 12" x 3/16"
	0537-00903-0051	GLASS EDGE CHANNEL — 10-3/8 LG. (2 REQ'D.)
	0894-00904-0000	ONE WAY MIRROR
9	0894-00106-00XF	GLASS RETAINER — UPPER
10	0894-00105-00XF	GLASS RETAINER — LOWER
	0017-00101-0126	#10-32 x 3/4 HEX HD. BUTTON SCR. (6 REQ'D.)
11	0017-00032-0092	SMALL RED LIGHTED P.B. SWITCH (2 REQ'D.)
	0929-00905-00XF	SWITCH BEZEL (2 REQ'D.)
12	0894-00910-0100	CORNER CONDUIT — LEFT
13	0894-00914-0000	SCUFF PROTECTOR
	0894-00910-0200	CORNER CONDUIT — RIGHT — NOT SEEN
	0017-00101-0117	#8 x 5/8 PHIL. TRS. HD. SCR. (12 REQ'D.)
14	0894-00911-0000	FLOOR MAT
15	0894-00109-0000	THRESHOLD GUARD (2 REQ'D.)
	0017-00101-0742	#8 x 1/2 PHIL. TRS. HD. SCR. (6 REQ'D.)
16	A090-00300-06BK	DOUBLE ENTRY COIN DOOR ASSY.
17	0090-00002-02BK	LARGE DOOR FRAME
	0017-00101-0121	#6-32 x 5/16 PHIL. TRS. HD. M.S. (3 REQ'D.) (MOUNTS COIN DOOR TO FRAME)
18	0017-00102-0048	3/8-16 x 2" LEG LEVELERS (4 REQ'D.)
	0017-00103-0026	3/8-16 LEG LEVELER HEX NUTS (4 REQ'D.)
19	A894-00014-0000	CASTER ASSY. (2 REQ'D.)
	0894-00903-0000	NOT SHOWN LIST SEAT & BACK CUSHIONS (2 REQ'D.)
	0017-00102-0052	1/4-20 x 1" UNSLOT. HEX BOLT (6 REQ'D.)
	0017-00104-0014	PERIPHERY WASHER (6 REQ'D.)
	0894-00912-0000	MONITOR MASK
	0017-00009-0484	1/8" TAMPER PROOF ALLEN KEY
	0017-00032-0083	ON/OFF SWITCH W/NUT

NO. 894 — OMEGA RACE SIT DOWN — FRONT INTERIOR ACCESS

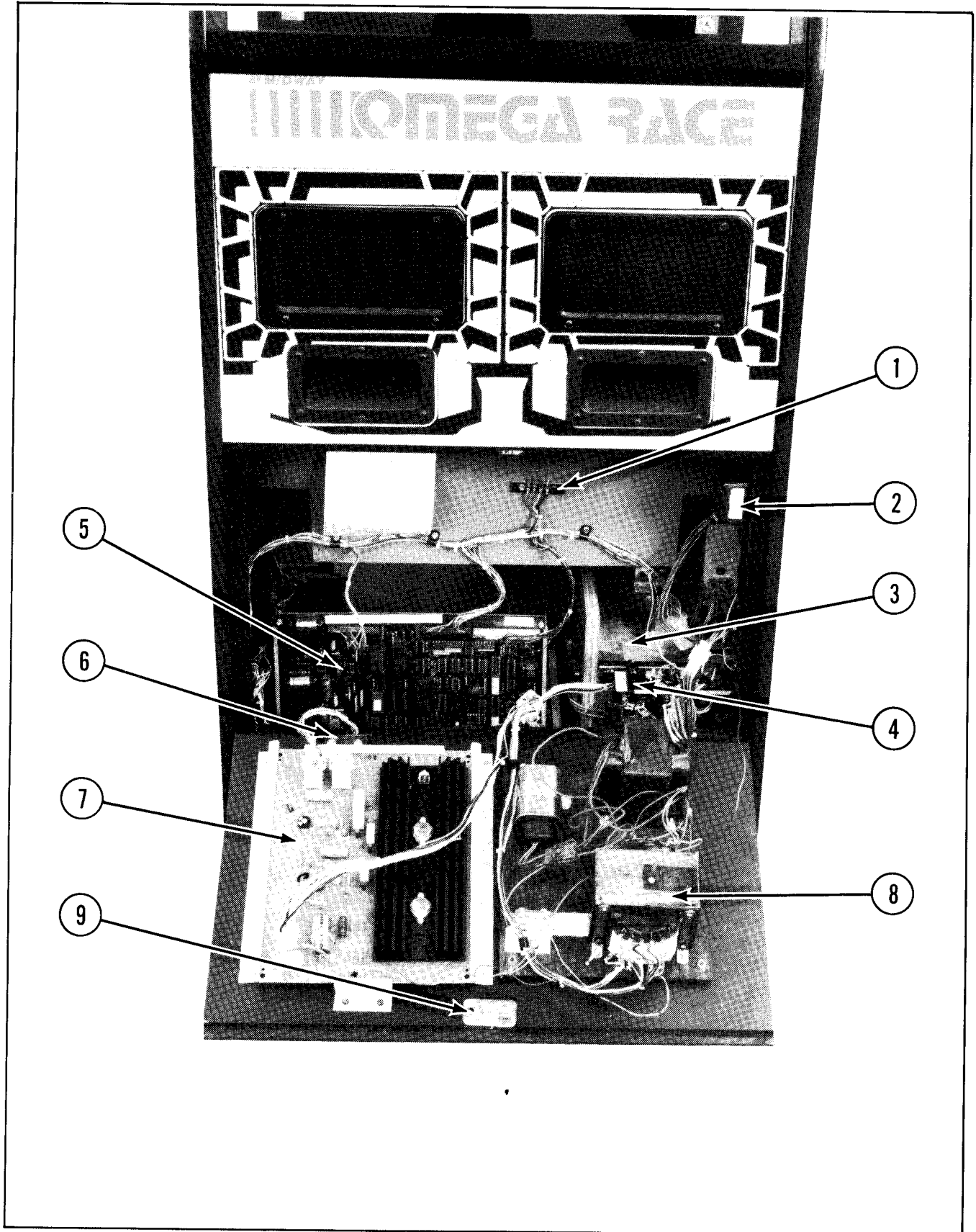

NO. 894 — OMEGA RACE SIT DOWN — FRONT INTERIOR ACCESS PARTS LIST

ORDER BY PART NUMBER ONLY

ITEM	PART NO.	DESCRIPTION
1	A031-00004-0000 0017-00101-0015	TERMINAL STRIP ASSY. #6 x 1/2 SLT. HEX HD. SCR. (2 REQ'D.)
2	A151-00027-0000	INTERLOCK SWITCH ASSY.
3	A894-00025-0000 0017-00009-0477 A894-00024-0000 0894-00121-0000 0017-00101-0628 0017-00104-0022 0017-00103-0061	CASH BOX COVER ASSY MOLDED CASH BOX CASH BOX SIDE CHANNEL ASSY. CASH BOX SIDE CHANNEL — LONG #8-32 x 3/4 CARRIAGE BOLT (4 REQ'D.) #8 FLAT WASHER (4 REQ'D.) #8-32 HEX NUT W/SEMS (4 REQ'D.)
4	A945-00002-0000	FILTER ASSY. — 125VA
5	A084-91372-G929 A084-90007-H929 A894-00032-0000 A597-00012-0100 A597-00012-0200 0017-00101-0096	GAME LOGIC BOARD ASSY. (DAUGHTER BRD.) MOTHER BOARD ASSY. MOTHER & GAME BOARDS MTG. ASSY. P.C. SUPPORT MTG. BRKT. ASSY. P.C. SUPPORT MTG. BRKT. ASSY. #6 x 3/8 SLT. HEX HD. SCR. (6 REQ'D.)
6	0017-00009-0514 0017-00101-0127 0017-00101-0713 0017-00103-0061	2-1/2" HINGE (2 REQ'D.) #8-32 x 1/2 CARRIAGE BOLT (4 REQ'D.) #8-32 x 1" SLT. FLT. HD. M.S. (4 REQ'D.) #8-32 HEX NUT W/SEMS (8 REQ'D.)
7	A082-90413-D000 0624-00902-0100 0624-00902-0300 0624-00902-0500 0017-00101-0028 0017-00104-0062	LINEAR POWER SUPPLY ASSY. P.C. SUPPORT BRKT. — 12" LG. (2 REQ'D.) P.C. SUPPORT BRKT. — 6-1/2" LG. P.C. SUPPORT BRKT. — 2-1/2" LG. #8 x 3/4 SLT. HEX HD. SCR. (11 REQ'D.) #8 FLAT WASHER (11 REQ'D.)
8	A894-00030-0000	TRANSFORMER BOARD ASSY.
9	A097-00001-0000	FRONT DOOR LOCK ASSY.
<p>ADDITIONAL PARTS LIST</p> <p>A894-00037-0000 A894-00043-0000 A894-00042-0000 A894-00040-0000 A894-00035-0000 A894-00041-0000 A894-00033-0000 0894-00915-0000</p>		<p>MASTER CABLE ASSY. LOW VOLTAGE TRANSFORMER CABLE ASSY. LOW VOLTAGE CABLE ASSY. A.C. VOLTAGE ASSY. COIN DOOR CABLE ASSY. THRUST-FIRE CABLE ASSY. SWITCH CABLE ASSY. GAME BOARD SHIELD</p>

NO. 894 — OMEGA RACE SIT DOWN — REAR INTERIOR ACCESS

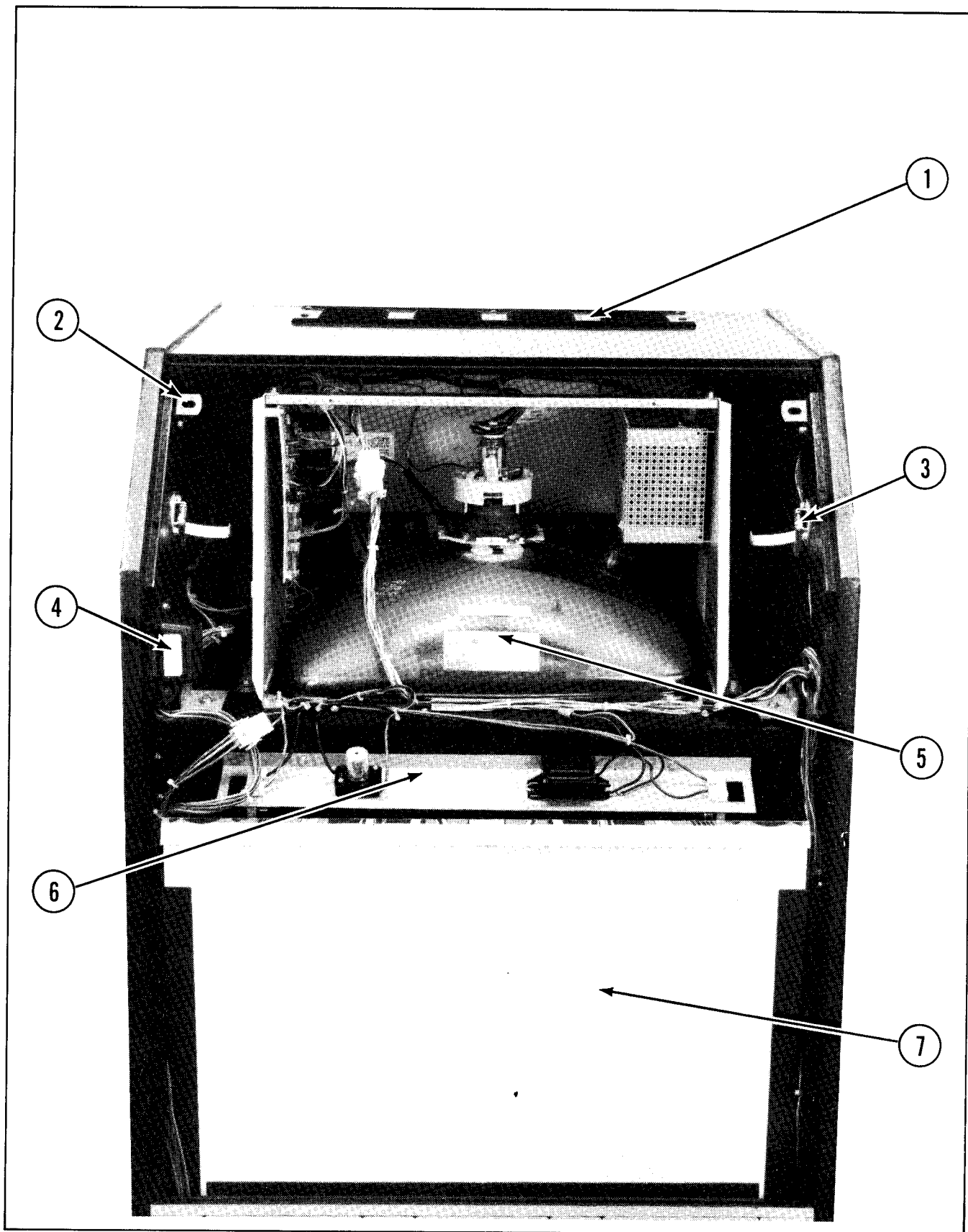

NO. 894 — OMEGA RACE SIT DOWN — REAR INTERIOR ACCESS — PARTS LIST

ORDER BY PART NUMBER ONLY

ITEM	PART NO.	DESCRIPTION
1	0894-00119-00XF 0017-00101-0742	VENT — ANTI SPILL #8 x 1/2 PHIL. TRS. HD. SCR. (8 REQ'D.)
2	A866-00026-0000	LOCATING PIN & PLATE ASSY. (2 REQ'D.)
3	0603-00131-0000 0017-00009-0033 0017-00101-0027	STRIKE (2 REQ'D.) BASSICK CLAMP (2 REQ'D.) #8 x 3/4 SLT. HEX HD. SCR. (TOTAL REQ'D. 16)
4	A151-00027-0000	INTERLOCK SWITCH ASSY.
5	0017-00003-0324	ELECTROHOME — 19" B&W, X-Y MONITOR & CHASSIS (OR)
5	0017-00003-0325 0894-00108-0000 0017-00102-0008 0017-00104-0005	WELLS-GARDNER — 19" B&W, X-Y MONITOR & CHASSIS MONITOR HOLD DOWN BRKT. (2 REQ'D.) 1/4-20 x 7/8 SLT. HEX HD. BOLT (4 REQ'D.) SPLIT LOCK WASHER (4 REQ'D.)
6	A894-00004-0000 0894-00100-00XF	FLUORESCENT LIGHT FIXTURE ASSY. FLUOR. REFLECTOR
7	A894-00045-0000	BACKGROUND SCENERY ASSY.
		REAR SIDE OF CABINET — NOT SHOWN
	0017-00009-0393	BLACK SPEAKER GRILL W/SLOTS (2 REQ'D.)
	0017-00101-0137	#8-32 x 1" CARRIAGE BOLT (8 REQ'D.)
	0017-00104-0062	#8 FLAT WASHER (8 REQ'D.)
	0017-00103-0061	#8-32 HEX NUT W/SEMS (8 REQ'D.)
	A097-00001-0000	BACK DOOR LOCK ASSY.
	0894-00118-0000	VENT/ACCESS PLATE
	0017-00101-0135	#8-32 x 3/4 WELD SCREW (2 REQ'D.)
	0894-00114-0000	LINE CORD/ACCESSORY PLATE
	0017-00101-0135	#8-32 x 3/4 WELD SCREW (2 REQ'D.)
	0017-00003-0178	FUSE 3A., 125V. SLO-BLO
	0017-00003-0155	FUSE HOLDER

NO. 894 — OMEGA RACE SIT DOWN — CONSOLE & FLUORESCENT FIXTURE ASSYS.

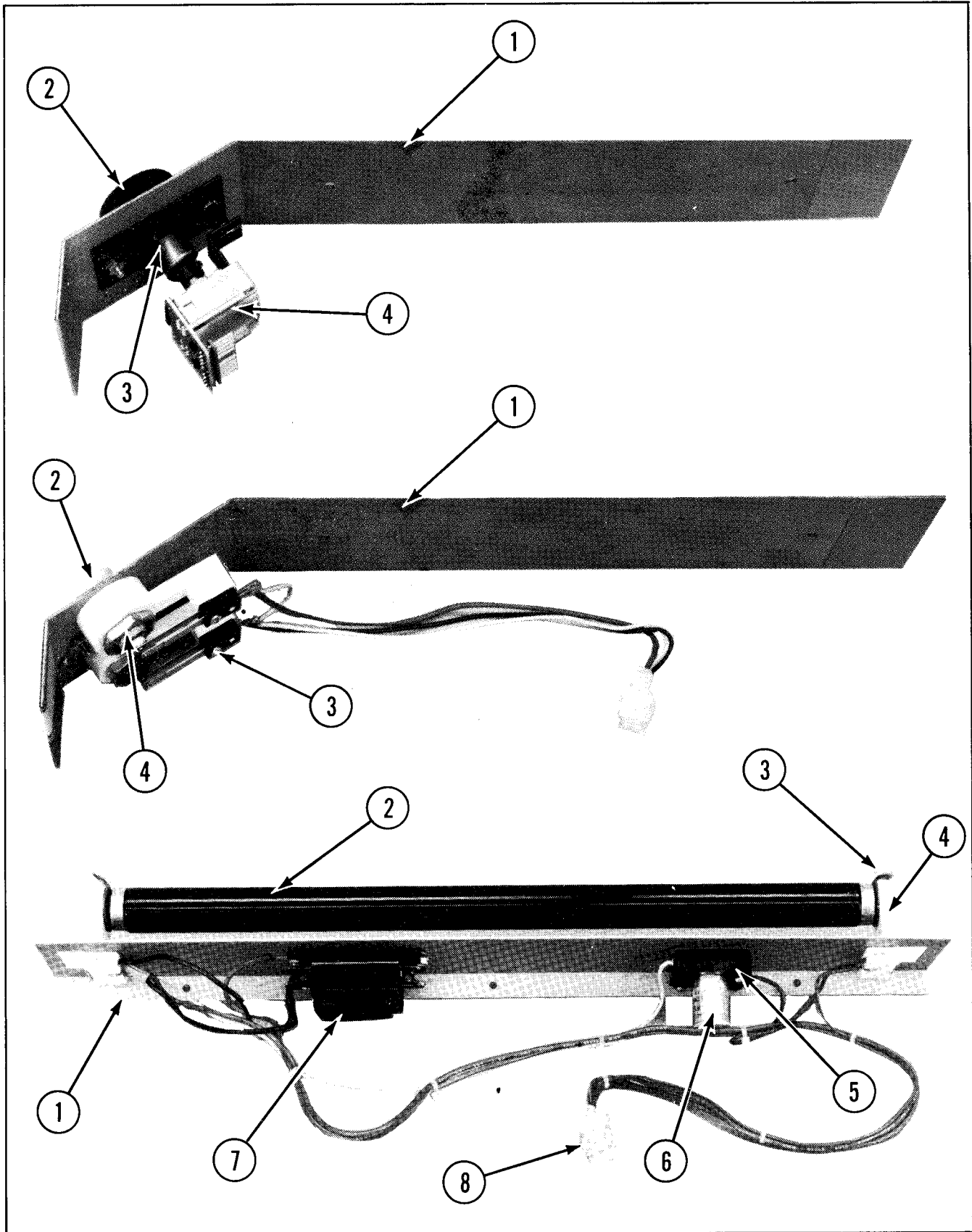

NO. 894 — OMEGA RACE SIT DOWN — CONSOLE & FLUORESCENT ASSYS. — PARTS LIST

ORDER BY PART NUMBER ONLY

ITEM	PART NO.	DESCRIPTION
1	A894-00011-0000 A894-00022-0000 0894-00110-0000 0894-00907-0200 0017-00101-0126	LEFT ARM CONSOLE ASSY. LEFT CONSOLE/OVERLAY ASSY. LEFT CONSOLE PLATE DECORATIVE OVERLAY — LEFT #10-32 x 3/4 BLACK HEX HD. BUTTON SCR. (3 REQ'D.)
2	A894-00008-0000	KNOB & SHAFT ASSY.
3	A894-00010-0000	BEARING & PLATE ASSY.
4	A084-91110-A000	ANGLE ENCODER P.C. BRD. ASSY.
1	A894-00013-0000 A894-00023-0000 0894-00107-0000 0894-00907-0100 0017-00101-0126	RIGHT ARM CONSOLE ASSY. RIGHT ARM/OVERLAY ASSY. RIGHT CONSOLE PLATE DECORATIVE OVERLAY — RIGHT #10-32 x 3/4 BLACK HEX HD. BUTTON SCR. (3 REQ'D.)
2	0017-00042-0256	RED PUSH BUTTON ASSY.
3	0017-00042-0257	YELLOW PUSH BUTTON ASSY.
3	0017-00032-0093	PUSH BUTTON SWITCH W/HOLDER (2 REQ'D.)
4	0017-00103-0054	5/8 PAL NUT (2 REQ'D.)
1	A894-00004-0000	FLUORESCENT LIGHT FIXTURE ASSY.
2	0894-00101-0000	FLUORESCENT BRKT.
2	0017-00003-0095	18" BLACK LIGHT LAMP — F15T8
3	0017-00021-0005	FLUORESCENT LOCKS (2 REQ'D.)
4	0017-00031-0036	FLUORESCENT SOCKETS (2 REQ'D.)
5	0017-00021-0079	FLUOR. STARTER HOLDER
5	0017-00101-0573	#6-32 x 1/2 PHIL. R.H.M.S. (2 REQ'D.)
6	0017-00003-0019	STARTER
7	0017-00003-0026	BALLAST
7	0017-00101-0593	#8-32 x 5/16 SLT. HEX HD. M.S. (2 REQ'D.)
8	A894-00034-0000	FLUORESCENT CABLE ASSY.

NO. 931 — OMEGA RACE MINI

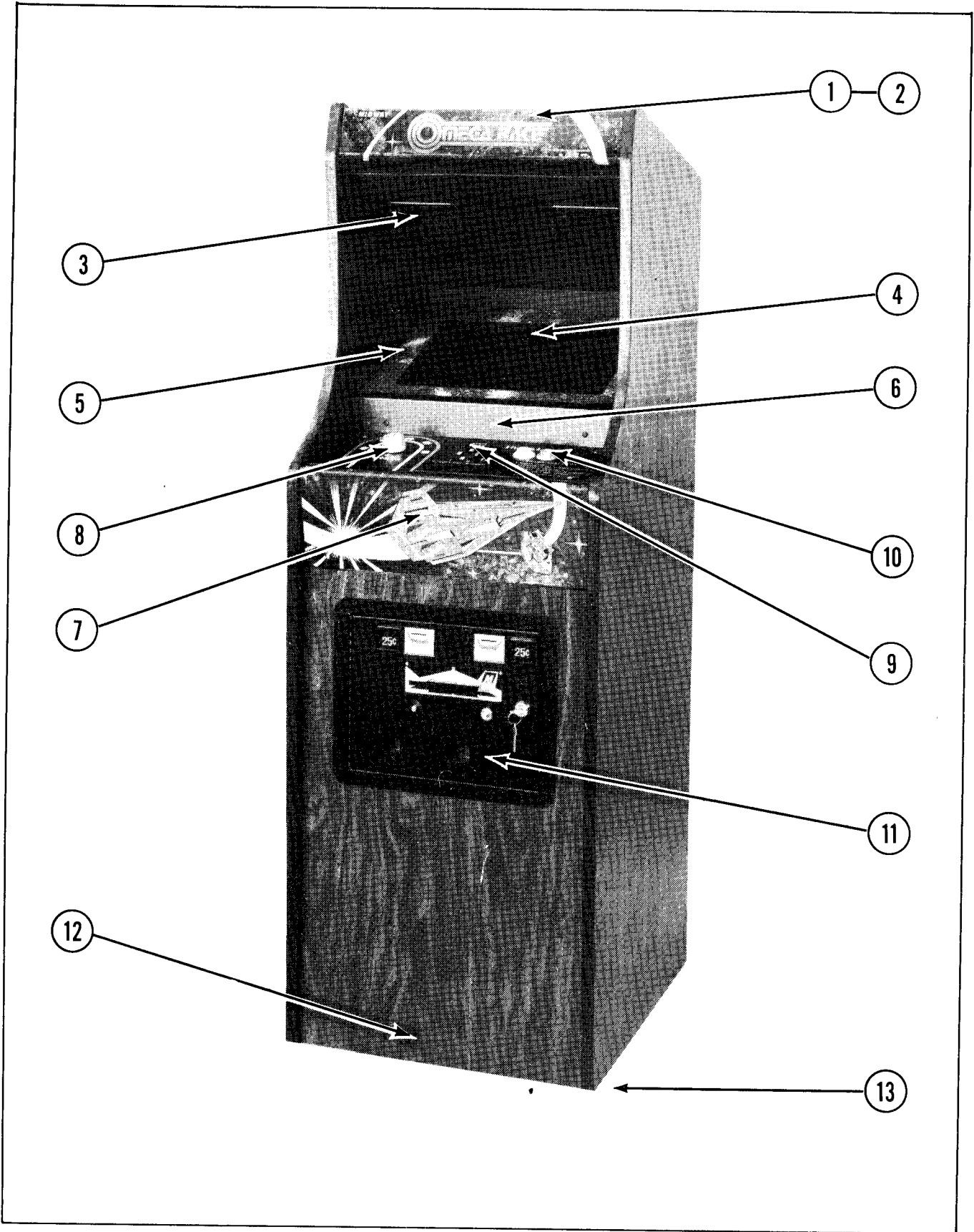

NO. 931 — OMEGA RACE MINI — PARTS LIST

ORDER BY PART NUMBER ONLY

ITEM	PART NO.	DESCRIPTION
1	0931-00901-0000	DISPLAY PANEL
	0017-00101-0117	#8 x 5/8 PHIL. TRS. HD. SCREW (8 REQ'D.)
2	A931-00017-0000	INSERT DISPLAY ASSY.
	0017-00031-0030	WEDGE BASE LIGHT SOCKET (5 REQ'D.)
	0017-00003-0219	#194 LAMP 14V, 27A. (5 REQ'D.)
3	0017-00003-0161	4" SQR. SPEAKER 8 OHM, 3W. (2 REQ'D.)
	0017-00009-0482	SPEAKER GRILL (2 REQ'D.)
	0017-00101-0136	#8-32 x 1/4 CARRIAGE BOLT (8 REQ'D.)
	0017-00103-0061	#8-32 HEX NUT W/SEMS (8 REQ'D.)
4	0931-00902-00XF	MAIN DISPLAY GLASS — 17-13/16" x 14-13/16" x 1/8"
5	0905-00903-0100	GLASS EDGE CHANNEL — 14-1/2" LG. (2 REQ'D.)
6	0963-00101-00XF	GLASS CLAMPING PLATE
	0017-00101-0789	#10-32 x 3/4 HEX BUTTON HD. SCR. (2 REQ'D.)
7	A931-00014-0000	CONTROL PANEL & OVERLAY ASSY.
	0931-00102-0000	CONTROL PANEL
	0931-00905-0000	DECORATIVE OVERLAY
	0017-00101-0118	#8-32 x 1-1/8 CARRIAGE BOLT (4 REQ'D.)
	0017-00104-0022	#8 FLAT WASHER (4 REQ'D.)
	0017-00103-0061	#8-32 HEX NUT W/SEMS (4 REQ'D.)
	0017-00101-0065	#6 x 1/2 PHIL. TRS. HD. SCR. (2 REQ'D.)
8	A929-00021-0000	KNOB & SHAFT ASSY.
9	0017-00032-0092	LIGHTED RED P.B. SWITCH (4 REQ'D.)
	0929-00905-00XF	SWITCH BEZEL (4 REQ'D.)
10	0017-00042-0256	RED — PUSH BUTTON ASSY.
	0017-00042-0257	YELLOW — PUSH BUTTON ASSY.
	0017-00032-0093	P.B. SWITCH W/HOLDER (2 REQ'D.)
11	A090-00300-06BK	DOUBLE ENTRY COIN DOOR ASSY.
	0090-00002-02BK	LARGE DOOR FRAME
	0017-00101-0121	#6-32 x 5/16 PHIL. TRS. HD. SCR. (3 REQ'D.) (MOUNTS COIN DOOR TO FRAME)
12	0935-00906-0400	KICK PLATE — 17-15/16" LG. — NOT SHOWN
13	0017-00102-0048	3/8-16 x 2" LEG LEVELERS (4 REQ'D.)
	0017-00103-0026	3/8-16 LEG LEVELER HEX NUTS (4 REQ'D.)
		NOT SHOWN LIST
	0017-00009-0033	BASSICK CLAMP (2 REQ'D.)
	0961-00115-00XF	STRIKE (2 REQ'D.)
	0017-00101-0027	#8 x 3/4 SLT. HEX HD. SCR. (8 REQ'D.)
	0961-00113-0000	SHELF SUPPORT — LEFT
	0961-00114-0000	SHELF SUPPORT — RIGHT
	0017-00101-0028	#8 x 3/4 BLACK SLT. HEX HD. SCR. (16 REQ'D.)

NO. 931 — OMEGA RACE MINI — REAR ACCESS

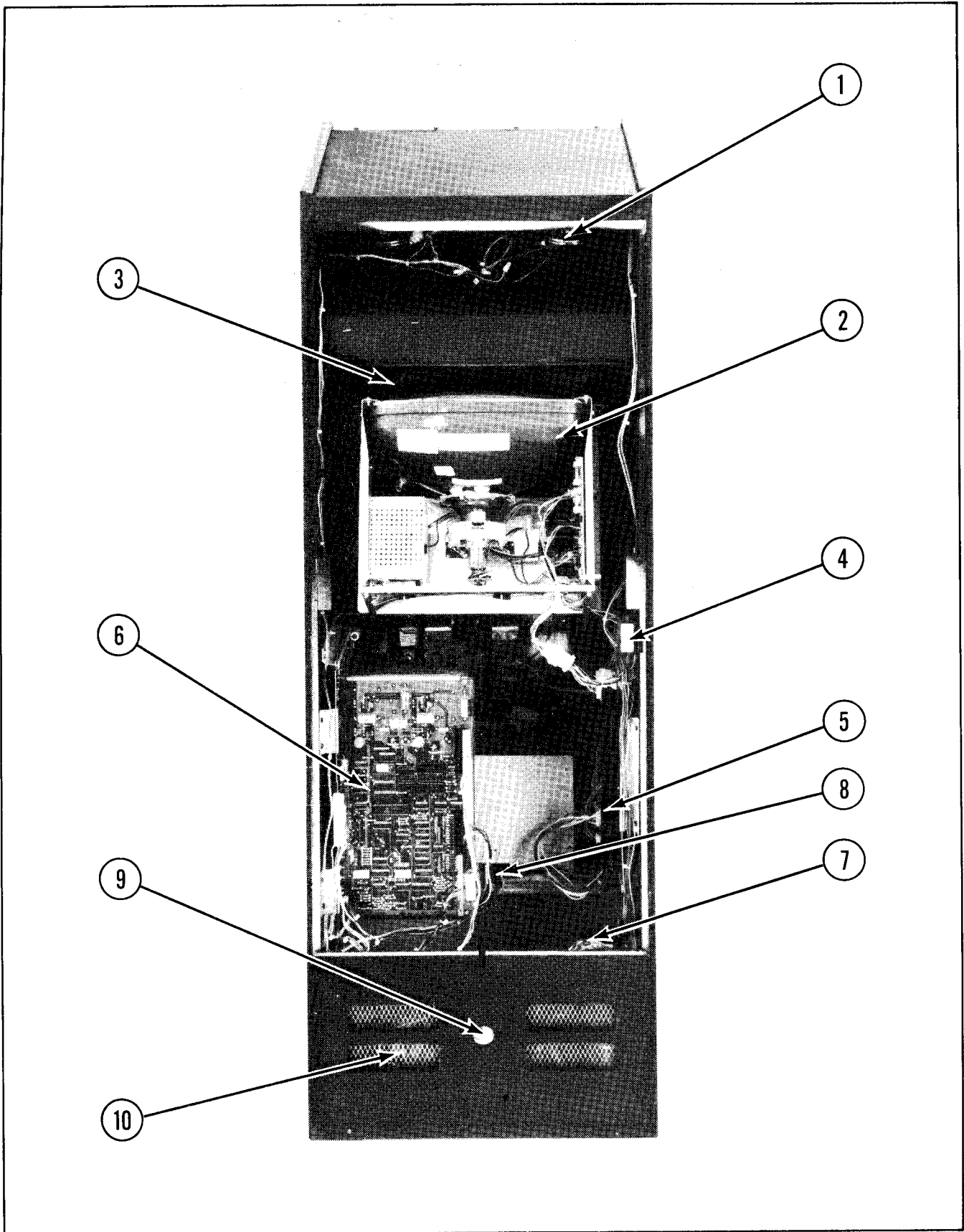

NO. 931 — OMEGA RACE MINI — REAR ACCESS — PARTS LIST

ORDER BY PART NUMBER ONLY

ITEM	PART NO.	DESCRIPTION
1	0017-00003-0161	4" SQR. SPEAKER 8 OHM, 3W. (2 REQ'D.)
2	0017-00003-0358	ELECTROHOME — 15" B&W, X-Y HORIZ. MTG. MONITOR (OR)
2	0017-00003-0384	WELLS-GARDNER — 15" B&W, X-Y HORIZ. MTG. MONITOR
	0592-00104-0100	CHASSIS MTG. BRKT. — R.H.
	0017-00101-0628	#8-32 x 3/4 CARRIAGE BOLT (4 REQ'D.)
	0017-00104-0014	DISH WASHER — .870 DIA. (4 REQ'D.)
	0017-00103-0061	#8-32 HEX NUT W/SEMS (4 REQ'D.)
3	A931-00011-0000	T.V. BEZEL ASSY.
	0931-00903-0000	T.V. BEZEL
	0931-00904-0000	BLUE ACETATE OVERLAY — 14" x 11-3/4"
	0934-00905-0000	PLEXI-GLASS
4	A151-00027-0000	INTERLOCK SWITCH ASSY.
5	A082-90413-D000	LINEAR POWER SUPPLY
	0624-00902-0100	P.C. SUPPORT BRKT. — 12" LG. (5 REQ'D.)
	0624-00902-0300	P.C. SUPPORT BRKT. — 2-1/2" LG. (4 REQ'D.)
	0017-00101-0025	#8 x 1/2 SLT. HEX HD. SCR. (23 REQ'D.)
	0017-00104-0037	#8 FLAT WASHER (23 REQ'D.)
6	A084-91372-G929	GAME LOGIC BRD. ASSY. (DAUGHTER BRD.)
	A084-90007-H929	MOTHER BRD. ASSY.
	A597-00012-0100	P.C. SUPPORT BRKT. ASSY.
	A597-00012-0200	P.C. SUPPORT BRKT. ASSY.
	0017-00101-0096	#6 x 3/8 SLT. HEX HD. SCR. (6 REQ'D.)
7	A945-00002-0000	125 VA — FILTER ASSY.
	A931-00015-0000	TRANSFORMER BRD. ASSY. — LOCATED NEXT TO FILTER ASSY.
8	A031-00004-0000	TERMINAL STRIP ASSY.
	0017-00101-0014	#6 x 1/2 SLT. HEX HD. SCR. (2 REQ'D.)
9	0017-00032-0083	ON/OFF SWITCH 120V, 6A.
	0567-00106-0100	ON/OFF SW. PLATE
10	0017-00009-0490	5-5/8" SQR. VENT GRILL (2 REQ'D.)
	A905-00028-0000	ADDITIONAL PARTS LIST CASH BOX ASSY. W/HANDLE
	A961-00008-0000	CASH BOX COVER ASSY.
	A894-00024-0000	CASH BOX SIDE CHANNEL ASSY.
	0894-00121-0000	CASH BOX SIDE CHANNEL — LONG
	0017-00101-0628	#8-32 x 3/4 CARRIAGE BOLT (4 REQ'D.)
	0017-00104-0022	#8 FLAT WASHER (4 REQ'D.)
	0017-00103-0061	#8-32 HEX NUT W/SEMS (4 REQ'D.)
	A931-00013-0000	MASTER CABLE ASSY.
	A931-00007-0000	HIGH VOLTAGE CABLE ASSY.
	A931-00008-0000	LOW VOLTAGE CABLE ASSY.
	A931-00009-0000	CONTROL SHELF CABLE ASSY.
	A931-00016-0000	INSERT LIGHT CABLE ASSY.
	A894-00035-0000	COIN DOOR CABLE ASSY.
	A866-00049-0000	LINE CORD ASSY.
	A151-00029-0000	BACK DOOR LOCK ASSY.
	0017-00009-0490	5-5/8" SQR. VENT GRILL — BACK DOOR
	A904-00031-0000	MOTHER & DAUGHTER BRDS. BRKT. ASSY.

NO. 930 — OMEGA RACE COCKTAIL

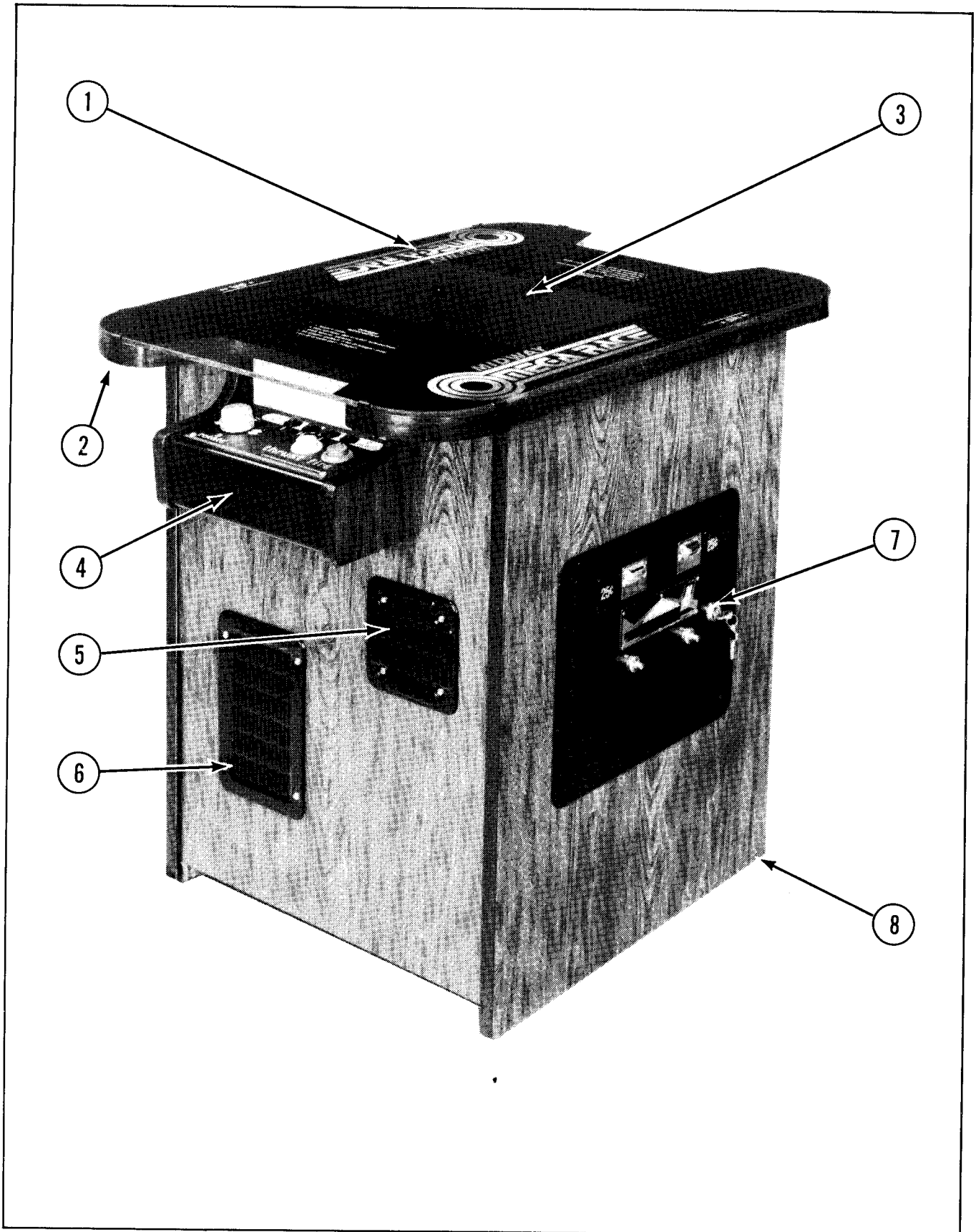

NO. 930 — OMEGA RACE COCKTAIL — PARTS LIST

ORDER BY PART NUMBER ONLY

ITEM	PART NO.	DESCRIPTION
1	0930-00901-00XF	COVER GLASS — 32" x 22" x 1/4"
2	0775-00104-00XF	GLASS CLIPS (8 REQ'D.)
	0017-00101-0117	#8 x 5/8 PHIL. TRS. HD. SCR. (16 REQ'D.)
3	A930-00009-0000	T.V. BEZEL ASSY.
	0930-00900-0000	T.V. BEZEL
	0931-00904-0000	BLUE ACETATE OVERLAY — 14" x 11-3/4"
	0934-00905-0000	PLEXI-GLASS
4	A930-00006-0100	CONTROL SHELF ASSY. — PLAYER #1
	A930-00006-0200	CONTROL SHELF ASSY. — PLAYER #2 — NOT SEEN
5	0017-00009-0482	SMALL SPEAKER GRILL
	0017-00003-0161	4" SQR. SPEAKER 8 OHM, 7W.
	0017-00101-0118	#8-32 x 1-1/8 CARRIAGE BOLT (4 REQ'D.)
	0017-00103-0061	#8-32 HEX NUT W/SEMS (4 REQ'D.)
6	0017-00009-0393	SPEAKER GRILL (3 REQ'D.)
	0017-00003-0187	6" x 9" SPEAKER 8 OHM, 9W.
	0017-00101-0136	#8-32 x 1-1/4 CARRIAGE BOLT (12 REQ'D.)
	0017-00103-0061	#8-32 HEX NUT W/SEMS (12 REQ'D.)
7	A090-00300-06BK	DOUBLE ENTRY COIN DOOR ASSY.
	0090-00002-02BK	LARGE COIN DOOR FRAME
	0017-00101-0121	#6-32 x 5/16 PHIL. TRS. HD. SCR. (3 REQ'D.) (MOUNTS COIN DOOR TO FRAME)
8	0017-00102-0048	3/8-16 x 2" LEG LEVELERS (4 REQ'D.)
	0017-00103-0026	3/8-16 LEG LEVELER NUTS (4 REQ'D.)
		NOT SHOWN LIST
	0017-00032-0083	ON/OFF SWITCH 120V., 6A.
	0567-00106-0100	ON/OFF SWITCH MTG. PLATE
	A151-00078-0000	INTERLOCK SWITCH ASSY.
	A930-00007-0000	CASH BOX ASSY.
	A930-00010-0000	CASH BOX COVER ASSY.
	A962-00005-0000	CASH BOX SIDE CHANNEL ASSY. — SHORT
	0962-00101-0000	CASH BOX SIDE CHANNEL — SHORT
	0017-00101-0628	#8-32 x 3/4 CARRIAGE BOLT (4 REQ'D.)
	0017-00104-0022	#8 FLAT WASHER (4 REQ'D.)
	0017-00103-0061	#8-32 HEX NUT W/SEMS (4 REQ'D.)

NO. 930 — OMEGA RACE COCKTAIL — INTERIOR ACCESS

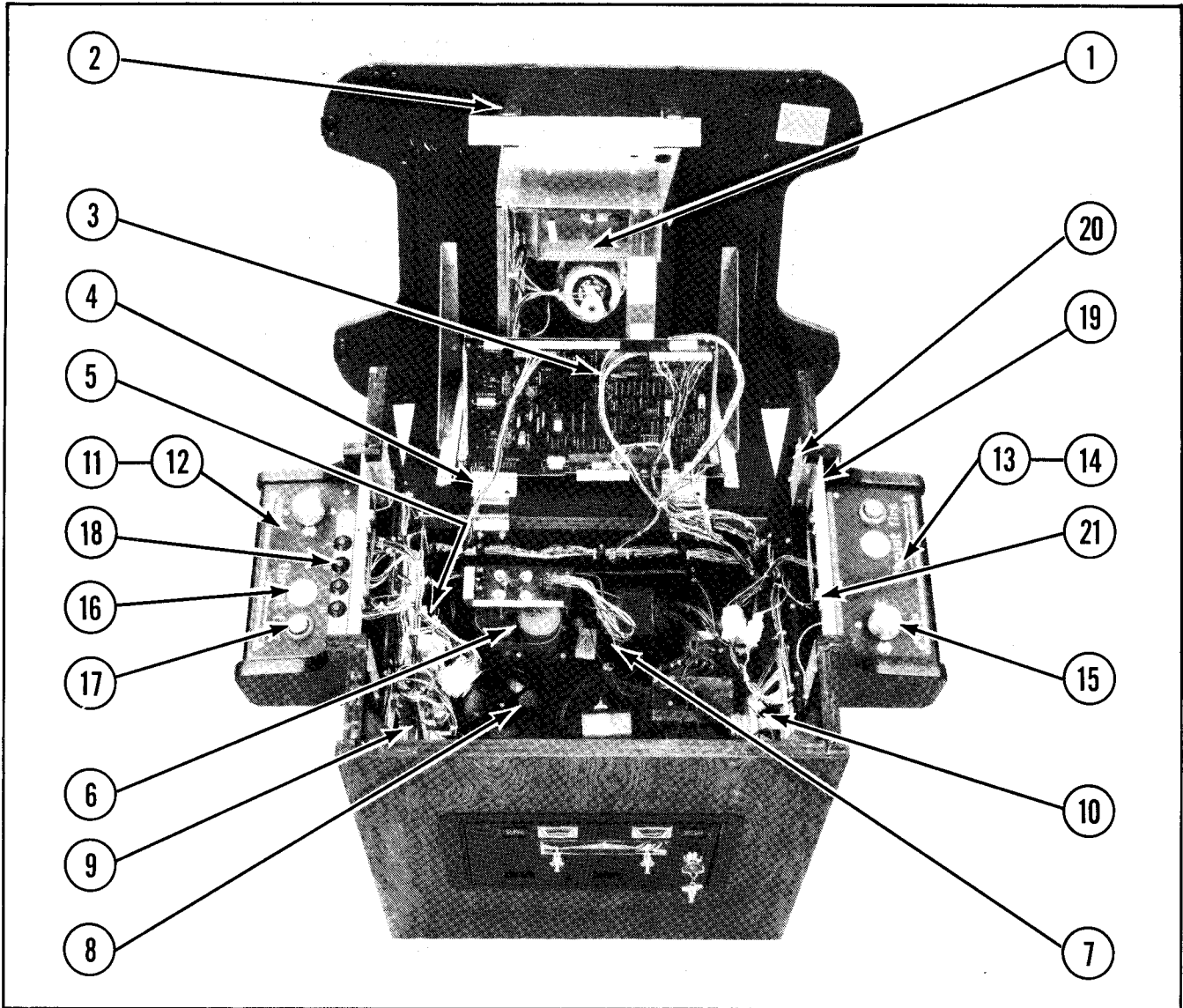

NO. 930 — OMEGA RACE COCKTAIL — INTERIOR ACCESS — PARTS LIST

ORDER BY PART NUMBER ONLY

ITEM	PART NO.	DESCRIPTION
1	0017-00003-0358	ELECTROHOME 15" B&W, X-Y HORIZ. MTG. MONITOR & CHASSIS (OR)
1	0017-00003-0384	WELLS-GARDNER 15" B&W, X-Y HORIZ. MTG. MONITOR & CHASSIS
	0930-00101-0000	C.R.T. MTG. BRKT., (2 REQ'D.)
	0017-00101-0082	#10 x 3/4 HEX HD. SCR. (UNSLOTTED) (8 REQ'D.)
	0017-00101-0799	#10-32 x 3/8 SLT. HEX HD. SCR. (4 REQ'D.)
	0017-00103-0081	#10-32 HEX NUT W/SEMS (4 REQ'D.)
2	0610-00132-0000	STRIKE (2 REQ'D.)
	0017-00009-0033	BASSICK CLAMP (2 REQ'D.) — NOT SEEN
	0017-00101-0027	#8 x 3/4 SLT. HEX HD. SCR. (8 REQ'D.)

NO. 930 — OMEGA RACE COCKTAIL — INTERIOR ACCESS — PARTS LIST (cont'd)

ITEM	PART NO.	DESCRIPTION
3	A084-91372-G929 A084-90007-H929 0624-00902-0100 0624-00902-0300 0017-00101-0027 0017-00104-0037	GAME LOGIC BRD. ASSY. (DAUGHTER BRD.) MOTHER BOARD ASSY. P.C. SUPPORT BRKT. — 12" (2 REQ'D.) P.C. SUPPORT BRKT. — 2-1/2" (2 REQ'D.) #8 x 3/4 SLT. HEX HD. SCR. (10 REQ'D.) #8 WASHER (6 REQ'D.)
4	0017-00009-0514 0017-00101-0639 0017-00103-0061	2-1/2" HINGE (2 REQ'D.) #8-32 x 1-1/4 CARRIAGE BOLT (8 REQ'D.) #8-32 HEX NUT W/SEMS (8 REQ'D.)
5	A082-90413-D000 0624-00902-0100 0624-00902-0300 0624-00902-0500 0017-00101-0027 0017-00104-0037	LINEAR POWER SUPPLY ASSY. P.C. SUPPORT BRKT. — 12" (2 REQ'D.) P.C. SUPPORT BRKT. — 2-1/2" P.C. SUPPORT BRKT. — 6-1/2" #8 x 3/4 SLT. HEX HD. SCR. (10 REQ'D.) #8 WASHER (10 REQ'D.)
6	A945-00002-0000	125VA FILTER ASSY.
7	A730-00011-0000	TRANSFORMER BRD. ASSY.
8	0017-00003-0310 0017-00009-0485 0869-00909-0000 0870-00700-00XF 0017-00101-0583 0017-00103-0052 0017-00104-0019	EXHAUST FAN 115V., 60HZ FAN FINGER GUARD FAN SHROUD FAN SPACER (4 REQ'D.) #6-32 x 1-1/4 CARRIAGE BOLT (4 REQ'D.) #6-32 LOCKNUT (4 REQ'D.) #6 FLAT WASHER (4 REQ'D.)
9	0017-00003-0161	4" SQR. SPEAKER 8 OHM, 7W.
10	0017-00003-0187	6" x 9" SPEAKER 8 OHM, 9W.
11	0930-00100-01XF	CONTROL PANEL — PLAYER #1
12	0980-00903-0100	DECORATIVE OVERLAY — PLAYER #1
13	0930-00100-00XF	CONTROL PANEL — PLAYER #2
14	0930-00903-0200 0017-00101-0341 0930-00103-00XF	DECORATIVE OVERLAY — PLAYER #2 #6 x 1/4 PHIL. TRS. HD. SCR. (TOTAL REQ'D. 14) BOTTOM SHELF PANEL (2 REQ'D.)
15	A929-00021-0000	KNOB & SHAFT ASSY. (2 REQ'D.)
16	0017-00042-0257	YELLOW — PUSH BUTTON (2 REQ'D.)
17	0017-00042-0256 0017-00032-0093	RED — PUSH BUTTON (2 REQ'D.) P.B. SWITCH W/HOLDER (4 REQ'D.)
18	0017-00032-0092 0929-00905-00XF	LIGHTED RED PUSH BUTTON SWITCH (4 REQ'D.) SWITCH BEZEL (4 REQ'D.)
19	0930-00904-0000	LIGHT SHIELD (2 REQ'D.)
20	0921-00105-00XF 0017-00101-0025	PANEL SUPPORT BRKT. (4 REQ'D.) #8 x 1/2 SLT. HEX HD. SCR. (20 REQ'D.)
21	0017-00003-0219 0017-00031-0044 0017-00101-0555	#194 WEDGE LAMP 14V., .27A. (4 REQ'D.) WEDGE BASE LAMP SOCKET (4 REQ'D.) #6-32 x 5/16 SLT. HEX HD. SCR. (4 REQ'D.)
	A031-00004-0000 A930-00012-0000 A930-00013-0000 A930-00014-0000 A894-00035-0000 A930-00008-0100 A930-00008-0200	ADDITIONAL PARTS LIST TERMINAL STRIP ASSY. MASTER CABLE ASSY. HIGH VOLTAGE CABLE ASSY. — A.C. LOW VOLTAGE CABLE ASSY. — MONITOR COIN DOOR CABLE ASSY. CONTROL SHELF CABLE ASSY. — PLAYER #1 CONTROL SHELF CABLE ASSY. — PLAYER #2

OMEGA RACE — TRANSFORMER BOARD ASSY.

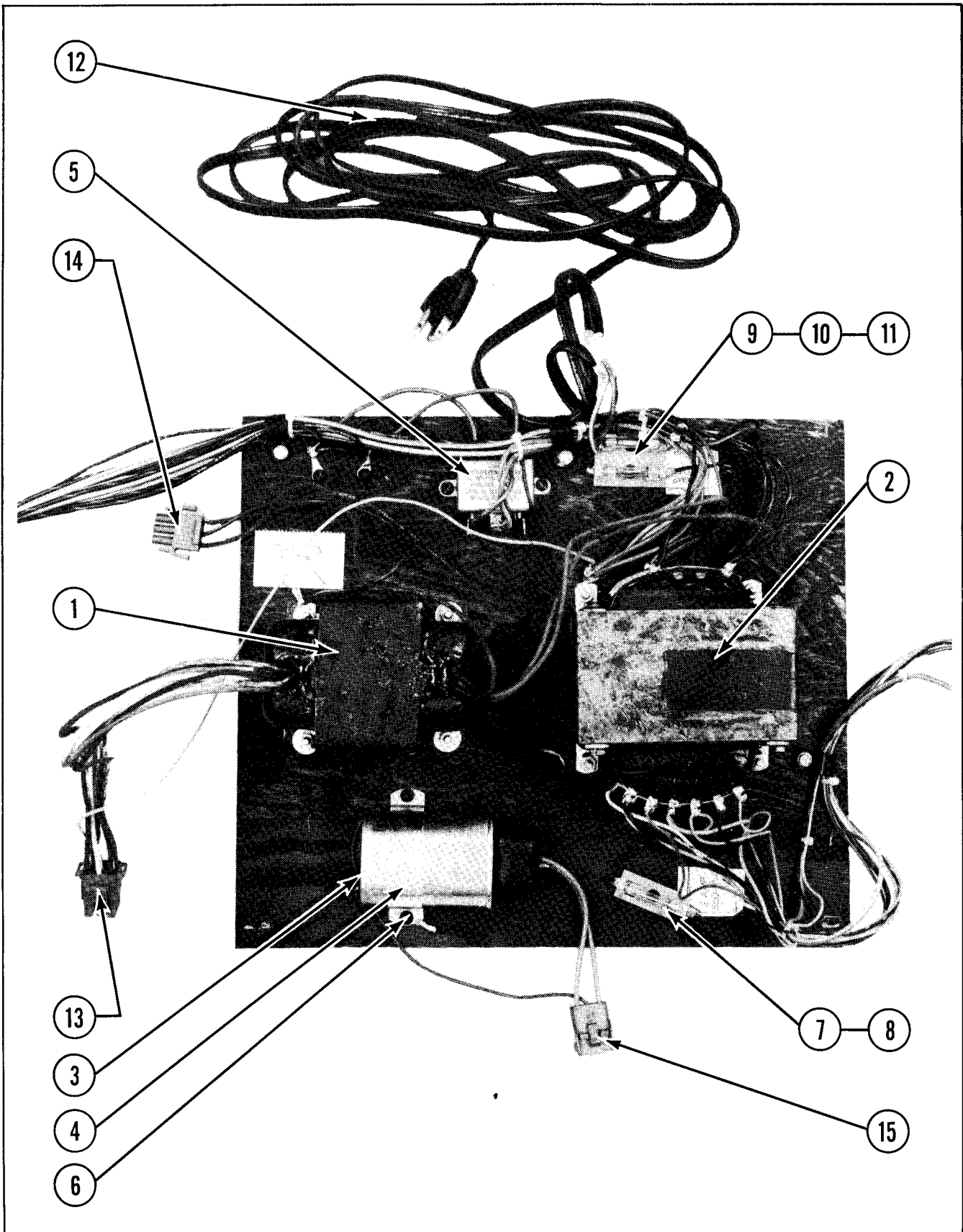

OMEGA RACE — TRANSFORMER BOARD ASSY. — PARTS LIST

ORDER BY PART NUMBER ONLY

ITEM	PART NO.	DESCRIPTION
1	A945-00013-0000	TRANSFORMER ASSY. W/PINS — MT89-A000
2	MT00-00088-A000	TRANSFORMER W/SHIELD
	0017-00101-0639	#8-32 x 1-1/4 CARRIAGE BOLT (4 REQ'D.)
	0017-00103-0061	#8-32 HEX NUT W/SEMS (4 REQ'D.)
	0017-00104-0026	1/2" #8 FLAT WASHER (8 REQ'D.)
	0017-00101-0052	#6 x 1-1/4 SLT. HEX HD. SCR. (4 REQ'D.)
3	A945-00005-0000	60 HZ CAPACITOR ASSY.
4	0017-00003-0379	CAPACITOR CLAMP
5	0017-00003-0064	NOISE FILTER
6	0017-00101-0014	#6 x 1/2 SLT. HEX HD. SCR. (17 REQ'D.)
7	0720-00001-0100	1 POSITION FUSE CLIP ASSY. (U.R., C.T., & MINI MODELS)
8	0017-00003-0004	FUSE — 2A, 250V, SLO-BLO
9	0720-00001-0200	2 POSITION FUSE CLIP ASSY. (U.R., C.T., & S.D. MODELS)
10	0017-00008-0260	FUSE — 1/2A, 250V, SLO-BLO (C.T. & U.R. MODELS)
11	0017-00003-0262	FUSE — 3A, 250V, SLO-BLO (U.R., C.T., & MINI MODELS)
	0017-00003-0103	FUSE — 1A, 250V, SLO-BLO (S.D. MODEL ONLY)
12	A866-00049-0000	LINE CORD ASSY.
13	0017-00021-0478	9 PIN CONNECTOR PLUG
14	0017-00021-0479	3 PIN CONNECTOR PLUG
15	0017-00021-0480	3 PIN CONNECTOR CAP

OMEGA RACE — FILTER ASSY.

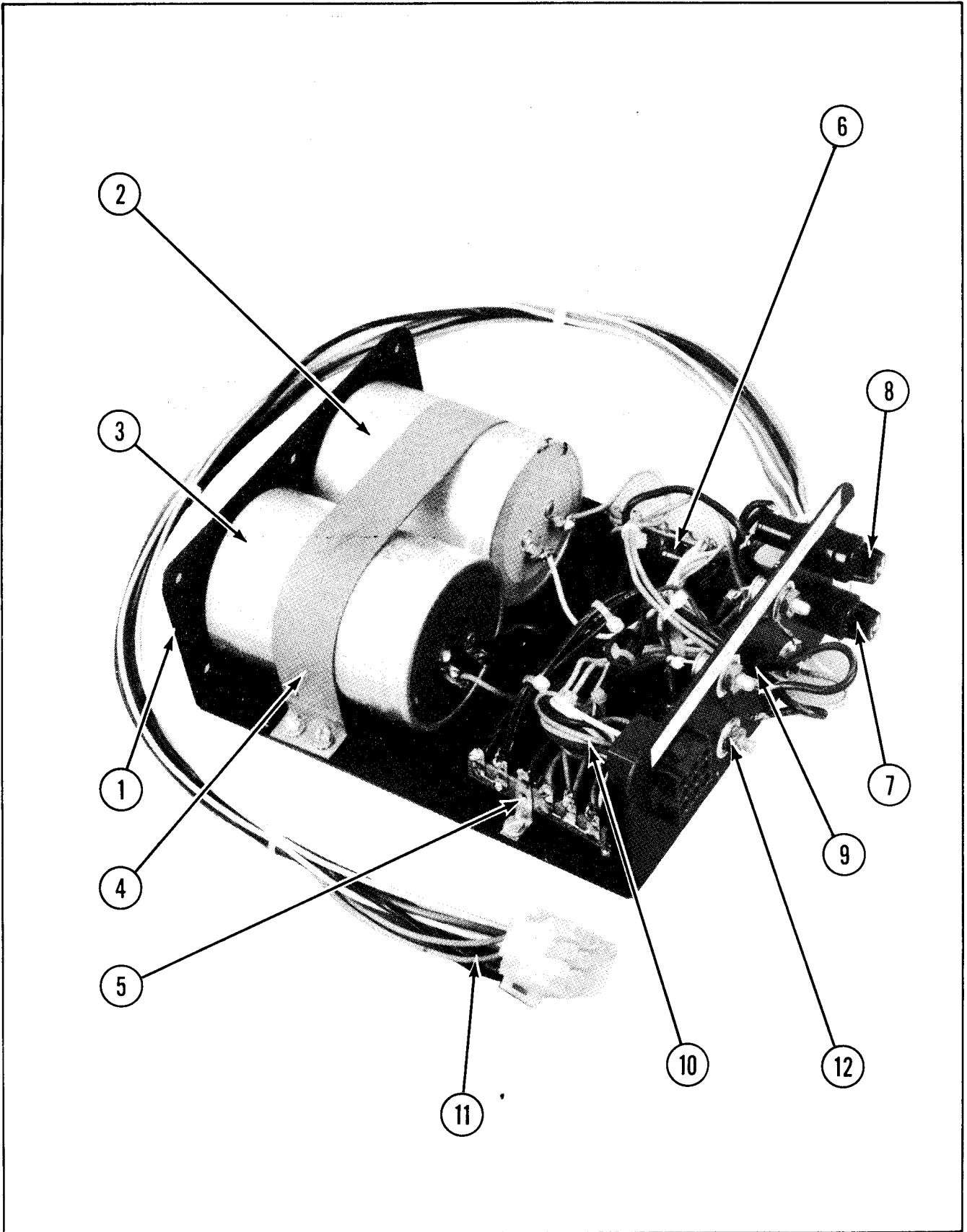

OMEGA RACE — FILTER ASSY. — PARTS LIST

ORDER BY PART NUMBER ONLY

ITEM	PART NO.	DESCRIPTION
1	0945-00101-00XF	CHASSIS
2	0945-00803-0100	CAPACITOR — 55000MF — 25V.
3	0945-00803-0200	CAPACITOR — 100000MF — 15V.
4	0945-00100-0000	CAPACITOR STRAP
	0017-00101-0555	#6-32 x 5/16 SLT. HEX HD. SCR. (4 REQ'D.)
5	0017-00021-0525	5 POSITION TERMINAL STRIP (2 REQ'D)
	0017-00101-0510	#4-40 x 1/2 SLT. PAN HD. SCR. (4 REQ'D.)
	0017-00104-0087	#4 FLAT WASHER (4 REQ'D.)
	0017-00104-0071	#4 EXT. TOOTH WASHER (4 REQ'D.)
	0017-00103-0002	#4-40 HEX NUT (4 REQ'D.)
6	0062-122H7-1XXX	RESISTOR — 150 OHM, 2W.
	0062-086H7-1XXX	RESISTOR — 47 OHM, 2W. — LOCATED ON OPPOSITE TERMINAL STRIP
7	0017-00003-0008	FUSE — 6AMP — 120V.
8	0017-00003-0174	FUSE — 10 AMP — 32V.
	0945-00805-0000	FUSE HOLDER (2 REQ'D.)
9	0017-00041-0008	RUBBER GROMMET
10	A089-00007-0000	FILTER CABLE ASSY. #2
11	A089-00006-0000	FILTER CABLE ASSY. #1
12	0945-00804-0100	DIODE — 12A. — 50V. (4 REQ'D.)
	0017-00103-0086	#10-32 HEX NUT (4 REQ'D.)
	0017-00021-0484	SOLDER LUG (4 REQ'D.)
	0017-00104-0107	#10 FLAT WASHER (4 REQ'D.)
	0017-00009-0510	INSULATOR (8 REQ'D.)
	0017-00042-0254	BUSHING (4 REQ'D.)
	0945-00900-0000	DIODE FORMED FISHPAPER COVER — NOT SHOWN

OMEGA RACE — ALL VERSIONS — FRONT DOOR ASSY.

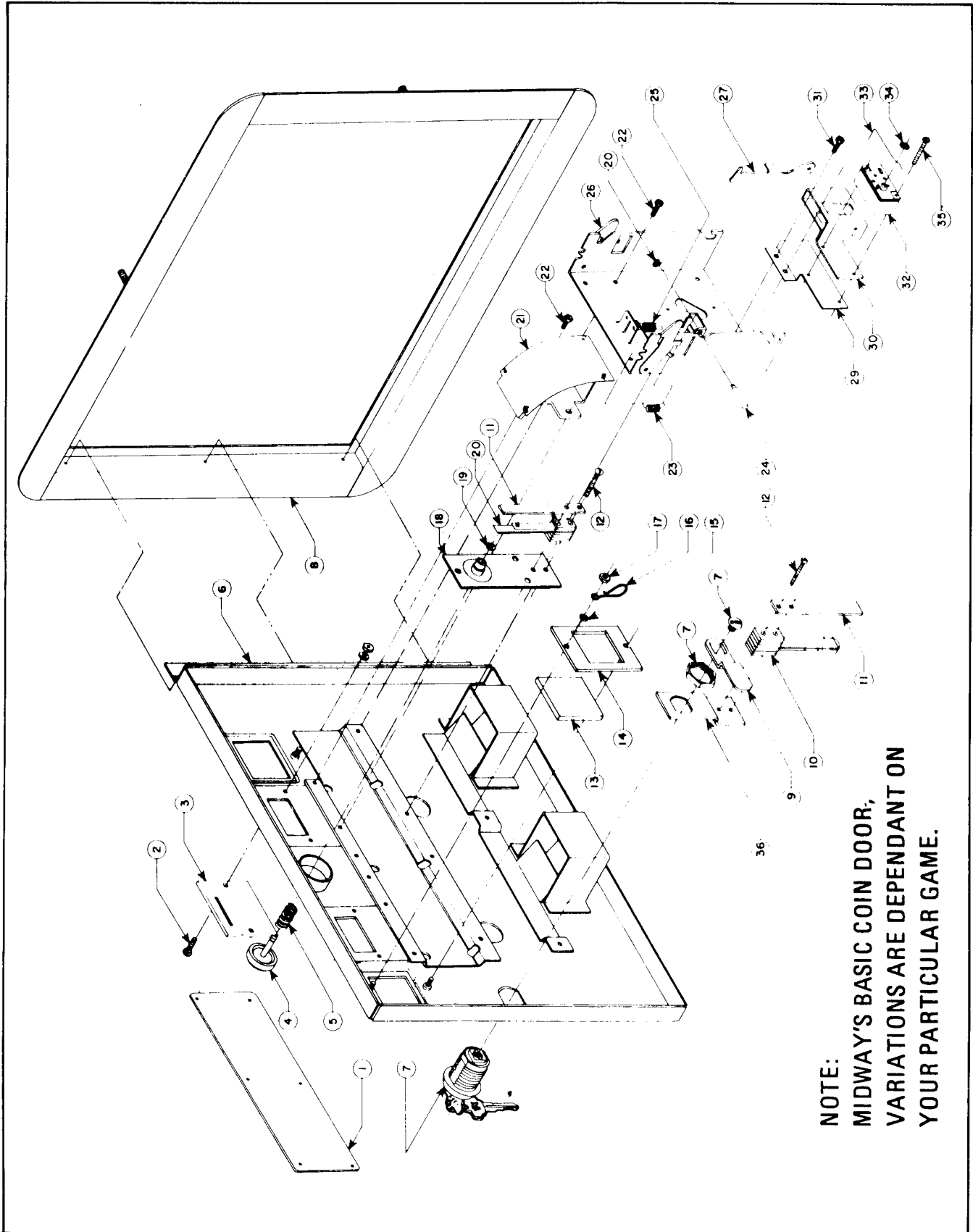

NOTE:
MIDWAY'S BASIC COIN DOOR,
VARIATIONS ARE DEPENDANT ON
YOUR PARTICULAR GAME.

OMEGA RACE — ALL VERSIONS — FRONT DOOR ASSY. — PARTS LIST

ORDER BY PART NUMBER ONLY

ITEM	PART NO.	DESCRIPTION
1	0090-00902-0000	DRESS PLATE
	0090-00902-0100	DRESS PLATE W/O BUTTON TO START GAME
2	0017-00101-0552	#6-32 x 1/4 CARRIAGE BOLT (2 REQ'D.)
3	0090-00117-03XF	COIN ENTRY PLATE (25¢)
4	0090-00906-0000	PLASTIC START BUTTON
5	0010-00007-0000	COMPRESSION SPRING
6	A090-00020-2003	DOOR ASSY. DOUBLE ENTRY
7	0017-00005-0050	DOOR LOCK & KEY WITH SCREW & NUT
8	0090-00002-02BK	DOUBLE DOOR FRAME
9	0017-00005-0041	421 N.S. CAM
10	0090-00901-0000	DOOR SWITCH
	0090-00126-01XF	SWITCH BACKUP PLATE
12	0017-00101-0528	#5-40 x 3/4 LNG. M.S.
13	0090-00903-9500	25¢ WINDOW
14	0090-00143-00XF	COIN PLEX RETAINER
15	0017-00104-0002	SPLIT LOCK WASHER
16	0017-00007-0019	KEY HOOK
17	0017-00103-0087	#6-32 HEX NUT
18	0090-00010-0000	SW. PLATE & OILLITE ASSY.
19	0017-00100-0018	"E" RING
20	0090-00131-0000	SWITCH
21	A090-00087-0100	TOP & BTM. COIN CHUTE W/BRKT. ASSY.
22	0017-00101-0123	#8 x 1/4 SCREW
23	0010-00181-0100	SPRING
24	0090-00129-00XF	PIVOT POST
25	0010-00134-0000	SPRING
26	A090-00085-0000	ACCEPTOR FRAME ASSY.
27	0093-00155-00XF	REJECTOR LEVER
28	0017-00100-0012	"E" RING
29	0090-00162-00XF	COIN SWITCH MTG. BRKT. — SMALL
29	0090-00163-00XF	COIN SWITCH MTG. BRKT. — LARGE
30	0017-00005-0203	COIN SWITCH CHUTE — SMALL
30	0017-00005-0204	COIN SWITCH CHUTE — LARGE
31	0017-00101-0124	#6 x 1/4 SCREW
32	0017-00005-0195	COIN SWITCH
33	0010-00599-0000	COIN SWITCH WIRE
34	0017-00007-0132	PUSH-ON RING (BLK.)
35	0017-00101-0698	#4-40 x 3/4 SCREW (. REQ'D.)
36	0090-00128-00XF	SWITCH BRKT. — DOOR TILT
	A090-00061-0000	ANTI-STRING DEVICE ASSY.
	A090-00064-0000	ANTI-PENNY DEVICE ASSY.

OMEGA RACE

Vector Mother Board #A084-90007-E929

CHIP NUMBER	FUNCTION
74LS00	Quad 2 input Nand
74LS02	Quad 2 input Nor
74LS04 or 74S04	Hex inverter
74LS08	Quad 2 input And
74LS10	Triple 3 input Nand
74LS14	Hex Schmitt-Trigger
74LS20	Dual 4 input Nand
74LS32	Quad 2 input Or
74LS42	BCD to decimal decoder
74LS74	Dual "D" Flip-Flop
74LS83	4 bit binary adder
7497	6 bit rate multipliers
74LS109	Dual "JK" Flip-Flop
74LS138	3 to 8 line decoder
74LS139	Dual 2 to 4 line decoder
74LS157	Quad 2 to 1 line multiplexer
74LS161	4 bit binary counter
74LS174	Hex "D" Flip-Flop
74LS175	Quad "D" Flip-Flop
74LS191	Synchronous up-down counters
74LS193	Up-down counter with dual clock
74LS244	Octal buffer
74LS245	Octal bus tranceiver
74LS273	Octal "D" Flip-Flop
74LS367	Hex bus driver
74LS374	Octal "D" Flip-Flop
74LS393	Dual 4 bit binary counter
74LS670	4 by 4 register files
Z80	CPU
2114	1K x 4 Ram
2716	2K x 8 Prom
2532	4K x 8 Prom
9316	2K x 8 Rom
9332	4K x 8 Rom
MI-7611-5	Prom
5101	256 x 4 Ram
UPD8216	4 bit bus tranceiver
AD561	Digital to analog converter
TL081	Operational amplifier
TL082	Operational amplifier
4016	Quad electronic switch
7805	Positive 5 volt regulator
78M12	Positive 12 volt regulator
7815	Positive 15 volt regulator
7915	Negative 15 volt regulator
12.0000	Crystal 12 megahertz

OMEGA RACE

Game Board #A084-91372-D929

CHIP NUMBER	FUNCTION
7400	Quad 2 input Nand
7402	Quad 2 input Nor
7404	Hex inverter
7407	Hex buffer
7408	Quad 2 input And
7432	Quad 2 input Or
7492	Divide by 12 counter
74138	3 to 8 line decoder
74367	Hex bus driver
74LS373	Octal "D" latch
74LS374	Octal "D" Flip-Flop
Z80	CPU
2716	2K x 8 Prom
2114	1K x 4 Ram
LM383	8 watt audio amplifier
AY-3-8912	Sound chip

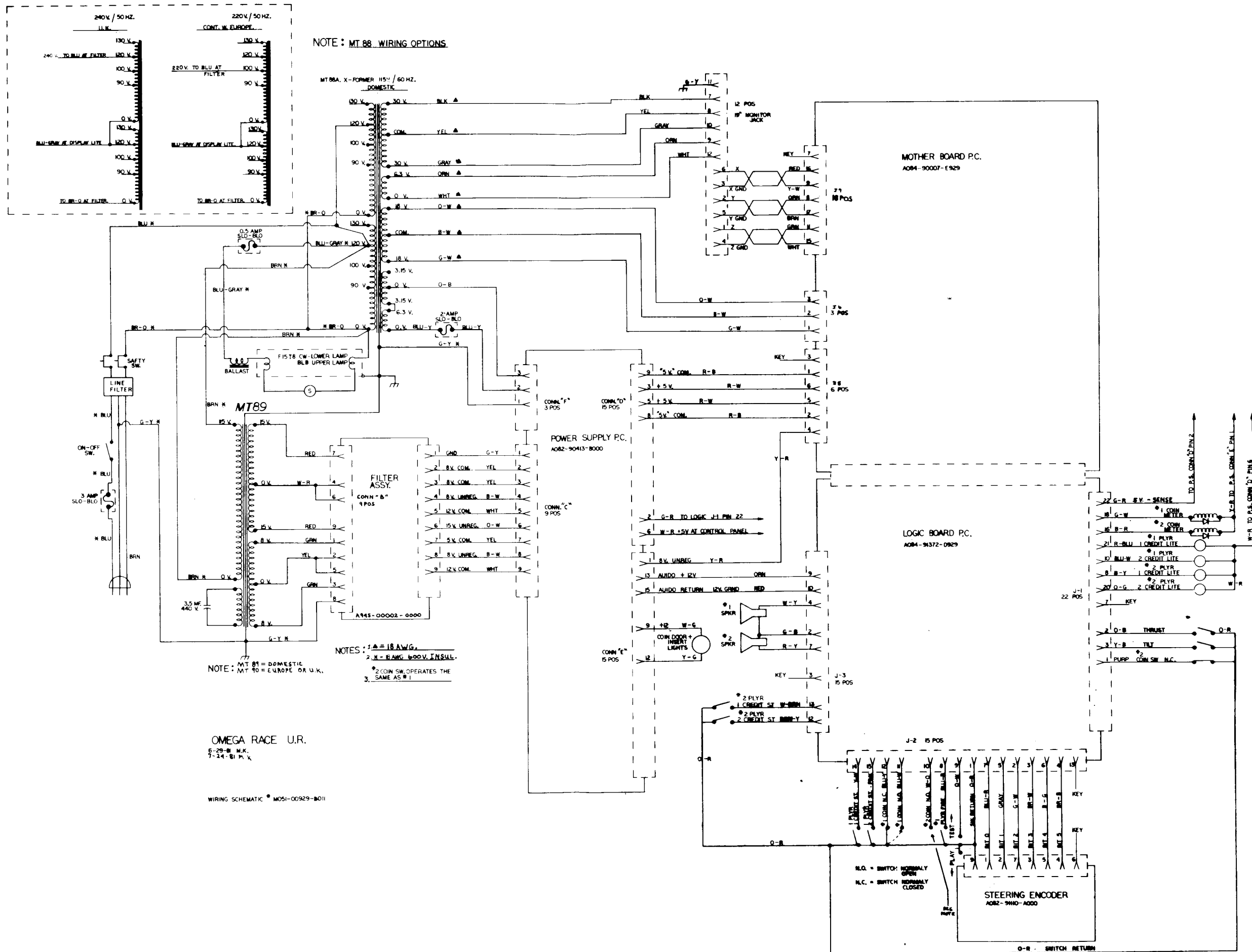

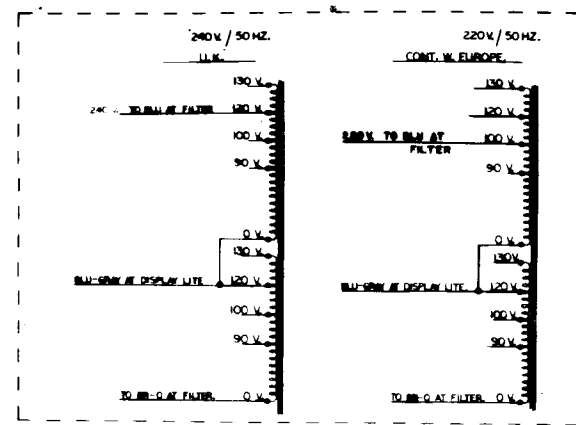

NOTE: MT 89 WIRING OPTIONS

MT89A X-FORMER 115V/60HZ. DOMESTIC

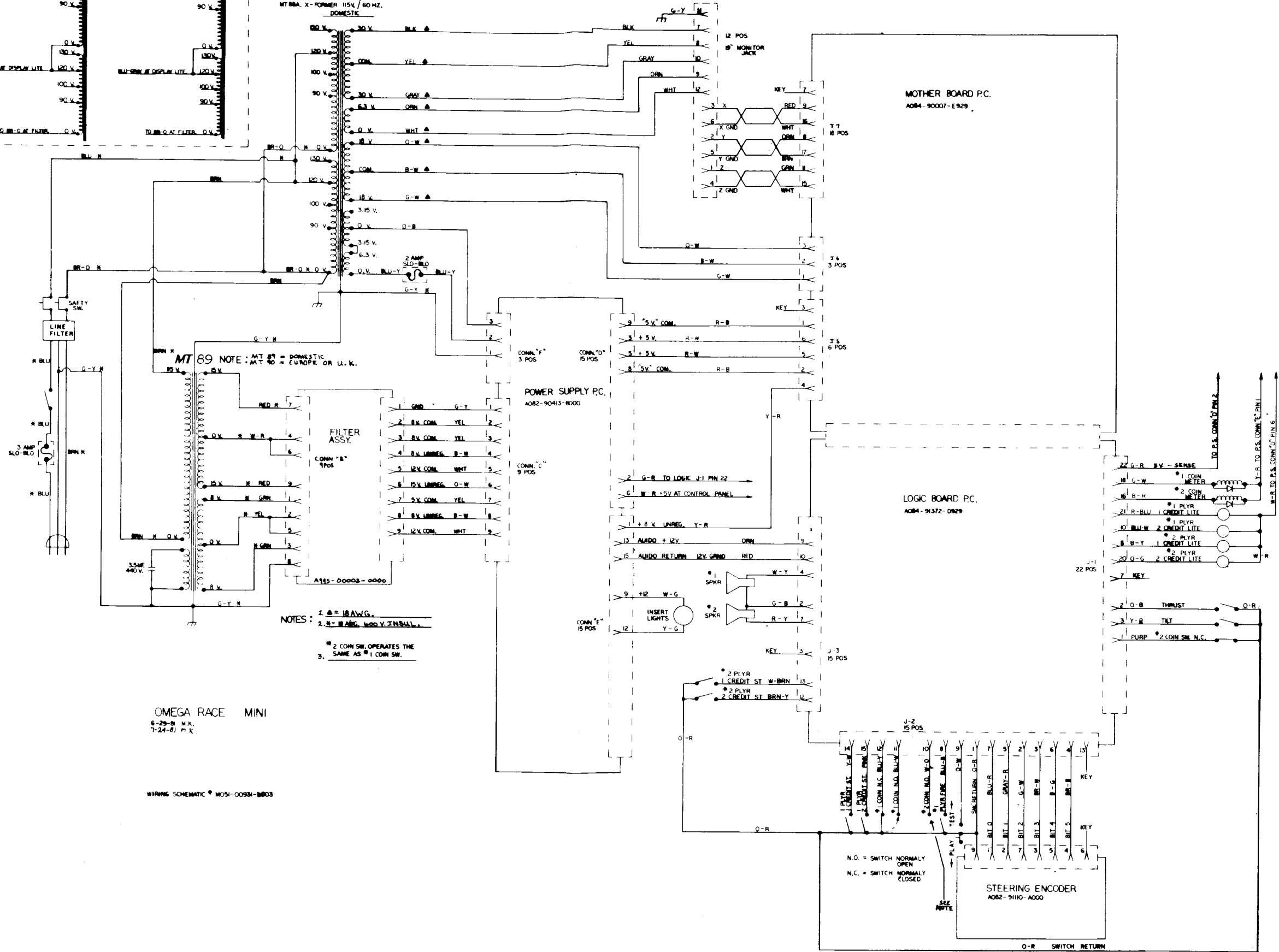

OMEGA RACE MINI
6-29-81 N.K.
7-24-81 N.K.

WIRING SCHEMATIC * M051-0093A-B003

NOTES:
1. = 18AWG.
2. = 18AWG. W/RY ZINSHLL.
* 2 COIN SW OPERATES THE SAME AS #1 COIN SW.

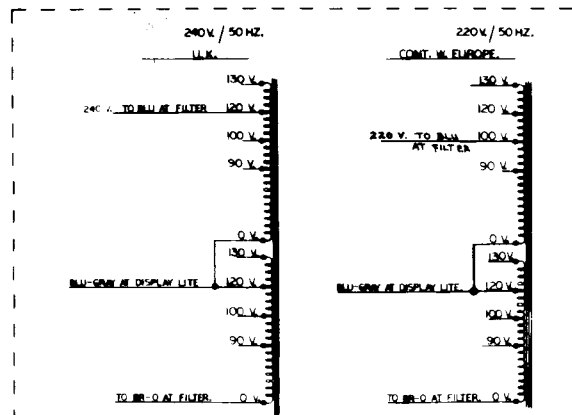

NOTE: MT 88 WIRING OPTIONS

MT 88A, X-FORMER 115V/60 HZ. DOMESTIC

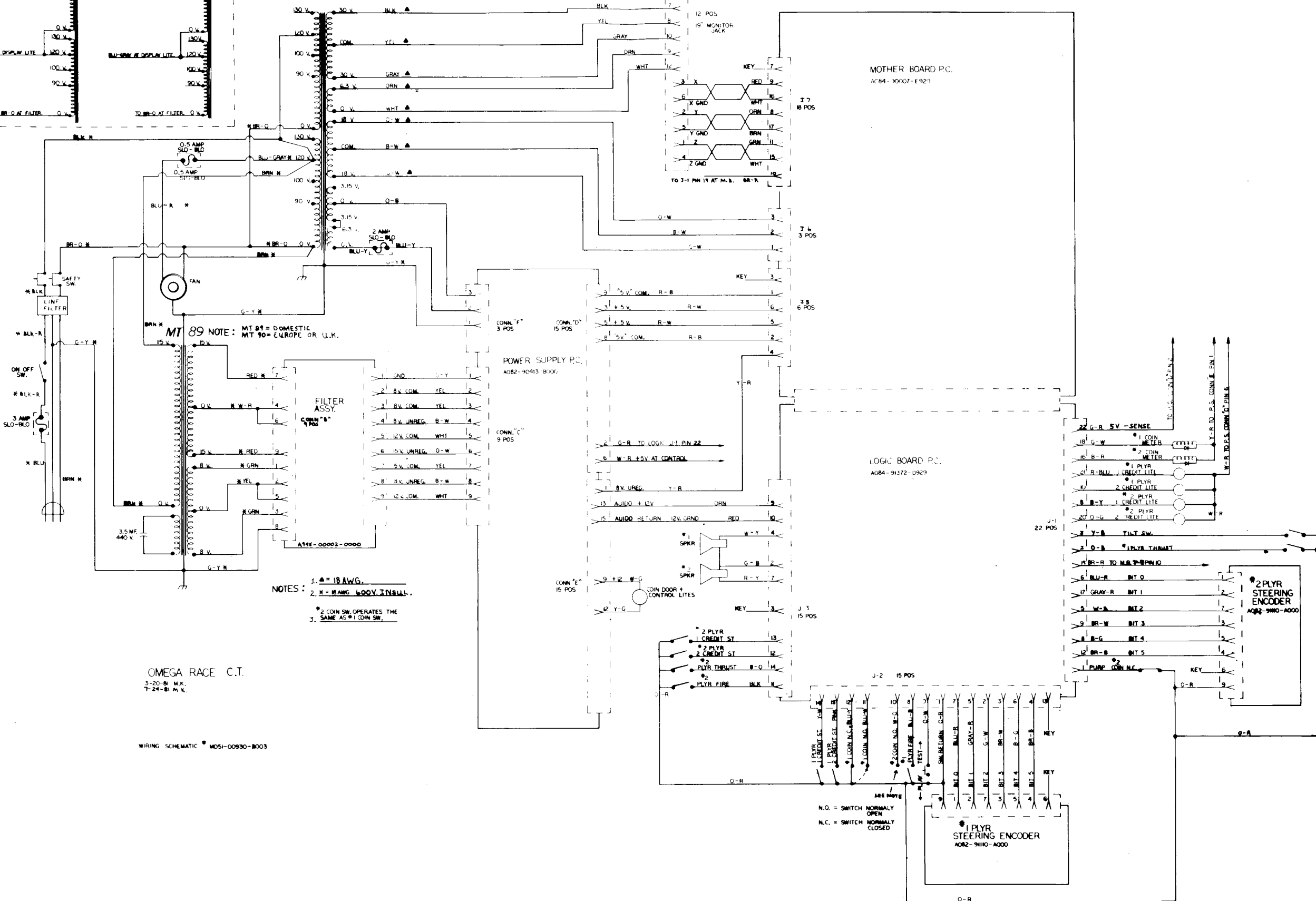

MT 89 NOTE: MT 89 = DOMESTIC MT 90 = EUROPE OR U.K.

- NOTES:
- 1. ▲ = 18 AWG.
 - 2. H = 18 AWG. 600V. INSULL.
 - 3. * 2 COIN SW OPERATES THE SAME AS * 1 COIN SW.

OMEGA RACE C.T.
3-20-M.K.
7-21-B.M.K.

WIRING SCHEMATIC MDSI-00930-8003

SEE NOTE
N.O. = SWITCH NORMALLY OPEN
N.C. = SWITCH NORMALLY CLOSED

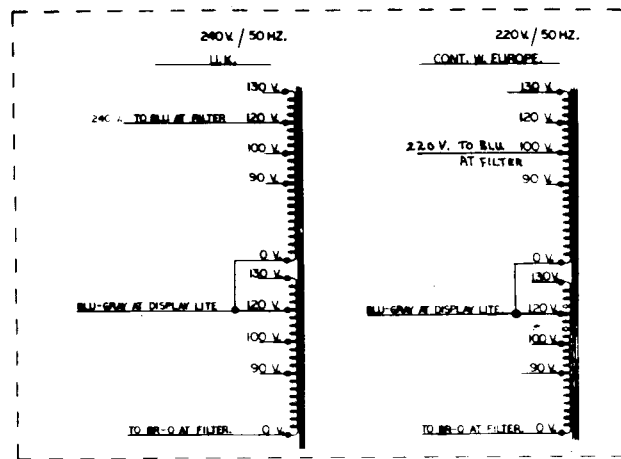

NOTE: MT 88 WIRING OPTIONS.

MT 88A, X-FORMER 115V/60HZ. DOMESTIC

OMEGA RACE S.D. WIRING SCHEMATIC

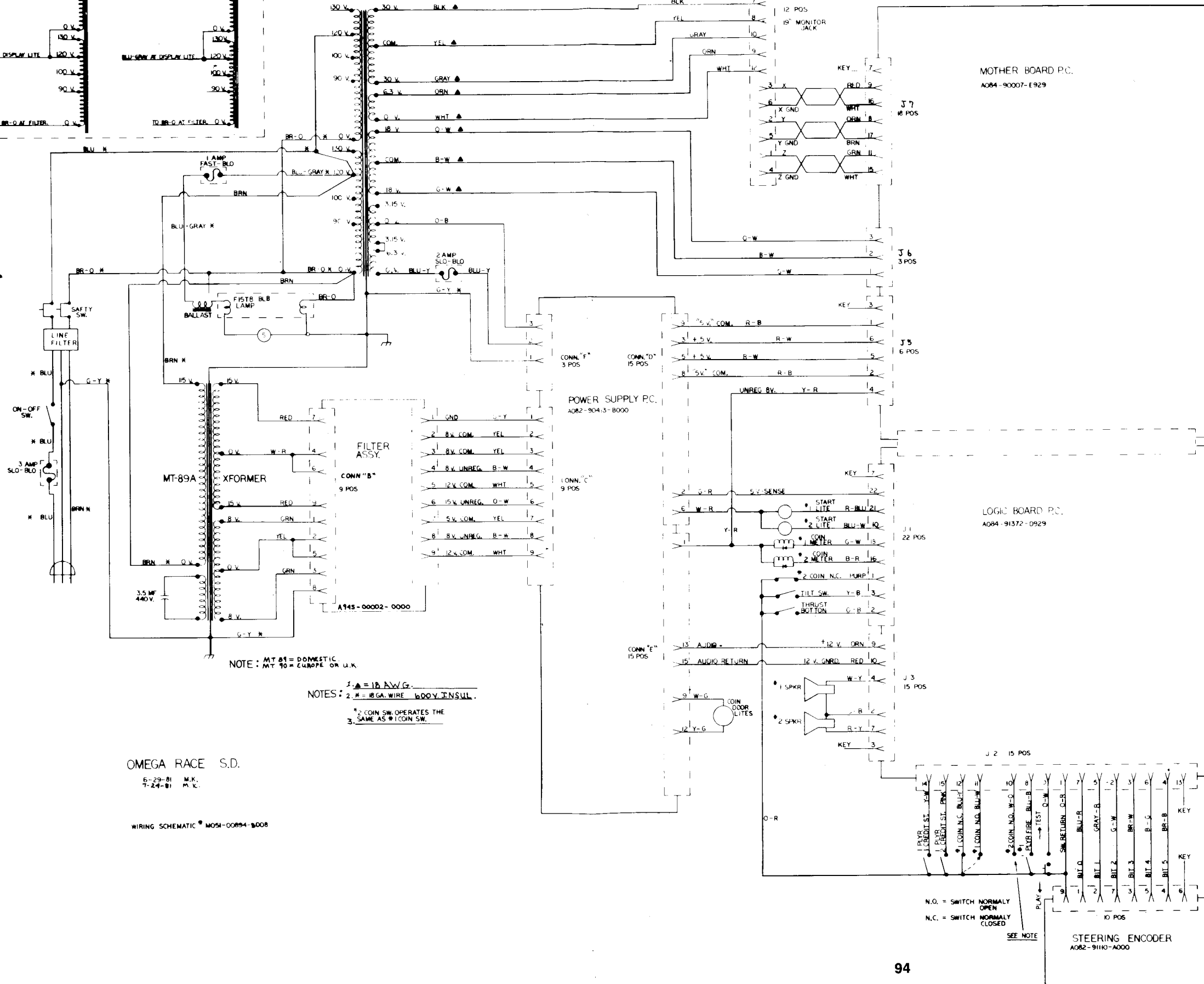

NOTE: MT 89 = DOMESTIC. MT 90 = EUROPE OR U.K.

NOTES: 1. \blacktriangle = 18 AWG.
2. * = 18 GA. WIRE 600V. INSUL.
* 2 COIN SW. OPERATES THE SAME AS #1 COIN SW.

OMEGA RACE S.D.

6-29-81 M.K.
7-24-81 M.K.

WIRING SCHEMATIC # M051-00894-0008

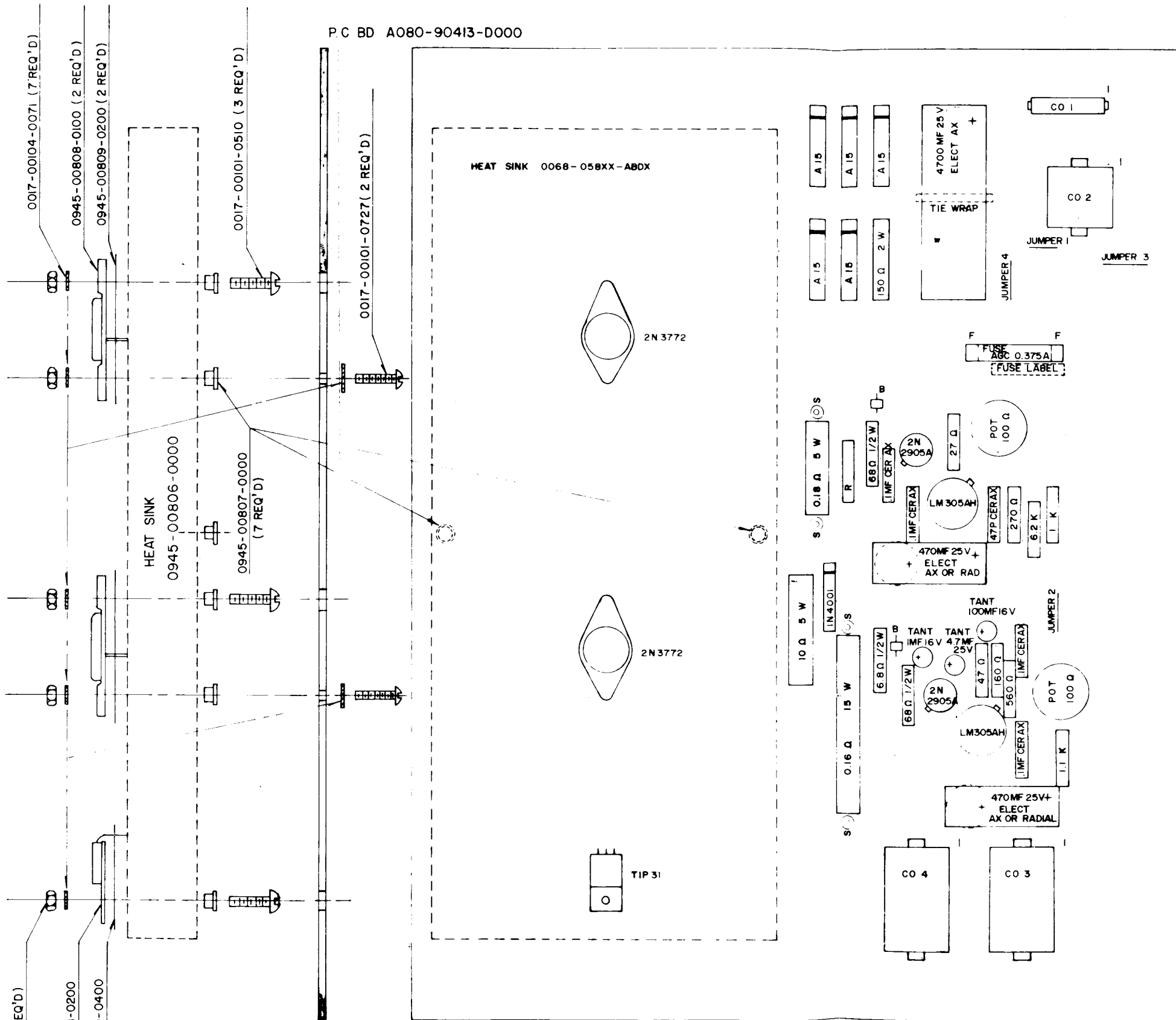

NOTE
 CO 1 - P.C MOUNT CONN. (MALE) - 0017-00021-0443 (3 PIN)
 CO 2 - " " " " " " 0442 (9 PIN)
 CO 3 - " " " (FEMALE) " " 0441 (15 PIN)
 CO 4 - " " " (MALE) " " 0440 (15 PIN)
 R - JUMPER
 F - FUSE CLIP
 S - SPACER 3/8 INCH
 JUMPERS ARE 22 GAGE WIRE.
 OMEGA RACE - OMIT JUMPER 1 AND 3
 B - FERRITE BEAD WITH 20 GAGE WIRE

M051-00929-D003

DO NOT SCALE DWG		HEAT TREAT.	SCALE	DESIGN ON OMEGA RACE	REVISIONS
DIM TOLERANCES UNLESS SPECIFIED		MATL		NO. REQ'D PER	
DATE	2/5/81	FINISH		ASS'Y DRAWING	
LINEAR PWR SUPPLY, 125 VA WITHOUT SUPPORT CIRCUIT				MIDWAY MFG. CO. FRANKLIN PK ILL	
				PART NO A082-90413-D000	

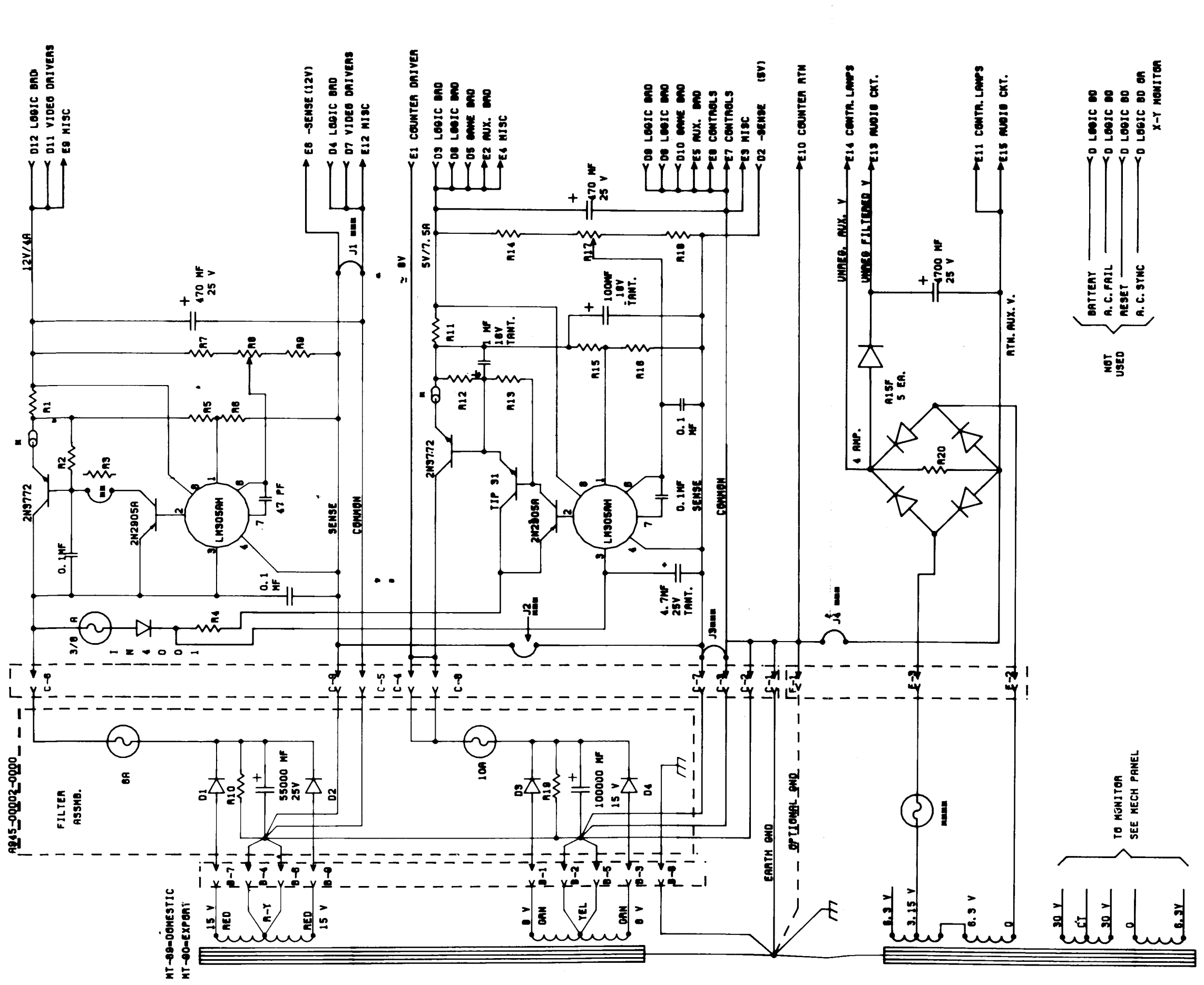

RESISTOR KEY

- R1-0.10 OHM, 5W
- R2-0.08 OHM, 1/2W
- R3-
- R4-10 OHM, 5W
- R5-27 OHM
- R6-270 OHM
- R7-8.2K OHM
- R8, R17-100 OHM PBT.
- R9-1K OHM
- R10, R20-150 OHM, 2M
- R11-0.10 OHM, 15W
- R12-8.8 OHM, 1/2W
- R13-88 OHM, 1/2W
- R14-1.1K OHM
- R15-47 OHM
- R16-100 OHM
- R18-560 OHM
- R19-47 OHM, 2M

DIODE KEY

- D1-D4-MN1120

NOTES

- FERRITE BEAD
- == JUMPER OR RESISTOR OPTION
- JUMPER OPTIONS
- FUSE VALUE VARIES WITH APPLICATION

- NOT USED
- BATTERY
- A.C. FAIL
- RESET
- A.C. SYNC
- D LOGIC BD
- D LOGIC BD
- D LOGIC BD
- D LOGIC BD OR X-Y MONITOR

MT-88

MT-88-00002-0000

drn	TJK	used on	OMEGA RACE	REVISIONS
chk'd	L. D. 3/3/81	no. req'd	J. PER	MIDWAY MFG. COMPANY FRANKLIN PARK IL.
date	2/27/81	LINEAR POWER SUPPLY ASS'Y 125VA WITHOUT CIRCUIT SUPPORT		P/N A082-80419-0000

MA13	1
BUSAK	2
HALT	3
RFSH	4
RE	5
RESET	6
BUSRQ	7
RD	8
3.8KHZ	9
NMI	10
3MHZ	11
15.5KHZ	12
N/U	13
GBNMI	14
12MHZ	15
WATT	16
N/U	17
MDO	18
MA9	19
MA0	20
MA2	21
MA4	22
MA4	23
GND	24
+5V	25
+5V	26
GND	27
+5V	28
-15V	29
+5VDC	30
-0.2	31
+0.2	32
+12	33
+15	34
GND	35
+5V	36
MA12	A
MA4	B
MA4	C
1.5MHZ	D
7.5MHZ	E
MA11	F
WR	H
MREQ	J
IORQ	K
MD7	L
MA15	N
MD5	P
MD4	R
MD3	S
MD2	T
MD1	U
MA8	V
MA10	W
MA1	X
MA5	Y
MA3	Z
GND	a
GND	b
GND	c
N/U	d
N/U	e
-15	f
+5VDC	g
-0.2	h
+0.2	i
+12	j
+15	k
GND	l
+5V	m

18VAC	1
C T	2
18VAC	3
GND	4
GND	5
KEY	6
-0.2 DC UNREG	7
+5VDC	8
+5VDC	9

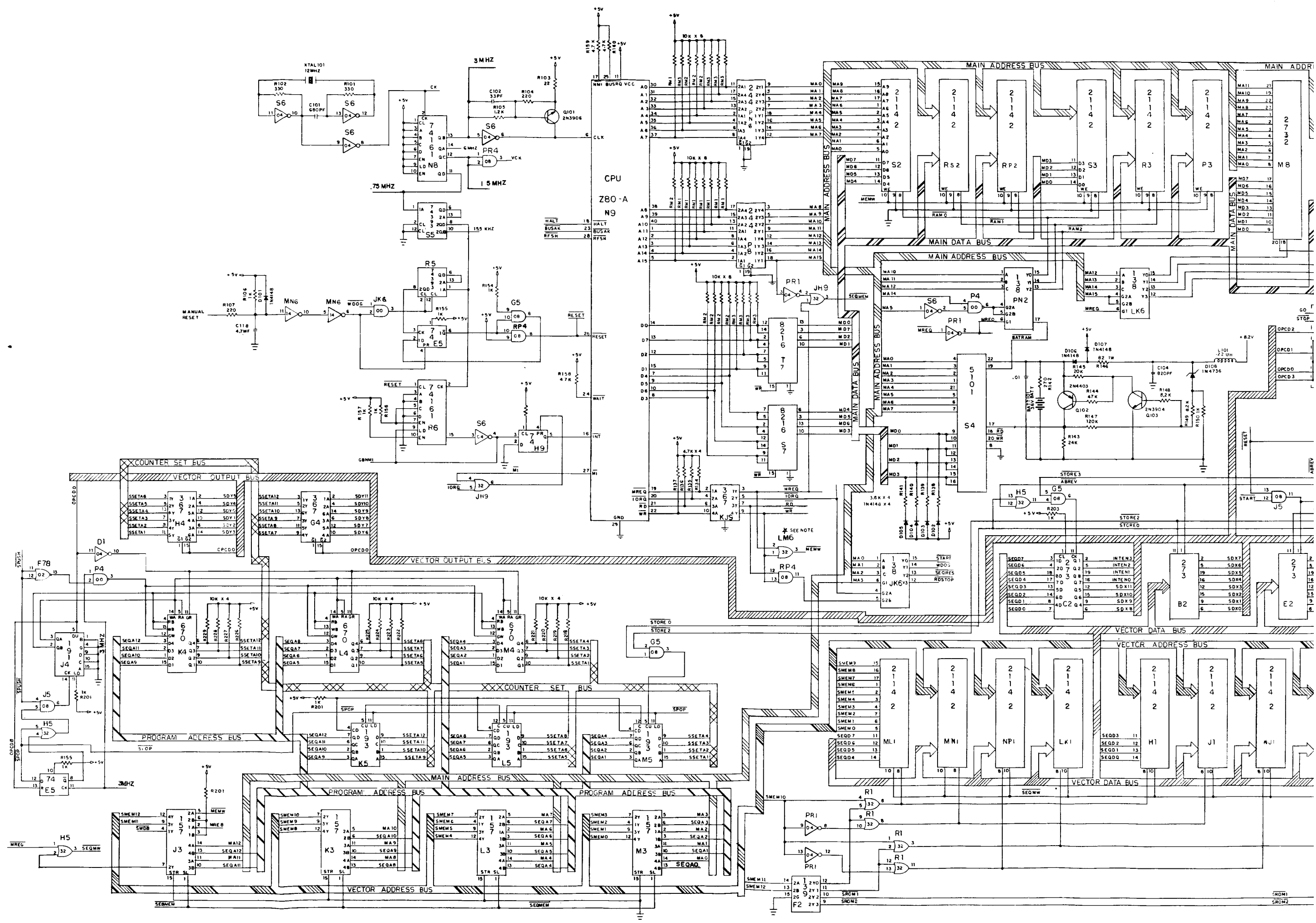

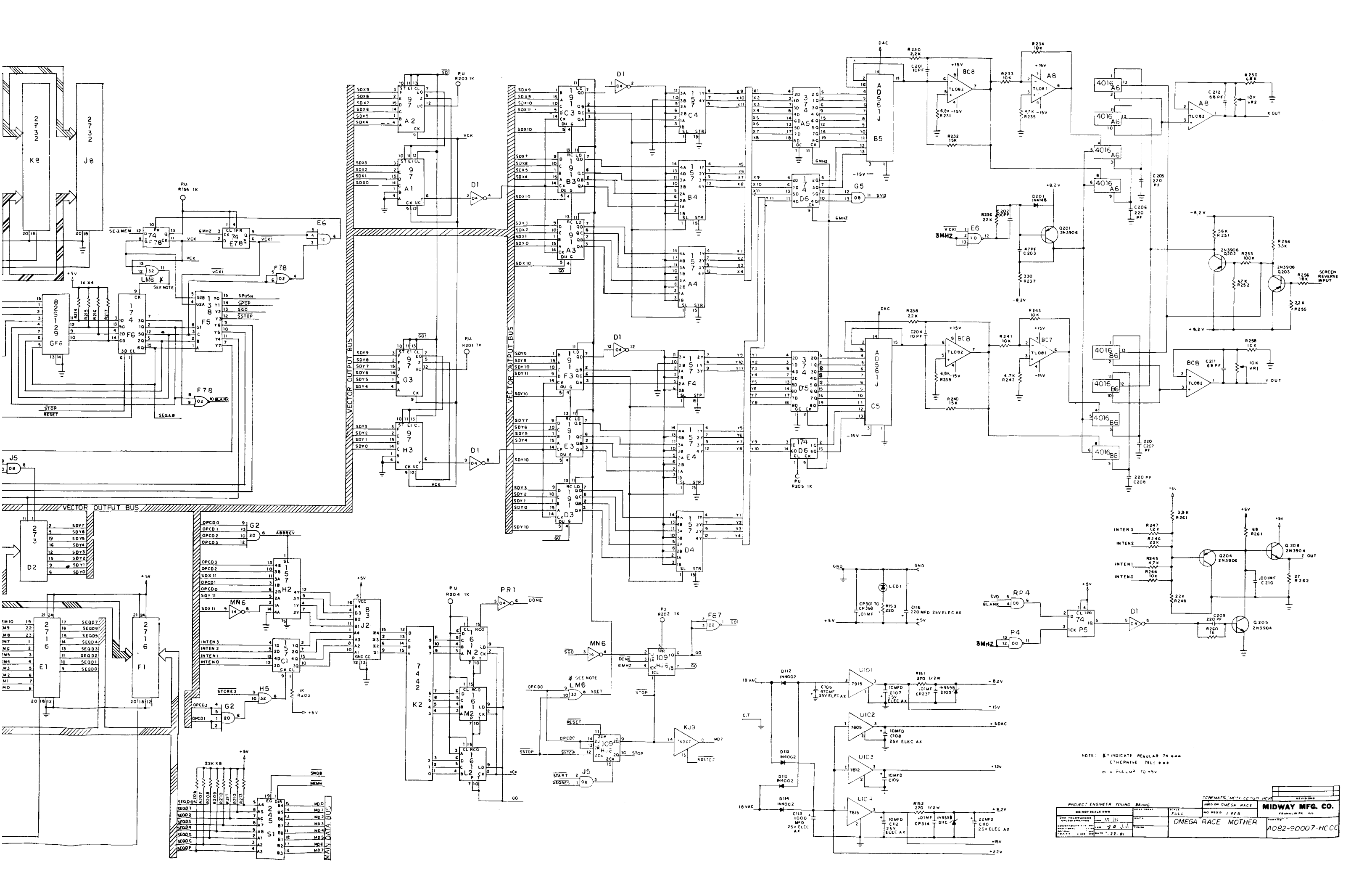

NOTE: * INDICATE REGULAR 74 ***
OTHERWISE 74LS ***
Q = FULLUP TO +5V

PROJECT ENGINEER YOUNG BRAWN		DATE		REV. NO.	
DO NOT SCALE DIMS		SCALE		NO. REQS. 1 PER	
CIRCUIT NO. 1000		TITLE		MIDWAY MFG. CO.	
DESIGNED BY J. J. J.		CHECKED BY		PARALLEL PR. 111	
DRAWN BY		DATE		OMEGA RACE MOTHER	
PARTS LIST		REV. NO.		A082-0007-HCC	

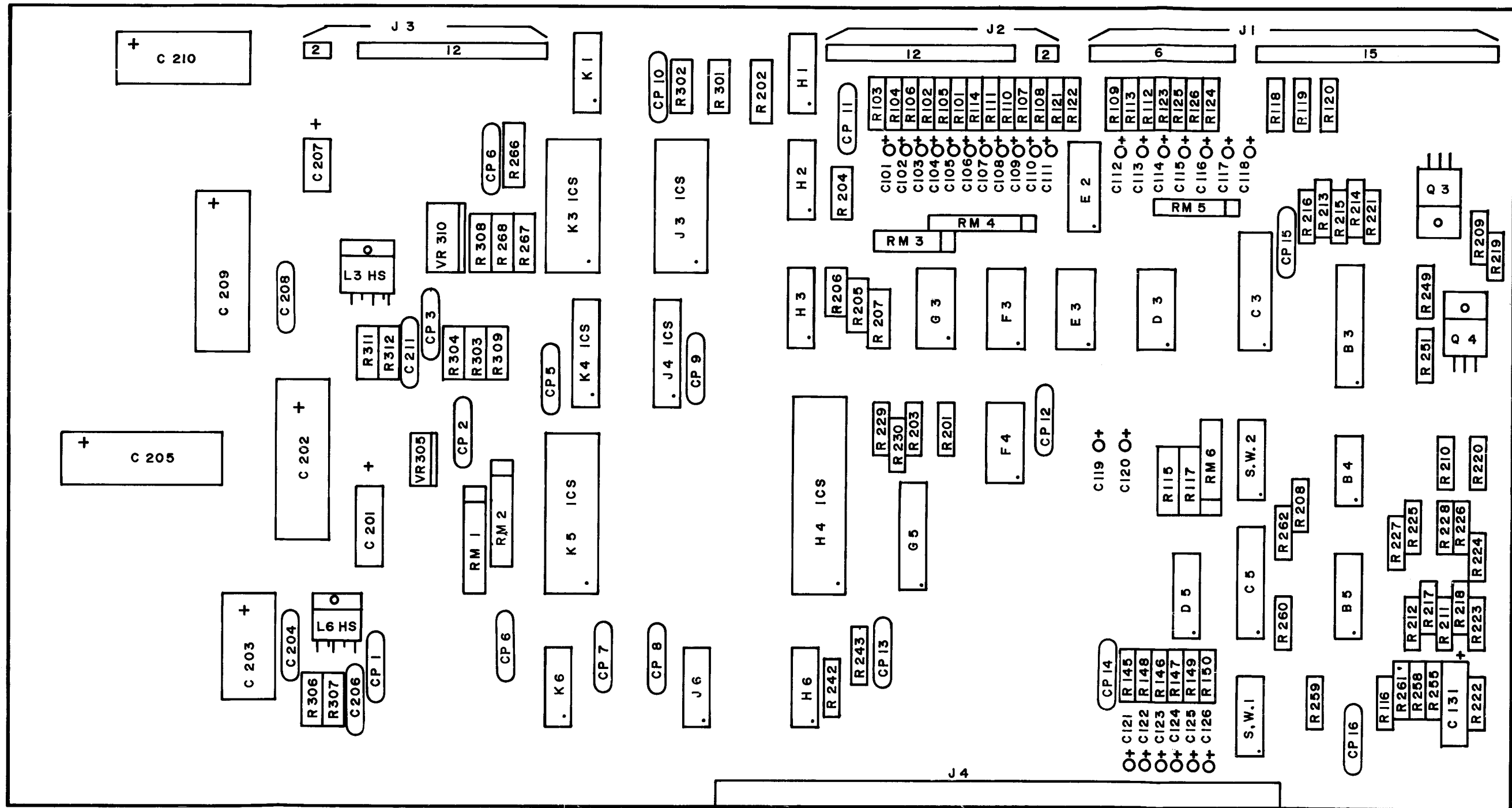

Q'TY	DISCRIPTION	DESIGNATION	PART NO.
2	KK-15625 2 PIN	J 2, 3	3000-16367-0200
1	KK-15625 6 PIN	J 1	3000-16367-0600
2	KK-15625 12 PIN	J 2, 3	3000-16367-1200
1	KK-15625 15 PIN	J 1	3000-16367-1500

M051-00929-G005
 PROJ. ENG. J. JARON, Y. BANG

REVISIONS	

DO NOT SCALE DWG.		HEAT TREAT	SCALE
DIM. TOLERANCES UNLESS SPECIFIED		MAT'L.	ASS'Y DRAWING DAUGHTER B.D.
CONCENTRICITY T.I.R. .003	DRN. <i>cl</i>	FINISH	
FRACTIONAL ± 1/64	CKD. <i>J.J.</i>		
DECIMAL ± .005	DATE 7/21/81		
HOLE DIA. +.002-.000			

USED ON OMEGA RACE
 NO. REQ'D 1 PER

MIDWAY MFG. CO.

FRANKLIN PK. ILL.

PART NO.
 A084-91372-G929

DESIGNATION LIST

DESIGNATION	DESCRIPTION	DESIGNATION	DESCRIPTION
C101-126	1uF 25V TANT	L 3, 6	LM 383
C 131	10uF 25V TANT AX.	Q 3, 4	TIP 31
C 201	10 uF 25V ELECT AX.	IC B 3	74LS374
C 202, 203	470 uF 25V ELECT AX.	IC B 4	7407
C 204	.001uF CER. DISC	IC B 5	7404
C 205	1000 uF 25V ELECT AX.	IC C 3	74LS373
C 206	.2 uF CER. DISC	IC C 5	74LS373
C 207	10 uF 25 V ELECT AX.	IC D 3	74LS367
C 208	.001 CER. DISC	IC D 5	74LS367
C 209	470 uF 25V ELECT AX.	IC E 2	7400
C 210	1000 uF 25V ELECT AX.	IC E 3	74LS367
C 211	.2 uF CER. DISC	IC F 3	74LS367
CP1-16	.01 uF AX. CER. BY PASS	IC F 4	7400
		IC G 3	74LS138
		IC G 5	74LS374
R101-126	68 ohm	IC H 1	7408
R145-150	1 K	IC H 2	7402
R 201-207	4.7 K	IC H 3	7432
R 208-214	1 K	IC H 4	Z 80
R 215-220	220 ohm	IC H 6	7400
R 221-230	1 K	IC J 3	8912
R 242, 243	10 K	IC J 4	2114
R 250	1 K	IC J 6	7404
R 252	1 K	IC K 1	7492
R 255	1 K	IC K 3	8912
R 258-262	1 K	IC K 4	2114
R 266-268	10 K	IC K 5	PROM
R 301, 302	10 K	IC K 6	7404
R 303, 304	1 K	L 3, 6 HS	HEAT SINK
R 306	2.2 ohm	J 3 ICS	28 PIN IC SOCKET
R 307	220 ohm	J 4 ICS	18 PIN IC SOCKET
R 308, 309	1 K	K 3 ICS	28 PIN IC SOCKET
R 311	2.2 ohm	K 4 ICS	18 PIN IC SOCKET
R 312	220 ohm	K 5 ICS	24 PIN IC SOCKET
RM 1, 2	9 PIN 10 K SIP	H 4 ICS	40 PIN IC SOCKET
RM 3-6	9 PIN 1 K SIP	SW1, 2	8 POS. DIP
VR 305	10 K POT	J 1	KK-15625 90° (6,15)
VR 310	10 K POT	J 2	KK-15625 90° (2,12)
		J 3	KK-15625 90° (2,12)

CROSS REFERENCE LIST

Q'TY	DESCRIPTION	DESIGNATION	PART NO.
2	.001 uF 50V CER. DISC	C 204, 208	0061-070HX-1AIX
16	.01 uF 50V AX. CER.	CP 1-16	0929-00818-0400
2	.2 uF CER. DISC	C 206, 211	0929-00811-0000
26	1 uF 25V TANT.	C101-126	0929-00818-0500
1	10 uF 25V TANT. AX.	C131	0174-203E4-EX0X
2	10 uF 25V ELECT. AX.	C 201, 207	0929-00808-0900
3	470 uF 25V ELECT. AX.	C 202, 203, 209	0929-00808-1200
2	1000 uF 25V ELECT. AX.	C 205, 210	0929-00808-1300
37	1 K 1/4 W	R145-150	0062-179B3-1XXX
		R 221-230, 250, 208-214,	
		R 252, 255, 258-262	
		R 303, 304, 308, 309	
2	2.2 ohm 1/4 W	R 306, 311	0062-034B3-1XXX
8	220 ohm 1/4 W	R 215-220	0062-133B3-1XXX
		R 307, 312	
7	4.7 K 1/4 W	R 201-207	0062-211B3-1XXX
7	10 K 1/4 W	R 242, 243	0062-227B3-1XXX
		R 266-268, 301, 302	
26	68 ohm 1/4 W	R101-126	0062-098B3-1XXX
4	1 K 9 PIN SIP	RM 3-6	0929-00820-0100
2	10 K 9 PIN SIP	RM 1, 2	0062-00929-0001
2	10 K POT	VR 305, 310	0063-265AX-1EEX
2	TIP 31	Q 3, 4	0929-00814-0000
2	LM 383	L 3, 6	0066-043BX-XXAX
3	7400	IC H 6, F 4, E 2	0929-00810-3300
1	7402	IC H 2	0929-00810-3400
3	7404	IC K 6, J 6, B 5	0929-00810-3500
1	7407	IC B 4	0929-00810-3900
1	7408	IC H 1	0929-00810-3600
1	7432	IC H 3	0929-00810-3700
1	7492	IC K 1	0929-00810-3200
1	74LS138	IC G 3	0929-00810-1300
4	74LS367	IC F 3, E 3, D 3, D 5	0929-00810-2500
2	74LS373	IC C 3, C 5,	0066-716AX-XXXX
2	74LS374	IC B 3, G 5,	0929-00810-2300
2	2114	IC J 4, K 4	0929-00810-2800
2	8912	IC J 3, K 3	0066-289BX-XXSX
1	Z 80	IC H 4	0066-274BX-XXWD
1	PROM	IC K 5	0929-00810-3800
2	HEAT SINK	L 3, 6 HS	0068-046XX-BXAX
2	18 PIN IC SOCKET	J 4, K 4 ICS	0069-117XX-XXWX
2	28 PIN IC SOCKET	J 3, K 3 ICS	0069-186XX-XXWX
1	24 PIN IC SOCKET	K 5 ICS	0929-00817-0100
1	40 PIN IC SOCKET	H 4 ICS	0929-00817-0200
2	8 POS. DIP	SW1, 2	0929-00816-0000

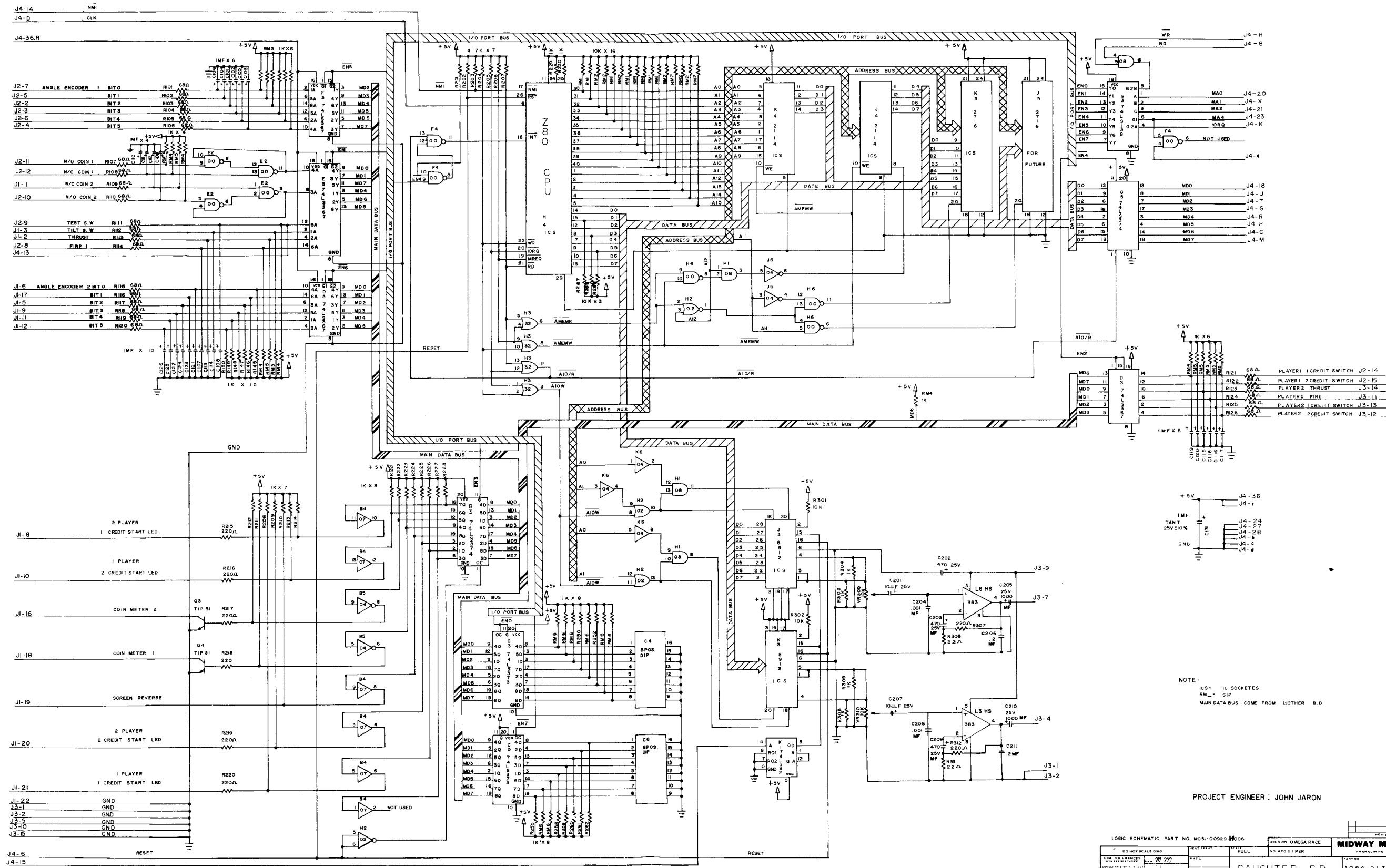

PROJECT ENGINEER: JOHN JARON

LOGIC SCHEMATIC PART NO. M051-00929-0006		MIDWAY MFG. CO.	
DWG TOLERANCES	UNLESS OTHERWISE SPECIFIED	DATE	REV
0.005	0.005	11-81	1
DAUGHTER B.D.		A084-31372-H929	

Black & White X-Y T.V. Monitor

Introduction

(How to use this section of your manual.)

Welcome to the world of the X-Y monitor, an electronic device that strikes terror into the heart of many a technician. The **main reason** it is so intimidating is that the Vector Beam, Quadrascan, or X-Y monitor is **TOTALLY UNLIKE** the Rasterscan monitor or T.V. set as you probably call it. Since many technicians are generally unfamiliar with the circuit operation, they may not be able to figure out when a symptom correlates with (points to) a particular circuit. If you are a technician, this section of the manual will certainly be a life-saver (our modest opinion). If you don't know anything about electronics, just relax because these monitors are a lot simpler than a regular monitor or T.V. set.

Vectorbeam or X-Y monitors are used because a regular Rasterscan monitor constructs the picture in a different way. For example, your T.V. set has 525 horizontal lines on the screen from top to bottom. Each line is a slice of the picture. If you stare real close at the edge of a picture of a curved object (a large ball) or an angular object (the peak of a roof) on the screen of your T.V., you will be able to see the individual slices that the object's edge is made up of. The edge of the curved or angular objects will not appear to be completely smooth but will look like they are stepped. However, at normal viewing distance, these same curved or angular lines will appear to be smooth or straight and not stepped. To make sure that the pieces or slices of the picture stay together just like they were transmitted, T.V. sets have synchronization circuits. Vectorbeam monitors don't use ANY of this. Here, the electron beam smoothly goes anywhere it is told to to paint the picture. It DOES NOT go across the screen 525 times to paint the picture in slices. Because of this shortcut, the circuitry is less complex and the detail in the

figures will appear smoother. One drawback is that the brightness level is intentionally designed to be at a level high enough to burn or etch right into the picture tube face. This will be covered in more detail later in this section.

If your X-Y monitor develops a problem, you can go directly to the "SYMPTOM DIAGNOSIS" subsection where you can match up your problem to the problem described and the circuit that may be causing it. From there you go to the schematic diagrams for your particular brand of monitor and troubleshoot the circuits mentioned in the "SYMPTOM DIAGNOSIS" subsection.

If you are a technician who is unfamiliar with X-Y monitors, you may want to read the "THEORY OF OPERATION" subsection first. This section **IS NOT** a rigorous description of circuit operation, but a simplified general description of major circuit blocks. Some literature has been written on this subject. Electrohome's instruction and service manual on the G05-801 is an analysis on one X-Y monitor (which Midway Mfg. Co. does not use) **described from an engineering standpoint**. All that is necessary to understand it is a battery of U.N. interpreters. Electrohome's instruction and service manual on the G05-802 and G05-805 monitors (which Midway Mfg. Co. does use) is simpler and more condensed. The best manual we have found on the subject so far is Wells Gardner's publication on their Graphic Display Unit, model 19V2000 (which Midway Mfg. Co. also uses). Most technicians will understand it and it is very complete. The above manuals are available on request from your distributor or monitor manufacturer.

For those who know nothing of electronics, we suggest that you read the "THEORY OF OPERATION" subsection, and we definitely recommend that you read the "TROUBLESHOOTING" subsection. From there, go to the "SYMPTOM DIAGNOSIS" subsection, and then to the schematic diagrams — the monitor's road map.

Symptom Diagnosis

1. Insufficient width or height :

- A. Horizontal line (due to "Y" amplifier defect).
 - Bad yoke.
 - Bad "Y" amplifier output transistors.
 - Blown "Y" amplifier fuse.
 - Open fusible resistor in the "Y" amplifier.
 - Yoke pins not making good contact (very common).
- B. Vertical line (due to "X" amplifier defect).
 - Bad yoke.
 - Bad "X" amplifier output transistors.
 - Blown "X" amplifier fuse.
 - Open fusible resistor in the "X" amplifier.
 - Yoke pins not making good contact (very common).

2. Picture spread out too far and/or crushed in certain areas:

- A. Controls for linearity (located on the deflection board and set at the factory) are misadjusted.
- B. Bad yoke.

3. Poor focus:

- A. Low focus voltage from the high voltage board.
- B. Defective diode off the flyback.
- C. Defective focus control.
- D. Defective picture tube (CRT).

4. Picture not bright enough:

- A. If the CRT voltages are present, the picture tube is probably bad. The surest way to cure this on an X-Y monitor is to replace the picture tube (CRT).
- B. Weak 90 volt supply from the EHT power supply.
- C. Loose wire to socket of CRT for G2 voltage.

5. Silvery effect to the white lines, or picture looks dim, washed out:

- A. If the CRT voltages are present, the picture tube is probably bad. The surest way to cure this on an X-Y monitor is to replace the picture tube (CRT).

6. Increasing brightness causes an increase in picture size and weakens focus:

- A. For the most part, this is normal in X-Y monitors. But if this should occur at normal viewing levels, either:
 - The CRT is defective.
 - The high voltage rectifier is weak.
 - Or the high voltage circuitry has poor regulation.

7. Picture rapidly blinks on and off:

- A. Internal short in the picture tube (arcing).

8. A dot on the middle of the screen — Red LED is turned on (located on the deflection board):

- A. The "X" and "Y" signals are not making it into the monitor.
- B. Check cabling, jacks, and logic boards.
- C. "X" and "Y" amplifier failure. See Number 1 above and *check the fuses first*.

9. Monitor won't turn on:

- A. Open fuse(s).
- B. A defect in the power supply; check:
 - Fuse(s).
 - Transistors.
 - Open fusible resistor.
- C. Check jack to make certain all pins are obtaining their voltage from the other game circuitry.
- D. Check for loose foil, especially by D100.

10. Blown 5 amp fuses:

- A. Caused by bad luck. Change fuses.
- B. If they keep blowing, check all power transistors that are heat-sunk on the side (as in the 19" version) or the bottom (as in the 13" version) of the monitor.

11. Extremely bright picture; spider-web like retrace lines floating around on the picture:

- A. Defective "Z" amplifier circuitry; check:
 - The brightness and contrast controls.
 - For peeled foil on the deflection board.
 - Semiconductors, etc.
- B. See symptom 4, diagnosis "B" and "C" ONLY. A bad EHT power supply or loose G2 wire can cause the same thing.

12. Hazy blob of light that shimmers on the screen.

- A. Open secondary on flyback winding.
- B. Failure of some component in the high voltage section.

13. Corners of the picture are missing:

- A. Yoke is too far back on the picture tube neck.

14. Picture is too far up, down, or not centered properly:

- A. Metallic yoke tabs need to be adjusted.

15. A shadowy image of the game remains on the screen, even after monitor is off:

- A. Picture tube has burnt phosphor.

16. 2 amp fuses keep blowing:

- A. Check the large heat-sinked power transistors.
- B. Check D608 and D708
- C. Check semiconductors, especially the transistors in the "X" and "Y" amplifiers.
- D. Bad yoke.

17. Video information is distorted: letters and figures are "crinkly" — like crumpled paper, and it shakes slightly:

- A. Bad 90 volt power being supplied by the EHT unit. If everything looks good, check the electrolytics.
- B. The regulator control (R905) may need adjusting.
 - On the Wells Gardner monitor, the anode voltage is supposed to read 14.5KV High Voltage. That's 14,500 volts with the beam current at zero. R905 adjusts this output voltage. To read this voltage, your meter needs a separate high voltage probe. Follow the directions **EXACTLY** as stated with the literature that comes with the probe. IF you don't,

or you touch something you shouldn't, **you're dead**. If this scares you, have someone qualified (a technician) perform this adjustment for you. Better SAFE than sorry.

- In the case of the Electrohome monitor, the adjustment is complex and, of course, **potentially DANGEROUS**. Basically, the Electrohome anode voltage from the "flyback" and rectifier is supposed to be set at 12,000 volts with the beam current at zero. That's right — **THOUSANDS** of volts! To read this voltage, your meter needs a separate high voltage probe. Follow the directions **EXACTLY** as stated with the literature that comes with the probe. IF you don't or you touch something you shouldn't, **you're dead**. If this scares you, have someone qualified (a technician) perform this adjustment for you. Better SAFE than sorry.

If you are still unsure, it may be best if you call Electrohome at (519) 744-7111 and obtain exact information from one of their staff engineers.

Guide To Schematic Symbols

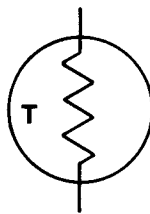

THERMISTOR
(POLARITY DOESN'T MATTER)

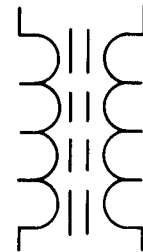

IRON CORE TRANSFORMER
(SUCH AS A FLYBACK)



INDUCTOR, COIL, CHOKE
(POLARITY DOESN'T MATTER)



FUSE
(POLARITY DOESN'T MATTER)



OR
GROUND

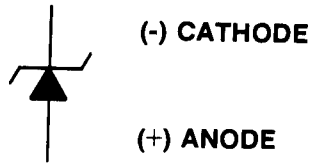

ZENER DIODE

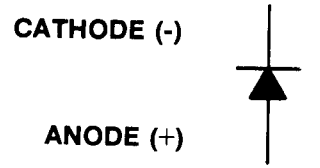

DIODE



VARIABLE RESISTOR, POT, CONTROL
(POLARITY DOESN'T MATTER)



RESISTOR
(POLARITY DOESN'T MATTER)

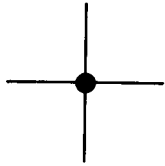

LINES ARE CONNECTED

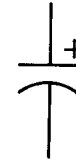

ELECTROLYTIC CAPACITOR

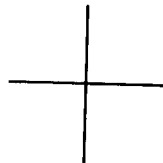

LINES ARE NOT CONNECTED

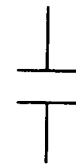

CAPACITOR
(POLARITY DOESN'T MATTER)

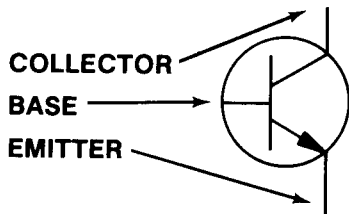

NPN TRANSISTOR

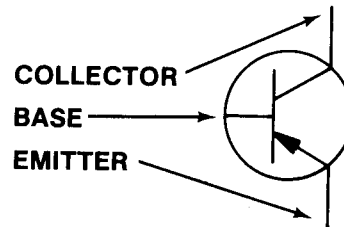

PNP TRANSISTOR

Troubleshooting

Troubleshooting monitors requires experience, patience, **and luck**. The first step is to match the symptom the monitor displays to the diagnosis next to it in the "SYMPTOM-DIAGNOSIS" subsection. This will pinpoint the circuit the problem is probably in, and often the parts to check. Next, the circuit should be visually inspected to see if there are any parts broken, burned, or if something is there that shouldn't be, like a loose screw, etc. Some parts go bad before others and should be checked first. In fact, following is the general order in which parts usually go bad:

1. Semiconductors (like transistors, diodes, and integrated circuits).
2. Fusible resistors.
3. Electrolytic capacitors.
4. Resistors.
5. Capacitors and coils.

Always remember that a monitor can bite like a snake. Even when it is turned off, capacitors hold voltage and will discharge it to you should you be touching chassis ground. The picture tube or CRT, itself, is a giant capacitor, so avoid the flyback anode plug hole. With the monitor on, the power supply circuit and/or the flyback, which puts out at least 12,000 volts, **CAN BE KILLERS!!** Avoid handling power transistors (usually output transistors), yoke terminals, and other high power components when the monitor is on.

WARNING: That picture tube is a bomb!

When it breaks, first it implodes, then it explodes. Large pieces of glass have been known to fly in excess of 20 feet in all directions. **DO NOT** carry it by the long, thin neck. Discharge its voltage to ground by shorting the anode hole to ground. Use a plastic handled screwdriver, connect one end of a wire with an alligator clip at each end to chassis ground and the other end to the metal shaft of the screwdriver. Using **ONE HAND ONLY** (put the other in your pocket) and touching **ONLY** the plastic handle of the screwdriver (**DO NOT TOUCH THE METAL SHAFT**) stick the blade of the screwdriver into the anode hole. Be prepared for a fairly loud pop and a flash. The longer the monitor has been turned off, the smaller the pop and dimmer the flash. But **BE CAREFUL**, picture tubes will hold a very

healthy charge for at least **a week** if not longer. Even after you've discharged it once, it may still carry a residual charge. It's better to be too careful than dead, which is why electronic equipment always carries stickers referring servicing to qualified personnel. Handle the side with the viewing screen against your chest when changing it. **ALWAYS** wear safety goggles when handling the picture tube.

To maintain the safety and performance of the monitor, always use exact replacement parts. For instance, the wrong components in the power supply can cause a fire, or picture distortion may result from the wrong transistor being placed in the deflection circuitry. Component manufacturers offer specification sheets which are useful for "mixing and matching", but why go through all the trouble? Order exact replacement parts! Service your monitor on a nonconductive firm table like wood, **NOT METAL**, and take off all of your jewelry just in case. With all this in mind, you are ready to begin troubleshooting.

Observe the picture carefully. Try to vary the appropriate control that would most likely affect your particular symptom. For example, if there is poor brightness or no picture, try turning up the brightness or contrast control. If the controls have no effect at all, chances are there is trouble with the control itself, the circuit it controls, or a nearby circuit that may be upsetting voltages. Go to the list of symptoms and determine with the schematic where the bad circuit is.

CAUTION:

Keep in mind that capacitors hold a charge as can the picture tube (for at least a week and usually longer), and could shock you.

First, check for obvious visual defects such as broken or frayed wires, solder where it is not supposed to be, missing components, burned components, or cracked printed circuit boards. If everything looks good up to this point, make sure that diodes, electrolytic capacitors, and transistors have their leads connected in the right polarity as shown on the schematic and the circuit board.

Turn on the power and measure the voltages at the leads of the active devices such as tubes, transistors, or integrated circuits. Any voltage that does not come within at least 10% to 15% of the voltage specified on the schematic indicates either a problem with that device or a component connected with it in the circuit. The next step is to use the ohmmeter to narrow down the field of possible offenders.

To test a transistor, one lead of the ohmmeter is placed on the base; and the other lead placed just on the emitter, then on the collector. A normal transistor will read either high resistance (infinite), or little resistance (400 to 900 ohms), depending on the polarity of this type transistor. Then the leads should be switched, one remaining on the base, and the other switched from the emitter to the collector. Now the opposite condition should result: the resistance should be infinite if it was lower when the other lead was on the base. Consistently infinite readings indicate an open, and a short is demonstrated by 0-30 ohms on most of these test readings. Finally, place one lead on the collector, then the other on the emitter. No matter which lead is used, there should be infinite resistance. Any lower reading, such as 50 ohms (which is typical on a bad transistor), indicates a short.

This all sounds pretty confusing, but a little experience on a good transistor will make you an expert in no time. Usually, the lowest ohmmeter setting is used for testing transistors. Once in a great while a transistor may check out good on this test, but may actually be "leaky" or break down only on higher voltages. If in doubt, change it. It is also wise to check the transistor out of the circuit just in case some component in the circuit is affecting the ohmmeter reading.

A diode is tested like a transistor except it only has two leads. Again, there should be high resistance one

way and little resistance the other. If it tests bad, take one lead out of the circuit in case some component is messing up the ohmmeter reading.

NOTE: DO NOT leave soldering equipment on the leads too long since all semiconductors, especially integrated circuits, are easily destroyed by heat.

Without special equipment, integrated circuits are checked by verifying the proper DC voltage on the pins and the correct AC wave form using an oscilloscope. **BE CAREFUL:** Shorting their pins can easily destroy them.

Resistors are checked with an ohmmeter and should usually be within ten percent of the value stated on them and on the schematic. You may have to desolder one lead from the printed circuit board. If you wreck the foil on the board, carefully solder a small wire over the break to reconnect the conductive foil.

Capacitors are tricky. Their resistance goes up when checked with an ohmmeter which shows a charging action. As they suck up current from the meter, the voltage goes up and so does the resistance. If you are sure a particular circuit is giving you a problem and everything else checks out O.K., Electrolytic capacitors are prime suspects. Substitute a new one and keep your fingers crossed.

Theory of Operation

To understand what goes on inside the monitor, large general groups of circuits will be examined instead of laborously analyzing the branches and small circuits that make up these groups. This will help avoid confusion and aid in a basic, concrete, knowledge of what makes up a monitor.

THE POWER SUPPLY

The best way to begin explaining the innards of the X-Y monitor is at its beginning or the inputs to the monitor. Ignoring the ground or common tie points for many of the components, which represents zero voltage, there is 30 volts AC going in pins seven and ten of P100 — the input jack. These voltages meet at DB100 which is a device that has four diodes in it. The 30 volts AC means the voltage and current alternate or jump up and down going positive and negative with zero voltage in between. DB100 and the capacitors immediately after it make up the power supply. Most of the circuits in the monitor can't use power that jumps up and down since your picture would do the same thing. DB100 chops up the wave form and capacitors C100 and C101 build up the power that DB100 chops up. The capacitors then

leak it out so the power is smooth and not varying. If any component fails in the circuit, the usual result is blown fuses, burning in this area, or just less power. The power supply starts the whole ball rolling, but remember that other circuits build up voltages that can be tapped for those circuits that need more than this thirty plus thirty volts AC from the game transformer.

THE "X" AND "Y" AMPLIFIERS —

Let's go back to the input jack, P100, again. Along with the grounds and the two 30 volt AC inputs is the "X" and "Y" channel video information. The "X" input is about 10 volts AC and the "Y" input is about 7.5 volts AC. The "X" channel information represents parts of objects from **LEFT** to **RIGHT** on the screen. The "Y" channel information represents parts of objects from **TOP** to **BOTTOM** on the screen. To get **complete objects**, then, you **MUST** have both the "X" and "Y" inputs. If this is so, then why aren't the input voltages equal? Well, notice how a T.V. tube is shorter than it is wide? The up and down voltages ("Y" input = ± 7.5 volts AC) don't need as much as the side to side voltages ("X" input = ± 10 volts AC).

If we divide the picture into four quadrants, the responsibilities of the "X" and "Y" amplifiers may be seen more clearly:

The **upper left** quadrant is represented by "-X" and "+Y" information.

The **upper right** quadrant is represented by "+X" and "+Y" information.

The **lower left** quadrant is represented by "-X" and "-Y" information.

The **lower right** quadrant is represented by "+X" and "-Y" information.

So let's say your monitor only has the right side of the picture and the left side is missing. The top and bottom right of the screen has "+X", "+Y", and "-Y" information. The left side has "-X", "+Y", and "-Y" information. But since the right side is O.K., obviously the only information missing is "-X". Therefore, there's got to be a problem somewhere in the "X" amplifier.

From P100, the "X" or "Y" signals each go through a resistor and the linearity control of their respective channels. The Wells Gardner monitor only has **one** linearity control per channel while the Electrohome monitor has **two** linearity controls per channel. These controls are supposed to be set at the factory. But sometimes they need additional adjusting. The best way to do this is to get a test pattern on the monitor screen, remove the glue holding the control adjustments in place, vary the controls until the size is right and the lines are nice and straight, and then re-glue the control adjustments so they can not move.

After the linearity controls, the rest of the circuitry just corrects the signal for the picture tube and amplifies it. The output power transistors (two for each channel) are heat-sinked on the bottom or the side of the monitor chassis. These feed the "X" and "Y" signals in the form of current to the yoke. The yoke then puts out two invisible electromagnetic fields or forces. These fields pull the stream of electrons that is spit out of the neck of the picture tube to the various quadrants of the monitor screen where they will write or paint a picture. Just as you may use a magnet to pull nails across a table, so does the yokes magnetic field pull the electron beam all over the picture tube screen to write the picture. The "X" and "Y" information we talked about earlier is what tells the electron beam **WHERE** to write or paint the picture. When the electron beam hits the phosphor coating on the back side of the front of the picture tube or screen, the phosphor glows in proportion to the electron beam intensity. In other words, the more electrons in the beam, the brighter the light that comes from the screen of the picture tube where it is being hit by the electron beam. This varying beam intensity is the function of the "Z" amplifier.

THE "Z" AMPLIFIER

At pin one of P100, the "Z" amplifier signal voltage is sent to the base of Q504 in the "Z" amplifier circuit. This circuit amplifies the AC "Z" signal and is then sent to the cathode of the picture tube. This varying "Z" signal voltage in turn varies the intensity of the electron beam producing at least eight different amounts of brightness or "eight gray scale steps" as the engineers would say.

In case the "X" and "Y" signals are missing, there is a 90 volt DC power failure — from the high voltage circuitry that feeds the "Z" amplifier, or if any other missing signal condition should occur, the "spot killer" circuitry comes on to effectively turn off the electron beam thus keeping the phosphor from being burned. At the same time, the light emitting diode turns on informing you of this. If the "spot killer" didn't come on when any of the above conditions exists, the electron beam wouldn't be moved around and the phosphor in the center of the screen would be burned from the intense electron beam that is hitting it without moving. Transistors Q500 through Q502 and their circuitry affect the voltages on Q503 to turn the beam current off. This **DOES NOT** mean you have automatic protection against CRT burns from too much brightness. In fact, it would probably be a good idea to keep the brightness and contrast controls **TURNED DOWN** to the point where the game looks good but not too bright. If the picture is way too bright, fine spider web-like retrace lines will follow the figures wherever they move and you are headed for a burnt CRT. The brightness control affects the DC voltage between the cathode and G1 of the picture tube. The contrast control varies the amount of signal to the cathode. Both control picture intensity.

THE HIGH VOLTAGE GENERATOR — OR — EHT SUPPLY

On the side of your monitor is a box-like cage with a wire that goes to the CRT. This is the EHT supply. It performs several functions, one of which is to supply the high voltage for the CRT.

The input to the EHT supply is at pin eight of P900 where 40 volts AC is fed through a large resistor, R900. Actually, this is a **VERY** important resistor because it limits the current to the oscillator, keeping it from taking off on its own and increasing the high voltage to the point where X-rays are emitted from the CRT, which is **DEFINITELY NOT GOOD**.

Did we mention an oscillator? What's an oscillator? Well, in this case, it is made up of: transistor Q903, the primary winding of the "flyback" transformer, and a few other components that toss the voltage back and forth (oscillate) 25,000 times each second. By doing this, it electromagnetically induces a bigger voltage in the "flyback" transformers secondary winding

since it is bigger. This voltage is rectified (chopped up) by diode D904 to get 12,000 volts DC in Electrohome monitors and 14,500 volts DC in Wells Gardner monitors. This voltage is used to light up the CRT (picture tube). The other transistors, from Q900 to Q902 and their circuit components keep the power to the oscillator steady or regulated, as they say in engineering. There is an adjustment control, R905, to make certain the oscillator is fed the proper power.

The "flyback" transformer also has an additional secondary winding which generates more voltage to power other circuits. At pin three of P900 there is about 400 volts DC for focus voltage to the CRT. This can be adjusted with R909, the focus control. From pin five at the other side of the "flyback" transformer secondary winding, there is 90 volts DC for the "Z" amplifier circuit. In between pins three and five of P900 there are two diodes and capacitors that change the AC from the "flyback" secondary winding to DC just like the power supply. In fact, that's just what it is, a "mini power supply".

THE CRT — (PICTURE TUBE)

The CRT has already been described indirectly. However, to make a picture or turn the CRT on, certain voltages are needed. Otherwise it won't work. These are: about 6 volts AC (**note that's AC**) is needed for the heater filament in the tube neck to light up; the electron beams intensity must be controlled by the "Z" amplifiers signal which is applied to the CRT's cathode; there must be voltage at G1 of the CRT for brightness; there should be about 400 volts DC at G2; there should be focus voltage which varies but can go as high as 400 volts DC; and there should be high voltage at the anode of the CRT which runs into the **thousands of volts (this voltage can jump almost one inch - so BE CAREFUL!!)**

Always remember that a monitor can bite like a snake. Even when it is turned off, capacitors hold voltage and will discharge it to you should you be touching chassis ground. The CRT or picture tube, itself, is a giant capacitor, so avoid the flyback anode plug hole. With the monitor on, the power supply circuit and/or the flyback, which puts out at least 12,000 volts, **CAN BE KILLERS!!** Avoid handling power transistors (usually output transistors), yoke terminals, and other high power components when the monitor is on.

WARNING: That picture tube is a bomb!

When it breaks, first it implodes, then it explodes. Large pieces of glass have been known to fly in excess of 20 feet in all directions. **DO NOT** carry it by the long, thin neck. Discharge its voltage to ground by shorting the anode hole to ground.

Use a plastic handled screwdriver, connect one end of a wire with an alligator clip at each end to chassis ground and the other end to the metal shaft of the screwdriver. Using **ONE HAND ONLY** (put the other in your pocket) and touching **ONLY** the plastic handle of the screwdriver (**DO NOT TOUCH THE METAL SHAFT**) stick the blade of the screwdriver into the anode hole. Be prepared for a fairly loud pop and a flash. The longer the monitor has been turned off, the smaller the pop and dimmer the flash. But **BE CAREFUL**, picture tubes will hold a very healthy charge for at least a **week** if not longer. Even after you've discharged it once, it may still carry a residual charge. It's better to be too careful than dead, which is why electronic equipment always carries stickers referring servicing to qualified personnel. Handle the side with the viewing screen against your chest when changing it. **ALWAYS** wear safety goggles when handling the picture tube.

WHAT TO DO WHEN YOU DON'T KNOW WHAT TO DO — AND OTHER TIPS

If you are totally confused about where to begin to hunt for a problem, and can't find the problem in the "SYMPTOM DIAGNOSIS" subsection, there may be another way to proceed.

Take a **VOLTMETER** and (if possible) an oscilloscope and begin probing the jacks. You can start with the input jack to the monitor. Using the oscilloscope, make sure both the "X" and "Y" information is present (which it isn't during the "SOUND" test).

NOTE: It is advisable to use one of the games test patterns (obtained when you put the game into the Self-Test mode) when using the oscilloscope. **The simple diamond one is a good choice.** This way the "X" and "Y" information at the above jack isn't changing and a recognizable wave form is easy to see if it's there. The DC voltages tend to jump around like crazy when the game is being played or is running through its **ATTRACT** mode, so, using the test pattern tends to keep them still.

Next, use the volt meter to make sure the other voltages are present at each pin. Similarly, you proceed to P500 on the deflection board, and P900 on the EHT unit to make sure all the correct voltages are present. Use the schematic to determine what the correct voltages should be.

Check the pins on the CRT to be sure the voltages are getting this far. If everything looks good to this point, perhaps the CRT is bad. **DO NOT** check the anode voltage unless you have a special high voltage probe or you may wind up repairing X-Y monitors in heaven.

DO NOT BE FOOLED by the silent operation of the monitor. Regular T.V. sets and monitors buzz and crackle a lot when they're operating — this is normal for them. **BUT**, Vectorbeam monitors are noiseless unless something is wrong.

Whatever you do, **ALWAYS** read the literature that comes with any test equipment you use so that you will not damage the equipment, the monitor, and most of all **YOURSELF**.

PARTS INTERCHANGEABILITY

Quite a few of the parts between the Electrohome and the Wells Gardner monitors may be swapped. The CRT's for example are completely interchangeable. Also, many of the transistors used in each monitor are the same. Certain critical components in the power supply and the EHT unit are dangerous to interchange. The best thing to do is to compare both monitors parts lists to see if the descriptions of any two particular parts you want to swap match exactly. Substitution manuals are available for transistors and semiconductors, but you never know about them. Sometimes they work and sometimes they don't, depending on the critical circuit parameters. If in doubt, order exact replacement parts.

Schematic — Deflection/Power/Z amp

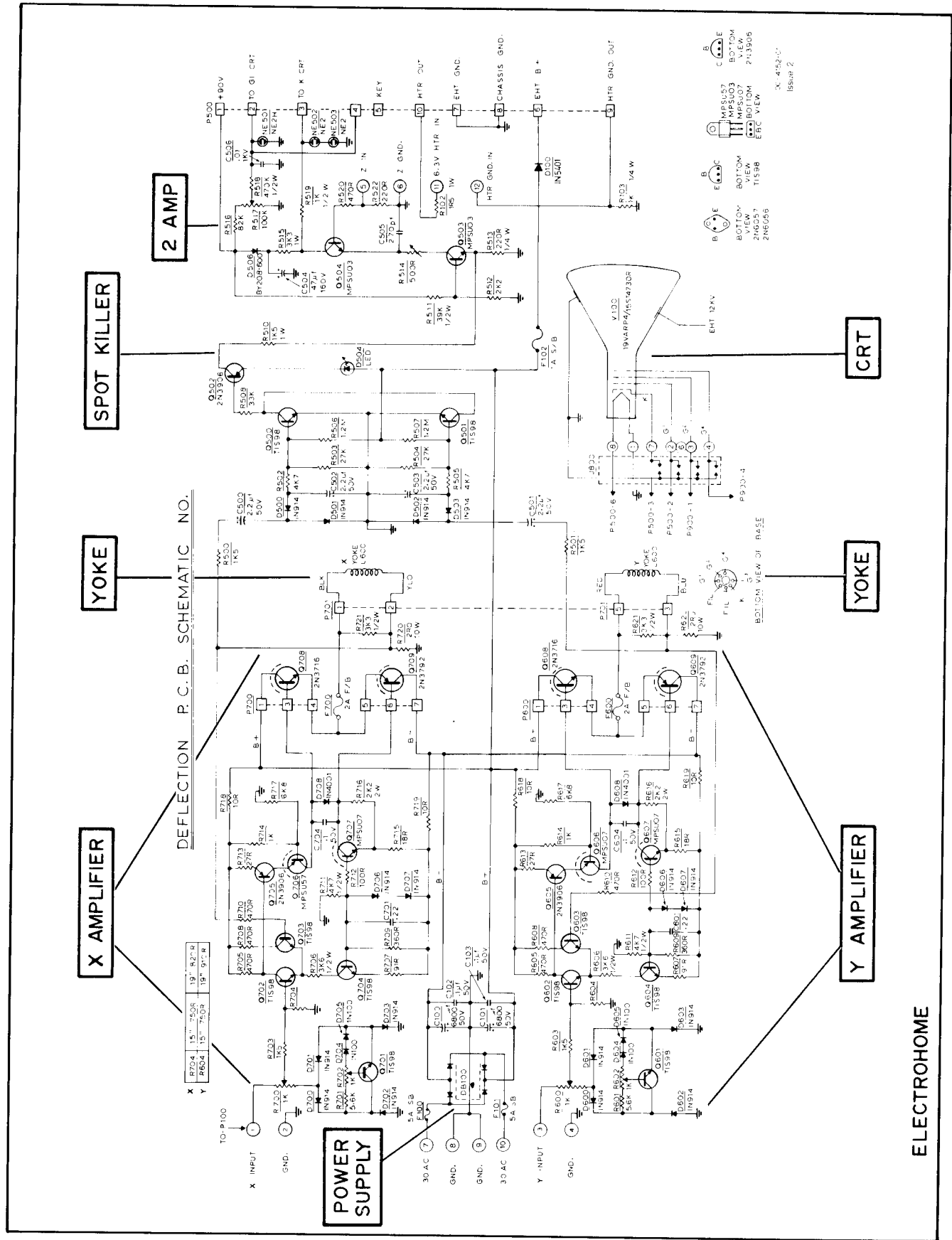

Schematic — EHT Supply

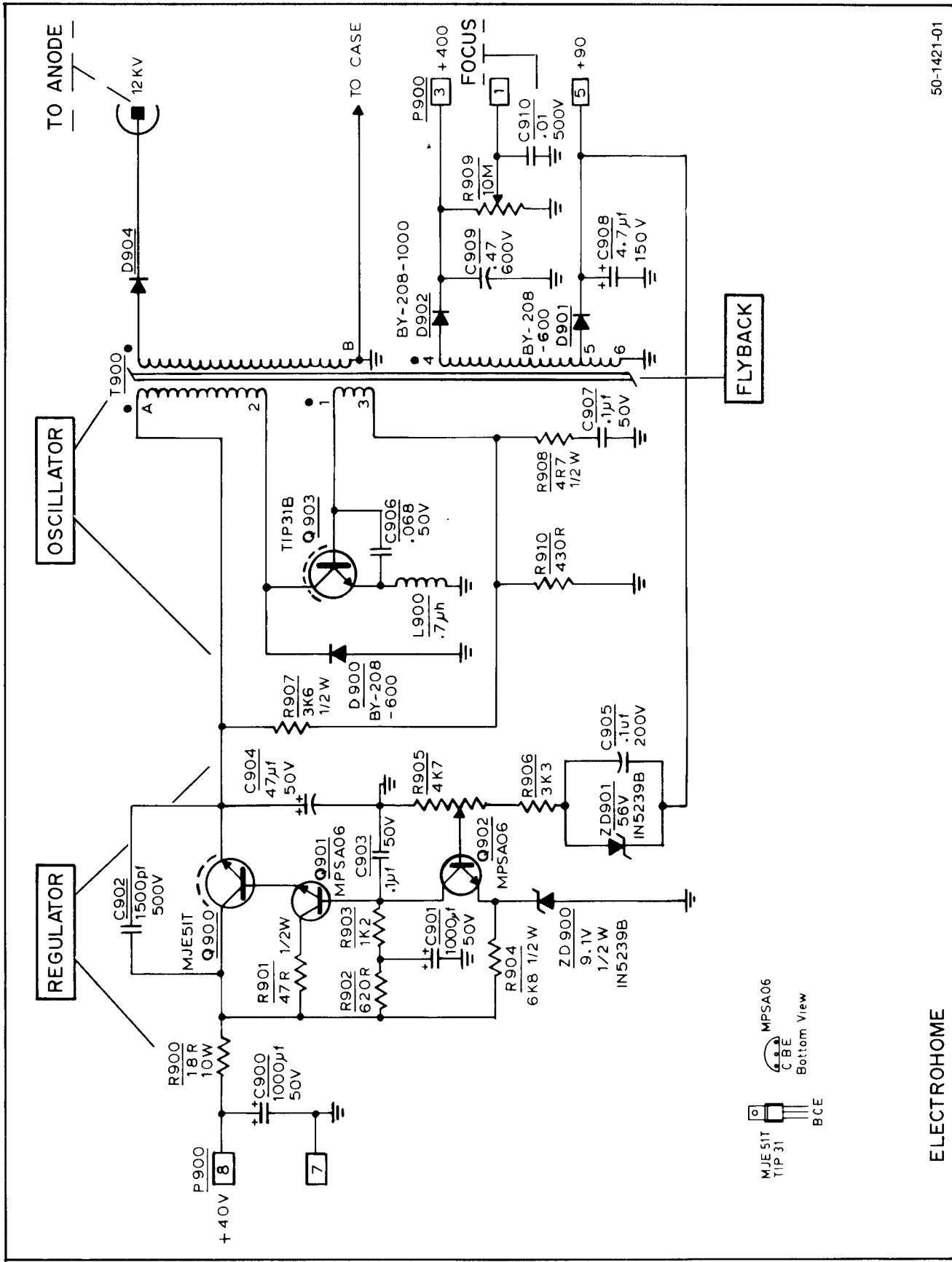

50-1421-01

ELECTROHOME

