

YAMAHA

GENERAL
MIDI
XG

TONE GENERATOR
MUSO

OWNER'S MANUAL

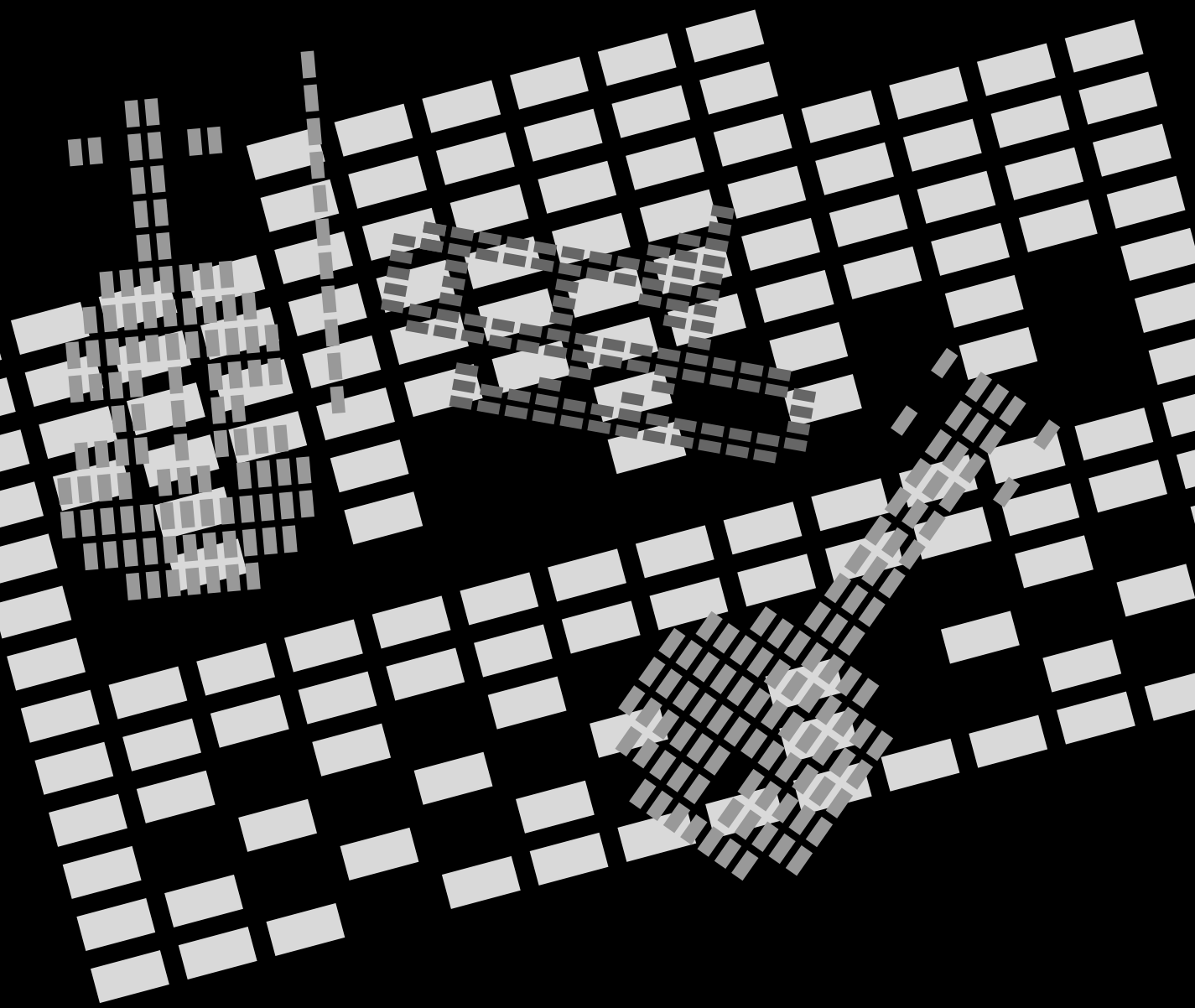

FCC INFORMATION (U.S.A)

1. **IMPORTANT NOTICE : DO NOT MODIFY THIS UNIT!**

This product, when installed as indicated in the instructions contained in this manual, meets FCC requirements. Modifications not expressly approved by Yamaha may void your authority, granted by the FCC, to use the product.

2. **IMPORTANT:** When connecting this product to accessories and/or another product use only high quality shielded cables. Cable/s supplied with this product **MUST** be used. Follow all installation instructions. Failure to follow instructions could void your FCC authorization to use this product in the USA.

3. **NOTE:** This product has been tested and found to comply with the requirements listed in FCC Regulations, Part 15 for Class "B" digital devices. Compliance with these requirements provides a reasonable level of assurance that your use of this product in a residential environment will not result in harmful interference with other electronic devices. This equipment generates/uses radio frequencies and, if not installed and used according to the instructions found in the user's manual, may cause interference harmful to the operation of other electronic devices. Compliance with FCC regulations does not guarantee that interference will not occur in all installations. If this product is found to be the source of interference, which can be determined by turning the unit "OFF" and "ON", please try to eliminate the problem by using one of the following measures:

Relocate either this product or the device that is being affected by the interference.

Utilize power outlets that are on different branch (circuit breaker or fuse) circuits or install AC line filter/s.

In the case of radio or TV interference, relocate/reorient the antenna. If the antenna lead-in is 300 ohm ribbon lead, change the lead-in to co-axial type cable.

If these corrective measures do not produce satisfactory results, please contact the your local retailer authorized to distribute this type of product. If you can not locate the appropriate retailer, please contact Yamaha Corporation of America, Electronic Service Division, 6600 Orangethorpe Ave, Buena Park, CA 90620

* The above statements apply **ONLY** to those products distributed by Yamaha Corporation of America or its subsidiaries.

CANADA

THIS DIGITAL APPARATUS DOES NOT EXCEED THE "CLASS B" LIMITS FOR RADIO NOISE EMISSIONS FROM DIGITAL APPARATUS SET OUT IN THE RADIO INTERFERENCE REGULATION OF THE CANADIAN DEPARTMENT OF COMMUNICATIONS.

LE PRESENT APPAREIL NUMERIQUE N'EMET PAS DE BRUITS RADIOELECTRIQUES DEPASSANT LES LIMITES APPLICABLES AUX APPAREILS NUMERIQUES DE LA "CLASSE B" PRESCRITES DANS LE REGLEMENT SUR LE BROUILLAGE RADIOELECTRIQUE EDICTE PAR LE MINISTERE DES COMMUNICATIONS DU CANADA.

* This applies only to products distributed by Yamaha Canada Music LTD.

ADVARSEL!

Lithiumbatteri—Eksplussionsfare ved fejlagtig håndtering. Udskiftning må kun ske med batteri af samme fabrikat og type. Levér det brugte batteri tilbage til leverandoren.

VARNING

Explosionsfara vid felaktigt batteribyte. Använd samma batterityp eller en ekvivalent typ som rekommenderas av apparattillverkaren. Kassera använt batteri enligt fabrikantens instruktion.

VAROITUS

Paristo voi räjähtää, jos se on virheellisesti asennettu. Vaihda paristo ainoastaan laitevalmistajan suosittelemaan tyyppiin. Hävitä käytetty paristo valmistajan ohjeiden mukaisesti.

Welcome to the MU50

Congratulations and thank you for purchasing the Yamaha MU50 Tone Generator!

The MU50 is an advanced tone generator providing **737 high-quality Voices**, full **General MIDI compatibility** — including Yamaha's new **XG-MIDI** — plus flexible **computer interfacing** in a highly **compact and portable** package.

With the convenient built-in **host computer interface** and **MIDI terminals**, the MU50 is ideal for any computer music system — from connection to a simple laptop to integration in a complete MIDI studio. With its large LCD and the intuitive graphic controls on the display, the MU50 is remarkably easy to use.

The MU50 also features **16 Part multi-timbral capacity** and full **32-note polyphony** for playback of even the most sophisticated song data. A special **Performance mode** gives you flexible four-Voice operation, for live performance applications. Built-in **digital multi-effects** give you enormous versatility in “sweetening” the sound. Plus, the convenient **INPUT jack** allows you to connect an external audio source, and mix that source's signals with the MU50's Voices. What's more, the MU50 provides a host of comprehensive, yet easy-to-use **editing tools** for getting just the sound you need.

Unpacking

Your MU50 package should include the items listed below. Make sure that you have them all. Also, write down the serial number of your MU50 in the box below, for future reference.

MU50	Serial No.:
PA-1207 AC Power Adaptor*	
Owner's Manual	

* Power supply recommendation may vary from country to country.
Please check with your nearest Yamaha dealer for further details.

Table of Contents

Welcome to the MU50	ii
Unpacking	iii
Table of Contents	iv
How to Use This Manual	vi
Precautions	vii
The Controls of the MU50	1
The MU50 — What It Is and What It Can Do	4
What It Is	4
About General MIDI	4
What It Can Do...	5
Using With a MIDI Keyboard	5
Using With a Computer or Sequencer	5
About the Modes of the MU50	6
Play Modes and the Part Controls	7
Utility Mode	10
Part Edit Mode	10

GUIDED TOUR

Setting Up Your MU50	12
What You'll Need	12
Making the Connections	12
Powering Up and Playing the Demo Song	14
Playing the Demo Song	15
Selecting Voices	17
Changing the Voice Bank	18
Selecting Voices From Your MIDI Keyboard	19
Changing Some of the Settings — Part Controls	20
Selecting another Part and changing its MIDI channel	20
Changing the Volume and Pan settings of a Part	22
Using Mute/Solo	23
Using the INPUT Jack	24
Setting Up the MU50 in Your Music System	25
Connecting With a Computer	25
Macintosh	25
IBM PC and Clones	26
Connecting to Other MIDI Devices	27
Using the MU50 with a MIDI Data Storage Device	29
Data Flow Block Diagram	30
MIDI/Computer Connecting Cables	31

REFERENCE

Multi Mode	34
Multi Play Mode	35
Part Controls	35
Single Part Control	36

Selecting Single Part Control	36
Editing in Single Part	36
All Part Control	40
Editing in All Part	40
Multi Edit Mode	43
Filter	43
EG (Envelope Generator)	45
Vibrato	50
Others	52
Drum Setup Controls	61
Calling Up the Drum Setup Menu	61
Drum Setup Parameters	62
Performance Mode	66
Performance Play Mode	66
Selecting a Performance and its Individual Parts	67
Performance Part Control	69
Single Part	69
All Part	72
Performance Edit Mode	75
Common	75
Part	78
Filter	79
EG	79
Vibrato	80
Others	80
Copy and Store Operations	83
Copy	83
Store	84
Effect Edit Mode	86
Reverb (REV)	86
Chorus (CHO)	88
Variation (VAR)	89
About the Effect Connections — System and Insertion	92
Utility Mode	95
System Functions	95
Dump Out Functions	98
Saving and Restoring Data via MIDI	98
Saving and Restoring Data via TO HOST	98
Initialize Functions	101
Demo Song Play (DEMO)	104
Sound Module Mode (MODE)	105

APPENDIX

XG	108
Troubleshooting	123
Error Messages	124
Specifications	125
Glossary	127
Index	129

How to Use This Manual

You are probably eager to try out your new MU50 Tone Generator right away and hear what it can do, rather than have to read through a lot of instructions before you can even get a sound out of it.

However, to get the most out of your MU50, we strongly suggest that you read the following sections in the order given:

1) Precautions

This gives you important information on how to care for your new MU50, how to avoid damaging, and how to ensure long-term, reliable operation.

2) The Controls of the MU50

This section introduces you to the panel controls and connectors.

3) The MU50 — What It Is and What It Can Do

This briefly provides an overview of the functions and features of the MU50 and offers some important hints on how you can use it effectively.

4) Guided Tour

This very important section gets you started using your new MU50. It helps you set up the instrument, play it, and use some of the more important functions and features. The hands-on experience you gain in this section will help you navigate through the other sections of the manual.

5) Setting Up the MU50 in Your Music System;

Using the MU50 with a Computer

These sections (within the Guided Tour) provide all you need to know to effectively integrate the MU50 into your present computer music system.

6) Reference

Once you're familiar with everything above, lightly go over this comprehensive guide to all editing functions. You won't need (or want) to read everything at once, but it is there for you to refer to when you need information about a certain feature or function.

7) Appendix

Finally, use the sections in the Appendix as necessary. For example, the Index will come in handy when you need to quickly find information on a specific topic. Other sections, such as the **Glossary**, **Troubleshooting** and **Error Messages** provide additional useful information.

Precautions

Your MU50 will give you years of reliable service if you follow the simple precautions below:

■ LOCATION

Keep the instrument away from locations where it is likely to be exposed to high temperatures (such as direct sunlight) or humidity. Also avoid locations which are subject to excessive dust accumulation or vibration which could cause mechanical damage.

■ USE THE CORRECT POWER ADAPTOR

Use only the recommended PA-1207 Power Adaptor for supplying power to the instrument. Use of another adaptor may cause serious damage to the instrument or the adaptor itself.

■ MAKE SURE POWER IS OFF WHEN MAKING OR REMOVING CONNECTIONS

To prevent damage to the instrument and other connected equipment, always turn off the power prior to connecting or disconnecting cables. Also, turn the power off when the instrument is not in use, and disconnect the power adaptor during electric storms.

■ HANDLE THE INSTRUMENT WITH CARE

Although the instrument has been constructed to withstand the rigors of normal use for optimum sturdiness and reliability, avoid subjecting it to strong physical shocks (such as dropping or hitting it). Since the MU50 is a precision-made electronic device, also avoid applying excessive force to the various controls. When moving the instrument, first unplug the power adaptor and all other cables to prevent damage to cords and jacks. Always unplug cables by gripping the plug firmly, not by pulling on the cable.

■ CLEAN WITH A SOFT, DRY CLOTH

Never use solvents such as benzine or thinner to clean the instrument, since these will damage the cabinet finish or dull the keys. Wipe clean with a soft, dry cloth. If necessary, use a soft, clean, slightly moistened cloth — making sure to wipe the case off again with a dry cloth.

■ ELECTROMAGNETIC INTERFERENCE

Avoid using the unit near televisions, radios or other equipment generating electromagnetic fields. Proximity to such equipment may cause the unit to malfunction, and may generate interference noise in the other appliance as well.

■ DO NOT OPEN THE CASE OR TRY REPAIRING THE INSTRUMENT YOURSELF

The instrument contains no user-serviceable parts. Never open the case or tamper with the internal circuitry in any way, since doing so may result in damage to the instrument. Refer all servicing to qualified Yamaha service personnel.

■ MIDI CABLES

When connecting the instrument to other MIDI equipment, be sure to use only high-quality cables made especially for MIDI data transmission. Also, avoid using cables longer than 15 meters, since long cables can result in data errors.

Yamaha is not responsible for damage caused by improper handling or operation.

The Controls of the MU50

Front Panel

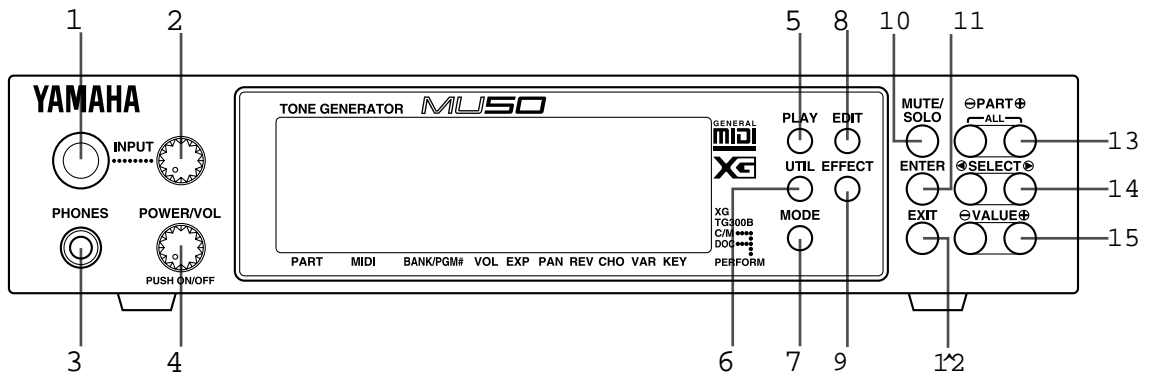

1 INPUT jack

For connection of an external audio source. (Accepts either stereo or mono 1/4" plugs.)

2 INPUT level control

For control of the INPUT audio level.

3 PHONES jack

For connection to a set of stereo headphones (mini-pin).

4 POWER/VOL control

Pressing this turns the power on and off. Turning it adjusts the overall volume of the MU50.

5 PLAY button

For entering the Play mode. (See page 34.)

6 UTIL (UTILITY) button

For entering the Utility mode. (See page 95.)

7 MODE button

For entering the Sound Module mode. (See page 34.)

8 EDIT button

For entering the Edit mode. (See pages 43, 75.)

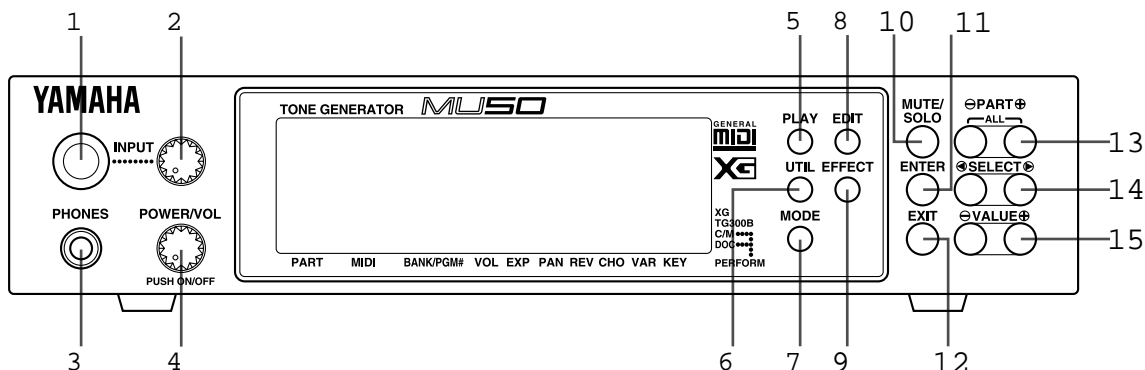

9 EFFECT button

For entering the Effect Edit mode. (See page 86.)

10 MUTE/SOLO button

Pressing this alternately mutes or solos the selected Part. (See page 23.)

11 ENTER button

For calling up menu items in the display and for executing certain functions and operations. Double-clicking this (pressing it twice quickly) calls up the System Exclusive or Control Change hexadecimal message for the current function and parameter value.

12 EXIT button

For leaving various display pages and returning to previous displays. Also for canceling certain functions and operations.

13 PART buttons

For selecting different Parts. In the Effect Edit mode, these can be used to switch among the different effects. Pressing these together enters and exits from All Part control. (See page 40.)

14 SELECT buttons

For selecting the various menu items, parameters and controls on the display.

15 VALUE buttons

For changing the value of a selected parameter or control.

Rear Panel

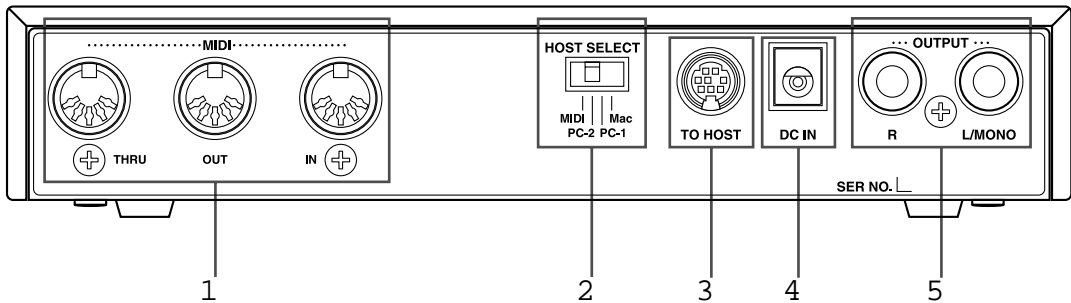

1 MIDI THRU, MIDI OUT and MIDI IN terminals

For connection to other MIDI devices, such as a MIDI keyboard, tone generator, sequencer, or to a computer that has a MIDI interface. MIDI IN is for input of MIDI data. MIDI OUT is for data dumps to another MIDI device, while MIDI THRU is for “daisy-chain” connection of additional MU50s or other MIDI instruments. (See page 12 for more information on MIDI connections.)

2 HOST SELECT switch

For selecting the type of host computer. (See page 12.)

3 TO HOST terminal

For connection to a host computer that does not have a MIDI interface. (See page 26.)

4 DC IN jack

For connection to the PA-1207 AC power adaptor.

5 OUTPUT R, L/MONO jacks (Right, Left/Mono)

For connection to a stereo amplifier/speaker system. When using a mono system, connect it to the L/MONO jack.

The MU50 — What It Is and What It Can Do

What It Is...

The MU50 is a compact, highly portable and easy-to-use tone generator. It features full General MIDI Level 1 compatibility with 128 General MIDI Voices and 1 drum kit. It also provides new XG-MIDI compatibility, with a total of 480 Voices and 11 drum kits. The MU50 has 32-note polyphony and is 16-Part multi-timbral. In other words, the MU50 features 16 different Parts, each with its own Voice, so that up to 16 different Voices can be sounded simultaneously.

The MU50 also has a TO HOST terminal for easy interfacing with a computer, allowing you to play the Voices using your favorite music software. This is where the advanced multi-timbral capabilities come in, letting you playing sophisticated arrangements using up to 16 different Voices at the same time.

The MU50 also features a special Performance mode, in which four Parts are played simultaneously over a single MIDI channel. Connected to a MIDI keyboard, this effectively gives you four tone generators in one. The MU50 gives you four sets of 32 factory-programmed Preset Performances plus 128 Internal Performance locations for your own original Performances.

About General MIDI

General MIDI is a new addition to the worldwide MIDI standard. MIDI, as you know, stands for Musical Instrument Digital Interface, and makes it possible for various electronic musical instruments and other devices to “communicate” with each other. For example, by connecting a sequencer to the MU50’s MIDI IN terminal, you could play back a song on the sequencer using the Voices of the MU50.

So, where does General MIDI fit in all of this? One of the most important features of General MIDI is in the standardization of Voices. This means that a song recorded in the General MIDI format can be played back on any General MIDI compatible tone generator and sound just as the composer intended. For example, if there is an alto sax solo in the song, it will be played by an alto sax Voice on the General MIDI tone generator (and not by a tuba or harpsichord!). Since the MU50 is fully compatible with General MIDI, you can take advantage of the vast wealth of musical material recorded in that format.

What It Can Do...

Here are a few ideas on how you can use the MU50. The list below is not comprehensive, but is meant to be a general guide to the possibilities and provide a starting point or springboard for your own creative ideas and explorations.

Using With a MIDI Keyboard

Use the MU50 as supplementary tone generator with your MIDI keyboard and play the Voices of both instruments in a layer together. Or, use the convenient Performance mode, and play four Voices on the MU50 at once. You can split the four Voices across the keyboard, playing each from a different register. Or you can create sophisticated velocity splits, in which a different Voice is heard depending on how strongly you play the keyboard. Or use keyboard and velocity splits together for even greater flexibility.

Using With a Computer or Sequencer

Home Studio Setup

The MU50 integrates instantly and easily into any existing setup. If you have a MIDI keyboard, computer and sequencing software, the MU50 with its high-quality Voices and multi-timbral capabilities can expand your home studio system.

Carry It With You

If you have a laptop computer (and sequencing software), simply connect the MU50, plug in some headphones and you've got a complete, high-powered music making system that's ready to go wherever you go. Use it for composing, arranging, practicing or making/playing demos for your band.

Multimedia

Since it's portable and compatible with General MIDI, the MU50 is a natural for multimedia applications. Bring it with you to a presentation — since the computer interface is built-in to the MU50, it hooks up instantly and easily to the computer's serial port or printer port, without the need for any other equipment.

About the Modes of the MU50

The MU50 has two main operating modes: Multi and Performance. In Multi mode, the MU50 is a 16-Part multi-timbral tone generator; in Performance mode, the MU50 effectively functions as four tone generators controlled over a single MIDI channel.

Which mode the MU50 is in depends on the selected Sound Module mode. If XG, TG300B, C/M or DOC are selected, the MU50 automatically sets itself to the Multi mode. When PERFORM is selected, the MU50 is in the Performance mode.

The various modes and the software compatibility each provides are described below:

XG: Provides compatibility with the XG format.

TG300B: Provides semi-compatibility with the GM Level 1 standard.

C/M: Provides semi-compatibility with computer music software.

DOC: Provides compatibility with DOC music software for the Yamaha Clavinova.

PERFORMANCE: Allows playing of four separate Parts simultaneously over a single MIDI channel.

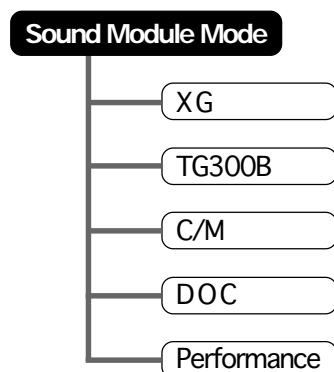

The bottom right of the display indicates the currently selected Sound Module mode.

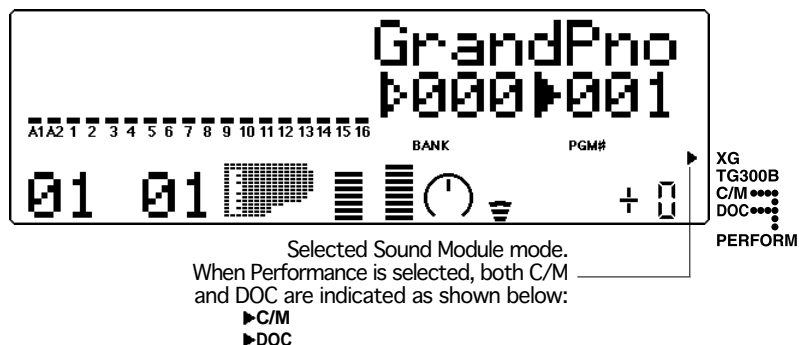

Play Modes and the Part Controls

Once the operating mode of the MU50 is set (Multi or Performance), there are two main ways you can use the MU50: playing and editing. In the Play modes, you play the Voices; in the various Edit modes, you change their settings.

Within the Play modes are the Part controls. These let you make basic settings for the Parts. The Single Part controls allow you to make independent settings for each Part, while the All Part controls allow you to change the overall settings of all Parts. (See page 35 for more information.)

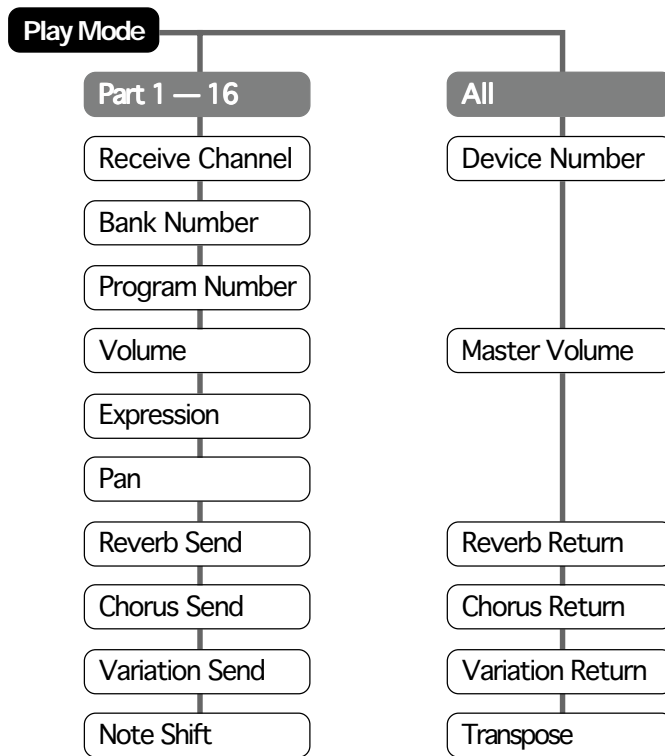

The MU50 has several different Edit modes, each with various menus and operations:

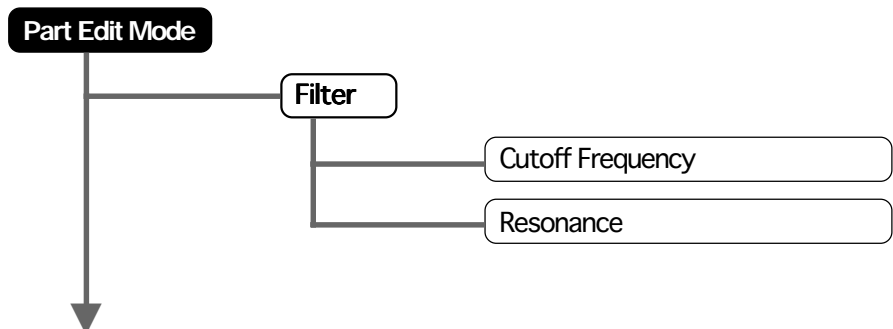

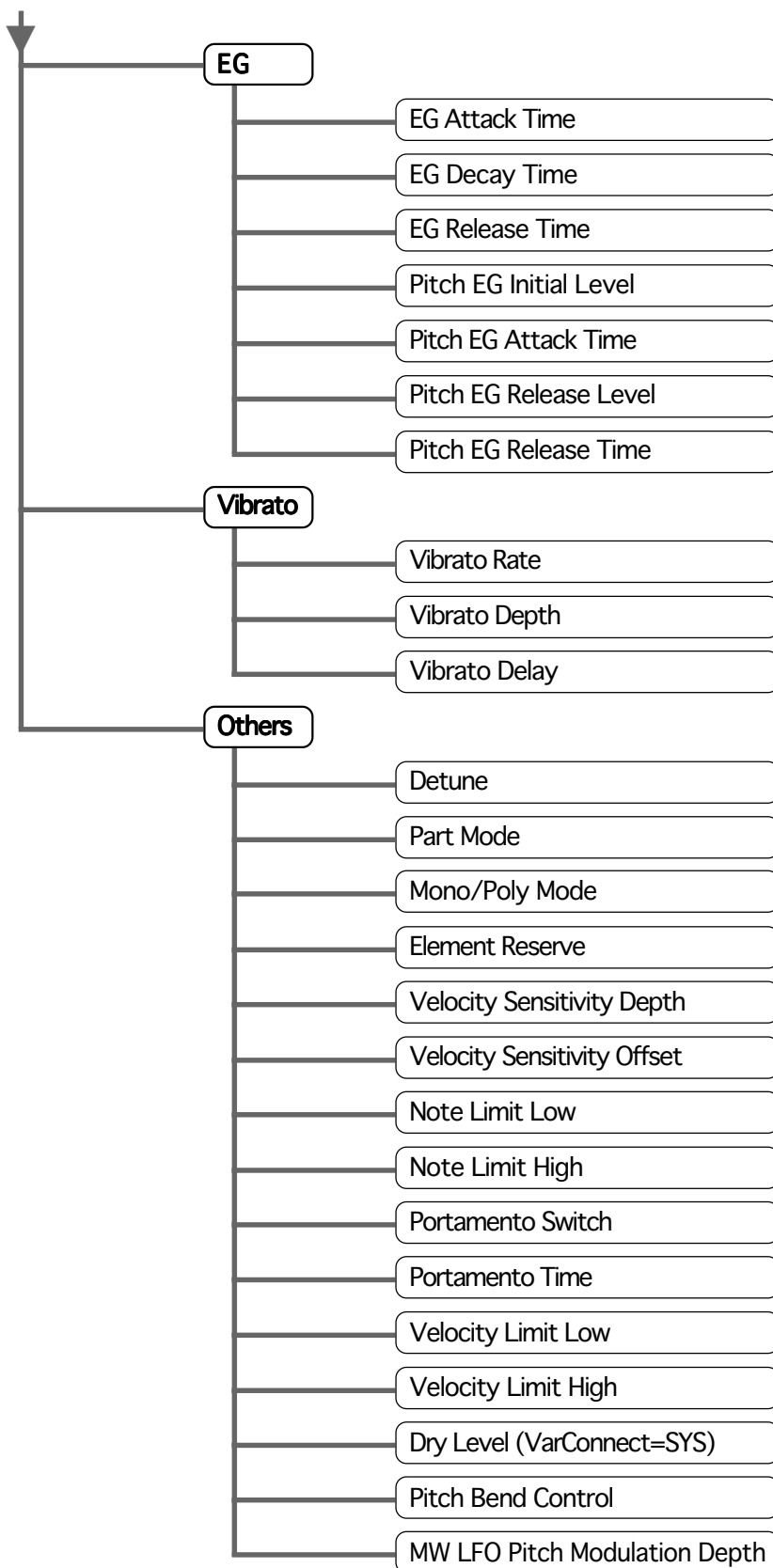

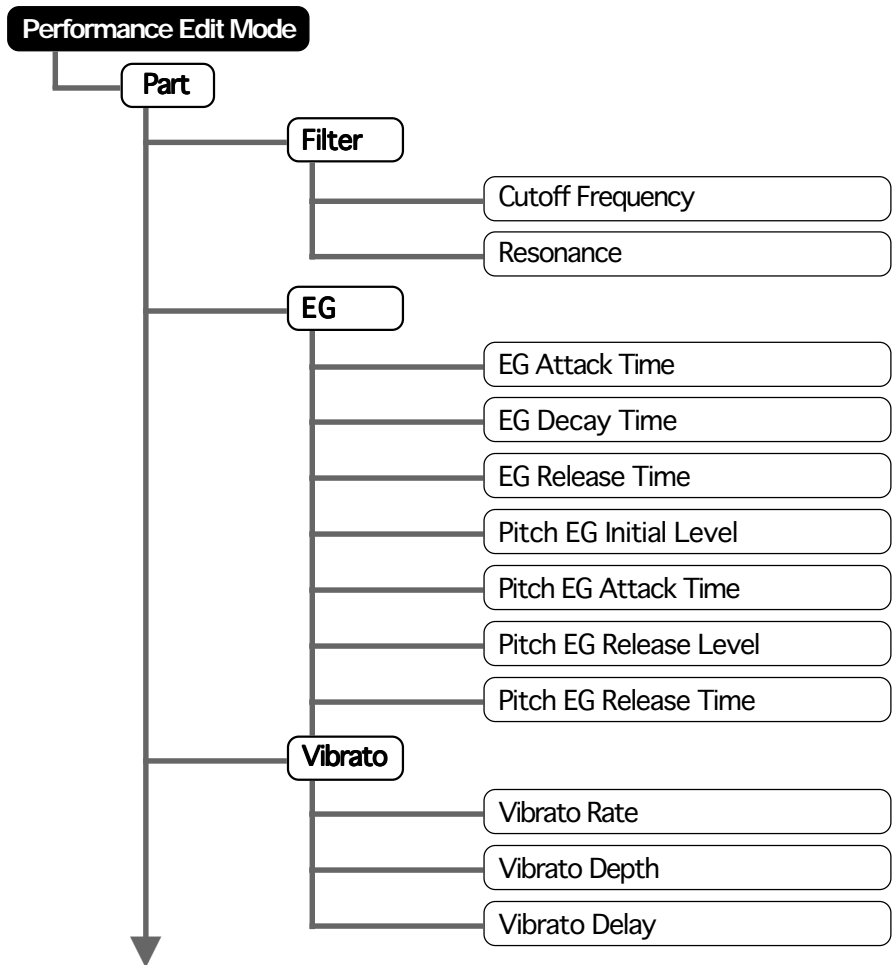
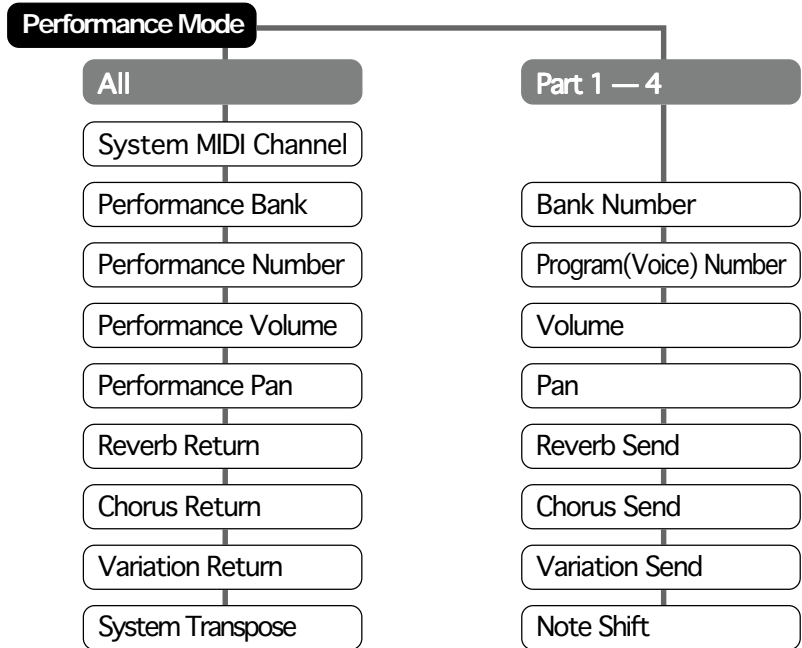

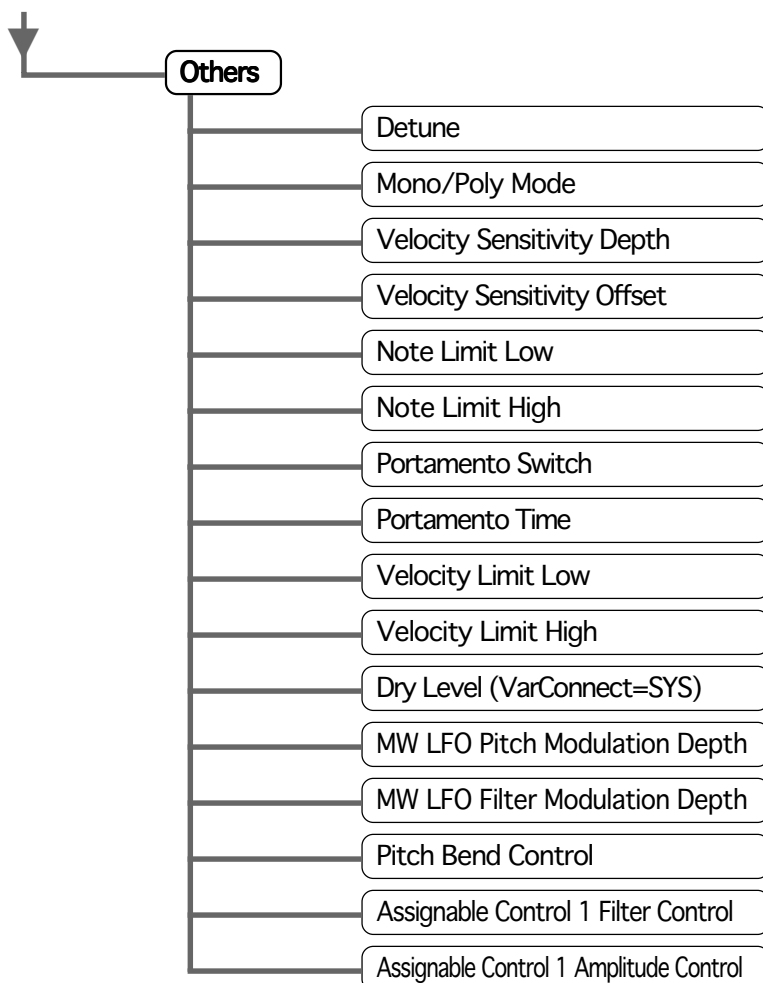

For more information on each of these modes and their menus, see the respective sections in the **Reference** section.

Utility Mode

The Utility mode lets you set functions related to the overall operation of the MU50, such as Master Tune, display Contrast and reception of certain MIDI messages that affect the entire instrument. Included also are miscellaneous operations, such as sending bulk data to a data storage device, initializing of the MU50 settings, and playing the special Demo song.

Part Edit Mode

The Part Edit mode allows you to change certain settings for each individual Part, such as those of the Filter, EG (Envelope Generator), and many other settings. The internal Voices can be sounded during editing, allowing you to hear the effects of your edits.

GUIDED TOUR

When using your MU50 for the first time, read through this short section of the manual. It guides you step-by-step in using many of the basic operations: setting the instrument up, connecting it properly to other equipment, and — most importantly — playing it.

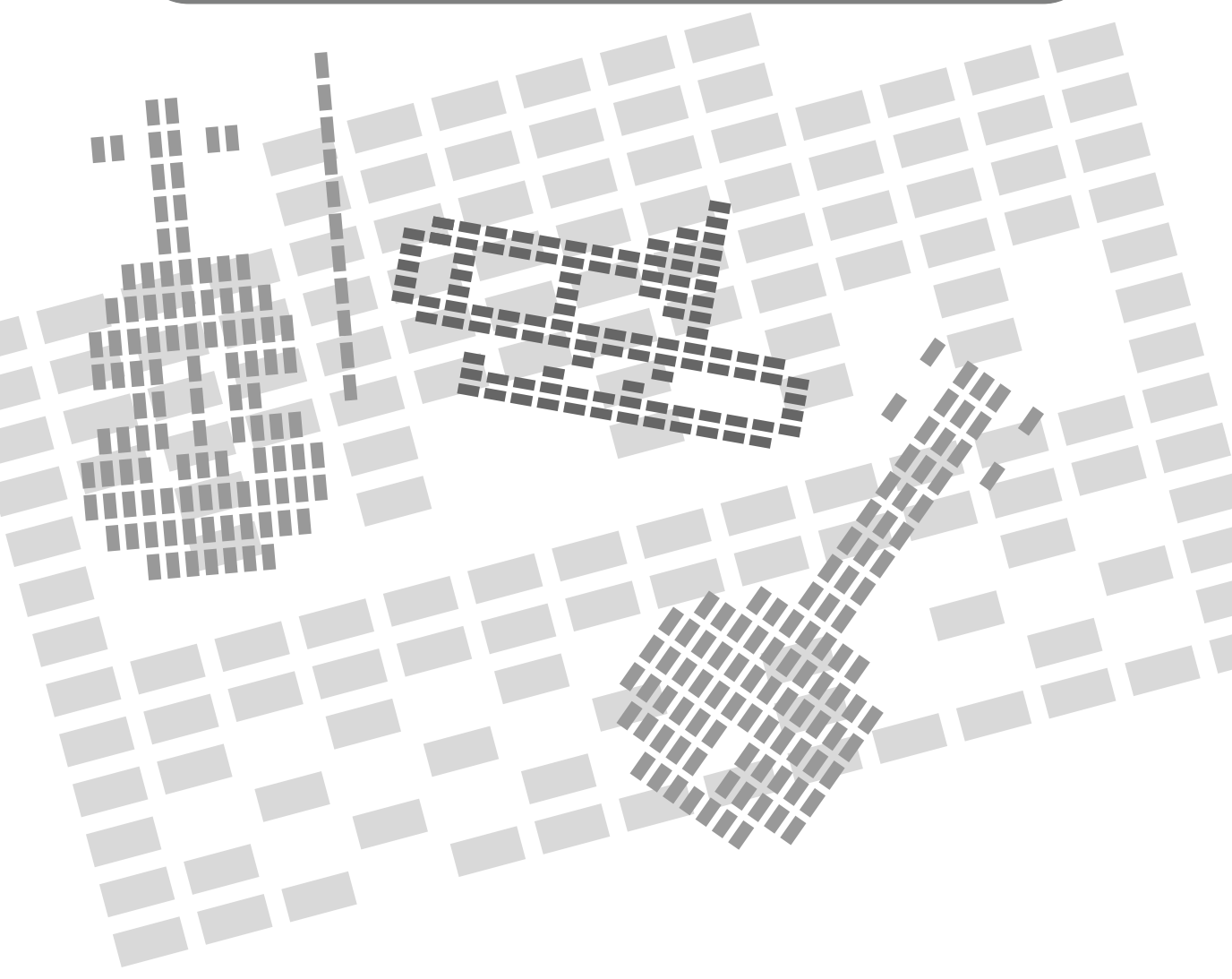

Setting Up Your MU50

In this introductory section, you'll learn how to set up the MU50 for use with a MIDI keyboard. (Setting up for use with a computer is covered on page 25.)

What You'll Need

- ☞ The MU50 and the included power adaptor.
- ☞ A MIDI keyboard, electronic piano, or any instrument that can output MIDI data.
- ☞ An amplifier/speaker system, preferably stereo. Alternately, you can use a set of stereo headphones.
- ☞ Audio connecting cables.
- ☞ A MIDI cable.

Making the Connections

CAUTION!

Before making any connections, make sure that all equipment to be connected is turned off, and that the MU50 power adaptor is not connected to an electrical outlet.

Operation

- 1** Connect one end of the MIDI cable to the MIDI OUT terminal of the MIDI keyboard and the other to the MIDI IN terminal of the MU50 (as shown in the illustration below).
- 2** Connect the audio cables from the R and L/MONO OUTPUT jacks of the MU50 to the appropriate inputs on the amplifier speaker system (as shown in the illustration below).
If the amplifier has only one input, use the L/MONO jack on the MU50. If you are using stereo headphones, connect them to the front panel PHONES jack.
- 3** Set the HOST SELECT switch on the MU50 to MIDI.
- 4** Connect the power adaptor to the DC IN terminal on the MU50 and plug the adaptor into an appropriate electrical outlet.

CAUTION!

- Do not attempt to use an AC adaptor other than the PA-1207. The use of an incompatible adaptor may result in irreparable damage to the MU50, and even pose a serious shock hazard.
- Be sure to disconnect the power adaptor from the outlet when the MU50 is not in use.

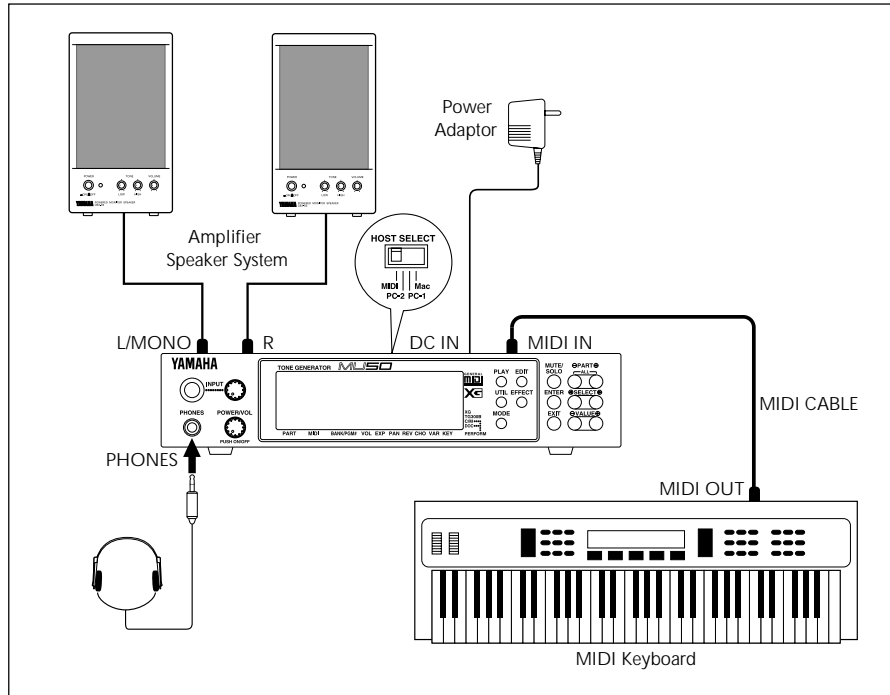

Powering Up and Playing the Demo Song

Once you've connected everything properly, you're ready to turn the MU50 on and start playing it. However, a small word of caution before you begin: Follow the instructions given below to avoid possible damage to your equipment and speakers.

Powering Up

Operation

- 1 If you haven't done so already, press the **POWER/VOL** control on the MU50.

After the greeting display, the following display will appear:

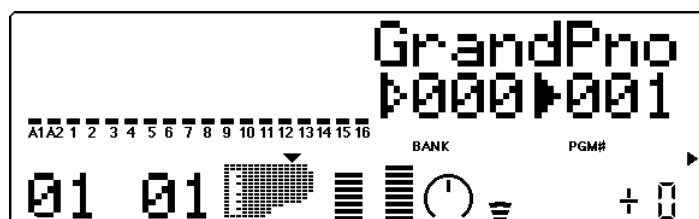

- 2 Turn on the power of your MIDI keyboard.
- 3 Make sure that all volume controls (on the MU50 and the connected amplifier) are turned down. Then, turn on the power of your amplifier speaker system.
- 4 Finally, set the volume control on the MU50 to about the mid-way position and set the volume on the amplifier to a suitable level.

Playing the Demo Song

Now that you've set everything up properly, try playing the built-in Demo Song. This showcases the high-quality Voices and the AWM2 tone generation system of the MU50.

Operation

- 1 Press the **UTIL** button.

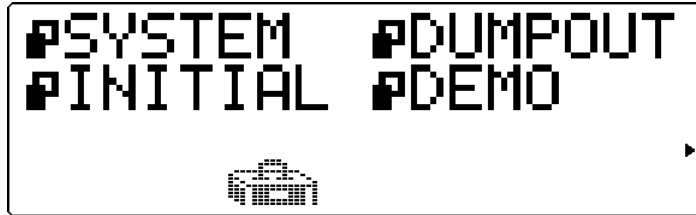

- 2 Select "DEMO" with the **SELECT** buttons and press the **ENTER** button.
- 3 Press the **ENTER** button to start the Demo Song.

The Demo Song starts playing immediately and repeats indefinitely until stopped (in step 4 below). As the song plays back, the display also shows in succession the bank number, program number and voice name for each of the 16 Parts.

NOTE

During Demo Song playback, all panel controls (except the **EXIT** button and the **VOLUME** control) cannot be used.

- 4 To stop playback of the song, press the **EXIT** button.



- 5 To exit from the Demo Song function, press the **EXIT** button again.

Playing Your MU50 With a MIDI Keyboard

Operation

Play some notes on your MIDI keyboard.

If you've carefully followed all instructions up to now, one of the "level meter" bars in the display should move — and you should be able to hear the sound of the MU50 as you play.

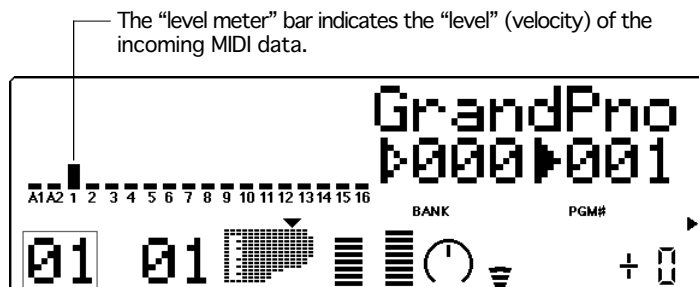

NOTE

If your MIDI keyboard is transmitting on channel 1, the Voice of Part 1 should sound. If it is transmitting on another channel, another Part's Voice will sound. For the sake of these introductory instructions, set your keyboard so that it transmits on channel 1. (Refer to the owner's manual of that instrument if necessary.)

Selecting Voices

In this brief section, you'll learn how to select other Voices. You can do this directly from the panel of the MU50 or remotely, from your MIDI keyboard.

Operation

- 1 First, select a Part. Use the **PART** buttons to select Part 1. Press the appropriate button until "01" appears in the PART section of the display.



- 2 Use the **SELECT** buttons to move the arrow cursor to the right side of the instrument icon, as shown below.

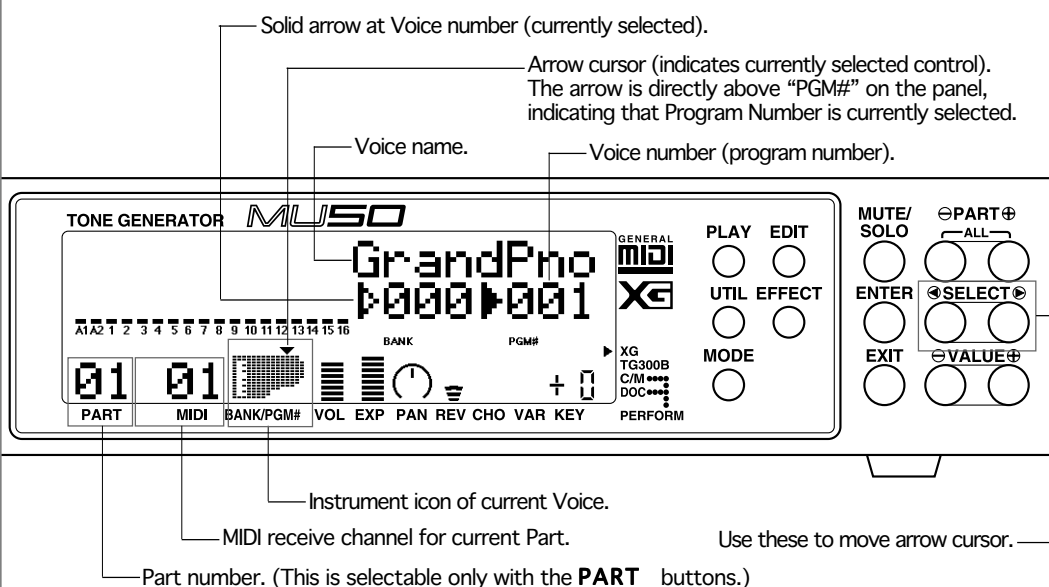

- 3 Use the **VALUE** buttons to change the Voice number. In the display below, Voice number 26 has been selected.

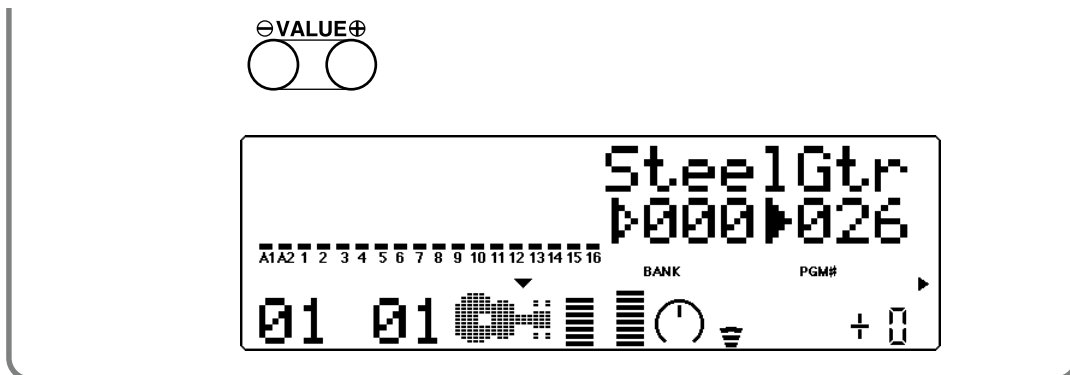

Play this new Voice from the keyboard. Try selecting other Voices and play them as well. (For a list of all the available Voices, refer to the **SOUND LIST & MIDI DATA** booklet.

HINT

You can rapidly move through the values by holding down one of the **VALUE** buttons. You can move even more rapidly by holding down one button and then pressing and holding down the other. For example, to rapidly advance (increase) the value, hold down the **VALUE** button and simultaneously press and hold down the **VALUE** button.

Changing the Voice Bank

In the current Sound Module mode (XG), several banks of Voices are available. Each bank can contain up to 128 different Voices.

Operation

- 1 Use the **SELECT** buttons to move the arrow cursor to the left side of the instrument icon, as shown below.

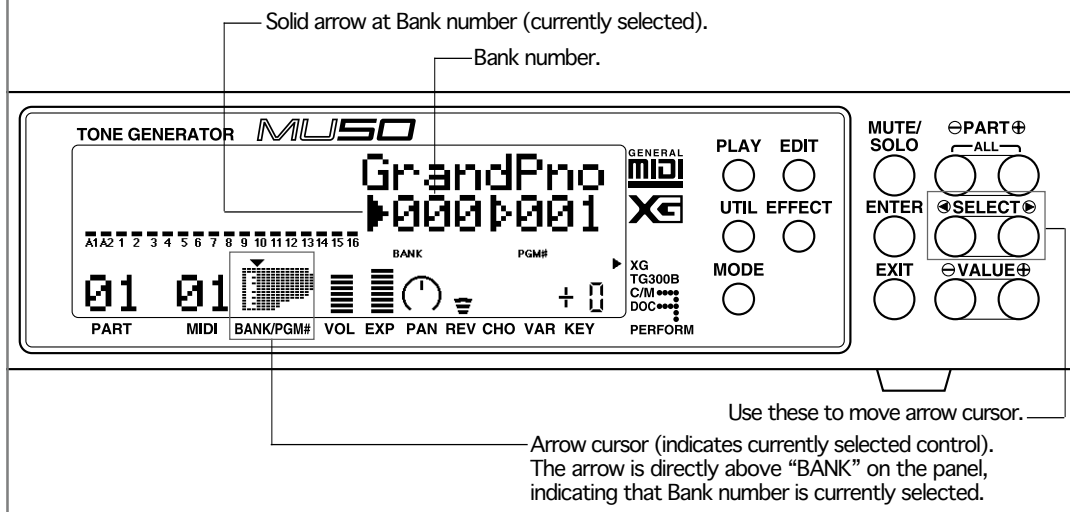

- 2 Use the **VALUE** buttons to change the Bank number.
- 3 Finally, use the **SELECT** buttons again to move the arrow cursor back to the right side of the instrument icon — for Voice selection.

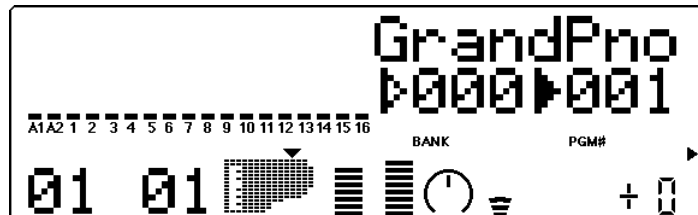

Selecting Voices From Your MIDI Keyboard

You can also select Voices remotely from the connected MIDI keyboard. Though the actual operation may differ depending on the keyboard used, the general procedure is the same. (Refer to the owner's manual of your instrument for specific instructions.)

Operation

- 1 Make sure that your keyboard is set up to send Program Change messages.
- 2 Use the panel controls to select a program on your keyboard.

Generally, if everything has been set up properly, the Voice number and name on the MU50 will change, and will be the same number as the program number you selected on your keyboard.

Changing Some of the Settings — Part Controls

You can make changes to each individual Part by using the Part controls. These are always displayed in the Play mode, giving you at-a-glance confirmation of the various basic settings of the MU50. Let's take a look at the Play display again:

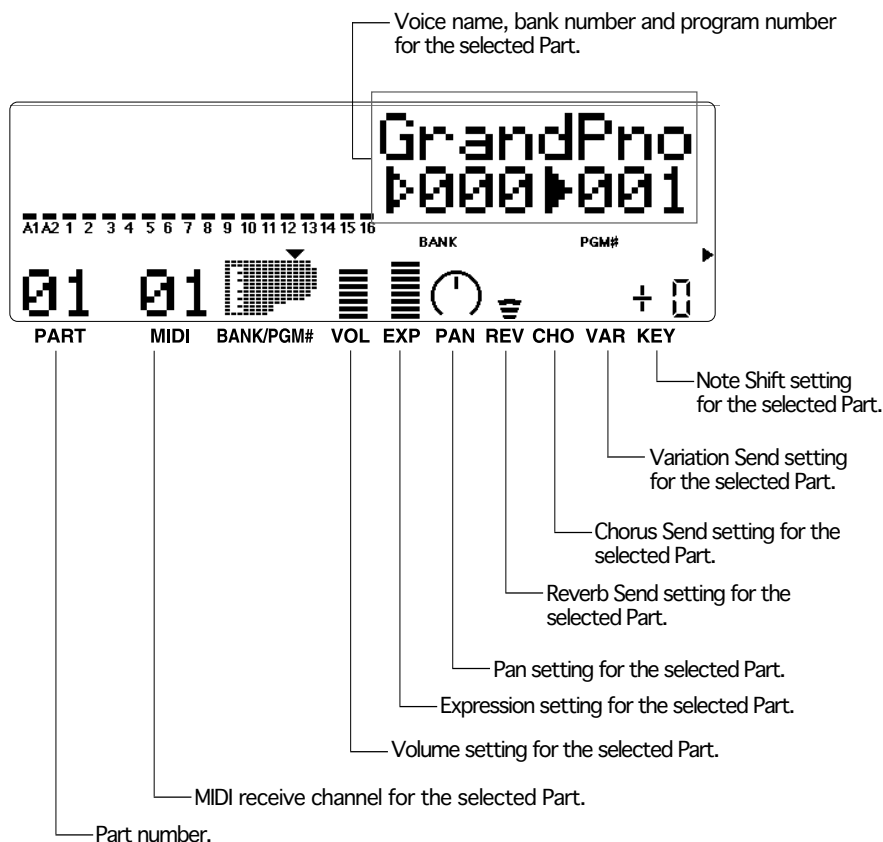

Each of these settings can be made independently for each of the Parts. For example, each Part could have a different Volume setting, or a different Pan setting. Try going through the brief sections below and making some changes in the Part controls yourself.

Selecting another Part and changing its MIDI channel

Here we'll select Part 2 and change its MIDI channel to 1, so that it matches the MIDI channel of Part 1. This allows you to play the Voices of both Part 1 and Part 2 over MIDI channel 1.

Operation

- 1 Use the **PART** buttons to select Part 2.

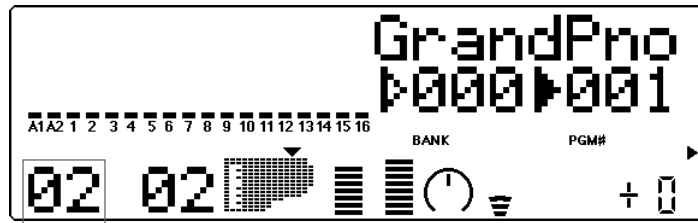

Part 2.

- 2 Use the **SELECT** buttons to call up the “Rcv CH” display below.

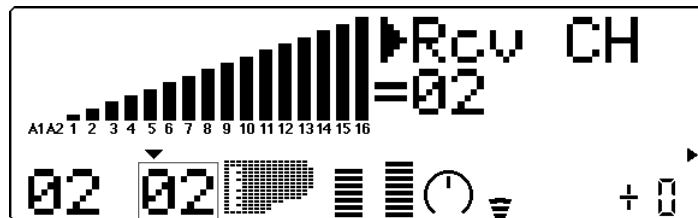

Current MIDI Receive Channel.

- 3 Use the **VALUE** buttons to change the MIDI Receive Channel to “01.”
- 4 Finally, use the **SELECT** buttons to move the arrow cursor back to the instrument icon (so that the Voice name is displayed), and play the MIDI keyboard again.

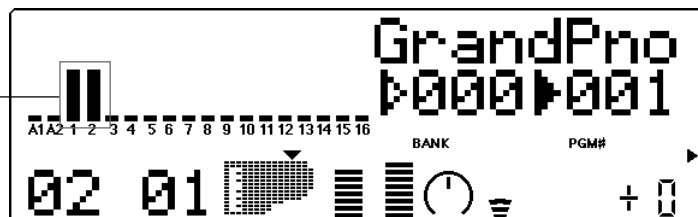

Both “level meter” move together.

If both Parts 1 and 2 have been set to MIDI channel 1, both of their “level meters” should move together as you play. And, if the two Parts are set to different Voices, you should hear two different Voices sound at the same time. (To change the Voice for a Part, refer back to **Selecting Voices** above.)

Changing the Volume and Pan settings of a Part

Now that you're playing two Voices at the same time, you may want to adjust their settings. Here, we'll change the Volume and Pan settings of one Part's Voice.

Operation

- 1 Use the **PART** buttons to select the desired Part (Part 1 or 2).
- 2 Use the **SELECT** buttons to call up the "Volume" display below.

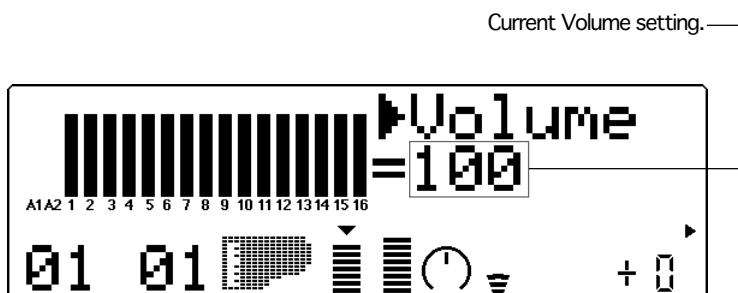

- 3 Use the **VALUE** buttons to change the setting, and play the keyboard as you make changes.
- 4 Now that you've adjusted the Volume balance of the two Voices, change one of the Part's Pan setting. Use the **SELECT** buttons to call up the "Pan" display below.

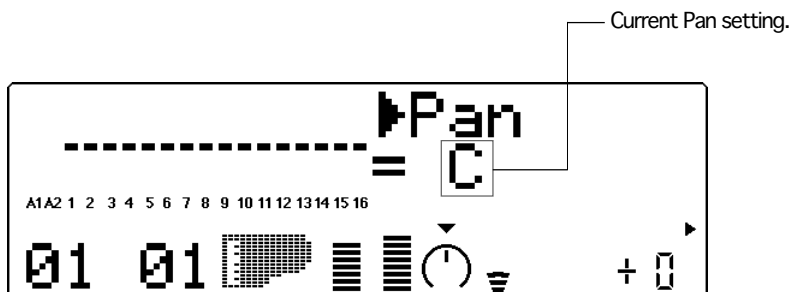

- 5 Use the **VALUE** buttons to change the setting, and play the keyboard again as you make changes.

If you want, try making changes to some of the other Part controls. The procedure is the same: 1) Use the **PART** buttons to select a Part, 2) use the **SELECT** buttons to choose the desired control, and 3) use the **VALUE** buttons to change the setting. For more information on the Part controls, see page 36.

Using Mute/Solo

The MU50 has convenient Mute and Solo functions for selectively muting or soloing any of the 16 Parts. This is especially useful when playing back several Parts from a connected computer or sequencer. Mute lets you silence one Part to hear how all of the other Parts sound without it. Solo lets you isolate a single Part, to hear how that Part sounds by itself.

Mute and Solo are effective tools that help you as you edit the Parts, since they allow you to better hear how the changes you make affect specific Voices as well as the overall sound.

Operation

While playing the keyboard (or during playback of a song from a sequencer), press the MUTE button. Each press cycles through the three functions: Mute, Solo and Normal operation.

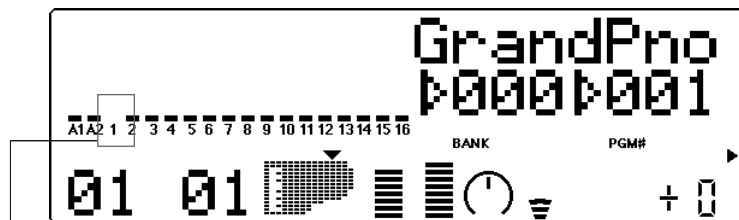

The selected Part is muted, while all other Parts sound normally.



The selected Part is soloed, while all other Parts are muted.

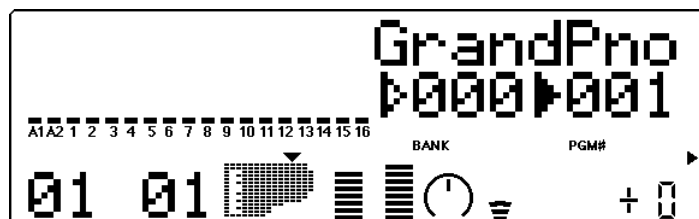

All Parts sound normally.

Using the INPUT Jack

The MU50 also features an INPUT function that allows you to connect an external audio source (such as an electric guitar, keyboard or CD player) and mix in those signals with the MU50's Voices — without the need for an external mixer. For example, this allows you to play a guitar or keyboard over backing tracks played with the MU50's Voices from a MIDI sequencer. The INPUT jack is a stereo input, and the left and right channels are indicated on the display as A1 and A2, with corresponding level meter bars for indicating the signal levels.

Operation

- 1 Turn down the INPUT control on the front panel.

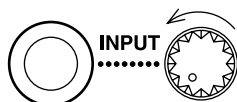

- 2 Connect the cable from the external sound source to the INPUT jack.

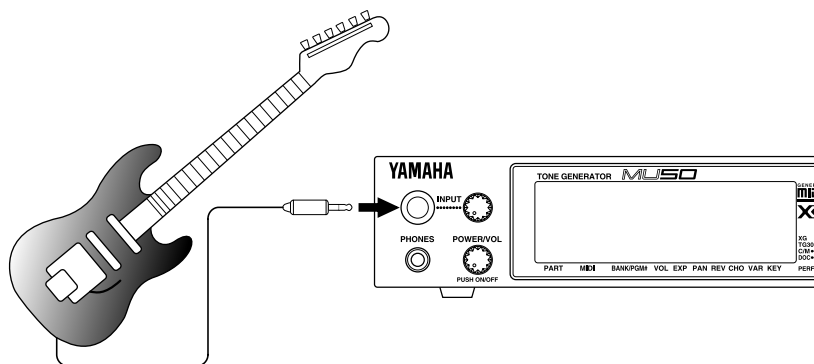

NOTE

The INPUT jack accepts stereo signals. The left channel corresponds to the tip of the 1/4" plug and the right corresponds to the ring.

- 3 Slowly bring up the INPUT control on the front panel and play the external instrument or sound source until the level is appropriate.

NOTE

When the MU50 receives a mono signal, only the A1 (left) level meter bar is indicated.

Setting Up the MU50 in Your Music System

As you learned in the section **The MU50 — What It Is and What It Can Do** on page 4, the MU50 can be integrated into a variety of setups. It would be impossible to cover all connection possibilities in a short manual as this; however, the section below will help in quickly setting up the MU50 and using it in your system.

Connecting With a Computer

The MU50 features a built-in host computer interface, allowing you to directly connect it to your computer — eliminating the need of installing a special MIDI interface to your computer. The MU50 can be used with the following computers: Apple Macintosh, IBM PC and the NEC PC-9800 Series.

If your computer has a MIDI interface you may want to connect the MU50 to it, rather than using the host computer interface on the MU50. (See the section “**Connecting to Other MIDI Devices**” on page 27.)

Depending on the computer or interface used, set the **HOST SELECT** switch to the appropriate setting: **MIDI**, **PC-1** (NEC PC-9800 Series), **PC-2** (IBM and clones), or **Mac** (Macintosh). For information on the types of cables that can be used for connection, see the section “**MIDI/Computer Connecting Cables**” on page 31.

Macintosh

Follow these instructions if you have an Apple Macintosh not equipped with an external MIDI interface. Connect the **TO HOST** terminal on the MU50 to the Modem or Printer port on the Macintosh.

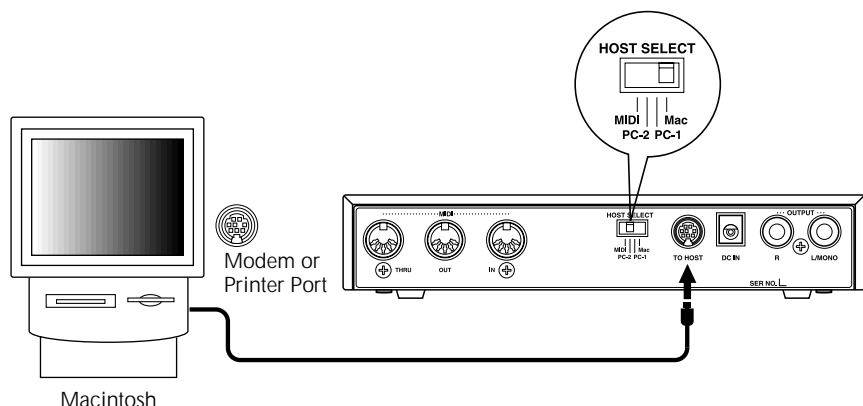

Operation

- 1 Set the **HOST SELECT** switch to **Mac**.
- 2 Connect the MU50 to the host computer, as shown in the illustration above. Use a standard Macintosh cable (8-pin Mini DIN on both ends; see page 31).
- 3 Turn on the the host computer, then the MU50.
- 4 Start up your music software, and set up the appropriate options on the software for operation with the MU50.

The options you may have to set include:

MIDI Interface Type ➤ Standard MIDI Interface
 Clock ➤ 1 MHz

Other options and settings may have to be made as well. Refer to the owner's manual of your particular music software for more information.

IBM PC and Clones

Follow these instructions if you have an IBM PC/AT or compatible computer not equipped with an external MIDI interface. Connect the **TO HOST** terminal on the MU50 to one of the computer's serial ports, COM 1 or COM 2.

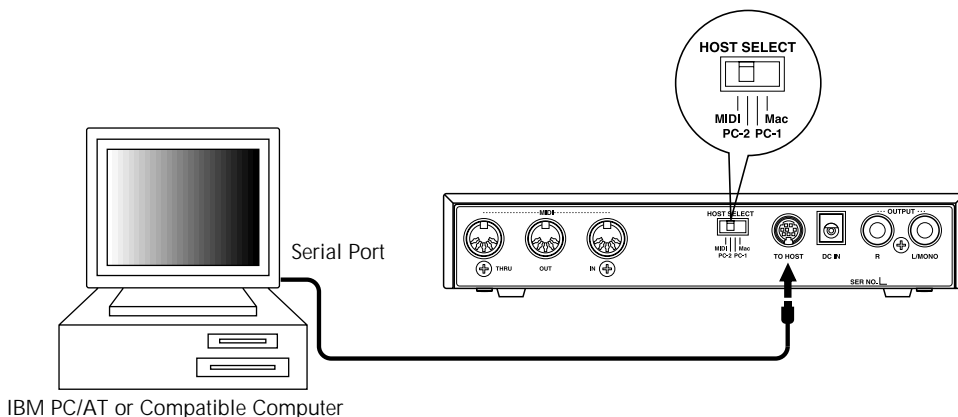

NOTE

Your music software must be able to recognize the **TO HOST** connection. Consult your Yamaha dealer for more details. If your software is not compatible, you can still use the MU50 by installing a MIDI interface (internal card or external) to the computer.

Operation

- 1 Set the **HOST SELECT** switch to **PC-2**.
- 2 Connect the MU50 to the host computer, as shown in the illustration above. Use a standard computer cable (8-pin Mini DIN to 9-pin D-SUB; see page 31).
- 3 Turn on the the host computer, then the MU50.
- 4 Start up your music software, and set up the appropriate options on the software for operation with the MU50.

Refer to the owner's manual of your particular music software for more information.

Connecting to Other MIDI Devices

The MU50 is equipped with MIDI IN and OUT terminals, allowing you to use it in any MIDI system. Example uses for the built-in MIDI interface include:

- ☞ Connecting to a **MIDI keyboard** (for playing the sounds of the MU50 from that keyboard).
- ☞ Connecting to a **computer equipped with a MIDI interface** (either internal or external).
- ☞ Connecting to a **hardware sequencer** (such as the Yamaha QY300).
- ☞ Connecting to a **MIDI data storage device** (such as the Yamaha MDF2 MIDI Data Filer).

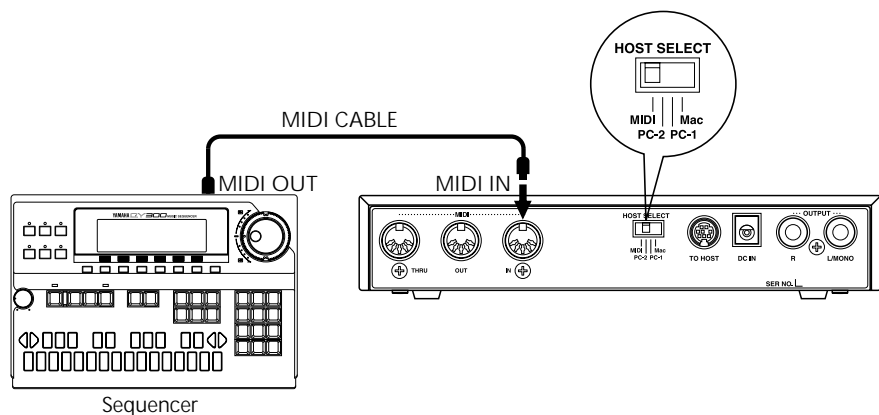

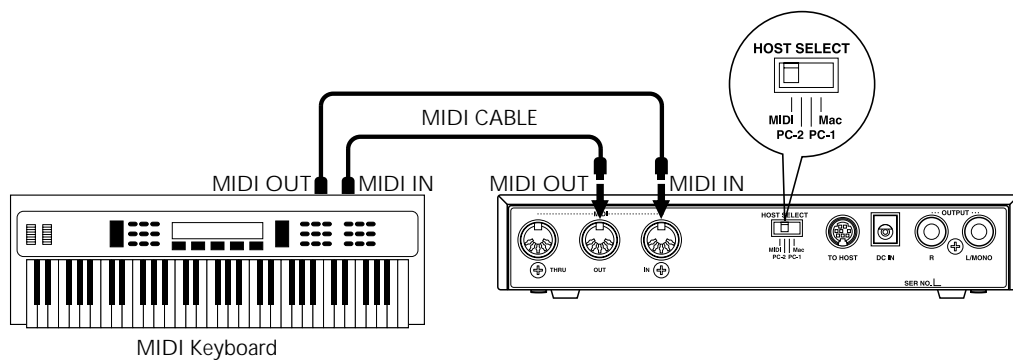
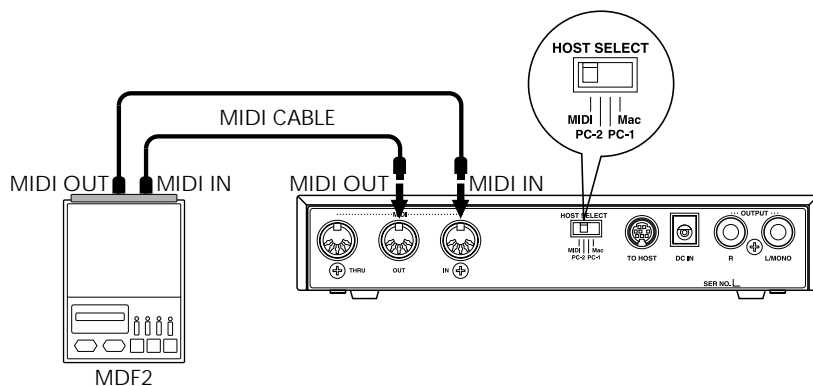

Operation

- 1 Set the **HOST SELECT** switch to MIDI.
- 2 Connect the MU50 to the appropriate MIDI device, as shown in the illustrations above. Use a standard MIDI cable (see page 31).
- 3 Turn on the the connected device, then the MU50.
- 4 If you are using a computer, start up your music software, and set up the appropriate options on the software for operation with the MU50.

Using the MU50 with a MIDI Data Storage Device

You can also use the MU50 with a MIDI data storage device, such as the Yamaha MDF2 MIDI Data Filer. This lets you save or back up whatever changes you've made in the settings of the Utility and Part Edit modes, as well as changes to the built-in effects and Performances. Then, when you want to recall those settings, you can transfer the appropriate data from the storage device.

The MDF2 also allows you to play compatible song data on the MU50 directly from the MDF2 itself, without the need of a sequencer.

Make sure that the MU50 is properly connected to the data storage device (via MIDI). (Refer to page 28 for the connection example.) Use the Dump Out function (page 98) to send data to the device. Also refer to the owner's manual of your data storage device for specific operating instructions in receiving or sending data.

Data Flow Block Diagram

When HOST SELECT switch is set to MIDI (31,250 bps):

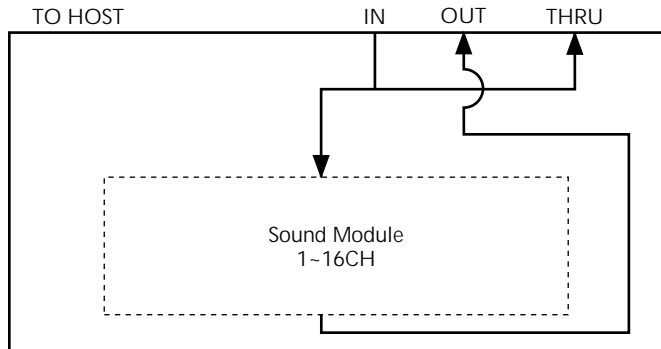

When HOST SELECT switch is set to PC-1/PC-2/Mac:

HOST SELECT = PC-1 (31,250bps)
 PC-2 (38,400bps)
 Mac (31,250bps)

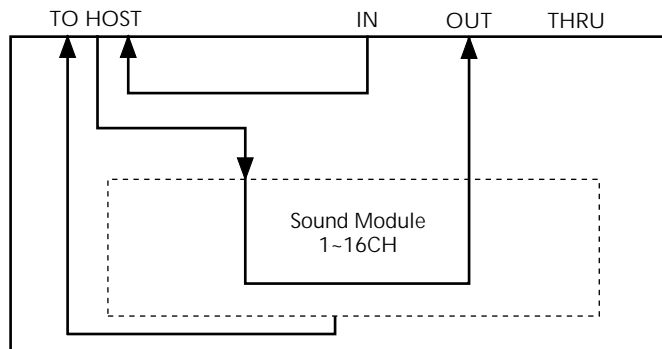

MIDI/Computer Connecting Cables

MIDI

Standard MIDI cable. Maximum length 15 meters.

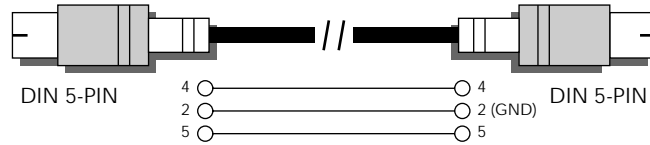

Mac

Apple Macintosh Peripheral cable (M0197). Maximum length 2 meters.

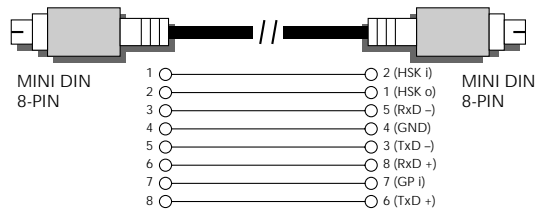

PC-1

8-pin MINI DIN to D-SUB 25-pin cable. If your PC-1 type computer has a 9-pin serial port, use the PC-2 type cable. Maximum length 1.8 meters.

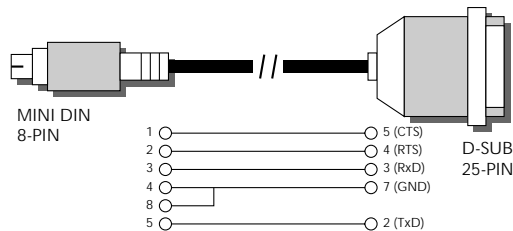

PC-2

8-pin MINI DIN to D-SUB 9-pin cable. Maximum length 1.8 meters.

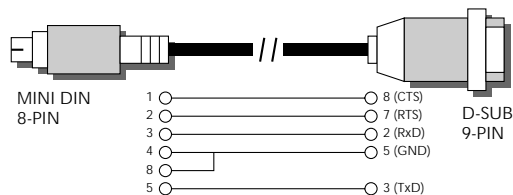

This concludes your basic tour of the important functions of the MU50. To find out more about how to best use your MU50, look through the **Reference** section that follows and try out some of the functions and operations that interest you.

REFERENCE

The Reference section of this manual covers in detail all of the functions of the MU50. Refer to it when you need information about a specific function, feature or operation.

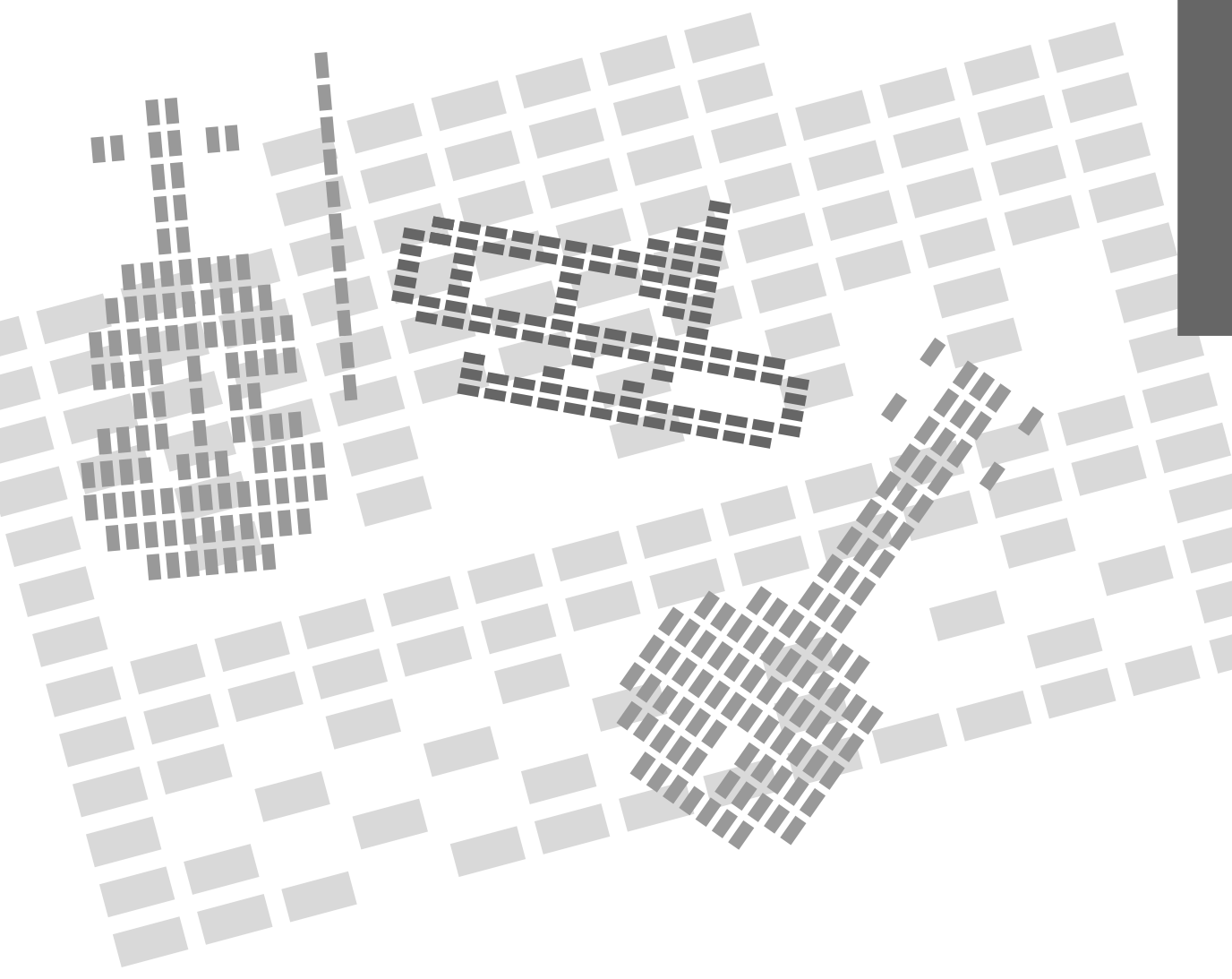

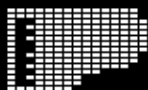

Multi Mode

In the Multi mode, the MU50 performs as a multi-timbral tone generator capable of playing up to 16 Parts simultaneously, over 16 MIDI channels. Normally, the MU50 should be set to Multi mode when using it with a sequencer and General MIDI song data. There are four Multi modes: XG, TG300B, C/M and DOC. Each mode provides compatibility with different music software and hardware as described below:

- XG:** Provides compatibility with the XG format.
- TG300B:** Provides semi-compatibility with the GM Level 1 standard.
- C/M:** Provides semi-compatibility with computer music software.
- DOC:** Provides compatibility with DOC music software for the Yamaha Clavinova.

NOTE

When set to the **TG300B** mode, the MU50 may not be able to play TG300-specific song data with complete accuracy. However, MIDI data designed for other computer music tone generators is compatible with the MU50.

To set the Multi mode:

- 1 Press the **MODE** button.



- 2 Use the **VALUE** buttons to select the desired Multi mode: XG, TG300B, C/M or DOC.
- 3 Press the **EXIT** button or the **PLAY** button to return to the Play display.

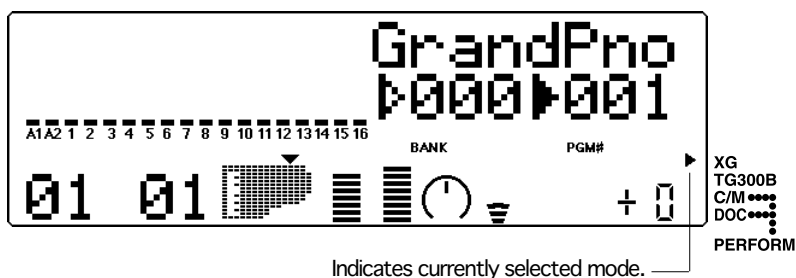

The currently selected mode setting is shown by the arrow at the bottom right of the display.

Multi Play Mode

The Play mode (with the main Play display shown below) is the normal operating mode of the MU50. To select the Play mode from any other mode, press the **PLAY** button. (The Play mode is also automatically selected when you turn on the MU50.)

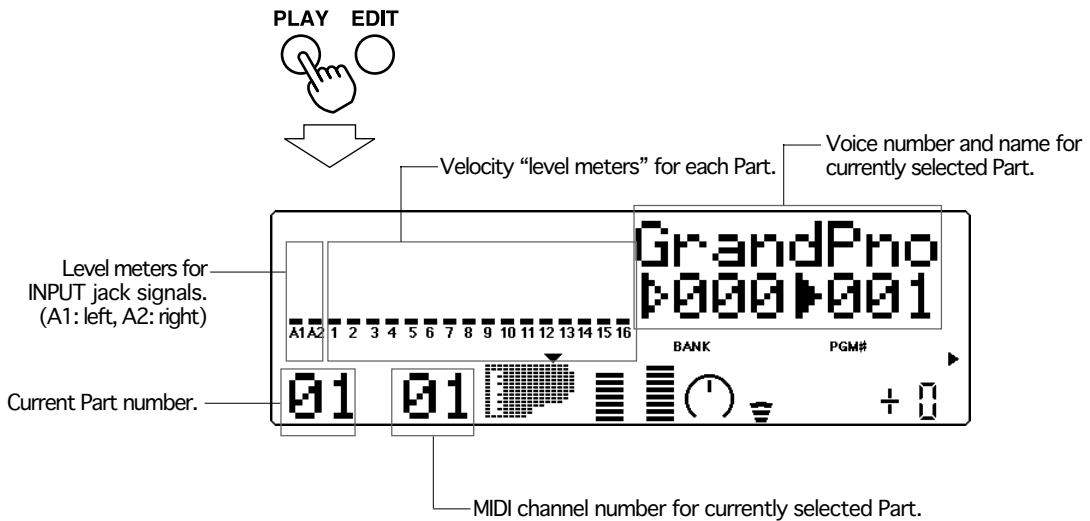

Part Controls

The Part controls in the Play mode give you tools for adjusting the basic sound and settings for each Part. The MU50 lets you adjust the various settings for each Part individually (Single Part control) or together (All Part control). Each of these types is explained in greater detail below.

NOTE

In the Multi mode, no settings can be permanently saved to the internal memory of the MU50. However, you can use the Dump Out function to save Multi settings to a MIDI data storage device. (See page 98.)

Single Part Control

The Single Part controls include: MIDI Receive Channel, Bank Number, Program Number, Volume, Expression, Pan, Reverb Send, Chorus Send, Variation Send and Note Shift.

Selecting Single Part Control

Single Part control is automatically called up when the MU50 is turned on. If All Part is selected, simply press both **PART** buttons simultaneously (or press the **EXIT** button) to return to Single Part.

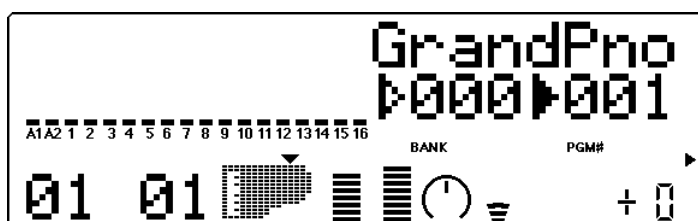

Editing in Single Part

Operation

- 1 Select the Part to be edited by using the **PART** buttons.
- 2 Select the desired control for the selected Part by using the **SELECT** buttons.
- 3 Change the value of the selected control by using the **VALUE** buttons.

MIDI Receive Channel

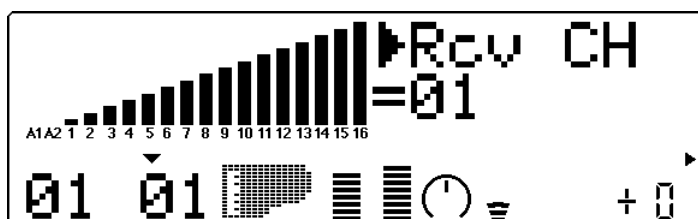

Settings: 1 — 16

This determines the MIDI receive channel (1 — 16) for the selected Part.

Bank Number



Settings:

XG: 000, 001, 003, 006, 008, 012, 014, 016 — 020, 024, 025, 027, 028, 032 — 043, 045, 064 — 072, 096 — 101, SFX

TG300B: 000 — 011, 016 — 019, 024 — 026, 032, 033, 040, 126, 127

C/M: Fixed (only one bank)

DOC: Fixed (only one bank)

This determines the bank number of the selected Part's Voice. Each bank contains 128 Voices. (Refer to the **SOUND LIST & MIDI DATA** booklet.)

Program (Voice) Number



Range: 1 — 128

This determines the Voice for the selected Part. (Refer to the **SOUND LIST & MIDI DATA** booklet.)

Volume

Graphically indicates current Volume setting.

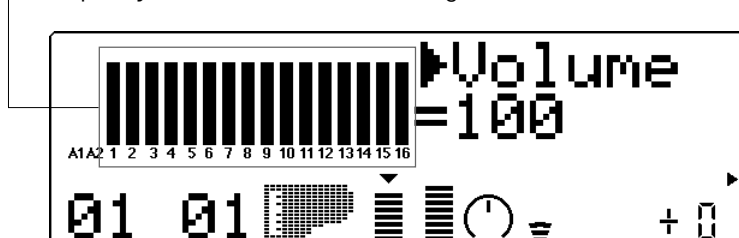

Range: 0 — 127

This determines the Volume setting for the selected Part's Voice.

Expression (Express)

Graphically indicates current Expression setting.

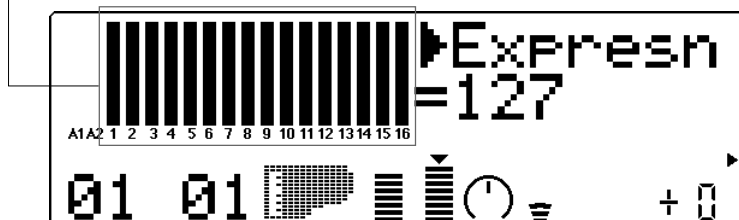

Range: 0 — 127

This determines the Expression setting for the selected Part's Voice.

Pan

Graphically indicates current Pan setting.

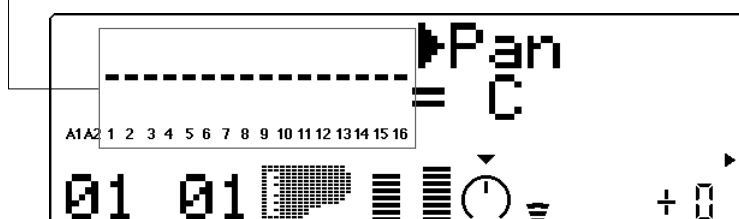

Settings: Rnd (Random), L63 — C — R63

This determines the stereo position of the selected Part's Voice. A setting of "Rnd" (Random) randomly assigns the Voice to a pan position. This is useful when you want to have different Voices sound from different random parts of the stereo image.

Reverb Send (RevSend)

Graphically indicates current Reverb Send setting.

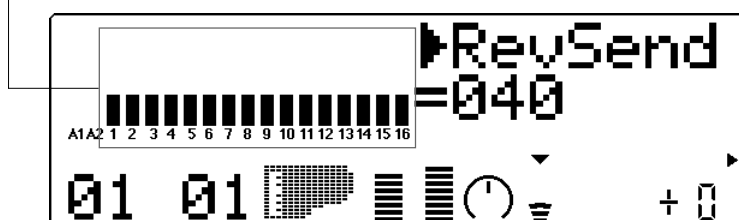

Range: 0 — 127

This determines the level of the selected Part's Voice that is sent to the Reverb effect. A value of 0 results in a completely "dry" Voice sound.

NOTE

Keep in mind that the Reverb effect must be properly enabled and set for this parameter to work as intended. (See page 86.)

Chorus Send (ChoSend)

Graphically indicates current Chorus Send setting.

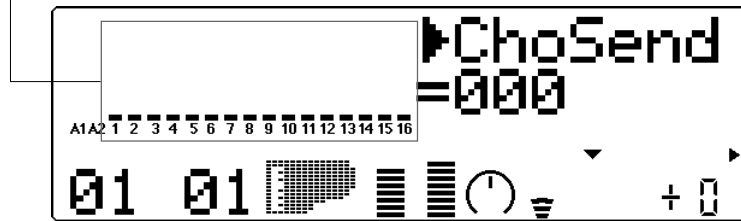

Range: 0 — 127

This determines the level of the selected Part's Voice that is sent to the Chorus effect. A value of 0 results in a completely "dry" Voice sound (no Chorus effect).

NOTE

Keep in mind that the Chorus effect must be properly enabled and set for this parameter to work as intended. (See page 88.)

Variation Send (VarSend)

Graphically indicates current Variation Send setting.

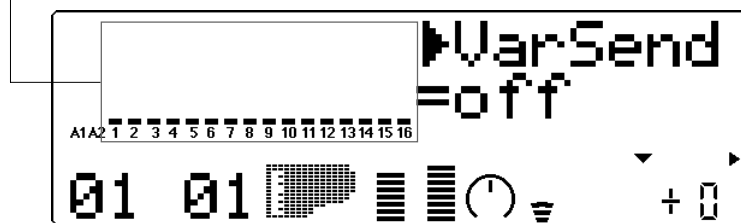

Settings: **off, on** (when **Variation Connection** is set to **INS**);
0 — 127 (when **Variation Connection** is set to **SYS**)

This determines whether the selected Part's Voice is sent to the Variation effect or not. A setting of "off" results in no Variation effect being applied to the Voice.

Note Shift (NoteSft)

Graphically indicates current Note Shift setting.

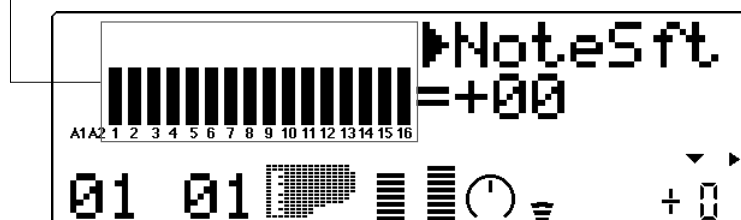

Range: -24 — +24 semitones

This determines the key transposition setting for the Part's Voice.

All Part Control

The All Part controls include: Device Number, Master Volume, Reverb Return, Chorus Return, Variation Return and Transpose.

Keep in mind that these controls affect all Parts equally, and either add to or subtract from their individual values. For example, if Note Shift on one Part is set to -12 , and Transpose (in All Part) is set to $+12$, that Part's pitch value will actually be 0 or normal.

Selecting All Part Control

To select All Part control, press both **PART** buttons simultaneously. (or press the **EXIT** button). (“All” appears in the PART section of the display.)

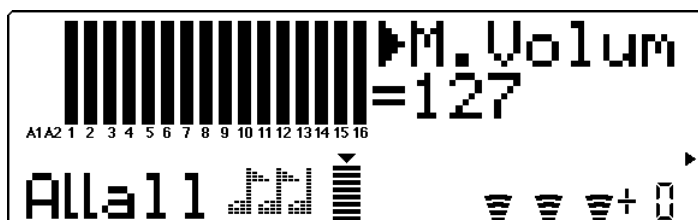

Editing in All Part

Operation

- 1 Select the desired control for all Parts by using the **SELECT** buttons.
- 2 Change the value of the selected control by using the **VALUE** buttons.

Device Number (DevNo.)

Graphically indicates current Device Number setting.

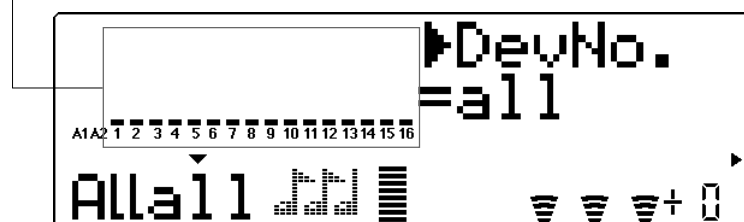

Settings: 1 — 16, all

This determines the Device Number for the MU50, a kind of MIDI “identification” number to distinguish between multiple units. For

example, if you are using more than one MU50, set a different Device Number for each. This is especially important when using the data dump features. (See page 98.) If you have only one MU50, set this to “all.”

Master Volume (M.Volum)

Graphically indicates current Master Volume setting.

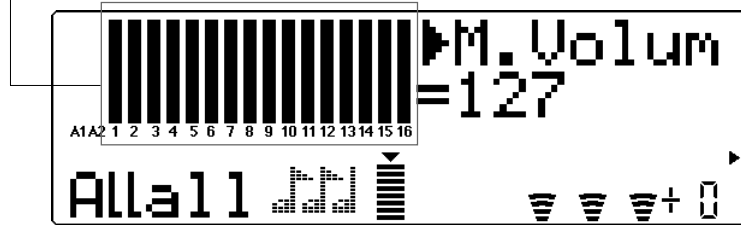

Range: 0 — 127

This determines the overall Volume of the Parts.

Reverb Return (RevRtn)

Graphically indicates current Reverb Return setting.

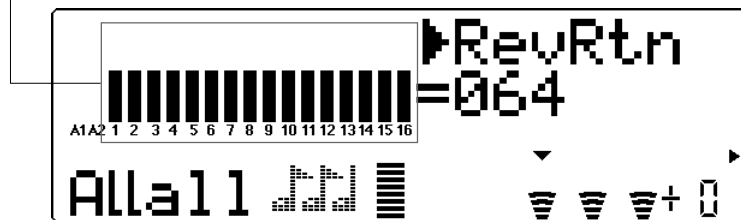

Range: 0 — 127

This determines the amount of Reverb return in the overall mix.

Chorus Return (ChoRtn)

Graphically indicates current Chorus Return setting.

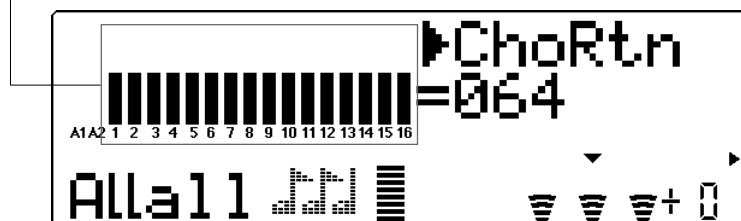

Range: 0 — 127

This determines the amount of Chorus return in the overall mix.

Variation Return (VarRtn)

Graphically indicates current Variation Return setting.



Range: 0 — 127

This determines the amount of Variation return in the overall mix. Variation Return is only available when the **Variation Connection** parameter is set to **SYS**. (See page 92.)

Transpose (Trans)

Graphically indicates current Transpose setting.



Range: -24 — +24 semitones

This determines the overall Transpose setting of the Parts.

Multi Edit Mode

The Multi Edit mode features various parameters for controlling the Filter, the EG (Envelope Generator) and Vibrato. It also features a variety of other miscellaneous controls grouped in the Others parameters. When a Drum Part is selected, Drum-related parameters are also available.

To enter the Multi Edit mode, press the **EDIT** button. When a normal Part is selected, the following menu appears:



When a Drum Part is selected, the following menu appears:



Filter

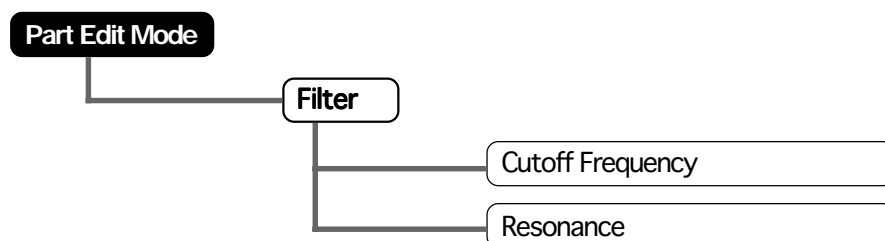

The MU50 features a digital filter that can be used to change the timbre of the Voices. The filter is affected (together with the level) by the EG (Envelope Generator), which allows you to change the timbre over time as well. (See **EG**, page 45.)

Cutoff Frequency (CutoffFreq)

Graphically shows Cutoff Frequency setting for each Part.

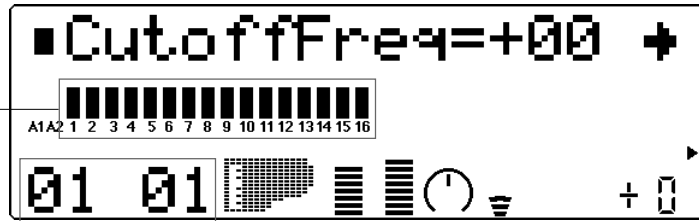

Selected Part and MIDI channel

Range: -64 — +63

Default: 0

This determines the cutoff frequency of the filter, or the frequency point above which other frequencies are filtered out. Lower cutoff values create a deeper, more rounded tone, while higher values create a thinner, brighter tone.

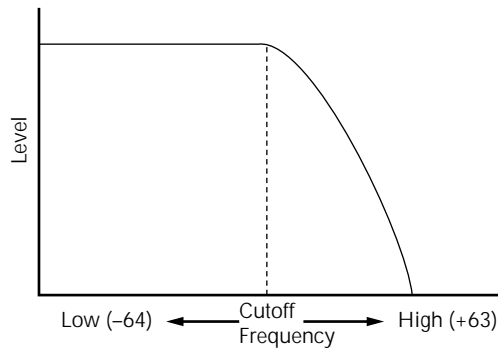

Resonance

Graphically shows Resonance setting for each Part.



Selected Part and MIDI channel

Range: -64 — $+63$

Default: 0

This determines the amount of filter resonance or emphasis of the Cutoff Frequency parameter above. Higher values increase the emphasis of the Cutoff Frequency, producing a higher resonant peak, while lower values produce a relatively flat response.

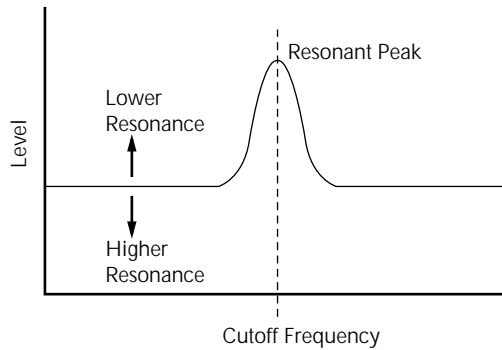

EG (Envelope Generator)

Part Edit Mode

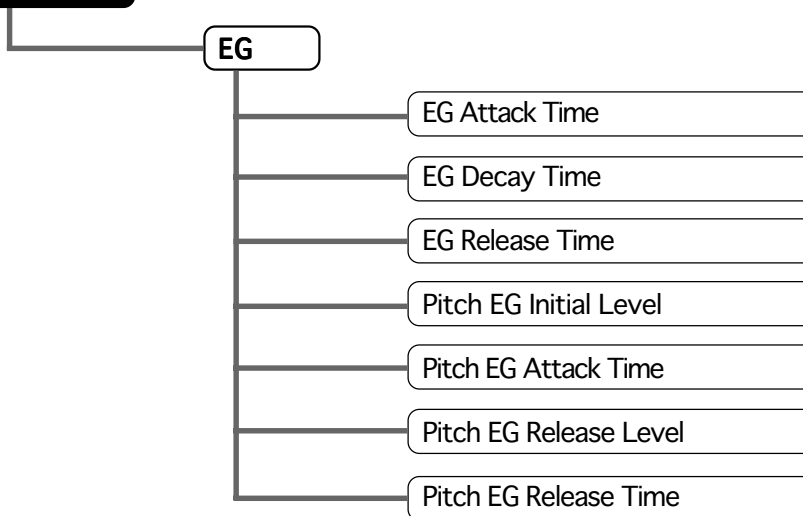

The EG parameters allow you to shape the sound of a Part's Voice — or, in other words, set how the level and timbre of the Voice changes over time. This section also includes independent Pitch Envelope Generator (PEG) parameters for controlling how the pitch of a Part's Voice changes over time.

The relationship of the main EG parameters — Attack, Decay and Release — are shown in the illustration below. These parameters not only affect the sound level, but also the timbre (with the Filter parameters; see page 43).

EG Parameters

1) Short Attack, Decay, Release times:

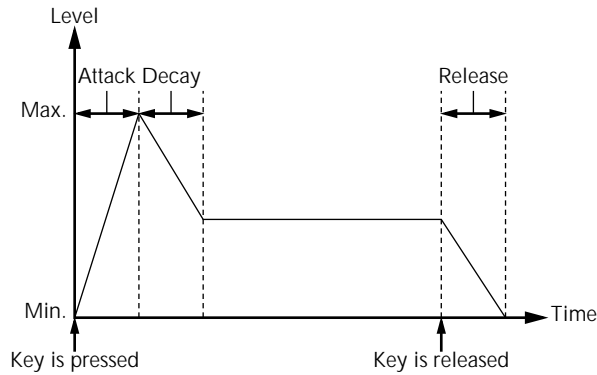

2) Long Attack, Decay, Release times:

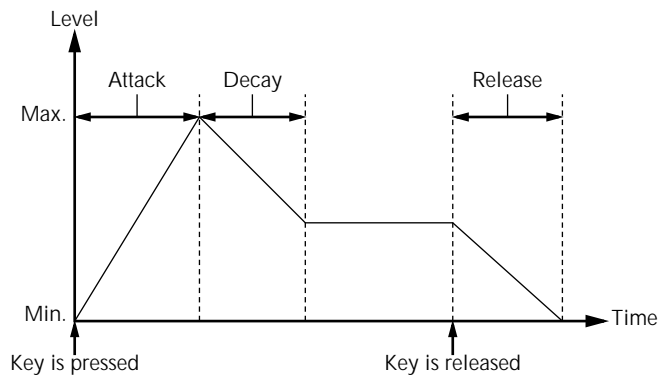

Even though the key is held for the same length of time in both examples, the sound of the second example slowly reaches full volume and decays over a longer time. It also sustains longer after the key is released.

Keep in mind that the EG parameters affect each other, and are affected by how long a note is held. For example, if Decay is set to a low value and the note is held for a long time, you may not be able to hear changes made to the Release parameter.

EG Attack Time

Graphically shows EG Attack Time setting for each Part.

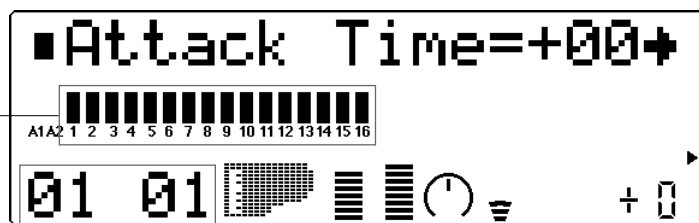

Selected Part and MIDI channel

Range: -64 — +63

Default: 0

This determines the Attack Time of the EG, or how long it takes for the sound to reach full volume when a note is played. For the Filter, this determines how long it takes for the sound to be affected by the maximum Filter values.

EG Decay Time

Graphically shows EG Decay Time setting for each Part.

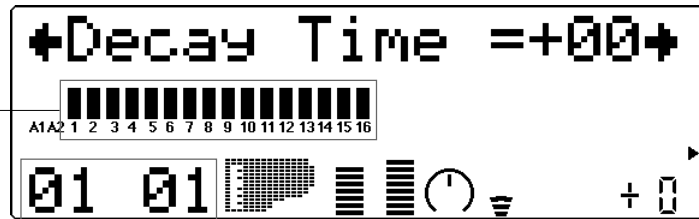

Selected Part and MIDI channel

Range: -64 — +63

Default: 0

This determines the Decay Time of the EG, or how rapidly the sound dies out as a note is held. For the Filter, this determines how long it takes for the Filter effect to die out.

EG Release Time

Graphically shows EG Release Time setting for each Part.



Selected Part and MIDI channel

Range: -64 — +63

Default: 0

This determines the Release Time of the EG, or how long the sound sustains after a note is released. For the Filter, this determines how long the Filter effect continues after a note is released.

Pitch EG Parameters

The Pitch EG parameters determine how the pitch of a Part's Voice changes over time. This lets you produce subtle or pronounced pitch changes as a note is played.

In the example Pitch EG settings below, a played note is gradually bent up to its normal pitch, and kept there as the note is held. When the note is released, the pitch rapidly climbs up.

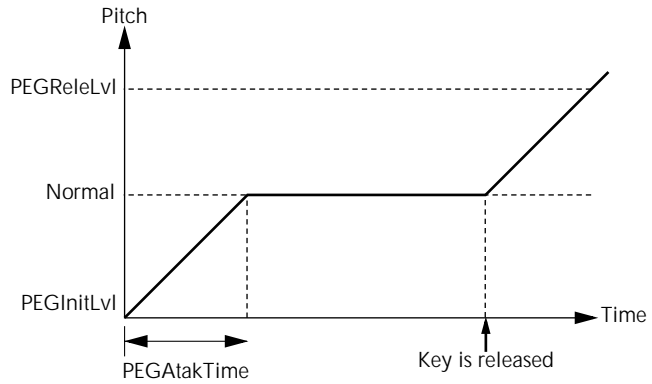

NOTE

The Pitch EG parameters may have little or no effect, depending on the particular Voice used and the settings made to the main EG parameters.

Pitch EG Initial Level (PEGInitLvl)

Graphically shows Pitch EG Initial Level setting for each Part.

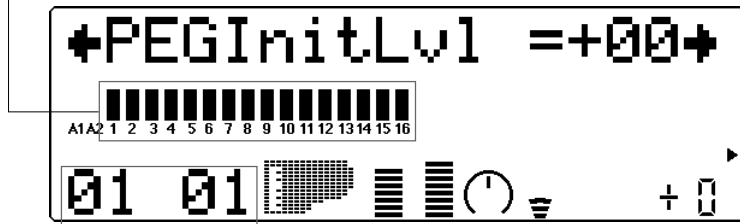

Selected Part and MIDI channel

Range: -64 — +63

Default: 0

This determines the initial pitch of the Part's Voice, when the note is first played. A setting of 0 corresponds to normal pitch.

Pitch EG Attack Time (PEGAtakTime)

Graphically shows Pitch EG Attack Time setting for each Part.

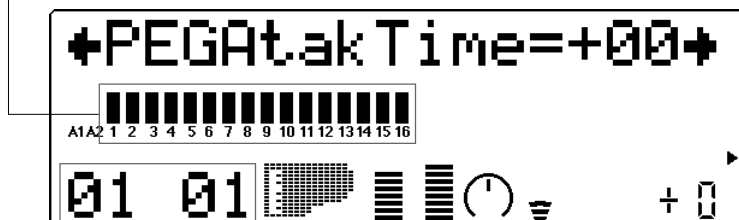

Selected Part and MIDI channel

Range: -64 — +63

Default: 0

This determines the Attack Time of the Pitch EG, or how long it takes for the pitch to return to normal (from the pitch value set in Initial Level above).

Pitch EG Release Level (PEGReleLvl)

Graphically shows Pitch EG Release Level setting for each Part.



Selected Part and MIDI channel

Range: -64 — +63

Default: 0

This determines the final pitch of the Part's Voice, or the pitch that is reached after the note is released. A setting of 0 corresponds to normal pitch.

NOTE

The Pitch EG Release Level and Time parameters may have no effect if the Voice itself does not sustain after the note is released. (Short percussive Voices may fall into this category.) Also make sure that the main EG Release Time is set to an appropriate value so that the sound sustains.

Pitch EG Release Time (PEGReleTime)

Graphically shows Pitch EG Release Time setting for each Part.

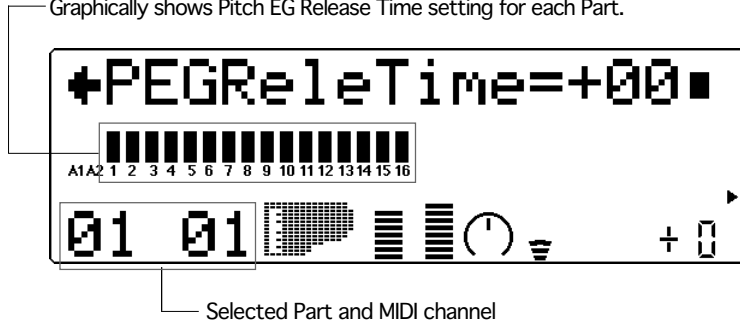

Selected Part and MIDI channel

Range: -64 — +63

Default: 0

This determines the Release Time of the Pitch EG, or how long it takes for the pitch to change to the pitch value set in Release Level above.

Vibrato

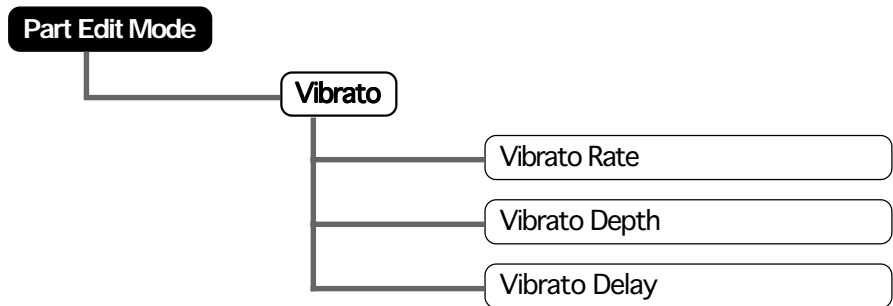

Vibrato produces a quavering, vibrating sound in the Part's Voice, by regularly modulating the pitch. You can control the speed and depth of the Vibrato, as well as the time it takes before the Vibrato effect is applied.

Vibrato Rate

Graphically shows Vibrato Rate setting for each Part.

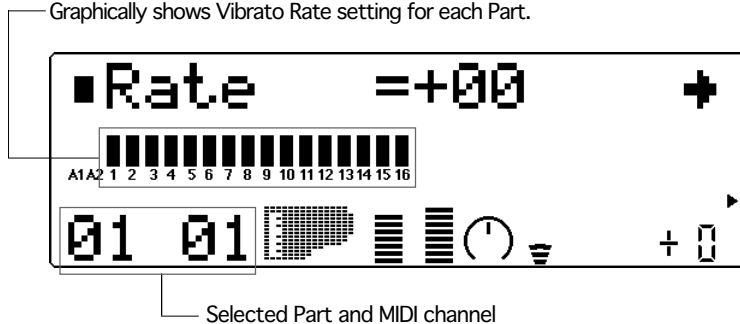

Selected Part and MIDI channel

Range: -64 — +63

Default: 0

This determines the speed of the Vibrato effect. Higher values result in a faster Vibrato sound.

Vibrato Depth

Graphically shows Vibrato Depth setting for each Part.

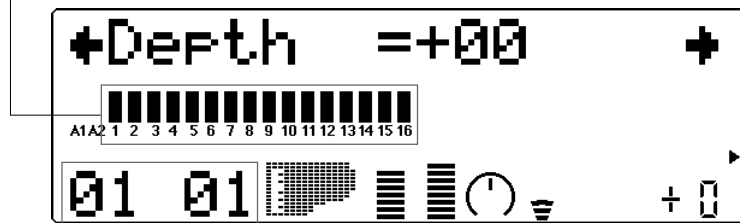

Selected Part and MIDI channel

Range: -64 — +63

Default: 0

This determines the depth of the Vibrato effect. Higher values result in a stronger, more pronounced Vibrato sound.

Vibrato Delay

Graphically shows Vibrato Delay setting for each Part.

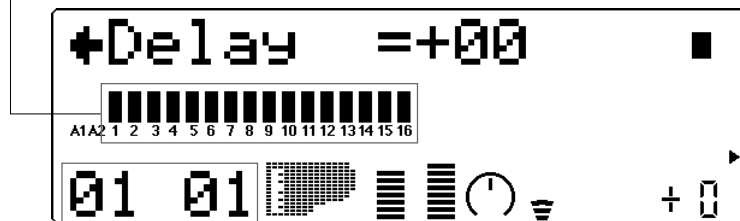

Selected Part and MIDI channel

Range: -64 — +63

Default: 0

This determines the delay in the onset of the Vibrato effect. Delay is effective especially on stringed instrument Voices. For example, violin players often use delayed vibrato, especially while playing long notes. The Delay parameter is useful in recreating this effect, producing a more natural, lifelike sound. Higher values result in a longer Delay time.

Others

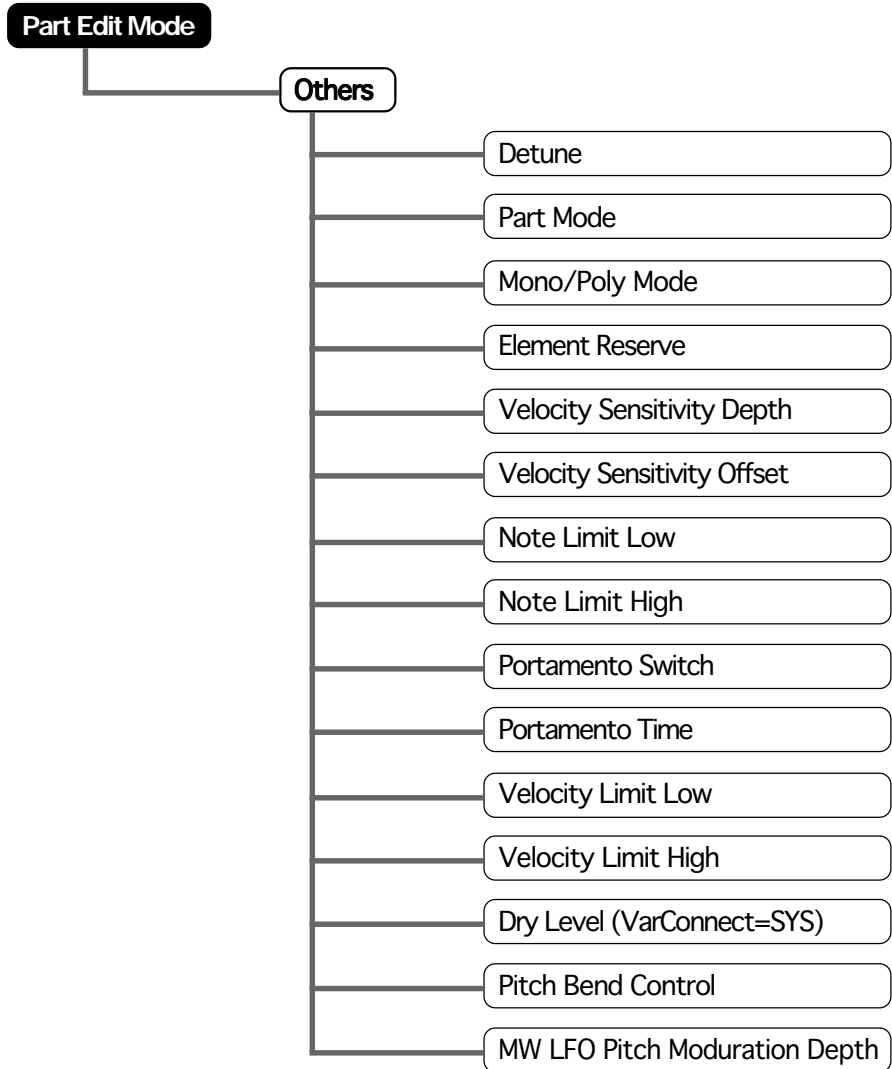

The Others section of parameters contains miscellaneous controls, including those related to tuning, Part Mode, velocity, portamento, note range, etc.

Detune

Graphically shows Detune setting for each Part.

Selected Part and MIDI channel

Range: -12.8 — +12.7

Default: 0.0

This determines the fine tuning of the Part's Voice.

HINT

Detune could be used to slightly detune a Voice compared to the tuning of the rest of the Voices for a richer sound. It could also be used to detune two different Voices being played in unison. For example if two different Parts are set to the same MIDI channel (see page 36) and same Voice, a naturally thick chorusing effect can be obtained by slightly detuning each Voice in opposite directions here.

Part Mode

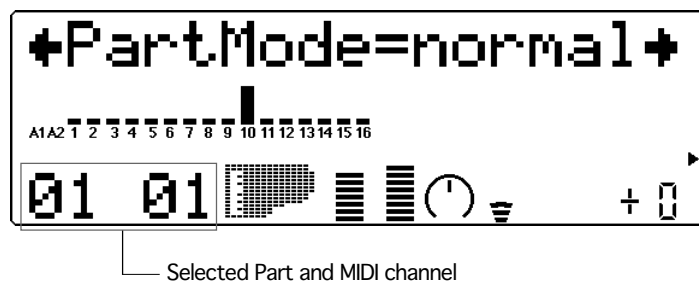

Height of bars indicates selected Part Mode setting for each Part. (A single bar indicates “normal” setting.)

Settings: normal, drum, drumS1, drumS2

Default: normal (Parts 1 — 9, 11 — 16)
drumS1 (Part 10)

(When Sound Module mode is set to **C/M** or **DOC**, Part 10 is set to **drumS1**.)

This determines the mode for the Part. A setting of **normal** allows selection of the normal instrument Voices. (See the **SOUND LIST & MIDI DATA** booklet.) The **drum** setting allows selection of the drum kits. (See the **SOUND LIST & MIDI DATA** booklet.) The **drumS1**, **drumS2** settings are locations for storing specially programmed drum setups. These setups can be edited by using the Drum Setup controls in the Multi Edit mode. (See page 61.) The **drum** and **drumS1**, **drumS2** settings are not available in the Performance mode.

The Part Mode settings differ depending on the Sound Module mode selected, as described below.

For **XG** mode:

All settings described above are available. When **normal** is selected, any of the basic or the extended set of Voices can be used for the Part.

For TG300B mode:

The settings **normal** and **drumS1**, **drumS2** are available; **drum** cannot be selected. When **normal** is selected, either the basic or the extended set of Voices (for the TG300B mode) can be used for the Part.

For C/M mode:

The Part Mode settings are fixed in this mode and cannot be changed: Part 10 is set to **drumS1**, and all other Parts are set to **normal**. The MIDI Receive Channel setting for Part 1 is set to **off**. The 128 Voices of C/M Type 1 can be used for Parts 1 — 9; the 64 Voices of C/M Type 2 can be used for Parts 11 — 16.

For DOC mode:

The Part Mode settings are fixed in this mode and cannot be changed: Parts 1 through 10 are set to **normal** and Part 15 is set to **drumS1**.

For PERFORM (Performance) mode:

All four Parts are set to **normal**; none of the **drum** settings are available. Any of the basic or the extended set of Voices can be used for each Part.

NOTE

When two or more different Parts are set to the same editable drum setup (**drumS1** or **drumS2**), any edits made to that drum setup automatically affect all those Parts. For example, when two Parts are set to **drumS1**, any changes made to **drumS1** affect both Parts.

Mono/Poly Mode

Height of bars indicates selected Mono/Poly Mode setting for each Part. (A single bar indicates “mono” setting, while full height indicates “poly.”)

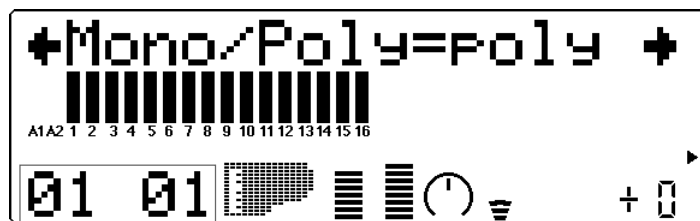

Selected Part and MIDI channel

Settings: mono, poly

Default: poly

This determines whether the Part's Voice is played monophonically (only one note at a time) or polyphonically (up to 32 notes at a time). This parameter is not available when the Part Mode is set to Drum.

Element Reserve (ElemReserv)

Height of bars indicates selected Element Reserve setting for each Part.

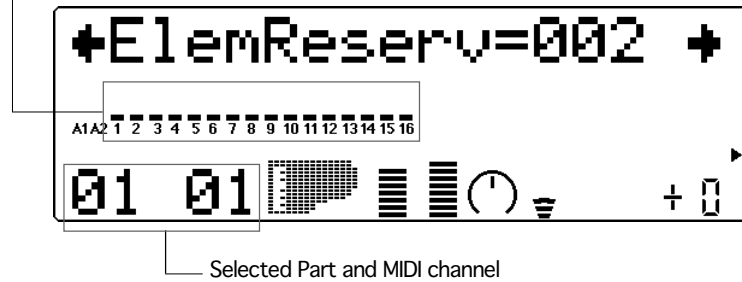

Range: 0 — 32

Default: 2 (Parts 1 — 9, 11 — 16)
0 (Part 10)

This determines the amount of elements (or notes) that are reserved for the selected Part, effectively letting you keep notes of certain Parts from being “stolen” by other Parts.

Normally, elements are dynamically allocated to Parts. However, you may want to use this parameter to avoid the problem of note “stealing” and reserve a certain number of elements for particularly important Parts in a complex composition. The total range of this parameter is 0 — 32; however, this will be less if the Element Reserve for other Parts has been set to 1 or more.

Velocity Sensitivity Depth (VelSensDpt)

Graphically shows Velocity Sensitivity Depth setting for each Part.

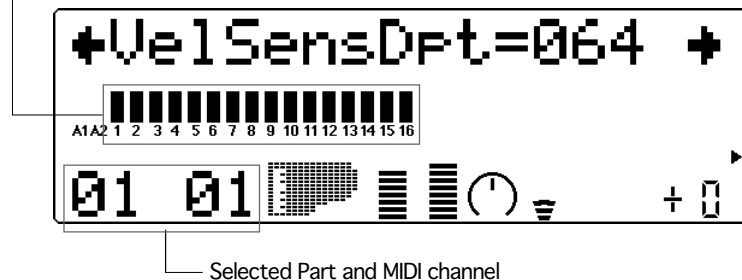

Range: 0 — 127

Default: 64

This determines the degree to which velocity affects the Part’s Voice. Higher values make the Voice more sensitive to changes in velocity.

Velocity Sensitivity Offset (VelSensOfs)

Graphically shows Velocity Sensitivity Offset setting for each Part.

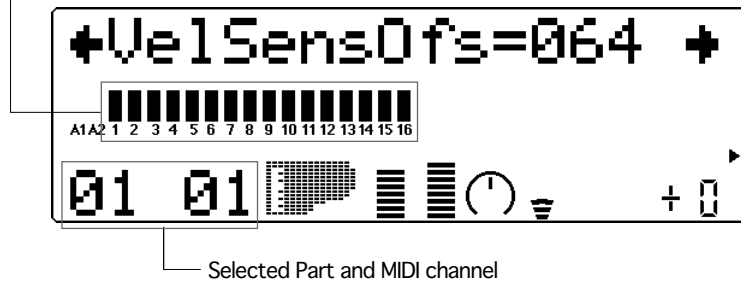

Range: 0 — 127

Default: 64

This determines the volume range over which velocity affects. For lower values, the velocity affects a volume range from minimum to medium-loud. For higher values, velocity affects a range from medium-soft to maximum.

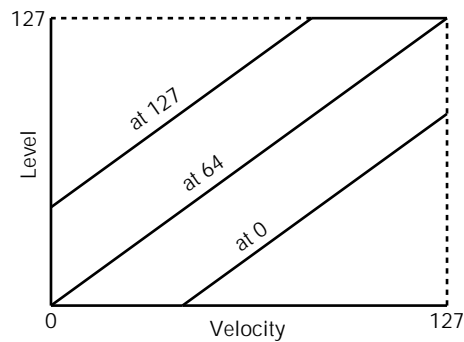

NOTE

Depending on the Voice used, if Velocity Sensitivity Offset is set to too low of a value, the Voice may not sound, no matter how strong the velocity.

Note Limit Parameters

The Note Limit Low and High parameters allow you to set the range of notes for a Part's Voice. Notes outside the range will not be played.

HINT

Note Limit can be used to set up keyboard splits. Set two Parts to the same MIDI channel (see page 36), but give them Note Limit settings so that one Part is played from the left side of the keyboard and the other is played from the right.

Note Limit Low (NoteLimitL)

Graphically shows Note Limit Low setting for each Part.

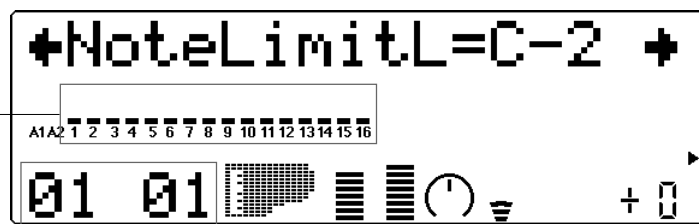

Selected Part and MIDI channel

Range: C-2 — G8

Default: C-2

This determines the lowest responding note for the Part. Notes below this value will not be played.

Note Limit High (NoteLimitH)

Graphically shows Note Limit High setting for each Part.

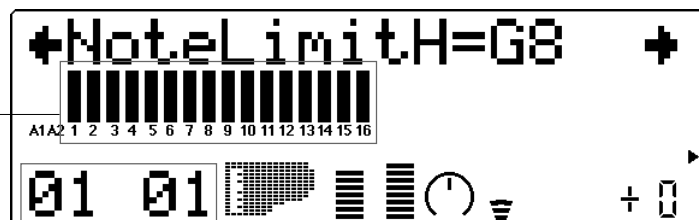

Selected Part and MIDI channel

Range: C-2 — G8

Default: G8

This determines the highest responding note for the Part. Notes above this value will not be played.

Portamento Parameters

Portamento is a function that creates a smooth pitch glide from one note to another.

Portamento Switch (PortamntSw)

Height of bars indicates selected Portamento Switch setting for each Part. (A single bar indicates “off” setting, while full height indicates “on.”)

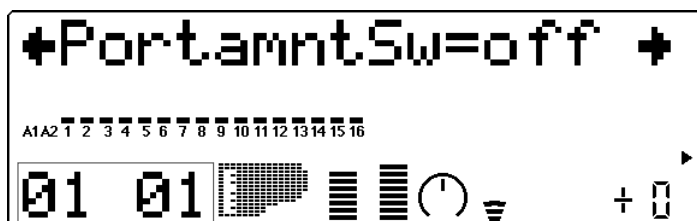

Selected Part and MIDI channel

Settings: off, on

Default: off

This determines whether Portamento is on or off for the Part. (This parameter is not available for Drum Parts.)

Portamento Time (PortamntTm)

Graphically shows Portamento Time setting for each Part.

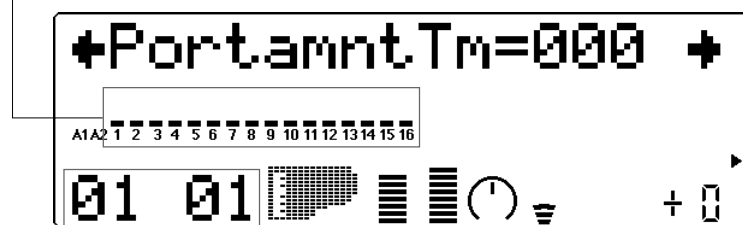

Selected Part and MIDI channel

Range: 0 — 127

Default: 0

This determines the time of the Portamento effect, or how long it takes to glide the pitch from one note to the next. Higher values result in a longer pitch glide time. (This parameter is not available for Drum Parts.)

Velocity Limit Parameters

The Velocity Limit Low and High parameters allow you to set the effective velocity range for a Part’s Voice. Velocity values outside the range will not be played. (Velocity is generally the strength at which notes are played from a MIDI keyboard.)

HINT

Velocity Limit can be used to set up velocity splits. A velocity split allows you to have one Part's Voice sound when you play the connected keyboard strongly, and a different Voice sound when you play softly. Set two Parts to the same MIDI channel (see page 36), but give them different Velocity Limit settings so that one or the other sounds depending on how strongly you play the keyboard.

Velocity Limit Low (VelLimitLo)

Graphically shows Velocity Limit Low setting for each Part.

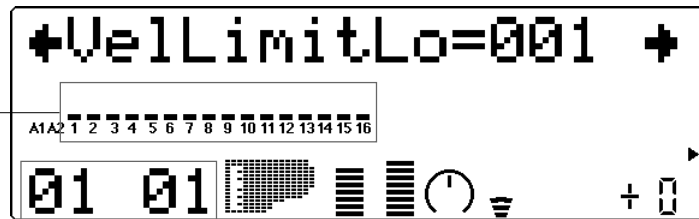

Selected Part and MIDI channel

Range: 1 — 127

Default: 1

This determines the lowest velocity value at which the Part's Voice will play. The higher the value, the harder the keyboard must be played for the Voice to sound.

Velocity Limit High (VelLimitHi)

Graphically shows Velocity Limit High setting for each Part.

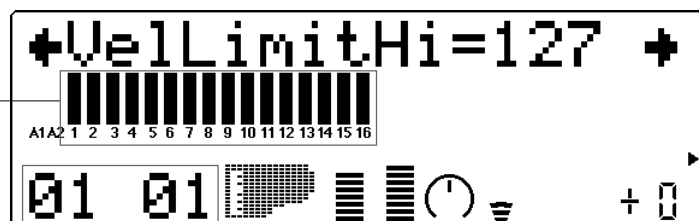

Selected Part and MIDI channel

Range: 1 — 127

Default: 127

This determines the highest velocity value at which the Part's Voice will play. The lower the value, the less strength needed (in playing the keyboard) to get maximum volume.

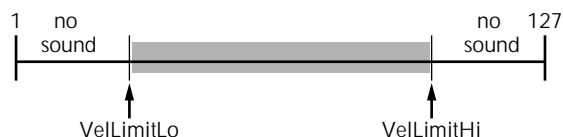

Dry Level

Range: 0 — 127

Default: 127

This determines the level of the unprocessed sound of the Voice (sound with no effect processing). This parameter is only available when the **Variation Connection** parameter is set to **SYS**. (See page 92.)

Pitch Bend Control (PitBndCtrl)

Graphically shows Pitch Bend Control setting for each Part.

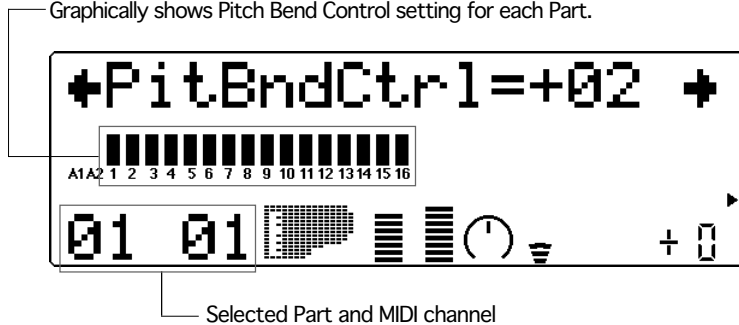

Range: -24 — +24 semitones (+/- 2 octaves)

Default: +2

This determines the Pitch Bend range for the Part's Voice. (Pitch Bend is usually controlled by a pitch bend wheel on a MIDI keyboard.)

Modulation Wheel — LFO Pitch Modulation Depth (MW LFOPMod)

Graphically shows LFO Pitch Modulation Depth setting for each Part.

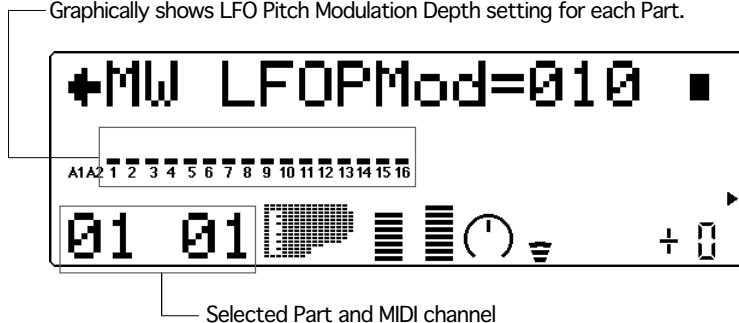

Range: 0 — 127

Default: 10

This determines how widely the pitch is modulated by the LFO (low frequency oscillator). This is generally controlled from a modulation wheel on a MIDI keyboard and produces a vibrato effect. The higher the value, the deeper the pitch modulation, and hence, the more pronounced the vibrato effect.

Drum Setup Controls

The Drum Setup controls allow you to make a wide variety of settings for the drum sounds in a Drum Part. These settings include Pitch controls, Level, Pan, effect send, filter controls and EG (Envelope Generator), among others. Moreover, these parameters can be set to completely independent values for each of the drum sounds in a Part.

Calling Up the Drum Setup Menu

To call up the Drum Setup menu, select a Part for which a Drum Part has been assigned. The Drum Setup controls automatically come up in the Edit mode. For example, if Part 10 is assigned a Drum Part, the Drum Setup menu will appear in the main Edit menu:



Use the **SELECT** buttons to select “DRUM” in the display, and press the **ENTER** button.

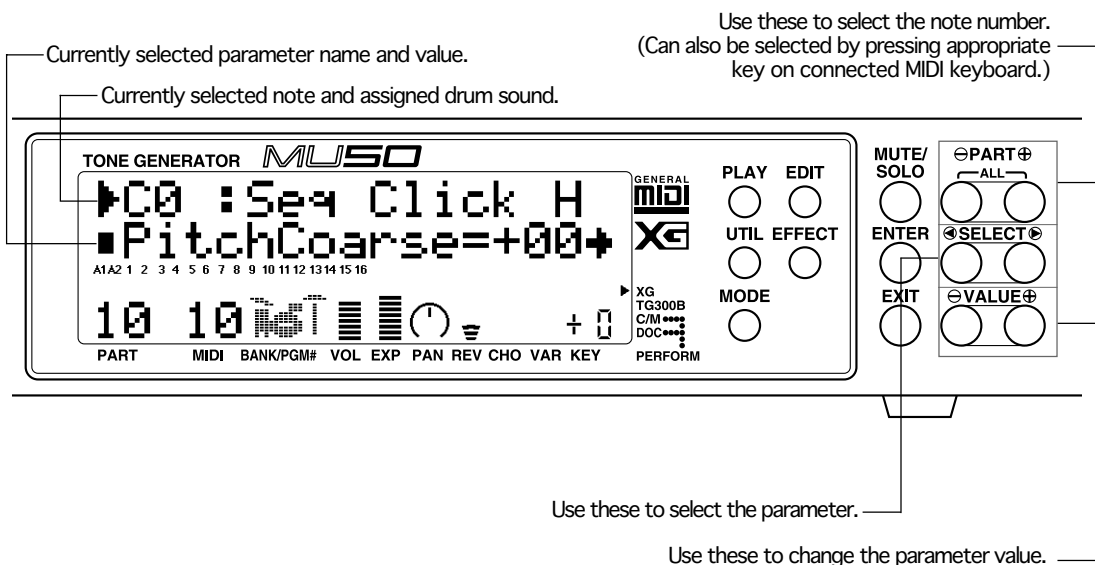

Operation

- 1 Select the desired note number and its assigned drum sound with the **PART** buttons.

For a list of the available sounds and their note assignments, see the **SOUND LIST & MIDI DATA** booklet.

HINT

You can also select the desired note number by simply pressing the appropriate key on a connected MIDI keyboard.

- 2 Select the desired parameter with the **SELECT** buttons. Refer to the descriptions below for details on the individual parameters.
- 3 Change the parameter value with the **VALUE** buttons.

Drum Setup Parameters

Pitch Coarse

Range: -64 — +63

This determines the coarse pitch setting of the selected drum sound. This parameter is only available when the Part Mode has been set to drumS1 or drumS2. (See page 53.)

Pitch Fine

Range: -64 — +63

This determines the fine pitch setting of the selected drum sound.

Level

Range: 0 — 127

This determines the volume of the selected drum sound.

Pan

Settings: Rnd (Random), L63 — C — R63

This determines the stereo position of the selected drum sound. A setting of “Rnd” (Random) randomly assigns the drum to a pan position. This is useful when you want to have different drums sound from different random parts of the stereo image.

Reverb Send (Rev Send)

Range: 0 — 127

This determines the level of the selected drum sound that is sent to the Reverb effect. A value of 0 results in a completely “dry” drum sound, no matter how much Reverb is applied to the Drum Part.

NOTE

Keep in mind that the Reverb effect must be properly enabled and set for this parameter to work as intended. (See page 86.) Also, the parameters Reverb Send in Single Part control (page 38) and Reverb Return in All Part control (page 41) must be set to appropriate values.

Chorus Send (Cho Send)

Range: 0 — 127

This determines the level of the selected drum sound that is sent to the Chorus effect. A value of 0 results in a completely “dry” drum sound, no matter how much Chorus is applied to the Drum Part.

NOTE

Keep in mind that the Chorus effect must be properly enabled and set for this parameter to work as intended. (See page 88.) Also, the parameters Chorus Send in Single Part control (page 39) and Chorus Return in All Part control (page 41) must be set to appropriate values.

Variation Send (Var Send)

Settings: **off, on** (when **Variation Connection** is set to **INS**);
0 — 127 (when **Variation Connection** is set to **SYS**)

This determines the level of the selected drum sound that is sent to the Variation effect. A setting of off results in a completely “dry” drum sound, no matter how much Variation is applied to the Drum Part.

NOTE

Keep in mind that the Variation effect must be properly enabled and set for this parameter to work as intended. (See page 89.) Also, the Variation Send parameter in the Part controls must be set to on. (See page 39.)

Cutoff Frequency (CutoffFreq)

Range: -64 — +63

This determines the cutoff frequency of the filter applied to the selected drum sound, or the frequency point around which other frequencies are filtered out. Lower cutoff values create a deeper, more rounded tone, while higher values create a thinner, brighter tone.

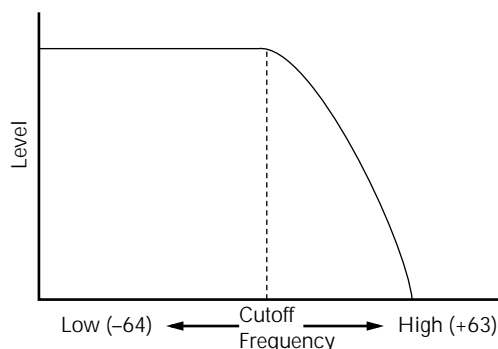

Resonance

Range: -64 — +63

This determines the amount of filter resonance or emphasis of the Cutoff Frequency parameter above. Higher values increase the emphasis of the Cutoff Frequency, producing a higher resonant peak, while lower values produce a relatively flat response.

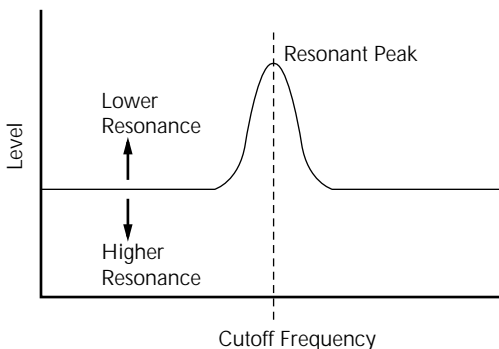

Alternate Group (AlterGroup)

Settings: off, 1 — 127

This determines the group assignment of the selected drum sound. Drums assigned to the same group cannot be sounded simultaneously. In other words, if one drum in a group is sounding while a second in the same group is played, the first drum sound will be cut off and the second will sound.

HINT

The main use for this parameter is in creating realistic hi-hat sounds. By assigning an open hi-hat and a closed hi-hat to the same group, you can “choke” or stop the open hi-hat sound by simply playing the closed hi-hat — just like pressing the pedal on an actual hi-hat set.

Receive Note On (RcvNoteOn)

Settings: on, off

Default: on

This determines how the selected drum sound responds to MIDI Note On messages. Normally, this should be set to **on** so that the corresponding drum sound plays when a MIDI Note On message is received. Set this to **off** when you want to keep the selected drum sound from playing.

Receive Note Off

Settings: on, off

This determines how the selected drum sound responds to MIDI Note Off messages. When this is set to on, the selected sound will stop in response to the corresponding MIDI Note Off message. An on setting is good for some sustained sounds (like a whistle), or for key-controlled cymbal “chokes.” For most drum sounds, however, this should be set to off so that the drum sound plays back in its entirety (is not cut off).

EG Attack Rate

Range: -64 — +63

This determines the Attack Rate of the EG (Envelope Generator), or how long it takes for the sound of the selected drum sound to reach full volume when a note is played. (See illustration below.)

EG Decay 1 Rate

Range: -64 — +63

This determines the Decay 1 rate of the EG, or how rapidly the sound dies down to the Decay 2 level. (See illustration below.) Higher values result in a shorter Decay time.

EG Decay 2 Rate

Range: -64 — +63

This determines the Decay 2 rate of the EG, or how rapidly the sound dies out completely. (See illustration below.) Higher values result in a shorter Decay time.

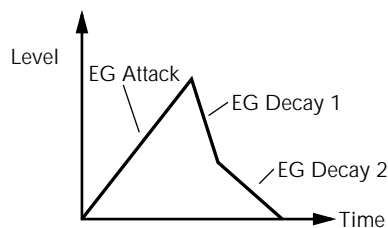



Performance Mode

In the Performance mode, the MU50 performs as a four-Part tone generator, with all Parts controlled over a single MIDI channel. The Performance mode is so named because it's ideally suited to live performance situations. It allows you to play four different Voices at the same time from your MIDI keyboard — either in a layer, or in sophisticated keyboard and velocity splits. It also gives you comprehensive control over each of the four Parts for maximum performance flexibility. A total of 256 Performances are available: 32 × 4 Preset and 128 Internal.

NOTE

Drum Parts are not available in the Performance mode.

Performance Play Mode

To set the Performance mode and call up Performance Play:

- 1 Press the **MODE** button.

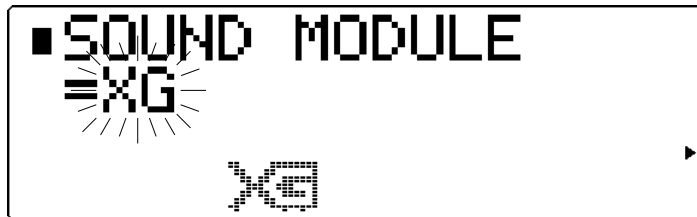

- 2 Use the **VALUE** button to select "PERFORM" (PERFORMANCE).
- 3 Press the **EXIT** button or the **PLAY** button to return to the Play display.

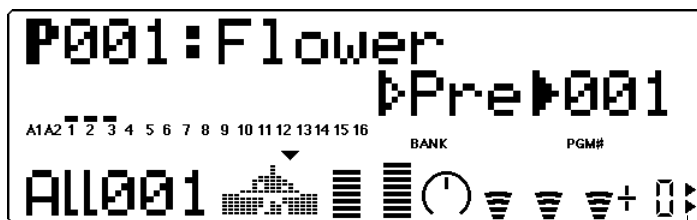

Indicates Performance mode.

XG
TG300B
C/M
DOC
PERFORM

Selecting a Performance and its Individual Parts

To call up a Preset or Internal Performance and select individual Parts of that Performance:

- 1 From the Performance Play mode (see section above), press the **PART** buttons simultaneously, so that the All Part display is shown.

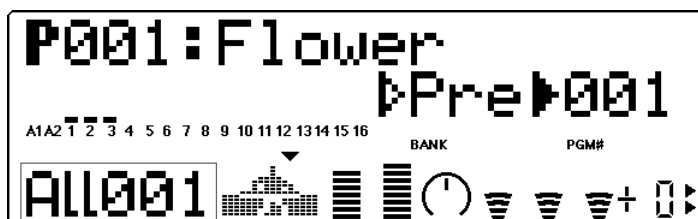

Indicates All Part display.

NOTE

The display is automatically set to All Part when the Performance Play mode is selected.

- 2 Use the **SELECT** buttons to select the Bank parameter, then use the **VALUE** buttons to select the desired bank, Preset (Pre) or Internal (Int).

Preset bank:

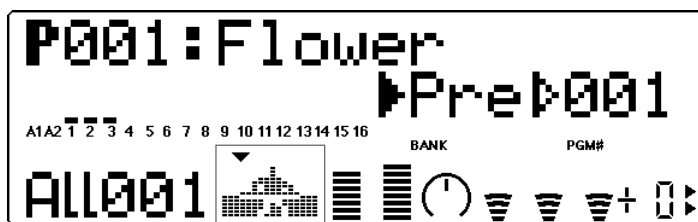

Bottom half of keyboard player icon is shown in reverse display to indicate Preset Performance bank.

Internal bank:

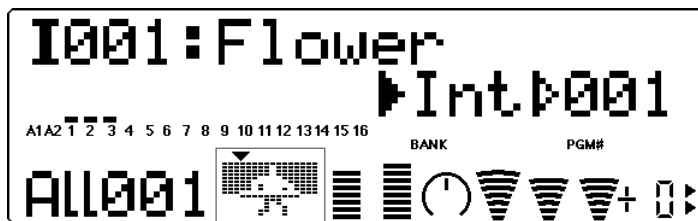

Top half of keyboard player icon is shown in reverse display to indicate Internal Performance bank.

- Use the **SELECT** buttons to select the Program Number parameter, then use the **VALUE** buttons to select the desired Performance number.

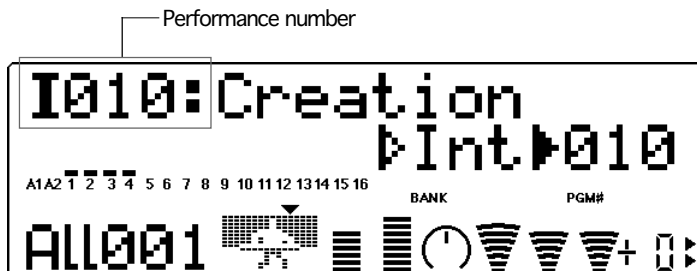

- From the All Part display, press the **PART** buttons simultaneously, so that the Single Part display is shown.

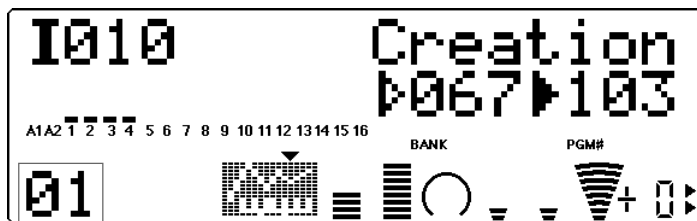

- Select the desired Part by using the **PART** buttons.
- Select the desired Voice bank for the Part by using the **SELECT** buttons to select the Bank parameter, and using the **VALUE** buttons to change the bank number.
- Select the desired Voice for the Part by using the **SELECT** buttons to select the Program Number parameter, and using the **VALUE** buttons to change the Voice number.

To return to the All Part display from the Single Part display, either press the **PART** buttons simultaneously, or press the **EXIT** button.

Performance Part Control

Single Part

Bank Number



Settings:

XG: 000, 001, 003, 006, 008, 012, 014, 016 — 020, 024, 025, 027, 028, 032 — 043, 045, 064 — 072, 096 — 101, SFX

This determines the bank number of the selected Part's Voice. Each bank contains 128 Voices. (Refer to the **SOUND LIST & MIDI DATA** booklet.)

Program (Voice) Number



Range: 1 — 128

This determines the Voice for the selected Part. (Refer to the **SOUND LIST & MIDI DATA** booklet.)

Volume

Graphically indicates current Volume setting.

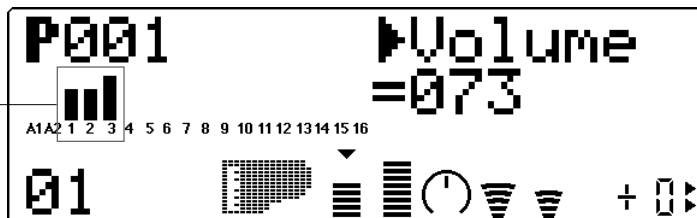

Range: 0 — 127

This determines the Volume setting for the selected Part's Voice.

Pan

Graphically indicates current Pan setting.

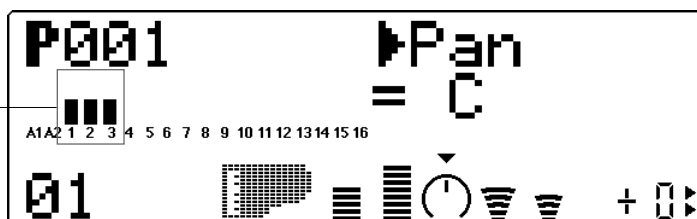

Settings: Rnd (Random), L63 — C — R63

This determines the stereo position of the selected Part's Voice. A setting of "Rnd" (Random) randomly assigns the Voice to a pan position. This is useful when you want to have different Voices sound from different random parts of the stereo image.

Reverb Send (Rev Send)

Graphically indicates current Reverb Send setting.

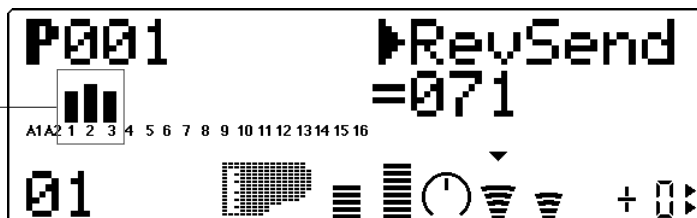

Range: 0 — 127

This determines the level of the selected Part's Voice that is sent to the Reverb effect. A value of 0 results in a completely "dry" Voice sound.

NOTE

Keep in mind that the Reverb effect must be properly enabled and set for this parameter to work as intended. (See page 86.)

Chorus Send (Cho Send)

Graphically indicates current Chorus Send setting.

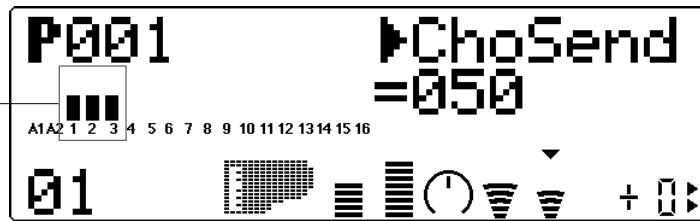

Range: 0 — 127

This determines the level of the selected Part's Voice that is sent to the Chorus effect. A value of 0 results in a completely "dry" Voice sound (no Chorus effect).

NOTE

Keep in mind that the Chorus effect must be properly enabled and set for this parameter to work as intended. (See page 88.)

Variation Send (Var Send)

Graphically indicates current Variation Send setting.

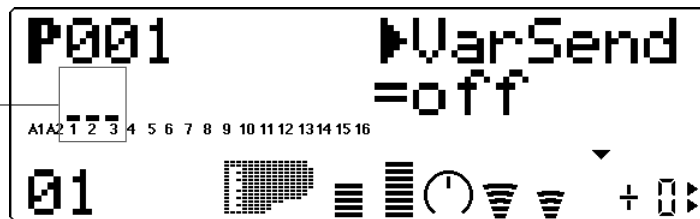

Settings: **off**, **on** (when **Variation Connection** is set to **INS**);
0 — 127 (when **Variation Connection** is set to **SYS**)

This determines whether the selected Part's Voice is sent to the Variation effect or not. A setting of **off** or **0** results in no Variation effect being applied to the Voice.

Note Shift (NoteSft)

Graphically indicates current Note Shift setting.

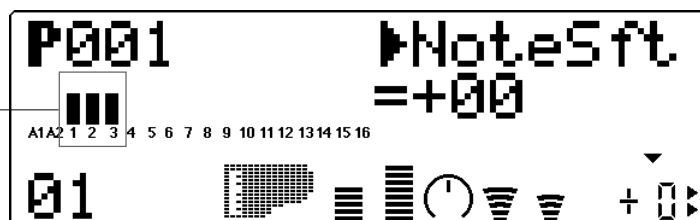

Range: -24 — +24 semitones

This determines the key transposition setting for the Part's Voice.

All Part

System MIDI Channel (Sys CH)

Graphically indicates current System MIDI Channel setting.

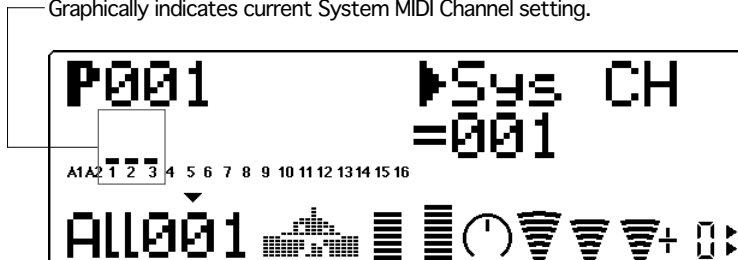

Settings: 1 — 16, all

This determines the MIDI receive channel for all Parts of the Performance. When this is set to “all,” the Performance responds over any incoming MIDI channel.

Performance Bank

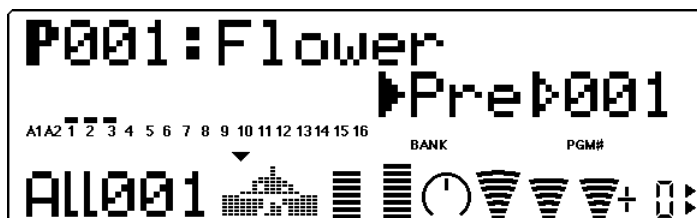

Settings: Pre (Preset), Int (Internal)

This determines the bank of Performance programs: Preset or Internal. Preset Performances are those that have been created and loaded at the factory; the Internal bank is reserved for user-created Performances.

Performance Number

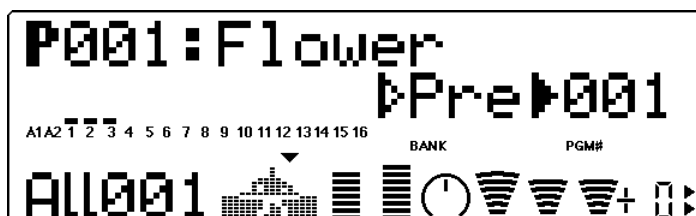

Range: 1 — 128

This determines the Performance number.

Performance Volume (Pfm Vol)

Graphically indicates current Performance Volume setting.

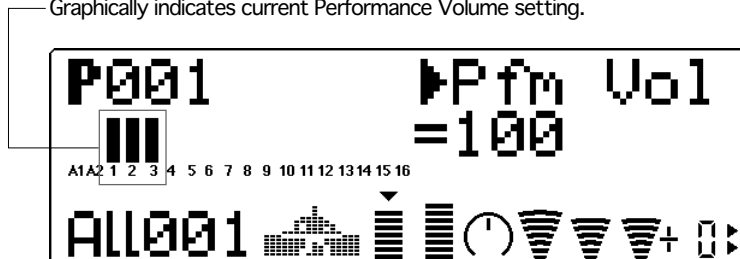

Range: 0 — 127

This determines the overall Volume of the Performance.

Performance Pan (Pfm Pan)

Graphically indicates current Performance Pan setting.

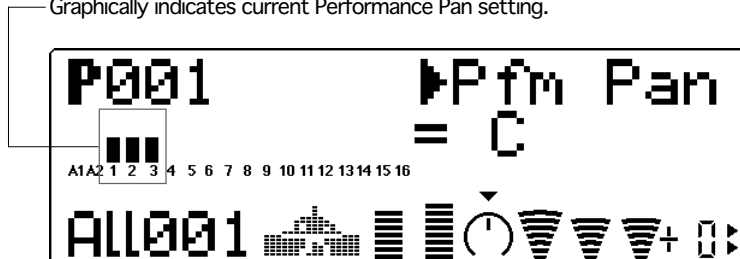

Range: L63 — C — R63

This determines the overall Pan position of the Performance.

Reverb Return (RevRtn)

Graphically indicates current Reverb Return setting.

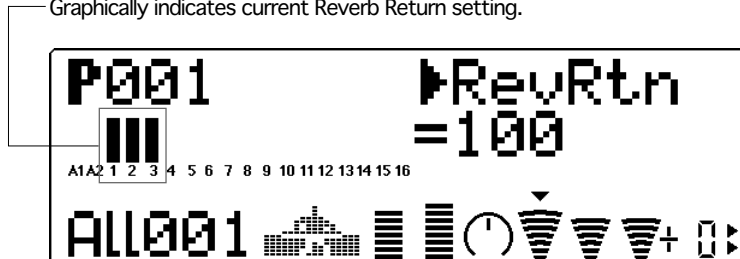

Range: 0 — 127

This determines the amount of Reverb return for the Performance in the overall mix.

Chorus Return (ChoRtn)

Graphically indicates current Chorus Return setting.

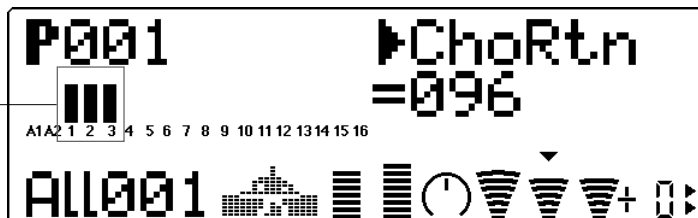

Range: 0 — 127

This determines the amount of Chorus return for the Performance in the overall mix.

Variation Return (VarRtn)

Graphically indicates current Variation Return setting.

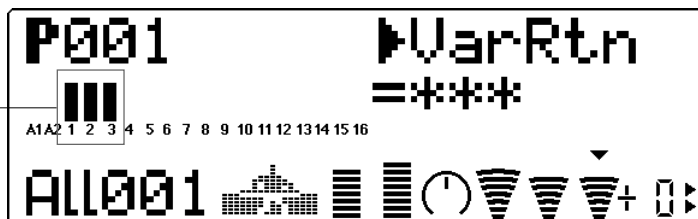

Range: 0 — 127

This determines the amount of Variation return in the overall mix of the Performance. Variation Return is only available when the **Variation Connection** parameter is set to **SYS**. (See page 92.)

System Transpose (SysTran)

Graphically indicates current Transpose setting.

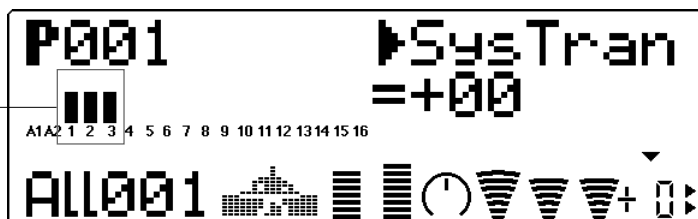

Range: -24 — +24 semitones

This determines the overall Transpose setting of the Performance.

Performance Edit Mode

The Performance Edit mode features various functions and parameters, grouped in the following sections: Common (related to the Performance as a whole), Part (related to each of the four Parts), and the Copy and Store operations.

To enter the Performance Edit mode, press the **EDIT** button (from the Performance Play mode). The following menu appears:



Common

The Common parameters allow you to name a Performance, and set the control change number for realtime parameter control.

Performance Name (Perform Name)



This allows you to give a name to your edited Performance.

Operation

- 1 From the Performance Name display, press the **ENTER** button.



- 2 Use the **SELECT** buttons to select the character position (flashing character) in the name and use the **VALUE** buttons to change the character at that position.

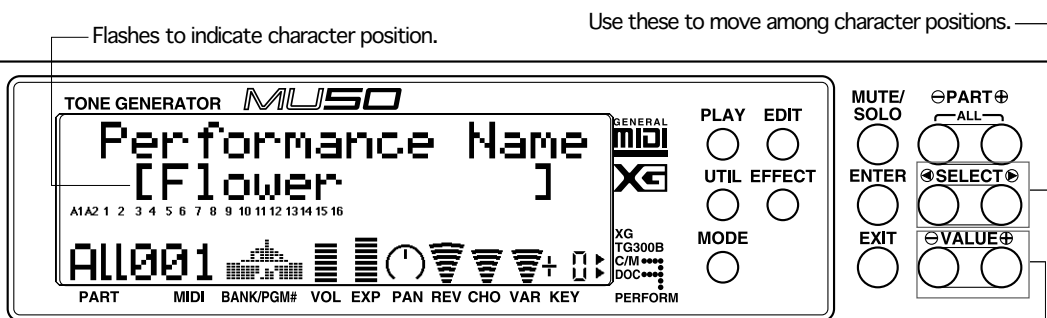

Up to 12 characters can be used for the Performance name. Available characters include all letters of the alphabet, in both upper and lower case, numbers from 0 to 9, and a variety of miscellaneous characters.

(Space) ABCDEFGHIJKLMNOPQRSTUVWXYZ
 abcdefghijklmnopqrstuvwxyz
 0123456789! " # \$ % & ' () * + , - . / :
 ; < = > ? @ [\] ^ _ ` { | } ~ +

- 3 Press the **EXIT** button to return to the previous display (or press the **PLAY** button to return to the Play display).

After creating and naming a Performance, you'll probably want to save that Performance for future recall. For instructions on saving a Performance, refer to the Store operation on page 84.

Assignable Controller1 Control Change Number (AC1 CC No.)

Graphically indicates Control Change Number setting.



Range: 0 — 95

This determines which Control Change number will be used for Assignable Controller 1 in the Performance. Assignable Controller 1 can be used to affect the Filter (page 43), the Amplitude or the Variation effect (page 90).

HINT

Though this parameter allows you to assign any control change number from 0 to 95, only a few of these are in common use. The controllers most likely to be encountered include:

- 01 — Modulation wheel or lever
- 02 — Breath controller
- 04 — Foot controller
- 07 — Volume controller

Some or all of these may be available on your MIDI instrument, and can be used to control certain functions on the MU50 in real time. Some MIDI instruments allow you to change the control change number for a particular controller: for example, setting the modulation wheel (normally 01) to control Volume (07). Refer to the owner's manual of your particular instrument for more information.

Part

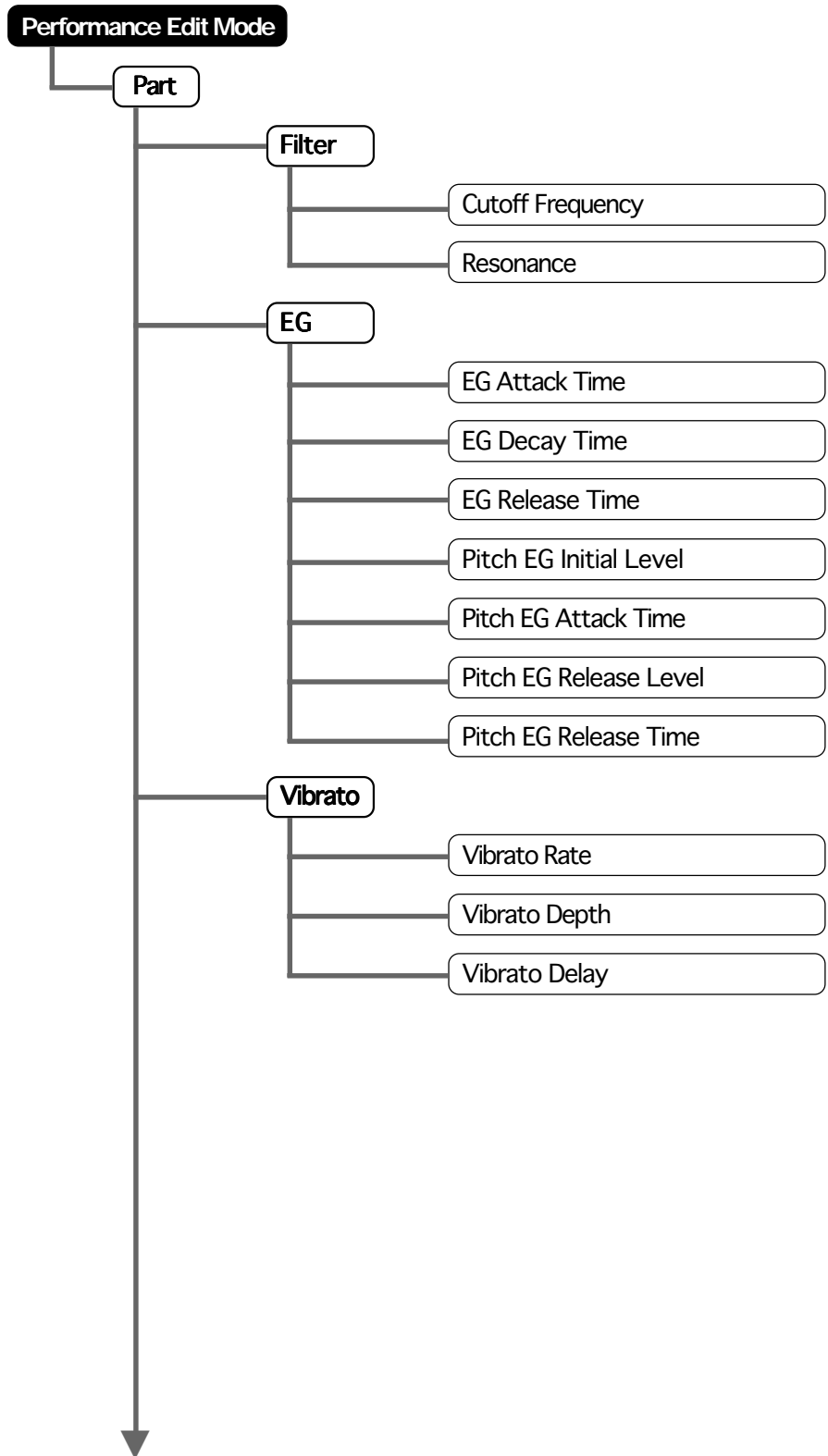

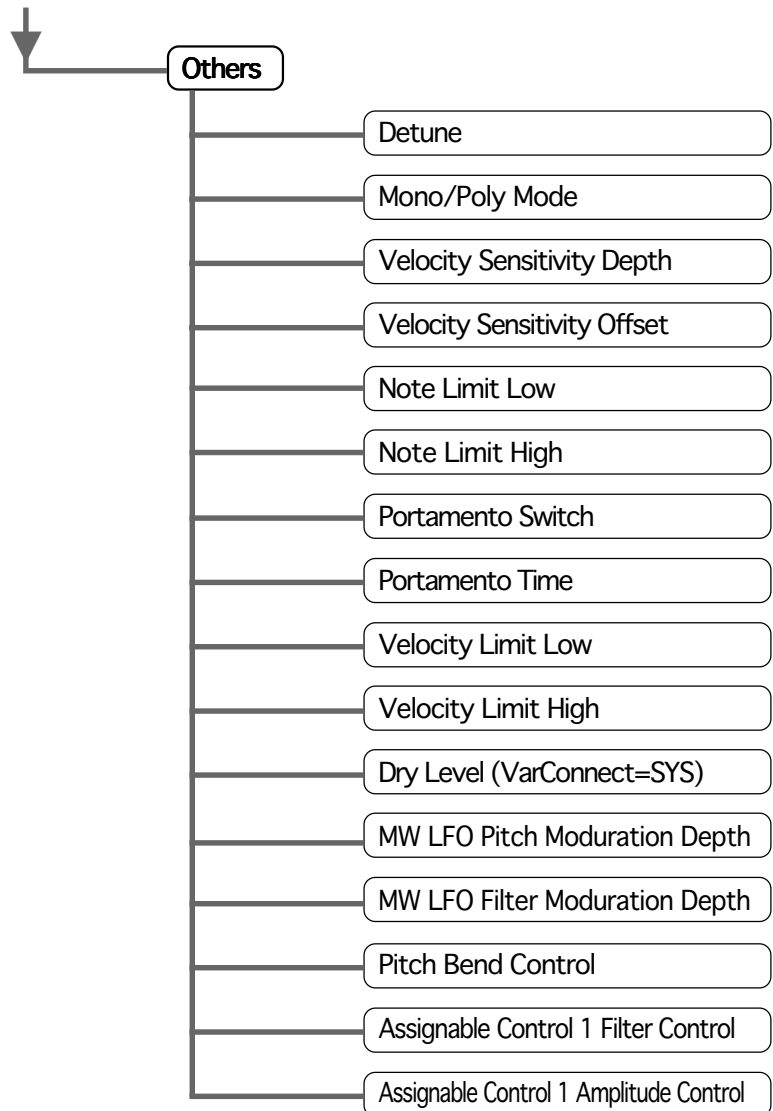

The Part menu contains the Filter, EG, Vibrato and Others parameters for the Performance.

Filter

The Filter section of Performance Edit parameters are the same as the corresponding parameters in the Multi Edit mode. (See page 43.)

EG

The EG section of Performance Edit parameters are the same as the corresponding parameters in the Multi Edit mode. (See page 45.)

Vibrato

The Vibrato section of Performance Edit parameters are the same as the corresponding parameters in the Multi Edit mode. (See page 52.)

Others

The Others section of Performance Edit parameters contains miscellaneous controls, including those related to tuning, velocity, portamento, note range, etc. With a few additional parameters, these are the same as the parameters in the Multi Edit mode.

NOTE

The Part Edit parameter (available in Multi Edit) is not available in Performance Edit mode. No Drum Parts can be selected for a Performance.

Detune

Same as the corresponding parameter in the Multi Edit mode. (See page 52.)

Mono/Poly Mode

Same as the corresponding parameter in the Multi Edit mode. (See page 54.)

Velocity Sensitivity Depth (VelSensDpt)

Same as the corresponding parameter in the Multi Edit mode. (See page 55.)

Velocity Sensitivity Offset (VelSensOfs)

Same as the corresponding parameter in the Multi Edit mode. (See page 56.)

Note Limit Low (NoteLimitL)

Same as the corresponding parameter in the Multi Edit mode. (See page 57.)

Note Limit High (NoteLimitH)

Same as the corresponding parameter in the Multi Edit mode. (See page 57.)

Portamento Switch (PortametSw)

Same as the corresponding parameter in the Multi Edit mode. (See page 58.)

Portamento Time (PortametM)

Same as the corresponding parameter in the Multi Edit mode. (See page 58.)

Velocity Limit Low (VelLimitLo)

Same as the corresponding parameter in the Multi Edit mode. (See page 59.)

Velocity Limit High (VelLimitHi)

Same as the corresponding parameter in the Multi Edit mode. (See page 59.)

Dry Level

Same as the corresponding parameter in the Multi Edit mode. (See page 60.) This parameter is only available when the **Variation Connection** parameter is set to **SYS**. (See page 92.)

Modulation Wheel — LFO Pitch Modulation Depth (MWLFO PMod)

Same as the corresponding parameter in the Multi Edit mode. (See page 60.)

Modulation Wheel — LFO Filter Modulation Depth (MWLFO FMod)

Graphically shows LFO Filter Modulation Depth setting for each Part.

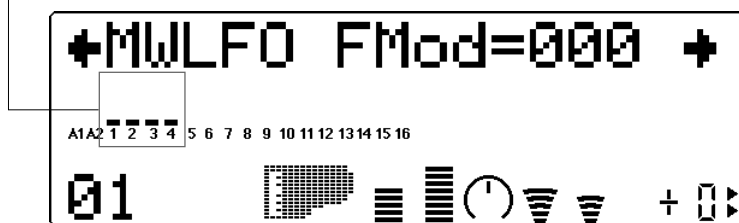

Range: 0 — 127

This determines how widely the filter is modulated by the LFO (low frequency oscillator). This is generally controlled from a modulation wheel on a MIDI keyboard and, depending on the character of the sound, produces a “swoosh” filter sweep effect. The higher the value, the deeper the filter modulation, and hence, the more pronounced the filter sweep effect.

Pitch Bend Control (PitBndCtrl)

Same as the corresponding parameter in the Multi Edit mode. (See page 60.)

Assignable Control 1 Filter Control (AC1FilCtrl)

Graphically shows AC1 Filter Control setting for each Part.



Range: -64 — +63

This determines the degree to which Assignable Controller 1 affects the Filter. A setting of 0 results in no control over the Filter. Negative settings affect the Filter negatively; in other words, when the controller is at the minimum position, control over the filter is greatest.

In the illustration below, a foot controller is used as Assignable Controller 1.

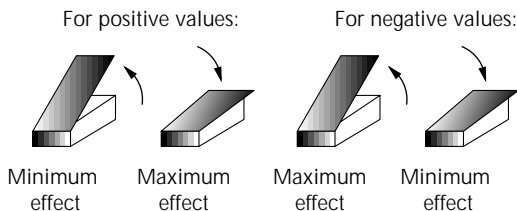

Assignable Control 1 Amplitude Control (AC1AmpCtrl)

Graphically shows AC1 Amplitude Control setting for each Part.



Range: -64 — +63

This determines the degree to which Assignable Controller 1 affects the Amplitude (level or volume). A setting of 0 results in no control over the Amplitude. Negative settings affect the Amplitude negatively; in other words, when the controller is at the minimum position, control over the Amplitude is greatest.

Copy and Store Operations

The Copy and Store operations allow you to save and organize the Performances you've created.

Copy

The Copy operation allows you to copy the settings of one Performance program (Preset or Internal) to another Performance number (Internal only).

Operation

- 1 From the Performance Edit menu, use the **SELECT** buttons to select "COPY." Then, press the **ENTER** button to call up the Copy operation.



- 2 Use the **SELECT** buttons to select the desired parameter: memory location, source number or destination number. (The selected parameter flashes.) Then use the **VALUE** buttons to change the value.

Memory location (P = Preset, I = Internal)

Source Performance number

Use these to select desired parameter.

Destination Performance number

Use these to change value.

3 Press the **ENTER** button to actually execute the Copy operation. An “Executing...” message flashes in the display during the operation. When the data has been copied, the MU50 returns to the Performance Edit menu. To cancel the operation without copying, press the **EXIT** button (before pressing **ENTER**).

Store

Once you’ve edited or created a Performance, you can save that new Performance for future recall by using the Store operation. Performances can be saved to any one of the 128 Internal memory locations. With the exception of the Receive Channel and Transpose (Note Shift) settings made from the Play screen, all parameter settings in the Play screen and in the Edit and Effect modes are saved to the selected Performance number.

Operation

- 1** From the Performance Edit menu, use the **SELECT** buttons to select “STORE.” Then, press the **ENTER** button to call up the Store operation.





ENTER



- 2 Use the **VALUE** buttons to change the destination Performance number.

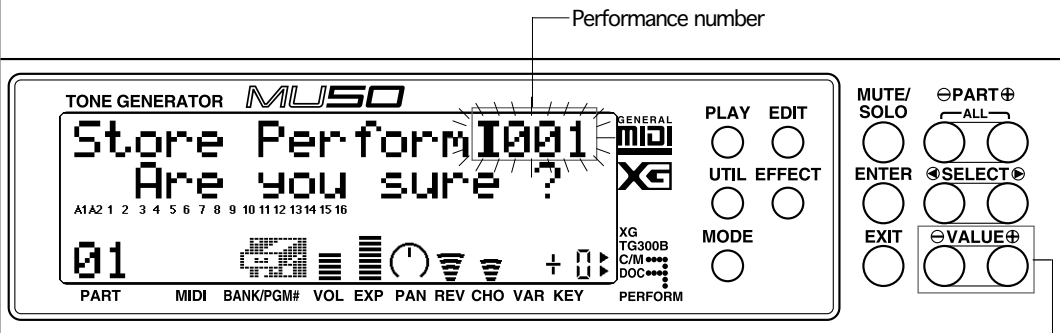

Use these to change Performance number.

- 3 Press the **ENTER** button to actually execute the Store operation. An “Executing...” message flashes in the display during the operation. When the data has been stored, the MU50 returns to the Performance Edit menu. To cancel the operation without saving, press the **EXIT** button (before pressing **ENTER**).



Effect Edit Mode

The MU50 features a built-in multi-effect processor with three independent digital effects: Reverb, Chorus and Variation. These are controlled in the Effect Edit mode.

In this section, only the effect Types and the global parameters common to all Types are covered. For descriptions and details on the parameters for each effect Type, refer to the separate **SOUND LIST & MIDI DATA** booklet.

To enter the Effect Edit mode, press the **EFFECT** button. The following menu appears:



Reverb (REV)

Reverb recreates the sounds of various performance environments by adding an ambient wash of delays or reflections. Several different types of Reverb effects are available to simulate the ambience of different sized rooms.

Explanations of the Reverb Type and Reverb Pan parameters are given below. For descriptions and explanations for all other Reverb parameters, refer to the separate **SOUND LIST & MIDI DATA** booklet.

Type



Settings: NO EFFECT, HALL 1, HALL 2, ROOM 1, ROOM 2, ROOM 3, STAGE 1, STAGE 2, PLATE, WHITE ROOM, TUNNEL, BASEMENT

This determines the Reverb Type. Each Reverb Type has different values for the rest of the Reverb parameters.

NOTE

When **“NO EFFECT”** is selected, Reverb is off and none of the other Reverb parameters are available (with the exception of the Reverb Pan parameter).

HINT

Generally when using Reverb, you can simply select the particular Type needed, and use it without bothering to adjust the other parameters. If fine tuning of the Reverb sound is necessary, delve into the other parameters as needed.

Reverb Pan (RevPan)

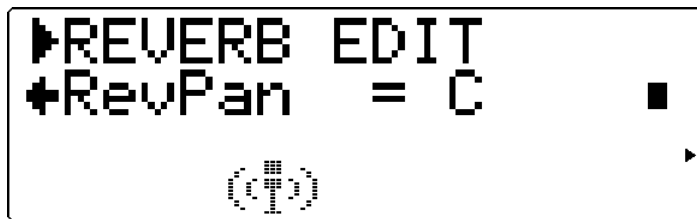

Range: L63 — C — R63

This determines the Pan position of the Reverb sound, or where it appears in the stereo image.

For details on the parameters for each Reverb Type, refer to the separate **SOUND LIST & MIDI DATA** booklet.

Chorus (CHO)

The Chorus section uses pitch modulation to create a variety of rich, spacious-sounding effects, including Chorus, Celeste and Flanger.

Explanations of the Chorus Type and Chorus Pan parameters are given below. For descriptions and explanations for all other Chorus parameters, refer to the separate **SOUND LIST & MIDI DATA** booklet.

Type



Settings: NO EFFECT, CHORUS 1 — 4, CELESTE 1 — 4,
FLANGER 1 — 3

Default: CHORUS 1

This determines the Chorus Type. Depending on the Type selected, the specific parameters and values may differ.

Chorus and Celeste are used to subtly enhance the sound, and generally make it richer, fatter and warmer. Flanger uses modulation to create an animated, swirling motion effect, and produces a characteristic metallic sound.

NOTE

When **NO EFFECT** is selected, Chorus is off and none of the other Chorus parameters are available (with the exception of the Chorus Pan and Send Chorus to Reverb parameters).

Chorus Pan (ChoPan)

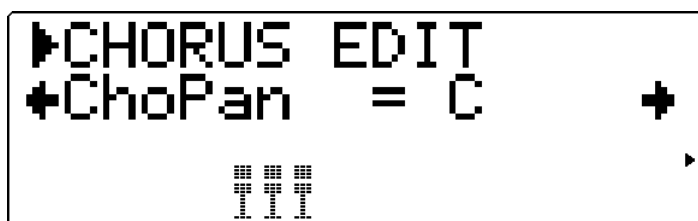

Range: L63 — C — R63

This determines the Pan position of the Chorus sound, or where it appears in the stereo image.

Send Chorus to Reverb (SendCho → Rev)

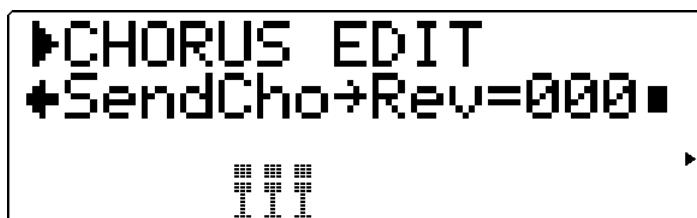

Range: 0 — 127

This determines the level of the Chorus signal sent to and processed by the Reverb effect. A setting of 0 results in none of the Chorus-processed signal going to the Reverb.

HINT

Setting this to a relatively high level gives you a more natural sound, since the Chorus-processed sound is also being processed by the reverb. More unusual effects can be created by having a long Reverb and setting this to 0, so that the Chorus sound is dry (no Reverb) and the original sound is “drenched” in Reverb.

For details on the parameters for each Chorus Type, refer to the separate **SOUND LIST & MIDI DATA** booklet.

Variation (VAR)

The Variation section provides a wealth of additional effects for processing the Voices of the MU50. It features some of the same effects found in the Reverb and Chorus sections. This is not mere redundancy; it allows you to use two types of Reverb or Chorus on different Voices. For example, you may want to have the Flanger effect on one Voice and Phaser on another. Variation also gives you many special effects not found in the other sections, such as Delay, Gate Reverb, Distortion, and Wah.

The Variation section of effects can be applied either to a single selected Part or to all Parts, depending on the connection setting: Insertion or System. (See **About the Effect Connections — System and Insertion** on page 92 for more information.)

Explanations of the Variation Type and other common parameters are given below. For specific descriptions of Variation Types and explanations for all other Variation parameters, refer to the separate **SOUND LIST & MIDI DATA** booklet.

Type



Settings: NO EFFECT; HALL 1 & 2; ROOM 1 — 3; STAGE 1 & 2; PLATE; DELAY LCR; DELAY L,R; ECHO; CROSS DELAY; EARLY REFLECTION 1 & 2; GATE REVERB; REVERSE GATE; KARAOKE 1 — 3; CHORUS 1 — 4; CELESTE 1 — 4; FLANGER 1 — 3; SYMPHONIC; ROTARY SPEAKER; TREMOLO; AUTO PAN; PHASER 1 — 2; DISTORTION; OVERDRIVE; AMP SIMULATOR; 3-BAND EQ; 2-BAND EQ; THRU

NOTE

When **NO EFFECT** or **THRU** is selected for the Type, no Variation effect is applied, and only the common parameters shown below are available (with the exception of **Dry/Wet**).

The **NO EFFECT** setting cancels the Variation effect. When the Variation Connection is set to **SYS** (System), the sound can be heard with no effect. When the Variation Connection is set to **INS** (Insertion), no sound is output for the Part.

When set to **THRU**, the sound of the Part (or Parts) is output without any Variation effect. Generally, when Variation Connection is set to **INS** (Insertion), you should set the Type to **Thru**. When Variation Connection is set to **SYS** (System), you should set the Type to **NO EFFECT**.

Common Parameters (Insertion connection):

Dry/Wet

Range: D63>W — (D=W) — D<W63

Adjusts the level balance of original sound (dry, or **D**) and processed sound (wet, or **W**). A setting of (**D=W**) results in an equal balance of dry and wet sound.

Assignable Controller 1 Variation Control (AC1VarCtrl)

Range: 0 — 127

Determines the amount of effect the Assignable Controller has on the Variation effect.

Common Parameters (System connection):

Variation Pan (VarPan)

Range: L63 — C — R63

Determines the pan position of the Variation effect.

Send Variation to Chorus (SendVar→Cho)

Range: 0 — 127

Determines the amount of Variation effect sound that is sent to the Chorus effect.

Send Variation to Reverb (SendVar→Rev)

Range: 0 — 127

Determines the amount of Variation effect sound that is sent to the Reverb effect.

Variation Connection (VarConnect)

Settings: INS (Insertion), SYS (System)

Determines how the Variation effect is connected in the effect chain of the MU50. When set to **SYS** (System), Variation is applied to all Parts, according to the amount of Variation Send set for each Part. When set to **INS** (Insertion), Variation is applied to only the selected Part, set in Variation Send. (See page 92.)

NOTE

The common parameters above are common to nearly all the Variation effect types. (Exceptions are described in the separate **SOUND LIST & MIDI DATA** booklet.

About the Effect Connections — System and Insertion

The multi-effects of the MU50 provide not only a wide range of sound processing controls, but also a flexible system for connecting them. Unlike simple effect routing schemes on conventional sound modules that process all voices with the same effects, the MU50 allows you to put independent, special effects on one Part, as well as use overall effects for processing all 16 Parts together. For example, you can have a Wah effect on a guitar Part, yet still use ambient effects such as Reverb and Chorus for processing the overall mix.

All the effect sections are connected or routed in one of two ways: **System** or **Insertion**. System applies the selected effect to all 16 Parts, while Insertion applies the selected effect to one specific Part. Reverb and Chorus, are System effects. The Variation effect section, on the other hand, can be configured for either System or Insertion routing. (This is done from the **Variation Connection** parameter; see page 91.) Since System and Insertion are part of the XG MIDI format, you can create and play back song data using the same flexible effect routings on any tone generator or sound module having the **XG** mark.

NOTE

The **Variation Connection** default setting is Insertion.

The illustrations and explanations below cover the System and Insertion connections in greater detail.

VARIATION CONNECTION = SYSTEM

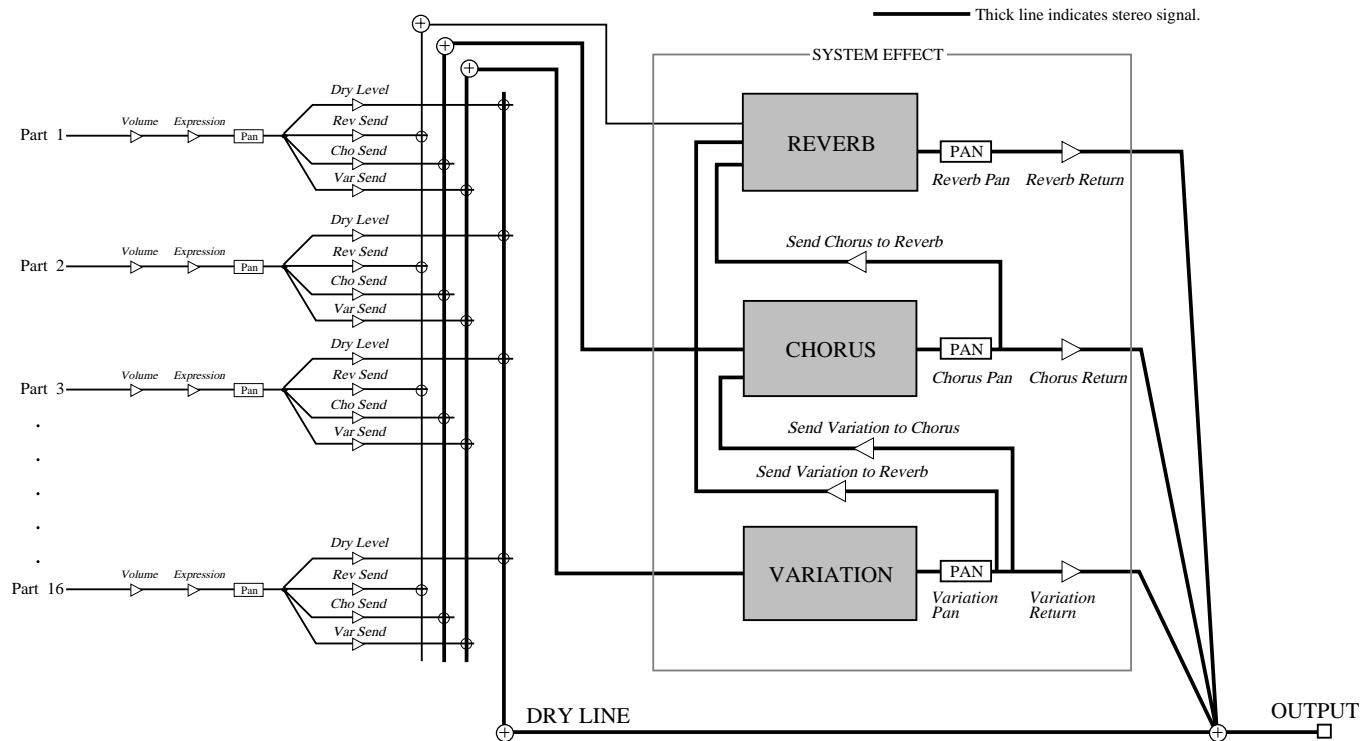

When Variation is set to System:

NOTES

- Even though the System routing applies the selected effect to all Parts, you can control how much the Reverb, Chorus and Variation effects are applied to any individual Part (with the **Reverb Send**, **Chorus Send** and **Variation Send** parameters in the Single Part controls; see pages 38, 39). For the effects to be properly heard, the **Reverb Return**, **Chorus Return** and **Variation Return** parameters in the All Parts controls must also be set to appropriate values (see pages 41, 42).
- The stereo position of the effects is controlled by the **Reverb Pan**, **Chorus Pan** and **Variation Pan** parameters; see pages 87, 88, 91.
- You can set Reverb, Chorus and Variation to be routed in parallel or in serial, and you can determine the amount of Variation effect that is sent to Chorus and Reverb, as well as the amount of Chorus that is sent to Reverb. This is done with the **Send Variation to Chorus** (page 91), **Send Variation to Reverb** (page 91), and **Send Chorus to Reverb** (page 89) parameters. When these are all set to 0, all three effects are in parallel routing. Higher values for each provide varying degrees of serial routing.

When Variation is set to Insertion:

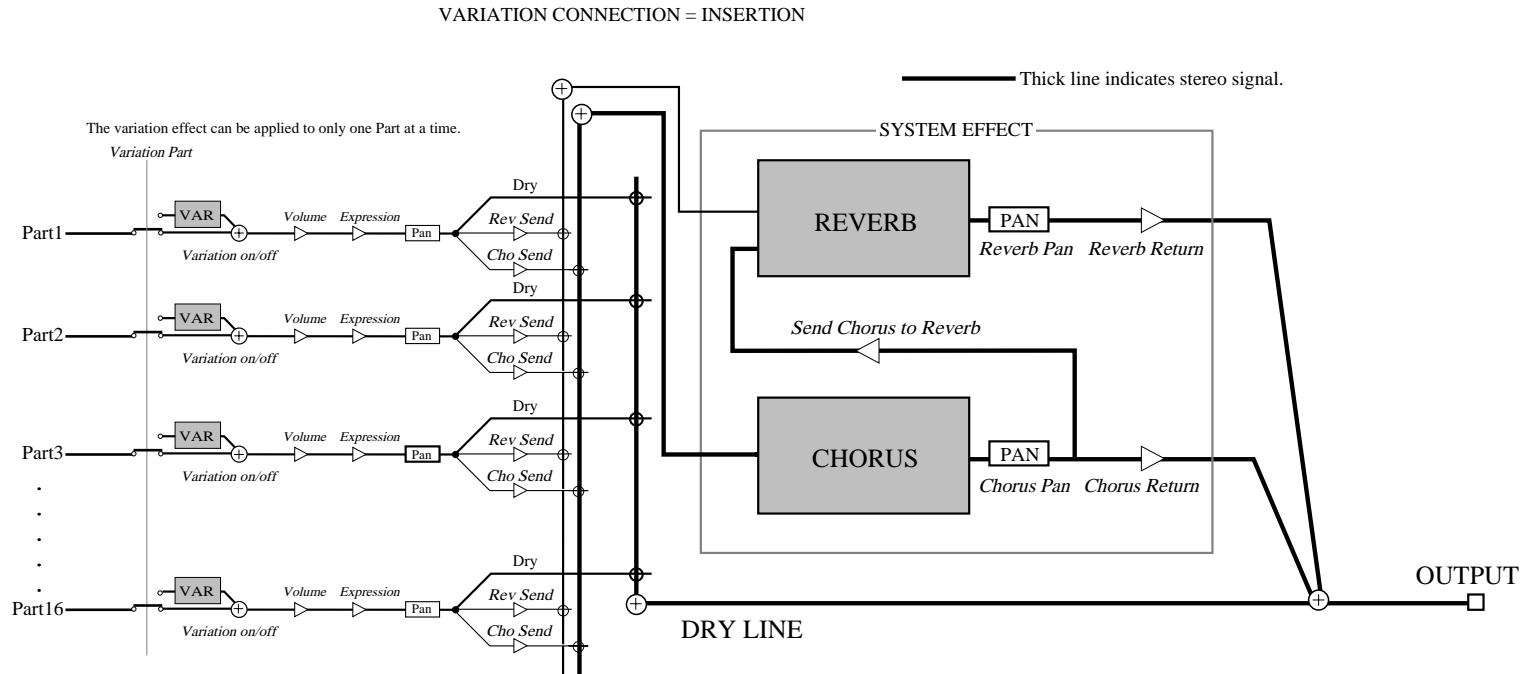

NOTES

- The Part to which Variation is applied is determined by the **Variation Send** control in the Single Part controls (page 39).
- As with System above, the effects cannot be properly heard unless the **Reverb Send**, **Chorus Send** and **Variation Send** parameters in the Single Part controls (pages 38, 39) and the **Reverb Return** and **Chorus Return** parameters in the All Parts controls are set to appropriate values.
- The stereo position of the effects is controlled by the **Reverb Pan** and **Chorus Pan** parameters. (See pages 87, 88.)
- You can set Reverb and Chorus to be routed in parallel or in serial, and you can determine the amount of Chorus that is sent to Reverb. This is done with the **Send Chorus to Reverb** parameter (see page 89). When this is set to 0, Reverb and Chorus are in parallel routing. Higher values for each provide varying degrees of serial routing.



Utility Mode

The Utility mode lets you set functions related to the overall operation of the MU50, such as Master Tune, display contrast and playing of the Demo Song. Included also are utility operations, such as various kinds of data transfer with an external data storage device, and initializing of the MU50 settings.

To enter the Utility mode, press the **UTIL** button. The following menu appears:



System Functions

The System functions provide various controls of the overall operation of the MU50, such as Master Tune, Mute, some MIDI receive filters and a display Contrast control.

Master Tune (M.Tune)

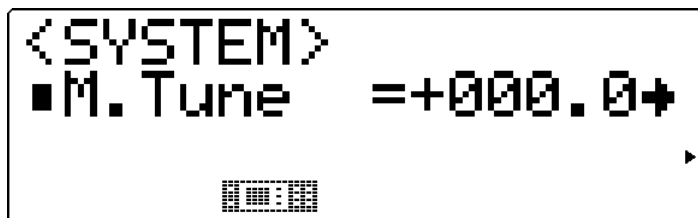

Range: -102.4 — $+102.3$ cents (approx. ± 1 semitone)

Default: 0

This determines the overall fine tuning of the MU50's Voices. It also affects the pitch of the individual drum/percussion sounds of the drum kits. Master Tune is especially useful for adjusting the pitch of the MU50 when playing with other instruments. The actual pitch of each Voice depends also on the other pitch related parameters: Key (in Play mode) and Detune (in Edit mode).

NOTE

At around 440 Hz, 1 Hz is approximately equal to 4 cents.

Mute Lock

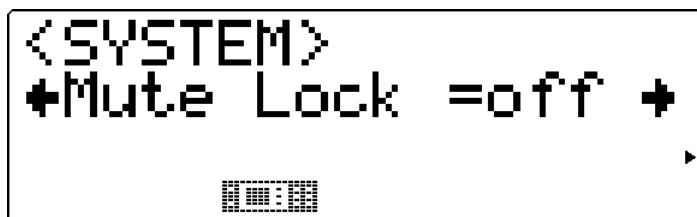

Settings: off, on

Default: off

This determines whether or not the Part Mute status of the MU50 is reset when receiving a **GM System On**, **XG System On** or **Disk Orchestra On** message. Generally, this message is automatically transmitted to the MU50 as part of General MIDI song data. When Mute Lock is set to **off**, this resets the Mute status of the Parts on the MU50. If you want to keep the current Mute settings and disable this reset, set Mute Lock to **on**. (For more information on the Mute function, see page 23.)

Receive General MIDI Exclusive (RcvGMExcl)

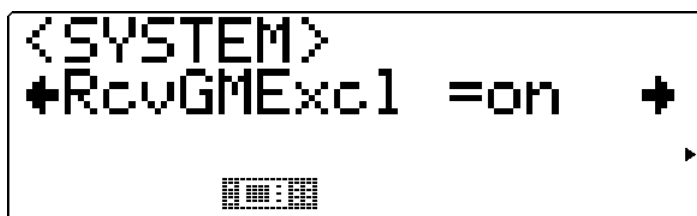

Settings: off, on

Default: on

This determines whether **GM System On**, **XG System On** or **Disk Orchestra On** messages are received or not. The **on** setting allows these messages to be received.

Receive System Exclusive (RcvSysExcl)

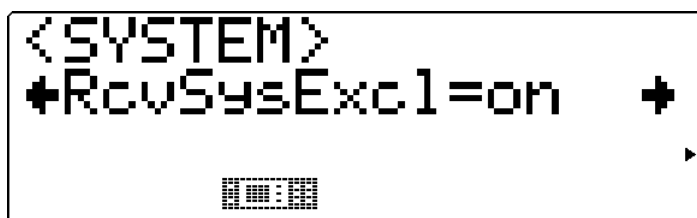

Settings: off, on

Default: on

This determines whether System Exclusive messages are received or not. System Exclusive messages are data specifically (or “exclusively”) related to the MU50. The On setting allows these messages to be re-

ceived. This should be to On when receiving bulk data from a MIDI data storage device. (See page 102.)

Receive Bank Select (RcvBankSel)

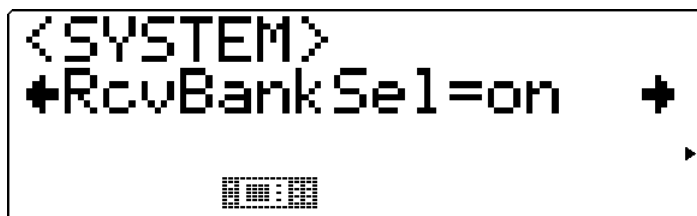

Settings: off, on

Default: on

This determines whether Bank Select messages are received or not. Bank Select messages can be sent from another MIDI device to change the banks of Voices on the MU50. The On setting allows Bank Select messages to be received.

Contrast

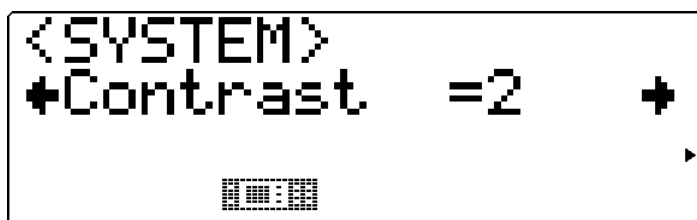

Range: 1 — 8

Default: 2

This determines the contrast of the display. Adjust this as necessary for optimum visibility. (At extreme settings, the display may not be readable.)

Dump Interval (DumpIntrval)



Settings: 50, 100, 150, 200, 300

Default: 150

This determines the length of time the MU50 pauses when sending blocks of data in the Dump Out functions. If the receiving device fails to process the data or displays a “buffer full” type message, try setting this parameter to a higher value and send the data again.

Thru Port



Range: 1 — 8
 Default: 1

Some MIDI devices and sequencers are capable of transmitting data over several MIDI “ports,” effectively breaking the 16-channel barrier. When this data is received via the TO HOST terminal on the MU50, this parameter determines which MIDI port’s data will be routed through the MIDI OUT terminal. This allows you to connect another multi-timbral tone generator to the MU50 and play back data over 32 independent MIDI channels — 16 on the MU50 and another 16 on the connected tone generator. This parameter should be set to a value of 2 — 8 when using another multi-timbral tone generator.

Dump Out Functions

The Dump Out functions allow you to save the various settings of the MU50 (such as settings for Parts, Performances, system, etc.) to a MIDI sequencer, computer or a MIDI data recorder (such as the Yamaha MDF2 MIDI Data Filer).

The following illustrations show example connections for the Dump Out functions.

Saving and Restoring Data via MIDI

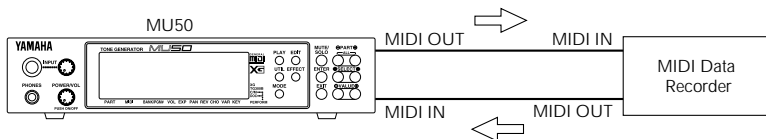

Bulk Dump data can be sent and received using the MIDI IN and MIDI OUT connections.

Saving and Restoring Data via TO HOST

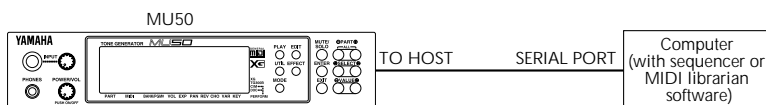

Bulk Dump data can be sent and received using the TO HOST connection.

Operation

- 1 Make sure that the MU50 is properly connected to the device and that the **HOST SELECT** switch is properly set.

When using the MIDI terminals, connect the **MIDI OUT** of the MU50 to the **MIDI IN** of the data recorder. (See the illustrations above.) Also, set the **HOST SELECT** switch to **MIDI**.

When using the TO HOST terminal, make sure that the **HOST SELECT** switch is set corresponding to the device to be used. (Refer to page 25 for more on host computer connections.)

- 2 Press the **UTIL** button and select “DUMPOUT,” then press the **ENTER** button.

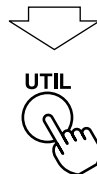
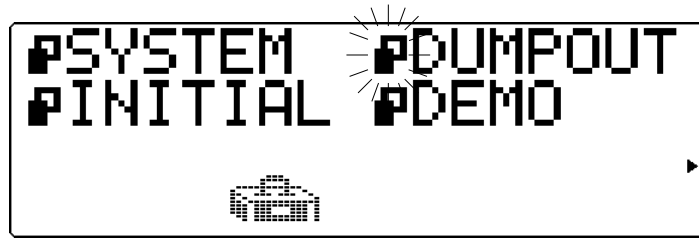

- 3 From the Dump Out menu, select the type of data to be sent: All, Multi or Performance. Then, press the **ENTER** button to call up the selected data dump.

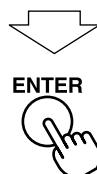

All



Dump All Data
Are you sure ?

This transmits all MU50 data (including Part, Performance, system, and all parameter values) to the connected device.

Multi Part



Dump Multi Part
Are you sure ?

This transmits the MU50 Multi Part data (including System and Effect data) to the connected device. (Use the **VALUE** buttons to select the type/amount of data to be transmitted.)

Performance (PERFORM)



Dump Perform **ALL**
Are you sure ?

Settings: ALL, I 001 — I 128 (Internal Performance numbers)

This transmits the selected MU50 Performance data to the connected device. (Use the **VALUE** buttons to select the type/amount of data to be transmitted.)

- 4 From the “Are you sure?” prompt, press the **ENTER** button to execute the operation, or press the **EXIT** button to cancel it and return to the Dump Out menu.

A “Transmitting...” message appears in the display during the operation. When the transmission is completed, the MU50 returns to the Dump Out menu.

NOTE

If you have more than one MU50 connected in your MIDI system and wish to send different sets of data to each, you can specify a different Device Number for each. (See page 40.) You should set the Device Number on each MU50 you use, **before** dumping the data to a data storage device. Then, when you reload the data to the connected MU50s, each unit will automatically receive only the data that has the corresponding Device Number.

To reload the data from the data recorder back to the MU50:
Make sure that the devices are properly connected (see the **Restoring Data** illustrations above), and execute the appropriate data transfer operation from the data recorder. (Refer to the owner’s manual of that device for instructions.) The MU50 automatically receives incoming bulk data.

Initialize Functions

The Initialize functions allow you to restore the factory settings of the MU50.

NOTE

Since the Initialize functions replace existing data, you should save any and all important settings to a MIDI data storage device before using these functions. (See page 98.)

Operation

- 1 Press the **UTIL** button and select “**INITIAL**,” then press the **ENTER** button.

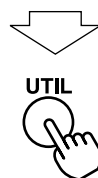
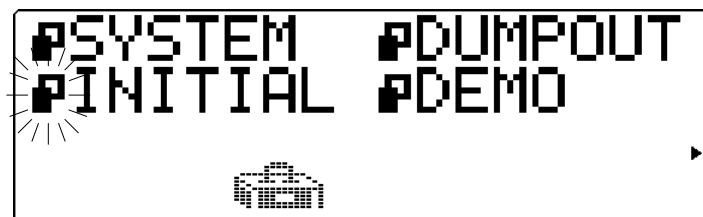

- 2 From the Initialize menu, select the type of data to be initialized: Factory Settings (FactSet), selected Sound Module mode (XG Init, GM Init, C/MInit, DOClnit, PFMIInit) or Drum (DrumInit) Then, press the **ENTER** button to call up the selected data dump.



ENTER



Factory Settings (FactSet)



This restores the original factory settings of the MU50.

Selected Sound Module Mode:

Extended General MIDI (XG Init)



General MIDI (GM Init)

Initialize GM
Are you sure ?



Computer Music (C/MInit)

Initialize C/M
Are you sure ?



Disk Orchestra (DOCIInit)

Initialize DOC
Are you sure ?



Performance (PFMIInit)

Initialize PFM
Are you sure ?



One of the four parameters above will be available, depending on the currently selected Sound Module mode: **XG**, **TG300B**, **C/M**, **DOC** or **PERFORM**. Initializing this parameter restores the original settings for the selected mode.

NOTES

- For the **PFMIInit** setting, only the currently selected Performance will be initialized.
- For **XG Init**, **GM Init** and **DOCIInit**, the initialized settings are the same as when the MU50 is reset upon receiving an **XG System On**, **GM System On** or **Disk Orchestra On** message.

Drum (DrumInit)

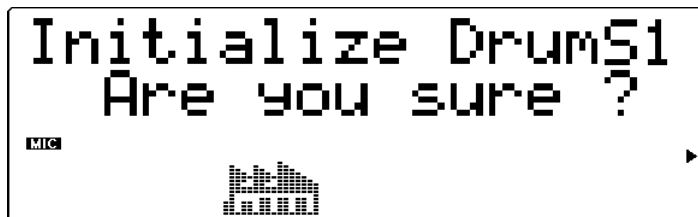

Setting: DrumS1, DrumS2

This restores the original drum settings for the selected Drum SetupS1, SetupS2. (Use the **VALUE** buttons to select the desired Drum Setup.)

When **C/M** or **DOC** is selected, only DrumS1 can be selected.

NOTE

This parameter is not available when the MU50 is set to Performance mode.

- 3 From the “Are you sure?” prompt, press the **ENTER** button to execute the operation, or press the **EXIT** button to cancel it and return to the previous display.

An “Executing...” message appears in the display during the operation. When the operation is completed, the MU50 returns to the Initialize menu.

Demo Song Play (DEMO)

The Demo Song function in the Utility menu allows you to play the built-in Demo Song.

Operation

- 1 Press the **UTIL** button and select “DEMO” using the **SELECT** buttons, then press the **ENTER** button.



- 2 Press the **ENTER** button to start the Demo Song.

The Demo Song starts playing immediately and repeats indefinitely until stopped (in step 4 below). Playback of the individual Parts of the song is shown graphically by the “level meter” bars in the display.

NOTE

During Demo Song playback, no panel controls (with the exception of the **EXIT** button and the **VOLUME** control) can be used.

- 3 To stop playback of the song, press the **EXIT** button.



- 4 To exit from the Demo Song function, press the **EXIT** button again.

Sound Module Mode (MODE)

This lets you select the operating mode of the MU50. Press the **MODE** button, then use the **VALUE** buttons to select the desired Sound Module mode: **XG** (XG MIDI), **TG300B** (General MIDI), **C/M** (Computer Music), **DOC** (Disk Orchestra) or **PERFORM** (Performance). If **XG**, **TG300B**, **C/M** or **DOC** are selected, the MU50 automatically sets itself to the Multi mode. When **PERFORM** is selected, the MU50 is in the Performance mode. (See page 66.)

The bottom right of the display indicates the currently selected Sound Module mode.

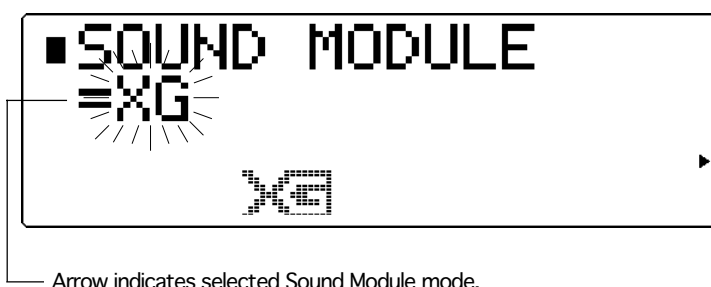

Arrow indicates selected Sound Module mode.

Press the **EXIT** button (or any one of the other mode select buttons: **PLAY**, **EDIT**, **UTIL** or **EFFECT**) to use the MU50 in the current mode.

NOTE

When the MU50 is **not** set to the XG mode and an **XG System On** message is received, the MU50 changes to the XG mode after a slight pause of 0.5 seconds.

About Cable Messages

The MU50 can receive Cable messages (F5) when the TO HOST terminal is connected to the serial terminal of a computer. On the MU50, MIDI receive channels 1 — 16 are controlled from Port 1. By connecting another multi-timbral tone generator to the MIDI OUT terminal of the MU50 and setting the Thru Port function (page 98) to a value other than 1, you can play back data over a total of 32 MIDI channels — 16 on the MU50 and another 16 on the connected tone generator.

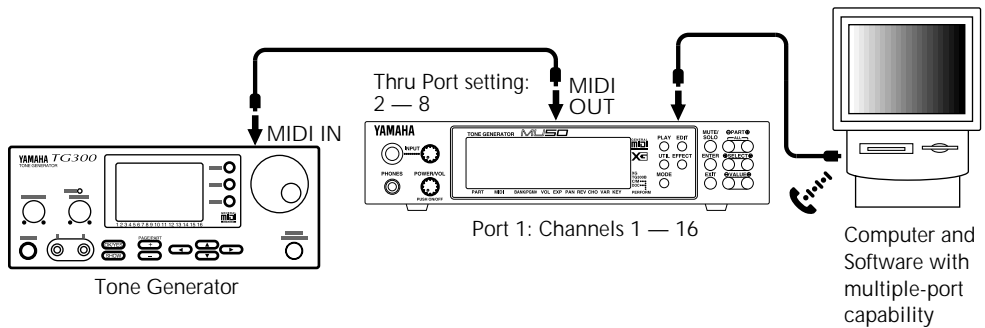

APPENDIX

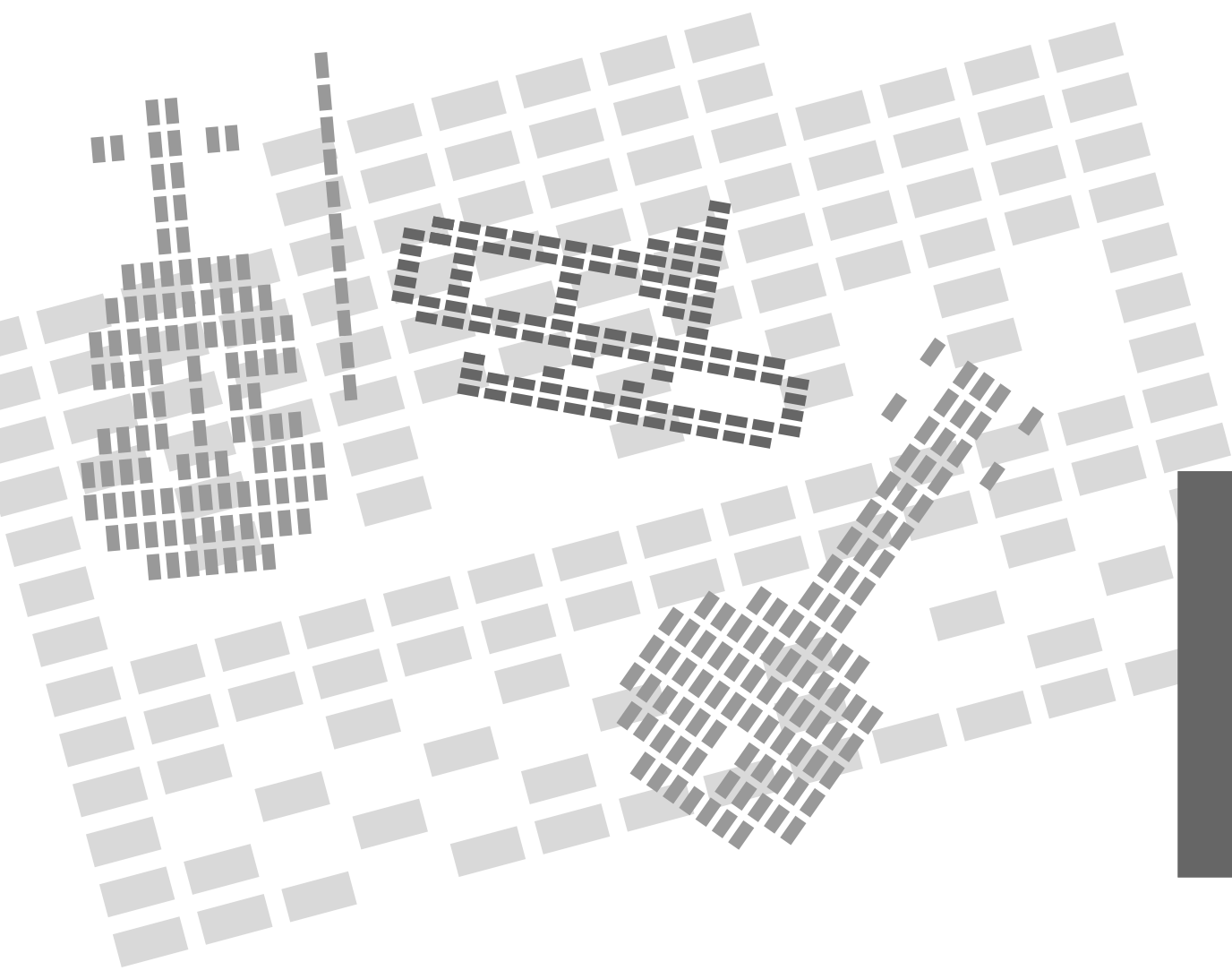

XG

Chapter 0: Format Overview

Yamaha introduces a new tone-generator control format designed to meet the requirements of the coming multimedia environment. The new XG format — an extension of the existing GM format — provides broader capabilities suited to the demands of an increasingly sophisticated and diversified computerized environment. The new format enables a significantly higher level of musical expressiveness while at the same time ensuring the continued compatibility of existing sound data.

Yamaha shall use the XG format as the basis for forthcoming electronic instruments, acoustic software, and tone-generating LSI circuitry, while working to maintain compatibility and scalability among Yamaha models.

Development Background

Tone generators are utilized in a wide range of devices, from musical instruments to communications devices and computer games.

The first international MIDI standard arose from the need to enable consistent external control of tone generators on all device types, regardless of manufacturer or model. Because tone generator voice arrangements tended to vary considerably among manufacturers and models, however, different MIDI devices often produced different types of sound in response to identical MIDI instructions.

In 1991 the MIDI standard committee enacted additional specifications, referred to as the GM (General MIDI) standard, for the purpose of standardizing voice arrangements and improving MIDI uniformity. The GM standard significantly enhanced acoustics compatibility among complying devices, leading in turn to an expanding base of GM software applications. But the GM standard also has its limitations. It provides support for only 128 voices, whereas many users now perceive the need for a greater number of voices suited to a wider range of musical genres. Users have also indicated a desire for greater control over voice modifications and effects so as to enable a higher level of expressiveness.

The advent of the computer-based multimedia age has added yet a different perspective, bringing increased attention to both image and sound technologies. Developments in multimedia-related sound and music processing parallel recent advances in the area of image compression, and are pointing the way to the future of multimedia.

At present there are two fundamentally different approaches to the handling of sound and control data. One method is to digitally store sound data at the software side together with the control data, then send all of the data together to generate the playback. The second method is to have the software supply just control data to a tone generator on a computer or other such device. The tone generator processes the incoming data and generates the sound locally.

The first method offers highly realistic sound, but requires immense quantities of data and locks in a specific set of performance characteristics and voices. The second method requires far less data while allowing for entirely free variations in voices, tempos, and virtually all other performance characteristics. The second method is therefore ideal for interactive multimedia applications such as karaoke and repetitive computer-game sounds.

MIDI-based applications are typical of this second type of approach. As multimedia technology advances, we face a pressing need to expand this approach to accommodate a larger number of voices and greater degree of expressive control. This is why Yamaha is pleased to propose the new XG format — the tone generator format for the 21st century.

Basic Concepts

The XG format maintains the universality and compatibility of the MIDI and GM standards while significantly increasing the range of expressiveness. It is designed to ensure data continuity, and to provide equipment manufacturers with considerable flexibility in designing machines that satisfy its requirements.

Specifically, the XG format does the following.

- Enables production of extremely expressive sound data
- Significantly expands available voice types and variations
- Supports future compatibility of sound data among musical instruments, computers, and other devices
- Ensures that data will remain fully usable well into the future
- Supports standardized handling of new types of effects-inclusive data (such as karaoke data)

The XG format is founded on the following three principles:

- Compatibility
- Scalability
- Expandability

1 Compatibility

Any XG machine, regardless of model or manufacturer, will provide faithful reproduction of any XG sound data. Because the XG format maintains downward compatibility with the GM format, XG machines will also provide correct reproduction of GM sound data.

2 Scalability

Although the XG format provides detailed and extensive specification of voice sets and voice changes, it does not require XG machines to support the full range of functions. Designers are free to develop a wide range of products to meet various cost and performance objectives. Each XG machine will replay XG data in accordance with the machine's level of sophistication. If a model does not support a variation voice, it will automatically play the corresponding basic voice instead. If a model includes a graphic equalizer, it can take full advantage of graphic equalizer functions so as to control frequency characteristics to best suit the musical genre being played — from lively rock to soothing classical.

3 Expandability

The XG format remains open to enhancements and extensions that will allow it to remain in step with future product developments.

Additions to the GM format

The XG offers the following extensions to the GM format.

- **Voices:** The GM format supports 128 voices. The XG format provides for Bank Select messages that significantly expand the number of voices supported.

1) Voice Extension by Bank-Select LSB

Variations of basic GM voices are stored in banks. To select a variation, specify the desired bank by sending the appropriate Bank-Select LSB value. Each bank is associated with a specific type of variation, so that voices are easy to locate.

- 2) **Bank-Select MSB** adds an SFX bank
 The Bank-Select LSB method is not useful for extension of distinctive SFX voices that have no meaningful variation. For this reason the XG format supports a full SFX bank of extension effects, which you can select by sending a Bank-Select MSB value of 40H. Bank-Select MSB 7EH or 7FH, in contrast, can be used to set any channel to rhythm-part play.
- **Voice Modification:** The XG format allows creation of extremely expressive control data that can darken or lighten voices, delay or accelerate sound start-up, or implement many other types of control. Most controls are issued by Control Change commands, although System Exclusive messages are also used.
 - **Effects:** The XG format offers high-level effects support, enabling control of effects types, circuit operation, and internal parameter settings for both basic and elaborate effects. Devices equipped with graphic equalizers will be able to modify ambience and sound to suit the specific type of music being played.
 - **External Input:** Whereas existing tone generators create sound in response to internal data only, the XG format provides for real-time participation by adding support for input of external audio signals. External signals can be processed by the mixer in the same way as internal tone-generator data. A model that supports this function would allow you, for example, to create karaoke data that can automatically set the microphone echo used for playback.

New MIDI messages not available under GM format

1. Control Change
 - Bank Select
 - Portamento Time
 - Portamento
 - Sostenuto
 - Soft Pedal
 - Harmonic Content
 - Release Time
 - Attack Time
 - Brightness
 - Portamento Control
 - Effects Send Level 1 (Reverb)
 - Effects Send Level 2 (Chorus)
 - Effects Send Level 3 (Variation)
 - NRPN Part Parameter Control
 - All Sound Off
2. Channel Mode Messages
3. Polyphonic Aftertouch

4. System Exclusive Messages

Parameter Change

System Parameters

Effects Parameters

Three categories of system effects are supported. One of these categories can be switched with insertion effects.

Graphic EQ and multiple insertion effects are supported as options.

Part Parameters

Filter cutoff and AEG value can be controlled by offset.

Display Parameters

External-Input Control Parameters

Enable control of external signals input into internal mixer.

Drum Setup Parameters

Bulk Dump

Parameter Request

Dump Request

Chapter 1: MIDI Specifications

1. Key On/Key Off

Status: 9nH/8nH

If multipart parameter “Rcv NOTE MESSAGE” is OFF, the part ignores these messages.

2. Program Change

Status: CnH

Default: 00H

If multipart parameter “Rcv PROGRAM CHANGE” is OFF, the part ignores this message.

Melody Voice

As indicated in MU50 Sound List & MIDI Data booklet. Voices can be added through use of Bank Select LSB. (Refer to description of Bank Select, below.)

Rhythm Voices

As indicated in MU50 Sound List & MIDI Data booklet. Program Change message can be used to change the voice (drum kit). If the tone generator does not have a drum kit corresponding to the specified program number, it will ignore the message and continue to use the current drum kit.

3. Pitchbend

Status: EnH

Default: 40H 00H

If multipart parameter “Rcv PITCH BEND” is OFF, the part ignores this message.

4. Control Change

Status: BnH

If multipart parameter “Rcv CONTROL CHANGE” is OFF, the part will continue to accept Channel Mode messages but will ignore all other Control Change messages.

Bank Select MSB/LSB: 00H/20H

Cntrl#	Parameter	Data Range
0 32	Bank Select MSB Bank Select LSB	0:Normal 64:SFX voice 126:SFX kit 127:Drum 0 to 127 Default: 00 00H

If multipart parameter “Rcv BANK SELECT” is OFF, the part ignores this message.

The new bank selection does not become effective until receipt of the next Program Change message.

The Bank-Select MSB selects melody voice, SFX voice, or rhythm kit. It allows any channel as opposed to just channel 10 to be designated for rhythm play.

Bank-Select MSB values are as follows.

00H:	Melody voice
01H to 3FH:	not used
40H:	SFX voice
41H to 7DH:	not used
7EH:	SFX kit (SFX voices arranged over keyboard)
7FH:	Rhythm kit (Rhythm voices arranged over keyboard)

The Bank-Select LSB selects from the extended melody-voice set. (SFX-kit and rhythm-kit voices do not currently support Bank-Select LSB extension sets.) Each bank is set for a specific type of variation, simplifying retrieval of the desired voice. Extension voices, like basic voices, are associated with voice names (see MU50 Sound List & MIDI Data booklet). Other banks and voices may be added in the future.

An XG machine need not support all LSB-selectable extension voices listed in the MU50 Sound List & MIDI Data booklet. If support is included for one or more voices in an extension bank, however, all the other Program Change Numbers in that bank are filled with the corresponding Bank #0 voice (basic voice).

Note 1: Under default selection, Channel 10 plays rhythm voices, while other channels take Bank 1 melody voices. (Same as GM-system Level 1)

Note 2: Receipt of Bank-Select LSB/MSB does not immediately change the voice. The channel stores the received Bank-Select LSB/MSB setting, but does not apply it until receipt of the next Program Change message.

Note 3: If the new Bank-Select MSB is 00H (melody voice) but the tone generator does not support the melody voice corresponding to the last received Bank-Select LSB, the channel reverts to the Bank-Select LSB corresponding to its most recently played melody voice.

Note 4: If the new Bank Select MSB is 7FH (GM rhythm voice), the tone generator unconditionally uses LSB 00H. If the tone generator does not support a drum kit corresponding to the channel's most recently received Program Change, the channel will revert to the Program Change corresponding to its most recently played rhythm kit.

Note 5: If a Bank Select MSB value of 01H~7EH (SFX voice, or unused MSB) is received and the tone generator does not have a voice corresponding to the last received LSB and Program Change, the tone generator will produce no sound for that channel regardless of subsequent Key On messages.

(Commentary) Users employing the XG format to generate music data should note the following general points.

- The discussion and examples provided above are intended to clarify operating specifications relevant to tone-generator manufacture. During general operation the MSB, LSB, and Program Change information should always be sent together (as under the MIDI standard).
- For melody-voice play: If the channel cannot play from the bank selected by the last LSB specification, it will revert to the most recent playable LSB specifications.
- For rhythm-voice play: If the channel cannot play the kit selected by the last received Program Number, it will revert to the most recent playable Program Number.

Modulation: 01H

Cntrl#	Parameter	Data Range
1	Modulation	0 to 127 Default: 00H

If multipart parameter “Rcv MODULATION” is OFF, the part ignores this message.

Upon initialization this message applies to vibrato depth, but content can be changed by use of System Exclusive message.

Portamento Time: 05H

Cntrl#	Parameter	Data Range
5	Portamento Time	0 to 127 Default: 00H

Sets the pitch-change speed used when Portamento is ON. Has no affect on portamento control. A value of 0 produces the shortest portamento time; value 127 selects the longest time.

Data Entry MSB/LSB: 06H/26H

Cntrl#	Parameter	Data Range
6	Data Entry MSB	0 to 127
38	Data Entry LSB	0 to 127

Sets the value for the parameter specified by RPN/NRPN.

Master Volume: 07H

Cntrl#	Parameter	Data Range
7	Volume	0 to 127 Default: 64H

If multipart parameter “Rcv VOLUME” is OFF, the part ignores this message.

Use this message to balance the volume among the different parts.

Panpot: 0AH

Cntrl#	Parameter	Data Range
10	Panpot	0 to 127 Default: 40H

If multipart parameter “Rcv PAN” is OFF, the part ignores this message.

Produces relative variations in pan among different installments of the rhythm part.

Expression: 0BH

Cntrl#	Parameter	Data Range
11	Expression	0 to 127 Default: 7FH

If multipart parameter “Rcv EXPRESSION” is OFF, the part ignores this message.

This message is used to control intonation expression (diminuendo and crescendo) during play.

Sustain: 40H

Cntrl#	Parameter	Data Range
64	Sustain	0 to 127 (0-63:Off 64-127:On) Default: 00H

If multipart parameter “Rcv SUSTAIN” is OFF, the part ignores this message.

Portamento: 41H

Cntrl#	Parameter	Data Range
65	Portamento Default: 00H	0 to 127 (0-63:Off 64-127:On)

If multipart parameter “Rcv PORTAMENTO” is OFF, the part ignores this message.

Sostenuto: 42H

Cntrl#	Parameter	Data Range
66	Sostenuto Default: 00H	0 to 127 (0-63:Off 64-127:On)

If multipart parameter “Rcv SOSTENUTO” is OFF, the part ignores this message.

Soft Pedal: 43H

Cntrl#	Parameter	Data Range
67	Soft Pedal	0 to 127 (0-63:Off 64-127:On) Default: 00H

If multipart parameter “Rcv SOFT PEDAL” is OFF, the part ignores this message.

Harmonic Content: 47H

Cntrl#	Parameter	Data Range
71	Harmonic Content	0 to 127 (0:-64 64:+0 127:+63) Default: 40H

Applies adjustment to the resonance value set by the voice. This parameter specifies relative change, with value 64 producing zero adjustment. As values get higher the sound becomes increasingly eccentric. Note that for some voices the effective parameter range is narrower than the legal parameter range.

Release Time: 48H

Cntrl#	Parameter	Data Range
72	Release Time	0 to 127 (0:-64 64:+0 127:+63) Default: 40H

Applies adjustment to the envelope release time set by the voice. This parameter specifies relative change, with value 64 producing zero adjustment. For some voices the effective parameter range is narrower than the legal parameter range.

Attack Time: 49H

Cntrl#	Parameter	Data Range
73	Attack Time	0 to 127 (0:-64 64:+0 127:+63) Default: 40H

Applies adjustment to the envelope attack time set by the voice. This parameter specifies relative change, with value 64 producing zero adjustment. For some voices the effective parameter range is narrower than the legal parameter range.

Brightness: 4AH

Cntrl#	Parameter	Data Range
74	Brightness	0 to 127 (0:-64 64:+0 127:+63) Default: 40H

Applies adjustment to the filter cutoff frequency set by the voice. This parameter specifies relative change, with value 64 producing zero adjustment. For some voices the effective parameter range is narrower than the legal parameter range.

Portamento Control: 54H

Cntrl#	Parameter	Data Range
84	Portamento Control	0 to 127

Portamento time is always 0.

Effects Send Level 1 (reverb): 5BH

Cntrl#	Parameter	Data Range
91	Effect-1 Depth	0 to 127 Default: 28H

Adjusts the reverb send level.

Effects Send Level 3 (chorus): 5DH

Cntrl#	Parameter	Data Range
93	Effect-3 Depth	0 to 127 Default: 00H

Adjusts the chorus send level.

Effects Send Level 4 (variation): 5EH

Cntrl#	Parameter	Data Range
94	Effect-4 Depth	0 to 127 Default: 00H

Adjusts the variation effect send level. Effective only if “Variation Connection = System”.

Data Increment/Decrement (RPN): 60H/61H

Cntrl#	Parameter	Data Range
96	RPN Increment	0 to 127
97	RPN Decrement	0 to 127

The data byte has no meaning.

This message adds or subtracts 1 to/from the Pitchbend Sensitivity, Fine Tune, and Coarse Tune MSBs. Note that the Increment (Decrement) message will not change a setting that has already reached its maximum (minimum) value. (Incrementation or decrementation of the Fine Tune value never carries over to the Coarse Tune value.)

NRPN (Non-registered parameter number) LSB/MSB: 62H/63H

Cntrl#	Parameter	Data Range
98	NRPN LSB	0 to 127
99	NRPN MSB	0 to 127

If multipart parameter “Rcv NRPN” is OFF, the part ignores this message.

First send the NRPN MSB and LSB to select the control parameter, then set the value by Data Entry.

Once you have selected an NRPN on a given channel, the channel will apply subsequent Data Entry to the selected parameter. After making the necessary settings you should set RPN to Null to reduce the risk of operational errors.

The following NRPN values are supported.

NRPN		Data-entry			Data Range
MSB	LSB	MSB	Parameter		
01H	08H	mmH	Vibrato Rate		mm:00H-40H-7FH(-64-0+63)
01H	09H	mmH	Vibrato Depth		mm:00H-40H-7FH(-64-0+63)
01H	0AH	mmH	Vibrato Delay		mm:00H-40H-7FH(-64-0+63)
01H	20H	mmH	Filter Cutoff Frequency		mm:00H-40H-7FH(-64-0+63)
01H	21H	mmH	Filter Resonance		mm:00H-40H-7FH(-64-0+63)
01H	63H	mmH	EG Attack Time		mm:00H-40H-7FH(-64-0+63)
01H	64H	mmH	EG Decay Time		mm:00H-40H-7FH(-64-0+63)
01H	66H	mmH	EG Release		mm:00H-40H-7FH(-64-0+63)
14H	rrH	mmH	Drum Filter Cutoff Frequency		mm:00H-40H-7FH(-64-0+63) rr:drum instrument note number
15H	rrH	mmH	Drum Filter Resonance		mm:00H-40H-7FH(-64-0+63) rr:drum instrument note number
16H	rrH	mmH	Drum EG Attack Rate		mm:00H-40H-7FH(-64-0+63) rr:drum instrument note number
17H	rrH	mmH	Drum EG Decay Rate		mm:00H-40H-7FH(-64-0+63) rr:drum instrument note number
18H	rrH	mmH	Drum Pitch Coarse		mm:00H-40H-7FH(-64-0+63) rr:drum instrument note number
19H	rrH	mmH	Drum Pitch Fine		mm:00H-40H-7FH(-64-0+63) rr:drum instrument note number
1AH	rrH	mmH	Drum Level		mm:00H-7FH(0-Max) rr:drum instrument note number
1CH	rrH	mmH	Drum Pan		mm:00H-40H-7FH(Random,L-Center-R) rr:drum instrument note number
1DH	rrH	mmH	Drum Reverb Send Level		mm:00H-7FH(0-Max) rr:drum instrument note number
1EH	rrH	mmH	Drum Chorus Send Level		mm:00H-7FH(0-Max) rr:drum instrument note number
1FH	rrH	mmH	Drum Variation Send Level		mm:00H-7FH(0-Max) rr:drum instrument note number

If multipart parameter “Rcv NRPN” is OFF, the part ignores these messages.

Note that LSB values 14H through 1FH (drum parameters) are effective only for rhythm parts.

RPN (Registered parameter number) LSB/MSB: 64H/65H

Cntrl#	Parameter	Data Range
100	RPN LSB	0 to 127
101	RPN MSB	0 to 127 Default: 7F 7FH

If multipart parameter “Rcv RPN” is OFF, the part ignores this message.

The following parameters are supported.

NRPN		Data-entry			Data Range
LSB	MSB	MSB	Parameter		
00H	00H	mmH	Pitchbend Sensitivity		mm: 00H-40H-7FH (-64-0+63) Default: 02H

LSB value is ignored.

Minimum operational range is 00H00H-0CH00H (\pm octave).

01H	00H	mmH	Fine Tune	mm: 00H-40H-7FH (-64-0+63) Default: 40 00H
02H	00H	mmH	Coarse Tune	mm: 00H-40H-7FH (-64-0+63) Default: 40 00H
7FH	7FH		Null	—

5. Channel Mode Messages

All Sound Off: 78H

Cntrl#	Parameter	Data Range
120	—	0

Switches off sound from all parts.

Does not reset the settings established by Channel Messages.

Reset All Controllers: 79H

Cntrl#	Parameter	Data Range
121	—	0

Resets the following values: Pitchbend, Modulation, Expression, Sustain, Registered Parameter Number, parameter settings.

Resets portamento control. Specifically, clears condition in which source (Portamento Control Message) has been received but target (new Key On) has not.

Leaves the following values unchanged: Program Change, Bank Select MSB/LSB, Volume, Pan, Dry Send Level, Effects Send Levels 1 ~ 5, Pitchbend Sensitivity, Fine Tuning, Coarse Tuning.

All Notes Off: 7BH

Cntrl#	Parameter	Data Range
123	—	0

Switches off all currently “on” notes in all parts. Any notes being held by sustain or sostenuto continue to sound until sustain/sostenuto goes off.

OMNI Off: 7CH

Cntrl#	Parameter	Data Range
124	—	0

Same processing as for All Notes Off.

OMNI On: 7DH

Cntrl#	Parameter	Data Range
125	—	0

Same processing as for All Notes Off. (“OMNI ON” operation not supported.)

MONO: 7EH

Cntrl#	Parameter	Data Range
126	Mono	0 to 16

Generates “All Sound Off” operation. If the value of the third byte (mono number) is 0~16, the channel changes to Mode 4 (m=1).

POLY: 7FH

Cntrl#	Parameter	Data Range
127	—	0

Generates “All Sound Off” operation, and sets the channel to Mode 3.

6. Channel Aftertouch

Status: DnH

The message is not effective under initial settings.

If multi part parameter “Rcv CHANNEL AFTERTOUC” is Off, the part ignores this message.

7. Polyphonic Aftertouch

Status: AnH

The message is not effective under initial settings.

If multi part parameter “Rcv POLYPHONIC AFTERTOUC” is Off, the part ignores this message. It is not necessary for the effect to apply to all note numbers (0~127).

8. Exclusive Messages

XG System On

F0H,43H,1nH,4CH,00H,00H,7EH,00H,F7H

11110000	F0	Exclusive status
01000011	43	YAMAHA ID
0001nnnn	1n	Device Number
01001100	4C	Model ID
00000000	00	Address High
00000000	00	Address Mid
01111110	7E	Address Low
00000000	00	Data
11110111	F7	End of Exclusive

The message switches SOUND MODULE MODE to XG and initializes the XG settings.

The message requires approximately 50ms to execute, so sufficient time should be allowed before the next message is sent.

GM System On

F0H,7EH,7FH,09H,01H,F7H

11110000	F0	Exclusive status
01111110	7E	Universal Non-realtime ID
01111111	7F	Device ID
00001001	09	Sub ID1
00000001	01	Sub ID2
11110111	F7	End of Exclusive

Resets all data values to their defaults, with the exception of the MIDI Master Tuning value.

MIDI Master Volume

F0H,7FH,7FH,04H,01H,11H,mmH,F7H

11110000	F0	Exclusive status
01111111	7F	Universal Realtime ID
01111111	7F	Device ID
00000100	04	Sub ID1
00000001	01	Sub ID2
01111111	11	Master Volume LSB
0mmmmmm	mm	Master Volume MSB
11110111	F7	End of Exclusive

Changes volume of all channels. (“Universal System Exclusive”)

MIDI Master Tuning

F0H,43H,1nH,27H,30H,00H,00H,mmH,11H,ccH,F7H

11110000	F0	Exclusive status
01000011	43	YAMAHA ID
0001nnnn	1n	Device Number
00100111	27	Model ID
00110000	30	Sub ID2
00000000	00	
00000000	00	
0mmmmmm	mm	Master Tune MSB
01111111	11	Master Tune LSB
0ccccccc	cc	Don't Care
11110111	F7	End of Exclusive

Changes tuning of all channels.

Parameter Change

11110000	F0	Exclusive status
01000011	43	YAMAHA ID
0001nnnn	1n	Device Number
01001100	4C	Model ID
0aaaaaaa	aa	Address High
0aaaaaaa	aa	Address Mid
0aaaaaaa	aa	Address Low
0ddddddd	dd	Data
0ddddddd	dd	Data
11110111	F7	End of Exclusive

Includes 2 or 4 bytes of data, depending on parameter size.

The following eight types of parameter change are provided.

- 1) System Data parameter change
- 2) Multi Effect Data parameter change
- 3) Multi EQ Data parameter change
- 4) Multi Part Data parameter change
- 5) Drums Setup Data parameter change
- 6) System Information
- 7) Display Data parameter change
- 8) AD Part Data parameter change

*6) System Information is sent in response to dump requests. Received parameter changes are ignored.

System Exclusive messages are not accepted if “Rcv System Exclusive” is OFF.

Bulk Dump

11110000	F0	Exclusive status
01000011	43	YAMAHA ID
0000nnnn	0n	Device Number
01001100	4C	Model ID
0bbbbbbb	bb	Byte Count MSB
0bbbbbbb	bb	Byte Count LSB
0aaaaaaa	aa	Address High
0aaaaaaa	aa	Address Mid
0aaaaaaa	aa	Address Low
0ddddddd	dd	Data
0ddddddd	dd	Data
0ccccccc	cc	Checksum
11110111	F7	End of Exclusive

For information about “Address” and “Byte Count” fields, refer to Table 2 on the SOUND LIST & MIDI DATA booklet.

Checksum value is set such that the sum of Address, Byte Count, and Checksum has value zero in its seven least significant bits.

No more than 512 bytes should be sent in a single transmission. If the Dump Request asks for more than 512 bytes, data should be sent in packets of 512 bytes or less, with at least 120msec between transmission of consecutive packets.

Parameter Request

11110000	F0	Exclusive status
01000011	43	YAMAHA ID
0011nnnn	3n	Device Number
01001100	4C	Model ID
0aaaaaaa	aa	Address High
0aaaaaaa	aa	Address Mid
0aaaaaaa	aa	Address Low
11110111	F7	End of Exclusive

Dump Request

11110000	F0	Exclusive status
01000011	43	YAMAHA ID
0010nnnn	2n	Device Number
01001100	4C	Model ID
0aaaaaaa	aa	Address High
0aaaaaaa	aa	Address Mid
0aaaaaaa	aa	Address Low
11110111	F7	End of Exclusive

Sending or receiving of dump request cannot be switched off except by setting “Exclusive” to OFF.

Troubleshooting

Even though the MU50 is exceptionally easy to use, it may occasionally not function as you expect it to. If that happens, check the possible problems and solutions below before assuming that the instrument is faulty.

Problem	Possible Cause and Solution
No power.	If you are using an AC adaptor, check that the adaptor is properly plugged into both the AC outlet and the MU50 (See page 12.)
No sound.	<p>Check that:</p> <ul style="list-style-type: none"> ● The panel volume control is set to an appropriate level. ● Other volume-related parameters are set to appropriate levels. (See Volume and Expression in the Single Part controls, pages 37—38, and Master Volume and Master Attenuator in the All Part controls, page 41.) ● Mute or Solo are not active. (See page 23.) If a Part is being muted, or an empty Part is being soloed, you may not get any sound. ● The Variation effect settings are appropriate. No sound will be output at all if Variation Connection is set to INS (page 92), Variation Send is turned on for the Part (page 39), and NO EFFECT is selected for the Variation Type (page 90). The easiest solution in such a case is to turn off Variation Send for the Part. ● The EG Attack Time (page 46) is appropriately short, for short percussive sounds. ● The Velocity Sensitivity Offset (page 56) is appropriate. ● The Note Limit Low and Note Limit High (page 57) settings are appropriate. If the former is set higher than the latter, no sound will be output. ● The Velocity Limit Low and Velocity Limit High (page 59) settings are appropriate. If the former is set too high and the latter too low, no sound may be output.
No sound when playing the MU50 from a computer, sequencer or external keyboard.	Check all MIDI connections, making sure that the MIDI OUT of the external device is connected to the MIDI IN of the MU50, and that the MIDI IN of the external device is connected to the MIDI OUT of the MU50. (See pages 28—29.) Or, if you are using the TO HOST terminal with a computer, make sure that the terminal is properly connected to the computer and that the HOST SELECT switch is properly set for your particular computer. (See pages 25—28.) Also, make sure that you have turned on the connected MIDI instrument or computer <i>before</i> turning on the MU50. If you haven't, simply turning the MU50 off and back on again may solve the problem.
Notes are cut off or omitted.	The maximum polyphony of the MU50 may be exceeded. The MU50 can play no more than 32 notes at once. (Though 32 notes may seem to be more than enough, you may run short when playing a connected keyboard along with some densely arranged song data.)
Reverb, Chorus and/or Variation effects cannot be heard.	Check all Reverb-, Chorus- and Variation-related controls: Reverb Send, Chorus Send and Variation Send in Single Part controls (pages 39); Reverb Return, Chorus Return and Variation Return (when Variation Connection is set to SYS) in All Part controls (pages 41—42). Also check the individual effect settings; if no Type has been selected, or if the parameter settings are too low, there may be no effect sound.
The input sound (keyboard, guitar, etc.) cannot be heard.	Make sure that the INPUT control is set to an appropriate level. Also for best results, make sure that the input type (guitar, keyboard, audio) is set to match the input you are using.

Error Messages

Battery Low!

The battery voltage (for internal memory backup) may be too low. Bring the unit to your local Yamaha dealer or any other authorized Yamaha service personnel.

Illegal Data!

A data error resulted during reception of MIDI messages. Try transmitting the data again, or turn the MU50 off and back on again.

MIDI Buffer Full!

Too much MIDI data is being received by the MU50 at one time. Reduce the amount of data being sent to the MU50.

HOST is OffLine!

This message appears when the host computer is not turned on, the connecting cable is not properly connected, or the sequencing software is not active.

SysEx Adrs ERROR!

The data of the received System Exclusive message is incorrect. Check the address of the message and try transmitting again.

SysEx Data ERROR!

The data of the received System Exclusive message is incorrect. Check the data of the message (as to whether it requires an MSB or LSB header) and try transmitting again.

SysEx Size ERROR!

The data of the received System Exclusive message is incorrect. Check the size of the message and try transmitting again.

Check Sum ERROR!

The checksum of the received System Exclusive message is incorrect. Check the checksum of the message and try transmitting again.

This Parameter isn't Excl Data

The selected parameter has no System Exclusive value and cannot be displayed with the Show Exclusive function.

No Parameter

The selected parameter for use with the Show Exclusive function does not exist as a valid parameter.

Rcv CH is OFF!

The selected parameter for use with the Show Exclusive function cannot be converted to a MIDI message value since the Receive Channel for the Part is off. Set the Receive Channel to an appropriate value.

Specifications

Tone Generation Method

AWM2 (Advanced Wave Memory 2)

Maximum Simultaneous Polyphony

32-note

Sound Module Modes

XG (Extended General MIDI), TG300B, C/M, DOC, and Performance

Multi-timbral Capacity

16-Part (on 16 MIDI channels; with element reserve priority for later notes and dynamic Voice allocation)

Internal Voice/Program Structure

Normal Programs

Total Voices	737
XG mode	480
TG300B mode	579
C/M mode	128 (Parts 1 — 9), 64 (Parts 11 — 16)
DOC mode	61

Drum Programs

Total Programs	22
XG mode	11
TG300B mode	10
C/M mode	1
DOC mode	1

Performance Programs

Up to four Voices plus all effect settings can be memorized to a Performance.	
Preset Programs	32 × 4
User Programs	128

Effects

Five sections of multi-effects: Reverb (12 Types), Chorus (11 Types), Variation (42 Types)

Demo Song

1 (not editable, stored in ROM)

Display

Custom back-lit LCD

Controls

INPUT level control; POWER/VOL control; Mode select buttons: PLAY, UTIL (UTILITY), MODE, EDIT, EFFECT; other buttons: MUTE/SOLO, ENTER, EXIT, PART , SELECT , VALUE

Jacks and Terminals

Front panel: INPUT jack (stereo 1/4"), PHONES jack (stereo mini-pin)
Rear panel: OUTPUT R, L/MONO jacks (Right, Left/Mono); DC IN jack; TO HOST terminal; HOST SELECT switch; MIDI IN, MIDI OUT, and MIDI THRU terminals

Computer/MIDI Interface

Direct connection to host computer port (RS-232C, RS-422) with optional cables; MIDI terminals allow connection to MIDI sequencer or MIDI controller

Data Transfer (Baud) Rate

MIDI — 31,250 bps (bits per second)
Mac — 31,250 bps
PC-1 — 31,250 bps
PC-2 — 38,400 bps

Power Supply

Yamaha PA-1207 AC Adaptor (included)

Dimensions (W × D × H)

220 × 210 × 44 mm (8-5/8" × 8-1/4" × 1-3/4")

Weight

1.3 kg (2 lbs., 14 oz.)

Included Accessories

Owner's Manual, Yamaha PA-1207 AC Adaptor

** Specifications subject to change without notice.*

Glossary

- Assignable Controller 1** Certain functions on the MU50 (such as the Filter, Volume or Variation effect) can be changed in real time by controllers on a connected MIDI instrument. Assignable Controller 1 lets you determine which controller (for example: modulation wheel, breath controller, foot controller, etc.) is used for that purpose.
- AWM2** Abbreviation for Advanced Wave Memory 2, an enhanced version of Yamaha's original tone generation system, featuring digital filters for superior sound.
- bank** A set of Voices or programs. The MIDI standard supports up to 128 banks, each of which can contain up to 128 Voices or programs.
- edit** Editing is the process of changing or adjusting the settings of the MU50.
- EG** Abbreviation for Envelope Generator, a common control on electronic instruments that affects the "shape" (or envelope) of the sound in time. The MU50 provides two types of EGs: one for level and the other for pitch.
- Filter** A control for affecting the frequency content of a sound. Filters are used to selectively cut or boost certain frequency ranges in the sound — subtly enhancing the sound, or dramatically changing its character. On the MU50, the Filter can be controlled in real time with the Assignable Controller 1.
- General MIDI (GM)** An addition to the MIDI standard which effectively ensures that any General MIDI-compatible song data can be properly played back on any General MIDI-compatible tone generator. The standard specifies that a GM-compatible tone generator must have at least 24-note polyphony, 16-part multi-timbral capacity and 128 standard voices.
- host computer** The controlling computer in a computer music system. The host computer is connected to the MU50 (via the TO HOST or MIDI terminals) and runs the software necessary for recording and playing back song data, which is reproduced by the internal sound sources and effects of the MU50.
- LFO** Abbreviation for low frequency oscillator, which generates a low frequency signal that is used to modulate certain aspects of the sound, such as pitch or level. Chorus, Flanger, Tremolo, Vibrato and other modulation effects use LFOs.
- MIDI** Acronym for Musical Instrument Digital Interface, a worldwide standard that allows MIDI-compatible instruments and devices to communicate with each other. For the instruments to communicate, they normally must be set to the same MIDI channel.
- modulation wheel** A controller found on most MIDI keyboards which is normally used to control pitch and other types of modulation. It can be used to control various aspects of the MU50 sound by proper setting of the Assignable Controller 1. (See pages 77.)
- multi-timbral** This refers to the capacity of a tone generator to produce several different sounds at once. The MU50 is a 16-Part multi-timbral tone generator, capable of playing 16 different instrument Voices at once, each over an independent MIDI channel.
- Mute** The Mute function of the MU50 allows you to silence one Part to hear how all of the other Parts sound without it.
- parameter** The word "parameter" refers to any adjustable setting of an electronic musical instrument. For example, the Filter function of the MU50 has two parameters: Cutoff Frequency and Resonance.
- Part** The Voices of the MU50 are assigned to separate Parts, and up to 16 of these Parts can sound simultaneously. Parts are analogous to the various instrumental parts in music: e.g., piano part, guitar part, etc.
- Performance** In the MU50, "Performance" refers to an operation mode and the programs that are used in that mode. A Performance can contain up to four different Parts, all controllable over the same MIDI channel. The preset Performances of the MU50 are special multi-Part sound programs designed particularly for live performance and studio recording purposes.

Pitch Bend A function found on virtually all MIDI keyboards (usually controlled with a pitch bend wheel) that allows the pitch to be raised or lowered continuously. The Pitch Bend Control parameter on the MU50 allows you to set the range over which the pitch can be changed.

polyphony The number of notes that can be sounded simultaneously by an electronic instrument. The MU50 has 32-note polyphony, ensuring that even the most complex song data will play back completely and accurately, with no “note robbing.”

Portamento A function found on early synthesizers that creates a continuous pitch glide between successively played notes. On the MU50, the time of the pitch glide can be adjusted.

return Related to effect operation, “return” refers to the effect-processed signal that is returned to the overall sound mix. For example, the parameter Reverb Return determines the amount of Reverb-processed signal that is blended with the overall sound mix of the MU50. (“Return” is the companion function of “send” below.)

send Related to effect operation, “send” refers to the signal that is sent to an effect for processing. For example, the parameter Reverb Send determines the degree to which an individual Part is processed with the Reverb effect. (“Send” is the companion function of “return” above.)

sequencer A device used for recording, editing and playing back of MIDI data. Sequencers are generally of two types: “dedicated” sequencer units, and computer-based sequencing software. The MU50 can be used with either type.

Solo The Solo function of the MU50 allows you to isolate a single Part, to hear how that Part sounds by itself.

Sound Module mode The MU50 has five Sound Module modes, and these determine the basic operation of the unit as a tone generator. Three Multi modes (XG, TG300B, C/M and DOC) and one Performance mode (PFM) are available.

tone generator An electronic instrument that functions as a MIDI-controllable sound source. For the most part, the term “tone generator” refers to those devices that have no keyboard or other controller, but are meant to be connected to and played from a separate keyboard or computer.

Variation In the MU50, “Variation” refers to the special section of various effects, including Reverb, Delay, Chorus, and many others. The Variation effects total 44, and can be used simultaneously with the other effect sections of the MU50: Reverb, and Chorus.

velocity The speed at which a note is played (for example, on a keyboard). Normally, the faster (or harder) a key is struck, the higher the corresponding note’s velocity — and, hence, the louder the sound produced. The MU50 features a variety of velocity-related parameters that provide extensive control over the velocity response of the Voices, and even allow you to set up sophisticated velocity splits, in which the Voices change in response to playing velocity.

Vibrato Vibrato is a quavering, vibrating sound, and is produced in the MU50 by regularly modulating the pitch of a Voice. The speed and depth of the Vibrato can be adjusted, as well as the time it takes before the Vibrato effect is applied.

Voice The basic sound unit (or sound program) of the MU50. There are a total of 737 Voices available on the MU50.

XG-MIDI A new standard created by Yamaha which significantly improves on the General MIDI standard by providing a greater variety of high-quality Voices and enhanced effect operation.

Index

-
- A**
- All Part control 40–42, 72–74
 - All Part control, selecting 40
 - Alternate Group (Drum Setup) 64
 - Assignable Controller 1 77, 82
 - Assignable Controller 1 Amplitude Control 82
 - Assignable Controller 1 Control Change
 Number 77
 - Assignable Controller 1 Filter Control 82
 - Assignable Controller 1 Variation Control 90
-
- B**
- Bank (Performance mode) 67–68
 - Bank Number (Multi mode) 37
 - Bank Number (Performance mode) 69
 - banks, changing 18, 67–68
-
- C**
- C/M mode 34, 54, 103, 105
 - Cable messages 106
 - Chorus 88–89
 - Chorus Pan 88–89
 - Chorus Return (Multi mode) 41
 - Chorus Return (Performance mode) 74
 - Chorus Send (Drum Setup) 63
 - Chorus Send (Multi mode) 39
 - Chorus Send (Performance mode) 71
 - Chorus Send (to Reverb) 89
 - Chorus Type 88
 - Common parameters 75–77
 - computer, connecting cables 31
 - computer, connecting MU50 with 25
 - computer, IBM PC and clones 26–27
 - computer, Macintosh 25–26
 - connections, audio 12–13
 - connections, MIDI 12–13, 27–28
 - Contrast 97
 - Copy 83–84
 - Cutoff Frequency (Drum Setup) 63
 - Cutoff Frequency (Multi mode) 44
-
- D**
- Demo song 15, 104–105
 - Detune 52, 80
 - Device number 40
 - DOC mode 34, 54, 103, 105
 - Drum Setup controls 61–65
 - Drum Setup menu, selecting and editing 61–62
 - Dry Level 60, 81
 - Dry/Wet (Variation) 90
 - Dump Interval 97
 - Dump Out functions 98–101
-
- E**
- editing, in All Part 40
 - editing, in Single Part 36
 - Effect Edit mode 86–94
 - effect connections (System and Insertion) 92–94
 - EG (Envelope Generator) 45–50, 79
 - EG Attack (Drum Setup) 65
 - EG Attack Time 46
 - EG Decay 1 (Drum Setup) 65
 - EG Decay 2 (Drum Setup) 65
 - EG Decay Time 47
 - EG Release Time 47
 - Element Reserve 55
 - Expression 38
-
- F**
- Filter 43–45, 79
-
- I**
- Initialize functions 101–104
 - INPUT jack/control 24
 - Insertion connection 92–94
-
- L**
- Level (Drum Setup) 62
-
- M**
- Master Tune 95
 - Master Volume 41
 - MIDI channel, changing 72
 - MIDI data flow (diagram) 30
 - MIDI data storage device 29, 98
 - MIDI devices, connecting to 12–13, 27–28, 98
 - MIDI keyboard, playing the MU50 with 16
 - MIDI keyboard, selecting Voices with 19
 - MIDI, Receive Channel 36
 - MIDI, Receive Port 36
 - Modulation Wheel —
 - LFO Filter Modulation Depth 81
 - Modulation Wheel —
 - LFO Pitch Modulation Depth 60, 81
 - Mono/Poly Mode 54, 80
 - Multi Edit mode 43
 - Multi mode 34–65
 - Multi mode, selecting 34
 - Multi Play mode 35
 - Mute 23
 - Mute Lock 96
-
- N**
- Note Limit High 57, 80
 - Note Limit Low 57, 80
-

Note Shift (Multi mode)	39	Reverb Send (Performance mode)	70
Note Shift (Performance mode)	71	Reverb Type	86–87
<hr/>		<hr/>	
O		S	
Others parameters	52, 80	Send Chorus to Reverb	89
<hr/>		Send Variation to Chorus	91
P		Send Variation to Reverb	91
Pan (Drum Setup)	62	Single Part control (Multi mode)	36–39
Pan (Multi mode)	38	Single Part control (Performance mode)	69–71
Pan (Performance mode)	70	Single Part control, selecting	36
Part controls	6, 20, 35–42, 69–74	Solo	23
Part Edit mode	7, 10	Sound Module mode	6
Part Mode	53	Sound Module mode, selecting	34, 105
Part parameters	78–82	Store	84–85
Part settings, changing	22	System connection	92–94
Parts, selecting	20–21	System functions	95–98
Performance Bank	67, 72	System MIDI Channel	72
Performance Edit mode	9, 75–82	System Transpose	74
Performance mode	54, 66–85, 103, 105	<hr/>	
Performance Name	75–76	T	
Performance Number	72	TG300B mode	34, 54, 103, 105
Performance Pan	73	Thru Port	98
Performance Part control	69–74	Transpose	42, 74
Performance Play mode	66–68	<hr/>	
Performance Volume	73	U	
Performances, selecting Preset or Internal ...	67–68, 72	Utility mode	10, 95–105
Pitch Bend Control	60, 81	<hr/>	
Pitch Coarse (Drum Setup)	62	V	
Pitch EG	48–50	Variation	89–91
Pitch EG Attack Time	49	Variation Connection	91
Pitch EG Initial Level	48	Variation Pan	91
Pitch EG Release Level	49	Variation Return (Multi mode)	42
Pitch EG Release Time	50	Variation Return (Performance mode)	74
Pitch Fine (Drum Setup)	62	Variation Send (Drum Setup)	63
Play mode	7, 35	Variation Send (Multi mode)	39
playing the MU80	14–16	Variation Send (Performance mode)	71
Portamento Switch	58, 80	Variation Send (to Chorus)	91
Portamento Time	58, 81	Variation Send (to Reverb)	91
Program (Voice) Number (Multi mode)	37	Variation Type	90
Program (Voice) Number (Performance mode)	69	Velocity Limit High	59, 81
<hr/>		Velocity Limit Low	59, 81
R		Velocity Sensitivity Depth	55, 80
Receive Bank Select	97	Velocity Sensitivity Offset	56, 80
Receive General MIDI Exclusive	96	Vibrato	50–51, 80
Receive Note Off (Drum Setup)	65	Vibrato Delay	51
Receive Note On (Drum Setup)	64	Vibrato Depth	51
Receive System Exclusive	96	Vibrato Rate	50
Resonance (Drum Setup)	64	Voices, selecting	17–19
Resonance (Multi mode)	44	Volume (Multi mode)	37
Reverb	86–87	Volume (Performance mode)	70
Reverb Pan	87	<hr/>	
Reverb Return (Multi mode)	41	X	
Reverb Return (Performance mode)	73	XG mode	34, 53, 103, 105
Reverb Send (Drum Setup)	62	<hr/>	
Reverb Send (Multi mode)	38		

YAMAHA

