

MATTEL ELECTRONICS[®] SOCCER 2

INSTRUCTIONS

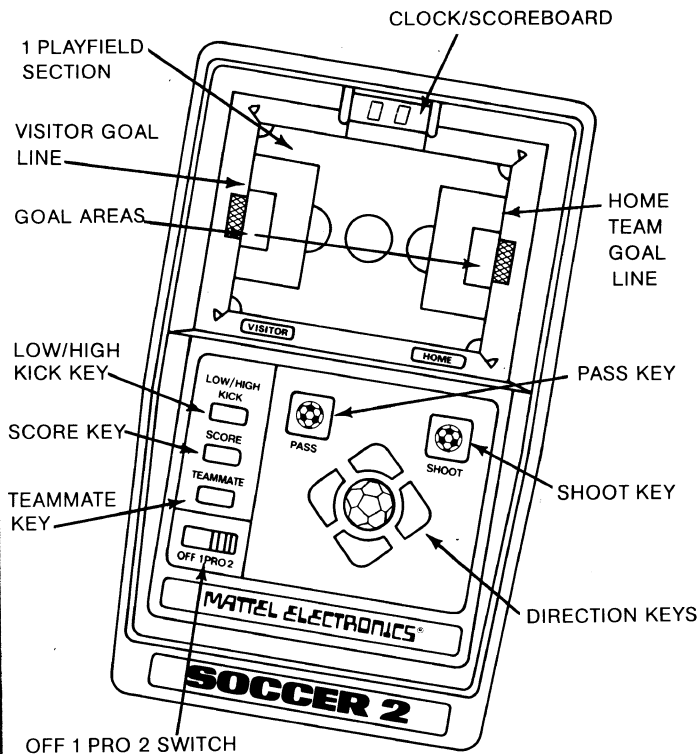

KNOW YOUR GAME



BATTERY INSTALLATION

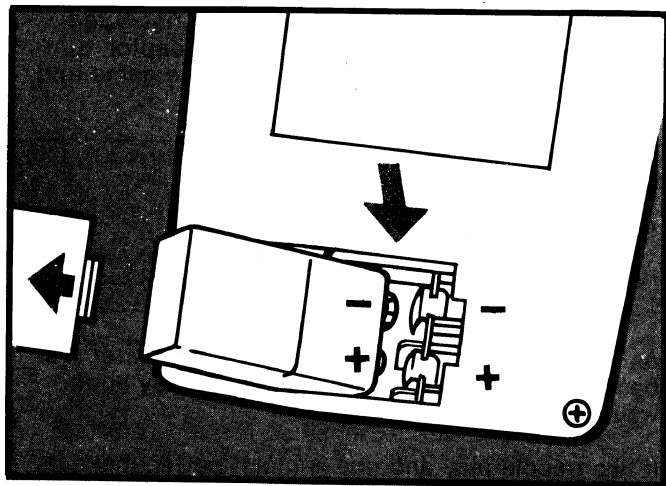

1.

Be sure the game is turned OFF. Turn game face down. Slide battery panel off.

2.

Insert a Duracell* 9-volt battery or other high quality alkaline battery and replace panel.

*Trademark of Duracell International Inc.

AC ADAPTOR USE

Use a Mattel Electronics® AC Adaptor with this game (sold separately).

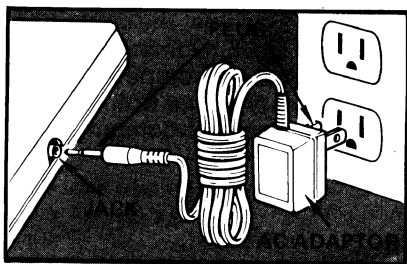

HOW TO PLAY SOCCER 2

After you have installed the battery or connected the game to a Mattel Electronics® AC Adaptor, turn the game ON. This automatically sets the game and playing speed. Here's how:

ROOKIE SOCCER	Speed 1 (slow) Turn to 1.	Speed 2 (fast) Turn to 2.
PRO SOCCER	Hold down SCORE – Turn to 1, release.	Hold down SCORE – Turn to 2, release.

As the speed increases, everything goes faster. It's best to start at the slowest speed and play your way up . . .

If two people play and one is much better, make it a more equal contest by having the better player go at a faster speed. During the game, you can change the speed by moving the Program Switch between 1 and 2.

TWO GAMES

Soccer 2 by *Mattel Electronics*® is two games in one. (Both versions are described and illustrated beginning with page 8.) With either game you can . . .

PLAY ALONE against the computer. OR PLAY AGAINST SOMEONE ELSE. Computer *always* plays defense. When two people compete, one is the Home Team, the other the Visitors. Both teams take turns trying to score against the computer-controlled goalie.

AT THE START OF THE GAME the field looks like this:

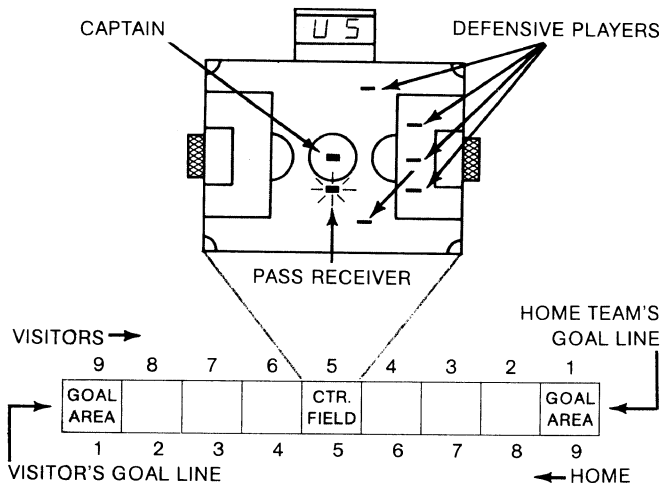

NINE SECTIONS OF THE PLAYING FIELD.

THE PLAYFIELD

You only see one section of the soccer field at a time. However, you play on nine sections, which make up the full field. The scoreboard tells you which section you're playing in at any time.

Each team tries to move the ball toward opponent's goal line, in section 1. Visitors move from left to right. Home Team moves from right to left.



VISITORS HAVE THE BALL IN SECTION 5

NOTICE: *Computer V looks like U.
Hence U for V (Visitors).*

As the ball moves from one section to another, the section number changes and the scoreboard will always tell you where you are:

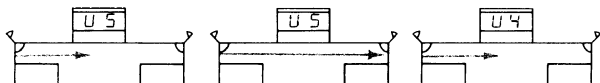

VISITORS MOVING FROM SECTION 5 TO 4

When the offense enters the last section at either end of the field, the scoreboard displays “-” to warn you that the ball is in the goal area.



VISITORS ENTER
SECTION 1,

(-) APPEARS WITH A BEEP

WHO ARE THE PLAYERS?

The brightest blip of light is the Captain (controlled player with possession of the ball). His offensive teammate, the Pass Receiver, is the slow blinking bright blip. The 5 dimmer blips are defensive players, and they're controlled by the computer. When the game starts, Visitors have the ball. *Each team controls the ball until it scores, kicks out of bounds, runs out of time in the half, or has the ball stolen or kicked away by the defense.*

CLOCK & SCOREBOARD

The digital display just above the field section is your clock and scoreboard. When you turn the game on, 4 numbers will flash:



VISITORS
SCORE



HOME
SCORE

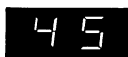

TIME REMAINING/
MINUTES IN HALF



VISITORS HAVE BALL
IN SECTION 5

Just like the pros, there are two simulated "45 minute" halves. When the clock counts down from 45 to 0, the half is over, and you'll hear a double whistle. It resets at 45 for the second half, ending the game at 0 with a triple whistle. The scoreboard shows 00 the last 10 seconds of the game. All times are compressed by using a "fast clock," so you can play 2 or 3 games in an hour if you want to. There's one point per goal.

Whenever the ball is not in play, you can see the scoreboard sequence flash by pressing SCORE.

WHAT THE FORMATIONS MEAN

During a Soccer 2 game, play action will stop when the following things happen – a score, a ball out of bounds, a turnover, or time runs out. You'll hear the ref's "whistle," press SCORE, and the electronic scene will change to one of the following formations. Learn these formations and you'll learn Soccer 2 fast!

FORMATIONS

1. *Kick-Off*: The first formation you'll see, as soon as you turn the game ON, is the *KICK-OFF*: This one comes up every time a goal is scored and at the start of both halves. Visitors get the Kick Off at the start of the game; Home at the start of the second half. When you see this formation, start the play by pressing SCORE. Then, press *PASS* to continue the action.

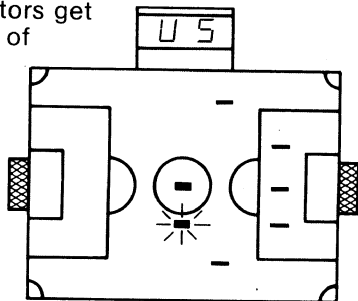

2. *Turnover*: Just like real Soccer, there *will* be **TURNOVERS**, when the defense steals the ball. (The computer-operated defense is pretty fast!) The ref's "whistle" sounds, press **SCORE** and the field is re-set so the ball's field position is exactly the same but in the other team's possession. For instance: if the ball is stolen from the Visitors when they were in section V3, the Home team now takes over possession in H7. And the position of all the players is re-set to what it was when play stopped. As soon as you press any **DIRECTION KEY**, the action starts again.

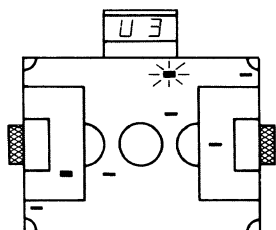

WHISTLE BLOWS WITH VISITORS IN SECTION 3.

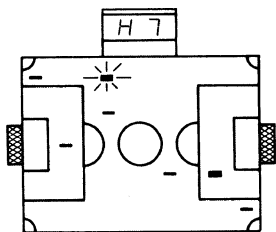

HOME TEAM TAKES POSSESSION IN SECTION 7.

3. *Throw-In*: When either team kicks the ball out at the sidelines, the ref's "whistle" sounds, press **SCORE** and the game is set up in one of these 14 **THROW-IN** formations. Four of the throw-in formations are shown here; the other ten are mirror images of these. If you have any doubt about which team now has the ball, remember to check the scoreboard for "V" or "H". Re-start the action with the **PASS KEY**.

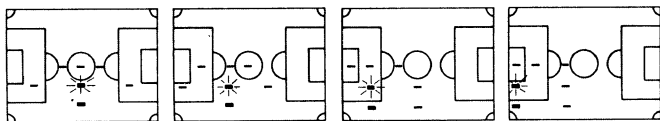

THROW IN FORMATIONS

4. *Goal Kick*: When either team kicks the ball over its opponent's goal line (and misses the goal), press SCORE and you'll see the *GOAL KICK* formation. Press PASS to re-start the play.

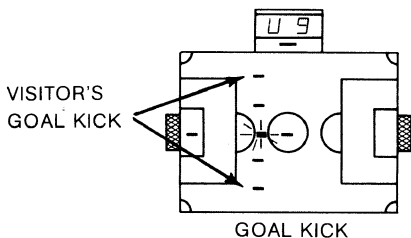

HOME TEAM
GOAL KICK
FORMATION.
LINES UP
RIGHT OF
CENTER LINE

5. *Corner Kick*: If the offensive team kicks the ball behind their own goal line, the next play starts from this *CORNER KICK* formation. It's always set up in the corner nearest the point where the ball went across the line. Press PASS to re-start the play.

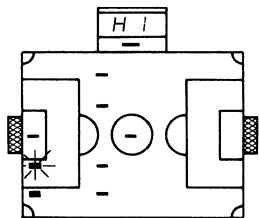

STARTING TO PLAY

Soccer 2 gives you a choice of 2 games. They have a lot in common, but Pro Soccer includes some added features. In both games, YOU ALWAYS CONTROL THE OFFENSIVE TEAM. To start either game press SCORE, then PASS. (See page 5.) Now play Soccer!

ROOKIE SOCCER

is running, passing, scoring.

Start with Rookie Soccer and master it before you try Pro Soccer.

RUNNING

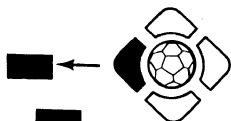

Use the 4 Direction Keys to make the Captain run in the directions of the arrows.



Plus you can move diagonally when you press two adjoining keys at the same time:

PASSING

Passing is the best way to get into scoring position. As soon as the ball is in play, the Pass Receiver starts moving. He'll try to line up with the Captain.

YOU CAN COMPLETE A PASS WHEN:

- (1) The Receiver is in the same row or diagonal line as the Captain.

AND

- (2) There are no defenders between passer & receiver.

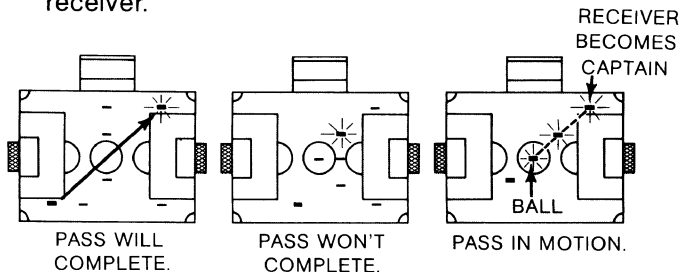

The instant the pass is kicked, the Pass Receiver becomes the Captain, controlled by the DIRECTION KEYS. You control him so he can line up to take the pass. Meanwhile, your passer disappears and all defense "freezes." Ball in motion is fast blinking bright blip. As soon as the pass is completed, Pass Receiver reappears as slow blinking blip.

Passes will travel on the ground until the Pass Receiver or defensive player get to them, or (if no player gets in the path of the ball), out of bounds. If a defensive player moves into the path of the ball, it's either intercepted or rebounded. Computer selects either randomly.

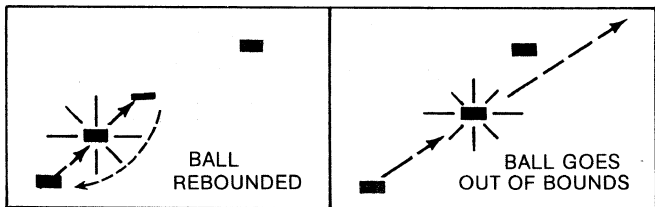

SCORING

When the ball enters the offensive goal area (Section 1), the goalkeeper appears and tries to keep you from scoring. Move your players into position for a good shot at the goal.

When you have a clear shot, press SHOOT. As soon as you shoot, the goalkeeper & all defense "freeze," and the Pass Receiver disappears. If your timing is right, you'll hear the scoring

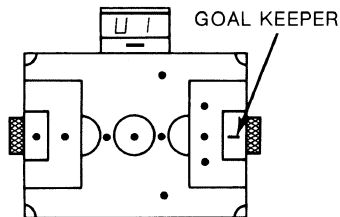

OFFENSE CAN SCORE FROM POSITIONS INDICATED.

fanfare – and you've scored a point. Press SCORE to set the Kick-Off formation.

YOU CAN SCORE A GOAL WHEN:

- (1) Shooter (brightest blip) is lined up with the goal
AND
- (2) There are no defensive players between shooter & the goal
AND
- (3) The goalkeeper is not blocking the goal

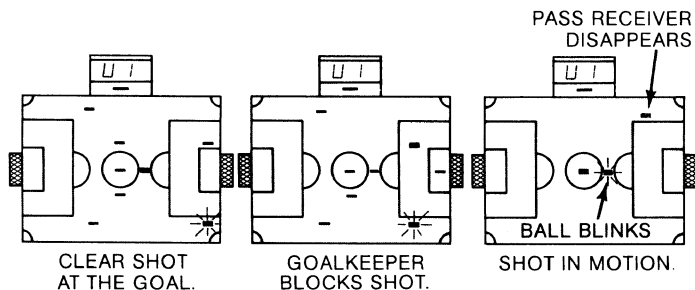

Scoring attempts make the ball go along the ground, into the goal or out of bounds. If the goalkeeper steps back into the goal just before you press SHOOT, he might rebound or intercept the ball.

The goalkeeper is the sixth defensive player (controlled by the computer). He can intercept scoring attempts, steal the ball and intercept and rebound passes. The goalkeeper can block the goal and move to one space on either side as he tries to block your kicks. He can also steal the ball when you stand in front of him.

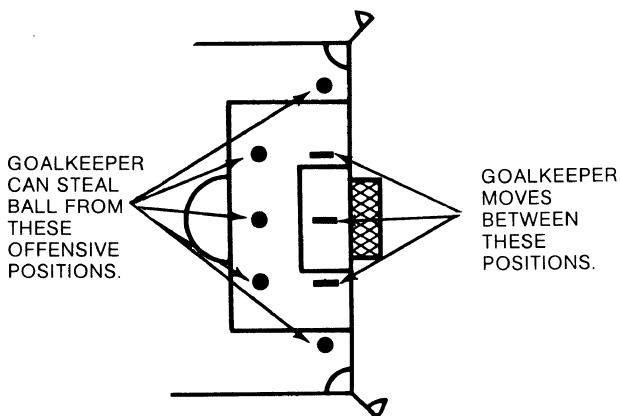

PRO SOCCER

adds low/high kicks, you
control teammate, defense
can kick ball away.

Master Rookie Soccer before you try Pro Soccer.

DEFENSE KICKS BALL AWAY (LOOSE BALL)

Defensive players can kick the ball away from the Captain. While the loose ball moves (the Pass Receiver disappears). Use the DIRECTION KEYS to make your Captain go after the ball. Defense will keep trying to kick the ball away, and may even score against you.

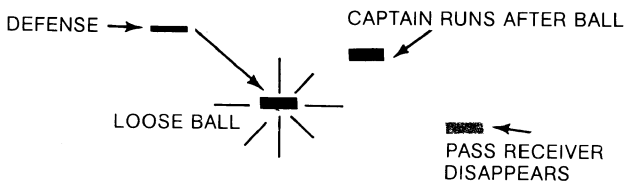

When defense kicks the ball away, it always goes in the direction of opponent's goal. It can be kicked into another section, so watch the scoreboard number. Also, when the "whistle" sounds, check to see whose ball it is. The computer defense sometimes intercepts the ball but kicks it out of bounds. In that case, the offense would still have possession.

LOW/HIGH KICK KEY



HIGH KICK BLOCKED.



HIGH KICK GOES OVERHEAD.

This key lets you make passes and shots that are high or low. When you change back and forth, you hear a high tone (high kick) or low tone (low kick). High kicks go over the heads of defenders and receiver, unless either is right in front of the passer or shooter or where the ball lands. In these two places, the ball can be caught by the receiver or stolen or kicked away by a defender. When play ends, game automatically resets to low kick.

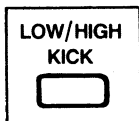

Passes in Pro Soccer are automatically set on low kicks, random lengths. If a pass falls short, the offense must run to get it. When you press LOW/HIGH KICK passes are now high kicks, long length. Defense continues to move even after pressing PASS.

Diagonal or cross-field passes go to the nearest boundary. A straight downfield pass goes just one full section.

DIAGONAL PASS WAITS AT THE BOUNDARY.

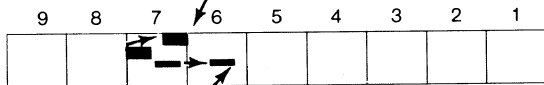

DOWNFIELD PASS GOES ONE FULL SECTION & STOPS.

Shots are automatically set on low kicks, random lengths. You can shoot in any section to advance the ball; but you can only score in section 1. When you press LOW/HIGH KICK, you hear a high tone and your shots are now high kicks, random lengths. A high shot might go over the net, and be a goal kick instead of a goal. After pressing SHOOT, the goalkeeper can step into the goal and block, and defense moves.

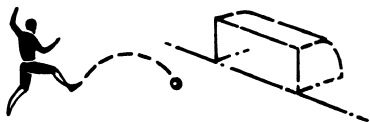

ON LOW KICKS, BALL CAN FALL SHORT.

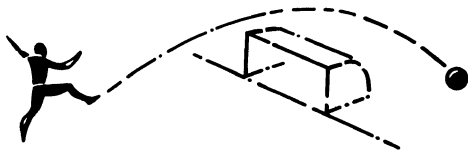

HIGH SHOTS MIGHT GO OVER NET (GOAL KICK).

TEAMMATE

Use this key to switch directional control to your Pass Receiver. Press TEAMMATE once, hear a beep, and the Direction Keys now move the blinking receiver. (This is the ONLY time the Direction Keys do not move the Captain.) Press TEAMMATE a second time, and the Direction Keys again control the Captain. Use TEAMMATE to maneuver your receiver before or during play. Teammate will remain in a fixed position until you press SCORE.



If the ball gets kicked away when Direction Keys are controlling the Pass Receiver, the receiver disappears, but he's still being controlled by the Keys. Quickly press TEAMMATE and SCORE. Now the Keys control the Captain, and the computer again moves teammate.

THE GAME HAS ENDED

When the triple "whistle" sounds, the game is over. All action on the playfield freezes. Press SCORE to see the scoreboard sequence. TO START A NEW GAME, turn the game off, then turn it on & set the next game and speed.

SOUNDS

Ticking	Ball in play, clock running
Buzz.....	A loose ball
Whistle.....	Defense stole ball or Ball out of bounds
Goal Tune.....	Goal scored
Beep	Offense in section 1 or Teammate controlled
High Tone	High shot & high pass
Low Tone	Low shot & low pass or Defense kicks ball away
Double Whistle....	End of the half
Triple Whistle	End of the game

SOME WINNING WAYS

In Pro Soccer, if you're blocked when trying to pass, *press SHOOT instead*, this sends the ball in the direction of the goal. If it stops short, your offense may be able to get it.

If defenders get too close and block forward dribbling, *move the Captain back*, even if he has to retreat into a section of the field further from the goal. You can usually get some maneuvering room this way, and can then move forward again.

When you get into scoring position, you've got to move around to foil the goalkeeper. Make him move out of the goal – quick. Shoot.

In Pro Soccer, you *can switch* back and forth from *high to low kicks*. Set for a high pass, when it's in motion, reset to low kick. Odds are better with a low, long shot at the goal.

Keep your Captain moving! Defenders can steal the ball whenever they're next to the Captain.

TAKING CARE OF YOUR GAME

Treat your SOCCER 2 game as you would treat a fine calculator: Don't drop it . . . don't leave it in a hot place, like a car glove compartment . . . don't let it get wet or dirty . . . remove the battery if the game will be stored for more than a few weeks.

IF THE BLIPS OF LIGHT REPRESENTING PLAYERS OR THE SCORE DISPLAY APPEAR TO MALFUNCTION, THIS IS THE FIRST SIGN OF BATTERY WEAR. A FRESH BATTERY SHOULD SOLVE THE PROBLEM.

90 DAY LIMITED WARRANTY

Mattel Electronics warrants to the original consumer purchaser of any of its electronic games (including hand-held electronic games) that the product will be free of defects in material or workmanship for 90 days from the date-of-purchase.

During this 90-day warranty period the game will either be repaired or it will be replaced (at our option) without charge to the purchaser when returned either to the dealer with proof of the date-of-purchase, or when returned prepaid and insured, with proof of the date of purchase, to

**MATTEL ELECTRONICS REPAIR CENTER
5150 ROSECRANS AVENUE
HAWTHORNE, CA 90250.**

Units returned without proof of the date-of-purchase, or units returned after the 90-day warranty period has expired, will be repaired or replaced (at our option) for a service charge of \$10.00. Payment must be made by check or money order. This non-warranty service will only be available for one year from the date of purchase. All non-warranty units must be returned postage prepaid and insured to Mattel Electronics Repair Center.

This warranty gives you specific legal rights and you may also have other rights which vary from state to state. This warranty does not cover damage resulting from accident, unreasonable use, neglect, unauthorized service or other causes not arising out of defects in material or workmanship.

IF YOU NEED SERVICE FROM MATTEL
ELECTRONICS REPAIR CENTER

it's available during *and* after the 90-day warranty period.

1. *Pack* the product carefully in its original box. If the box is not available, use a strong carton with plenty of newspaper or other padding. Enclose a brief note telling us the specific problem you are having with the unit, and your name and home address. Remove the batteries.
2. *Print* this address on the box:
MATTEL ELECTRONICS REPAIR CENTER
5150 ROSECRANS AVENUE
HAWTHORNE, CA 90250
... and your return address.
3. *Send* the package by insured parcel post.

During the warranty period, enclose proof-of-purchase date. After warranty has expired, enclose check or money order for \$10.00.

www.handheldmuseum.com

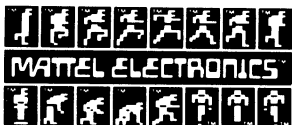

Other electronic games
available from Mattel Electronics®
Look for them!