

 Roland

MIDI SOUND MODULE

PLANET-5

MKS-30

Owner's Manual

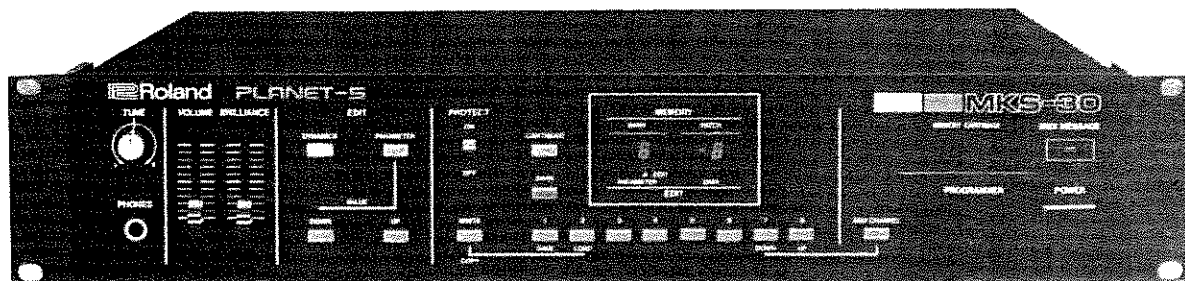

RADIO AND TELEVISION INTERFERENCE

Warning – This equipment has been verified to comply with the limits for a Class B computing device, pursuant to Subpart J, of Part 15, of FCC rules. Operation with non-certified or non-verified equipment is likely to result in interference to radio and TV reception.”

The equipment described in this manual generates and uses radio-frequency energy. If it is not installed and used properly, that is, in strict accordance with our instructions, it may cause interference with radio and television reception.

This equipment has been tested and found to comply with the limits for a Class B computing device in accordance with the specifications in Subpart J, of Part 15, of FCC Rules. These rules are designed to provide reasonable protection against such a interference in a residential installation.

However, there is no guarantee that the interference will not occur in a particular installation. If this equipment does cause interference to radio or television reception, which can be determined by turning the equipment on and off, the user is encouraged to try to correct the interference by the following measure:

- Disconnect other devices and their input/output cables one at a time. If the interference stops, it is caused by either the other device or its I/O cable.

These devices usually require Roland designated shielded I/O cables. For Roland devices, you can obtain the proper shielded cable from your dealer. For non Roland devices, contact the manufacturer or dealer for assistance.

If your equipment does cause interference to radio or television reception, you can try to correct the interference by using one or more of the following measures:

- Turn the TV or radio antenna until the interference stops.
- Move the equipment to one side or the other of the TV or radio.
- Move the equipment farther away from the TV or radio.
- Plug the equipment into an outlet that is on a different circuit than the TV or radio. (That is, make certain the equipment and the radio or television set are on circuits controlled by different circuit breakers or fuses.)
- Consider installing a rooftop television antenna with coaxial cable lead-in between the antenna and TV.

If necessary, you should consult your dealer or an experienced radio/television technician for additional suggestions. You may find helpful the following booklet prepared by the Federal Communications Commission:

“How to Identify and Resolve Radio-TV Interference Problems”

This booklet is available from the U.S. Government Printing Office, Washington, D. C., 20402, Stock No.004-000-00345-4.

PANEL DESCRIPTION

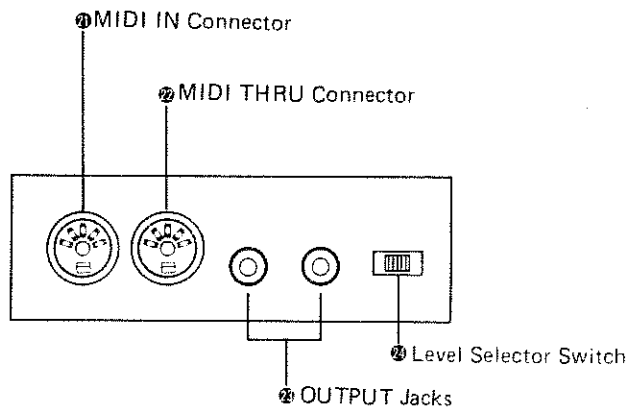
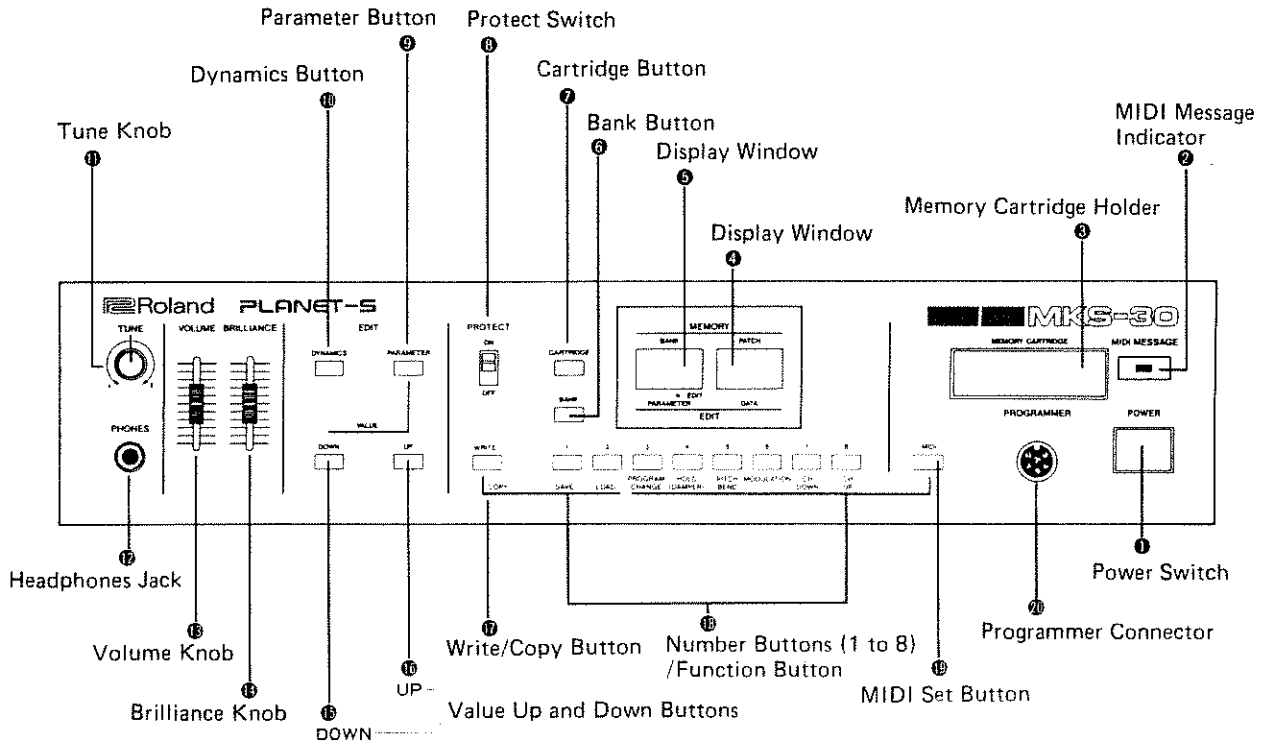

FEATURES

- The MKS-30 is a 6 voice, programmable synthesizer module. It can be effectively used with a MIDI keyboard, sequencer or home computer, as an extra sound source.
- The MKS-30 has memory capacity that retains 64 different tone colors. Moreover, the supplied Memory Cartridge M-16C expands available memory capacity up to 128 patch programs.
- By using the copy function that allows a tone color transfer between the internal memory of the MKS-30 and the cartridge, editing and writing data is extremely easy.
- The edit function and the optional programmer PG-200 make even more sophisticated synthesis possible.
- The MKS-30 is rack mounting type, therefore can be comfortably, and compactly set up with other rack systems or the MKS series.

CONTENTS

1	Panel Description	3	E. Memory Cartridge	21	
2	Connection	6	a. Attaching the Memory Cartridge	21	
3	Operation	7	b. Cartridge Mode	21	
A.	Outline of the MKS-30	7	c. Patch Transfer	22	
B.	Play Mode	7	d. Saving and Loading	22	
a.	MIDI Channel Setting	7	F. Control Knobs	23	
b.	Recalling a Patch Program	8	a. Brilliance Knob	23	
C.	Edit Mode	9	b. Volume Knob	23	
a.	Parameters for Synthesis	9	c. Tune Knob	23	
b.	Editing with the Pannel Buttons	16	G. Other MIDI Messages	24	
c.	Editing with the PB-200	17	a. Pitch Range	24	
D.	Write	18	b. Selecting MIDI Messages	24	
a.	Writing a Tone Color	18	4	Specifications/Options	24
b.	Copy Function	20			

Please read the separate volume "MIDI" then this owner's manual for better understanding of the MKS-30.

IMPORTANT NOTES

Power Supply

- The appropriate voltage to be used is shown on the name plate on the rear panel. Be sure that it meets the voltage system in your country.
- Do not use the same socket that is used for any noise generating device, such as a motor, or variable lighting system.
- When setting up the MKS-30, be sure that all the units are turned off.
- This unit might not work properly if turned on immediately after turned off, or if the power cable is plugged in with the unit turned on. If this happens, simply turn the unit off, and turn it on again in a few seconds.

Cleaning

- Use a soft cloth and clean only with a mild detergent.
- Do not use solvent such as paint thinner.

Location

- Operating the MKS-30 near a neon or fluorescent lamp may cause noise interference. If so, change the angle or position of the MKS-30.
- Avoid using the MKS-30 in extreme heat or humidity or where it may be affected by dust.

Other Notes

- This unit might get hot while operating, but there is nothing to worry about it.
- Save the data in memory onto a cartridge or make a synthesize memo of each tone color, before having the MKS-30 repaired. The data may be accidentally lost during repairing process, and if it happens, there is no way to retrieve it.

2 CONNECTION

MIDI Connection

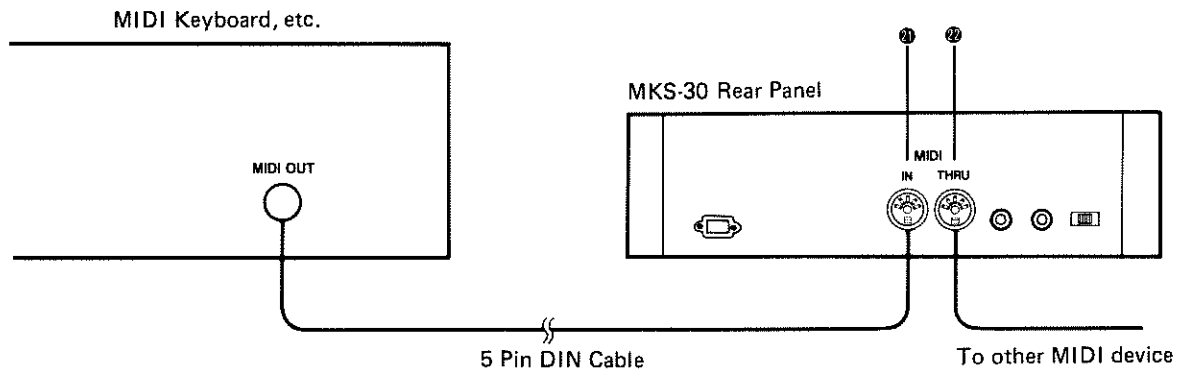

Amplifier Connection

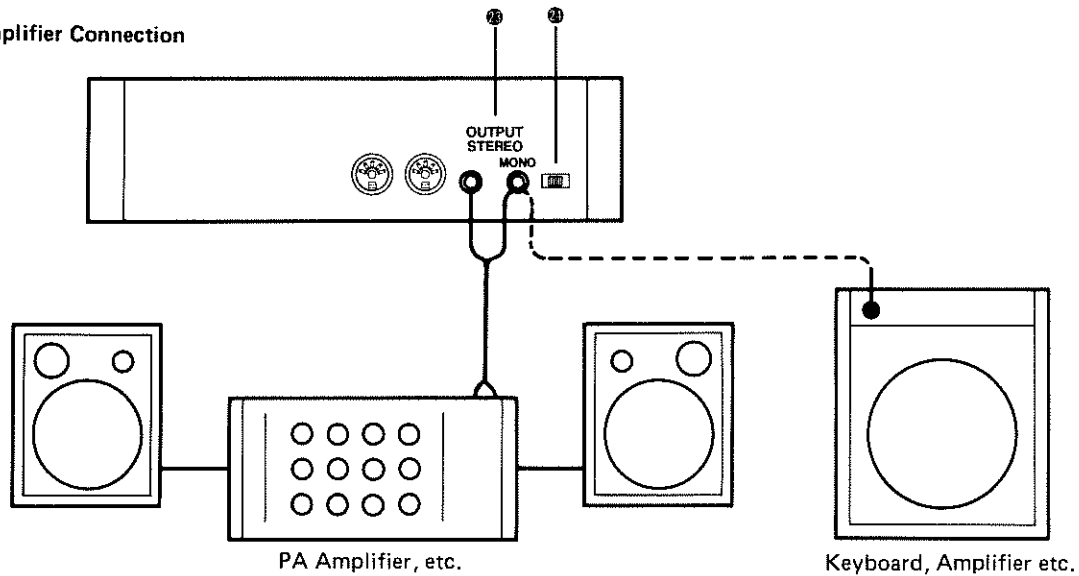

1. MIDI IN ①

2. MIDI THRU ②

How these connectors function is fully explained in a different volume "MIDI".

3. OUTPUT ③

This is an output jack to connect to an amplifier such as keyboard amplifier, PA or audio equipment. To play the MKS-30 simultaneously with other instrument, an audio mixer is required. Playing in stereo will give more effective chorus sound.

4. Level Selector Switch ④

The output level should be changed with this switch, depending on the type of amplifier used. The appropriate level setting should not allow any distortion with the amplifier's volume set to 5 to 7.

5. Headphones Jack ⑤

Connect stereo headphones to this jack. The volume can be adjusted with the Volume Knob ⑥.

3 OPERATION

A Outline of the MKS-30

The MKS-30 is a polyphonic synthesizer module operated by the music data received from an external device.

If the MKS-30 is properly set up with a MIDI device transmitting music data, it will be turned to the Play mode by powered on.

There are 64 different tone colors preprogrammed (8 banks x 8 patch numbers). You can recall any of those patches and edit it as you like. This editing operation, however, does not automatically rewrite the existing patch program. If you wish to write the edited program, appropriate writing operation is required. Writing a new patch program, however, replaces the one currently written.

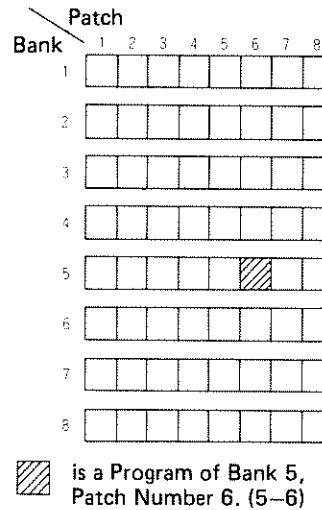

B Play Mode

When the MKS-30 is first turned on, the Display Windows ④ and ⑤ show [CH] [], then in a few seconds, [] [-]. The first display "CH 1" represents the MIDI Channel number on which data can be received. The second display "1 - 1" means a patch program of bank 1, patch number 1. Now receiving message on MIDI Channel 1 from the transmitter, the MKS-30 starts operating. (↗)

a. MIDI Channel setting

- ① Press the MIDI Channel Button ⑩, and the Display Windows show the current MIDI Channel number on which the MKS-30 can receive the message, such as [CH] [].
- ② To change the Channel number, press the UP or DOWN Button which is 8 or 7 of the Number Buttons, while holding the MIDI Channel Button.

While the message is being received, the MIDI Message Indicator ② flashes. If the message is sent on a Channel other than 1, it cannot be received by the MKS-30, therefore, the indicator does not light. In the OMNI mode, the MKS-30 receives the message of any Channel number.

- * The Channel number you have set is written into the MKS-30's memory and it is not erased even if the unit is switched off. So, right after power on, the Display Windows show the Channel number you have previously set.

b. Recalling a Patch Program

After MIDI Channel number, shown in the Display Windows are the Bank and Patch number of a current patch program.

If you wish to call a different patch program, do as follows.

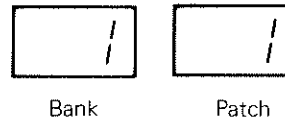

- ① Press a Number Button (1 to 8) to assign the Patch number of the tone color you wish to call.
- ② To assign the Bank number, press the Bank Button **6** first, then a relevant Number Button (1 to 8).

* Either of above procedure 1 or 2 can be done first.

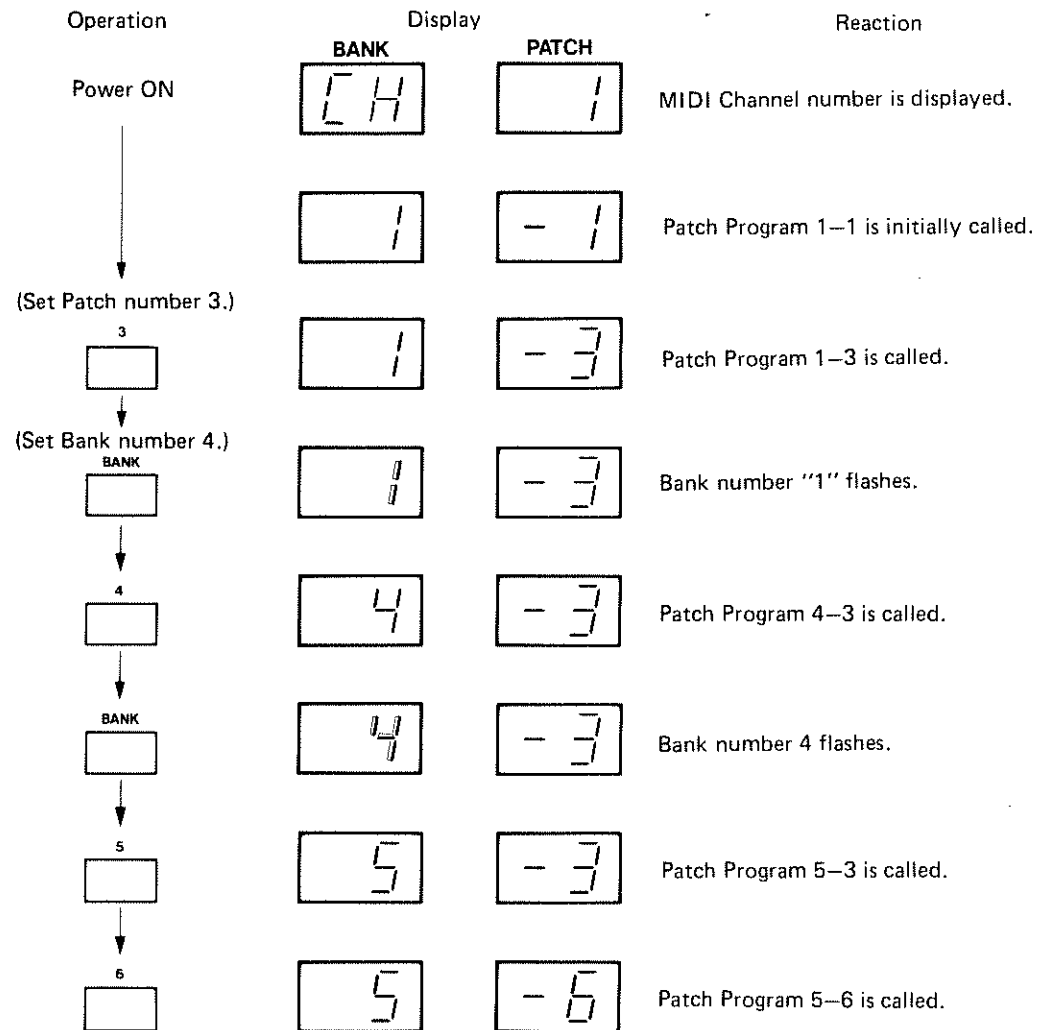

C Edit Mode

Like any analog synthesizer, the MKS-30 has parameters which can be edited for sound synthesis. It, however, does not have knobs or switches on its panel for you to touch or move. Instead, there are two methods of adjusting each parameter. One is by using the optional programmer PG-200 which works

just like panel controls of a synthesizer. The other method is changing the value of each parameter by using the panel buttons on the MKS-30. Each parameter has a number as shown in the Edit Map. The Edit Map is identical to the front panel of the PG-200.

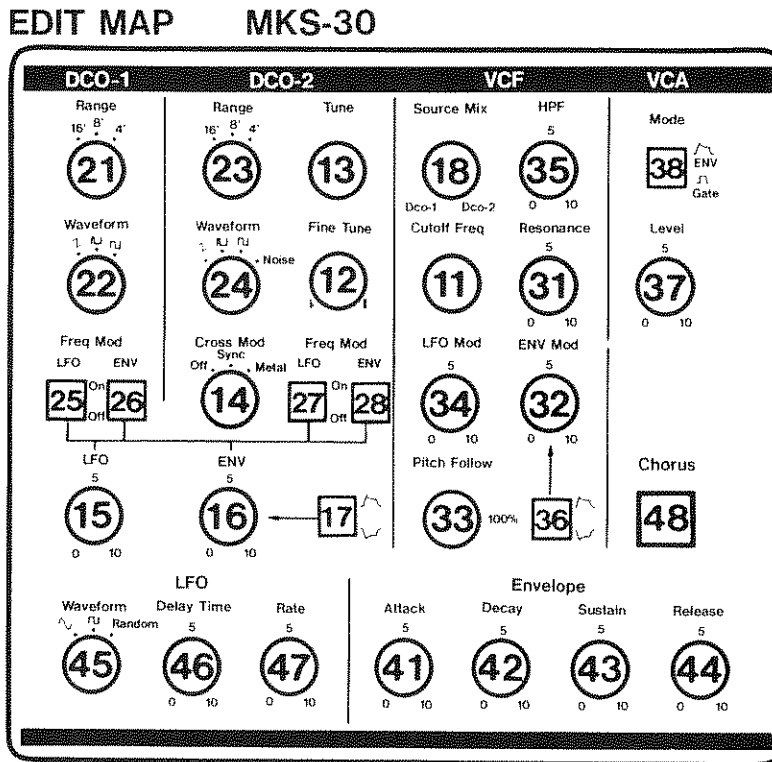











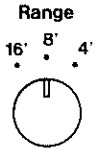



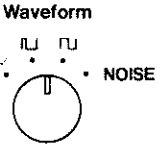

a. Parameters



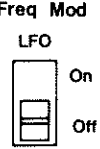



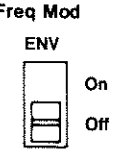



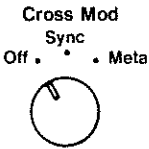



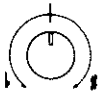

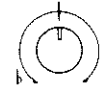

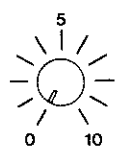
The table below shows all the relevant parameters for editing a tone color. It also includes the display reaction of the MKS-30 and the functions of the PG-200.

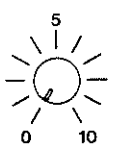

How to adjust each parameter by using the panel buttons of the MKS-30, or with the PG-200 is explained on P 16.

DCO (Digitally Controlled Oscillator)

DCO is the digitally controlled oscillator that controls the pitch and generates the waveforms that are the sound source of the synthesizers. Owing to its digital control system, this offers superior pitch stability compared to the VCO (Voltage Controlled Oscillator).

Programmer (PG-200)	Function	Display	
		Parameter Number	Parameter Value
<p>Range</p> 	<p>This is to change the pitch range of the DCO in exact one octave steps from 4' to 16' (4', 8', 16'). 8' is standard.</p>	<p>DCO-1</p> <p>21</p>	<p>16'</p>  <p>8'</p> 
		<p>DCO-2</p> <p>23</p>	<p>4'</p> 
<p>Waveform</p> 	<p>This is to choose the output waveform of the DCO. Set it to  for pulse width modulation. [NOTE 1]</p>	<p>DCO-1</p> <p>22</p>	  
		<p>DCO-2</p> <p>24</p>	 <p>NOISE</p> 
<p>Frequency Modulation (LFO switch)</p> 	<p>When this is set to ON, the LFO Section controls the frequency (pitch) of the DCO. To adjust the depth of modulation, use the ENV Depth Knob and the Polarity Switch. Select  for vibrato effect. can be obtained. [NOTE 2]</p>	<p>DCO-1</p> <p>25</p>	<p>On</p> 
		<p>DCO-2</p> <p>27</p>	
<p>Frequency Modulation (ENV switch)</p> 	<p>When this is set to ON, the ENV signal controls the frequency (pitch) of the DCO. To adjust the depth of the modulation, use the Polarity Switch.</p>	<p>DCO-1</p> <p>26</p>	<p>Off</p> 
		<p>DCO-2</p> <p>28</p>	

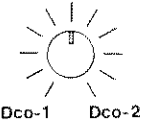
<p>Cross Modulation</p> 	<ul style="list-style-type: none"> • Sync: The frequency of the DCO-2 synchronizes with that of the DCO-1. The fundamental of the DCO-2 is decided by that of the DCO-1. Therefore, you can generate a unique waveform that is impossible to obtain by "Off" setting. • Metal: By controlling the DCO-1 with the output signal from the DCO-2, ring modulation style sound can be obtained. [NOTE 3] • Off: Each DCO-1 and DCO-2 can have different pitch and waveform. [NOTE 3] 		<p>Off</p>  <p>Sync</p>  <p>Metal</p> 
<p>Fine Tune</p> 	<p>The frequency (pitch) of the DCO-2 can be adjusted with this knob.</p> <ul style="list-style-type: none"> • Variable range . . . ± 15 cent (438 ~ 446 Hz) 		
<p>Tune</p> 	<p>This adjusts the frequency (pitch) of the DCO-2.</p> <ul style="list-style-type: none"> • Variable range . . . Approx. ± 1200 cent (1 octave) 		
<p>LFO Depth</p> 	<p>When the LFO output is modulating the DCO, this knob is used to adjust the depth of the modulation.</p>		
<p>ENV Depth</p> 	<p>When the ENV output is modulating the DCO, this knob is used to adjust the depth of the modulation.</p>		
<p>Polarity Switch</p> 	<p>This selects the polarity of the Envelope curve. Normally,  is used. In  mode, the ADSR patterns will be all inverted, therefore, pitch alteration, too. The depth of the modulation is adjusted with the ENV Depth Knob.</p>		 

<p>Source Mix</p> <p style="text-align: center;">Source Mix</p> 	<p>This is used to adjust the volume balance between the DCO-1 and DCO-2. In the center position, the volumes of the DCO-1 and DCO-2 are equal.</p>		
--	---	---	---

[NOTE 1]

Pulse width modulation is done only in the DCO-2. The necessary procedures are as follows.

- ① Set the Cross Mod to the SYNC position.
- ② Set the Source Mix to fully clockwise so that you can hear only the DCO-2 sound. (Turn it toward DCO-1, when the DCO-1 sound is necessary.)
- ③ By rotating the Tune Knob, you can change the pulse width. In its center position, the pulse width is 50% (square wave).

[NOTE 2]

When you control the depth of the vibrato effect by means of MIDI Modulation message, set this switch to the Off position.



The rate of the vibrato is to be set with the Rate Knob beforehand.





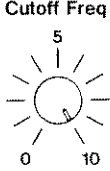

[NOTE 3]

The waveform of the DCO-2 will be always a saw tooth (\sphericalangle).

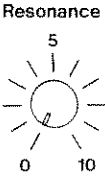
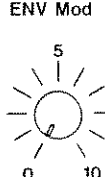
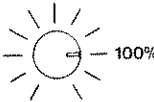
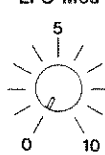
VCF (Voltage Controlled Oscillator)

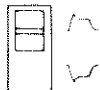
The output signal goes to the Source Mix then to the VCF to be filtered. Each VCF lets lower frequency harmonics pass and cuts off the higher ones. In other words, it is a usual low pass filter. By controlling the cutoff point and resonance, the waveform changes, thereby the tone color alters.

Programmer (PG-200)	Function	Display	
Parameter		Parameter Number	Parameter Value
<p>Cutoff Frequency</p> <p style="text-align: center;">Cutoff Freq</p> <p style="text-align: center;">5</p> 	<p>This knob is for changing the cutoff point of the VCF. As you rotate the knob clockwise, cutoff frequency will come down, and the waveform gradually becomes approximation of a sine wave, then the sound will fade out.</p>		

<p>Resonance</p> 	<p>This control is used to emphasize the cutoff point. As you rotate the knob, the created sound will become more unusual, more electronic in nature.</p>	<p>31</p>	
<p>ENV Modulation</p> 	<p>This knob is used to control the cutoff point of the VCF in each note with the ENV curve set in the ENV section. As you rotate this knob clockwise, tone color within one note changes more drastically.</p>	<p>32</p>	
<p>Pitch Follow</p> 	<p>This knob can shift the cutoff point by pitch message. In the "100%" position, it prevents any inconsistency in the harmonic contents caused by pitch alteration.</p> <p>Parameter value 92 ⇒ 100%</p>	<p>33</p>	<p>00 99</p>
<p>LFO Modulation</p> 	<p>This knob is used to control the cutoff point by the waveform of the LFO section. Rotating the knob clockwise deepens the modulation.</p>	<p>34</p>	
<p>HPF Cutoff Frequency</p> 	<p>The HPF (High Pass Filter) is a filter that passes higher frequency harmonics and cuts off the lower ones. As you rotate this knob clockwise, cutoff point goes up, lower frequency harmonics being cut off.</p>	<p>35</p>	
<p>Polarity Switch</p> 	<p>This is to select the polarity of the Envelope curve. Usually  may be used. In  mode, ADSR pattern will be inverted, so as the tone color alteration is. The depth of the ENV curve is adjusted with the ENV Modulation Knob.</p>	<p>36</p>	<p> </p>

ENV (Envelope Generator)

This generates the control voltage (Envelope) which controls the DCO, VCF and VCA, therefore, alters the pitch, tone color and volume in each note.

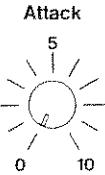
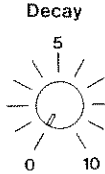
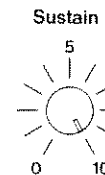
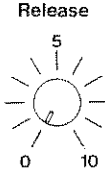
<p>Attack Time</p>  <p>The diagram shows a circular knob with a pointer pointing to the number 5. The numbers 0, 5, and 10 are marked around the dial.</p>	<p>This determines the time required for the voltage to reach its maximum from the moment the Key-ON message is received.</p>	<p>41</p>	
<p>Decay Time</p>  <p>The diagram shows a circular knob with a pointer pointing to the number 5. The numbers 0, 5, and 10 are marked around the dial.</p>	<p>This determines the time required for the voltage to drop from the maximum to the sustain level.</p>	<p>42</p>	<p>00</p>
<p>Sustain Level</p>  <p>The diagram shows a circular knob with a pointer pointing to the number 5. The numbers 0, 5, and 10 are marked around the dial.</p>	<p>This sets the sustain level to which the voltage falls at the end of the decay time. Therefore, when this knob is set to "10", the setting of the Decay Time Knob has no effect.</p>	<p>43</p>	<p>) 99</p>
<p>Release Time</p>  <p>The diagram shows a circular knob with a pointer pointing to the number 5. The numbers 0, 5, and 10 are marked around the dial.</p>	<p>This sets the time needed for the voltage to reach zero from the moment the Key-Off message is received.</p>	<p>44</p>	

Chorus

This is to produce rich and expansive sounds.

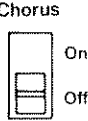
Programmer	Edit
<p>Chorus</p>  <p>The diagram shows a vertical toggle switch with 'On' and 'Off' labels. The switch is currently in the 'On' position.</p>	<p>If this is turned on, a chorus effect is obtained.</p> <p>48</p> <p>On 0</p> <p>Off 0</p>

b. Editing with the Panel Buttons of the MKS-30.

- ① Call a patch program you wish to edit, by assigning the Bank and Patch numbers.
- ② Turn the unit to the Edit mode by pressing the Parameter Button ⑨.

The Display Windows initially show , this means pitch bender data = value 2. The pitch bender data decides the maximum effect of bender (Pitch Bender Sensitivity), and it varies from semi tone to perfect 5th (value 1 to 7).

Unlike other parameters, the pitch bender sensitivity cannot be set independently in each patch program. The value set in the next procedure will stay whatever patch program may be playing. If you do not wish to change the value, just skip the next procedure ③.

- ③ Using the Value Up and Down Buttons ⑮ and ⑯, set the pitch bender value to any number you like. (1 to 7)
- ④ Assign the number of the parameter you wish to edit, by pressing the relevant Number Button ⑰. The parameter number will not change unless you press the button twice. The first two pressings will change the left figure, then the Display Window ⑤ shows a flashing bar “—” on the right asking you to set the number there.

The Display Window ④ shows the data value of the parameter.





- ⑤ While actually listening to the sound, adjust the parameter by using the value Up and Down Buttons ⑮ and ⑯. Here, the Display will respond as shown below.

By repeating procedure ④ and ⑤, keep on synthesizing.

When the Pitch Bend is set to 5 (perfect 4th)

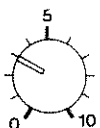
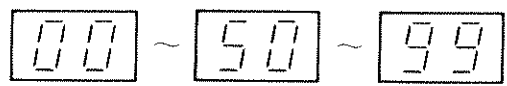
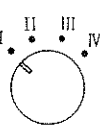

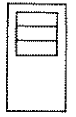
Data Display and Setting a Value

	Programmer	Data Display	Setting a Value
1	<p>Knob</p> 	<p>Knob Position</p> <p>0 ~ 5 ~ 10</p> 	<p>Higher <input type="text"/></p> <p>UP</p> <p>Lower <input type="text"/></p> <p>DOWN</p>
2	<p>Rotary Switch</p> 	<p>Switch Position</p> <p>I II III IV</p> 	<p>Toward Right <input type="text"/></p> <p>UP</p> <p>Toward Left <input type="text"/></p> <p>DOWN</p>
3	<p>Slider Switch</p> 	<p>Switch Position</p> <p>ON OFF</p> 	<p>ON <input type="text"/></p> <p>UP</p> <p>OFF <input type="text"/></p> <p>DOWN</p>

⑥ Select whether to receive velocity message or not with the Dynamics Button 10. When it is turned on, it will light up.

* This Dynamics Button can be turned on or off whatever mode the MKS-30 may be set to.

[NOTE]

When any slight editing is done, the "•" flashes indicating that the tone color currently in use is different from the one in memory. This indication helps you to understand that the edited tone color is not yet written into memory. If you wish to write the edited tone color, take an appropriate writing procedure, and the "•" will go out. (→)

If you do not want to retain the edited tone color, simply call any other patch program. Just note that calling a patch program can be done only in the Play mode. To turn the MKS-30 from Edit to Play mode, simply press the Parameter Button 9.

c. Editing with the PG-200

The optional programmer PG-200 can considerably simplify the editing operation. The PG-200 works like the control panel of a usual synthesizer, that is, you can edit the existing patch program or make a complete new patch from scratch, by actually using the tangible knobs and buttons. Also, the PG-200 functions whatever mode the MKS-30 may be set to. (Play, Edit, Manual or Write).

For hook-up, use the supplied 6 pin DIN cable (2.5m).

Connecting the PG-200

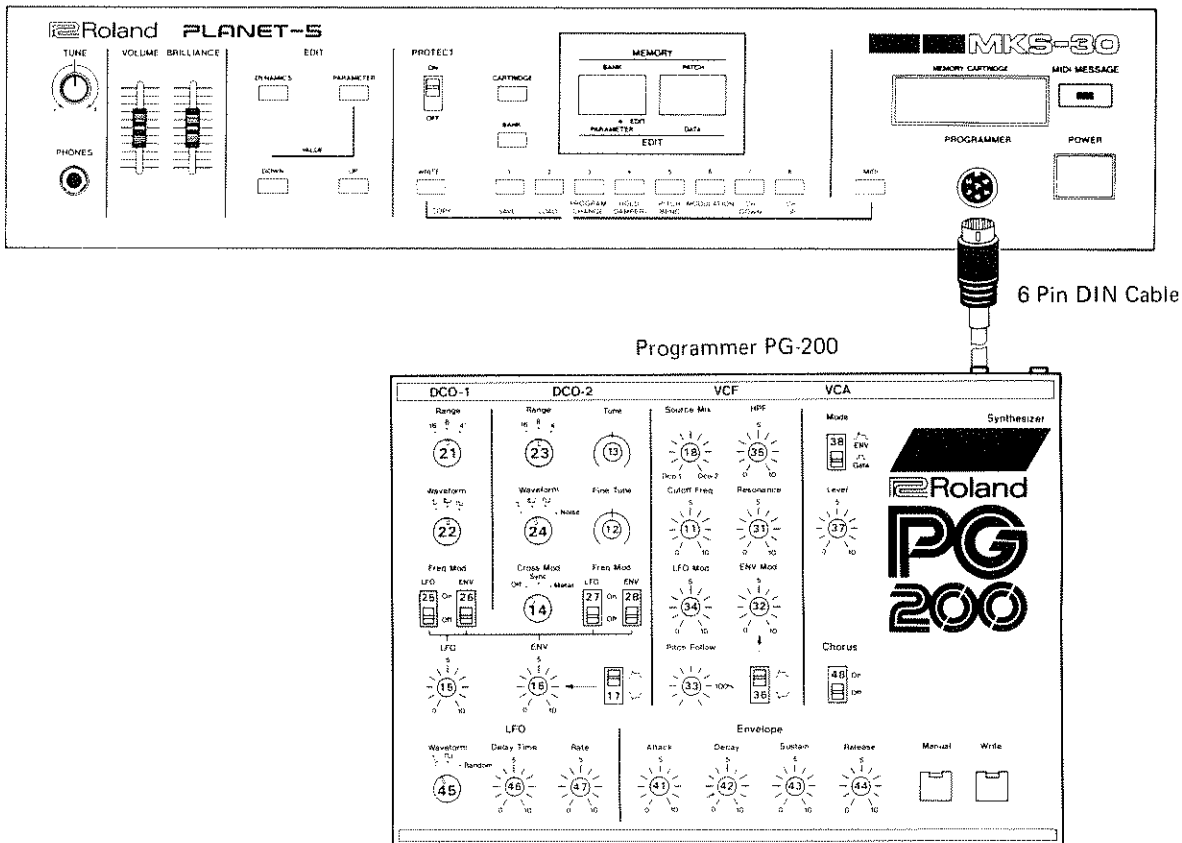

1) Play Mode

When the MKS-30 is in this mode, editing with the panel buttons is not possible. You need the PG-200. While you are editing, the " • " will flash.

2) Edit Mode

When the MKS-30 is in this mode, either editing, with the PG-200 or without, is possible. When you assign a parameter number by pressing the relevant Number Buttons, the left Display ⑤ shows the parameter number and the right Display ④ shows the parameter value.

3) Manual Mode

Pressing the Manual Button on the PG-200 will turn the MKS-30 to the Manual mode. The Display Window ④ shows . In this mode, the whole panel setting of the PG-200 decides the tone color. That is, now, existing patch program in memory has nothing to do with your sound synthesis. You make a new patch from scratch. This mode is cancelled when you select any other patch program or turn the MKS-30 to the Write mode.

* The edited patch program, either with the panel buttons or with the PG-200, cannot be retained unless a proper wiring procedure is taken.

* While editing a parameter with the PG-200, even if the current set positions of the knobs or switches are exactly what you desire, change the position once then return it. Otherwise, the parameter data might not be affected by the PG-200 at all, thereby remain unchanged.

D Write

a. Writing a tone color

1) Writing the edited tone color into the same patch program number

- ① Set the Protect Switch ⑧ to the OFF position.
- ② Turn the MKS-30 to the Write mode by pressing the Write/Copy Button ⑦. The Display Windows show the Bank and Patch numbers of the original patch program and  starts flashing.

③ Press a Number Button assigning the same patch number that is shown in the Display Windows.

* Now, writing is completed and the MKS-30 is automatically turned to the Play mode.

④ Set the Protect Switch ⑧ to the ON position.

2) Writing an edited tone color into other program number.

① Take the same procedures. ① and ② of "1) Writing the edited tone color into the same patch program number."

② Set the Bank number by pressing the Bank Button ⑥ then the relevant Number Button ⑩.

③ Set the Patch number by pressing the relevant Number Button.
Now, writing is completed and the MKS-30 is automatically turned to the Play mode.

④ Set the Protect Switch ⑧ to the ON position.

* Even if you happen to set a wrong Bank number in procedure ②, you can cancel it by simply pressing the Bank Button again and set a correct one. This is because writing is not done until you set the Patch number.

* If you happen to touch the Write/Copy Button by mistake, simply press the button again, and the Write mode will be cancelled.

* If the Bank Number shown in the right Display Window is what you desire, you can skip the procedure ③.

* If the Protect Switch is set to the ON position, writing is not done. The Display Windows show **Pr Lck** right after writing procedure. If so, set the Protect Switch to the OFF position and repeat procedure ②, ③ and ④.

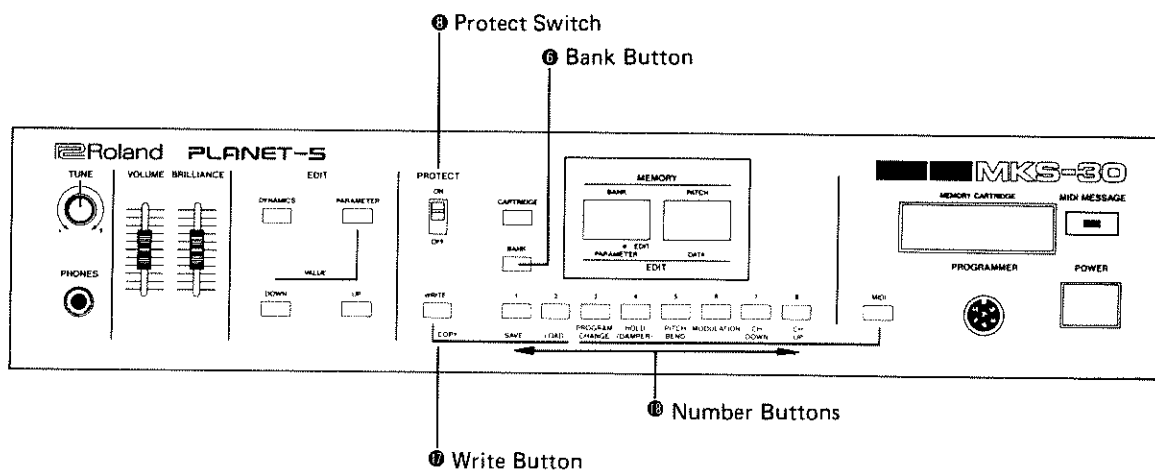

b. Copy Function

By using the Copy function, you can collect your favorite tone colors in one bank or change the places of the patch programs, etc. This copying operation, however, inevitably sacrifices one patch program.

- ① With the MKS-30 in the Play mode, call the patch program number where you wish to transfer a tone color. In other words, assign the new place for the tone color. Here, if you do not want to lose the tone color written in that patch program number, you must write it somewhere else. To do that, turn MKS-30 to the Write mode and write this tone color into the patch program number which you do not mind losing, by taking a usual writing operation. (If you do not remember how to write a tone color, refer to 4. Write.)
- ② Call the patch program you wish to transfer, then turn the MKS-30 to the Write mode, and write it into a new place.

(e.g.)

Copying patch program 2-1 to 1-2, keeping the tone color of 1-2, abandoning 2-4.

- ① Call 1-2 then write it to 2-4.
- ② Call 2-1 then write it to 1-2.

[NOTE]

Preset patches 1-1 to 4-8 (32 patches) can be restored even if lost, but those of 5-1 to 8-8 (32 patches) can never be retrieved. (Refer to Preset Patch Table.)

To restore the lost patch programs, set the Protect Switch **ⓑ** to the OFF position, then press the Bank Button while holding the Write/Copy Button down. Now, the whole set of 32 original preset patches 1-1 to 4-8 are restored, naturally, erasing the existing tone colors. Finally, set the Protect Switch to the ON position.

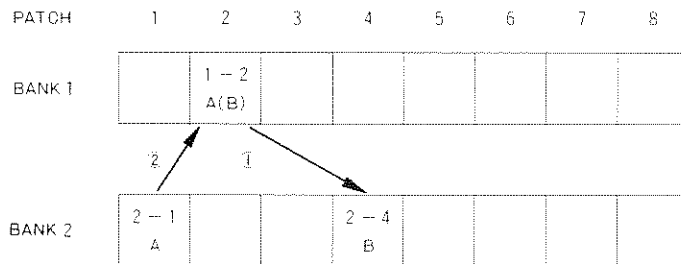

E Memory Cartridge

The Memory Cartridge M-16C, which has the same memory capacity as the internal memory of the MKS-30, expands the available patch programs up to 128. The Memory Cartridge adopts battery back-up system, and the battery will last for 5 years since it is released from the manufacturer.

a. Attaching the Memory Cartridge

Insert the cartridge securely into the Memory Cartridge Holder of the MKS-30 (with the Protect Switch on the cartridge facing upward).

- * Turn the Protect Switch on the cartridge to the ON position before connecting or disconnecting the cartridge.

b. Cartridge Mode

- 1) Each time you press the Cartridge Button **7**, the Internal Memory and the Cartridge Memory modes are alternately selected. When it is the Cartridge mode, **7** is shown on the left of the Bank number display.
- 2) Patch selection and writing procedures are exactly the same as when the internal memory is in use.
- 3) Even after the internal memory and the cartridge memory are exchanged, the previous patch program still remains unless a new patch is assigned.

Memory Cartridge

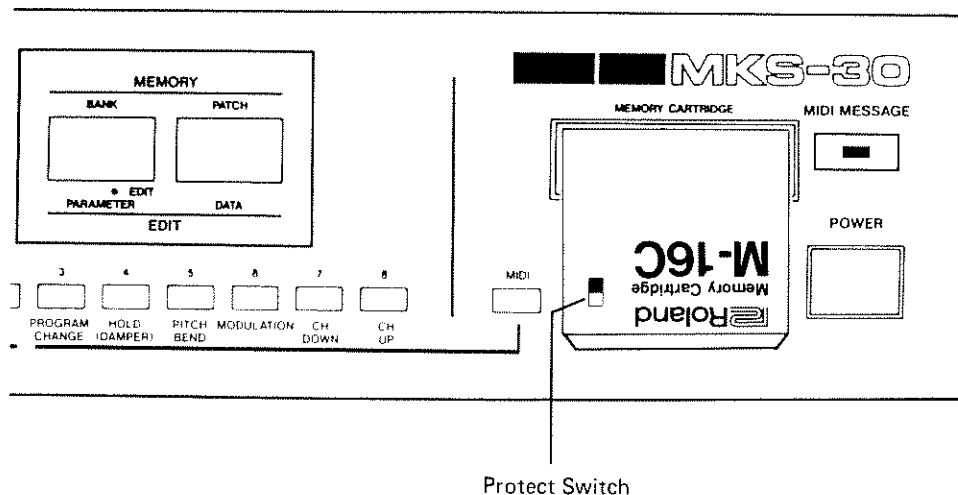

c. Patch Transfer between Internal Memory and the Cartridge Memory

1) If you wish to transfer a patch program in the MKS-30's memory onto the Memory Cartridge, do as follows.

- ① Call an internal patch program you wish to transfer to the cartridge.
- ② Turn Cartridge Button ⑦ on.
- ③ Press the Write/Copy Button ⑰ to turn the MKS-30 to the Write mode.
- ④ Set the Protect Switch on the Memory Cartridge to the OFF position.
- ⑤ Assign the Patch Program number on the cartridge where you wish to transfer the patch program from the internal memory, by using the Bank Button ④ and Number Button ⑱.
- ⑥ Set the Protect Switch of the Memory Cartridge to the ON position.

d. Save and Load

It is possible to save the whole data in the MKS-30's memory onto the Memory Cartridge. Also, you can load the data on the cartridge into the internal memory of the MKS-30.

1) Saving

- ① Set the Protect Switch on the Memory Cartridge to the OFF position.
- ② While holding the Write/Copy Button ⑰ down, press the Save Button (Number Button 1).
- ③ Set the Protect Switch on the cartridge to the ON position.

2) If you wish to transfer a patch in the Memory Cartridge into the internal memory of the MKS-30, do as follows.

- ① Turn the Cartridge Button ⑦ on, then call the patch program you wish to transfer to the internal memory.
- ② Set the Protect Switch ⑧ to the OFF position.
- ③ Press the Write/Copy Button ⑰ to turn the MKS-30 to the Write mode.
- ④ Assign the internal patch program numbers where you wish to transfer the patch program from the Memory Cartridge, by using the Bank Button ④ and the Number Button ⑱.
* The moment the Patch number is assigned, writing is done, then the MKS-30 is automatically turned to the Play mode.
- ⑤ Set the Protect Switch ⑧ to the ON position.

2) Loading

- ① Set the Protect Switch ⑧ on the MKS-30 to the OFF position.
- ② While holding the Write/Copy Button down, press the Load Button (Number Button 2).
- ③ Set the Protect Switch ⑧ to the ON position.

Saving and Loading

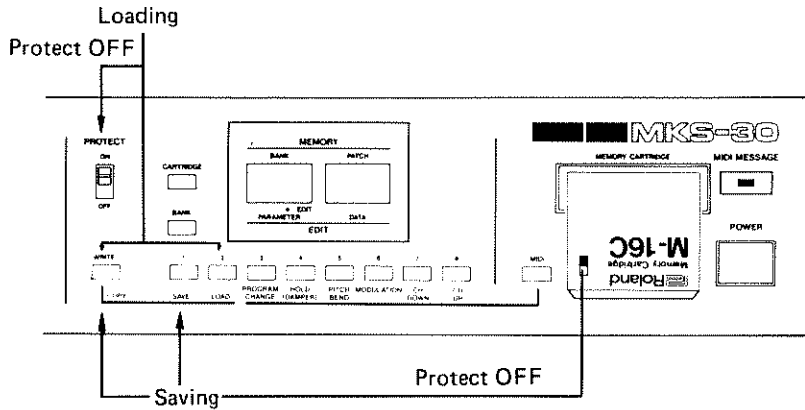

Right after the Saving or Loading operation, the Display reacts as shown below.

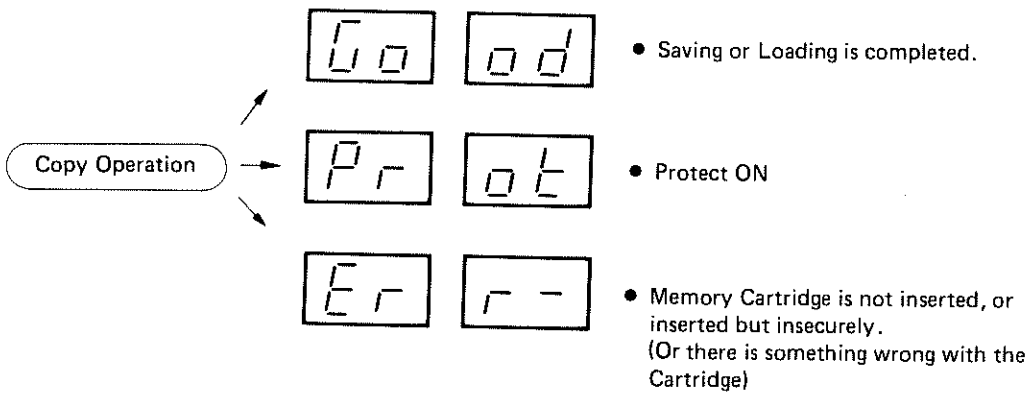

F Control Knobs

a. Brilliance Knob

Use the knob to change the cutoff frequency of the synthesizer. This can increase or decrease the cutoff frequency about 1 octave. Raising the knob makes brighter tone color. Normally, it should be set to the center position, but can be moved depending on the type of amplifier or speaker you use, or music you play. When editing a tone color, set it to the center position.

b. Volume Knob

Use this to adjust the output volume of the MKS-30. Set the volume knob of the amplifier and the Level Selector Switch  to the positions that allow comfortable playing volume, with this Volume Knob set to between 3 and 7.

Volume and Brilliance

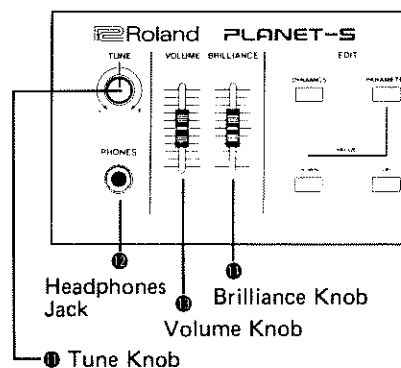

c. Tune Knob

Use this knob to tune the MKS-30 with other musical instrument. In the center position, A = 442 Hz, and it can change from 436 to 448 Hz.

G Other MIDI Messages

a. Pitch Range

When the "8" position is selected in the DCO, the MKS-30 covers the same octave range as a usual piano keyboard (88 keys). If the MIDI message, higher or lower than the top or bottom limit, is received, an octave range is shifted until it falls within the proper range.

b. Selecting MIDI Messages

The MKS-30 can receive the following 1) to 4) MIDI messages, but you can block them easily. When the message is blocked, the relevant function is turned off.

1) Program Change

2) Hold

3) Pitch Bender

4) Modulation

Operation

① Press the MIDI Channel Button, and the Display Windows show the currently selected channel number.

② While holding the MIDI Set Button **19**, press the relevant Function Button **10**.

Number Button	MIDI Message
3	1) Program Change
4	2) Hold
5	3) Pitch Bender
6	4) Modulation

Press the same Number Button again to relieve the blockade. The Display Windows tell you whether each function is on or off (whether each message is blocked or not).

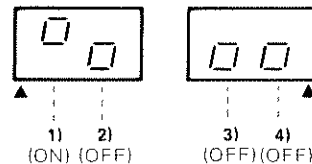

4 SPECIFICATIONS

Internal Memory Capacity : 64 patches

Cartridge Memory Capacity : 64 patches
(Memory Cartridge M-16C)

Edit : 32 Parameters

Panel Buttons

Number Buttons 1 to 8
Bank Button
Parameter Button
Value Up and Down Buttons
Write/Copy Button
Save Button
Load Button
Cartridge Button
MIDI Channel Button
Dynamics Button
Protect Switch

Controls

Volume Knob
Brilliance Knob
Tune Knob

Power Switch

Display Windows (7 Segment LED, 4 figured)

Memory Display : Bank, Patch numbers
Edit Display : Parameter number,
Parameter value

MIDI Message Indicator

Memory Cartridge Holder

Rear Panel

Output Jacks
(Standard : 5 k Ω : Stereo/Mono)
MIDI IN (5 pin DIN) Connector
MIDI THRU (5 pin DIN) Connector
Headphones Jack (8 Ω Stereo)
Programmer Connector

Level Selector Switch (H/M/L)

Consumption : 35W

Dimensions : 480(W) x 410(D) x 88(H) mm
19"(W) x 16-1/8"(D) x 3-7/16"(H)

Weight : 6.2 kg / 13 lb 11 oz

Accessories

Connection Cord (LP-25)
5 pin DIN Cord
6 pin DIN Cord
AC Cord
Memory Cartridge (M-16C)
Owner's Manual

Options

Programmer PG-200
Memory Cartridge M-16C
Carrying Case CB-2

Sound Module

MODEL MKS-30 MIDI Implementation

1. RECOGNIZED RECEIVE DATA

Status	Second	Third	Description	
1000 nnnn	0kkk kkkk	0vvv vvvv	Note OFF kkkkkk = 0 - 127 (21 - 108) velocity ignored	
1001 nnnn	0kkk kkkk	0000 0000	Note OFF kkkkkk = 0 - 127 (21 - 108)	*2
1001 nnnn	0kkk kkkk	0vvv vvvv	Note ON kkkkkk = 0 - 127 (21 - 108) vvvvvv = 1 - 127	*2
1011 nnnn	0000 0001	0vvv vvvv	Modulation	*3
1011 nnnn	0100 0000	0111 1111	hold on (1 - 126 ignored)	*3
1011 nnnn	0100 0000	0000 0000	hold off	
1100 nnnn	0ppp pppp		Program Change pppppp = 0 - 127	*3 *5
1110 nnnn	0bb0 0000	0bbb bbbb	Pitch Bender	*3, 4
1011 nnnn	0111 1011	0000 0000	ALL NOTES OFF	
1011 nnnn	0111 1100	0000 0000	OMNI OFF (ALL NOTES OFF)	*1
1011 nnnn	0111 1101	0000 0000	OMNI ON (ALL NOTES OFF)	*1
1011 nnnn	0111 1110	0vvv vvvv	ALL NOTES OFF	*1
1011 nnnn	0111 1111	0000 0000	POLY ON (ALL NOTES OFF)	*1

Notes:

- * nnnn = 0 - 15 corresponds to channel 1 - 16.
- *1 Mode messages (123 - 127) are also recognized as ALL NOTES OFF.

Mode messages are recognized as follows:

	POLY ON (127)	MONO ON (126)
OMNI OFF (124)	OMNI = OFF POLY	OMNI = OFF POLY
OMNI ON (125)	OMNI = ON POLY	OMNI = ON POLY

- * Mode messages (123 thru 127) are recognized in only the basic channel. While in OMNI ON mode, voice messages in all channels are recognized. While in OMNI OFF mode, voice messages in only the basic channel are recognized.
- * When power is first applied, the default mode is MODE 3 (OMNI OFF, POLY).
- * The basic channel can be changed by panel operation, and it is memorized when power is OFF.
- *2 Note numbers below 20 or over 109 (included) are recognized octave(s) up or down.
- *3 These are enabled or disabled to be recognized by panel operations. These conditions are memorized when power is OFF.

panel operations:

while holding down the 'MIDI CHANNEL', pressing next switch toggles these functions ON/OFF.

switch	function
3	program change
4	hold pedal
5	pitch bender
6	modulation

- *4 Sensitivity of the PITCH BENDER can be adjusted to the range of 0 thru 7 semi tones.

message	max value	min value
MSB	127	0
LSB	96	0
sensitivity		
MAX	+7	-7
MIN	+1	-1
ZERO	0	0

*5 Program change assignments are as follows:

B:bank P:patch

prog #	B	P	prog #	B	P	prog #	B	P	prog #	B	P
0	1	1	16	3	1	32	5	1	48	7	1
1	1	2	17	3	2	33	5	2	49	7	2
2	1	3	18	3	3	34	5	3	50	7	3
3	1	4	19	3	4	35	5	4	51	7	4
4	1	5	20	3	5	36	5	5	52	7	5
5	1	6	21	3	6	37	5	6	53	7	6
6	1	7	22	3	7	38	5	7	54	7	7
7	1	8	23	3	8	39	5	8	55	7	8
8	2	1	24	4	1	40	6	1	56	8	1
9	2	2	25	4	2	41	6	2	57	8	2
10	2	3	26	4	3	42	6	3	58	8	3
11	2	4	27	4	4	43	6	4	59	8	4
12	2	5	28	4	5	44	6	5	60	8	5
13	2	6	29	4	6	45	6	6	61	8	6
14	2	7	30	4	7	46	6	7	62	8	7
15	2	8	31	4	8	47	6	8	63	8	8
64	1	1	80	3	1	96	5	1	112	7	1
85	1	2	81	3	2	97	5	2	113	7	2
86	1	3	82	3	3	98	5	3	114	7	3
87	1	4	83	3	4	99	5	4	115	7	4
88	1	5	84	3	5	100	5	5	116	7	5
89	1	6	85	3	6	101	5	6	117	7	6
70	1	7	86	3	7	102	5	7	118	7	7
71	1	8	87	3	8	103	5	8	119	7	8
72	2	1	88	4	1	104	6	1	120	8	1
73	2	2	89	4	2	105	6	2	121	8	2
74	2	3	90	4	3	106	6	3	122	8	3
75	2	4	91	4	4	107	6	4	123	8	4
76	2	5	92	4	5	108	6	5	124	8	5
77	2	6	93	4	6	109	6	6	125	8	6
78	2	7	94	4	7	110	6	7	126	8	7
79	2	8	95	4	8	111	6	8	127	8	8

The program change numbers 0 thru 63 are assigned to internal memory. The numbers 64 thru 127 are assigned to the memory cartridge if it is equipped. If not, they are assigned to internal.

Sound Module

MODEL MKS-30 MIDI Implementation Chart

Function.....		Transmitted	Recognized dis en	Remarks
Basic Channel	Default Changed		1-16 1-16	memorized
Mode	Default Messages Altered	*****	3 POLY, OMNI ON/OFF <	MONO ignored
Note Number	: True voice	*****	0-127 21-108	
Velocity	Note ON Note OFF		○ ×	
After Touch	Key's Ch's		× ×	
Pitch Bender			× * ○ (0-7 semi)	9-bit reso
Control Change	1 64		× * ○ × * ○	Modulation Hold
Prog Change	True ≠	*****	× * ○ (0-127) 0-127	
System Exclusive			×	
System Common	Song Pos Song Sel Tune		× × ×	
System Real Time	Clock Commands		× ×	
Aux Messages	Local ON/OFF All Notes OFF Active Sense Reset		× ○ (123-127) × ×	
Notes	* These MIDI function can be set by panel operations, and they are memorized. Receiver only.			

Mode 1 : OMNI ON, POLY
Mode 3 : OMNI OFF, POLY

Mode 2 : OMNI ON, MONO
Mode 4 : OMNI OFF, MONO

○ : Yes
× : No

Roland[®]
RUS10008

UPC RUS10008



1998

Roland