



KORG

microKORG

SYNTHESIZER/VOCODER

Owner's Manual

Ⓔ ①

- High quality DSP analog modeling synthesizer and vocoder.
- 128 Programs, from classic analog to contemporary dance sounds.
- Sounds are grouped by musical genres for easy access.
- Quick and easy editing thanks to five "Performance Edit" knobs.
- Light weight, compact and battery driven for use with computers and on stage.
- Includes microphone for immediate fun with the onboard vocoder.

Precautions

Location

Using the unit in the following locations can result in a malfunction.

- In direct sunlight
- Locations of extreme temperature or humidity
- Excessively dusty or dirty locations
- Locations of excessive vibration
- Close to magnetic fields

Power supply

Please connect the designated AC adapter to an AC outlet of the correct voltage. Do not connect it to an AC outlet of voltage other than that for which your unit is intended.

Interference with other electrical devices

Radios and televisions placed nearby may experience reception interference. Operate this unit at a suitable distance from radios and televisions.

Handling

To avoid breakage, do not apply excessive force to the switches or controls.

Care

If the exterior becomes dirty, wipe it with a clean, dry cloth. Do not use liquid cleaners such as benzene or thinner, or cleaning compounds or flammable polishes.

Keep this manual

After reading this manual, please keep it for later reference.

Keeping foreign matter out of your equipment

Never set any container with liquid in it near this equipment. If liquid gets into the equipment, it could cause a breakdown, fire, or electrical shock.

Be careful not to let metal objects get into the equipment. If something does slip into the equipment, unplug the AC adapter from the wall outlet. Then contact your nearest Korg dealer or the store where the equipment was purchased.

THE FCC REGULATION WARNING (for U.S.A.)

This equipment has been tested and found to comply with the limits for a Class B digital device, pursuant to Part 15 of the FCC Rules. These limits are designed to provide reasonable protection against harmful interference in a residential installation. This equipment generates, uses, and can radiate radio frequency energy and, if not installed and used in accordance with the instructions, may cause harmful interference to radio communications. However, there is no guarantee that interference will not occur in a particular installation. If this equipment does cause harmful interference to radio or television reception, which can be determined by turning the equipment off and on, the user is encouraged to try to correct the interference by one or more of the following measures:

- Reorient or relocate the receiving antenna.
- Increase the separation between the equipment and receiver.
- Connect the equipment into an outlet on a circuit different from that to which the receiver is connected.
- Consult the dealer or an experienced radio/TV technician for help.

Unauthorized changes or modification to this system can void the user's authority to operate this equipment.

CE mark for European Harmonized Standards

CE mark which is attached to our company's products of AC mains operated apparatus until December 31, 1996 means it conforms to EMC Directive (89/336/EEC) and CE mark Directive (93/68/EEC).

And, CE mark which is attached after January 1, 1997 means it conforms to EMC Directive (89/336/EEC), CE mark Directive (93/68/EEC) and Low Voltage Directive (73/23/EEC).

Also, CE mark which is attached to our company's products of Battery operated apparatus means it conforms to EMC Directive (89/336/EEC) and CE mark Directive (93/68/EEC).

Data handling

Unexpected malfunctions can result in the loss of memory contents. Please be sure to save important data on an external data filer (storage device). Korg cannot accept any responsibility for any loss or damage which you may incur as a result of data loss.

Printing conventions in this manual

Knobs and keys printed in BOLD TYPE.

Knobs and keys on the panel of the microKORG are printed in **BOLD TYPE**.

Parameters " " "

Parameters are enclosed in "double quotation marks."

Symbols , ,

These symbols respectively indicate cautions, advice, and MIDI-related explanations.

MIDI-related explanations

CC# is used as an abbreviation for Control Change Number. In MIDI-related explanations, numbers enclosed in square brackets [] are in hexadecimal notation.

Display indications

The numerical values of various parameters appearing in this manual are only for explanatory purposes. They may not necessarily match what appears in the display of your microKORG.

Knob positions and parameters

Knob positions and parameter values appearing in this manual (p.16 and following) are approximations. There may be slight discrepancies between knob positions and parameter values.

* Company names, product names, and names of formats etc. are the trademarks or registered trademarks of their respective owners.

Thank you for purchasing the Korg micro KORG synthesizer/vocoder. To ensure trouble-free enjoyment, please read this manual carefully and use the product correctly.

Precautions	iii
Data handling	iii
Printing conventions in this manual	iii

Introduction 1

Explains the features of the microKORG, and the names and functions of each part.

Main Features	1
Front and rear panel	2
Front panel	2
Rear panel	4

Preparations 5

Explains how to connect external audio devices and the included mic, and how to turn on the power.

Connections	5
Connections from the audio outputs	5
Connections to the audio inputs	5
Connections to MIDI equipment/computers	5
Connecting the included mic	5
Turning the power on	6
1. The power supply	6
2. Turning the power on	6
3. Turning the power off	6

Table of Contents

Quick Start 7

Explains how to get started using the microKORG (listen to the demos, select programs, use the arpeggiator and performance functions), and perform basic editing.

Demo songs	7
Listening to the demo songs	7
Synth programs	8
1. Selecting and playing a program	8
2. Modifying the sound	8
Vocoder programs	10
1. Playing a vocoder program	10
2. Modifying the sound	10
Arpeggiator	11
Using the arpeggiator	11

Editing 12

Explains what you need to know when editing sounds on the microKORG.

Basic editing	12
Basic editing procedure	12
Editing each timbre	14

Editing a synth program 15

Explains the functions of the synth program parameters adjusted by edit control knobs 1–5 for the corresponding setting of the EDIT SELECT 1/2 knobs.

The structure of a synth program	15
Overview	15

Table of Contents

1. VOICE — SYNTH/VOCODER	16
2. PITCH — SYNTH/VOCODER	17
3. OSC1 (Oscillator 1) — SYNTH/VOCODER	18
4. OSC2 (Oscillator 2) — SYNTH	22
5. MIXER — SYNTH	23
6. FILTER — SYNTH	24
7. FILTER EG — SYNTH	26
8. AMP — SYNTH	27
9. AMP EG — SYNTH/VOCODER	28
10. LFO 1, 11. LFO 2 — SYNTH/VOCODER	29
12. PATCH 1, 13. PATCH 2, 14. PATCH 3, 15. PATCH 4 — SYNTH	30

Editing a vocoder program 31

Explains the function of the vocoder program parameters adjusted by edit control knobs 1–5 for the corresponding setting of the EDIT SELECT 1/2 knobs.

The structure of a vocoder program	31
Overview	31
1. VOICE — SYNTH/VOCODER	32
2. PITCH — SYNTH/VOCODER	32
3. OSC1 — SYNTH/VOCODER	32
4. AUDIO IN 1 — VOCODER	33
5. MIXER — VOCODER	34
6. FILTER — VOCODER	35
7. FC MOD — VOCODER	36
8. AMP — VOCODER	37
9. AMP EG — SYNTH/VOCODER	37
10. LFO 1, 11. LFO 2 — SYNTH/VOCODER	37
12. CH LEVEL A, 13. CH LEVEL B — VOCODER	38

14. CH PAN A, 15. CH PAN B — VOCODER	38
--	----

Editing the effects and EQ 39

Explains the function of the effect and EQ parameters adjusted by edit control knobs 1–5 for the corresponding setting of the EDIT SELECT 1/2 knobs.

The microKORG's effect structure	39
Overview	39
16. MOD FX — SYNTH/VOCODER	40
17. DELAY — SYNTH/VOCODER	41
18. EQ — SYNTH/VOCODER	42

Editing the arpeggiator 43

Explains the function of the arpeggiator parameters adjusted by edit control knobs 1–5 for the corresponding setting of the EDIT SELECT 1/2 knobs.

The structure of arpeggiator	43
Overview	43
19. ARPEG. A — SYNTH/VOCODER	44
20. ARPEG. B — SYNTH/VOCODER	45

Overall settings (GLOBAL) 46

Explains the function of the Global parameters adjusted by edit control knobs 1–5 for the corresponding setting of the EDIT SELECT 1/2 knobs.

GLOBAL structure	46
Overview	46
21. GLOBAL	47

Table of Contents

Using the microKORG with other MIDI devices (MIDI).. 48

Explains how to make connections with other MIDI devices, and explains the function of the MIDI parameters adjusted by edit control knobs 1–5 for the corresponding setting of the EDIT SELECT 1/2 knobs.

MIDI on the microKORG	48
Overview	48
Connecting MIDI devices/computers	48
MIDI-related settings after connection	49
22. MIDI	51
Messages transmitted and received by the microKORG	52

Saving Data

58

Explains how to save a program or Global settings that you edited.

Saving your edited settings	58
Saving a program	58
Saving GLOBAL, MIDI, and SHIFT function settings	58

SHIFT functions

59

Explains functions that use the **SHIFT** key, such as initializing a program and restoring the factory settings.

Copying and exchanging timbres — SYNTH	59
Initializing a program	59
Initializing CH LEVEL and CH PAN — VOCODER	60
MIDI Filter	60
Assigning control changes	61

Data dump	62
Restoring the factory settings	63
Write protect setting	63
Other SHIFT key functions	64

Appendix

65

Provides a troubleshooting checklist, and other information such as the specifications of the microKORG.

LFO 1/2 and delay time synchronization	65
Troubleshooting	66
Specifications and options	67
Index	68

1. Analog modeling synthesizer

The analog modeling system of the microKORG uses DSP technology to simulate an analog synthesizer. Starting with a variety of different oscillator algorithms (such as the sawtooth and square waves familiar to users of analog synthesizers) you can use the various controls located on the front panel to edit any sound, or to create sounds of your own. All sound parameters are organized into “sections”. By selecting the appropriate section and turning the appropriate knob you can edit sounds quickly, easily and intuitively. You can also modify the sound in realtime as you perform.

Number of timbres: maximum 2 (when layer is used)
Maximum polyphony: 4 voices
Structure: 2 oscillators + noise generator: sawtooth wave, square wave, triangle wave, sine wave, Vox wave, DWGS x 64, Noise, Audio In (eight types)
PWM function, OSC Sync function, Ring Mod. function, OSC Sync+Ring Mod. function
Multimode filters: -24 dB/oct LPF, -12 dB/oct LPF, -12 dB/oct BPF, -12 dB/oct HPF (four types)
Filter EQ, Amp EG, LFO1, LFO2 (LFO: six waveforms, can be synchronized to the arpeggiator or to external MIDI clock)

2. Vocoder

You can connect a mic to one of the microKORG's AUDIO IN 1 jacks, and use it as a vocoder – a device that imposes the spectral character of a voice (or other audio signal) on the sound of an oscillator, producing the impression that the oscillator is speaking.

The vocoder consists of eight channels (sixteen filters used in pairs). In addition to simulating the sounds of classic vocoder units, you can change the filter frequency and adjust the level and pan of each band to create original vocoder sounds.

Maximum polyphony: 4 voices
Structure: 8 channel vocoder, adjustable level/pan for each channel, Formant Shift function, 1 oscillator + noise generator (eight types)
Filter EG, Amp EG, LFO1, LFO2 (LFO: six waveforms, can be synchronized to the arpeggiator or to external MIDI clock)

3. 128 built-in programs

The microKORG contains 128 built-in programs. When shipped, the TRANCE-S.E./HIT banks contain 112 synth programs, and the VOCODER bank contains 16 vocoder programs.

4. Process the waveform of an external input source

The waveform of an external audio source can be input via the AUDIO IN 1 and 2 jacks, and processed in the same way as the internal waveforms.

5. Virtual Patch function

Modulators and controllers such as filter EG, amp EG, LFO 1/2, keyboard tracking, and wheel can be virtually patched (without using actual patch cables) to parameters such as pitch, cutoff, and amp. This gives you even more creative flexibility.

6. Effects to add the finishing touch to your sound

For even greater possibilities, the microKORG provides three types of modulation effect, three types of delay, and an equalizer.

The delay effect can be synchronized with the arpeggiator or an external MIDI clock, allowing numerous applications in live performance.

7. Step Arpeggiator

The microKORG's arpeggiator lets you produce an arpeggio simply by holding down a chord.

You can choose from six arpeggio types, and adjust the duration and spacing of the arpeggiated notes. You can also specify whether a note will be on or off for each of up to eight steps, letting you create a broad range of modified rhythms and other effects.

Front and rear panel

Front panel

note Items on the front panel that relate to the Vocoder are printed in green.

VOLUME knob

Adjusts the volume of the output from the OUTPUT jacks (L/MONO, R) and headphone jack.

ARPEGGIATOR ON/OFF key

Switches the arpeggiator on/off. (When on, the key LED will light.)

ARPEGGIATOR TEMPO LED

Blinks at the tempo of the arpeggiator performance. If MIDI CLOCK is set to External and MIDI Clock data is being received from the MIDI IN connector, this LED will blink at that tempo.

OCTAVE SHIFT UP, DOWN keys

Shifts the pitch range of the keyboard in steps of an octave, over a range of +/-3 octaves.

PITCH wheel

Controls the pitch.

MOD wheel

Controls the depth of modulation.

BANK SELECT dial

Selects the program bank.

BANK SIDE key

Switches between the two sides of each program bank. (The indicator is dark when side A is selected, and lit when side B is selected.)

This indicator will blink when the microKORG receives a MIDI program change, or if the **BANK SELECT** dial no longer matches the actual bank.

AUDIO IN 1/2 LEDs

These will light if a signal is being input to the AUDIO IN jacks. They will light red if an input overload occurs.

Display

Indicates the current program number, the value of the selected parameter, or other various messages.

WRITE key

Saves an edited program or global setting. (→p.58)

SHIFT key

By holding down this key and pressing another key, you can access various utility functions. (→p.59) Also, while this key is lit, it will function as an EXIT key to exit the current state and return to normal operation.

PROGRAM NUMBER

1, 2, 3, 4, 5, 6, 7, 8 keys

Select program numbers (the LED of the selected key will light). You can also use these keys to turn each of the eight steps of the arpeggio on/off, adding variety to an arpeggiated performance. (→p.11) In addition, you can hold down the **SHIFT** key and press one of these keys to access various utility functions. (SHIFT function)

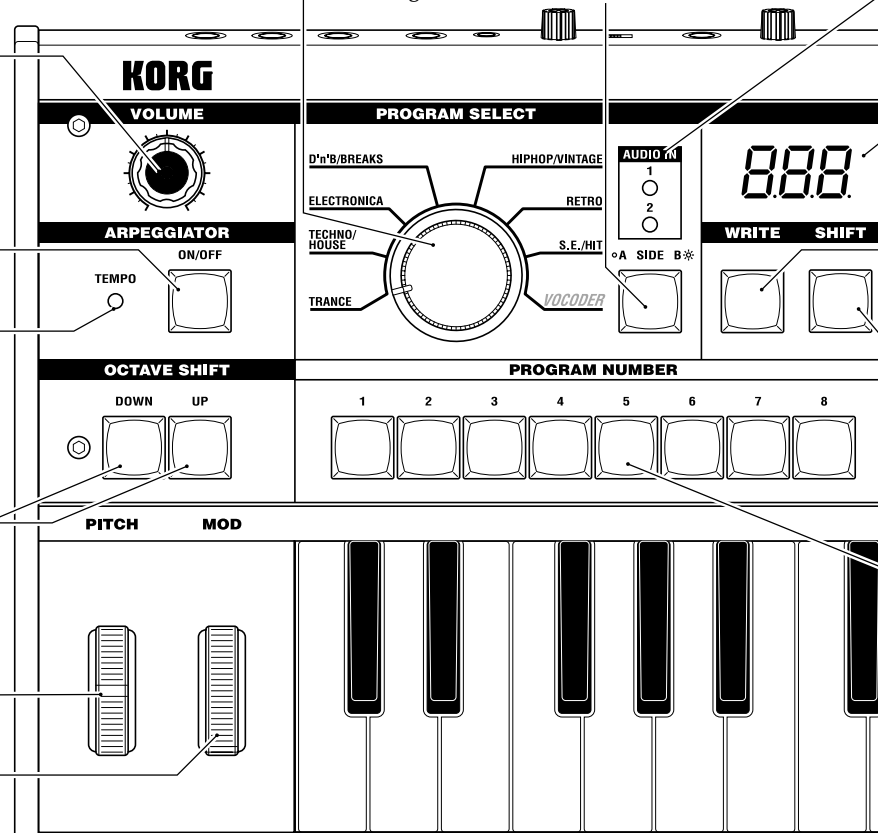

Front and rear panel

TIMBRE SELECT/FORMANT HOLD key

If a Synth program using "layer" is selected, this key allows you to chose which timbre will be edited or sounded, or lets you edit both timbres simultaneously (Sync).

If a Vocoder program is selected, this key switches Formant Hold on, letting you hold the tone currently produced by the vocoder without continuing to speak into the mic.

TIMBRE SELECT 1 LED, TIMBRE SELECT 2 LED

If a Synth program using Layer is selected, the LED(s) will light to indicate which timbre(s) will be edited. If a timbre is being soloed, its LED will blink.

If a Vocoder program is selected, the 1 LED will light if the formants are being held.

EDIT SELECT 1 dial, EDIT SELECT 2 dial

These dials select the section to edit. (→p.12)

SYNTH/VOCODER 1 LED, SYNTH/VOCODER 2 LED

These indicate whether the selected program is a Synth or a Vocoder program. If both the SYNTH/VOCODER 1 and 2 LEDs are lit, the Performance Edit function is enabled.

If only one LED is lit, the EDIT SELECT knob corresponding to the lit LED will be the object of your editing. If the object of editing has not been finalized, the LED will blink.

ORIGINAL VALUE LED

This will light if the value of the parameter currently being edited matches the value that is stored in the program. (→p.13)
(This LED does not function for Performance Edit.)

EDIT CONTROLS 1, 2, 3, 4, 5 knobs

These knobs edit the Performance Edit parameters or the parameters of the section selected by the EDIT SELECT 1 and 2 knobs. (→p.8, 9, 10)

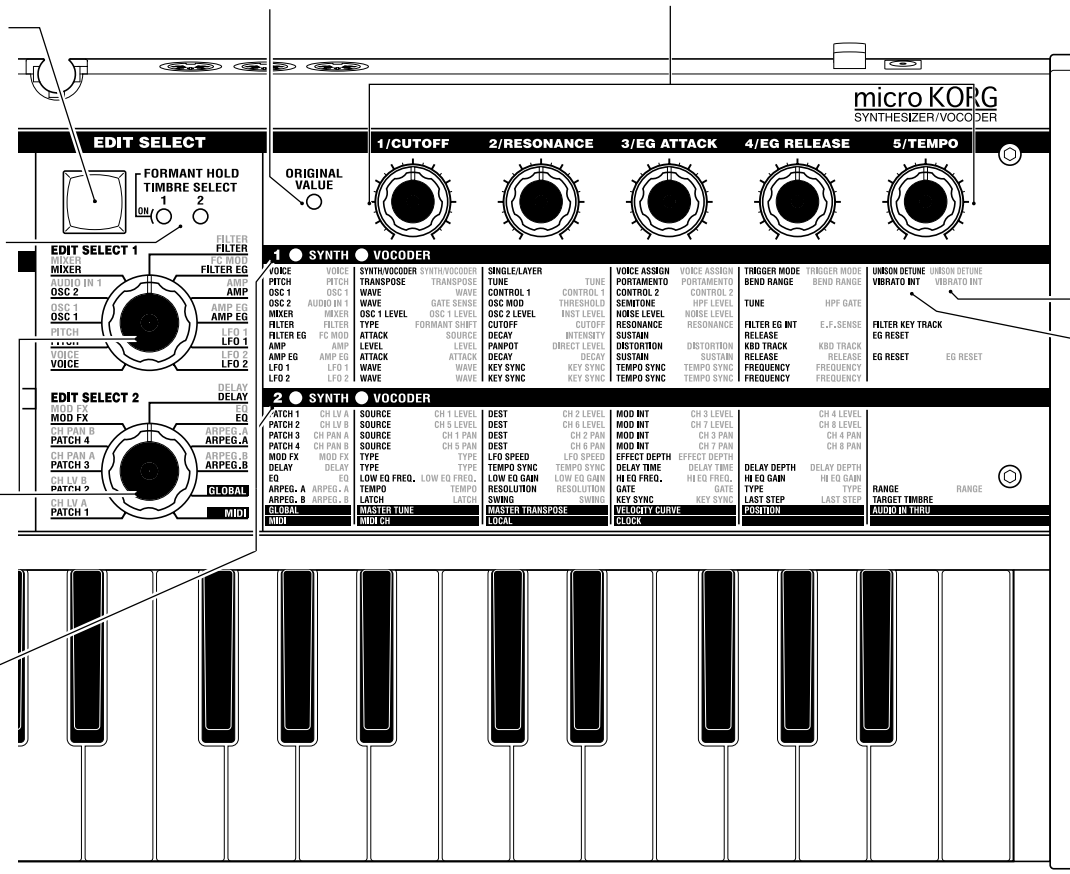

Vocoder parameters
These are the parameters for a Vocoder program.
Synth parameters
These are the parameters for a Synth program.

Front and rear panel

Rear panel

AUDIO IN 2

A Synth program can use an audio signal from an external device connected here as the oscillator 1 waveform.

A Vocoder program uses this input signal as the external carrier for the vocoder.

VOLUME 2 knob

Adjusts the input level from the LINE jack.

LINE jack

Connect a synthesizer or audio device here.

AUDIO IN 1

A Synth program can use an audio signal from a synthesizer or external device connected here as the oscillator 1 waveform.

A Vocoder program can use an audio signal from a mic etc. connected here as the modulator audio.

MIC/LINE switch

If a mic is connected to the DYNAMIC or CONDENSER jack, set this switch to the MIC position. If an external sequencer or audio device is connected, set this switch to the LINE position.

VOLUME 1 knob

Adjusts the input level from the DYNAMIC or CONDENSER jack.

CONDENSER jack

Connect a condenser mic to this jack.

DYNAMIC jack

Connect a dynamic mic, synthesizer, or audio device to this jack.

If both the DYNAMIC jack and the CONDENSER jack are connected, the audio signal from the CONDENSER jack will take priority.

OUTPUT L/MONO, R jacks

Connect these to your powered monitors, stereo amp, mixer, or multi-track recorder.

If you want to use the microKORG in monaural, connect the L/MONO jack.

HEADPHONES jacks

Connect a pair of headphones to this jack (1/4" stereo).

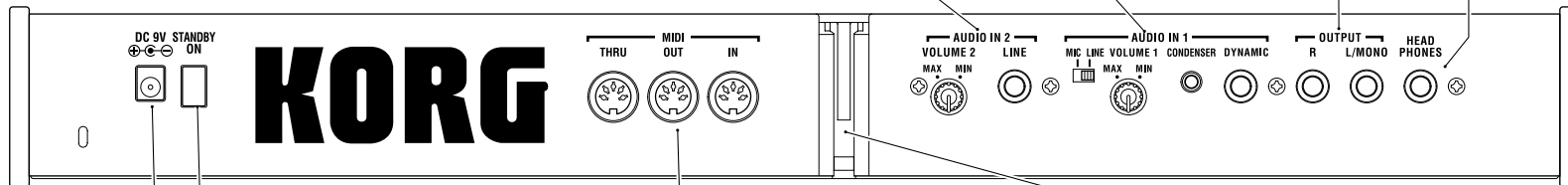

Power switch

Switches the power on/off. (→p.6)

AC adaptor jack

Connect the included AC adaptor to this jack. After connecting the AC adaptor to the microKORG, plug it into an AC outlet.

MIDI

Use these connectors to connect the microKORG to an external MIDI device so that MIDI data can be exchanged.

MIDI THRU connector

Received MIDI data is re-transmitted without change from this connector. Use this when you want to connect multiple MIDI devices to the same "stream" of data.

MIDI OUT connector

This connector transmits MIDI data.

MIDI IN connector

This connector receives MIDI data.

Mic holder

You can attach the included mic to this holder (→p.5).

Preparations

The diagram below shows basic connections for the microKORG. Make substitutions as appropriate for your equipment.

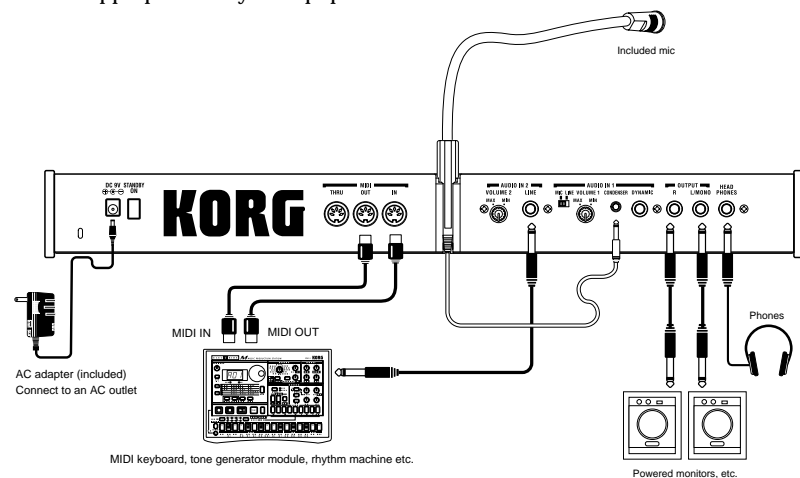

⚠ Be sure to turn off the power of all devices before making connections. Failing to take this precaution may cause your speaker system to be damaged, or may cause malfunctions.

Connections from the audio outputs

Connect the microKORG's OUTPUT L/MONO and R jacks to the input jacks of your mixer or powered monitor system.

In order to take full advantage of the potential of the microKORG, we recommend that you use stereo outputs.

If you are making monaural connections, use the L/MONO jack.

Connections to the audio inputs

If you want to use the microKORG as a vocoder, connect a mic or other audio source to AUDIO IN 1, and use that audio source as the modulator (→p.10). If you

Connections

want to use an external sequencer, rhythm machine, or audio source as the carrier of the vocoder, connect that device to AUDIO IN 2 (→p.34).

If you want to process the waveform of a synthesizer or sampler, connect a mic or the output jack of your external device to the AUDIO IN 1 and 2 jacks (→p.21).

Connections to MIDI equipment/computers

The keyboard, and controllers etc. of the microKORG can be used to control an external MIDI tone generator. Conversely, another MIDI keyboard or sequencer can control the tone generator of the microKORG to produce sound. (→p.48)

Connecting the included mic

A mic for use with the vocoder is included with the microKORG. Here's how to attach the included mic to the microKORG.

⚠ Do not apply excessive force to the neck of the mic, or repeatedly bend it back and forth any more than necessary. Doing so may cause malfunctions such as breakage of the internal wiring.

1 Grasp the base of the included mic, align the protrusion of the mic with the slit of the mic holder, and push it into the holder.

Do not use excessive force.

⚠ When removing the included mic, grasp it by the base and pull it out.

2 Turn the rear panel AUDIO IN VOLUME 1 knob to the MIN position, and set the MIC/LINE switch to the MIC position.

3 Connect the plug of the included mic to the AUDIO IN 1 CONDENSER jack.

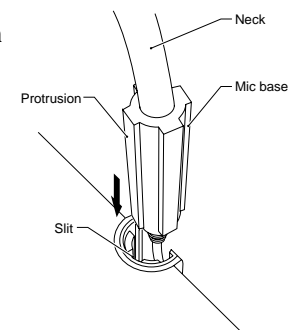

Turning the power on

1. The power supply

Before you connect the power supply, make sure that the power switch is turned off (i.e., in the outward position).

Connecting the AC adaptor

Firmly insert the plug of the included AC adaptor into the jack. Then connect the AC adaptor to an AC outlet.

⚠ Never use any AC adaptor other than the included one.

Inserting/exchanging batteries

The microKORG can also be operated on batteries.

⚠ Batteries are not included. You will need to purchase them separately.

- 1 Make sure that the power switch on the microKORG is turned off. Then open the battery cover located on the bottom of the case.
- 2 Insert six AA alkaline batteries.
- ⚠ Be careful to observe the correct polarity of the batteries.
- 3 Close the battery cover.

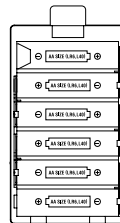

Low battery display "bAt"

When the batteries run low, the display will indicate "bAt," and the "." at the far right will begin blinking. If you continue using the microKORG, the Protect setting will be turned on automatically, and you will be unable to edit program or global settings. We recommend that you install new batteries or switch to the AC adaptor as soon as possible. If this state occurs while you are editing, and you want to save your settings, connect the AC adaptor and execute the Write operation.

You can cancel the "bAt" display by pressing the **SHIFT** key.

⚠ Batteries that have become unusable should be removed from the microKORG as soon as possible. Leaving such batteries installed may cause malfunctions (due to battery leakage, etc.). You should also remove the batteries if you will not be using the microKORG for an extended period of time.

2. Turning the power on

⚠ Before you turn on the microKORG's power, you should lower the level of your monitor system or other connected output device.

- 1 Turn the microKORG's **VOLUME** knob all the way toward the left.
- 2 Press the power switch to turn on the power. The display will indicate the program number.
- 3 Turn the microKORG's **VOLUME** knob toward the right to an appropriate position.
- 4 Adjust the volume of your external output device.

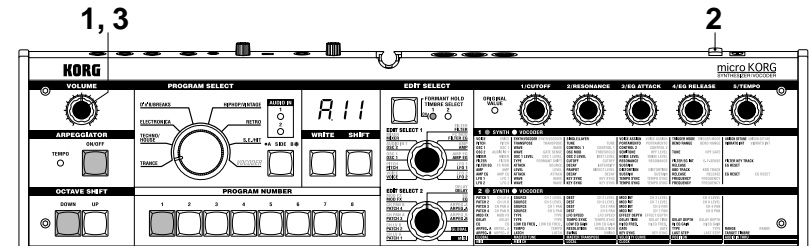

3. Turning the power off

After saving any necessary data (such as a program you have edited) turn the power off using the reverse order of the power-on procedure.

⚠ Never turn the power off while data is being saved (i.e., while Write is executing). Doing so may damage the internal data.

Quick Start

Demo songs

Listening to the demo songs

The microKORG contains several demo songs.

Here's how to listen to the demo songs and hear the sounds of the microKORG.

- 1 Hold down the **SHIFT** key and press the **ARPEGGIATOR ON/OFF** key.
The demo will begin playing. The **SHIFT**, **OCTAVE SHIFT DOWN UP**, and **PROGRAM NUMBER** key LEDs will light.
- 2 To switch the demo song during playback, press the **OCTAVE SHIFT UP** or **DOWN** key.
You can also use the **PROGRAM NUMBER 1 -8** keys to select a demo song.
- 3 When you press the **SHIFT** key, demo playback will stop.
The **SHIFT**, **OCTAVE SHIFT DOWN** and **UP** key will go dark, and the microKORG will return to normal playing mode.

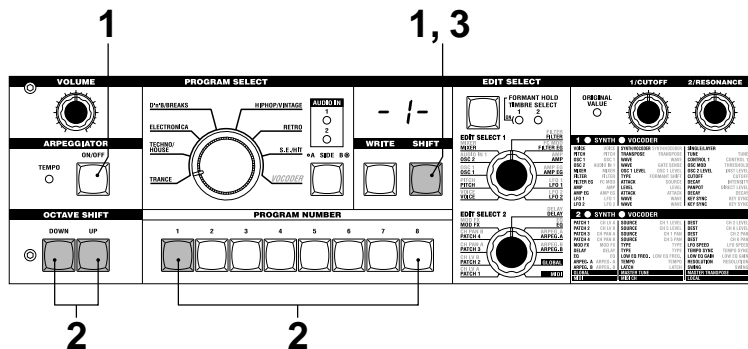

Synth programs

1. Selecting and playing a program

The microKORG contains 128 programs that you can select and play immediately. Programs are arranged in Banks. Each bank contains two "Sides", and each side contains eight programs. To select different programs, use the front panel PROGRAM SELECT knob and PROGRAM NUMBER keys. As an example, here's how to select program "b.26".

- 1 Press the BANK SIDE key to select "b" as the program side.
The BANK SIDE key will light when side B is selected, and will be dark when side A is selected.
- 2 Turn the PROGRAM SELECT knob to the TECHNO/HOUSE position.
The display will indicate "2" as the program bank.
- 3 Press the 6 key to select the program number.
Notice that the SYNTH/VOCODER LED for the SYNTH position is lit.

note The program will change at the moment you switch either the Side, Bank, or Number.

- 4 Play the keyboard to hear the sound.
- 5 You can use the OCTAVE SHIFT UP or DOWN keys to shift the pitch range of the keyboard. (→p.9)

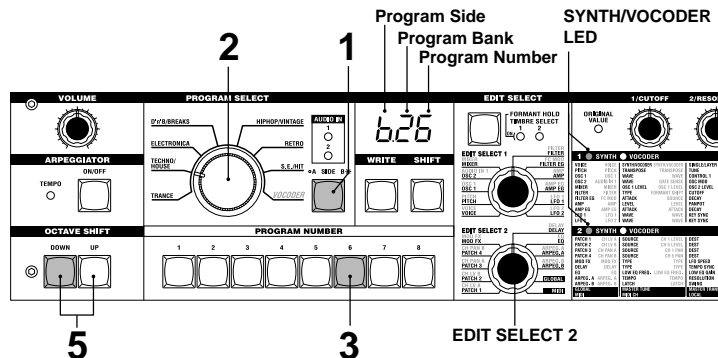

2. Modifying the sound

On the microKORG, you can modify the sound to add expression to your performance by turning the edit control knobs 1 - 5, by moving the **PITCH** or **MOD** wheels, or by the way that you play the keyboard.
Try out various ways to modify the selected program.

Using the Performance Edit function to modify the sound

When both the upper and lower SYNTH/VOCODER LEDs are lit, the Performance Edit function is active. In this state, the edit control knobs 1 - 5 are automatically assigned to control the parameters listed below. Turn these knobs to control the sound in realtime.

note When using Performance Edit, the display shows the program number.

note Performance Edit will be cancelled if you turn the EDIT SELECT 1 or EDIT SELECT 2 knob to select a different section, or if you hold down the **SHIFT** key and press the **BANK SIDE** key. To enable the Performance Edit function, press the **PROGRAM NUMBER** key that is lit.

When Performance Edit is active, you can edit the sound in the following ways.

Knob 1: CUTOFF

Adjusts the cutoff frequency of the filter. This will affect the brightness of the sound. Normally, turning the knob toward the left will darken the sound, and turning it toward the right will brighten the sound.

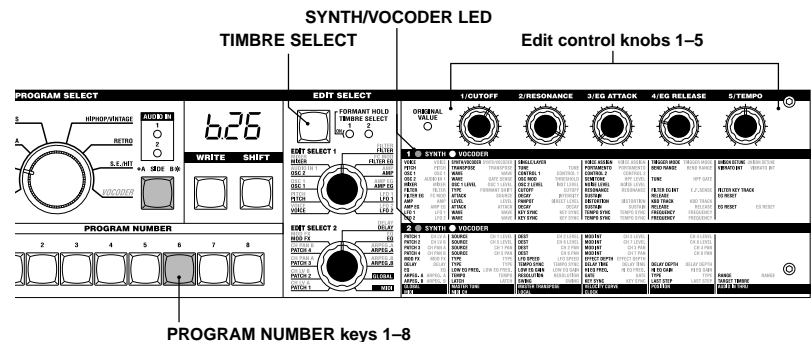

Synth programs

Knob 2: RESONANCE

Adjusts the resonance of the filter. This adds a distinctive character to the sound.

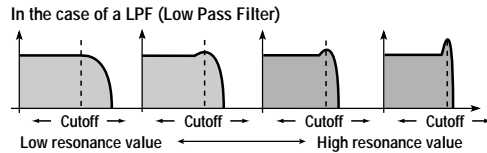

Knob 3: EG ATTACK

(FILTER EG + AMP EG ATTACK)

Adjusts the attack time of the filter EG and amp EG. This will affect the amount of time from note-on (when you press a key) until the attack level is reached. Turning this knob will adjust the speed at which the filter EG and amp EG will rise.

Normally, turning the knob toward the left will shorten the attack time, and turning it toward the right will lengthen the attack time.

Knob 4: EG RELEASE (FILTER EG + AMP EG RELEASE)

Adjusts the release time of the filter EG and amp EG. This will affect the amount of time from note-off (when you release a key) until the sound disappears.

Turning this knob will adjust the release time of the filter EG and amp EG. Normally, turning the knob toward the left will shorten the release time, and turning it toward the right will lengthen the release time.

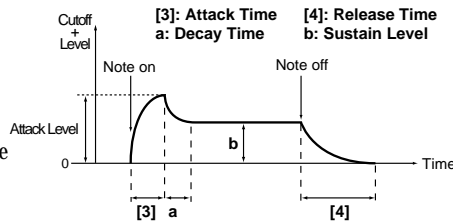

Knob 5: TEMPO

Adjusts the tempo of the arpeggiator, LFO, and DELAY (if "TEMPO SYNC" is ON). Turning the knob toward the left will slow down the tempo, and turning it toward the right will speed up the tempo. The ARPEGGIATOR TEMPO LED will blink at the specified tempo.

note If you have selected a Layer program that uses two timbres (one of the TIMBRE SELECT LEDs is lit), you can choose which timbre will be affected by your edits. Press the **TIMBRE SELECT** key to switch timbres. (→p.14)

note In the EDIT mode, the parameters that are assigned to each knob are also be edited via the parameters of the section selected by the EDIT SELECT 1 and EDIT SELECT 2 knobs. For details on each function, refer to p.24 for CUTOFF and RESONANCE, p.26 and 28 for EG ATTACK and EG RELEASE, or p.44 for TEMPO.

note A sound modified modify using Performance Edit can be written into memory if desired. (→p.58)

Using the PITCH and MOD wheels for control

PITCH wheel:

The effect will be applied when you move the wheel away from or toward yourself. When the wheel is in the center position, there will be no effect.

Normally this wheel is used as the pitch bender, so that the pitch will rise when you move the wheel away, and fall when you move the wheel toward yourself.

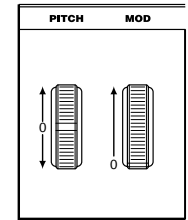

MOD wheel:

The effect will be applied when you move the wheel away from yourself, and will not apply when you move the wheel toward yourself.

You can use this wheel to control the vibrato depth (→p.17), or to adjust the tone by controlling the cutoff frequency (→p.30).

note Since the **PITCH** and **MOD** wheels can be used as virtual patch sources, you can use them to produce a variety of effects other than described above. (→p.30)

Using the OCTAVE SHIFT UP and DOWN keys for control

You can use these keys to shift the pitches assigned to the keyboard, in one-octave units over a range of +/-3 octaves. (→p.8, 52)

Key operation	Keyboard range	Key LED	Key operation
Press DOWN key	C6-C9	UP lit red	Press UP key
	C5-C8	UP lit orange	
DOWN	C4-C7	UP lit green	UP
	C3-C6	dark	
	C2-C5	DOWN lit green	
	C1-C4	DOWN lit orange	
	C0-C3	DOWN lit red	

Using the keyboard for control

Keyboard Tracking:

Keyboard tracking uses the position of the note on the keyboard to affect the sound. Normally, this is used to brighten the sound as you play upward, or to create differences in volume between high and low notes.

Velocity:

The strength with which you play the keyboard can affect the sound. Normally, your playing strength will affect the tone and volume.

note Since velocity and keyboard tracking can be used as a virtual patch source, you can use them to produce a variety of effects other than those described above. (→p.30)

Vocoder programs

1. Playing a vocoder program

Here's how to connect the included mic and play a vocoder program.

A vocoder applies the spectral character of an externally-input voice (the "modulator") to an oscillator or other sound (the "carrier"), and outputs the result. In the most popular use of a vocoder, you can speak or sing into a mic and play chords on the keyboard, to create the impression that an instrument is speaking or singing. Alternatively, you can create a variety of interesting effects by inputting audio signals other than a human voice (such as rhythm sounds).

- 1 On the rear panel, turn the AUDIO IN 1 VOLUME 1 knob to the MIN position, and set the MIC/LINE switch to the MIC position.

- 2 Connect the included mic to the AUDIO IN 1 CONDENSER jack.

note If you use a mic other than the included one, connect it to the appropriate jack.

- 3 Select a vocoder program. Using the procedure described on page 8, select program "A.84" for this example.

With the factory settings, the VOCODER bank contains vocoder programs. Notice that the SYNTH/VOCODER LED VOCODER is lit.

- 4 Vocalize into the mic, and turn the VOLUME 1 knob toward MAX without allowing the AUDIO IN 1 LED to light red.

note Raising the AMP "DIRECT LEVEL" value will cause the input sound to be output directly, so raise the level if you want to hear the input sound while you make adjustments. (→p.37)

- 5 While vocalizing into the mic, play the keyboard. Try pronouncing different words and changing the chords you play, and listen to the vocoder effect.

note If you cannot hear the effect, try adjusting the AMP "LEVEL" (knob 1) (→p.37) or MIXER "OSC 1 LEVEL" (knob 1) (→p.34).

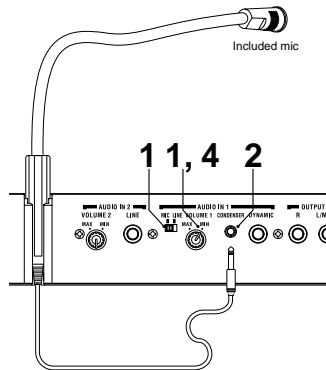

- 6 While vocalizing into the mic and using the keyboard to play vocoder sounds, you can "freeze" the current tone of the vocoder by pressing the FORMANT HOLD key. This allows you to continue to play the current vocoder sound, even when you are not vocalizing. This tone will be remembered when you Write the vocoder program to memory.

note Several of the VOCODER bank programs will sound even if you simply play the keyboard. These programs were written with FORMANT HOLD turned on.

2. Modifying the sound

In the same way as for a synth program, you can modify the sound of a vocoder program by turning the edit control knobs 1 -5, by moving the PITCH and MOD wheels, and by the way that you play the keyboard. As described on the preceding pages, try out various changes for the selected program.

The following Performance Edit operations work differently than for a synth program.

Knob 1: CUTOFF, Knob 2: RESONANCE:

These control the carrier by adjusting the band pass filter cutoff frequency of the carrier. See page 35.

Knob 3: EG ATTACK, Knob 4: EG RELEASE:

Only the amp EG can be controlled.

Also, a vocoder program does not allow you to switch timbres.

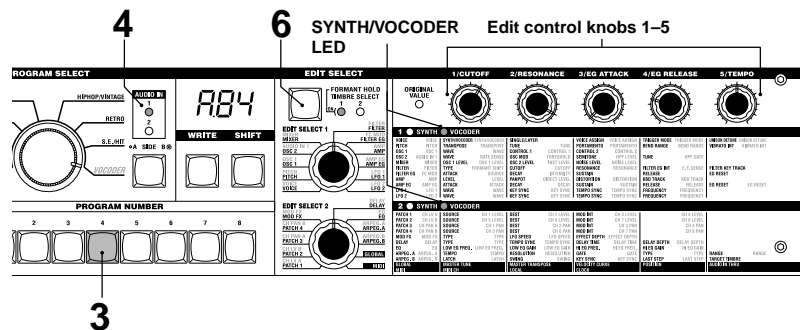

Arpeggiator

Using the arpeggiator

The arpeggiator is a function that automatically arpeggiates the notes of a chord you play; i.e., sounds the notes one after the other. The microKORG's arpeggiator provides six types of arpeggio pattern, and lets you adjust the duration (gate time) of the notes that are sounded. The microKORG also provides a "step arpeggiator" that lets you specify the on/off status of each note in the chord for as many as eight steps, letting you create an even wider range of arpeggio patterns.



When you play the chord shown above on the keyboard, the notes will be sounded as shown at the right. (TYPE: UP)

- 1 Select a program. (→p.8)
You can use the arpeggiator with either a synth program or a vocoder program, but let's select synth program b.58 for this explanation.
- 2 Press the ARPEGGIATOR ON/OFF key to make the key LED light.
- 3 Hold down a chord on the keyboard, and the arpeggiator will run.

Modifying the arpeggio

- 4 Turn the EDIT SELECT 2 knob to the ARPEG.A or ARPEG.B position.
- 5 Turn the edit control 1-5 knobs to adjust the arpeggiator parameters, changing the way that the arpeggiator is sounded.

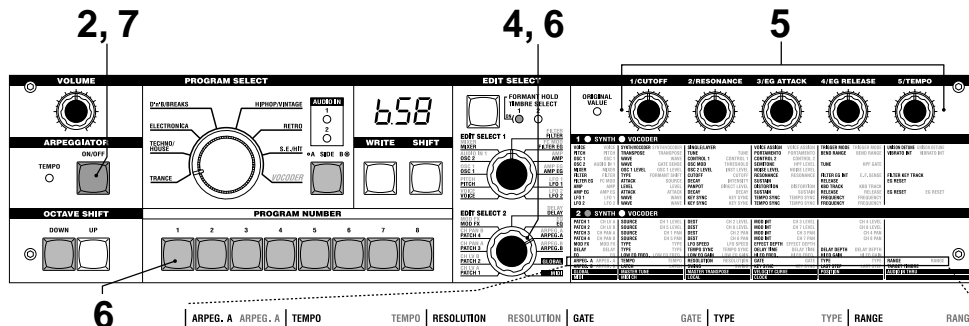

For example if you selected **ARPEG.A** in step 4, the parameters shown in the lower left diagram (below) will be selected as the knob functions. Turning knob **1** will change the tempo of the arpeggio, and turning knob **3** will change the duration of the arpeggiated notes. Turning knob **4** will switch the arpeggio pattern, changing the order in which the notes are sounded (→p.44). (For details on each parameter, refer to the appropriate page.)

note Refer to page 13 for a note regarding cases in which the value does not change.

Using the step arpeggiator to vary the arpeggio

- 6 If the EDIT SELECT 2 knob is turned to the **ARPEG.A** or **ARPEG.B** position, the PROGRAM NUMBER 1-5 keys will act as arpeggiator step keys, and will be lit (the "on" state) for the number of valid steps.

When you press a step key to make the key LED blink (the "off" state), the note of the corresponding step will change to a rest, and the resulting arpeggio will change (see the diagram below). The Step Arpeggiator function lets you switch each step of the arpeggio on/off in this way to modify the arpeggio that is sounded.

note To change the number of valid steps in the arpeggio, set the EDIT SELECT 2 knob to **ARPEG.B** and turn knob 4. (→p.45)

- 7 When you press the ARPEGGIATOR ON/OFF key (the key LED goes dark), the arpeggio will stop playing.

TYPE: UP
LAST STEP: 8

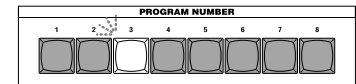
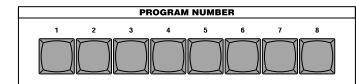

Editing

Basic editing procedure

All of the editable parameters are organized into "sections". Each section contains up to five parameters, which are controlled using the edit control knobs 1 - 5. The two knobs labelled **EDIT SELECT 1** and **EDIT SELECT 2** are used to select a section. Notice the six columns of text under the five knobs. The first column identifies the name of each section, and the following five columns show the parameter assigned to each of the knobs above. The text to the left side indicates the parameters used for a synth program. The text to the right side (in green) indicates the parameters available for a vocoder program.

On the microKORG there are two basic ways for you to create a sound.

- Select the program that is closest to the sound you want to create, and edit that program as necessary to change it as desired
- Start from an initialized program ("blank slate"), and create the sound from scratch

Broadly speaking, the procedure is as follows.

- 1 Select the program that you want to start from. (→p.8)
If you want to start from scratch, execute the Initialize operation. (→p.59)
- 2 Turn the EDIT SELECT 1 or EDIT SELECT 2 knob to select the section that includes the parameter you want to edit. (The SYNTH/VOCODER LED for the side you are editing will light.)

Consider how the current program differs from the sound you have in mind, and select the parameter that you want to edit.

If you are creating the sound from scratch, note that the EDIT SELECT 1 and EDIT SELECT 2 knobs access parameter sections in a logical order for creating the sound. You can turn the dials in sequence to step through these parameter sections in the appropriate order.

note By holding down the **SHIFT** key and pressing the **BANK SIDE** key, you can switch between EDIT SELECT 1 and EDIT SELECT 2 as the section to edit.

Basic editing

- 3 Turn edit control knob 1, 2, 3, 4, or 5 to edit the assigned parameters.
For example if you are editing a synth program and set the EDIT SELECT 1 knob to **FILTER**, the parameters shown below the diagram at the bottom of this page will be selected as the function of the five edit control knobs. (The left parameter of each pair is the synth program parameter, and the right parameter - in green - is the vocoder program parameter.)

Turning knob 2 will change the cutoff frequency value, affecting the tone. Turning knob 3 will change the resonance value, adding a distinctive character to the tone. (→p.24)

Go ahead and try editing the **AMP EG** parameters "ATTACK" and "DECAY" (→p.28), the **PITCH** parameter "PORTAMENTO" (→p.17), or the **MOD FX** (→p.40) or **DELAY** (→p.41) parameters to hear the result. (For details on each parameter, refer to the appropriate page.)

- 4 If you want to make precise adjustments to a value, hold down the **SHIFT** key and press the **OCTAVE SHIFT UP** or **DOWN** key (**UP**, **DOWN**, and **SHIFT** keys will light). Now you can use the **UP** and **DOWN** octave keys to step through the values for the selected parameter.

To cancel this function, press the lit **SHIFT** key.

note If you press the **UP** and **DOWN** keys simultaneously, that parameter will return to the value it had when you selected it.

- 5 Repeat steps 2-4 as necessary to create the desired sound.
- 6 Write the program into memory. (→p.58)

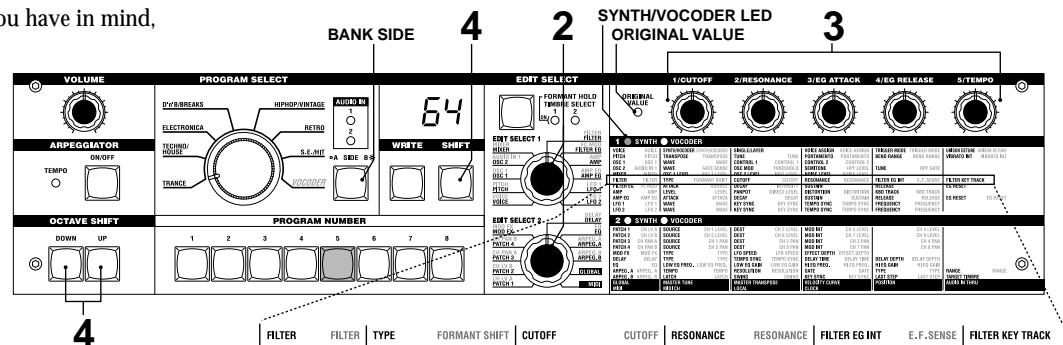

Basic editing

⚠ If you select another program or turn the power off before you write, your edits will be lost.

note If the parameter value does not change when you turn knobs 1–5
When you use EDIT SELECT 1 or EDIT SELECT 2 to select a section and turn knobs 1–5 to edit the parameter values, the value in the display will sometimes continue blinking, and the parameter value will not change. This occurs when there is a discrepancy between the actual value of the parameter being edited (the value that is blinking in the display) and the position of the knob. If the actual value is significantly different from the position of the knob, and the value changed immediately when you moved the knob, the sound would change in a sudden and unnatural way. To prevent this from happening, the knob and parameter will begin changing in tandem only when the knob position corresponds to the actual value of the edited parameter (the value in the display will stop blinking).

For example, suppose that you turn knob 1 to edit a parameter, so that the knob is in the position shown at left.

Then you use the EDIT SELECT 1 knob to switch to a different parameter section, and want to edit the parameter assigned to knob 1. The actual value of this parameter is at the position of the triangle in the diagram at left. (The actual value will blink when you turn the knob slightly.) The parameter value will not change until you turn the knob all the way to that position.

When the knob reaches the position of the actual value, the knob and parameter value will begin changing in tandem, so that you can edit the value. (When the knob reaches the actual value, the value in the display will stop blinking.)

note To return to the original parameter values of a program
The edit control **ORIGINAL VALUE LED** will light to indicate the parameter values of a preset program or a program that you saved. If you want to return parameters to their original values, turn knobs 1–5 so that the **ORIGINAL VALUE LED** is lit. If you select another program or re-select the same program while you are editing, all parameters will return to the values of the preset program or the previously-saved program.

note In the same way as when editing a program, you can make settings for the entire microKORG or MIDI-related settings by selecting the desired parameter section and turning knobs 1–5 to make the settings (→p.47, 51). Changes you make to these settings will also be lost if you turn the power off, so you must Write them if you want to keep your changes.

note How to read the pages for each section (→p.16–)

This indicates the position of the EDIT SELECT 1/2 knob. The EDIT SELECT 1/2 knob selects the section that will be edited. In this example, the **FILTER** section is selected. These are the edit control knobs 1–5. The markings printed around each knob are the values that will be selected when you turn that knob. These positions are approximate.

This area lists the parameters that are edited by edit control knobs 1–5 when the above section is selected. The range of values for each parameter is given in square brackets []. Explanations of each parameter and its values are given below.

This is the name of the section. When you have set the EDIT SELECT 1 or 2 knob to the **FILTER** position and would like to see an explanation of the parameters, refer to this page.

This section applies to synth programs.

A summary of this section is given here.

TYPE	1	2	3	4	5
CUTOFF	[40.00]	[120.00]	[120.00]	[120.00]	[120.00]
RESONANCE	[0.00]	[0.00]	[0.00]	[0.00]	[0.00]
FILTER EG RT	[0.00]	[0.00]	[0.00]	[0.00]	[0.00]
FILTER KEY TRACK	[0.00]	[0.00]	[0.00]	[0.00]	[0.00]

Basic editing

Editing each timbre

Synth programs can have up to two timbres.

A timbre consists of the parameters of EDIT SELECT 1 VOICE (except for "SYNTH/VOCODER" and "SINGLE/LAYER") through LFO2 sections, and the parameters of EDIT SELECT 2 PATCH 1-4 sections.

note The VOICE section parameters "SYNTH/VOCODER" and "SINGLE/LAYER" apply to the entire program.

Using both timbres (Layer)

- Set the EDIT SELECT 1 knob to VOICE, and turn knob 2 to select LAYER (L RY).

Selecting the timbre to edit

If you are editing a program that uses both timbres, here's how to select the timbre to edit.

- Press the EDIT SELECT TIMBRE SELECT key to select the timbre that you want to edit. (The corresponding TIMBRE SELECT LED will light.)
Your editing will affect the selected timbre.

You can also edit both timbres simultaneously (Edit Sync).

- 1 Press and hold the TIMBRE SELECT key for at least two seconds.
Both TIMBRE SELECT LEDs will light, and editing will be synchronized for the two timbres. The display will indicate the value for timbre 1. The value of timbre 1 will also be used as the value at which editing begins.
- 2 To cancel edit sync, press the TIMBRE SELECT key.
Edit sync will be cancelled, and timbre 1 will be the object of editing.

note You can use the Solo function even while editing is synchronized.

! The state of the edit sync function is not saved.

Listening to only one timbre (Solo)

For a program that uses both timbres, you can use the Solo function to hear just one timbre. This is convenient when you want to hear just one timbre while you edit.

- 1 Hold down the SHIFT key and press the TIMBRE SELECT key.
The TIMBRE SELECT LED for the timbre selected for editing will start blinking, and only that timbre will sound.
- 2 If you want to hear only the other timbre, once again hold down the SHIFT key and press the TIMBRE SELECT key.
The TIMBRE SELECT LED for the other timbre will start blinking, and only that timbre will sound. The timbre selected for editing will also change at this time.
- 3 To cancel the Solo function, press the TIMBRE SELECT key.
! The Solo state cannot be memorized.

Exchanging and copying the settings of the timbres (SHIFT function)

You can exchange the settings of the two timbres, or copy the timbre settings from another program. (→p.59)

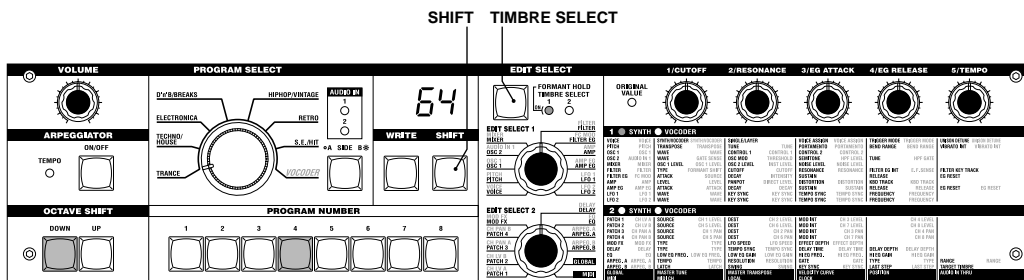

Editing a synth program

Overview

The three attributes of sound: pitch, tone, and volume

Sound has three basic attributes: pitch, tone, and volume.

To control these attributes, the microKORG analog modeling synthesizer provides "oscillator," "filter," and "amp (amplifier)" sections, just as on the analog synthesizers of the past.

The "oscillator" settings vary the pitch, the "filter" settings modify the tone, and the "amp" settings modify the volume.

The microKORG's "oscillator," "filter," and "amp"

On the microKORG, the OSC1, OSC2, and PITCH sections control the "oscillator". The PITCH section specifies the pitch of the waveform that is the basis of the sound, and the OSC1 and OSC2 sections select the waveforms. The waveforms generated here are mixed by the MIXER section.

The microKORG's FILTER section modifies the tone. Then the AMP section modifies the volume and outputs the final sound.

These three sections determine the basic sound of the program.

EG, LFO, keyboard tracking, virtual patch, controllers

In addition to the sections described above, the microKORG provides ways in which the sound can be varied according to time, key range, or various types of performance expression. These are controlled by modulators and controllers such as EG (envelope generator), LFO (Low Frequency Oscillator), keyboard tracking, Virtual Patch, and the **PITCH** and **MOD** wheels. You can use these modulators and controllers to apply change to the basic sound of the program.

Figure 0-1 (at right) shows the structure of a synthesizer sound on the microKORG. Look at TIMBRE 1, and notice how the signal flows in the order of OSC → FILTER → AMP. Also notice how modulators such as EG and LFO can affect these blocks.

The structure of a synth program

As shown in figure 0-1, a synth program consists of timbres 1/2, effects, and the arpeggiator.

TIMBRE 1/2

Each timbre consists of OSC, FILTER, AMP, EG, LFO, and Virtual Patch blocks. You can create more complex programs by using two timbres together in one program using the Layer feature.

EFFECTS

The output of timbres 1/2 is sent to the modulation effect (MOD FX) → delay effect (DELAY) → equalizer (EQ).

For the modulation effect you can choose from three types of effect such as chorus. For the delay, you can choose from three types of delay such as stereo delay. The EQ is a two-band equalizer.

ARPEGGIATOR

You can apply the arpeggiator to a timbre. If the program uses two timbres, you can apply the arpeggiator to either or both timbres. This is a step arpeggiator with six arpeggio types.

Figure 0-1
SYNTHESIZER BLOCK DIAGRAM

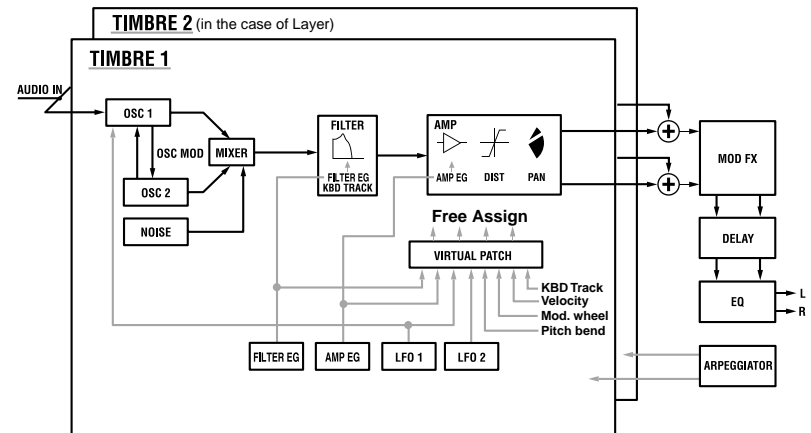

1. VOICE — SYNTH/VOCODER

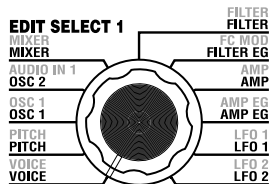

These settings determine the basic character of the program, and how it will sound.

"SYNTH/VOCODER" (knob 1) specifies whether the program will be a synth program or a vocoder program. If you want this to be a synth program, select Synthesizer (SYL). "SINGLE/LAYER" (knob 2) specifies whether both timbres will be used (Layer) in the case of a synth program. Other parameters in this section specify whether the program will sound monophonically/polyphonically/unison, and how the notes will be triggered.

note If you simultaneously press more keys than the specified number of voices, the last-pressed key will take priority.

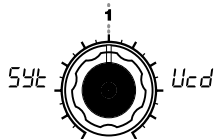

SYNTH/VOCODER

[Synthesizer, Vocoder]

Switches the currently selected program between a Synthesizer program and a Vocoder program.

Synthesizer (SYL):

The program will be a synth program. You can use two oscillators to create the sound.

Vocoder (VCD):

The program will be a vocoder program. You can use sound input from a connected mic to produce "talking" instrument effects.

note The parameters for editing will vary depending on whether Synthesizer or Vocoder is selected here.

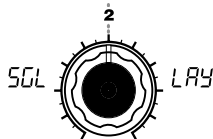

SINGLE/LAYER [Single, Layer]

Specifies how many timbres the program will use. This cannot be selected for a vocoder program.

Single (SGL):

Only one timbre will be used.

Figure 1-1

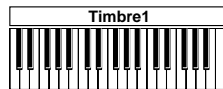

Layer (LAY):

Two timbres will be used. When you play the keyboard, both timbres will sound simultaneously. You can edit each timbre individually.

Figure 1-2

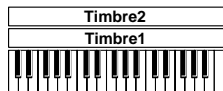

note The maximum polyphony is four voices (four notes). In the case of a Layer program, these four voices are divided between timbres 1 and 2, so only two keys can be played in a layered program.

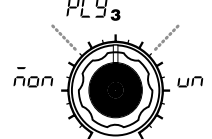

VOICE ASSIGN

[Mono, Poly, Unison]

Specifies how the timbre will be sounded.

Mono (MON):

The timbre will sound monophonically. The program will play only one note at a time.

Poly (POLY):

The program will sound polyphonically, allowing you to play chords. The maximum polyphony is four voices.

Unison (UNI):

All four voices will sound in unison at the same pitch. Use "UNISON DETUNE" to specify the pitch difference in steps of one cent.

note "VOICE ASSIGN" and polyphony for a Layer program

	Timbre 1	Timbre 2
VOICE ASSIGN	Mono	Poly
Polyphony	1 voice	3 voices
VOICE ASSIGN	Poly	Poly
Polyphony	2 voices	2 voices
VOICE ASSIGN	Unison	Mono
Polyphony	2 voices	1 voices

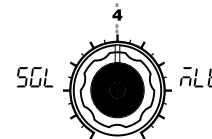

TRIGGER MODE [Single, Multi]

Specifies whether the EG and LFO will be retriggered when you play the next key while still holding down the previous key.

You can edit this if "VOICE ASSIGN" is Mono or Unison.

Single (SGL):

The EG and LFO will not be retriggered by the second or subsequent key. Use this setting if you want to play legato.

Multi (MULTI):

The EG and LFO will be retriggered each time you press a key.

Figure 1-3

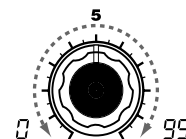
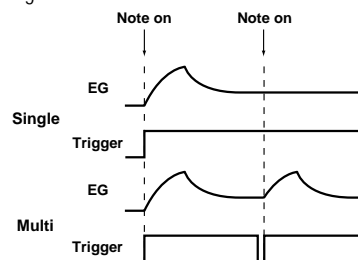

UNISON DETUNE [0..99]

Specifies the amount of detuning (in steps of one cent) between the notes sounded by Unison mode. You can edit this if "VOICE ASSIGN" is set to Unison. The detuning method will depend on the number of unison voices.

Figure 1-4

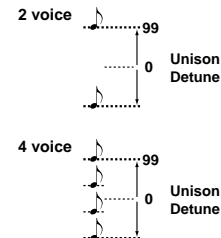

2. PITCH — SYNTH/VOCODER

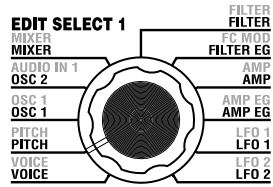

These settings specify the pitch of the oscillator.

Use "TRANSCOPE" (knob 1) and "TUNE" (knob 2) to set the desired pitch. These settings are shared by oscillators 1 and 2. In this section you can also set the portamento time, and specify how the **PITCH** and **MOD** wheels will affect the pitch.

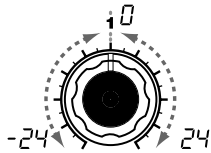

TRANSCOPE [-24...24]
Adjusts the pitch of the oscillator in semitone (100 cent) steps. The range is two octaves upward or downward.

note Changes made by the front panel **OCTAVE SHIFT** buttons actually shift the pitches assigned to the keyboard (or keys) in one-octave steps, and do not affect the pitch of the oscillator that is sounding. Nor are such settings saved by the Write operation. If you wish to change the pitch of the oscillator itself, you must use this "TRANSCOPE" setting to specify the pitch.

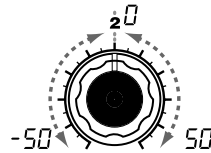

TUNE [-50...50]
Adjusts the pitch of the oscillator in one-cent steps.

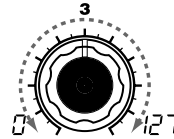

PORTAMENTO [0...127]
Specifies the speed of the portamento effect (a smooth change in pitch from one note to the next note of a different pitch). With a setting of 0, there will be no portamento effect. Increasing this value will cause the pitch change to occur over a longer time.

▲ If "VOICE ASSIGN" is set to Mono or Unison, and if "Trigger" is set to Single, portamento will not apply to the first-sounded note.

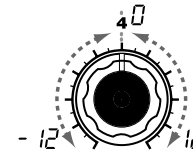

BEND RANGE [-12...12]
Specifies the amount of pitch change in semitones that will occur when the pitch wheel is operated. This value specifies the amount of change that will occur when you move the pitch wheel all the way to the away from you.

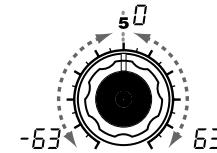

VIBRATO INT [-63...63]
Specifies the depth of vibrato that will be applied when you move the **MOD** (modulation) wheel all the way away from yourself.

note The LFO2 modulates the pitch of the oscillator, raising and lowering it to create vibrato.

SYNTH
VOICE
PITCH

3. OSC1 (Oscillator 1) — SYNTH/VOCODER

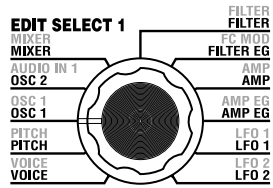

The oscillator generates the waveform that is the basis of the sound.

The timbre has two oscillators. The settings in this section are for oscillator 1. "WAVE" (knob 1) selects the basic waveform for oscillator 1, and "CONTROL 1" (knob 2) and "CONTROL 2" (knob 3) modify the waveform. For example if you set "WAVE" to Saw (S \bar{A} U), adjusting the "CONTROL 1" value will modify the sound, changing the waveform as shown in figure 3-1. Adjusting "CONTROL 2" will apply LFO1 modulation to the waveform specified by "CONTROL 1," producing additional change.

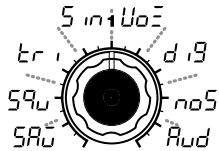

WAVE

[Saw, Square, Triangle, Sine, Vox, DWGS, Noise, Audio In]
Selects the waveform for oscillator 1.

Saw Wave (S \bar{A} U):

This is a sawtooth wave. This waveform is shaped like the tooth of a saw, and contains a rich overtone spectrum.

You can use this to create numerous instrumental sounds such as string and brass sounds, or typical analog synth sounds such as synth bass or synth brass.

Square Wave (S \bar{Q} U):

This is a square wave. It has a rectangular shape, and strictly speaking is actually square only when the top and bottom of the waveform have the same width (a "pulse width" of 50%). If the pulse width is other than 50%, this is also called a pulse wave.

A square wave is used for woodwind sounds such as clarinet, and for wooden percussion sounds. A pulse wave is used for plucked-string sounds and reed-type sounds.

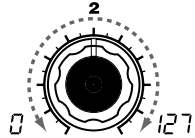

CONTROL 1 [0...127/---]
Adjusts a parameter specific to the selected waveform. CONTROL 1 has no effect if "WAVE" is set to DWGS.

CONTROL 1 [0...127]:
Adjusting this value will modify the waveform. A setting of 0 will produce a conventional sawtooth wave, and a setting of 127 will produce a sawtooth wave one octave higher. (→Figure 3-1)

CONTROL 1 [0...127]:
Adjusts the pulse width. A setting of 0 produces a pulse width of 50% (square wave), and a setting of 127 produces a pulse width of 0% (there will be no sound). The sound will become "harder" as you adjust this parameter toward 0%. (→Figure 3-2)

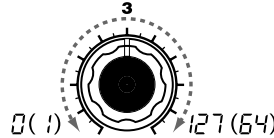

CONTROL 2 [0...127/1...64]
Adjusts a parameter specific to the selected waveform.

CONTROL 2 [0...127]:
LFO1 is used to apply modulation to the waveform specified by "CONTROL 1." The "CONTROL 2" setting specifies the depth of the modulation produced by LFO1. For example by setting LFO1 "WAVE" to Triangle (T \bar{R}) and adjusting the LFO speed, you can produce a detune-like effect.

CONTROL 2 [0...127]:
LFO1 is used to apply PWM (pulse width modulation)^{*3-1} to the pulse width specified by "CONTROL 1." The "CONTROL 2" setting specifies the depth of the modulation produced by LFO1. For example by setting LFO1 "WAVE" to Triangle (T \bar{R}) and adjusting the LFO speed, you can add depth to the sound.



Figure 3-1

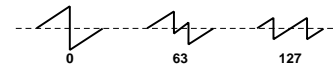
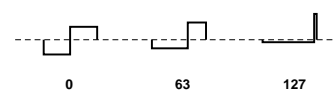

Figure 3-2



*3-1: PWM

Pulse Width Modulation refers to the use of a separate signal to vary the pulse width over time. On the microKORG, you can use PWM to modify the tone via LFO1, or via Virtual Patch from modulation sources LFO2, Filter EG, or Amp EG.

3. OSC1 (Oscillator 1) — SYNTH/VOCODER

WAVE

Triangle Wave (△):

This is a triangle wave, which has weaker overtones and a stronger fundamental than a sawtooth wave or square wave. It is suitable for mellow bass sounds.

Sine Wave (sin):

This is a sine wave. This waveform contains only the fundamental, and no overtones at all. It can be used to create claves or bass drum sounds. In some synth programs, oscillator 2 is used to perform cross modulation*3-2 (→Figure 3-4), creating a more complex overtone structure.

Cross modulation by a sine wave cannot be applied to a vocoder program.

note Since a sine wave contains no overtones, the filter will not modify its tone.

Vox Wave (UO):

This simulates a waveform similar to human vocal cords. Even if the oscillator pitch is changed, the frequency spectrum will be maintained, which makes this effective when used for vocal-type sounds or as a vocoder oscillator.

Select HPF or BPF as the filter, and adjust "Cutoff" to create a vocal-type sound.

CONTROL 1

CONTROL 1 [0...127]:

You can modify the waveform by adjusting this value.

A setting of 0 will produce a triangle wave, and a setting of 127 will produce a waveform with a pitch that is one octave and a fifth higher. (→Figure 3-3)

CONTROL 1 [0...127]:

On a synth program, this adjusts the depth of cross modulation.

On a vocoder program, this modifies the waveform.

CONTROL 1 [0...127]:

Adjusting this value will modify the waveform. (→Figure 3-5)

CONTROL 2

CONTROL 2 [0...127]:

LFO1 is used to apply wave form modulation to the waveform specified by "CONTROL 1." The "CONTROL 2" setting specifies the depth of the modulation produced by LFO1.

CONTROL 2 [0...127]:

On a synth program, this adjusts the depth of additional modulation applied by LFO1 to the cross modulation specified by "CONTROL 1." On a vocoder program, this adjusts the depth of modulation applied by LFO1 to the waveform that you selected by "CONTROL 1."

CONTROL 2 [0...127]:

LFO1 is used to apply modulation to the waveform specified by "CONTROL 1." CONTROL 2 sets the depth of the modulation applied by LFO1.

Figure 3-3

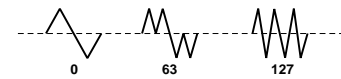

Figure 3-4

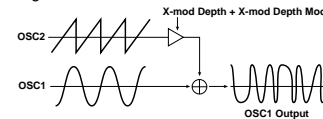
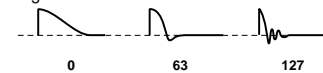

Figure 3-5



*3-2: Cross Modulation

This is a type of oscillator modulation available on analog synthesizers of the past. Normally, a low-frequency signal (such as from an LFO) is used as the modulation source for an oscillator, but Cross Modulation lets you use another oscillator as the modulation source, creating sounds with a complex overtone structure that would not normally be produced otherwise. On the microKORG, you can use oscillator 2 to apply cross modulation if a sine wave is selected for oscillator 1. Gradually raise the "CONTROL 1" level, and notice how the sound changes. This can produce distorted sounds, or sounds with a metallic character.

You can produce an even wider variety of effects by adjusting the OSC2 "SEMITONE" or "TUNE" parameters. You can also achieve interesting results by applying sync modulation and cross modulation at the same time.

3. OSC1 (Oscillator 1) — SYNTH/VOCODER

WAVE

DWGS (1, 9)

(Digital Waveform Generator System): This is waveform data created by harmonic additive synthesis. Choose this when you want to create sounds with a distinctive "digital-synth" character, such as synth bass, electric piano, bell, or horn. 64 types of waveform are provided.

Noise (105):

This generates white noise. Within the oscillator, a LPF (Low Pass Filter) is provided to process the noise. (→Figure 3-6). You can use this to create percussion sounds, or sound effects such as surf. This can also be used in conjunction with another timbre to simulate the "breath" component of a wind instrument sound.

CONTROL 1

CONTROL 1 [---]:

CONTROL 1 [0...127]:

This sets the cutoff frequency of the LPF. Adjusting this will affect the noise waveform.

Figure 3-6

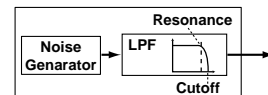

CONTROL 2

CONTROL 2 [1...64]:

Selects the DWGS waveform. (→Table 3-1)

note DWGS waveform data was first used in the Korg DW-6000 (which went on sale in 1984), and has continued to be developed since that time.

CONTROL 2 [0...127]:

This controls the resonance of the LPF.

If you raise this enough to produce an identifiable pitch, the cutoff frequency will move according to the keyboard location you play, and the change will be heard as a pitch.

note If you want the oscillation produced by resonance to match the reference pitch, set "CONTROL 1" to 24.

Table 3-1

DWGS List

No.	Name	No.	Name	No.	Name
1	SynSine1	24	5thWave1	47	Clav1
2	SynSine2	25	5thWave2	48	Clav2
3	SynSine3	26	5thWave3	49	Guitar1
4	SynSine4	27	Digi1	50	Guitar2
5	SynSine5	28	Digi2	51	Guitar3
6	SynSine6	29	Digi3	52	Bass1
7	SynSine7	30	Digi4	53	Bass2
8	SynBass1	31	Digi5	54	Bass3
9	SynBass2	32	Digi6	55	Bass4
10	SynBass3	33	Digi7	56	Bass5
11	SynBass4	34	Digi8	57	Bell1
12	SynBass5	35	Endless*	58	Bell2
13	SynBass6	36	E.Piano1	59	Bell3
14	SynBass7	37	E.Piano2	60	Bell4
15	SynWave1	38	E.Piano3	61	Voice1
16	SynWave2	39	E.Piano4	62	Voice2
17	SynWave3	40	Organ1	63	Voice3
18	SynWave4	41	Organ2	64	Voice4
19	SynWave5	42	Organ3		
20	SynWave6	43	Organ4		
21	SynWave7	44	Organ5		
22	SynWave8	45	Organ6		
23	SynWave9	46	Organ7		

*: The 35 Endless waveform simulates an endless scale, in which notes one octave apart have the identical pitch. You can play an ascending or descending scale as far as you wish, producing the sensation that a scale of the same pitch is continuing infinitely.

3. OSC1 (Oscillator 1) — SYNTH/VOCODER

WAVE

Audio In (AUD):

The waveform of the audio signal input from the AUDIO IN 1 or 2 jacks will be used instead of an oscillator.

This lets you apply filtering to a drum phrase, or synthesize a vocal or guitar sound together with oscillator 2.

⚠ The parameters of the **PITCH** section have no effect on the waveform that is input from the AUDIO IN 1 or 2 jacks.

CONTROL 1

CONTROL 1 [0...127]: This adjusts the volume balance between AUDIO IN 1 and AUDIO IN 2. With a setting of 127 only AUDIO IN 1 will be output. With a setting of 0, only AUDIO IN 2 will be output.

CONTROL 2

CONTROL 2 [0...127]: LFO1 is used to apply modulation to the volume balance between AUDIO IN 1 and AUDIO IN 2 that you set by "CONTROL 1." The "CONTROL 2" setting sets the depth of this modulation produced by LFO1. This lets you create effects in which the AUDIO IN 1 and 2 inputs are alternated.

Processing an external input audio signal

You can use the filter, amp, EG, and LFO etc. to process the signal from an external synthesizer, rhythm machine, or audio device in the same way as an oscillator waveform.

⚠ Before you connect an external device, turn off the power of the microKORG and of any external output devices and power amps.

- 1 Turn the rear panel AUDIO IN 2 **VOLUME 2** knob to the MIN position.
- 2 Connect the output jack of your external device to the AUDIO IN 2 **LINE** jack.
- 3 After making connections, turn the power on in the order of your external device, the microKORG, and finally your powered monitor speaker system.
- 4 Select a program to initialize, and initialize it.

For this example, select any synth program, and initialize the program as described on page 59.

- 5 Turn the EDIT SELECT 1 knob to the **OSC 1** position, and turn knob 1 ("WAVE") to select "AUD" (Audio In).
- 6 Input an audio signal from your external device, and turn the **VOLUME 2** knob toward MAX as far as possible without allowing the AUDIO IN 2 LED to light red.
- 7 While inputting an audio signal, play the keyboard.
- 8 As described in "Basic editing procedure" (→p.12), edit the **FILTER**, **AMP**, **EG**, **LFO**, and effects to modify the sound.

⚠ The **PITCH**-related parameters have no effect on the sound from the AUDIO IN jacks.

MIDI In this example, you could connect the microKORG's MIDI OUT to the MIDI IN of your external MIDI device and set the MIDI channels to match, so that your sound module or other external MIDI device will produce sound when you play the keyboard of the microKORG (→p.49). You can use the microKORG's keyboard to play the sounds of your external device, and use the EDIT SELECT 1/2 knobs and the edit control knobs 1-5 to modify the sound.

MIDI You can use an external input as the carrier of the vocoder. (→p.34)

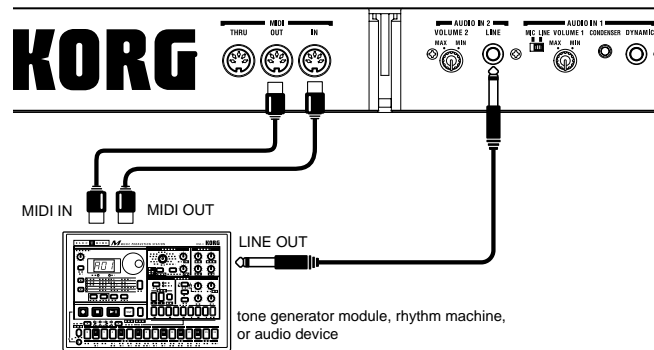

4. OSC2 (Oscillator 2) — SYNTH

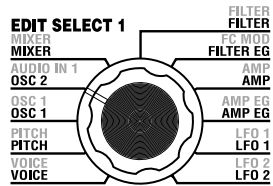

Here you can make settings for oscillator 2.

You can create a variety of sounds by using two oscillators together. For example you can adjust "SEMITONE" (knob 3) and "TUNE" (knob 4) so that one oscillator acts as though it were part of the overtone structure of the other oscillator, set the pitches of the two oscillators to an interval of harmony, or set both oscillators to the same pitch but slightly detune one of them to create a detuning effect.

You can also use Ring Modulation and Oscillator Sync to create very complex overtone structures. (This is set by "OSC MOD" (knob 2).)

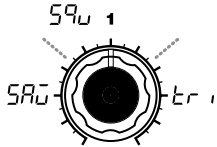

WAVE [Saw, Square, Triangle]
Selects the waveform for oscillator 2.

Saw Wave (SAW):
A sawtooth wave. (→p.18)

Square Wave (SQ):
A square wave. (→p.18)

Triangle Wave (TR):
A triangle wave. (→p.19)

note If you do not hear the sound of oscillator 2, raise the **MIXER** "OSC2 LEVEL" (knob 2). If you want to hear only the sound of oscillator 2, lower the **MIXER** "OSC 1 LEVEL" (knob 1).

OSC MOD [OFF, Ring, Sync, RingSync]
Selects the type of oscillator modulation that will be produced in conjunction with oscillator 1.

OFF (OFF):
The sound will be output without applying oscillator modulation. You can adjust "SEMITONE" and "TUNE" to produce harmony, detune, or harmonic-component effects.

Ring (RING):
Ring modulation *4-1 will be applied. (→Figure 4-1)
By adjusting "SEMITONE" and "TUNE" you can create metallic sounds with little sense of pitch. This is effective for sound effects.

Sync (SYN):
Oscillator sync *4-2 will be applied. This is useful for creating synth-lead sounds. (→Figure 4-2)

RingSync (RS):
This simultaneously applies Ring and Sync modulation. (→Figure 4-3)

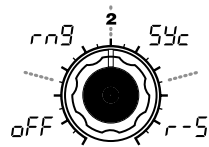

SEMITONE [-24...24]
Specifies the detuning (pitch difference) relative to oscillator 1, in semitone steps over a range of 2 octaves upward or downward.

note If you want to use the sound of oscillator 2 as a component in the oscillator 1 overtone structure, try setting it one octave or a fifth higher than oscillator 1. If you want to use oscillator 2 in harmony, you can try intervals such as a third, fourth, or fifth.

Figure 4-1

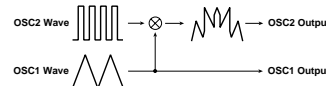

Figure 4-2

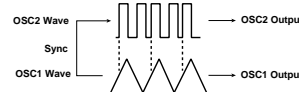
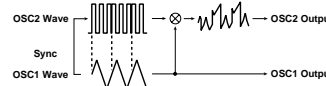

Figure 4-3



TUNE [-63...63]
Specifies the amount of detune for OSC2 relative to OSC1.

A setting of ± 63 produces a pitch difference of ± 2 octaves, and ± 48 produces a pitch difference of ± 1 octave. A value near 0 will make fine adjustments in the pitch.

note If "OSC MOD" is set to Sync, adjustments in "Semitone" or "Tune" will change the pitch of the overtones. The pitch of the fundamental will not change.

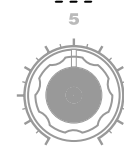
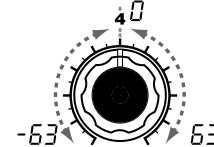

*4-1: Ring Modulation:

This modulation generates a sum and difference of the oscillator 1 and 2 waveforms.

For example you can select a square wave for the oscillator, set "TRANSPPOSE" to 0, "SEMITONE" to 24, and adjust "TUNE" to produce a clear bell-like sound. The effect will be easier to detect if you lower "OSC 1 LEVEL" and raise "OSC 2 LEVEL." You can also create interesting effects by using Virtual Patch to modulate OSC 2 TUNE from LFO or EG.

*4-2: Oscillator Sync:

This modulation forcibly synchronizes the phase of oscillator 2 to the phase of oscillator 1.

For example, select sawtooth wave for oscillator 1 and raise the "OSC 2 LEVEL." Then, edit "SEMITONE" and "TUNE" to change the pitch, and notice the result. The effect will be more noticeable if the oscillator 2 pitch is raised above the oscillator 1 pitch. You can also produce interesting effects by using Virtual Patch to modulate OSC 2 Tune from LFO or EG.

5. MIXER — SYNTH

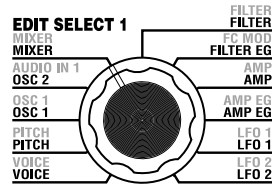

These parameters adjust the volume balance of the oscillator 1 and 2, and the noise generator. "OSC 1 LEVEL" (knob 1) sets the output level of oscillator 1, "OSC 2 LEVEL" (knob 2) sets the output level of oscillator 2, and "NOISE LEVEL" (knob 3) sets the output level of the noise generator.

These settings will be the input level to the filter.

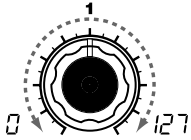

OSC 1 LEVEL [0...127]
Sets the output level of oscillator 1.

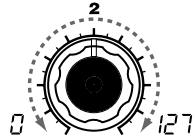

OSC 2 LEVEL [0...127]
Sets the output level of oscillator 2.

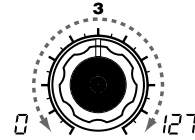

NOISE LEVEL [0...127]
Sets the output level of the noise generator.

This noise generator generates white noise. This is independent of the white noise that can be selected as a waveform for oscillator 1. This does not have filter or resonance (as the oscillator 1 noise generator, but you can use the FILTER section to create the same results as the noise waveform of oscillator 1.

Noise is used to create percussion instrument sounds, or sound effects such as surf.

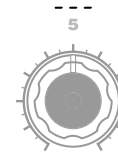
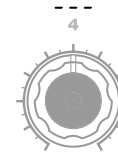

6. FILTER — SYNTH

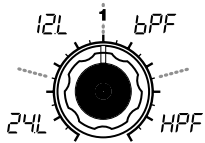
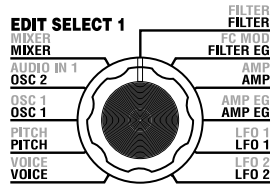

TYPE [-24dB LPF, -12dB LPF, -12dB BPF, -12dB HPF]

Selects the type of filter

-24dB LPF (24L):

The -24 dB LPF (-24 dB/octave Low Pass Filter) is the most common type of filter; it passes the frequencies that are below the cutoff frequency, and cuts the frequencies that are above (→Figure 6-1). Lowering the cutoff frequency will make the tone darker and more mellow.

-12dB LPF (12L):

The -12 dB LPF (-12 dB/octave Low Pass Filter) has a more gentle slope than the -24 dB LPF, producing a more natural-sounding effect. (→"-24 dB LPF") (→Figure 6-1)

Figure 6-1

LPF (Low Pass Filter)

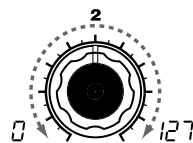
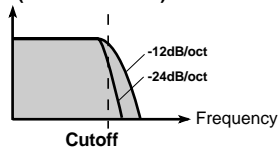

CUTOFF [0...127]

Sets the cutoff frequency. Increasing this value will raise the cutoff frequency.

note "CUTOFF" can be varied by time-variant change produced by Filter EG, by keyboard playing dynamics (velocity), and by note location (keyboard tracking).

▲ If the "CUTOFF" value is set too low, the volume may be extremely low, or you may hear no sound at all.

Figure 6-4

The effect of resonance

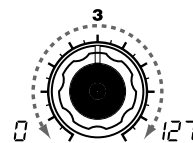
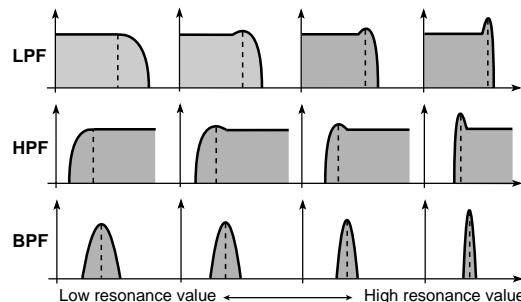

RESONANCE [0...127]

Sets the resonance of the filter. This will emphasize the overtones near the cutoff frequency specified by "CUTOFF," adding a distinctive character to the sound. Increasing this value will increase the effect. (→Figure 6-4)

Since movement of the "CUTOFF" knob will affect the overtones that are boosted by resonance, it is best to adjust "CUTOFF" and "RESONANCE" in conjunction with each other.

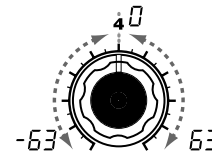

FILTER EG INT [-63...63]

This specifies how time-variant modulation from the Filter EG will be applied to the cutoff frequency (→Figure 6-5). The cutoff frequency will change over time according to the Filter EG settings, modifying the tone. For example, you can use this to create a sound that gradually begins to brighten when you press the key, and then gradually becomes darker.

This INT (Intensity) parameter specifies the depth (sensitivity) to which the Filter EG will affect the cutoff frequency.

With a setting of 0, the Filter EG will not affect the cutoff frequency. Increasingly positive (+) settings will allow the Filter EG to have a correspondingly greater effect on the cutoff frequency. (→Figure 6-6)

Increasingly negative (-) settings will allow a correspondingly greater effect in the opposite direction. (→Figure 6-7)

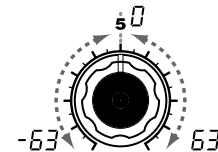

FILTER KEY TRACK [-63...63]

This specifies how keyboard tracking (the keyboard location that you play) will affect the cutoff frequency.

For example if the sound played by the C4 key has the desired tone but higher notes no longer have resonance or are too mellow-sounding, you can adjust keyboard tracking to make compensations so that the cutoff frequency will rise for higher notes.

With positive (+) settings, the cutoff frequency will rise as you play upward from the C4 note, and fall as you play downward. With negative (-) settings, the cutoff frequency will fall as you play upward from the C4 note, and rise as you play downward.

note With a setting of +48, the change in cutoff frequency will be proportionate to the change in pitch. With a setting of 0, keyboard tracking will not affect the cutoff frequency.

6. FILTER — SYNTH

TYPE

-12dB BPF (BPF):

-12dB/oct BPF (Band Pass Filter) allows a frequency band in the region of the cutoff frequency to pass, and cuts the remaining frequencies. It is used when you wish to emphasize only a specific portion of the frequency range. (→Figure 6-2)

Use this when you want to emphasize just a specific region of the sound. For example, you can use this to create a bandwidth-limited sound similar to sound heard from a small radio or a telephone.

Figure 6-2

BPF (Band Pass Filter)

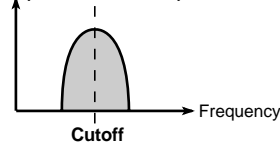

-12dB HPF (HPF):

-12dB/oct HPF (High Pass Filter) allows frequencies above the cutoff frequency to pass, and cuts the lower frequencies. Use this when you wish to make the sound thinner. However if the cutoff frequency is raised excessively, the volume will decrease significantly. (→Figure 6-3)

For example you can use the HPF to purposely attenuate the low-frequency region of a sound that will be played together with other low-frequency instruments, in order to differentiate that sound from the other instruments.

Figure 6-3

HPF (High Pass Filter)

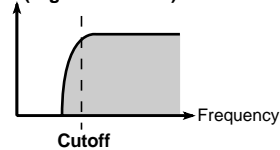

Filter oscillation

If you raise the resonance to a high value, it will oscillate (produce a sound) at the frequency specified by the cutoff frequency. You can use filter oscillation ("self-oscillation") as a sound source. If the filter is oscillating, the "CUTOFF" parameter that normally adjusts the tone will instead control the pitch of the oscillation. This can be used in a variety of ways. Whistling is a typical example, and can be produced by adjusting the ADSR parameters of the filter EG. You can also try setting "FILTER EG INT" to a negative value. Another possibility is to select the MOD wheel or LFO 1/2 as a source in Virtual Patch, and use it to control "CUTOFF" as a destination.

FILTER KEY TRACK

note Keyboard Track operates according to the pitch that is controlled by pitch bend, and transpose. It is not affected by pitch changes produced by vibrato or Virtual Patch.

Figure 6-5

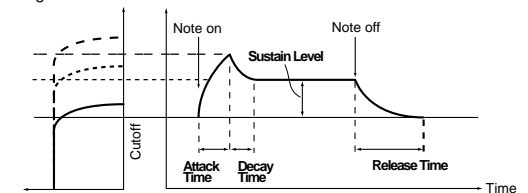

Figure 6-6

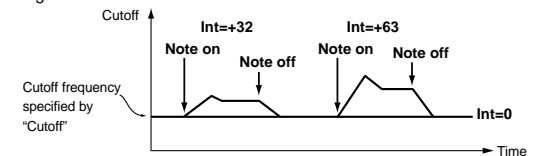
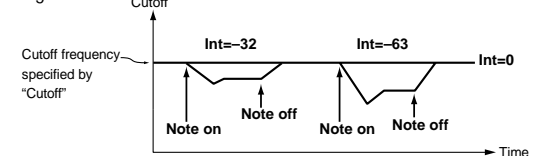
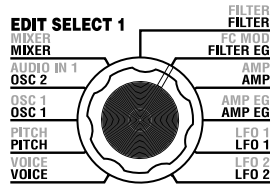

Figure 6-7



7. FILTER EG — SYNTH



Here you can make settings for the filter EG, which applies time-variant change to the tone (→Figure 7-1). Make these settings to specify the "shape" of the EG, and use the FILTER parameter "FILTER EG INT" to specify the amount of effect that the EG will have (→p.24). By making FILTER EG settings, you can make the tone change as time passes. Create the desired tonal curve by adjusting the ADSR parameters; ATTACK (knob 1), DECAY (knob 2), SUSTAIN (knob 3), RELEASE (knob 4).

For details on how an EG (Envelope Generator) works, refer to AMP EG (→p.28).

note You can use the FILTER EG as a Virtual Patch source modulate a parameter other than the filter cutoff frequency. (→p.30)

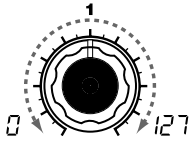

ATTACK [0...127]
Specifies the time from note-on (when the key is pressed) until the attack level (maximum value of the envelope) is reached.

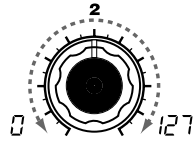

DECAY [0...127]
Specifies the time from when the attack level is reached until the sustain level (SUSTAIN) is reached.

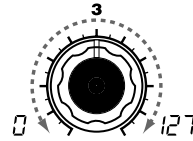

SUSTAIN [0...127]
Specifies the cutoff frequency that will be maintained after the decay time has elapsed, until you release the key.

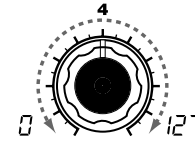

RELEASE [0...127]
Specifies the time from note-off (when the key is released) until the level reaches 0.

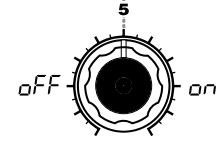

EG RESET [OFF, ON]
Specifies whether or not the EG will be reset for the second and subsequent note-on. If a new note is played before the previous note has finished its release stage, the envelope can either start over from zero, or continue from the current value.

OFF (OFF):
The note will start from the current EG level.

ON (ON):
The second note-on will start from a level of 0.

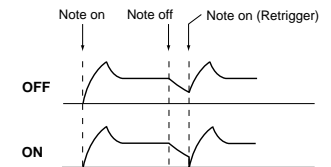

note The "EG RESET" parameter is only available if "VOICE ASSIGN" is set to Poly, or if "VOICE ASSIGN" is set to Mono or Unison and "TRIGGER" is set to Multi.

Figure 7-1

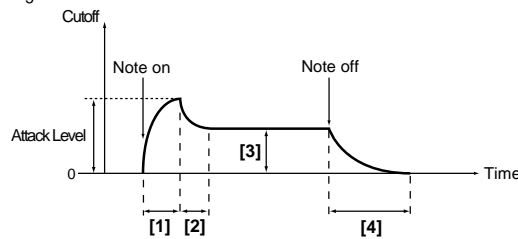

[1]: Attack Time [3]: Sustain Level
[2]: Decay Time [4]: Release Time

Filter EG and Amplifier EG

When the Filter EG changes the cutoff frequency, the tone will change. However depending on the volume changes produced by the Amplifier EG, this can be heard in different ways. For example by changing the speed at which the tone and volume begin (attack) or decay, you can significantly vary the character of the tonal change. It is a good idea to adjust the changes of both the Filter EG (tone) and the Amplifier EG (volume) as you proceed with editing.

8. AMP (Amplifier) – SYNTH

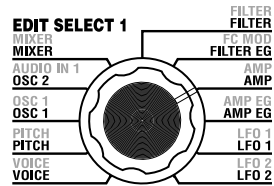

These parameters specify the volume. The sound that is created by passing through the oscillator and filter is amplified by the amp. "LEVEL" (knob 1) adjusts the volume. "KBD TRACK" (knob 4) adjusts how keyboard tracking will affect the volume, and "DISTORTION" (knob 3) specifies whether the sound will be distorted.

You can use "PANPOT" (knob 2) to set the pan (stereo position of the sound).

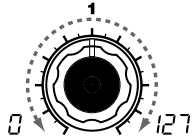

LEVEL [0...127]
Adjusts the volume of the timbre.
If the "SINGLE/LAYER" is Layer, this setting will adjust the volume balance between timbre 1 and timbre 2.

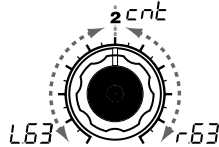

PANPOT [L63...Center...R63]
Adjusts the location of the sound in the stereo field.
L63 (L63) is far left, Center (Cntr) is center, and R63 (R63) is far right.

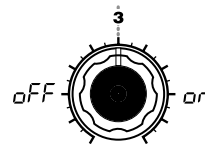

DISTORTION [OFF, ON]
Specifies whether distortion will be applied to the output of the timbre. The degree of distortion is adjusted by the output level of each oscillator in the MIXER.
OFF (OFF):
Distortion is off.
ON (ON):
Distortion is on.

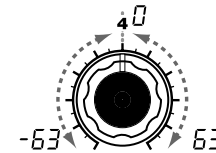

KBD TRACK [-63...63]
Specifies how keyboard tracking will affect the volume.
With positive (+) settings, the volume will increase as you play above the C4 note on the keyboard, and will decrease as you play below C4.
With negative (-) settings, the volume will decrease as you play above the C4 note on the keyboard, and will increase as you play below C4.

note Keyboard Track operates according to the pitch that is controlled by pitch bend, and transpose. It is not affected by pitch changes produced by vibrato or Virtual Patch.

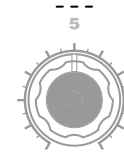

9. AMP EG — SYNTH/VOCODER

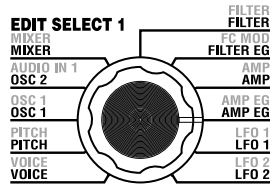

Here you can make settings for the AMP EG, which applies time-variant change to the volume (→Figure 9-1). By making AMP EG settings, you can make the volume change as time passes. Create the desired volume curve by adjusting the ADSR parameters; ATTACK (knob 1), DECAY (knob 2), SUSTAIN (knob 3), RELEASE (knob 4).

note You can use AMP EG as a Virtual Patch source to modulate parameters other than volume. (→p.30)

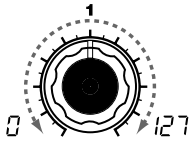

ATTACK [0...127]
Specifies the time from note-on (when the key is pressed) until the attack level (maximum value of the envelope) is reached.

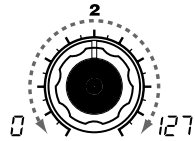

DECAY [0...127]
Specifies the time from when the attack level is reached until the sustain level (SUSTAIN) is reached.

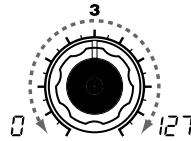

SUSTAIN [0...127]
Specifies the volume that will be maintained after the decay time has elapsed, as long as you continue holding the key.

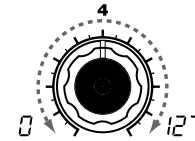

RELEASE [0...127]
Specifies the time from note-off (when the key is released) until the level reaches 0.

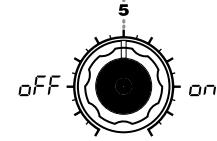

EG RESET [OFF, ON]
Specifies whether or not the EG will be reset for the second and subsequent note-on. If a new note is played before the previous note has finished its release stage, the envelope can either start over from zero, or continue from the current value.

EG (Envelope Generator)

To a significant extent, each sound has its own distinctive volume curve. For example when you play a note on a piano, the note begins at the maximum volume, and gradually diminishes. When you release your finger from the key, the sound will disappear quickly with a brief decay. Volume curves such as this are an important aspect of how we identify the sound of a specific instrument. This type of change also occurs in the tone and pitch, as well as in the volume. On a synthesizer, this type of change is produced by an EG. The microKORG has dedicated EGs for the filter and for the amp. However since these EGs can be used as Virtual Patch sources, you are also free to use them to vary the pitch or numerous other aspects of the sound. Some example settings are shown below.

Figure 9-1

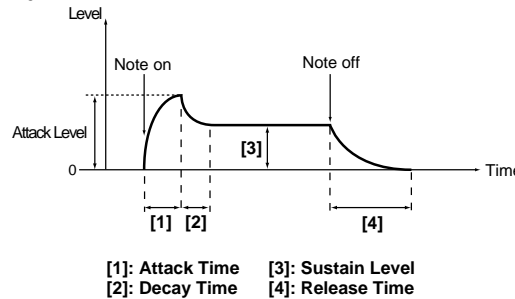

OFF (OFF):

The note will start from the current EG level.

ON (ON):

The second note-on will start from a level of 0.

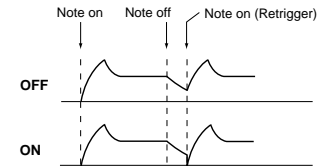

note The "EG RESET" parameter is available only when "VOICE ASSIGN" is Poly, or when "VOICE ASSIGN" is Mono or Unison and "TRIGGER" is Multi.

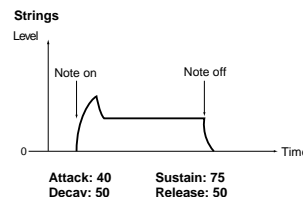
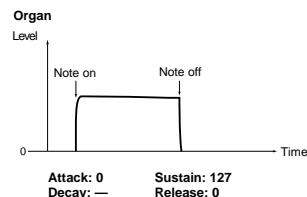
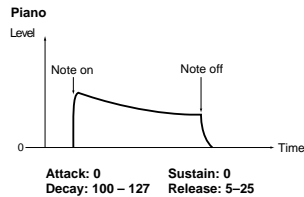

10. LFO 1, 11. LFO 2 – SYNTH/VOCODER

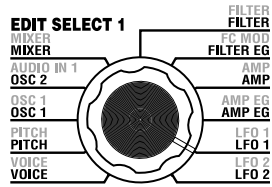

The timbre has two LFOs (Low Frequency Oscillator).

The cyclic change produced by an LFO can modulate various aspects of the sound such as the pitch, tone, or volume.

Use "WAVE" (knob 1) to select the LFO waveform, knob 2 to select the key sync method, "TEMPO SYNC" (knob 3) to synchronize the LFO cycle to the tempo, and "FREQUENCY"/"SYNC NOTE" (knob 4) to specify the frequency.

note LFO1 and LFO2 can be used as Virtual Patch sources to apply modulation to a variety of parameters. (→p.30)

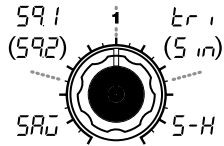

WAVE (LFO1) [Saw, Square1, Triangle, Sample&Hold]
WAVE (LFO2) [Saw, Square2, Sine, Sample&Hold]
 Selects the LFO waveform.

Figure 10-1

Saw (591):
Square1 (1):
Square2 (592):
Triangle (5 in):
Sine (5 in):
Sample&Hold (5-H):
 Amplitude changes irregularly (sample & hold)

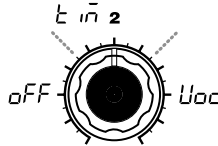

KEY SYNC [OFF, Timbre, Voice]
 Specifies how the LFO will be applied to a voice when note-on occurs.

OFF (OFF):
 The LFO phase will not be reset when note-on occurs. (→Figure 10-2)

Timbre (5 in):
 The LFO phase will be reset at the first note-on that occurs from a state of no keys pressed. Subsequently, modulation will continue to be applied at the same LFO phase even for subsequent note-on's. (→Figure 10-3)

Voice (UOC):
 The LFO phase will be reset at each note-on, and modulation of differing phases will apply to each voice. (→Figure 10-4)

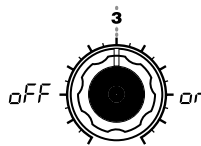

TEMPO SYNC [OFF, ON]
 Specifies whether the LFO cycle will be synchronized to the tempo or MIDI Clock.

OFF (OFF):
 The LFO will not be synchronized. It will operate at the frequency specified by the "FREQUENCY" parameter.

ON (ON):
 The LFO will be synchronized to the ARPEG.A "TEMPO" or to MIDI Clock messages from an external device.

note If "TEMPO SYNC" is ON, selecting LFO2 Frequency (LF2) as "DEST" in PATCH 1-4 will have no effect.

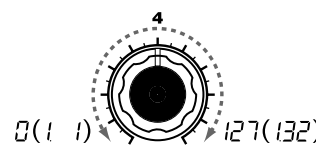

FREQUENCY [0...127]
 Specifies the frequency of the LFO. Increasing this value will result in a faster frequency. This parameter will be displayed and can be set if "TEMPO SYNC" is OFF.

SYNC NOTE [1.1...1.32]
 Specifies the proportion of the LFO cycle relative to the tempo specified by ARPEG.A "TEMPO." (→p.65) This parameter will be displayed and can be set if "TEMPO SYNC" is ON.

1/1 (1 1): Four beats will be one cycle.
1/2 (1 2): Four beats will be two cycles.
1/4 (1 4): One beat will be one cycle.
1/8 (1 8): One beat will be two cycles.

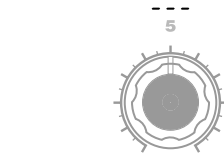

Figure 10-2

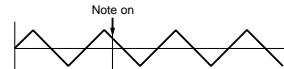

Figure 10-3

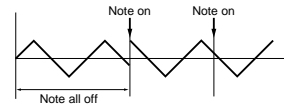
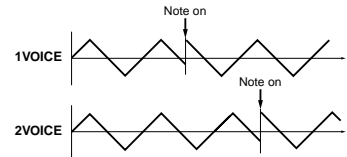

Figure 10-4



LFO (Low Frequency Oscillator)

The LFO (Low Frequency Oscillator) is an oscillator that produces a relatively slow (low-frequency) oscillation, and is used to apply cyclic modulation to various aspects of the sound. Some typical ways to use LFO are vibrato (use LFO to raise and lower the pitch), wah (use LFO to raise and lower the cutoff frequency), and tremolo (use LFO to raise and lower the

volume). You can select LFO as a Virtual Patch source, select the desired parameter as the destination, and apply modulation to produce various effects.

The microKORG provides some dedicated parameters for applying modulation from the LFO; for LFO1 you can use OSC1 "CONTROL 2," and for LFO2 you can use PITCH "VIBRATO INT."

12. PATCH 1, 13. PATCH 2, 14. PATCH 3, 15. PATCH 4 — SYNTH

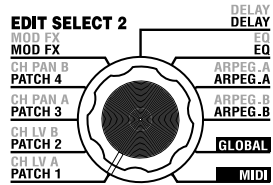

The microKORG provides four Virtual Patch routes that let you create more sophisticated sounds. Each patch lets you select a modulation "SOURCE" (knob 1) and modulation destination "DEST" (knob 2), and specify the intensity of modulation "MOD INT" (knob 3). By using various patchings you can create a wide variety of changes in the sound.

For example if you set the modulation source "SOURCE" (knob 1) to LFO2 (LF2) and set the modulation destination "DEST" (knob 2) to CutOff (CUT), and use "MOD INT" (knob 3) to adjust the depth of the effect, LFO2 will create a cyclic change in tone (a "wah" effect).

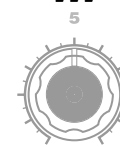
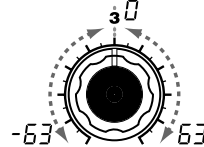
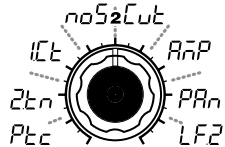
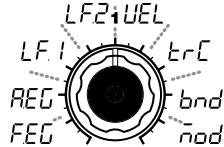

SOURCE [FILTER EG, AMP EG, LFO 1, LFO 2, Velocity, KBD Track, Pitch Bend, MOD.Wheel]

Selects a modulation source. For example if you select Filter EG (FEG), the Filter EG will be the modulation source.

FILTER EG (FEG): FILTER EG

AMP EG (AEG): AMP EG

LFO 1 (LF1): LFO 1

LFO 2 (LF2): LFO 2

Velocity (VEL):

Velocity (keyboard playing strength)

KBD Track (trc):

Keyboard tracking (keyboard position)

note Keyboard Track operates according to the pitch that is controlled by pitch bend, and transpose. It is not affected by pitch changes produced by vibrato or Virtual Patch.

Pitch Bend (bnd): PITCH wheel

MOD.Wheel (mod): MOD wheel

DEST [Pitch, OSC2 Tune, OSC1 Control 1, Noise Level, CutOff, Amp, Pan, LFO2 Frequency]

Selects the parameter (destination) that will be controlled by the modulation.

For example if you select Pitch (PFC), modulation will be applied to the overall pitch of the timbre.

Pitch (PFC): Overall pitch of the timbre

OSC2 Tune (OSC2): OSC2 "TUNE"

OSC1 Control 1 (OSC1): OSC1 "CONTROL 1"

Noise Level (NOISE):

MIXER "NOISE LEVEL"

CutOff (CUT): FILTER "CUT-OFF"

Amp (AMP): AMP "LEVEL"

Pan (PAN): AMP "PAN"

LFO2 Frequency (LF2):

LFO2 "FREQUENCY"

note If LFO "TEMPO SYNC" is ON,

selecting LFO2 Frequency will have no effect.

MOD INT [-63...63]

Specifies the depth of the effect produced by the modulation source. With a setting of 0, there will be no modulation.

Virtual Patch

On modular analog synthesizers, the input or output of each module (oscillator, filter, amp, EG, LFO, and other controllers) was connected ("patched") by a patch cord as desired, allowing you a great deal of freedom in creating the sound. The Korg MS-20 (which went on sale in 1978) also allowed a limited degree of this type of patching. The microKORG lets you perform this patching "virtually" (i.e., without using physical patch cords), so you can assign sources such as EG or LFO to the most important parameters (destinations).

Setting example for "SOURCE" and "DEST"

SOURCE [1]	DEST [2]	
Filter EG/Amp EG	Pitch	The Filter EG or Amp EG will vary the pitch of the entire timbre over time.
Filter EG/Amp EG	Pan	The Filter EG or Amp EG will vary the pan over time. By setting two patches to "MOD INT" settings with the opposite (+/-) value you can create more complex panning.
LFO 1/LFO 2	Pitch	Vibrato will be applied at the LFO1 or LFO2 frequency.
LFO 1/LFO 2	CutOff	Wah will be applied at the LFO1 or LFO2 frequency .
LFO 1/LFO 2	Amp	Tremolo will be applied at the LFO1 or LFO2 frequency.
LFO 1/LFO 2	Pan	Auto pan will be applied at the LFO1 or LFO2 frequency.
Velocity	Amp	Velocity (keyboard playing strength) will affect the volume.
Keyboard Track	Pan	Keyboard position will gradually change the pan; lower notes at the left, and higher notes at the right.
Pitch Bend	Pan	PITCH wheel operations or pitch bend change will move the sound between left and right.
Modulation Wheel	CutOff	MOD wheel operations or CC#1 will vary the cutoff frequency.
Modulation Wheel	LFO2 Frequency	MOD wheel operations or CC#1 will vary the LFO2 speed.

Editing a vocoder program

Overview

A vocoder is a device that analyzes the character (the frequency response of each band) of a "modulator" signal (typically a human voice from a mic), and applies a filter with the analyzed characteristics to the "carrier" signal (typically a waveform produced by an oscillator), imposing a vocal character on that waveform, and making it seem as though the instrument is talking.

The microKORG contains an eight-channel vocoder (sixteen filters in pairs). In addition to simulating the classic vocoder sounds of the past, you can modify the character of the sound, or edit the level of each frequency band to create truly original vocoder sounds.

As shown in figure v0-1, a vocoder program consists of a carrier (the signal that is modified), a modulator (the signal that modulates the carrier), a vocoder section, effects, and arpeggiator.

Carrier

The carrier signal that is processed by the vocoder effect can be the microKORG's internal waveform selected by OSC 1 and NOISE, or a waveform that is input from AUDIO IN 2 (LINE jack). Suitable choices for the carrier waveform are sawtooth waves which contain a rich array of overtones, and the VOX WAVE which has a character similar to human vocal cords.

The volumes of OSC1/NOISE/AUDIO 2 IN are adjusted by the MIXER, and the combined signal is output to the Vocoder section.

Modulator

The signal that is input to the AUDIO IN 1 (CONDENSER jack or DYNAMIC jack) will be the modulator. In general, it is most common for a voice to be input to the modulator, but you can create unique effects by inputting rhythm sounds or other waveforms.

Vocoder section (Vocoder sec.)

This consists of two sets of 16 band-pass filters (ANALYSIS FILTER and SYNTHESIS FILTER) and the ENVELOPE FOLLOWER.

The audio signal from the AUDIO IN 1 jack (modulator) is input to sixteen

The structure of a vocoder program

bandpass filters (ANALYSIS FILTER), and the ENVELOPE FOLLOWER detects the volume envelope (time-variant change) of each frequency band.

Then, the signal from the internal tone generator or the AUDIO IN 2 jack (carrier) is input to the other set of 16 band-pass filters (SYNTHESIS FILTER), and processed by the envelopes detected by the ENVELOPE FOLLOWER to modulate the carrier with the features of the voice, producing the impression that the instrument or sound is talking (vocoder effect).

It is also possible to use the "FORMANT SHIFT" or "CUTOFF" parameters to change each frequency of the carrier band-pass filter. This will cause the frequency response curve to be raised or lowered while preserving the character of the modulator, and will dramatically affect the tone.

EFFECTS

The output from the vocoder section is sent to the modulation effect (MOD FX) → delay effect (DELAY) → equalizer (EQ).

For the modulation effect you can choose from three effects such as chorus. For delay, you can choose from three types of delay, including stereo delay. The equalizer is a two-band equalizer.

ARPEGGIATOR

The arpeggiator can be used to play a vocoder program.

This is a step arpeggiator with six arpeggio types.

Figure v0-1

VOCODER BLOCK DIAGRAM

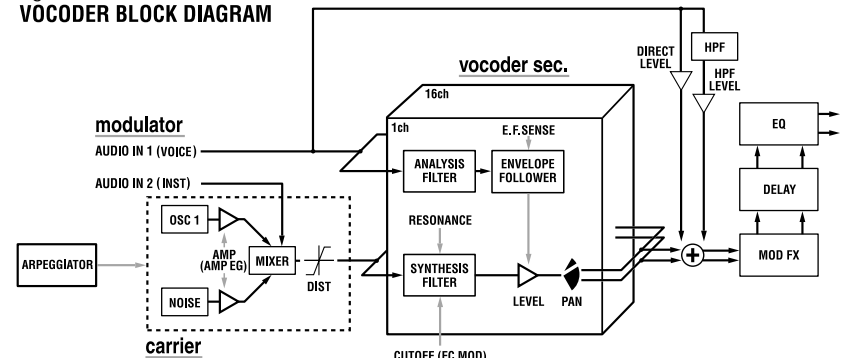

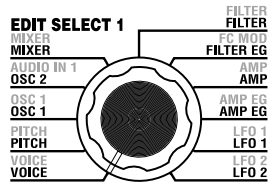

1. VOICE — SYNTH/VOCODER

The "1. VOICE" parameters are the same as for a synth program with a "SINGLE/LAYER" setting of Single (→p.16). To use the program as a vocoder program, set "SYNTH/VOCODER" (knob 1) to Vocoder (L C D).

2. PITCH — SYNTH/VOCODER

The "2. PITCH" parameters are the same as for a synth program (→p.17). They specify the pitch of the carrier.

3. OSC1 — SYNTH/VOCODER

Here you can select the waveform of the carrier.

The "3. OSC1" parameters are the same as for a synth program (→p.18).

By selecting a different waveform for "WAVE" (knob 1) you can change the depth of the effect. Normally, you will set OSC 1 "WAVE" to be a triangle wave which contains a rich set of overtones, or VOX WAVE which simulates a waveform similar to that produced by human vocal cords. Alternatively, you can select DWGS (L 15), and use "CONTROL 2" to select waveform number 26 (5th Wave3: a fifth interval), and play a chord to obtain rich sounds.

note Editing example for a vocoder program

- 1 Adjust the audio from the mic input.
Turn the EDIT SELECT 1 knob to the **AUDIO IN 1** position.
Turn knob 2 ("THRESHOLD"). As you turn the knob toward the right, the sound will be cut more readily. Adjust this so that noise is not obtrusive when you are not speaking into the mic. Then adjust knob 1 ("GATE SENSE") so that the vocoder sound that is output is not cut off in an unnatural way.
Turning knob 4 ("HPF GATE") toward the right will emphasize the consonants (e.g., "s" sounds) of the input voice. (→p.33)
- 2 Make filter settings.
Turn the EDIT SELECT 1 knob to the **FILTER** position.
Turn knob 4 ("EF SENSE") to adjust the sensitivity of the envelope follower. As you turn the knob toward the right, the vocoder output

will rise more smoothly, and the release will become longer.
Turning knob 2 ("CUTOFF") or knob 1 ("FORMANT SHIFT") will vary the cutoff frequency of the band pass filter for the carrier, changing the character of the vocoder output. (→p.35)
Turn the EDIT SELECT 2 knob to the **CH LEVEL A** or **CH LEVEL B** position. Turn knobs 1–4 for **CH LEVEL A** or **CH LEVEL B** to adjust the band pass filter output levels for each of the eight channels of the carrier.
Turn the EDIT SELECT 2 knob to the **CH PAN A** or **CH PAN B** position. Turn knobs 1–4 for **CH PAN A** or **CH PAN B** to adjust the band pass filter output pan for each of the eight channels of the carrier.

4. AUDIO IN 1 — VOCODER

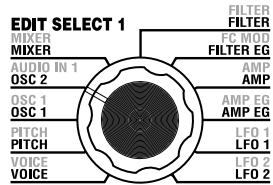

These parameters adjust the input from AUDIO IN 1 (the modulator).

Adjust "THRESHOLD" (knob 2) so that noise is not heard when you are not speaking, and adjust "GATE SENSE" (knob 1) so that the vocoder sound is not cut off unnaturally. Use "HPF LEVEL" (knob 3) to emphasize the consonants (such as "s" sounds) of the input voice.

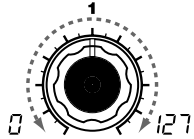

GATE SENSE [0...127]
Specifies the speed of the gate that will operate according to the "THRESHOLD" setting. Lower values for this setting will make the gate operate more quickly, causing the vocoder sound to decay more quickly. Higher values for this setting will make the gate operate more gradually, causing the vocoder sound to have a longer decay.

note If the "THRESHOLD" value is high, this effect will apply more readily. If the threshold value is 0, there will be no effect.

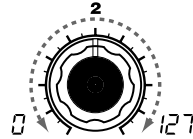

THRESHOLD [0...127]
Specifies the level at which the audio signal from the AUDIO IN 1 jack will be silenced. Increasing this value will cause the audio signal to be silenced. This lets you eliminate any noise that might be heard when no input signal is present.

note If this setting is set excessively high, the audio signal will also be cut, and it will be difficult for the vocoder effect to apply.

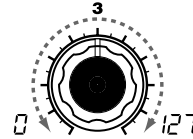

HPF LEVEL [0...127]
Adjusts the amount of the high-frequency portion of the audio signal input from the AUDIO IN 1 jack that will be mixed into the output of the vocoder. Increasing this value will emphasize the portion that corresponds to the consonants of speech or singing.

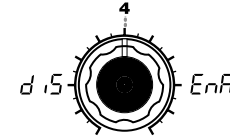

HPF GATE [Disable, Enable]
Specifies whether the high-frequency portion of the signal from AUDIO IN 1 that is mixed into the vocoder output will be passed only during the key-on (note-on) duration, or will always be allowed to pass.

Disable (d, S):
The high-frequency portion of the signal will always be passed. This is effective when you are playing a guitar etc. that is connected via an effect unit to AUDIO IN 2.

Enable (ErA):
The high-frequency portion of the signal will be passed only during the key-on (note-on) duration. Use this setting if you are applying the vocoder effect only to an internal sound source, or if you have connected a synthesizer etc. to AUDIO IN 2. (The signal will be passed when a MIDI note-on is received.)

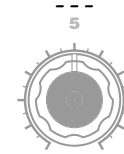

5. MIXER — VOCODER

This sets the output level of the carrier. The level you specify here will be the input level to the band-pass filter (Synthesis Filter) of the carrier.

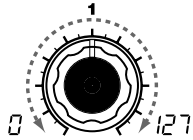
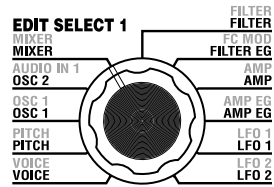

OSC 1 LEVEL [0...127]
Specifies the output level of Oscillator 1 (carrier).

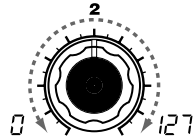

INST LEVEL [0...127]
Specifies the output level of the signal that is input from AUDIO IN 2.

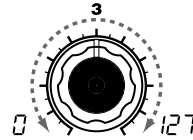

NOISE LEVEL [0...127]
Specifies the output level of the noise generator.

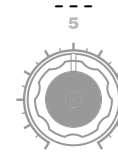
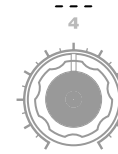

Using an external input as the carrier of the vocoder

Here's how to use a signal input from the AUDIO IN 2 LINE jack as the vocoder carrier (the signal that is modulated).

- As described in the connections for "1. Playing a vocoder program" and "Processing an external input signal" (→p.10, 21), connect the included mic to the AUDIO IN 1 CONDENSER jack, and connect the output jack of your external device to the AUDIO IN 2 LINE jack. Use the VOLUME 1 and VOLUME 2 knobs to adjust the levels so that the audio signals are output to AUDIO IN 1 and 2.
- When you raise the MIXER "INST LEVEL" (knob 2) value, the input signal from AUDIO IN 2 will be input to the band pass filter (synthesis filter) of the carrier.
- When you raise the MIXER "OSC 1 LEVEL" (knob 1) and play the keyboard, the OSC 1 waveform will be input to the band pass filter of the carrier.
- If you set the AUDIO IN 1 "HPF GATE" (knob 4) to Disable (♯, 5), the high-frequency portion of the input signal from the AUDIO IN 1 jack will always be output.

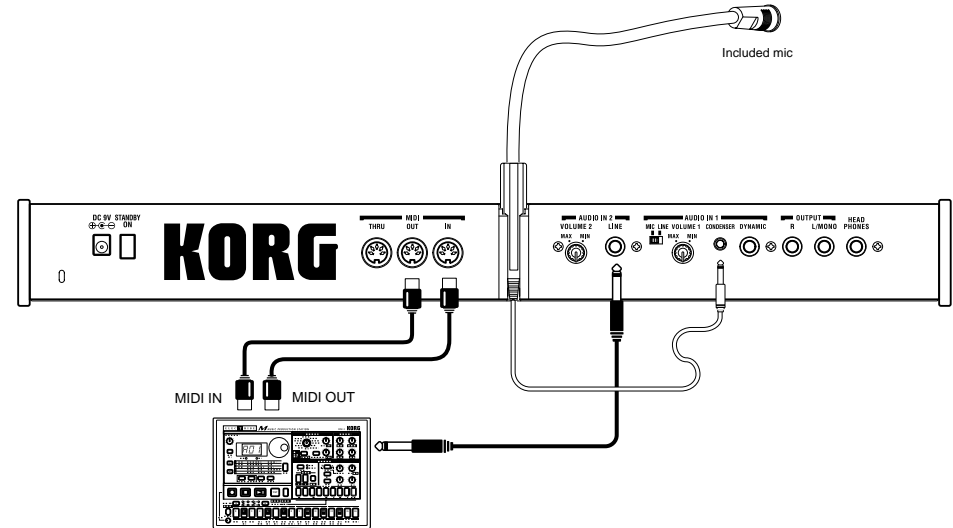

MIDI keyboard, tone generator module, rhythm machine etc.

6. FILTER — VOCODER

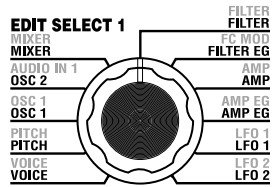

By using "FORMANT SHIFT" (knob 1) and "CUTOFF" (knob 2) to shift the cutoff frequency of each band pass filter of the carrier (the "synthesis filter"), you can raise or lower the frequency response while maintaining the character of the modulator, thus varying the character of the vocoder output. Both of these knobs do the same thing, and have the same range. FORMANT SHIFT is indexed to shift from filter to filter, and CUTOFF is continuously variable. In addition, you can use "E.F. SENSE" (knob 4) to adjust the sensitivity of the Envelope Follower for the modulator, in order to vary the smoothness of the attack and the length of the release for the vocoder output.

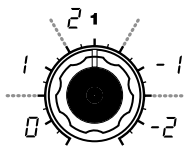

FORMANT SHIFT

[0, 1, 2, -1, -2]

Shifts the cutoff frequency of each band-pass filter of the carrier, in units of filters.

"FORMANT SHIFT" and "CUTOFF"

Each parameter allows you to vary the character over a range of two steps upward or downward (a total of four steps upward or downward when used together). If both of these parameters are at 0, the character will match the cutoff frequencies of the modulator band pass filters (the analysis filter).

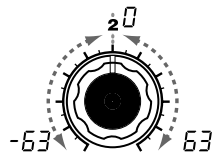
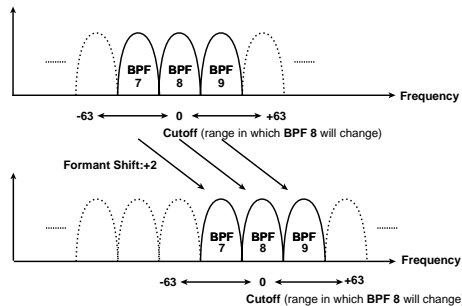

CUTOFF

[-63...63]

This continuously shifts the cutoff frequency of each band-pass filter of the carrier.

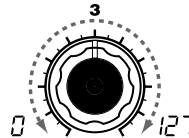

RESONANCE

[0...127]

Specifies the amount of resonance for each band-pass filter of the carrier. Increasing this value will emphasize the regions near each cutoff frequency.

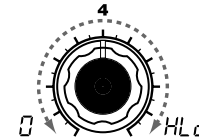

E.F.SENSE

[0...126, Hold]

Specifies the sensitivity of the Envelope Follower for the modulator. Lower settings of this value will allow the attacks of the input signal to be detected more rapidly. If you set this to **Hold (HLD)**, the character of the signal that is being input at that moment will be held. Subsequently, the sound will retain that character regardless of whether there is any input.

note The signal information that is maintained in the Hold state can be saved in the program by writing the program.

! If you set this to Hold when there is no input signal present, there will be no output even if an audio signal is subsequently input.

note This value will automatically be set to Hold if you press the **FORMANT HOLD** key. Higher values will retain more of the sound's natural decay.

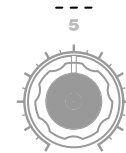

Table 6-1

Frequency [Hz]	Band (CH)		
	Formant shift 0	Formant shift +2	Formant shift -2
39			
50			
65			1 (CH1)
80			2 (CH1)
125	1 (CH1)		3 (CH2)
185	2 (CH1)		4 (CH2)
270	3 (CH2)	1 (CH1)	5 (CH3)
350	4 (CH2)	2 (CH1)	6 (CH3)
430	5 (CH3)	3 (CH2)	7 (CH4)
530	6 (CH3)	4 (CH2)	8 (CH4)
630	7 (CH4)	5 (CH3)	9 (CH5)
780	8 (CH4)	6 (CH3)	10 (CH5)
950	9 (CH5)	7 (CH4)	11 (CH6)
1150	10 (CH5)	8 (CH4)	12 (CH6)
1380	11 (CH6)	9 (CH5)	13 (CH7)
1680	12 (CH6)	10 (CH5)	14 (CH7)
2070	13 (CH7)	11 (CH6)	15 (CH8)
2780	14 (CH7)	12 (CH6)	16 (CH8)
3800	15 (CH8)	13 (CH7)	
5000	16 (CH8)	14 (CH7)	
6400		15 (CH8)	
8100		16 (CH8)	
10510			
12600			

Although the microKORG's editable band-pass filter has eight channels, it internally contains sixteen band-pass filters. These sixteen filters are arranged in pairs (a pair for each channel). Table 6-1 shows how the frequencies adjusted by "FORMANT SHIFT" and "CUTOFF" correspond to the frequencies of the sixteen filters.

VOCODER

MIXER

FILTER

7. FC MOD — VOCODER

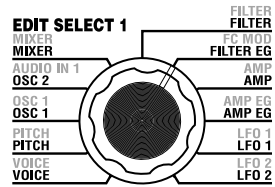

These parameters select the modulation source that will vary the cutoff frequency of the carrier band-pass filter (the synthesis filter), and specify the depth of the modulation. For example if you set the modulation source "SOURCE" (knob 1) to AMP EG (A.EG) and use "INTENSITY" (knob 2) to adjust the depth of the effect, the AMP EG will produce tonal changes.

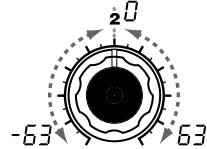
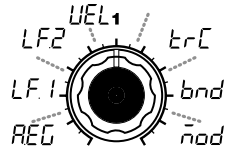

SOURCE [AMP EG, LFO 1, LFO 2, Velocity, KBD Track, Pitch Bend, MOD.Wheel]

Selects the modulation source that will be applied to the carrier band-pass filter "CUTOFF." For example if you select AMP EG (AEG), the Amp EG will be the modulation source.

AMP EG (AEG): AMP EG

LFO 1 (LF1): LFO 1

LFO 2 (LF2): LFO 2

Velocity (VEL):

Velocity (keyboard playing strength)

KBD Track (trC):

Keyboard tracking (keyboard position)

Pitch Bend (bnd):

PITCH wheel

MOD.Wheel (mod):

MOD wheel

INTENSITY [-63..63]

Specifies the depth of the modulation that is applied to the carrier band-pass filter "CUTOFF."

8. AMP — VOCODER

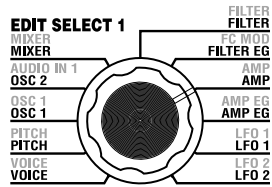

These parameters adjust the volume. "LEVEL" (knob 1) specifies the volume of the internal sound source (OSC 1, NOISE) for the carrier. "KBD TRACK" (knob 4) specifies how keyboard tracking will affect the volume, and "DISTORTION" (knob 3) specifies whether the sound will be distorted.

The "DIRECT LEVEL" (knob 2) specifies the output volume level of the sound that is input from AUDIO IN 1.

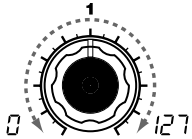

LEVEL [0...127]
Specifies the volume level of the internal tone generator (OSC1, NOISE) for the carrier.

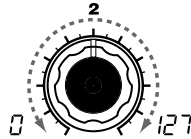

DIRECT LEVEL [0...127]
Specifies the volume level of the audio that is output directly from AUDIO IN 1.

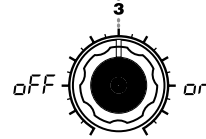

DISTORTION [OFF, ON]
Specifies whether distortion will be applied to the OSC 1, NOISE, and AUDIO IN 2 signal.
OFF (OFF):
Distortion is off
ON (ON):
Distortion is on

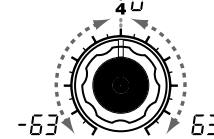

KBD TRACK [-63...63]
Specifies how keyboard tracking will affect the volume. With positive (+) settings, the volume will increase as you play above the note C4 on the keyboard, and will decrease as you play below C4. With negative (-) settings, the volume will decrease as you play above C4 on the keyboard, and will increase as you play below C4.

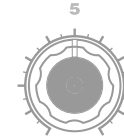

note Keyboard Track operates according to the pitch that is controlled by pitch bend and the "TRANSPOSE" setting. It is not affected by pitch changes produced by vibrato or Virtual Patch.

9. AMP EG — SYNTH/VOCODER

The "9. AMP EG" parameters are the same as for a synth program (→p.28). They specify the shape of the AMP EG, which creates time-variant change in the volume of the internal carrier sound source (OSC 1, NOISE). Virtual Patches are not available when using vocoder programs.

10. LFO 1, 11. LFO 2 — SYNTH/VOCODER

The "10. LFO1" and "11. LFO2" parameters are the same as for a synth program (→p.29). Cyclic change produced by the LFO can apply modulation to the internal carrier sound source (OSC 1, NOISE). Virtual Patches are not available when using vocoder programs.

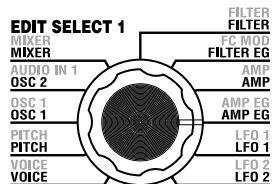

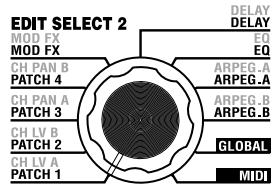

12. CH LEVEL A, 13. CH LEVEL B — VOCODER

These parameters set the level for each of the eight band-pass filter channels (SYNTHESIS FILTER) of the carrier (→p.35). This lets you adjust the output level of the internal carrier sound source (OSC 1, NOISE).

note If desired, you can initialize (127) the level of all band-pass filter channels in a single step. (→p.60)

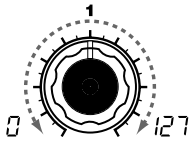

CH 1 LEVEL [0...127]

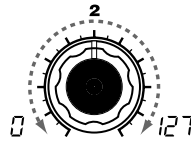

CH 2 LEVEL [0...127]

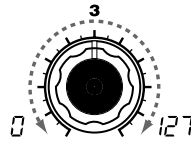

CH 3 LEVEL [0...127]

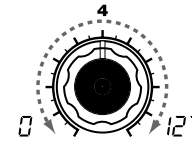

CH 4 LEVEL [0...127]

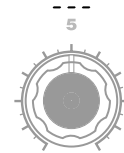

CH 5 LEVEL [0...127]

CH 6 LEVEL [0...127]

CH 7 LEVEL [0...127]

CH 8 LEVEL [0...127]

These parameters set the output level for each of the eight band-pass filter channels of the carrier.

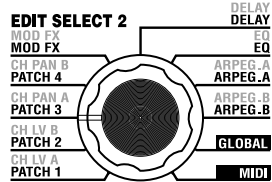

14. CH PAN A, 15. CH PAN B — VOCODER

These parameters set the pan for each of the eight band-pass filter channels (SYNTHESIS FILTER) of the carrier (→p.35).

This lets you adjust the stereo position of the internal carrier sound source (OSC 1, NOISE).

note If desired, you can initialize (center) the pan of all band-pass filter channels in a single step. (→p.60)

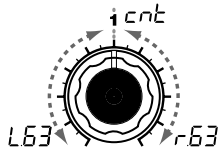

CH 1 PAN [L63...Center...R63]

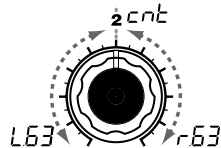

CH 2 PAN [L63...Center...R63]

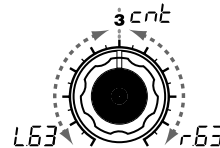

CH 3 PAN [L63...Center...R63]

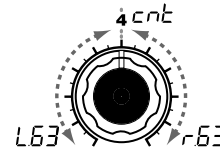

CH 4 PAN [L63...Center...R63]

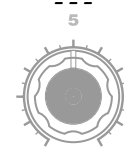

CH 5 PAN [L63...Center...R63]

CH 6 PAN [L63...Center...R63]

CH 7 PAN [L63...Center...R63]

CH 8 PAN [L63...Center...R63]

These parameters set the pan for each of the eight band-pass filter channels of the carrier. L63 (L 63) is far left, Center (c n t) is center, and R63 (r 63) is far right.

Editing the effects and EQ

The microKORG's effect structure

Overview

The output from the amp section of a synth program or vocoder program is sent to the modulation effect (MOD FX) → delay effect (DELAY FX) → equalizer (EQ).

(p.15 Figure 0-1, p.31 Figure v0-1)

You can edit the modulation type effect and the delay effect to create the desired sound in the same way as when editing the filter or amp parameters. You can use effects to modify the sound in a variety of ways. Then you can use the two-band EQ to make final adjustments to the tone, before the sound is sent to the L/R outputs. To bypass any of the effects, set the FX depth (or EQ gain) value to zero.

Modulation-type effect (MOD FX)

Choose one of three effects: Chorus/Flanger, Ensemble, or Phaser.

Delay effect (DELAY FX)

Choose one of three effects: Stereo Delay, Cross Delay, or L/R Delay.

Equalizer (EQ)

This is a two-band EQ.

16. MOD FX — SYNTH/VOCODER

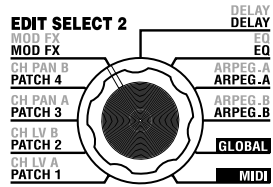

The modulation effect applies various types of cyclic change to the original sound. You can use it to give the sound greater depth, or to produce the impression that multiple sound sources are being heard simultaneously. You can also use LFO modulation to simulate cyclic changes produced by a performer on an instrument, such as breathing on a wind instrument or the strings of a string instrument. "TYPE" (knob 1) selects the type of modulation effect, "EFFECT DEPTH" (knob 3) sets the depth and the amount of feedback for the modulation effect. "LFO SPEED" (knob 2) sets the speed of modulation.

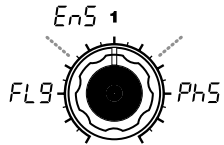

TYPE [Flanger/Chorus, Ensemble, Phaser]
Selects the effect type.

Flanger/Chorus (FLG):

This effect modulates the delay time of the input signal to add depth and warmth to the sound. Increasing the "EFFECT DEPTH" value will produce a flanger effect.

Ensemble (EnS):

This effect uses multiple chorus units to add three-dimensional depth and spaciousness to the sound.

Phaser (PhS):

This effect continuously modulates the phase of the sound, creating motion within the sound, a sweeping and twisting sensation.

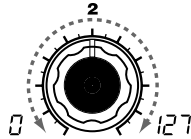

LFO SPEED [0...127]
Specifies the speed of the modulation effect LFO.

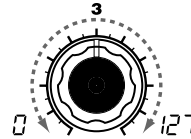

EFFECT DEPTH [0...127]
Specifies the modulation depth and amount of feedback. Increasing this value will deepen the modulation effect and also increase the amount of feedback. If you do not wish to apply the effect, set this to 0.

 Excessively high settings of this parameter may cause the output to be distorted.



17. DELAY — SYNTH/VOCODER

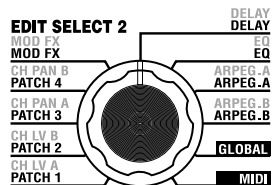

The delay effect simulates the delays that occur when sound travels through air.

"TYPE" (knob 1) selects the type of delay effect. "DELAY DEPTH" (knob 4) sets the delay depth and the amount of feedback. "TEMPO SYNC" (knob 2) specifies whether the delay time will be synchronized to the tempo set by the arpeggiator or by an external MIDI clock.

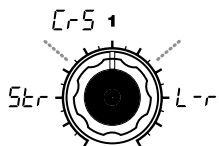

TYPE [Stereo Delay, Cross Delay, L/R Delay]
Selects the delay type.

Stereo Delay (Str):
This is a stereo delay. (→Figure 17-1)

Cross Delay (CrS):
This is a stereo delay where the left and right channels of feedback are interchanged. In a Layer program, it is effective to set the pan of the two timbres to left and right respectively. (→Figure 17-2)

L/R Delay (L-r):
This is a delay where the delay sound is output to left and right alternately. (→Figure 17-3)

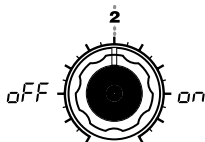

TEMPO SYNC [OFF, ON]
Specifies whether the delay time will be synchronized to the tempo.
OFF (OFF):
Delay off (not synchronized). The delay will operate according to the "DELAY TIME" value you specify.

ON (ON):
Delay on (synchronized). The delay will synchronize to the ARPEG.A "TEMPO" setting or to MIDI Clock data from an external device.

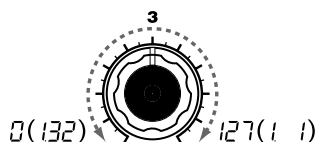

DELAY TIME [0...127]
Sets the delay time.
This parameter is available only if "TEMPO SYNC" is OFF.

SYNC NOTE [1.32...1.1]
Specifies the ratio of the delay time relative to the ARPEG.A "TEMPO" value. (→p.65)

This parameter is available only if "TEMPO SYNC" is ON.

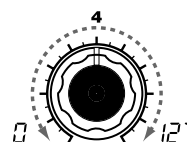

DELAY DEPTH [0...127]
Specifies the delay depth and feedback amount. Increasing this value will make the delay louder and will also increase the amount of feedback.

If you do not wish to apply a delay, set this to 0.

⚠ Excessively high settings of this parameter may cause the output to be distorted.

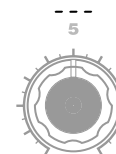

Figure 17-1

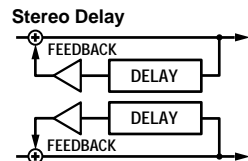

Figure 17-2

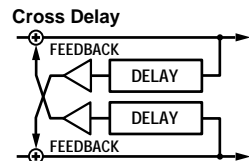
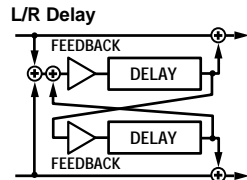

Figure 17-3



MOD FX - EQ

MOD

DELAY

18. EQ — SYNTH/VOCODER

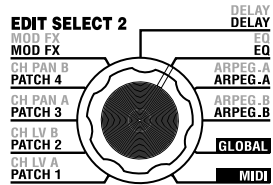

This is a two-band equalizer. Use EQ FREQ (knobs 1 and 3) to specify the frequency that you want to adjust, and use knobs 2 and 4 to adjust the gain of each frequency band.

⚠ Excessively raising the equalizer gain parameters may cause the output to be distorted.

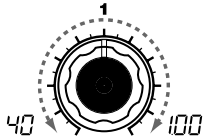

LOW EQ FREQ. [40Hz...1.00kHz]
Sets the frequency of the low-range equalizer.

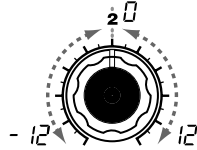

LOW EQ GAIN [-12...12]
Sets the amount of boost or cut for the low-range equalizer.

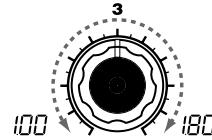

HI EQ FREQ. [1.00kHz...18.0kHz]
Sets the frequency of the high-range equalizer.

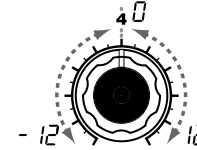

HI EQ GAIN [-12...12]
Sets the amount of boost or cut for equalizer.

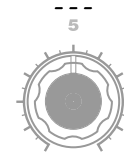

Editing the arpeggiator

The structure of arpeggiator

Overview

The microKORG's arpeggiator provides six arpeggio types. You can adjust the duration (gate time) and spacing of the notes played by the arpeggiator. The arpeggiator settings are adjusted by the ARPEG.A and ARPEG.B parameters. Each of the up to eight steps produced by the ARPEG.A and ARPEG.B settings can be switched on/off using the "step arpeggiator," for even more performance possibilities. (Refer to page 11 for more information about using the step arpeggiator.)

Selecting the timbre(s) that will be played by the arpeggiator

In a synth program that uses two timbres (Layer), you can select the timbre(s) that will be sounded by the arpeggiator. This is specified by ARPEG.B "TARGET TIMBRE" (knob 5). You can arpeggiate both timbres, or only timbre 1 or 2.

Synchronizing the rate of LFO 1/2 or the delay time of the delay effect to the arpeggiator tempo

By synchronizing the LFO 1/2 rate to the tempo of the arpeggio, you can apply modulation that is synchronized to the tempo. You can also specify the time parameter of the delay effect to be a ratio of the tempo, so that the delay time will remain appropriate even if you change the tempo of the arpeggio. This is particularly convenient for live performances. (p.65)

Since the microKORG's arpeggiator can be synchronized to an external MIDI sequencer, you can control the LFO 1/2 rate or the delay time from an external MIDI sequencer. (p.50)

19. ARPEG. A — SYNTH/VOCODER

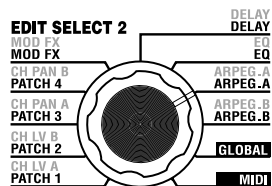

Here you can make various arpeggio-related settings. "TYPE" (knob 4) selects the arpeggio type. "TEMPO" sets the tempo of the arpeggiator, and "RESOLUTION" (knob 2) specifies the spacing of the notes relative to the tempo. "GATE" (knob 3) sets the duration of the arpeggiated notes, and "RANGE" (knob 5) specifies the range of pitch (one to four octaves, in one-octave steps) in which the arpeggio will be played. You may hold down as many keys as you like to create an arpeggiated program.

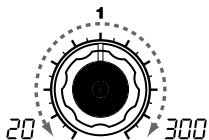

TEMPO [20...300]
Specifies the tempo of the arpeggio. Increasing this value will speed up the arpeggio tempo.

note If MIDI "CLOCK" is set to External, or if it is set to Auto when there is an external input, this setting will be ignored and the arpeggiator will synchronize to the external MIDI Clock.

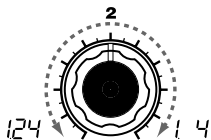

RESOLUTION [1/24...1/4]
Specifies the resolution (spacing of the notes) relative to the tempo specified by "TEMPO." (→p.65)

1/24 (1 24):
The arpeggio will be played as sixteenth note triplets of the specified tempo.

1/16 (1 16):
The arpeggio will be played as sixteenth notes of the specified tempo.

1/12 (1 12):
The arpeggio will be played as eighth note triplets of the specified tempo.

1/8 (1 8):
The arpeggio will be played as eighth notes of the specified tempo.

1/6 (1 6):
The arpeggio will be played as quarter note triplets of the specified tempo.

1/4 (1 4):
The arpeggio will be played as quarter notes of the specified tempo.

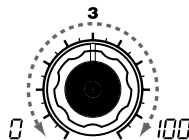

GATE [0...100]
Specifies the duration (gate time) of the arpeggiated notes, as a percentage (%).
With a setting of 0, each note will be extremely short.
With set to 100, each note will continue playing until the next step.

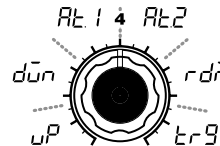

TYPE [Up, Down, Alternate 1, Alternate 2, Random, Trigger]
Selects the arpeggio type. (→Figure 19-1)

Up (uP):
Notes will be played consecutively from low to high pitches.

Down (dūn):
Notes will be played consecutively from high to low pitches.

Alternate 1 (Alt 1):
Up and Down will be alternated. (The highest and lowest notes will be sounded once.)

Alternate 2 (Alt 2):
Up and Down will be alternated. (The highest and lowest notes will be sounded twice.)

Random (r-dn):
Notes will be played randomly.

Trigger (trg):
The notes you are holding down will be played simultaneously at the tempo and "RESOLUTION" timing. The "RANGE" setting will be ignored.

note If you are holding down more notes (▶)

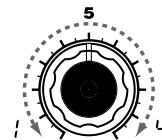

RANGE [1...4]
Specifies the range of octaves over which the arpeggio will be played.

Figure 19-1

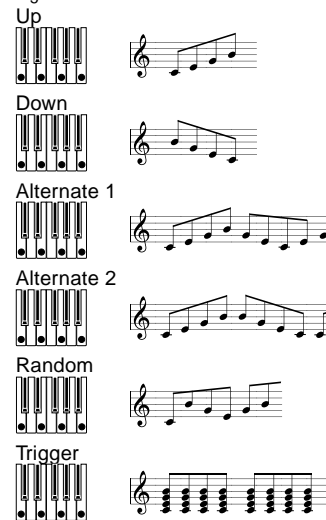

(▶) than the maximum polyphony of the timbre, the lowest pitches you are holding down will be played, up to the maximum polyphony.

20. ARPEG. B — SYNTH/VOCODER

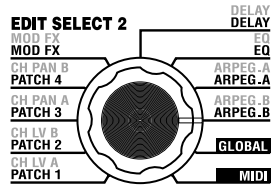

Here you can make additional arpeggio-related settings. "LAST STEP" (knob 4) sets the number of steps in the arpeggio. "LATCH" (knob 1) specifies how the arpeggiator will operate when you release the keyboard, "SWING" (knob 2) adjusts the sense of swing, and "KEY SYNC" (knob 3) specifies how the arpeggiator will be synchronized to the keyboard. In addition, "TARGET TIMBRE" (knob 5) specifies which timbre(s) of a Layer synth program will be sounded by the arpeggiator.

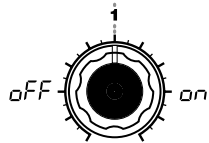

LATCH [OFF, ON]

Specifies how the arpeggiator will operate when you take your hand off of the keyboard.

OFF (OFF):

The arpeggiator will stop playing when you take your hand off of the keyboard.

ON (ON):

The arpeggiator will continue playing even if you take your hand off of the keyboard.

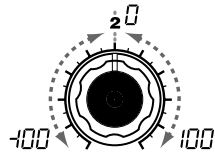

SWING [-100...100]

Specifies the percentage (%) by which even-numbered notes of the arpeggio will be shifted in timing relative to the first note. (→Figure 20-1)

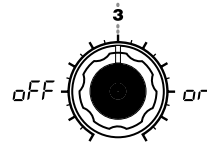

KEY SYNC [OFF, ON]

Specifies whether the arpeggiator will be synchronized to the keyboard.

If this is ON, the arpeggiator will always start from the beginning of the arpeggio pattern when you play the keyboard. If you are performing together with other instruments, you can use this function to ensure that the arpeggio pattern is aligned with the beginning of the measure.

OFF (OFF):

Sync off (not synchronized).

ON (ON):

Sync on (synchronized).

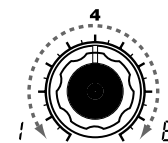

LAST STEP [1...8]

Specifies the number of valid steps (maximum number of steps) for the step arpeggiator.

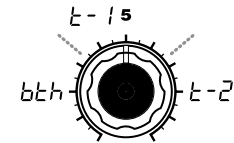

TARGET TIMBRE

[Both, Timbre 1, Timbre 2]
Selects the timbre(s) that will be sounded by the arpeggiator. This can be set only for a Layer program.

Both (b-t-h):

Both timbres will be sounded by the arpeggiator.

Timbre 1 (t-1):

Only timbre 1 will be sounded by the arpeggiator.

Timbre 2 (t-2):

Only timbre 2 will be sounded by the arpeggiator.

Figure 20-1

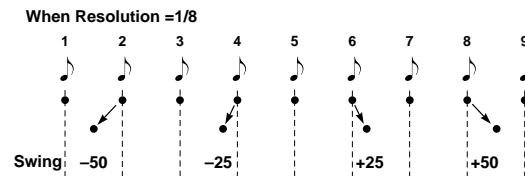

Overall settings (GLOBAL)

GLOBAL structure

.....

Overview

The GLOBAL section lets you can make overall settings for the microKORG.

For example, although it is possible to individually adjust the pitch of each synth or vocoder program, you can use the GLOBAL pitch settings ("MASTER TUNE" and "MASTER TRANSPOSE") to adjust the pitch of all programs. When you are playing the microKORG together with other instruments, use "MASTER TUNE" to match the pitch. If you want to transpose the pitch of the song you are playing, you can adjust "MASTER TRANSPOSE." In cases such as when you use multiple programs in a single song, it is convenient to simply adjust the GLOBAL setting instead of adjusting the pitch of each individual program.

Here you can also adjust the way in which your keyboard playing dynamics will affect the velocity. If you want your playing dynamics to affect parameters such as volume, set "VELOCITY CURVE" to Curve (\underline{C} \overline{r} \underline{L}). Alternatively, you can specify a constant velocity so that volume etc. will not be affected by your playing dynamics.

In addition, GLOBAL settings let you specify the MIDI IN/OUT routing within the microKORG, or specify whether the signal input from AUDIO IN will be passed to the output without modification.

21. GLOBAL

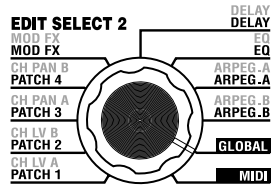

Here you can make overall settings for the microKORG. "MASTER TUNE" (knob 1) and "MASTER TRANSPOSE" (knob 2) adjust the pitch. "VELOCITY CURVE" (knob 3) specifies the velocity, "POSITION" (knob 4) specifies the MIDI IN/OUT routing, and "AUDIO IN THRU" (knob 5) specifies whether the input signal from AUDIO IN will be output directly.

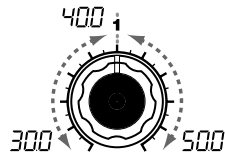

MASTER TUNE [30.0...50.0]
Adjusts the overall pitch in 0.1 Hz steps over a range of 430.0 Hz to 450.0 Hz, in terms of A4 as the reference pitch. (The highest digit "4" is not displayed.)
Use this when you need to tune the pitch of the microKORG to other instruments.

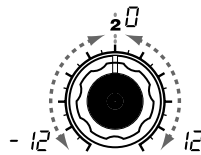

MASTER TRANSPOSE [-12...12]
Adjusts the overall pitch in steps of a semitone (100 cents) over a range of one octave upward or downward.
Use this when you wish to transpose to suit the song you are playing.

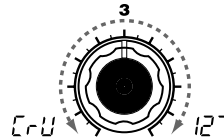

VELOCITY CURVE [Curve, 1...127]
Selects how velocity (keyboard playing dynamics) will affect volume and tone.
Use the setting that is appropriate for your situation.
Curve (CrV):
The normal curve. (→Figure 21-1)
1...127:
The fixed velocity you specify here will be output regardless of how strongly you play the keyboard.

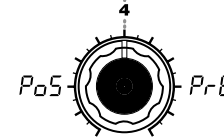

POSITION [Post KBD, Pre TG]
Specifies the internal MIDI IN/OUT routing within the microKORG. This setting will affect the way in which MIDI data is transmitted and received, and how the arpeggiator data is handled.
Post KBD (P05):
In this position, incoming MIDI data will be sent to the timbres without being affected by the global or front panel transpose controls, and will not trigger the arpeggiator. Data produced by the keyboard will be converted according to the internal settings, routed through the arpeggiator (arpeggiator notes are sent as MIDI data), and then sent to the MIDI OUT connector. (→Figure 21-2)

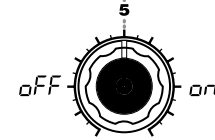

AUDIO IN THRU [OFF, ON]
Specifies whether the signal input from AUDIO IN will be output directly.
OFF (OFF):
The signal will not be output.
ON (ON):
The signal will be output.
⚠ This setting is not memorized by the Write operation. When the power is turned on, it will always be turned OFF. While you are editing, ORIGINAL VALUE will always remain lit.

Figure 21-1

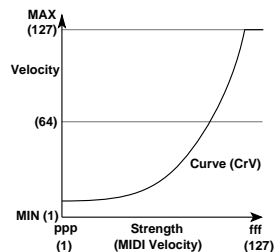

Figure 21-2

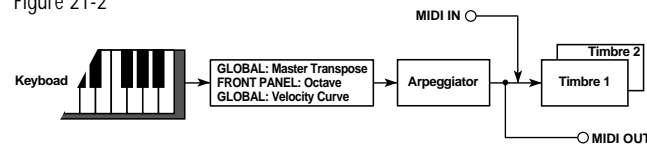
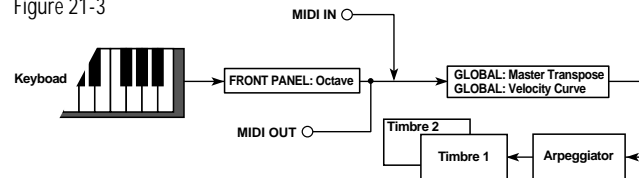

Figure 21-3



Pre TG (PrE):
Incoming MIDI data will be affected by by the global settings, and will act as trigger notes for the arpeggiator. Data produced by the keyboard will be sent to the MIDI OUT connector without being (↗)

(↗) affected by any setting other than OCTAVE SHIFT (arpeggiator notes are NOT sent via MIDI). (→Figure 21-3)

Using the microKORG with other MIDI devices (MIDI)

Overview

Here you can make MIDI-related settings for the microKORG.

MIDI stands for Musical Instrument Digital Interface, and is a world-wide standard for exchanging various types of musical data between electronic musical instruments and computers. When MIDI cables are used to connect two or more MIDI devices, performance data can be exchanged between the devices, even if they were made by different manufacturers.

The microKORG lets you assign control change numbers to the major parameters that affect the sound, and control these parameters from an external MIDI sequencer while you play the tone generator. You can also operate the assigned knobs 1-5 or keys to transmit these control changes to control an external MIDI device. You can synchronize the microKORG's arpeggiator, LFO rate, or the delay time of the delay effect to the MIDI Clock of an external MIDI sequencer.

Connecting MIDI devices/computers

Controlling an external MIDI tone generator from the microKORG

When you wish to use the microKORG's keyboard, controllers, and arpeggiator etc. to play an external MIDI tone generator, use a MIDI cable to connect the microKORG's MIDI OUT connector to the MIDI IN connector of the external MIDI tone generator.

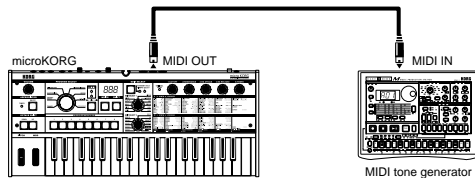

MIDI on the microKORG

Controlling the microKORG's tone generator from an external MIDI device

When you wish to play or control the microKORG's tone generator from an external MIDI keyboard or sequencer etc., use a MIDI cable to connect the MIDI OUT connector of the external MIDI device to the MIDI IN connector of the microKORG.

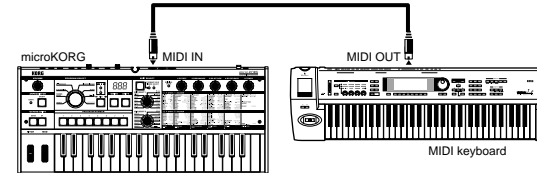

Controlling two or more external MIDI tone generators from the microKORG

You can use the MIDI THRU connector to simultaneously control multiple MIDI devices. (This type of connection should be used to connect no more than three devices. If you wish to connect a larger number of MIDI devices, we recommend that you use a MIDI patch bay as shown in the second diagram below.)

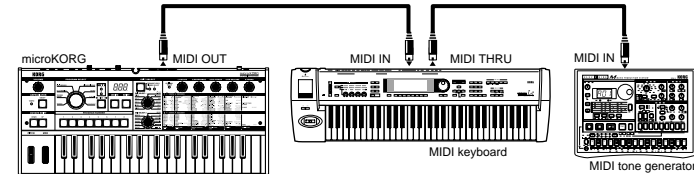

You can also use a MIDI patch bay to control multiple MIDI devices.

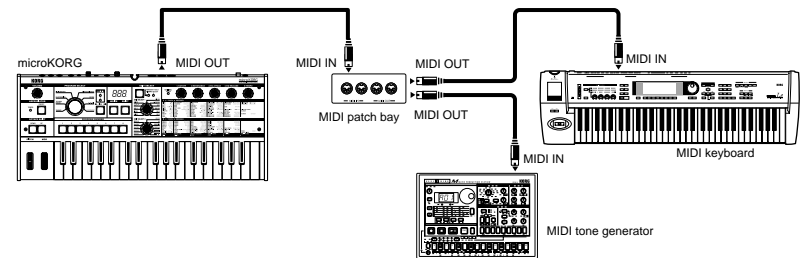

MIDI on the microKORG

Connecting an external MIDI sequencer or computer etc.

You can play the microKORG's keyboard and record your performance on an external MIDI sequencer/computer (connected via a MIDI interface), and then play back the recorded performance to sound the microKORG's tone generator (i.e., using the microKORG as an input keyboard and MIDI tone generator). To do this, connect the MIDI OUT and MIDI IN connectors of the microKORG and your external MIDI sequencer/computer to each other.

⚠ Some USB-MIDI interface devices may not be able to transmit/receive the microKORG's MIDI exclusive messages.

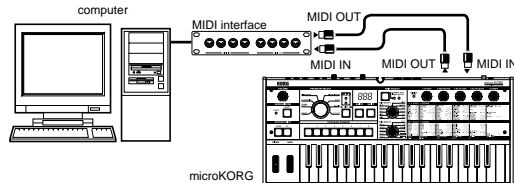

MIDI-related settings

MIDI channel setting

In order to exchange data with a connected external MIDI device, you must set the microKORG's MIDI channel to match the MIDI channel of the external MIDI device.

- 1 Set the MIDI channel of the microKORG.
Set the EDIT SELECT 2 dial to the **MIDI** position, and use knob 1 ("MIDI CH") to set the MIDI channel. (→p.51)
- 2 Set the MIDI channel of the connected external MIDI device.
(→For information on setting the MIDI channel of the external MIDI device, refer to the owner's manual of that device.)

GLOBAL "POSITION" setting

The microKORG's GLOBAL "POSITION" lets you specify how MIDI IN/OUT will be internally routed. This will affect how the MIDI data will be affected by the

"MASTER TRANSPOSE," "VELOCITY CURVE," OCTAVE SHIFT, and arpeggiator settings. (→p.47)

- Normally when controlling an external MIDI tone generator from the microKORG, you will set "POSITION" to Post KBD (P₀₅). The various settings listed above will affect the MIDI data that is transmitted.
The received data will be processed as "MASTER TRANSPOSE": 0, "VELOCITY CURVE": Curve (C_{rlj}), and OCTAVE SHIFT: 0.
- Normally when controlling the microKORG's tone generator from an external MIDI device, you will set "POSITION" to Pre TG (P_{re}). The various settings listed above will affect the MIDI data that is received (with the exception of "OCTAVE SHIFT," which will be processed as 0).
The transmitted data will be processed as "MASTER TRANSPOSE": 0 and "VELOCITY CURVE": Curve (C_{rlj}).

SHIFT function "MIDI FILTER" settings

You can specify whether program change, pitch bend, control change, and system exclusive messages will be transmitted or received. (→p.60)

SHIFT function "CONTROL CHANGE" settings

You can assign control change numbers to the major parameters that affect the sound, and use an external MIDI device to perform the same operations as when the knobs and keys of the microKORG are operated. Conversely, you can operate the microKORG's knobs and keys to control an external MIDI device. (→p.61)

MIDI "LOCAL" setting when connecting an external MIDI sequencer or computer

If notes are sounding doubled when the microKORG is connected to an external MIDI sequencer or computer, turn the Local setting off (MIDI "LOCAL" OFF). (→p.51)

If the microKORG is connected to an external MIDI sequencer or computer, and the Echo Back setting of the external MIDI sequencer or computer is turned on while the microKORG's Local Control setting is also on, the performance data generated when you play the microKORG's keyboard will be sent to the external MIDI sequencer, and will also be echoed-back to sound the microKORG's tone generator

MIDI on the microKORG

a second time. To prevent each note from being sounded twice, once directly from the keyboard and once from the echoed-back note, you must turn the microKORG's Local Control setting off.

Recording the MIDI output from the microKORG's arpeggiator onto an external MIDI sequencer or computer

Connect the microKORG's MIDI OUT connector to the MIDI IN connector of your external MIDI sequencer / computer, and connect the microKORG's MIDI IN connector to the MIDI OUT connector of your external MIDI sequencer / computer. (→p.49)

Then turn the microKORG's Local Control off (MIDI "LOCAL" OFF), and turn on the echo back setting of your external MIDI sequencer / computer.

Recording the note data from the arpeggiator onto an external MIDI sequencer / computer

Set the microKORG's GLOBAL "POSITION" to Post KBD (P□5).

Turn on the microKORG's arpeggiator, play the keyboard, and record the note data on your external MIDI sequencer / computer. If the GLOBAL "POSITION" is set to Post KBD, the MIDI note data produced by the arpeggiator will be output from the microKORG, and recorded. (→p.47)

Turn the microKORG's arpeggiator off during playback.

Recording only the arpeggio-triggering notes on an external MIDI sequencer / computer, and running the microKORG's arpeggiator during playback

Set the microKORG's GLOBAL "POSITION" to Pre TG (P□E).

Turn on the microKORG's arpeggiator, play the keyboard, and record the note data on your external MIDI sequencer / computer. If GLOBAL "POSITION" is set to Pre TG (P□E), only the notes you actually play on the keyboard will be transmitted as MIDI data, and the MIDI note data generated by the arpeggiator will not be transmitted. However, the MIDI note data echoed back from the external MIDI sequencer / computer (whose echo back setting is turned on) will trigger the microKORG's arpeggiator, producing an arpeggio. (→p.47)

Turn the microKORG's arpeggiator on during playback.

Synchronizing the arpeggiator

The MIDI "CLOCK" setting specifies whether the microKORG's arpeggiator will be the master (the controlling device) or slave (the controlled device).

note For information on synchronization-related settings of your external MIDI device, refer to the manual of your device.

Using the microKORG as master and the external MIDI device as slave

Connect the microKORG's MIDI OUT connector to the external MIDI device's MIDI IN connector (→p.48). If you set MIDI "CLOCK" to Internal (□□E), the microKORG will be the master, and will transmit MIDI timing clock messages.

Make settings on your external MIDI device so it will receive external MIDI clock data. The external MIDI device (sequencer, rhythm machine, etc.) will operate at the tempo specified by the ARPEG.A "TEMPO" setting.

Using the external MIDI device as master and the microKORG as slave

Connect the microKORG's MIDI IN connector to the external MIDI device's MIDI OUT connector (→p.48). If you set MIDI "CLOCK" to External (□□E), the microKORG will be the slave.

The microKORG's arpeggiator will operate at the tempo of the external MIDI device (sequencer, rhythm machine, etc.).

note If you set MIDI "CLOCK" to Auto (□□E), the microKORG will automatically function using the External setting if MIDI clock is being received from an external MIDI device connected to the MIDI IN connector. Otherwise, the microKORG will function using the Internal setting.

22. MIDI

Here you can make MIDI-related settings for the microKORG.

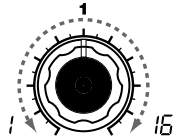
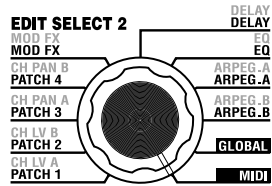

MIDI CH [1...16]
Specifies the MIDI channel.
When you wish to transmit program changes or system exclusive messages via MIDI, set the global MIDI channel to match the MIDI channel of the connected MIDI device.

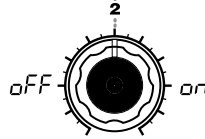

LOCAL [OFF, ON]
Switch the local on/off setting.
OFF (OFF):
With this setting, controllers such as the keyboard and modulation wheel will be internally disconnected from the tone generator section.
This setting prevents notes from being sounded in duplicate when a sequencer is connected and the performance data is echoed back from the sequencer. (Echo back is when the performance data transmitted by playing the microKORG is re-transmitted back to the microKORG from the sequencer.)

ON (ON):
Select this setting when you are using the microKORG by itself.

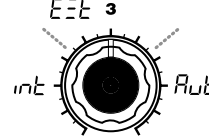

CLOCK [Internal, External, Auto]
Specifies how the microKORG will synchronize with a connected external MIDI device (sequencer, rhythm machine, etc.). If the LFO 1/2 or DELAY "TEMPO SYNC" is ON, the LFO rate and delay time will also synchronize in the same way as the arpeggiator.

Internal (INT):
The arpeggiator will be determined by the internal clock (specified by "TEMPO"). Select this setting if you are using the microKORG by itself, or if you are using the microKORG as the master (controlling device) so that an external MIDI device will synchronize to the MIDI clock messages from the microKORG.

External (EXT):
The microKORG's arpeggiator will synchronize to the MIDI clock messages received from an external MIDI device connected to the MIDI IN connector. (↗)



(↗)
Auto (RUL):
The microKORG will automatically function using the External setting if MIDI clock messages are being received from an external MIDI device connected to the MIDI IN connector. Normally it will function using the Internal setting.

note When making settings for synchronizing external MIDI devices, refer to the owner's manuals for the devices you are using.



Messages transmitted and received by the microKORG

❑ MIDI channels

MIDI uses sixteen channels (1-16). MIDI messages can be transmitted and received when the channel of the receiving device matches the channel of the transmitting device.

MIDI messages such as note-on/off and pitch bend are transmitted and received on the MIDI channel specified by the MIDI "MIDI CH" setting.

❑ Note-on/off

Note-on [9n, kk, vv], **Note-off** [8n, kk, vv]

(n: channel, kk: note number, vv: velocity)

When you play the keyboard of the microKORG, note-on/off messages are transmitted. The note-off velocity is transmitted at a fixed 64, but is not received. If the GLOBAL "POSITION" is Post KBD (P05), note-on/off messages will be transmitted by the arpeggiator when it is running.

❑ Program change

Program change [Cn, pp]

(n: channel, pp: program number)

When you switch programs, a program change message with a program number for the corresponding program 1-128 (A.11-b.88) will be transmitted. (→Voice Name List) If you want program changes to be transmitted and received, set the SHIFT function "MIDI FILTER" to PROGRAM CHANGE Enable (P-E). If this is set to Disable (P-d), program change messages will not be transmitted or received.

🚫 The microKORG does not transmit or receive bank select messages ([Bn, 00, mm], [Bn, 20, bb]).

❑ Pitch bend

Pitch bend change [En, bb, mm]

(n: channel, bb: lower digits of value, mm: upper digits of value)

When pitch bend change messages are received, a pitch bend will occur according to the PITCH "BEND RANGE" value. Pitch bend can also be used in a Virtual Patch for a synth program, or as an FC MOD modulation source for a vocoder program. In this case, the message will act as a modulation source where mm=64, bb=00 will be 0 (center value) for the range of -127 - +127. (This message is received on the timbre channel.)

When you move the **PITCH** wheel on the microKORG, pitch bend change messages are transmitted on the MIDI channel ("MIDI CH").

If you want pitch bend changes to be transmitted and received, set the SHIFT function "MIDI FILTER" to PITCH BEND Enable (b-E). If this is set to Disable (b-d), pitch bend change messages will not be transmitted or received.

❑ Control changes

Control changes [Bn, cc, vv]

(n: channel, cc: control change no., vv: value)

When you use knobs 1 -5 to edit certain parameters, or when you operate certain keys or the **MOD** wheel, the assigned control change will be transmitted. Conversely, when control change numbers corresponding to the knob 1 -5 settings are received, the corresponding controller or parameter will be controlled.

If you want control changes to be transmitted and received, set the SHIFT function "MIDI FILTER" to CONTROL CHANGE Enable (C-E). If this is set to Disable (C-d), control change messages will not be transmitted or received.

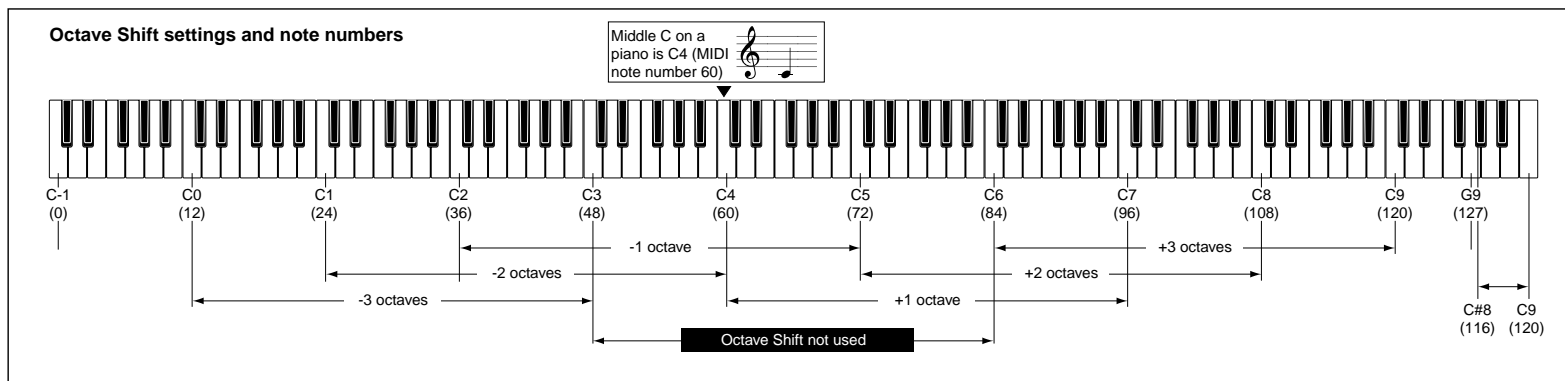

Messages transmitted and received by the microKORG

- **Modulation depth (CC#01) [Bn, 01, vv]**

When a modulation depth message is received, the LFO2 vibrato depth will change according to the value specified for PITCH "VIBRATO INT." If the value of the received message is the maximum value (127), vibrato will be applied over the full pitch range specified by "VIBRATO INT." If the value of the received message is 0, no vibrato will apply.

When you move the microKORG's MOD wheel, modulation depth messages are transmitted on the MIDI channel ("MIDI CH").

- **Volume (CC#07) [Bn, 07, vv]**

If you assign control change (CC#07 - volume) to AMP "LEVEL," volume messages can be received to control the volume.

- **Panpot (CC#10) [Bn, 0A, vv]**

If you assign control change (CC#10 - pan) to AMP "PANPOT," pan messages can be received to control the stereo position of the sound.

Assigning control changes to knobs and keys

You can use the SHIFT function "CONTROL CHANGE" to assign a control change in the range of CC#00-CC#95 to principal parameters that correspond to panel knobs and keys. When you operate the assigned knob or key, the corresponding control change will be transmitted. If the Performance Edit function is enabled, the control change for the corresponding parameter will be transmitted.

When control changes are received from an external device, the microKORG will behave according to the value of the control change, just as when the corresponding knob or key is operated (→p.56 "Control change assignments for the microKORG's knobs and keys").

In addition, when you use the front panel **TIMBRE SELECT** key to switch timbres, a message (Timbre Select) indicating which timbre is selected will be transmitted. When the microKORG receives a Timbre Select message, it will switch timbres according to the value of the message. (0: Timbre 1, 1: Timbre 1&2 (Sync), 2-127: Timbre 2).

You can use the SHIFT function "CONTROL CHANGE" TimbSelect to assign a control change to Timbre Select as well.

Sync control

The first-played note-on will sync a LFO whose "KEY SYNC" = Timbre (L, rr).

However in order to distinguish manually played note-on/off's from those that are repeated automatically by the arpeggiator, the microKORG's arpeggiator will transmit a Sync Control message at the time of note-on (when GLOBAL "POSITION" is Post KBD (P□5)).

A control change message is used for this Sync Control message as specified by Shift function "Control Change."

By using Sync Control to apply sync to a LFO, you can cause each arpeggiated note to advance the random LFO by one step.

Silencing all notes of a given channel

- **All note off (CC#123) [Bn, 7B, 00] (value is 00)**

When an All Note Off message is received, all currently-sounding notes of that channel will be turned off. Some sound may linger due to the envelope settings.

- **All sound off (CC#120) [Bn, 78, 00] (value is 00)**

When an All Sound Off message is received, all notes currently sounding on that channel will be silenced. While All Note Off allows the decay of a note to continue, the All Sound Off will silence the sound immediately.

However, this message is intended for use in emergencies, and is not for use during a performance.

Resetting all controllers of a given channel

- **Reset all controllers (CC#121) [Bn, 79, 00] (value is 00)**

When a Reset All Controllers message is received, all controller values currently operating on that channel will be reset. Some parameters assigned using Virtual Patch will not be reset.

Parameters transmitted and received via NRPN

Front panel knobs and keys other than the controls listed above are assigned NRPN (Non Registered Parameter No.). NRPN messages can be used freely by any musical instrument manufacturer or model.

NRPN editing is performed using the following procedure.

- 1 Use NRPN MSB (CC#99) [Bn, 63, mm] and NRPN LSB (CC#98) [Bn, 62, rr] (n: channel, mm, rr: parameter no. upper and lower bytes) to select the parameter.
- 2 Use data entry MSB (CC#6) [Bn, 06, mm] (n: channel, mm: parameter value) to specify the value.

note On the microKORG, only data entry MSB is used.

Controlling the arpeggiator

When arpeggiator settings are modified by the front panel keys or knobs, the following NRPN messages are transmitted. When these NRPN messages are received, the corresponding arpeggiator settings will change accordingly. These messages are transmitted and received on the MIDI channel ("MIDI CH"). For the correspondence between the values of the message and the values of the microKORG parameter, refer to the table.

- **ON/OFF:** [Bn, 63, 00, Bn, 62, 02, Bn, 06, mm]
- **RANGE:** [Bn, 63, 00, Bn, 62, 03, Bn, 06, mm]
- **LATCH:** [Bn, 63, 00, Bn, 62, 04, Bn, 06, mm]
- **TYPE:** [Bn, 63, 00, Bn, 62, 07, Bn, 06, mm]
- **GATE:** [Bn, 63, 00, Bn, 62, 0A, Bn, 06, mm] (n: channel, mm: parameter value)

Messages transmitted and received by the microKORG

	MSB (Hex)	LSB (Hex)	Value (transmitted)	Value (received)
ON/OFF	00(00)	02(02)	0: OFF, 127: ON	0...63: OFF, 64...127: ON
RANGE	00(00)	03(03)	0: 1 Octave, 1: 2 Octave, 2: 3 Octave, 3: 4 Octave	0: 1 Octave, 1: 2 Octave, 2: 3 Octave, 3...127: 4 Octave
LATCH	00(00)	04(04)	0: OFF, 127: ON	0...63: OFF, 64...127: ON
TYPE	00(00)	07(07)	0: Up, 26: Down, 51: Alt1, 77: Alt2, 102: Random, 127: Trigger	0...21: Up, 22..42: Down, 43..63: Alt1, 64..85: Alt2, 86...106: Random, 107...127: Trigger
GATE	00(00)	10(0A)	Refer to separate table (GATE values)	Refer to separate table (GATE values)

GATE values

Value (transmitted, received)	Gate Time [%]	Value (transmitted, received)	Gate Time [%]	Value (transmitted, received)	Gate Time [%]	Value (transmitted, received)	Gate Time [%]	Value (transmitted, received)	Gate Time [%]
0, 1	000	27	021	54	042	80, 81	063	107	084
2	001	28, 29	022	55	043	82	064	108	085
3	002	30	023	56, 57	044	83	065	109, 110	086
4, 5	003	31	024	58	045	84	066	111	087
6	004	32	025	59	046	85, 86	067	112	088
7	005	33, 34	026	60	047	87	068	113, 114	089
8	006	35	027	61, 62	048	88	069	115	090
9, 10	007	36	028	63	049	89	070	116	091
11	008	37, 38	029	64	050	90, 91	071	117	092
12	009	39	030	65	051	92	072	118, 119	093
13	010	40	031	66, 67	052	93	073	120	094
14, 15	011	41	032	68	053	94, 95	074	121	095
16	012	42, 43	033	69	054	96	075	122	096
17	013	44	034	70	055	97	076	123, 124	097
18, 19	014	45	035	71, 72	056	98	077	125	098
20	015	46	036	73	057	99, 100	078	126	099
21	016	47, 48	037	74	058	101	079	127	100
22	017	49	038	75, 76	059	102	080		
23, 24	018	50	039	77	060	103	081		
25	019	51	040	78	061	104, 105	082		
26	020	52, 53	041	79	062	106	083		

For example if you want to switch the arpeggiator on/off from an external MIDI sequencer, make the following settings.

Off: CC#99: 0, CC#98: 2, CC#6: 0...63 On: CC#99: 0, CC#98: 2, CC#6: 64...127

Other controls

Panel knobs and keys other than the arpeggiator transmit and receive the following NRPN messages. These messages are transmitted and received on the MIDI channel ("MIDI CH"). For the correspondence between the values of the message and the values of the microKORG parameter, refer to the table.

Controlling the VIRTUAL PATCH 1-4 SOURCE

- PATCH 1 SOURCE: [Bn, 63, 04, Bn, 62, 00, Bn, 06, mm]
 - PATCH 2 SOURCE: [Bn, 63, 04, Bn, 62, 01, Bn, 06, mm]
 - PATCH 3 SOURCE: [Bn, 63, 04, Bn, 62, 02, Bn, 06, mm]
 - PATCH 4 SOURCE: [Bn, 63, 04, Bn, 62, 03, Bn, 06, mm]
- (n: channel, mm: parameter value)

Controlling the VIRTUAL PATCH 1-4 DESTINATION

- PATCH1 DESTINATION: [Bn, 63, 04, Bn, 62, 08, Bn, 06, mm]
 - PATCH2 DESTINATION: [Bn, 63, 04, Bn, 62, 09, Bn, 06, mm]
 - PATCH3 DESTINATION: [Bn, 63, 04, Bn, 62, 0A, Bn, 06, mm]
 - PATCH4 DESTINATION: [Bn, 63, 04, Bn, 62, 0B, Bn, 06, mm]
- (n: channel, mm: parameter value)

Controlling the FC MOD source of a vocoder program FILTER

- FC MOD SOURCE: [Bn, 63, 04, Bn, 62, 00, Bn, 06, mm]
- (n: channel, mm: parameter value)

Synth Parameter	Vocoder Parameter	MSB (Hex)	LSB (Hex)	Value (transmitted)	Value (received)
PATCH 1 SOURCE	FC MOD SOURCE	04(04)	00(00)	0: F.EG(will not be transmitted FC MOD SOURCE), 18: A.EG, 36: LFO1, 54: LFO2	0...15: F.EG, 16...31: A.EG/FC MOD SOURCE will be transmitted 0...31: A.EG, 32...47: LFO1, 48...63: LFO2
PATCH 2 SOURCE	_____	_____	04(04)	01(01)	_____
PATCH 3 SOURCE	_____	_____	04(04)	02(02)	72: VELOCITY, 80...95: KBD TRACK
PATCH 4 SOURCE	_____	_____	04(04)	03(03)	108: [MOD], 126: [PITCH]
PATCH 1 DESTINATION	_____	_____	04(04)	08(08)	0: PITCH, 18: OSC2 PITCH
PATCH 2 DESTINATION	_____	_____	04(04)	09(09)	36: OSC1 CTRL1, 54: NOISE LEVEL
PATCH 3 DESTINATION	_____	_____	04(04)	10(0A)	72: CUTOFF, 90: AMP, 108: PAN
PATCH 4 DESTINATION	_____	_____	04(04)	11(0B)	126: LFO2 FREQ
					0...15: PITCH, 16...31: OSC2 PITCH 32...47: OSC1 CTRL1 48...63: NOISE LEVEL, 64...79: CUTOFF 80...95: AMP, 96...111: PAN 112...127: LFO2 FREQ

Controlling CH PARAM

The CH PARAM (CH LEVEL and CH PAN) of the synthesis filter can be controlled.

- Channel Level 1...16ch: [Bn, 63, 04, Bn, 62, 10...1F, Bn, 06, mm]
- (n: channel, mm: parameter value)

Vocoder Parameter	MSB (Hex)	LSB (Hex)	Value (transmitted)	Value (received)
CH [01] LEVEL	04(04)	16(10)	CH LEVEL: 0...127	CH LEVEL: 0...127
CH [02] LEVEL	04(04)	18(12)		
CH [03] LEVEL	04(04)	20(14)		
CH [04] LEVEL	04(04)	22(16)		
CH [05] LEVEL	04(04)	24(18)		
CH [06] LEVEL	04(04)	26(1A)		
CH [07] LEVEL	04(04)	28(1C)		
CH [08] LEVEL	04(04)	30(1E)		

- Channel Pan 1...16ch: [Bn, 63, 04, Bn, 62, 20...2F, Bn, 06, mm]
- (n: channel, mm: parameter value)

Vocoder Parameter	MSB (Hex)	LSB (Hex)	Value (transmitted)	Value (received)
CH [01] PAN	04(04)	32(20)	CH PAN: 0*1: L63, 2: L62...63: L01 64: CNT, 65: R01...127: R63	CH PAN: 0*1: L63, 2: L62...63: L01 64: CNT, 65: R01...127: R63
CH [02] PAN	04(04)	34(22)		
CH [03] PAN	04(04)	36(24)		
CH [04] PAN	04(04)	38(26)		
CH [05] PAN	04(04)	40(28)		
CH [06] PAN	04(04)	42(2A)		
CH [07] PAN	04(04)	44(2C)		
CH [08] PAN	04(04)	46(2E)		

Messages transmitted and received by the microKORG

🔗 If you are transmitting these parameters between two microKORG units, set both units to the same program settings.

❑ System exclusive messages

microKORG format

F0: exclusive status
42: Korg ID
3n: [n=0—F] MIDI channel
58: microKORG model ID (same as MS2000/MS2000R)
ff: function ID (type of message)
—
F7: end of exclusive

Universal system exclusive

System exclusive messages include a special category of messages whose purpose is officially defined. These are called universal system exclusive messages.

Of these universal system exclusive messages, the microKORG supports Master Volume and Master Fine Tuning.

Master volume [F0, 7F, nn, 04, 01, vv, mm, F7]

(vv: lower byte of value, mm: upper byte of value, [mm, vv=7F, 7F] is Max, [mm, vv=00, 00] is 0)

When a Master Volume message is received, the microKORG will adjust its overall volume.

🔗 If GLOBAL "AUDIO IN THRU" is ON, the input signal of AUDIO IN 1/2 will not be affected by Master Volume.

Master fine tuning [F0, 7F, nn, 04, 03, vv, mm, F7]

(A value of 8192 [mm, vv=40, 00] is center (0 cent, A4=440.0Hz), 4096 [mm, vv=20, 00] is -50 cents, and 12288 [mm, vv=60, 00] is +50 cents.)

When master fine tuning is received, the value specified for the microKORG's GLOBAL "MASTER TUNE" will be ignored, and the overall pitch will be specified by the data that was received.

Transmitting sound settings etc. (Data Dump)

Program data and global data can be transmitted as a MIDI exclusive data. The action of transmitting MIDI exclusive data to an external MIDI device is called a data dump.

By performing a data dump, you can store various types of data on an external MIDI device, or rewrite the sounds or settings of a second microKORG.

Data dumps can be performed on the microKORG as follows.

- Use the SHIFT function "MIDI DATA DUMP" to select the data that you want to transmit (1PROG, PROG, GLOBAL, ALL), and dump the data.

1PROG will dump only the data of the selected program. When the microKORG receives such a data dump, the settings of the currently selected program will be rewritten by the data that was received.

In this case, the data will not be saved unless you perform the Write operation.

PROG will dump the data for all programs saved in memory.

GLOBAL will dump the global data (GLOBAL, MIDI, and some of the SHIFT function settings →p.58).

ALL will dump all programs as well as global data.

If PROG, GLOBAL, or ALL dumps are received by the microKORG, the data will be written directly into internal memory; you do not need to perform the Write operation.

- When a dump request is received from an external device, the microKORG will transmit the data dump that was requested.

If you want the microKORG to receive a data dump, turn the SHIFT function "WRITE PROTECT" OFF (OFF), and set the MIDI FILTER setting "SYSTEM EXCLUSIVE" to Enable (E - E). If this is set to Disable (E - d), data dumps can not be received.

note If you wish to obtain the "MIDI Implementation" which includes details of the MIDI exclusive format, please contact a Korg dealer.

note The microKORG maintains data compatibility only for parameters that it shares with the MS2000/MS2000R. This data can be exchanged via data dump. For details on the compatible parameters, refer to "MIDI Implementation."

❑ Realtime Messages

Starting/stopping the arpeggiator

When the microKORG's arpeggiator is synchronized to a connected external MIDI device, system realtime messages Start and Stop will control the arpeggiator.

Start [FA]

When a Start [FA] message is received, the arpeggiator will start from the pitch of the first played note.

Stop [FC]

When a Stop [FC] message is received, the arpeggiator will stop. (It will not be turned off; the arpeggiator will start again when additional notes are played.)

Messages transmitted and received by the microKORG

Front panel knob/key control change assignments

Control changes can be assigned to each front panel knob/key of the microKORG so that the changes in sound as controlled by knob/key operations can be transmitted as performance data.

note For details on assigning control changes to the microKORG's knobs and keys, refer to page 61.

note Different parameters are assigned to synth parameters and vocoder parameters.

 If you are using two microKORG units to transmit and receive these parameters, you must set the transmitting and receiving programs to the same settings.

	Synth Parameter	Vocoder Parameter	Initial	Value (transmitted)	Value (received)
	PITCH	Portamento	Portamento	CC#05	0...127
OSC 1	Wave	Wave	CC#77	0:Saw, 18: Square, 36: Tri, 54: Sin, 72: Vox Wave 90: DWGS, 108: Noise, 126: Audio In	0...15: Saw, 16...31: Square, 32...47: Tri, 48...63: Sin, 64...79: Vox Wave, 80...95: DWGS, 96...111: Noise, 112...127: Audio In
	Control1	Control1	CC#14	0...127	0...127
	Control2	Control2	CC#15	0...127 * OSC 1 Wave=DWGS; see p.57	0...127 * OSC 1 Wave=DWGS; see p.57
	Wave	-----	CC#78	0: Saw, 64: Squ, 127: Tri	0...42: Saw, 43...85: Squ, 86...127: Tri
OSC 2 Audio in 1	OSC Mod	-----	CC#82	0: OFF, 43: Ring, 85: Sync, 127: RingSync	0...31: OFF, 32...63: Ring, 64...95: Sync, 96...127: RingSync
	Semitone	HPF Level	CC#18	Synth; see p.57 Vocoder; 0... 127	Synth; see p.57 Vocoder; 0... 127
	Tune	Threshold	CC#19	Synth; 0 / 1: -63, 2: -62...63: -1, 64: 0, 65: +1...127: +63 Vocoder; 0... 127	Synth; 0 / 1: -63, 2: -62...63: -1, 64: 0, 65: +1...127: +63 Vocoder; 0... 127
MIXER	OSC 1 Level	OSC 1 Level	CC#20	0...127	0...127
	OSC 2 Level	Inst Level	CC#21	0...127	0...127
	Noise Level	Noise Level	CC#22	0...127	0...127
FILTER	Type	Formant Shift	CC#83	Synth; 0: -24LPF, 43: -12LPF, 85: -12BPF, 127: -12HPF Vocoder; 0: 0, 32: +1, 63: +2, 95: -1, 126: -2	Synth; 0...31: -24LPF, 32...63: -12LPF, 64...95: -12BPF, 96...127: -12HPF Vocoder; 0...25: 0, 26...51: +1, 52...76: +2, 77...102: -1, 103...127: -2
	Cutoff	Cutoff	CC#74	Synth; 0...127 Vocoder; 0 / 1: -63, 2: -62...63: -1, 64: 0, 65: +1...127: +63	Synth; 0...127 Vocoder; 0 / 1: -63, 2: -62...63: -1, 64: 0, 65: +1...127: +63
	Resonance	Resonance	CC#71	0...127	0...127
	Filter EG Int	Mod Int	CC#79	0 / 1: -63, 2: -62...63: -1, 64: 0, 65: +1...127: +63	0 / 1: -63, 2: -62...63: -1, 64: 0, 65: +1...127: +63
F.EG	KBD Track	E.F.Sense	CC#85	Synth; 0 / 1: -63, 2: -62...63: -1, 64: 0, 65: +1...127: +63 Vocoder; 0...127	Synth; 0 / 1: -63, 2: -62...63: -1, 64: 0, 65: +1...127: +63 Vocoder; 0...127
	Attack	-----	CC#23	0...127	0...127
	Decay	-----	CC#24	0...127	0...127
	Sustain	-----	CC#25	0...127	0...127
AMP	Release	-----	CC#26	0...127	0...127
	Level	Level	CC#07	0...127	0...127
	Panpot	Direct Level	CC#10	Synth; 0 / 1: L63, 2: L62...63: L01, 64: CNT, 65: R01...127: R63 Vocoder; 0...127	Synth; 0 / 1: L63, 2: L62...63: L01, 64: CNT, 65: R01...127: R63 Vocoder; 0...127
	Distortion	Distortion	CC#92	0: OFF, 127: ON	0...63: OFF, 64...127: ON
A.EG	Attack	Attack	CC#73	0...127	0...127
	Decay	Decay	CC#75	0...127	0...127
	Sustain	Sustain	CC#70	0...127	0...127
	Release	Release	CC#72	0...127	0...127
LFO 1	Wave	Wave	CC#87	0: Saw, 43: Squ1, 85: Tri, 127: S/H	0...31: Saw, 32...63: Squ1, 64...95: Tri, 96...127: S/H
	Frequency	Frequency	CC#27	0...127, Tempo Sync=ON; see p.57	0...127, Tempo Sync=ON; see p.57
LFO 2	Wave	Wave	CC#88	0: Saw, 43: Squ2, 85: Sin, 127: S/H	0...31: Saw, 32...63: Squ2, 64...95: Sin, 96...127: S/H
	Frequency	Frequency	CC#76	0...127, Tempo Sync=ON; see p.57	0...127, Tempo Sync=ON; see p.57
PATCH 1	Intensity	-----	CC#28	0 / 1: -63, 2: -62...63: -1, 64: 0, 65: +1...127: +63	0 / 1: -63, 2: -62...63: -1, 64: 0, 65: +1...127: +63
PATCH 2	Intensity	-----	CC#29	0 / 1: -63, 2: -62...63: -1, 64: 0, 65: +1...127: +63	0 / 1: -63, 2: -62...63: -1, 64: 0, 65: +1...127: +63
PATCH 3	Intensity	-----	CC#30	0 / 1: -63, 2: -62...63: -1, 64: 0, 65: +1...127: +63	0 / 1: -63, 2: -62...63: -1, 64: 0, 65: +1...127: +63
PATCH 4	Intensity	-----	CC#31	0 / 1: -63, 2: -62...63: -1, 64: 0, 65: +1...127: +63	0 / 1: -63, 2: -62...63: -1, 64: 0, 65: +1...127: +63
MOD FX	LFO Speed	LFO Speed	CC#12	0...127	0...127
	Depth	Depth	CC#93	0...127	0...127
DELAY	Delay Time	Delay Time	CC#13	0...127, Tempo Sync=ON; see p.57	0...127, Tempo Sync=ON; see p.57
	Depth	Depth	CC#94	0...127	0...127
(MIDI)	Timbre Select	-----	CC#95	0:Timbre1, 1:Timbre1&2(Sync), 127:Timbre2	0:Timbre1, 1:Timbre1&2(Sync), 2...127:Timbre2
	Sync Ctrl	Sync Ctrl	CC#90	0:OFF, 127:ON	0...63:OFF, 64...127:ON

Messages transmitted and received by the microKORG

Control 2 values when OSC 1 Wave = DWGS

When the synth parameter OSC 1 "WAVE" is set to DWGS, the "CONTROL 2" (knob 3) will select the DWGS waveform. The value of the control change transmitted/received by operating the "CONTROL 2" (knob 3) corresponds to the parameter value as follows.

Value (transmitted, received)	DWGS Wave	Value (transmitted, received)	DWGS Wave
0, 1	1	64, 65	33
2, 3	2	66, 67	34
4, 5	3	68, 69	35
6, 7	4	70, 71	36
8, 9	5	72, 73	37
10, 11	6	74, 75	38
12, 13	7	76, 77	39
14, 15	8	78, 79	40
16, 17	9	80, 81	41
18, 19	10	82, 83	42
20, 21	11	84, 85	43
22, 23	12	86, 87	44
24, 25	13	88, 89	45
26, 27	14	90, 91	46
28, 29	15	92, 93	47
30, 31	16	94, 95	48
32, 33	17	96, 97	49
34, 35	18	98, 99	50
36, 37	19	100, 101	51
38, 39	20	102, 103	52
40, 41	21	104, 105	53
42, 43	22	106, 107	54
44, 45	23	108, 109	55
46, 47	24	110, 111	56
48, 49	25	112, 113	57
50, 51	26	114, 115	58
52, 53	27	116, 117	59
54, 55	28	118, 119	60
56, 57	29	120, 121	61
58, 59	30	122, 123	62
60, 61	31	124, 125	63
62, 63	32	126, 127	64

OSC 2 Semitone values

The value of the control change transmitted/received by operating OSC 2 "SEMITONE" (knob 3) of a synth program corresponds to the parameter value as follows.

Value (transmitted, received)	OSC 2 Semitone	Value (transmitted, received)	OSC 2 Semitone
0...2	-24	66, 67	+1
3...5	-23	68...70	+2
6, 7	-22	71...73	+3
8...10	-21	74, 75	+4
11...13	-20	76...78	+5
14, 15	-19	79, 80	+6
16...18	-18	81...83	+7
19, 20	-17	84...86	+8
21...23	-16	87, 88	+9
24...26	-15	89...91	+10
27, 28	-14	92...94	+11
29...31	-13	95, 96	+12
32, 33	-12	97...99	+13
34...36	-11	100, 101	+14
37...39	-10	102...104	+15
40, 41	-9	105...107	+16
42...44	-8	108, 109	+17
45...47	-7	110...112	+18
48, 49	-6	113, 114	+19
50...52	-5	115...117	+20
53, 54	-4	118...120	+21
55...57	-3	121, 122	+22
58...60	-2	123...125	+23
61, 62	-1	126, 127	+24
63...65	0		

"SYNC NOTE" value when LFO 1/2 or DELAY "TEMPO SYNC" = ON

If "TEMPO SYNC" is ON, the parameter that is set by the LFO 1/2 "FREQUENCY" (knob 4) or the DELAY "DELAY TIME" (knob 3) will change to "SYNC NOTE." In this case, the value of the control change message transmitted by knob operations (or received) will correspond to the parameter value as shown below.

Value (transmitted, received)	LFO Sync Note	DELAY Sync Note
0...8	1/1	1/32
9...17	3/4	1/24
18...25	2/3	1/16
26...34	1/2	1/12
35...42	3/8	3/32
43...51	1/3	1/8
52...59	1/4	1/6
60...68	3/16	3/16
69...76	1/6	1/4
77...85	1/8	1/3
86...93	3/32	3/8
94...102	1/12	1/2
103...110	1/16	2/3
111...119	1/24	3/4
120...127	1/32	1/1

MIDI

Message

Saving Data

WRITE



Saving your edited settings

- ⚠ If you have edited a program, your edited settings will be lost if you turn the power off or select another program before saving (writing). If you want to use the edited program later, you must save (write) it. Changes you make to the GLOBAL, MIDI, or SHIFT functions (described later in this manual) will also be lost if you turn off the power before saving (writing). If you want to reuse the modified settings, you must save them.
- ⚠ Never turn off the power while data is being written. Doing so may destroy the data.

Saving a program

Settings that will be saved

- All parameters VOICE-ARPEG.B (FORMANT HOLD key on/off)
- ARPEGGIATOR ON/OFF key
- OCTAVE SHIFT UP, DOWN keys

Procedure

- 1 Press the **WRITE** key.
The currently selected program number will blink in the display. The **WRITE** key LED will also blink, and the **SHIFT** key LED will light.

note If the display blinks "PCT" (Protect) when you press the **WRITE** key, the write protect setting is turned on, so that programs cannot be written. Press the **SHIFT** key to return to the normal state, and turn write protect off. (→p.63)

note If the display blinks "GLb" (Global) when you press the **WRITE** key, a GLOBAL or MIDI parameter is selected for saving. Press the **SHIFT** key to return to the normal state, and use the **EDIT SELECT 1** or **EDIT SELECT 2** dial to select a position other than GLOBAL or MIDI.

- 2 Select the program number where you want to save the current program settings.

Use the **PROGRAM SELECT BANK SIDE** key, the **PROGRAM SELECT** dial, and the **PROGRAM NUMBER** keys to select the program number where you want to save the current program settings. The display will indicate the save-destination number.

If you decide to cancel without saving, press the lit **SHIFT** key.

- 3 Press the **WRITE** key once again to save the data (execute the Write operation).

The display will indicate "PCT," and the data will be written. Then the microKORG will return to the normal operating state.

Writing program data

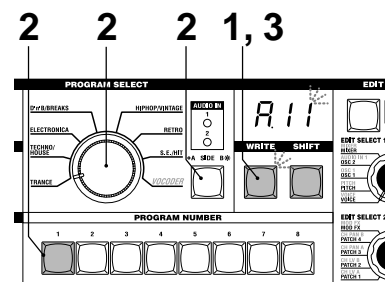

Saving GLOBAL, MIDI, and SHIFT function settings

Settings that will be saved (Global data)

- GLOBAL parameters other than AUDIO IN THRU
- All MIDI parameters
- SHIFT functions
MIDI FILTER, CONTROL CHANGE, WRITE PROTECT

Writing global data

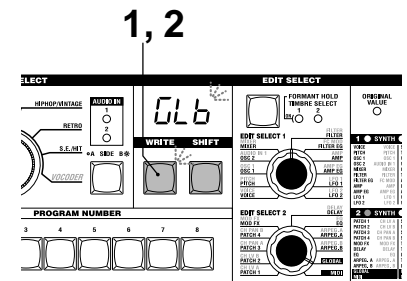

Procedure

- 1 Press the **WRITE** key.

The display will blink "GLb," the **WRITE** key LED will blink, and the **SHIFT** key LED will light.

If you decide to cancel without saving, press the lit **SHIFT** key.

note If a program number such as "R 1 !" blinks in the display when you press the **WRITE** key, a program is selected for saving. Press the **SHIFT** key to return to the normal state, and turn the **EDIT SELECT 2** dial to the **GLOBAL** or **MIDI** position.

- 2 Press the **WRITE** key once again to save the data (execute the Write operation).

The display will indicate "PCT," and the data will be written. Then the microKORG will return to its normal state.

SHIFT functions

SHIFT



Copying and exchanging timbres -SYNTH / Initializing a program

By holding down the **SHIFT** key and pressing the appropriate key, you can perform various utility functions. While a SHIFT function is being used, the **SYNTH** and **VOCODER** LEDs will both light. If you press the lit **SHIFT** key at this time, you will exit these functions and return to normal operation.

1-1. COPY TIMBRE (CPE)

Copying a timbre

You can access this function only if a synth program is selected. Timbre settings from another program will be copied to the timbre of the currently selected program. In the case of a Layer program, the settings of the currently-edited timbre will be copied.

note You cannot execute this function if a vocoder program is selected as the copy-source program (2). ("Err": Error)

Procedure

- 1 Hold down the **SHIFT** key and press the 1 key. The display will indicate "CPE."

- 2 Turn knob 1 to select the copy-source program (A.11–B.88). The 1 key will begin blinking. If you decide to cancel this operation, press the lit **SHIFT** key.
- 3 Press the blinking 1 key. The timbre copy will be executed, and then the microKORG will return to its normal state.

note If you have not selected a copy-source program (2), the 1 key will remain lit. If in this state you press the 1 key to attempt to execute, the display will indicate "---," and the copy will not be executed.

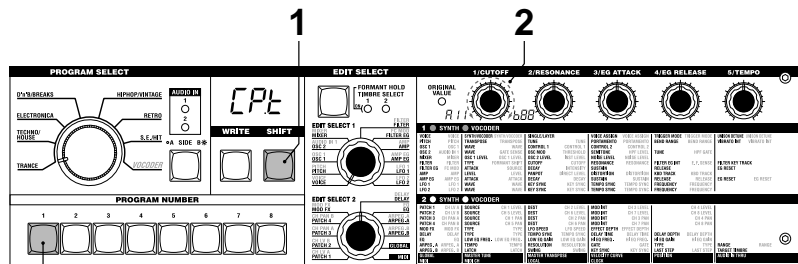

1, 3

2-1. SWAP TIMBRE (SUT)

Exchanging timbres

You can access this function only if a Layer synth program is selected. This will exchange the settings of timbres 1 and 2 within the currently selected program.

note You cannot execute this if a Single synth program is selected. (The display will indicate "Err": Error.)

Procedure

- 1 Hold down the **SHIFT** key and press the 2 key. The display will indicate "SUT."
- 2 Press the blinking 2 key. The timbre exchange will be executed, and then the microKORG will return to its normal state. If you decide to cancel, press the lit **SHIFT** key.

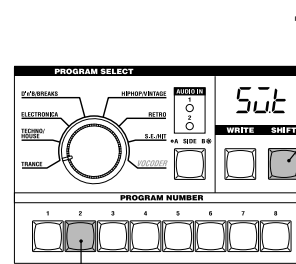

1, 2

3-1. INIT PROGRAM (INI)

Initializing a program

This function initializes the settings of the currently selected program. If you execute this on a synth program, it will be set as a Single program.

Procedure

- 1 Hold down the **SHIFT** key and press the 3 key. The display will indicate "INI."
- 2 Press the blinking 3 key. The program will be initialized, and then the microKORG will return to its normal state. If you decide to cancel, press the lit **SHIFT** key.

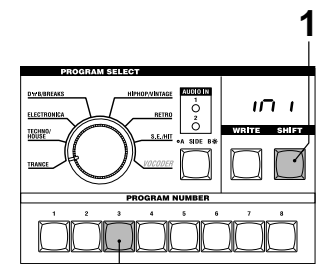

1, 2

WRITE

SHIFT

Initializing CH LEVEL and CH PAN -VOCODER

1-2. INIT LEVEL (*inL*)

Initializing CH LEVEL A/B

You can access this function if a vocoder program is selected.

This will simultaneously initialize the output levels of the eight band-pass filter channels for the carrier (SYNTHESIS FILTER). When you initialize the levels, all output levels will be set to 127.

Procedure

- 1 Hold down the **SHIFT** key and press the 1 key.
The display will indicate " *inL* ."
- 2 Press the blinking 1 key.
The output levels will be initialized, and then the microKORG will return to its normal state.

If you decide to cancel, press the lit **SHIFT** key.

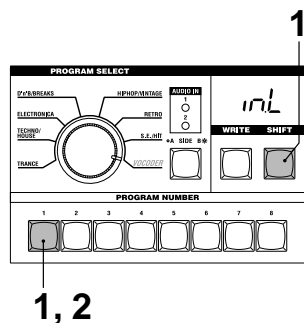

2-2. INIT PAN (*inP*)

Initializing CH PAN A/B

You can access this function if a vocoder program is selected.

This will simultaneously initialize the pan of the eight band-pass filter channels for the carrier (SYNTHESIS FILTER). When you initialize the pan settings, each filter channel will be set to Center.

Procedure

- 1 Hold down the **SHIFT** key and press the 2 key.
The display will indicate " *inP* ."
- 2 Press the blinking 2 key.
The pan settings will be initialized, and then the microKORG will return to its normal state.

If you decide to cancel, press the lit **SHIFT** key.

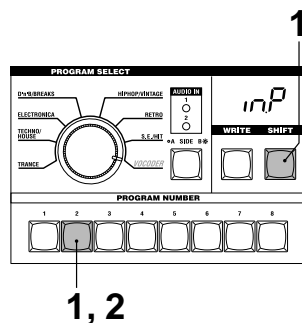

MIDI Filter

4-1. MIDI FILTER (*FLt*)

MIDI Filter

These settings specify whether the corresponding types of MIDI data will be received and transmitted.

Procedure

- 1 Hold down the **SHIFT** key and press the 4 key.
The display will indicate " *FLt* ."
- 2 Turn the appropriate knob 1-4 to make the desired settings.

[1] knob: PROGRAM CHANGE

Selects whether program changes will be transmitted and received.

Disable (*P-d*):

Program changes will not be transmitted or received.

Enable (*P-E*):

Program changes will be transmitted and received.

[2] knob: CONTROL CHANGE

Selects whether MIDI control changes will be transmitted and received.

Disable (*C-d*):

MIDI control changes will not be transmitted or received.

Enable (*E-E*):

MIDI control changes will be transmitted and received.

[3] knob: PITCH BEND

Selects whether pitch bend messages will be transmitted and received.

Disable (*b-d*):

Pitch bend messages will not be transmitted or received.

Enable (*b-E*):

Pitch bend messages will be transmitted and received.

[4] knob: SYSTEM EXCLUSIVE

Selects whether MIDI system exclusive messages will be transmitted and received.

Disable (*E-d*):

MIDI system exclusive messages will not be transmitted or received.

Enable (*E-E*):

MIDI system exclusive messages will be transmitted and received.

- 3 When you have finished making settings, press the lit 4 key or the **SHIFT** key. The microKORG will return to its normal state.

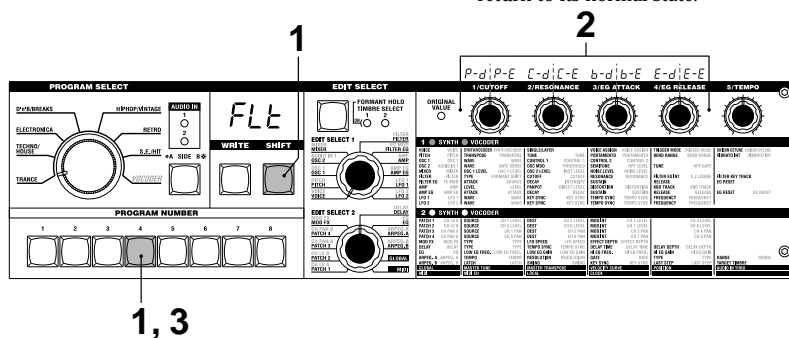

Assigning control changes

5-1. CONTROL CHANGE (CC)

Assigning control changes

You can assign control change numbers to the principal parameters accessed by the EDIT SELECT 1 and 2 knobs and knobs 1-5.

When you operate a knob that corresponds to one of the parameters shown below, the assigned control change will be transmitted. If the microKORG receives the assigned control change, the parameter value corresponding to that knob will be adjusted.

The default settings of these parameters are shown on page 56.

Procedure

- 1 Hold down the **SHIFT** key and press the 5 key.
The display will indicate "CC".
- 2 Turn the EDIT SELECT 1 or EDIT

SELECT 2 dial to select the section that contains the parameter whose control change you want to specify.

- 3 Turn each knob to select the desired MIDI control change number (OFF, C.00..C.95).

note If the specified number is currently assigned to another parameter, the last decimal point "." in the display will light.

- 4 When you have finished making settings, press the lit 5 key or the **SHIFT** key.
The microKORG will return to its normal state.

note The MIDI "MIDI CH" knobs 1 and 2 will select the control change number for TIMBRE SELECT and SYNC CTRL.

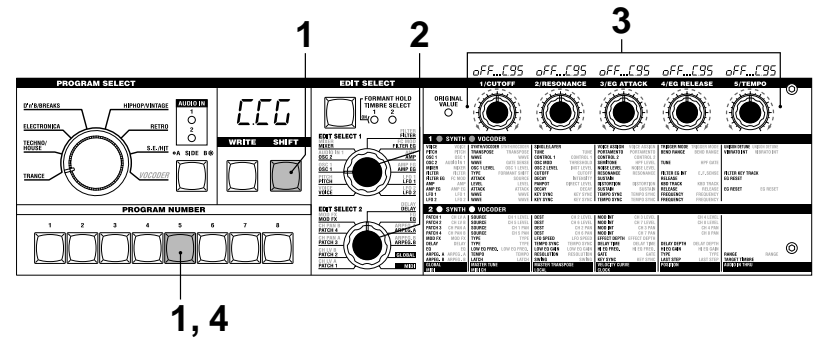

Parameters for which you can assign a control change

1 ● SYNTH ● VOCODER											
VOICE	VOICE	SYNTH/VOCODER	SYNTH/VOCODER	SINGLE/LAYER	TUNE	VOICE ASSIGN	VOICE ASSIGN	TRIGGER MODE	TRIGGER MODE	UNISON DETUNE	UNISON DETUNE
PITCH	PITCH	TRANSPOSE	TRANSPOSE	TUNE	CONTROL 1	PORTAMENTO	PORTAMENTO	BEND RANGE	BEND RANGE	VIBRATO INT	VIBRATO INT
OSC 1	OSC 1	WAVE	WAVE	CONTROL 1	CONTROL 1	CONTROL 2	CONTROL 2				
OSC 2	AUDIO IN 1	WAVE	GATE SENSE	OSC MOD	THRESHOLD	SEMITONE	HPF LEVEL	TUNE	HPF GATE		
MIXER	MIXER	OSC 1 LEVEL	OSC 1 LEVEL	OSC 2 LEVEL	INST LEVEL	NOISE LEVEL	NOISE LEVEL				
FILTER	FILTER	TYPE	FORMANT SHIFT	CUTOFF	CUTOFF	RESONANCE	RESONANCE	FILTER EG INT	E.F.SENSE	FILTER KEY TRACK	
FILTER EG	FC MOD	ATTACK	SOURCE	DECAY	INTENSITY	SUSTAIN	SUSTAIN	RELEASE		EG RESET	
AMP	AMP	LEVEL	LEVEL	PANPOT	DIRECT LEVEL	DISTORTION	DISTORTION	KBD TRACK	KBD TRACK	EG RESET	EG RESET
AMP EG	AMP EG	ATTACK	ATTACK	DECAY	DECAY	SUSTAIN	SUSTAIN	RELEASE	RELEASE		
LFO 1	LFO 1	WAVE	WAVE	KEY SYNC	KEY SYNC	TEMPO SYNC	TEMPO SYNC	FREQUENCY	FREQUENCY		
LFO 2	LFO 2	WAVE	WAVE	KEY SYNC	KEY SYNC	TEMPO SYNC	TEMPO SYNC	FREQUENCY	FREQUENCY		

2 ● SYNTH ● VOCODER											
PATCH 1	CH LV A	SOURCE	CH 1 LEVEL	DEST	CH 2 LEVEL	MOD INT	CH 3 LEVEL			CH 4 LEVEL	
PATCH 2	CH LV B	SOURCE	CH 5 LEVEL	DEST	CH 6 LEVEL	MOD INT	CH 7 LEVEL			CH 8 LEVEL	
PATCH 3	CH PAN A	SOURCE	CH 1 PAN	DEST	CH 2 PAN	MOD INT	CH 3 PAN			CH 4 PAN	
PATCH 4	CH PAN B	SOURCE	CH 5 PAN	DEST	CH 6 PAN	MOD INT	CH 7 PAN			CH 8 PAN	
MOD FX	MOD FX	TYPE	TYPE	LFO SPEED	LFO SPEED	EFFECT DEPTH	EFFECT DEPTH				
DELAY	DELAY	TYPE	TYPE	TEMPO SYNC	TEMPO SYNC	DELAY TIME	DELAY TIME	DELAY DEPTH	DELAY DEPTH		
EQ	EQ	LOW EQ FREQ.	LOW EQ FREQ.	LOW EQ GAIN	LOW EQ GAIN	HI EQ FREQ.	HI EQ FREQ.	HI EQ GAIN	HI EQ GAIN		
ARPEG. A	ARPEG. A	TEMPO	TEMPO	RESOLUTION	RESOLUTION	GATE	GATE	TYPE	TYPE	RANGE	RANGE
ARPEG. B	ARPEG. B	LATCH	LATCH	SWING	SWING	KEY SYNC	KEY SYNC	LAST STEP	LAST STEP	TARGET TIMBRE	
GLOBAL		MASTER TUNE		MASTER TRANSPOSE		VELOCITY CURVE		POSITION		AUDIO IN THRU	
MIDI		(TIMBRE SELECT)		(SYNC CTRL)	(SYNC CTRL)	CLOCK					

SHIFT

Data dump

6-1. MIDI DATA DUMP (dñP)

Data dump

"Data dump" is a function that transmits program or global data in the form of MIDI exclusive data, so that it can be saved on a connected MIDI data file or computer. This can also be used to transmit data to another microKORG unit.

⚠ Do not touch the knobs or keyboard of the microKORG while data is being transmitted or received. Also, never turn the power off during this time.

⚠ Some USB-MIDI interface devices may not be able to transmit/receive the microKORG's MIDI exclusive messages.

Transmission procedure

- 1 Connect the microKORG's MIDI OUT connector to the MIDI IN connector of a device that is able to receive a MIDI data dump, and set both devices to the same MIDI channel.
- 2 Hold down the **SHIFT** key and press the **6** key. The display will indicate "dñP."

- 3 Turn the 1 knob to select the type of data dump that will be transmitted.

1Program (PñG):

Data for the currently selected program will be transmitted.

Program (P-rñ):

Data for all programs will be transmitted.

Global (GñLb):

Global data will be transmitted. (→p.58)

All (ñLL):

All programs and global data will be transmitted.

The **6** key will begin blinking.

If you decide to cancel, press the lit **SHIFT** key.

- 4 Press the blinking **6** key. The data dump will be executed, and then the microKORG will return to its normal state.

Ⓝ If you did not select a data dump to be transmitted, the **6** key will remain lit. If you attempt to transmit by pressing

the **6** key in this state, the display will indicate "----" and the data dump will not be executed.

Ⓝ For the size of the dumped data and the time required for each, refer to table s6-1.

Reception procedure

Use the following procedure when you want to return previously-saved data from a connected MIDI data file or computer back to the microKORG, or to receive data from another microKORG unit.

- 1 Connect the microKORG's MIDI IN connector to the MIDI OUT connector of the device that will transmit the MIDI dump data.
- 2 Set the MIDI channel of the transmitting device to match the microKORG's MIDI channel. If you previously transmitted data to an external MIDI device and want to receive it into the microKORG, set the microKORG's MIDI channel to the same setting as when it originally transmitted the data.
- 3 Set the **SHIFT** function **MIDI FILTER "SYSTEM EXCLUSIVE"** to Enable. (→p.60)
Turn "**WRITE PROTECT**" OFF (→p.63).
- 4 Transmit the data from the MIDI data file or other device. For the transmission procedure, refer to the manual of the device you are using.

table s6-1

Data to dump	Data size (Bytes)	Time required (Seconds)
1Program	291	Less than one second
Program	37,157	approximately 15
Global	229	Less than one second
All	37,386	approximately 15

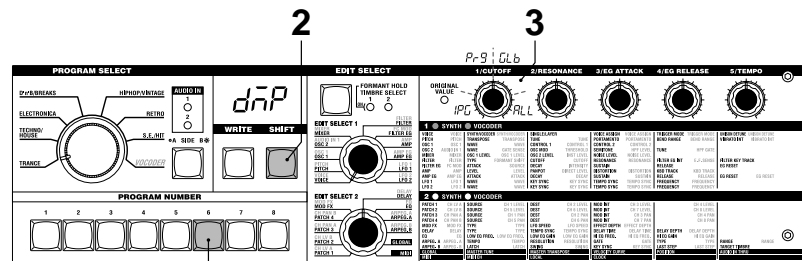

2, 4

Restoring the factory settings

7-1. PRELOAD (PLd)

Restoring the factory settings
This operation restores the microKORG's programs and global data settings to the factory-set condition. The factory-set settings are referred to as the "preload data."

⚠ When you restore the Preload settings, the data within the microKORG will be rewritten to the factory settings. Be sure that you don't mind losing your current data before you restore the factory settings.

⚠ Do not touch the microKORG's knobs or keyboard while the Preload operation is being executed, and never turn the power off.

note Preload cannot be executed if the SHIFT function "WRITE PROTECT" is on. You must turn "WRITE PROTECT" off beforehand.

Procedure

- 1 Hold down the **SHIFT** key and press the 7 key.
The display will indicate "PLd."
- 2 Turn the 1 knob to select the data that will be restored to its factory-set

condition.

1Program (IPG):
Load only data for one program.

Program (Prg):
Load data for all programs (128 programs).

Global (GLb):
Load global data. (→p.58)

To cancel, press the lit **SHIFT** key.

- 3 If you selected 1Program (IPG) in step 2, turn knob 2 to select the program (A.11–b.88) that will be restored to its factory-set condition.
- 4 Press the blinking 7 key. The Preload operation will be executed, and the microKORG will return to its normal state.

note If you have not selected the data to be restored to the factory-set condition (steps 2 or 3), the 7 key will be lit. If you attempt to execute by pressing the 7 key in this state, the display will indicate "---" and the operation will not be executed.

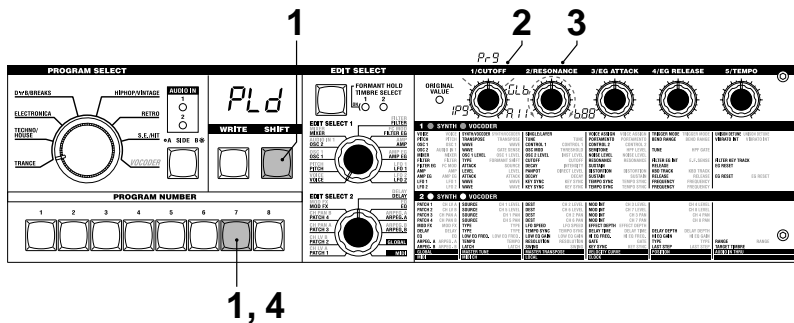

Write protect setting

8-1. WRITE PROTECT (WLP)

Write protect setting

The microKORG provides a write protect setting that disables writing to memory, letting you prevent data from being rewritten accidentally. If you want to save data that you have edited, you must first turn write protect off.

Procedure

- 1 Hold down the **SHIFT** key and press the 8 key.
The display will indicate "WLP."
- 2 Turn the 1 knob to switch write protect on/off.

OFF (OFF):
Data can be written to internal memory.

ON (ON):
The following writing operations will be prohibited.

- Writing a program
- Loading the factory data
- Receiving a data dump

- 3 When you have made the desired setting, press the lit 8 key or **SHIFT** key. The microKORG will return to its normal state.

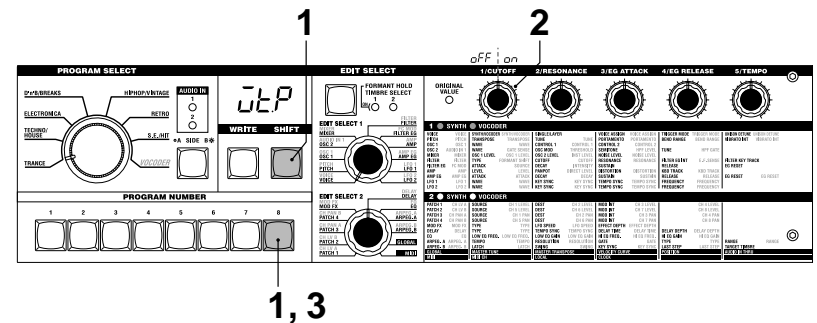

SHIFT

Other SHIFT key functions

TIMBRE SOLO

Timbre solo function

- Hold down the **SHIFT** key and press the **TIMBRE SELECT** key.
If a Layer synth program is selected, only one timbre will sound. (→p.14)

SWITCH EDIT SELECT

Switch between EDIT SELECT 1/2

- Hold down the **SHIFT** key and press the **BANK SIDE** key.
The object of editing will switch from EDIT SELECT 1 to 2, or from 2 to 1. (→p.12)

INC/DEC PARAM VALUE

Increment or decrement the parameter value

RETURN PARAM VALUE (Compare)

Return to the value at the time the parameter was selected (Compare)

- 1 While editing a parameter (i.e., when the parameter value is shown in the display), hold down the **SHIFT** key and press the **OCTAVE SHIFT UP** or **DOWN** key.
The corresponding LED will light red.
- 2 In this state, pressing the **UP** key will increment the currently-edited parameter value by one step, and pressing the **DOWN** key will decrement the value by one step.
If you simultaneously press the **UP** and **DOWN** keys, the value will return to the setting it had when you selected that parameter (the Compare function).
- 3 To exit, press the **SHIFT** key.

ENTER DEMO MODE

Enter demo mode

- When you hold down the **SHIFT** key and press the **ARPEGGIATOR ON/OFF** key, the microKORG will enter Demo mode. (→p.7)

Appendix

Synchronizing the LFO 1/2 rate or the delay time of the delay effect to the arpeggiator tempo

You can synchronize the LFO 1/2 rate or the delay time of the delay effect to the arpeggiator tempo. (When "TEMPO SYNC"=ON)

Example 1. LFO1

LFO1 "TEMPO SYNC" (knob 3): ON

LFO1 "SYNC NOTE" (knob 4): 1/4 (1.4)

In this case, one LFO cycle will occupy the same time as one quarter note.

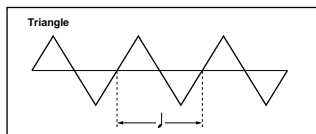

Example 2. Delay time

DELAY "TYPE" (knob 1): Cross Delay

DELAY "TEMPO SYNC" (knob 2): ON

DELAY "SYNC NOTE" (knob 3): 1/8 (1.8)

In this case, the delay time will be set to a time interval of an eighth note, and will alternate between left and right channels.

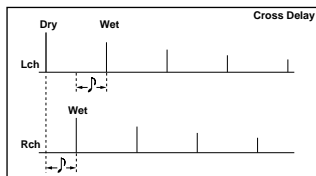

LFO 1/2 and delay time synchronization

How "SYNC NOTE" and "RESOLUTION" settings correspond to note values

The following table shows how LFO or DELAY "SYNC NOTE" settings and ARPEGG.A "RESOLUTION" settings correspond to note values.

The parameters will function according to the tempo specified by ARPEGG.A "TEMPO" and the note value corresponding to its setting.

Note Value	LFO, DELAY "SYNC NOTE"	ARPEGGIO "RESOLUTION"
	1/32	—————
	1/24	1/24
	1/16	1/16
	1/12	1/12
	3/32	—————
	1/8	1/8
	1/6	1/6
	3/16	—————
	1/4	1/4
	1/3	—————
	3/8	—————
	1/2	—————
	2/3	—————
	3/4	—————
	1/1	—————

Troubleshooting

Before you suspect a malfunction, please check the following points.

Power does not turn on

- ❑ Is the AC adaptor connected to an AC outlet? →p.6
- ❑ Is the **POWER** switch turned on (pressed inward)? →p.6
- ❑ If you are using batteries, are batteries installed? Have the batteries run down? →p.6

No sound

- ❑ If your powered monitor system or headphones connected to the correct jack(s)? →p.5
- ❑ Is the connected monitor system powered-on, and is the volume raised?
- ❑ Is the **VOLUME** knob set to a position where sound will be output? →p.6
- ❑ Is the MIDI "LOCAL" setting turned ON? →p.51
- ❑ Were any volume-related parameters set to a value of 0? →p.23, 27, 34, 37
- ❑ Was the FILTER "CUTOFF" set to 0? →p.24
- ❑ Did you turn the **FORMANT HOLD** key on ("E.F. SENSE" HOLD) while there was no input to AUDIO IN 1? →p.10, 35

Can't input sound

- ❑ Is the input source connected to the AUDIO IN 1 **CONDENSER** jack or **DYNAMIC** jack, or to the AUDIO IN 2 **LINE** jack? →p.10, 21, 34
- ❑ If you are inputting to AUDIO IN 1 or AUDIO IN 2, is the **VOLUME 1** or **VOLUME 2** knob turned up? →p.10, 21, 34
- ❑ If you are inputting to AUDIO IN 1, is the **MIC/LINE** switch set appropriately? →p.4
- ❑ If using a vocoder program, have you connected the modulator audio source to the AUDIO IN 1 **CONDENSER** jack or **DYNAMIC** jack? →p.10
- ❑ If you have connected an input device to the AUDIO IN 1 **CONDENSER** jack and also to the **DYNAMIC** jack, the input from the **CONDENSER** jack will take priority, and no signal can be input from the **DYNAMIC** jack. →p.4

Can't edit

- ❑ If the display does not switch to the parameter indication when you turn the edit control knobs 1-5, Performance Edit may be active. →p.8, 12
- ❑ If you are unable to use the edit control knobs 1-5 to edit the parameter value, did you remember to turn the knob to a position that matches the displayed value? →p.13

- ❑ If you are unable to edit timbre 2 of a synth program, has VOICE "SINGLE/LAYER" been set to LAYER? →p.14, 16
- ❑ If you are unable to edit timbre 1 or 2 of a synth program, is the TIMBRE SELECT 1/2 LED lit for the timbre you want to edit? →p.14
- ❑ If the changes you made to a program or to the global settings have not been remembered, did you turn the power off before executing the Write operation? In the case of a program, your edits will also be lost if you select a different program. Execute the Write operation to save your edits before you switch programs or turn off the power. →p.58

Can't write programs or global settings

- ❑ Is Shift function "MEMORY PROTECT" turned OFF? →p.63
- ❑ If an edited program or edited GLOBAL, MIDI, or SHIFT settings you thought you had saved have not actually been saved, did you set the EDIT SELECT 1 or EDIT SELECT 2 knob to one of the **VOICE-ARPEG.B** position when you attempted to save the program, or to the **GLOBAL** or **MIDI** position when you attempted to save the global data? →p.58

Arpeggios do not start

- ❑ Is the arpeggiator turned on (ON/OFF key lit)? →p.11
- ❑ Is the MIDI "CLOCK" setting correct? →p.51

No response to MIDI messages sent from an external device

- ❑ Is the MIDI cable connected correctly? →p.48
- ❑ Does the MIDI channel of the data transmitted from the external MIDI device match the MIDI channel of the microKORG? →p.49

Does not respond correctly to MIDI messages sent from an external device

- ❑ Is the SHIFT function "MIDI FILTER" for that type of MIDI message set to Enable? →p.60

Transpose, velocity curve, and arpeggiator data is not recognized correctly

- ❑ Is Global "POSITION" set appropriately? →p.47

Can't control two timbres on separate MIDI channels

- ❑ The microKORG uses only one MIDI channel to transmit and receive. You cannot use two MIDI channels to play the two timbres independently.

Specifications and options

Tone generator system: Analog modeling synthesis system

- **Synth programs:**
 - Number of timbres: maximum 2 (when using Layer)
 - Maximum polyphony: 4 voices
 - Structure: 2 oscillators + noise generator: sawtooth wave, square wave, triangle wave, sine wave, Vox wave, DWGS x 64, Noise, Audio In (8 types)
PWM function, OSC Sync function, Ring Mod. function, OSC Sync + Ring Mod. function
Multimode filters: -24 dB/oct LPF, -12 dB/oct LPF, -12 dB/oct BPF, -12 dB/oct HPF (4 types)
Filter EG, Amp EG, LFO1, LFO2 (LFO: six waveforms, synchronizable to arpeggiator or external MIDI clock)
- **Vocoder programs:**
 - Maximum polyphony: 4 voices
 - Structure: 8 channel vocoder, adjustable level and pan for each channel, Formant Shift function
1 oscillator + noise generator (8 types)
Filter EG, Amp EG, LFO1, LFO2, (LFO: six waveforms, synchronizable to arpeggiator or external MIDI clock)

Keyboard: 37 notes (mini keyboard, velocity sensitive, no aftertouch)

Effects: Modulation effect: flanger/chorus, phaser, ensemble (3 types), Delay: stereo, cross, L/R (3 types), Equalizer

Arpeggiator: UP, DOWN, ALT1/2, Random, Trigger (6 types), Step Arpeggiator function

Programs: total 128 programs (A/B side x 8 banks x 8 programs)

Inputs

- **AUDIO IN 1 CONDENSER jack (with MIC/LINE switch)**
 - Connector +5V mini-phone jack
 - AUDIO IN 1 (LINE)**
 - Input impedance: 39 [k Ω]
 - Maximum input level: -3.5 [dBu] (VOLUME 1: Max)
 - AUDIO IN 1 (MIC)**
 - Input impedance: 22 [k Ω]
 - Maximum input level: -33 [dBu] (VOLUME 1: Max)
- **AUDIO IN 1 DYNAMIC jack (with MIC/LINE switch)**
 - Connector 1/4" phone jack (unbalanced)

AUDIO IN 1 (LINE)

Input impedance: 39 [k Ω]
Maximum input level: -3.5 [dBu] (VOLUME 1: Max)

Input impedance: 600 [Ω]

AUDIO IN 1 (MIC)

Input impedance: 22 [k Ω]
Maximum input level: -33 [dBu] (VOLUME 1: Max)
Input impedance: 600 [Ω]

• AUDIO IN 2 LINE jack

Connector 1/4" phone jack (unbalanced)
Input impedance: 39 [k Ω]
Maximum input level: -3.5 [dBu] (VOLUME 2: Max)
Input impedance: 600 [Ω]

Outputs

• L/MONO, R jacks

Output impedance: 1.1 [k Ω] (MONO: 550 Ω)
Maximum output level: +0.0 [dBu] or more
Load impedance: 100 [k Ω]

• Headphone jack

Output impedance: 10 [Ω]
Maximum output level: 35 [mW]
Load impedance: 33 [Ω]

MIDI: IN, OUT, THRU connectors

Display: 3-digit x 1 line eight-segment LED

Power supply: when using AC adaptor: DC9V, 6.5 W
when using batteries: six AA batteries, 9 V

Battery life: approximately 4 hours or more (when using alkaline batteries)

Dimensions: 524 x 232 x 70 mm / Inches: 20.63" x 9.13" x 2.76" (W x D x H)

Weight: 2.2kg / 4.85 lbs. (without batteries and included microphone)

Included items: condenser microphone, AC adaptor (DC9V)

- * Appearance and specifications of this product are subject to change without notice.

Index

Symbols

-12dB BPF 25
-12dB HPF 25
-12dB LPF 24
-24dB LPF 24

A

AC adaptor 6
ADSR 26, 28
Amp 15, 27
AMP EG 28
Analog modeling system 1
ANALYSIS FILTER 31
Arpeggiator 11, 43, 50, 53
Arpeggio type 44
Assigning control changes 61
Attack time 9
Audio in 21

B

Band-pass filter 31, 35
bAt 6
Battery 6

C

Carrier 31
Compare 64
Computer 50
Connection 5, 48
Consonant 33

Control change 52, 56
Copying a timbre 59
Create a sound 12
Cross Modulation 19
Cutoff 8, 20, 24, 35

D

Data dump 62
Delay effect 41
Demo song 7
Destination 30
Detuning 16, 22
Distortion 27, 37
DWGS 20

E

Edit Sync 14
Editing 12
Editing each timbre 14
Editing example for a vocoder
 program 32
Effect 39
EG 28
Envelope Follower 31, 35
Envelope Generator 28
EQ 42
Equalizer 42
Exchanging timbres 59

F

Filter 15, 24
Filter EG 26
Filter oscillation 25
FORMANT HOLD key 35

G

Gain 42
GLOBAL 46
Global data 58

I

Increment or decrement the
 parameter value 64
Initializing a program 59
Initializing CH LEVEL A/B 60
Initializing CH PAN A/B 60
Internal MIDI IN/OUT routing
 47

K

Keyboard tracking 9, 24, 27, 37

L

Layer program 16
Legato 16
Level 38
LFO 29
LFO1 18

LFO2 17
Local Control 50
local on/off 51
Low battery 6

M

Mic 5, 10
MIDI 48
MIDI channel 49, 51, 52
MIDI Filter 60
MIDI sequencer 50
MOD wheel 9, 17
Modulation 40
Modulator 31, 33
Monophonically 16

N

Noise 20, 23
Note-on/off 52
NRPN 53

O

OCTAVE SHIFT UP and DOWN
 keys 9
Original parameter values of a
 program 13
OSC1 18
OSC2 22
Oscillator 15, 18
Oscillator Sync 22
Output 47

Output level 23
Output level of the carrier 34

P

Pan 27, 38
Parameter value does not change
 13
Performance Edit 8, 10
Pitch 17, 47
Pitch bend 52
Pitch wheel 9, 17
Polyphonically 16
Portamento 17
Power on 6
Processing an external input
 audio signal 21
Program change 52
Pulse width modulation 18
PWM 18

R

Realtime Messages 55
Release time 9
Resonance 9, 20, 24, 35
Restoring the factory settings 63
Retrigger 16
Ring Modulation 22

Index

S

Saving 58
Sawtooth wave 18, 22
SHIFT functions 59
Sine wave 19
Solo 14
Source 30, 36
Square wave 18, 22
Step 45
Step arpeggiator 11
Switch between EDIT SELECT
 1/2 64
Synchronize 29, 41, 45, 51, 65
Synth program 8, 16
SYNTHESIS FILTER 31
System exclusive messages 55

T

Tempo 9, 44
Three attributes of sound 15
Timbre 15, 16
Timbre solo function 64
Timbre(s) that will be sounded
 by the arpeggiator 45
Transpose 47
Tremolo 29
Triangle wave 19, 22

U

Unison 16
Using an external input as the
 carrier of the voco 34

V

Velocity 9, 47
Vibrato 29
Virtual Patch 30
Vocoder 31
Vocoder program 10, 16
Volume 27, 37
Volume balance 23
Vox wave 19

W

Wah 29
Write protect setting 63

IMPORTANT NOTICE TO CONSUMERS

This product has been manufactured according to strict specifications and voltage requirements that are applicable in the country in which it is intended that this product should be used. If you have purchased this product via the internet, through mail order, and/or via a telephone sale, you must verify that this product is intended to be used in the country in which you reside.

WARNING: Use of this product in any country other than that for which it is intended could be dangerous and could invalidate the manufacturer's or distributor's warranty.

Please also retain your receipt as proof of purchase otherwise your product may be disqualified from the manufacturer's or distributor's warranty.

KORG KORG INC.

15-12, Shimotakaido 1-chome, Suginami-ku, Tokyo, Japan

Voice Name List

BANK	No. (MIDI)	Name	Category	Single/Layer	Tempo	Arpeggio		
TRANCE	A.11 (0)	Trancey Arpeg.	Arpeggio	Layer	138	On		
	A.12 (1)	Acid Saw Bass	Bass	Single	138	On		
	A.13 (2)	Unison Saw Lead	Synth Lead	Single	138	Off		
	A.14 (3)	Unison HPF+LPF	Synth Lead	Layer	138	On		
	A.15 (4)	Weepty Lead	Synth Lead	Single	138	Off		
	A.16 (5)	Slippy Pad	Synth	Single	138	Off		
	A.17 (6)	Sweep Poly Pad	Synth	Single	138	Off		
	A.18 (7)	Filter Strings	Strings/Pad	Single	138	Off		
	TECHNO/HOUSE	A.21 (8)	Auto House	Arpeggio	Layer	140	On	
		A.22 (9)	Burnin' Rave	Arpeggio	Layer	143	On	
		A.23 (10)	X-Mod Perc.	Arpeggio	Single	124	On	
		A.24 (11)	House Bass	Bass	Single	128	Off	
		A.25 (12)	Distorted Bass	Bass	Single	130	Off	
		A.26 (13)	Acid Square Bass	Bass	Single	130	Off	
		A.27 (14)	Sync Bass	Bass	Single	130	Off	
		A.28 (15)	Hard House Lead	Synth Lead	Single	145	Off	
		ELECTRONICA	A.31 (16)	Sequence Pad	Arpeggio	Layer	130	On
			A.32 (17)	Bleeps Perc.	Arpeggio	Single	94	On
A.33 (18)			Gated Sync Bass	Bass	Single	102	Off	
A.34 (19)			Flap & Sweep	Arpeggio	Single	135	On	
A.35 (20)	Reverse Lead		Synth Lead	Single	130	Off		
A.36 (21)	IDM Pad		Strings/Pad	Single	120	Off		
A.37 (22)	Flanger 5th Pad		Strings/Pad	Single	160	Off		
A.38 (23)	Voice /A/		Strings/Pad	Single	100	Off		
D'n'B/BREAKS	A.41 (24)		2 Step Bass	Bass	Layer	136	Off	
	A.42 (25)		Techstep Ring Bass	Bass	Single	170	Off	
	A.43 (26)	Valve Kick Bass	Bass	Layer	170	Off		
	A.44 (27)	Drive Bass	Bass	Single	170	Off		
	A.45 (28)	Blade Bass	Bass	Layer	140	Off		
	A.46 (29)	Sweep Sync Lead	Synth Lead	Single	170	Off		
	A.47 (30)	Science Lead	Synth Lead	Single	130	Off		
	A.48 (31)	Gated Chord	Synth	Single	130	Off		
	HIPHOP/VINTAGE	A.51 (32)	Dirty Bass	Bass	Layer	90	Off	
		A.52 (33)	MG Bass 1	Bass	Single	90	Off	
A.53 (34)		R&B Lead	Synth Lead	Single	90	Off		
A.54 (35)		PWM Strings	Strings/Pad	Single	90	Off		
A.55 (36)		Reed Piano	KBD	Single	114	Off		
A.56 (37)		British Organ	KBD	Single	184	Off		
A.57 (38)		Synth Clav	KBD	Single	120	Off		
A.58 (39)		Tape Choir	Strings/Pad	Single	90	Off		
RETRO		A.61 (40)	Elektric Arpeg.	Arpeggio	Single	118	On	
		A.62 (41)	Water Edge	Arpeggio	Layer	140	On	
	A.63 (42)	80's Synth Bass	Bass	Single	103	On		
	A.64 (43)	Reverse Sync Lead	Synth Lead	Single	140	Off		
	A.65 (44)	Bright Poly Synth	Synth	Single	120	Off		
	A.66 (45)	Poly Synth	Synth	Single	134	Off		
	A.67 (46)	Warm 4th Pad	Strings/Pad	Single	100	Off		
	A.68 (47)	Octave Strings	Strings/Pad	Single	90	Off		
	S.E./HIT	A.71 (48)	Killa Beez	S.E.	Single	120	Off	
A.72 (49)		Diginator	S.E.	Layer	240	On		
A.73 (50)		Stutter	S.E.	Single	120	Off		
A.74 (51)		Invaders	S.E.	Single	80	Off		
A.75 (52)		Ring Chord	Hit	Single	135	Off		
A.76 (53)		Sweep min Chord	Hit	Single	135	Off		
A.77 (54)		Noisy Hit	Hit	Layer	142	Off		
A.78 (55)		4 OSC m7 Chord	Hit	Layer	148	Off		
VOCODER		A.81 (56)	Male-Ahhh	Vocoder	Vocoder	120	Off	
		A.82 (57)	Male-Eeee	Vocoder	Vocoder	120	Off	
	A.83 (58)	Male-Ahhh 5th	Vocoder	Vocoder	120	Off		
	A.84 (59)	Vocoder Ensemble	Vocoder	Vocoder	120	Off		
	A.85 (60)	Vocoder Chorus	Vocoder	Vocoder	120	Off		
	A.86 (61)	Vocoder 5th	Vocoder	Vocoder	120	Off		
	A.87 (62)	Bass Vocoder	Vocoder	Vocoder	120	Off		
	A.88 (63)	Voice Changer	Vocoder	Vocoder	120	Off		

BANK	No. (MIDI)	Name	Category	Single/Layer	Tempo	Arpeggio		
TRANCE	B.11 (64)	Synth Harp	Arpeggio	Single	138	On		
	B.12 (65)	Acid Ring Bass	Bass	Single	138	Off		
	B.13 (66)	Unison Ring Lead	Synth Lead	Single	138	On		
	B.14 (67)	Phaser Lead	Synth Lead	Single	138	Off		
	B.15 (68)	Synth Pizz	Synth	Layer	138	Off		
	B.16 (69)	Euphoric Synth	Synth	Single	138	Off		
	B.17 (70)	Flashin' Pad	Strings/Pad	Single	138	Off		
	B.18 (71)	Stream Pad	Strings/Pad	Single	138	Off		
	TECHNO/HOUSE	B.21 (72)	S&H Signal	Arpeggio	Single	138	On	
		B.22 (73)	Dirty Motion	Arpeggio	Layer	124	On	
		B.23 (74)	Short Ring Perc.	Arpeggio	Layer	140	On	
		B.24 (75)	Organ Bass	Bass	Single	132	Off	
		B.25 (76)	Unison SQU Bass	Bass	Single	145	Off	
		B.26 (77)	Detune Bass	Bass	Single	130	Off	
		B.27 (78)	Short Synth Bass	Bass	Single	134	Off	
		B.28 (79)	NRG Stab	Synth Lead	Layer	130	Off	
		ELECTRONICA	B.31 (80)	Noize Blasts	Arpeggio	Layer	140	On
			B.32 (81)	Future Perc.	Arpeggio	Single	97	On
B.33 (82)	Rhythmic Pad		Synth	Single	130	Off		
B.34 (83)	Pump Organ		Synth	Single	82	Off		
B.35 (84)	Lazy Pitch		Synth	Single	128	Off		
B.36 (85)	BPF 4th Pad		Strings/Pad	Single	148	Off		
B.37 (86)	Future Pad		Strings/Pad	Single	110	Off		
B.38 (87)	Shadow Pad		Strings/Pad	Single	122	Off		
D'n'B/BREAKS	B.41 (88)		X-Mod Bass	Bass	Layer	136	Off	
	B.42 (89)		Pipe Bass	Bass	Single	85	Off	
	B.43 (90)	Reverse Bass	Bass	Single	136	Off		
	B.44 (91)	RingSync Bass	Bass	Single	134	Off		
	B.45 (92)	HPF Sweep Bass	Bass	Single	133	Off		
	B.46 (93)	Nu Skool Drop	Bass	Single	125	Off		
	B.47 (94)	Modulation Lead	Synth Lead	Single	130	Off		
	B.48 (95)	Grimey Storm	Arpeggio	Single	136	On		
	HIPHOP/VINTAGE	B.51 (96)	Dark Bass	Bass	Single	90	Off	
		B.52 (97)	MG Bass 2	Bass	Single	90	Off	
B.53 (98)		Sub Bass	Bass	Single	90	Off		
B.54 (99)		70's Funk Lead	Synth Lead	Single	87	Off		
B.55 (100)		Rock Organ	KBD	Single	120	Off		
B.56 (101)		Perc. Organ	KBD	Single	120	Off		
B.57 (102)		Phaser Clav	KBD	Single	120	Off		
B.58 (103)		String Machine	Strings/Pad	Single	120	Off		
RETRO		B.61 (104)	Analog Bell	Arpeggio	Single	139	On	
		B.62 (105)	Stairs Pad	Arpeggio	Layer	140	On	
	B.63 (106)	Triangle Lead	Synth Lead	Single	135	Off		
	B.64 (107)	Random Comp	Synth	Single	144	Off		
	B.65 (108)	Stab Saw	Synth	Single	140	Off		
	B.66 (109)	Square Comp	Synth	Single	144	Off		
	B.67 (110)	Detuned Comp	Synth	Single	178	Off		
	B.68 (111)	Old Strings	Strings/Pad	Single	127	Off		
	S.E./HIT	B.71 (112)	Time Zone SFX	S.E.	Single	134	Off	
		B.72 (113)	Domin8or	S.E.	Single	125	Off	
B.73 (114)		Thunder	S.E.	Layer	34	Off		
B.74 (115)		Cry	S.E.	Single	137	Off		
B.75 (116)		HPF m7 Chord	Hit	Layer	120	Off		
B.76 (117)		M3rd Chord	Hit	Layer	130	Off		
B.77 (118)		Hardcore Hit	Hit	Layer	139	Off		
B.78 (119)		Artcore M7 Chord	Hit	Layer	176	Off		
VOCODER		B.81 (120)	Female-Ahhh	Vocoder	Vocoder	120	Off	
		B.82 (121)	Kid-Eeey	Vocoder	Vocoder	120	Off	
	B.83 (122)	Kid-Ahhh (Wow)	Vocoder	Vocoder	120	Off		
	B.84 (123)	Vocoder Pulse	Vocoder	Vocoder	120	Off		
	B.85 (124)	Vocoder SQU	Vocoder	Vocoder	120	Off		
	B.86 (125)	Vocoder Wah	Vocoder	Vocoder	200	Off		
	B.87 (126)	Vocoder Vox Wave	Vocoder	Vocoder	120	Off		
	B.88 (127)	Vocoder DWGS	Vocoder	Vocoder	120	Off		

Parameter List

EDIT SELECT 1/2	Type	1	2	3	4	5
VOICE (→p.16)	SYNTH/VOCODER	SYNTH/VOCODER Synthesizer, Vocoder	SINGLE/LAYER Single, Layer	VOICE ASSIGN Mono, Poly, Unison	TRIGGER MODE Single, Multi	UNISON DETUNE 0...99
PITCH (→p.17)	SYNTH/VOCODER	TRANSPOSE -24...24	TUNE -50...50	PORTAMENTO 0...127	BEND RANGE -12...12	VIBRATO INT -63...63
OSC1 (→p.18)	SYNTH/VOCODER	WAVE Saw, Square, Triangle, Sine, Vox, DWGS	CONTROL 1 0...127	CONTROL 2 0...127	—	—
OSC2 (→p.22)	SYNTH	WAVE Saw, Square, Triangle	OSC MOD OFF, Ring, Sync, RingSync	SEMITONE -24...24	TUNE -63...63	—
AUDIO IN 1 (→p.33)	VOCODER	GATE SENSE 0...127	THRESHOLD 0...127	HPF LEVEL 0...127	HPF GATE Disable, Enable	—
MIXER (→p.23)	SYNTH	OSC 1 LEVEL 0...127	OSC 2 LEVEL 0...127	NOISE LEVEL 0...127	—	—
MIXER (→p.34)	VOCODER	OSC 1 LEVEL 0...127	INST LEVEL 0...127	NOISE LEVEL 0...127	—	—
FILTER (→p.24)	SYNTH	TYPE -24dB LPF, -12dB LPF, -12dB BPF, -12dB HPF	CUTOFF 0...127	RESONANCE 0...127	FILTER EG INT -63...63	FILTER KEY TRACK -63...63
FILTER (→p.35)	VOCODER	FORMANT SHIFT 0, 1, 2, -1, -2	CUTOFF -63...63	RESONANCE 0...127	E.F.SENSE 0...126, Hold	—
FILTER EG (→p.26)	SYNTH	ATTACK 0...127	DECAY 0...127	SUSTAIN 0...127	RELEASE 0...127	EG RESET OFF, ON
FC MOD (→p.36)	VOCODER	SOURCE AMP EG, LFO 1, LFO 2, Velocity, KBD Track, Pitch Bend, MOD.Wheel	INTENSITY -63...63	—	—	—
AMP (→p.27)	SYNTH	LEVEL 0...127	PANPOT L63...Center...R63	DISTORTION OFF, ON	KBD TRACK -63...63	—
AMP (→p.37)	VOCODER	LEVEL 0...127	DIRECT LEVEL 0...127	DISTORTION OFF, ON	KBD TRACK -63...63	—
AMP EG (→p.28)	SYNTH/VOCODER	ATTACK 0...127	DECAY 0...127	SUSTAIN 0...127	RELEASE 0...127	EG RESET OFF, ON
LFO 1 (→p.29)	SYNTH/VOCODER	WAVE Saw, Square1, Triangle, Sample&Hold	KEY SYNC OFF, Timbre, Voice	TEMPO SYNC OFF, ON	FREQUENCY/SYNC NOTE 0...127/1.1...1.32	—
LFO 2 (→p.29)	SYNTH/VOCODER	WAVE Saw, Square2, Sine, Sample&Hold	KEY SYNC OFF, Timbre, Voice	TEMPO SYNC OFF, ON	FREQUENCY/SYNC NOTE 0...127/1.1...1.32	—
PATCH 1, 2, 3, 4 (→p.30)	SYNTH	SOURCE FILTER EG, AMP EG, LFO 1, LFO 2, Velocity, KBD Track, Pitch Bend, MOD.Wheel	DEST Pitch, OSC2 Tune, OSC1 Control1, Noise Level, CutOff, Amp, Pan, LFO2 Frequency	MOD INT -63...63	—	—
CH LEVEL A (→p.38)	VOCODER	CH 1 LEVEL 0...127	CH 2 LEVEL 0...127	CH 3 LEVEL 0...127	CH 4 LEVEL 0...127	—
CH LEVEL B (→p.38)	VOCODER	CH 5 LEVEL 0...127	CH 6 LEVEL 0...127	CH 7 LEVEL 0...127	CH 8 LEVEL 0...127	—
CH PAN A (→p.38)	VOCODER	CH 1 PAN L63...Center...R63	CH 2 PAN L63...Center...R63	CH 3 PAN L63...Center...R63	CH 4 PAN L63...Center...R63	—
CH PAN B (→p.38)	VOCODER	CH 5 PAN L63...Center...R63	CH 6 PAN L63...Center...R63	CH 7 PAN L63...Center...R63	CH 8 PAN L63...Center...R63	—
MOD FX (→p.40)	SYNTH/VOCODER	TYPE Chorus/Flanger, Ensemble, Phaser	LFO SPEED 0...127	EFFECT DEPTH 0...127	—	—
DELAY (→p.41)	SYNTH/VOCODER	TYPE Stereo Delay, Cross Delay, L/R Delay	TEMPO SYNC OFF, ON	DELAY TIME/SYNC NOTE 0...127/1.32...1.1	DELAY DEPTH 0...127	—
EQ (→p.42)	SYNTH/VOCODER	LOW EQ FREQ. 40...1.00	LOW EQ GAIN -12...12	HI EQ FREQ. 1.00...18.0	HI EQ GAIN -12...12	—
ARPEG. A (→p.44)	SYNTH/VOCODER	TEMPO 20...300	RESOLUTION 1/24...1/4	GATE 0...100	TYPE Up, Down, Alternate 1, Alternate 2, Random, Trigger	RANGE 1...4
ARPEG. B (→p.45)	SYNTH/VOCODER	LATCH OFF, ON	SWING -100...100	KEY SYNC OFF, ON	LAST STEP 1...8	TARGET TIMBRE Both, Timbre 1, Timbre 2
GLOBAL (→p.47)	GLOBAL	MASTER TUNE 30.0...50.0	MASTER TRANSPOSE -12...12	VELOCITY CURVE Curve, 1...127	POSITION Post KBD, Pre TG	AUDIO IN THRU OFF, ON
MIDI (→p.51)	MIDI	MIDI CH 1...16	LOCAL OFF, ON	CLOCK Internal, External, Auto	—	—

SHIFT Function List

SHIFT Function	Type	Operation 1	2	(Value)	3	(Value)	4
COPY TIMBRE (CP.t)	SYNTH	[SHIFT]+[1]key	[1] knob	A.11 ... b.88	[1] key	—	—
INIT LEVEL (in.L)	VOCODER	[SHIFT]+[1]key	[1] key	—	—	—	—
SWAP TIMBRE (Sw.t)	SYNTH	[SHIFT]+[2]key	[2] key	—	—	—	—
INIT PAN (in.P)	VOCODER	[SHIFT]+[2]key	[2] key	—	—	—	—
INIT PROGRAM (ini)	SYNTH/VOCODER	[SHIFT]+[3]key	[3] key	—	—	—	—
MIDI FILTER (Flt)	SYNTH/VOCODER	[SHIFT]+[4]key	[1] knob	Program Change Enable/Disable	—	—	—
			[2] knob	Control Change Enable/Disable	—	—	—
			[3] knob	Pitch Bend Enable/Disable	—	—	—
			[4] knob	System Exclusive Enable/Disable	—	—	—
CONTROL CHANGE (C.Cg)	SYNTH/VOCODER	[SHIFT]+[5]key	[EDIT SELECT 1/2]+[1]...[5]	OFF, CC#00...CC#95	—	—	—
MIDI DATA DUMP (dmP)	SYNTH/VOCODER	[SHIFT]+[6]key	[1] knob	1Program, Program, Global, All	[6] key	—	—
PRELOAD (Pld)	SYNTH/VOCODER	select Dest Prog, [SHIFT]+[7]key	[1] knob	1Program	[2] knob	A.11 ... b.88	[7] key
		[SHIFT]+[7]key	[1] knob	Program, Global	[7] key	—	—
WRITE PROTECT (wt.P)	SYNTH/VOCODER	[SHIFT]+[8]key	[1] knob	OFF, ON	—	—	—
TIMBRE SOLO	—	[SHIFT]+[TIMBRE SELECT]key	—	—	—	—	—
SWITCH EDIT SELECT	—	[SHIFT]+[BANK SIDE]key	—	—	—	—	—
INC PARAM VALUE	—	[SHIFT]+[UP]key	—	—	—	—	—
DEC PARAM VALUE	—	[SHIFT]+[DOWN]key	—	—	—	—	—
ENTER DEMO MODE	—	[SHIFT]+ARPEGGIATOR[ON/OFF]key	—	—	—	—	—

DEMO Song List

No.	Name
1	"TRANCE" DEMO
2	"TECHNO/HOUSE" DEMO
3	"ELECTRONICA" DEMO
4	"D'n'B/BREAKS" DEMO
5	"HIPHOP/VINTAGE" DEMO
6	"RETRO" DEMO
7	"S.E./HIT" DEMO
8	"VOCODER" DEMO

All Demo Songs: © 2002 KORG Inc. — all rights reserved.

microKORG

MIDI Implementation Chart

Function		Transmitted	Recognized	Remarks
Basic Channel	Default	1 – 16	1 – 16	Memorized
	Changed	1 – 16	1 – 16	
Mode	Memorized	×	3	
	Messages	×	×	
	Altered	*****	×	
Note Number:	True Voice	0 – 127	0 – 127	
		*****	0 – 127	
Velocity	Note On	○ 1 – 127	○ 1 – 127	
	Note Off	○ 64	×	
Aftertouch	Polyphonic (Key)	×	×	
	Monophonic (Channel)	×	×	
Pitch Bend		○	○	* B
Control Change	1	○	○	Modulation wheel *C
	6	○	○	Data Entry (MSB) *C
	98, 99	○	○	NRPN (LSB, MSB) *C
	120, 121	×	○	All sound off, Reset all controllers *C
	0 – 95	○	○	Sync control *C
	0 – 95	○	○	Timbre select *C
	0 – 95	○	○	Panel controls (knob, SW) *1, *C
Program Change	Variable Range	○ 0 – 127	○ 0 – 127	* P
		*****	0 – 127	
System Exclusive		○	○	* 2, * E
System Common	Song Position	×	×	
	Song Select	×	×	
	Tune	×	×	
System Real Time	Clock	○	○	* 3
	Command	×	○	* 3
Aux Messages	Local On/Off	×	×	
	All Notes Off	×	○ 123 – 127	
	Active Sense	○	○	
	Reset	×	×	
Remarks *P, *C, *B, *E: Transmitted/received when MIDI Filter (ProgChg, CtrlChg, P.Bend, SystemEx) settings are respectively ENA. *1: Received according to the CTRL CHANGE setting. *2: In addition to Korg exclusive messages, Inquiry messages, Master Volume messages and Master Fine Tune messages are also supported. *3: When the MIDI "Clock" is internal, transmitted but not received. The opposite for External or Auto.				

Mode 1: OMNI ON, POLY

Mode 2: OMNI ON, MONO

○ : Yes

Mode 3: OMNI OFF, POLY

Mode 4: OMNI OFF, MONO

×

Consult your local Korg distributor for more information on MIDI IMPLEMENTATION. / Veuillez vous adresser à votre revendeur Korg pour une copie de l'équipement MIDI. / Weitere Informationen zur MIDI IMPLEMENTATION erhalten Sie bei Ihrem Händler oder dem Korg-Vertrieb Ihres Landes.

MIDI Implementationの配布については、コルグお客様相談窓口へお問い合わせください。