

MEGA MAN THE POWER BATTLE

© CAPCOM CO., LTD.
©CAPCOM U.S.A., INC. 1995 ALL RIGHTS RESERVED

OPERATORS MANUAL



WARNING

This game is for use in the United States of America and Canada. Sales, export or operation outside of these countries may be constructed as copyright and trademark infringements and is strictly prohibited. Violators are subject to severe penalties and will be prosecuted to the full extent of the law.

CAPCOM[®] COIN-OP, INC.

3311 N. Kennicott Avenue
Arlington Heights, Illinois 60004

Phone: (847) 797-6100

Fax: (847) 797-6306

PM00133-KIT
021696

THANK YOU FOR PURCHASING *MEGA MAN : THE POWER BATTLE™*. WE INVITE YOU TO USE THE FOLLOWING MAILING ADDRESS, TELEPHONE OR FAX NUMBER FOR PARTS OR SERVICE INFORMATION CONCERNING THIS GAME:

CAPCOM® COIN-OP, INC.
ATTN: FIELD SERVICE - VIDEO PRODUCTS
3311 N. KENNICOTT AVENUE
ARLINGTON HEIGHTS, ILLINOIS 60004
PHONE: (708) 797-6100
FAX: (708) 797-6306

THE SERIAL NUMBERS FOR YOUR CONVERSION KIT ARE LOCATED ON THE PC BOARDS, AS SHOWN BELOW. PLEASE HAVE THESE SERIAL NUMBERS AVAILABLE WHEN CONTACTING US FOR SERVICE INFORMATION.

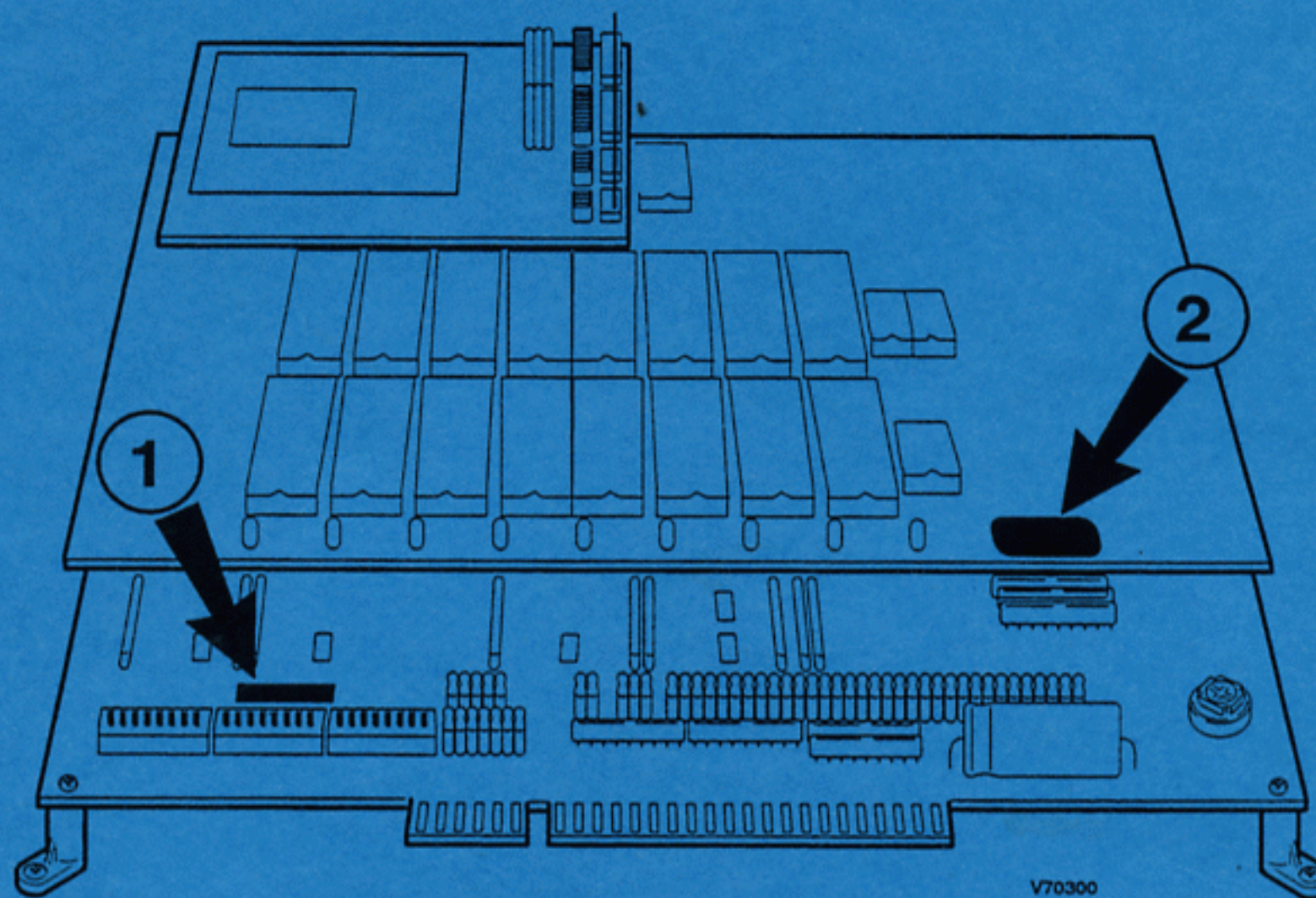

PLEASE RECORD THE SERIAL NUMBERS HERE:

1) CAPCOM S/N: _____

2) AAMA S/N: _____

TABLE OF CONTENTS

<i>Warranty Information</i>	i
<i>Kit Inspection</i>	1
<i>Kit Installation</i>		
Preparation	3
Installation	3
Marquee	3
Control Panel Components	4
Cabinet Decals	4
Control Panel Wiring	5
Speaker Wiring	5
PC Board Wiring	6
DIP Switch Settings	7
<i>Test Mode</i>		
Test Menu	9
Accessing the Menu	9
How to Select an Item	10
Closing the Menu	10
Menu Item Descriptions	10
DIP Switch Menu	11
Accessing the Menus	11
Menu Item Descriptions	11
Making Changes in the Menu	12
Clearing a DIP Switch Error	12
Menu Item Descriptions	15
<i>JAMMA Connections</i>	13
 <i>Template : Control Panel Drill Hole(s)</i>		

LIMITED PRODUCT WARRANTY (APPLIES TO DOMESTIC SALES ONLY)

CAPCOM® COIN-OP, INC. (Seller), warrants only to the initial purchaser of its products, that the items listed below are free from defects in material and workmanship under normal use and service for the warranty periods specified:

- | | |
|--|------------------|
| A. CPS I System Board Set | Ninety (90) Days |
| B. Electronic and Mechanical Components: | Ninety (90) Days |

No other part of Seller's products are warranted.

Warranty periods are effective from the initial date of shipment from seller to its authorized distributors.

Seller's sole liability shall be, at its option, to repair or replace products which are returned to Seller during the warranty periods specified, provided:

- A. Seller is notified promptly upon discovery by buyer that stated products are defective;
- B. Such products are properly packaged and then returned, prepaid to Seller's designated plant.

This warranty does not apply to any parts damaged during shipment or handling, or due to improper installation or usage, or alteration. In no event shall Seller be liable for any anticipated profits, loss of profits, loss of use, incidental or consequential damages or any other losses incurred by the customer in connection with the purchase of a CAPCOM® COIN-OP, INC. product.

WARRANTY DISCLAIMER

EXCEPT AS SPECIFICALLY PROVIDED IN A WRITTEN CONTRACT BETWEEN SELLER AND PURCHASER, THERE ARE NO OTHER WARRANTIES, EXPRESSED OR IMPLIED, INCLUDING ANY IMPLIED WARRANTIES OF MERCHANTABILITY OR FITNESS FOR A PARTICULAR PURPOSE.

IMPORTANT NOTICE

THIS SHIPMENT HAS BEEN CAREFULLY INSPECTED AND PROPERLY PACKAGED BEFORE LEAVING THE FACTORY. WE CANNOT ASSUME RESPONSIBILITY FOR BREAKAGE THAT MAY OCCUR DURING TRANSPORTATION OF THE GAME. IF THIS GAME IS DAMAGED UPON RECEIPT FROM THE CARRIER, IMMEDIATELY NOTIFY THE CARRIER AND FILE A DAMAGE REPORT.

KIT INSPECTION

MEG1000 kit contains the CPS I System PC board set. It also includes all the necessary game graphics for a cabinet conversion (marquee, control panel overlay, monitor card, etc.) and replacement joysticks and button switches. The "FULL" kit is intended for conversion of most JAMMA-compatible, horizontal screen cabinets.

Add a check mark to the parts that have been shipped with your kit. If any parts are missing, contact your distributor immediately.

KIT PARTS LIST

MEG1000	PART NO.	DESCRIPTION	QTY
	A-00541	CPS I System PC Board Set	1
	GE1200	Monitor Card	1
	AW00180	Marquee	1
	06-0074	Overlay, Control Panel	1
	AW00179	Decal, Joystick & Button Switches	1
	AW00147	Decal, Cabinet Side	2
	LB00176	Decal, Game Play Instruction	1
	PM00133-KIT	Manual, Operators	1
	GE2030	Joystick	2
	16-0130	Switch, 1-Player Start Button (White)	1
	16-0131	Switch, 2-Player Start Button (White)	1
	16-0133	Switch, Button (Red)	2
	16-0134	Switch, Button (Blue)	2
	16-0136	Switch, Button (Green)	2
	SC00104-05	Screw, Wood	4

CAUTION

Please read the following instructions to keep the PC boards in good condition:

- ◆ Do not drop or bump the boards.
- ◆ Do not spill any liquids on the boards.

DISASSEMBLING THE BOARDS OR REMOVING STICKERS MAY CAUSE THE TERMINATION OF YOUR REPAIR WARRANTY.

KIT INSTALLATION



WARNING:

MAKE SURE ELECTRICAL POWER TO THE GAME IS OFF BEFORE STARTING THE KIT INSTALLATION.

PREPARATION

1. Disconnect and remove the old printed circuit board(s) or cartridges from the cabinet.
2. Remove or open the control panel, and disconnect and remove the buttons and joystick(s) from the control panel.
3. Remove any plastic covering from the control panel overlay, and then remove the control panel overlay.
4. Place the Drill Hole template (found in the back of this manual) over the control panel to determine where any new holes should go. Center punch any needed new holes on the control panel.
5. Cut out the new holes using a 1-3/16" hole saw.
6. If there is an additional control panel *cover (such as plastic or lexan) that will be utilized, cut any additional holes using the same template. *Cover is not included in the kit.
7. Plug up unused holes with a wood dowel (1-1/8" diameter) and sand any rough edges.

INSTALLATION

Marquee Installation

8. Remove the marquee glass, marquee overlay, and the cabinet graphics.
9. Install the new marquee and replace the *glass. *Glass is not included in this kit.

Control Panel Overlay Installation (See Figure 1)

10. The control panel overlay in the kit is oversized to accommodate most control panel sizes. Center

the overlay on the control panel, leaving some excess material at the edges.

11. Remove the protective backing from the overlay and press it down on the control panel, keeping it properly aligned. Press it down firmly, smooth out any bubbles, and press it over the edges.

12. Trim any excess from the overlay. Place the drill hole template on top of the overlay, aligning it with the joystick holes. Pierce through the overlay at each control panel hole. Then, cut away overlay material covering the joystick and button holes. Remove the template and clean off the overlay.

13. Peel off the backings of the button and joystick decals, align over the control panel holes, and press in place on the overlay (refer to the drill hole template for proper placement). Using a knife, trim material from the center hole of the joystick decal.

14. Install the control panel *cover (if required).

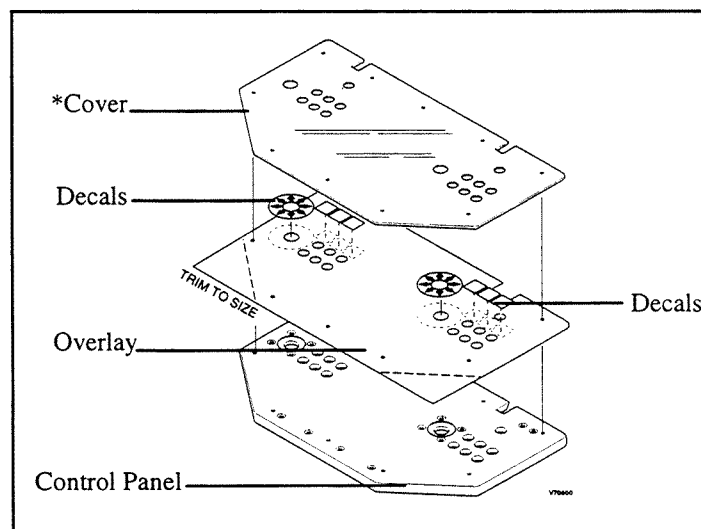

Figure 1
Overlay Installation

Reassembly of Components

15. Install all buttons and retaining rings on the control panel as shown in Figure 2. Install a RED button to the immediate right of each joystick, install a GREEN button to the right of the red one, and install a BLUE button to the right of the green one. All remaining holes should be capped with a button plug or doweled and sanded smooth.

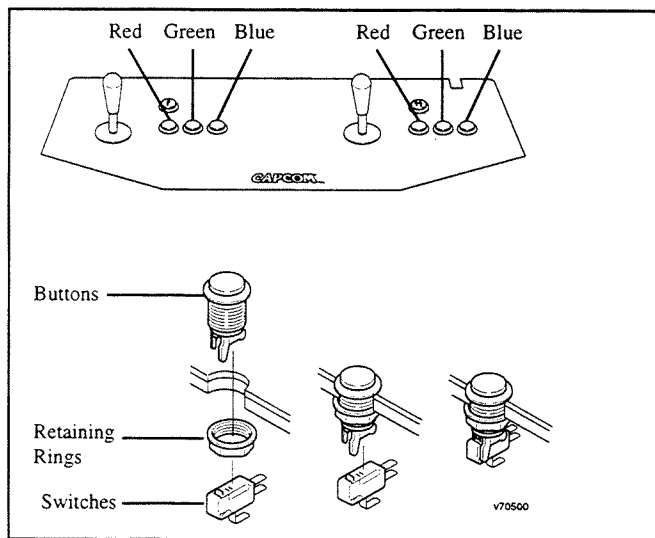

FIGURE 2

Control Panel Buttons and Switches

16. Notice that there are two white buttons. (See Figure 3.) The WHITE buttons are START buttons. Install the PLAYER ONE button on the top left-hand side of the control panel, and the PLAYER TWO button on the top right-side of the control panel.

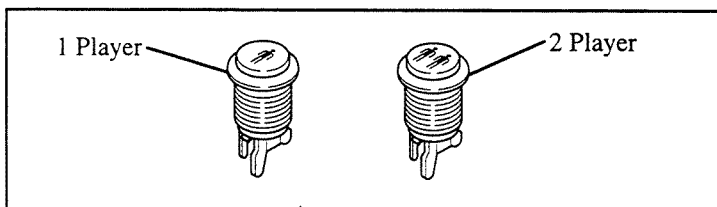

FIGURE 3

Start Buttons

17. Install the switches on the buttons as shown in Figure 2. Orient the switches so that when a button is pressed, the red contact on the switch is depressed.

18. Install the joysticks on the control panel as shown in Figure 4.

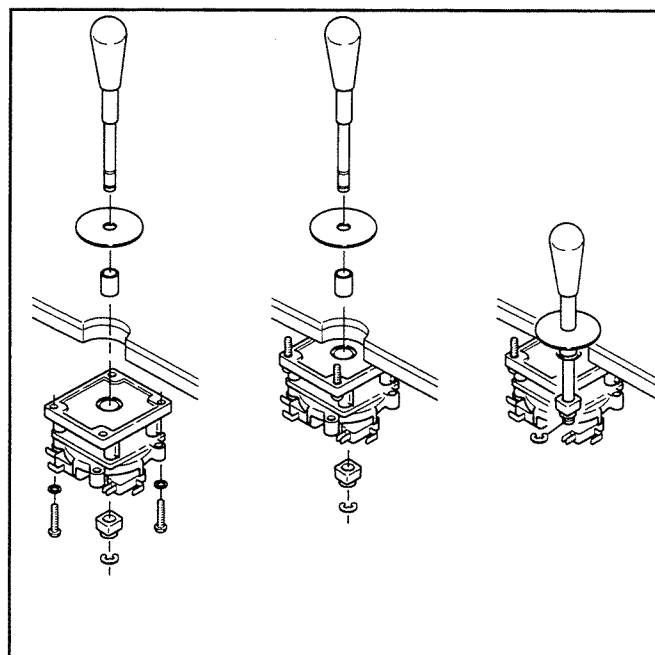

FIGURE 4

Joystick Installation

CABINET DECAL INSTALLATION

19. Remove monitor glass and install monitor card.

20. Peel-off the backing to the instruction decal and place on the bottom of the monitor card. (See Figure 5). Also, apply the cabinet decals to both sides of the cabinet.

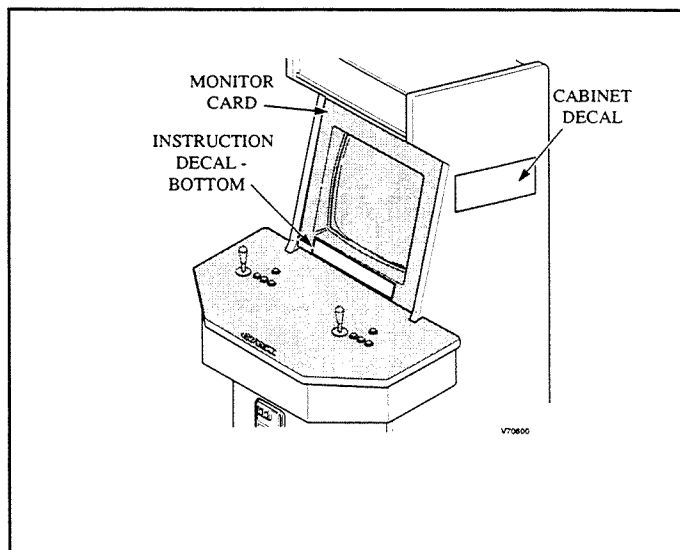

FIGURE 5

Cabinet Decal Installation

SYSTEM WIRING

CONTROL PANEL WIRING

NOTE:

All switch wires used in this game must be wired to the normally-open connection on the switches. Each switch requires a ground wire on the common connector and the appropriate control or switch wire on the normally-open connector of the switch.

21. Reconnect the existing JAMMA connectors to the control panel according to the following chart:

JAMMA CONNECTOR REF.	*WIRE COLOR	CONNECTS TO	COMPONENT	FUNCTION
18	WHITE/BLACK	PLAYER 1	JOYSTICK	UP
19	WHITE/BROWN	PLAYER 1	JOYSTICK	DOWN
20	WHITE/RED	PLAYER 1	JOYSTICK	LEFT
21	WHITE/ORANGE	PLAYER 1	JOYSTICK	RIGHT
22	WHITE/YELLOW	PLAYER 1	BUTTON SWITCH	ATTACK
23	WHITE/GREEN	PLAYER 1	BUTTON SWITCH	JUMP
24	WHITE/BLUE	PLAYER 1	BUTTON SWITCH	WEAPON CHANGE
V	VIOLET/BLACK	PLAYER 2	JOYSTICK	UP
W	VIOLET/BROWN	PLAYER 2	JOYSTICK	DOWN
X	VIOLET/RED	PLAYER 2	JOYSTICK	LEFT
Y	VIOLET/ORANGE	PLAYER 2	JOYSTICK	RIGHT
Z	VIOLET/YELLOW	PLAYER 2	BUTTON SWITCH	ATTACK
a	VIOLET/GREEN	PLAYER 2	BUTTON SWITCH	JUMP
b	VIOLET/BLUE	PLAYER 2	BUTTON SWITCH	WEAPON CHANGE

Figure 6: JAMMA Wiring Connections

* **Wire Color Note:** Wire colors shown are according to the AAMA -AMOA Standard for wire color assignments; your harness may contain wire colors that are different than shown above.

SPEAKER WIRING

22a. If you are converting a cabinet that is not equipped with CAPCOM® Q-SOUND, the speaker terminal connections are established through the JAMMA harness. No additional wiring is required.

22b. If you are converting a cabinet that is equipped with CAPCOM® Q-SOUND, **Q-SOUND WILL BE DISABLED DURING THIS GAME.** Check the existing JAMMA harness for wired connections to the speaker terminals.

PC BOARD INSTALLATION

23. Secure the PC boards to a cabinet shelf or the cabinet sidewall with wood screws, as shown in Figure 7.

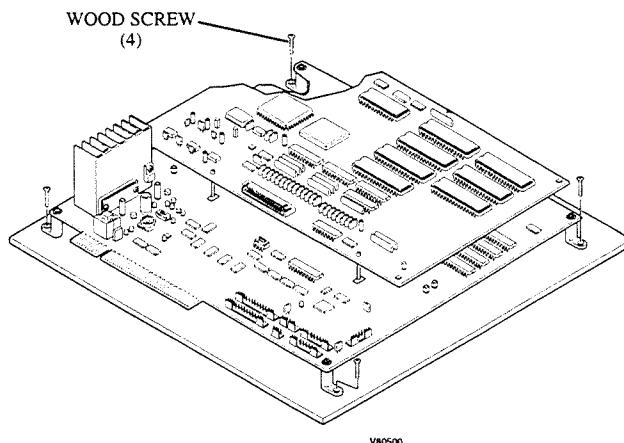

Figure 7: PC Board Mounting

PC BOARD WIRING CONNECTIONS AND ADJUSTMENTS

24. Connect the JAMMA harness connector to the edge connector located on the bottom PC board, as shown in Figure 8 below:

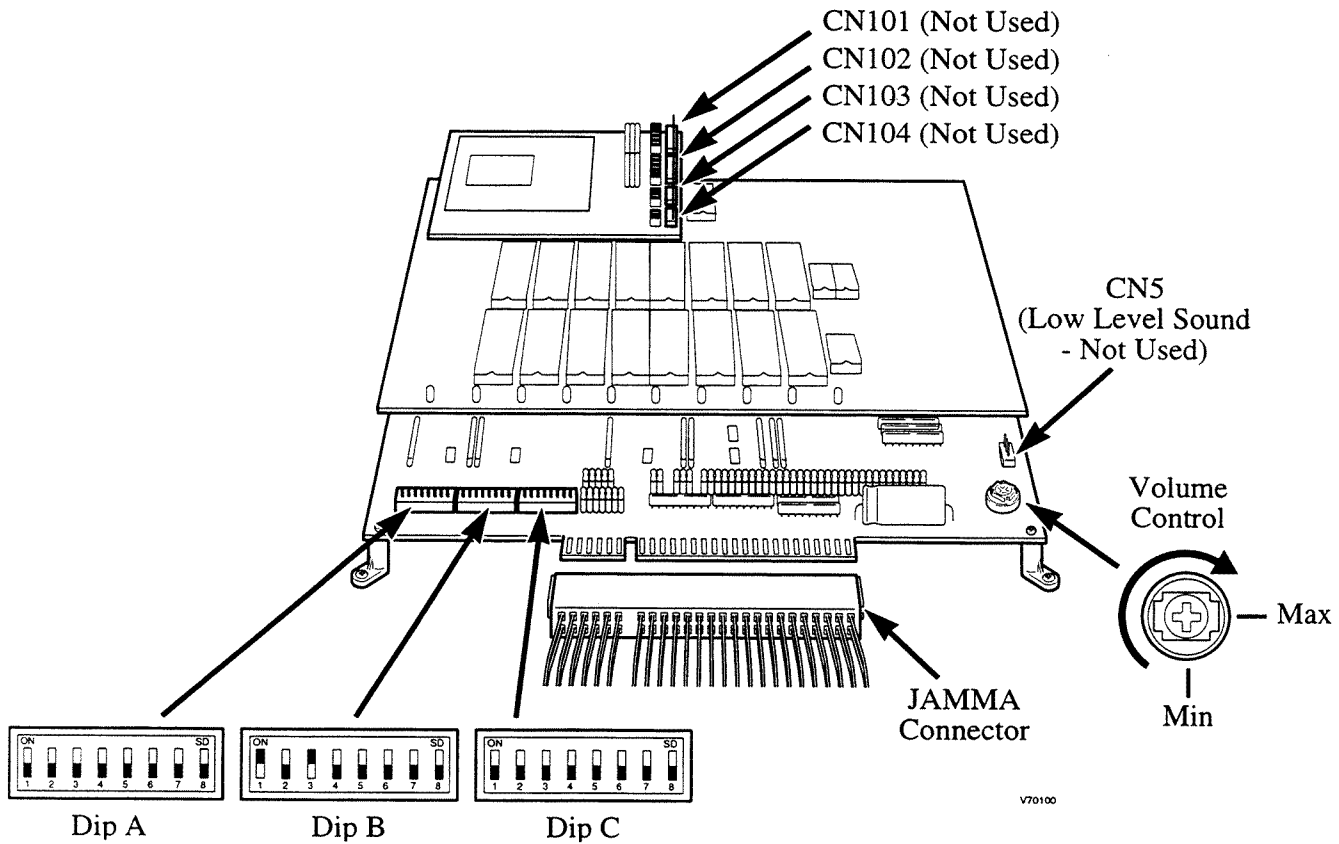

Figure 8: PC Board Wiring & Controls



WARNING

Improper installation of the JAMMA harness connector to the PC board connector will cause damage to the PC board.

25. The DIP switches are factory preset and are applicable for most locales. You may elect to re-configure the DIP switches for your location. When the game is powered-up, place the game in Test mode by moving DIP switch C-8 to the "ON" position and open the *Test Menu* to DIP SWITCH. This will allow the games' software to verify and confirm your settings.

DIP SWITCH SETTINGS

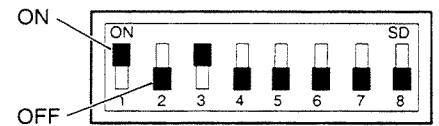

V70900

DIP SWITCH "A"

SW. REF	ITEM	SETTINGS	SW1	SW2	SW3	SW4	SW5	SW6	SW7	SW8
1,2,3,4,5	COIN MODE	1 COIN 1 CREDIT	OFF	OFF	OFF	OFF	OFF			
		1 COIN 2 CREDITS	ON	OFF	OFF	OFF	OFF			
		1 COIN 3 CREDITS	OFF	ON	OFF	OFF	OFF			
		1 COIN 4 CREDITS	ON	ON	OFF	OFF	OFF			
		1 COIN 5 CREDITS	OFF	OFF	ON	OFF	OFF			
		1 COIN 6 CREDITS	ON	OFF	ON	OFF	OFF			
		1 COIN 7 CREDITS	OFF	ON	ON	OFF	OFF			
		1 COIN 8 CREDITS	ON	ON	ON	OFF	OFF			
		1 COIN 9 CREDITS	OFF	OFF	OFF	ON	OFF			
		2 COINS 1 CREDIT	ON	OFF	OFF	ON	OFF			
		3 COINS 1 CREDIT	OFF	ON	OFF	ON	OFF			
		4 COINS 1 CREDIT	ON	ON	OFF	ON	OFF			
		5 COINS 1 CREDIT	OFF	OFF	ON	ON	OFF			
		6 COINS 1 CREDIT	ON	OFF	ON	ON	OFF			
		7 COINS 1 CREDIT	OFF	ON	ON	ON	OFF			
8 COINS 1 CREDIT	ON	ON	ON	ON	OFF					
9 COINS 1 CREDIT	OFF	OFF	OFF	OFF	OFF					
6,7	CHUTE TYPE	2 CHUTES SINGLE						OFF	OFF	
		2 CHUTES MULTI						ON	OFF	
		1 CHUTE SINGLE						OFF	ON	
8	NOT USED	ALWAYS "OFF"								OFF

DIP SWITCH "B"

SW. REF	ITEM	SETTINGS	SW1	SW2	SW3	SW4	SW5	SW6	SW7	SW8
1,2	DIFFICULTY	EASY	OFF	OFF						
		NORMAL	ON	OFF						
		HARD	OFF	ON						
		VERY HARD	ON	ON						
3,4	START TIME	EASY			OFF	OFF				
		NORMAL			ON	OFF				
		HARD			OFF	ON				
		VERY HARD			ON	ON				
5,6,7,8	NOT USED	ALWAYS "OFF"					OFF	OFF	OFF	OFF

DIP SWITCH "C"

SW. REF	ITEM	SETTINGS	SW1	SW2	SW3	SW4	SW5	SW6	SW7	SW8
1	MONITOR	NORMAL	OFF							
		FLIP	ON							
2	DEMO SOUND	ON		OFF						
		OFF		ON						
3	CONTINUE	ON			OFF					
		OFF			ON					
4	NOT USED	ALWAYS "OFF"	OFF	OFF	OFF	OFF	OFF	OFF	OFF	OFF
5	NOT USED	ALWAYS "OFF"	OFF	OFF	OFF	OFF	OFF	OFF	OFF	OFF
6	NOT USED	ALWAYS "OFF"	OFF	OFF	OFF	OFF	OFF	OFF	OFF	OFF
7	NOT USED	ALWAYS "OFF"	OFF	OFF	OFF	OFF	OFF	OFF	OFF	OFF
8	MODE	GAME MODE								OFF
		TEST MODE								ON

FACTORY DEFAULT SETTING

26. Power-up the game and adjust the speaker volume by turning the Volume Control pot clockwise. to increase volume, or counterclockwise to decrease volume (see Figure 12).
27. Set all operator adjustable options by pressing the DIP switch C-8 to **ON** (TEST mode). Follow the instructions under the ***TEST MENU*** section of this manual.

TEST MENU

The test menu allows you to test the functions and configure the game. These items include input devices such as joysticks, buttons and coin switches, output devices such as monitor, speakers and meters. To re-configure the game settings from the factory default settings, select the DIP SWITCH Menu.

1. ACCESSING THE TEST MENU

- **For a CAPCOM® cabinet, or a cabinet with a test switch:**
Make sure the game is on and push the test switch. The screen shown below will appear.
- **For a cabinet without a test switch:**
Push DIP switch C-8, located on the lower PC board, to the **ON** position (TEST mode).

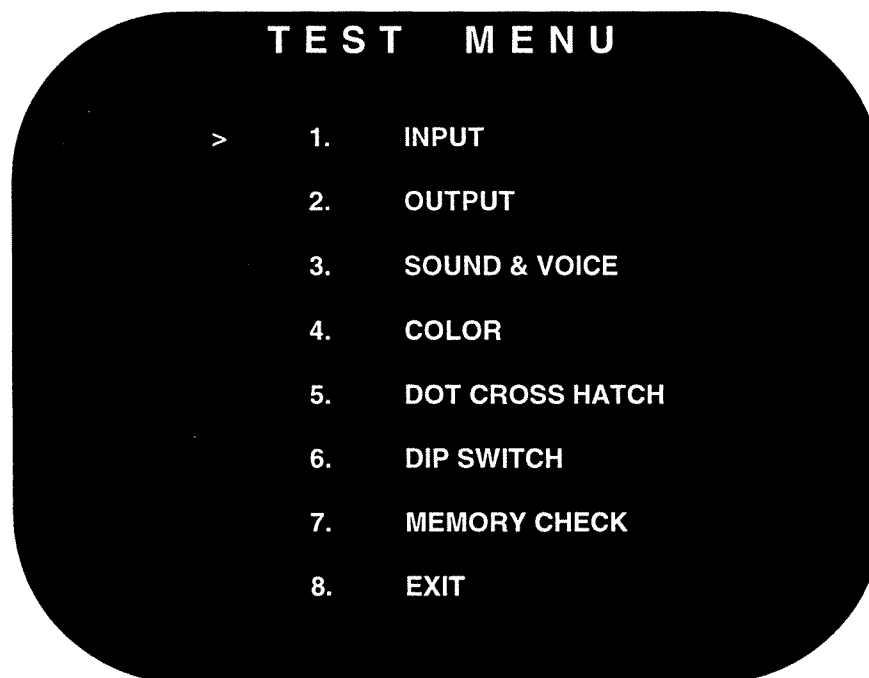

2. HOW TO SELECT AN ITEM

- Use the *PLAYER 1 JOYSTICK* to move the arrow in front of the desired item and press the *PLAYER 1 ATTACK* button.

- To return to the test menu, push the *PLAYER 1 START* and *PLAYER 2 START* buttons simultaneously.
- The Test Menu will always appear on the screen after the memory is tested from the menu, “8. MEMORY CHECK”.

3. CLOSING THE TEST MENU

To close the Test Menu, highlight “9. EXIT” and push the *PLAYER 1 ATTACK* button.

4. TEST MENU ITEM DESCRIPTIONS

INPUT	Used to test all the input switches, such as joysticks and buttons. The “0” changes to a “1” as the button is pushed or joystick is moved. Check connections and switches in case the “0” doesn’t change to a “1” when depressed or moved.
OUTPUT	Used to test the coin meter and the coin lock.
SOUND & VOICE	Select a code of SOUND or VOICE with the <i>PLAYER 1 JOYSTICK</i> . Push the <i>PLAYER 1 ATTACK</i> button to hear the sound of the selected code.
COLOR	Shows color bars of red, green, blue, and white. Adjust RGB and brightness to obtain the optimum color balance and solid black background.
DOT CROSS HATCH	Used to test the screen size, focus and distortion.
DIP SWITCH	Used to change the configuration settings of the game. Refer to the separate DIP SWITCH sub-menu.
MEMORY CHECK	Used to test memory. “OK” appears when each block of memory passes test, “NG” appears in case of malfunction. If “NG” appears, repeat the memory test and wait for the “OK” message. Contact your distributor if “NG” still appears.
EXIT	Select this item and push the <i>PLAYER 1 ATTACK</i> button to return to game play mode.

DIP SWITCH MENU (SYSTEM CONFIGURATION)

The Dip Switch menu is used to change various game settings such as level of difficulty, credits, demo sounds, etc. These settings are not stored in EEPROM memory and are read directly from the dip switches.

ACCESSING THE DIP SWITCH MENU:

- From the TEST MENU, move the arrow to “6. DIP SWITCH” and push the *PLAYER 1 ATTACK* button. The screen shown below will be displayed. A description of each option is explained in the accompanying chart.

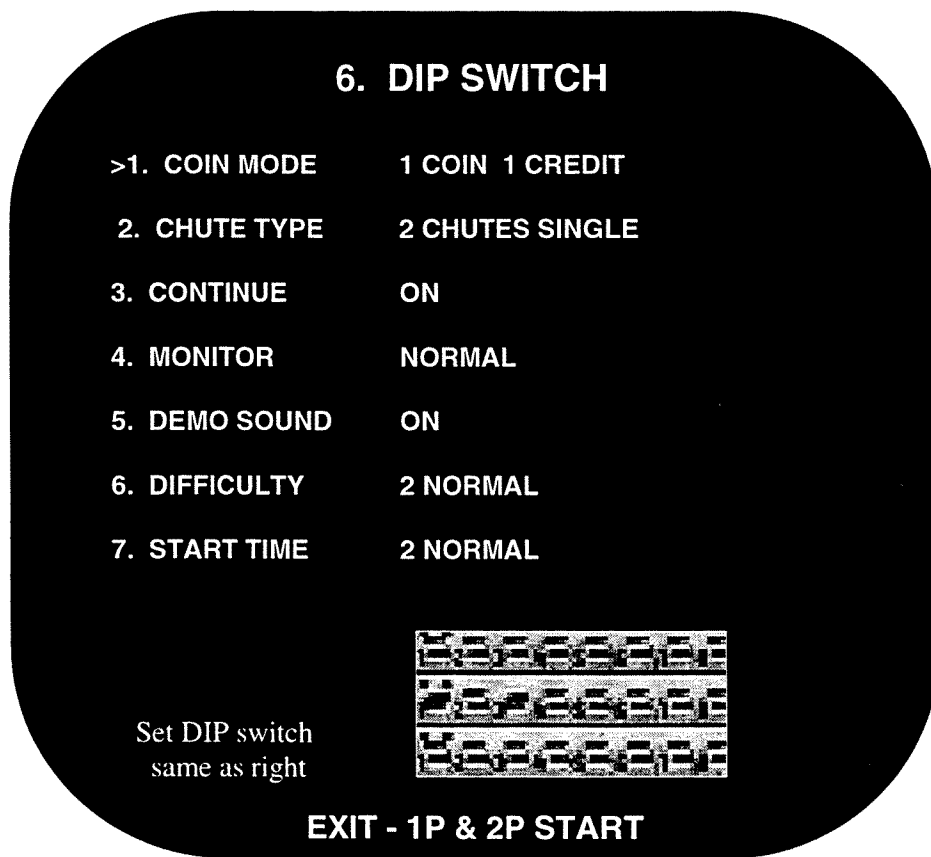

DIP SWITCH MENU ITEM DESCRIPTIONS

1. COIN MODE	SELECT THE CHARGE PER PLAY.
2. CHUTE TYPE	SELECT THE NUMBER OF PLAYER(S) AND COIN CHUTES. 1 CHUTE SINGLE: WITH THIS SETTING, EITHER PLAYER CAN START THE GAME. 2 CHUTES SINGLE: TWO PLAYERS USE ONE COIN CHUTE AND PLAY AT THE SAME TIME. THE PLAYER WHOSE COIN WAS PUT IN FIRST STARTS THE GAME. 2 CHUTES MULTI: TWO PLAYERS USE TWO COIN CHUTES AND PLAY SEPARATELY. THE GAME STARTS FROM THE SAME SIDE AS THE COIN CHUTE WAS USED.
3. CONTINUE	SELECT ON FOR CONTINUOUS PLAY OR OFF.
4. MONITOR	FLIPS THE POSITION OF THE SCREEN. IF THE SCREEN APPEARS UPSIDE DOWN, CHANGE THE SETTING TO FLIP ; IF THE SCREEN APPEARS CORRECT, SELECT NORMAL .
5. DEMO SOUND	TURNS ATTRACT SOUNDS ON OR OFF.
6. DIFFICULTY	SETS THE DIFFICULTY LEVEL OF THE GAME.
7. START TIME	SETS THE AMOUNT OF TIME ALLOWED FOR LEVEL PLAY.

MAKING CHANGES IN THE DIP SWITCH MENU

To change a setting, move the *PLAYER 1 JOYSTICK* to highlight the desired item . Once the option is highlighted, move the *PLAYER 1 JOYSTICK* left or right to scroll though the list of options. To save an item, press the *PLAYER 1 ATTACK* button.

NOTE: Once an item is selected, the DIP switch must be set correctly to exit this Menu. If the DIP switch is not properly configured, an error message (*Undefined DIP switch!!*) will appear on screen and the affected DIP switch(s) will be highlighted in the switch bank icon block, as shown below:

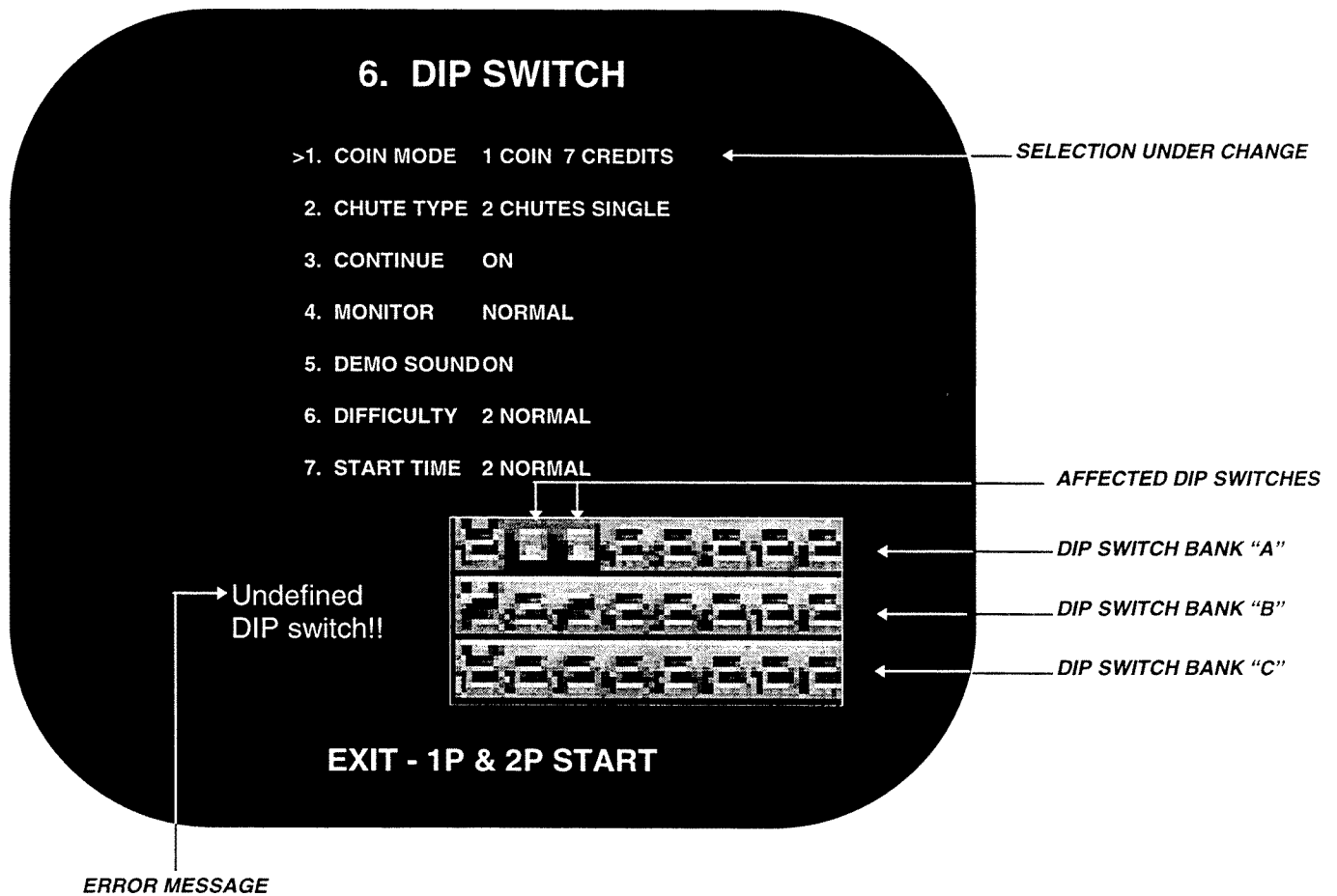

CLEARING A DIP SWITCH ERROR

When an error occurs, refer to the DIP Switch Settings table found earlier in "System Wiring". You must compare your *current* settings with the settings listed for the *new* item. Toggle the affected switches on the PC board to their proper state (ON, OFF). Changes in Coinage settings require you to configure as many as 5 switches; all other settings are typically 1 or 2 switches.

JAMMA Connections

SOLDER SIDE			COMPONENT SIDE
GND	A	1	GND
GND	B	2	GND
+5 VDC	C	3	+5 VDC
+5 VDC	D	4	+5 VDC
N.C.	E	5	N.C.
+12 VDC	F	6	+12 VDC
KEY	H	7	KEY
N/C	J	8	COIN COUNTER 1
COIN LOCK 2	K	9	COIN LOCK 1
SPEAKER (-)	L	10	SPEAKER (+)
N.C.	M	11	N.C.
VIDEO GREEN	N	12	VIDEO RED
VIDEO SYNC	P	13	VIDEO BLUE
SERVICE (FREE CREDIT)	R	14	VIDEO GROUND
N/C	S	15	TEST MODE
COIN 2	T	16	COIN 2
2 PLAYER - START	U	17	1 PLAYER - START
2 PLAYER - UP	V	18	1 PLAYER - UP
2 PLAYER - DOWN	W	19	1 PLAYER - DOWN
2 PLAYER - LEFT	X	20	1 PLAYER - LEFT
2 PLAYER - RIGHT	Y	21	1 PLAYER - RIGHT
2 PLAYER - ATTACK	Z	22	1 PLAYER - ATTACK
2 PLAYER - JUMP	a	23	1 PLAYER - JUMP
2 PLAYER - WEAPON CHANGE	b	24	1 PLAYER - WEAPON CHANGE
N/C	c	25	N/C
N/C	d	26	N/C
GND	e	27	GND
GND	f	28	GND

NOTES

1-3/4" DRILL FOR
JOYSTICK HOLE

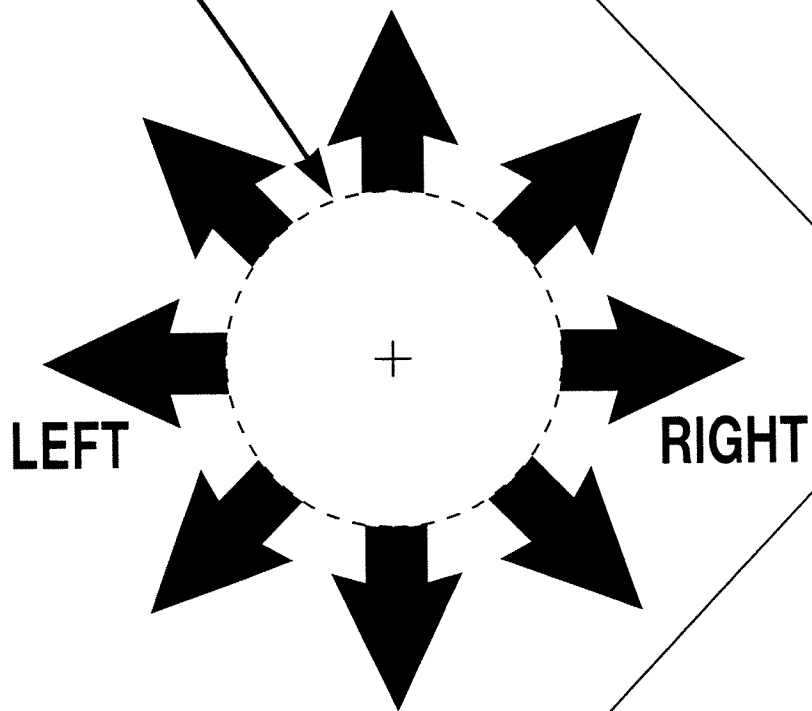

ATTACK

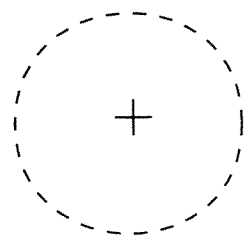

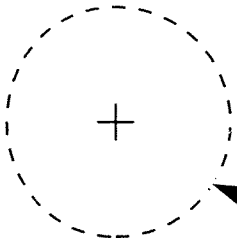

1-3/16" DRILL FOR
"PLAYER START"
BUTTON HOLE

JUMP

**WEAPON
CHANGE**

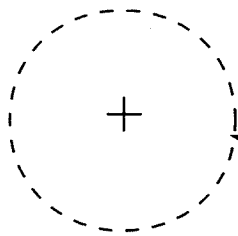
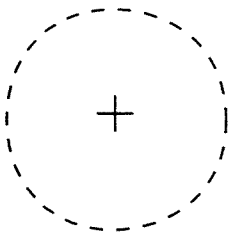

1-3/16" DRILL FOR
BUTTON HOLES

CAPCOM[®]
COIN-OP, INC.

C APCOM COIN-OP, INC.
3311 NORTH KENNICOTT AVENUE
ARLINGTON HEIGHTS, ILLINOIS 60004
PHONE (708) 797-6100
FAX (708) 797-6119

TITLE

DRILL TEMPLATE: "MEGAMAN"

DATE

2-15-96

DRAWN BY:

JA

V70700

REV.

REFERENCE INFORMATION

PC BOARDS: CONNECTORS & CONTROLS

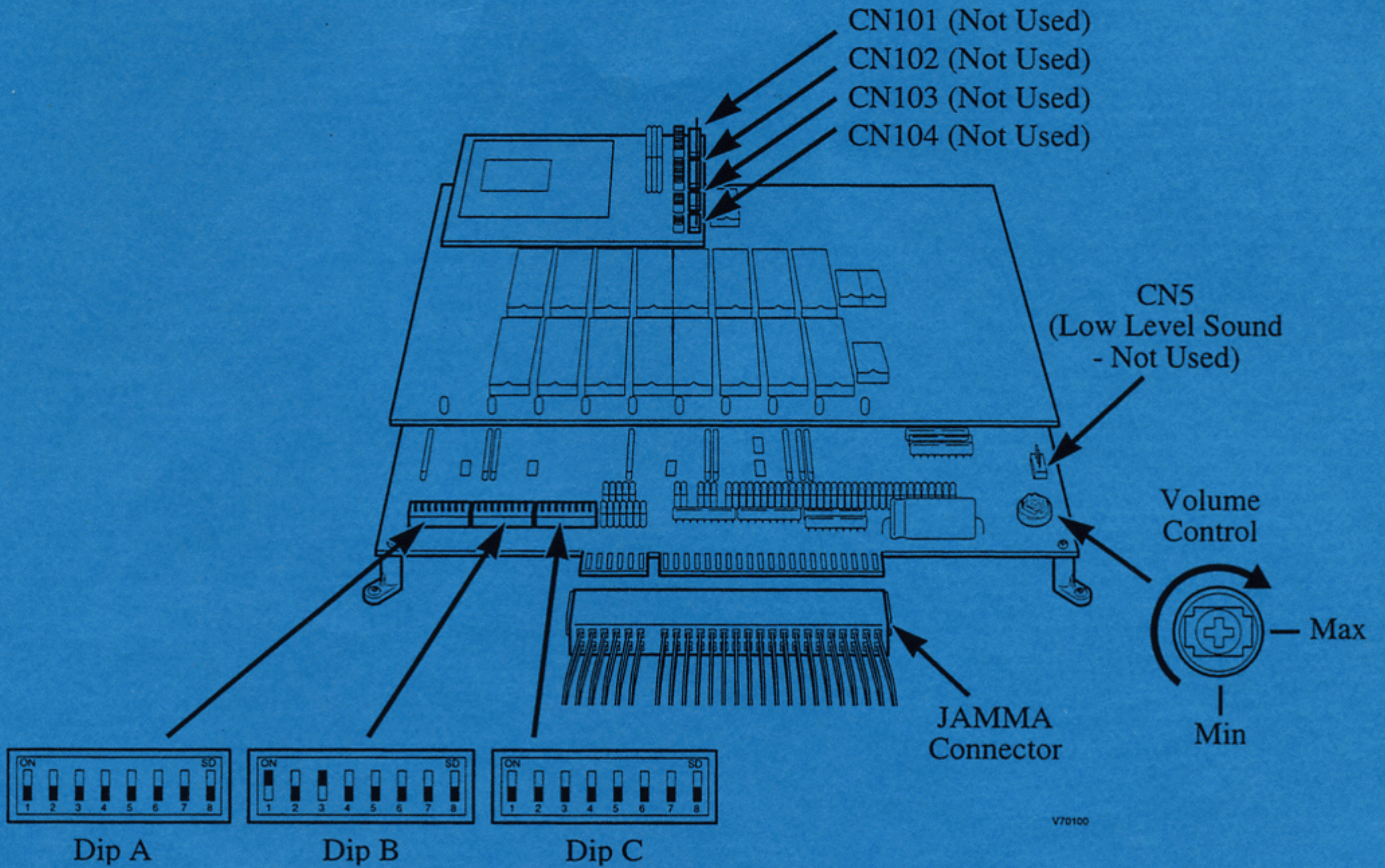

TYPICAL CONTROL PANEL LAYOUT OF MEGA MAN : THE POWER BATTLE™

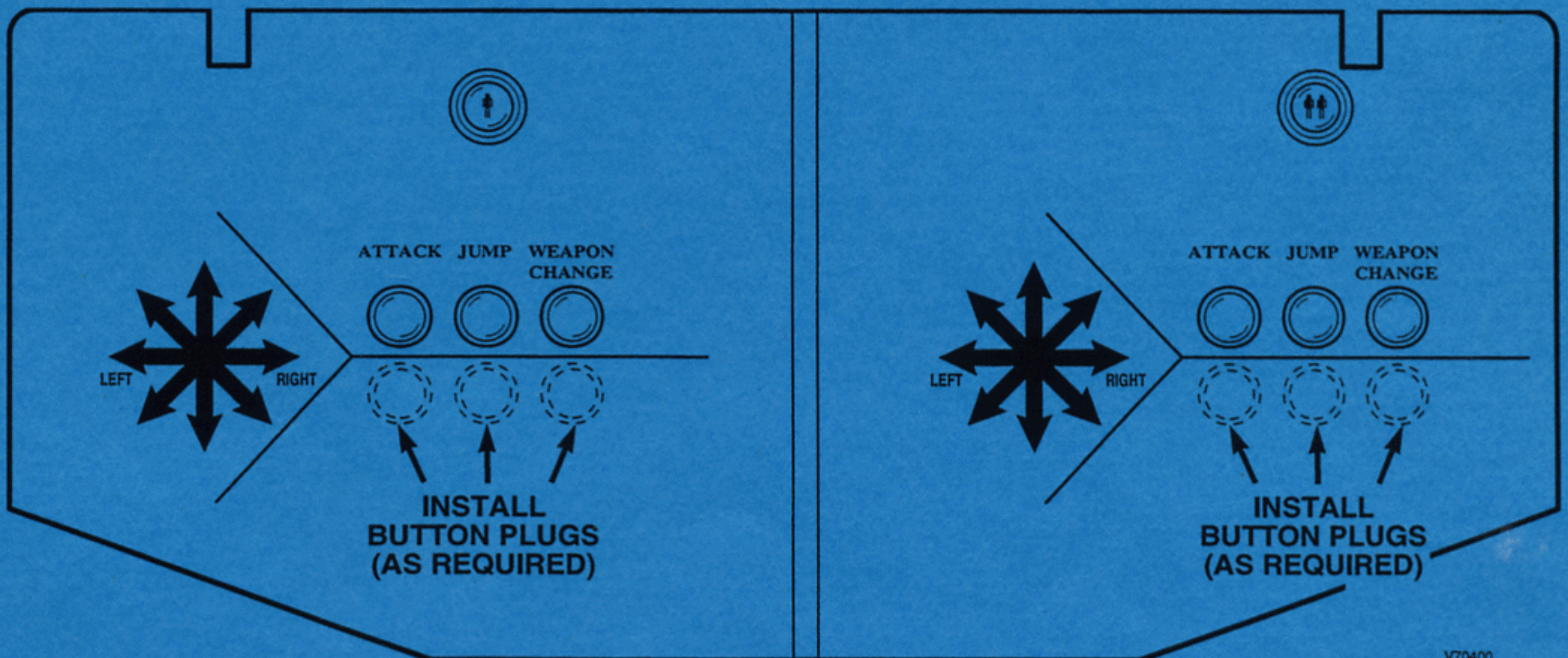

NOTICE

This equipment has been tested and found to comply with the limits for a Class A digital device, pursuant to Part 15 of the FCC Rules. These limits are designed to provide reasonable protection against harmful interference when the equipment is operated in a commercial environment. This equipment generates, uses, and can radiate radio frequency energy and, if not installed and used in accordance with the instruction manual, may cause harmful interference to radio communications. Operation of this equipment in a residential area is likely to cause harmful interference, in which case the user will be required to correct the interference at his own expense.

FBI



WARNING

Federal law provides severe civil and criminal penalties for the unauthorized reproduction, distribution, or exhibition of copyrighted audiovisual works and video games.

The Federal Bureau of Investigation investigates allegations of criminal copyright infringement.

CAPCOM[®] COIN-OP, INC.

3311 N. Kennicott Avenue
Arlington Heights, Illinois 60004

Phone: (847) 797-6100

Fax: (847) 797-6306