



MIDI REAL TIME RECORDER

MRC-300

for MC-300

ADVANCED USERS / APPLICATIONS MANUAL
BASIC USERS / APPLICATIONS MANUAL

Quick Operation Table

NOTE ON HANDLING THE FLOPPY DISK

MC-300 MICROCOMPOSER

INDEX

	<u>Page</u>
Section #2	
FORMAT OF THE MC-300	
Product Description	2-1
MRC-300 Software	2-2
Alpha Dial	2-2
Ten Key Pad	2-2
Display	2-2
Stand By Mode	2-3
Tracks	2-3
Memory Capacity (Avail Memo)	2-3
Song Number	2-4
Section #3	
DISK MANAGEMENT	
Utility Mode	3-1
Initializing New Disks	3-1
Backing Up Disks	3-2
Transferring Song Files	3-3
Restarting	3-4
Disk Mode	3-4
Loading Files from Disk	3-5
Disk Directory	3-5
Saving Songs to Disk	3-6
Deleting Songs from Disk	3-7
Renaming a Song File on Disk	3-7
Chapter #4	
THE MIDI BUTTON	
MIDI Functions	4-1
#1 Receive Channel	4-1
#2 Receive Polyphonic After-Touch	4-2

	Control Change	4-3
	Control Change Chart	4-4
#3	Receive Control Change A	4-5
#4	Receive Control Change B	4-5
#5	Receive Program Change	4-6
#6	Receive Channel (Mono- phonic) After-Touch	4-6
#7	Receive Pitch Bend	4-7
#8	Receive System Exclusive	4-7
#9	Transmit Channel (Output Assignments)	4-7
#10	Transmit Clock	4-9
#11	Transmit System Exclusive	4-10
#12	Soft Thru (Mix)	4-10

Section #5

FUNCTION BUTTON

Functions		5-1
#1	Sync Clock	5-1
#2	Metronome	5-2
#3	Song Title	5-2
#4	Rhythm Velocity	11-4
#5	Rhythm Instrument	11-3
#6	Rhythm MIDI Channel	11-2
#7	Block Repeat	5-3
#8	Auto Stop	5-4
#9	Basic Tempo	5-4

Section #6

REAL TIME RECORDING

Description of Real Time Recording	6-1
Procedure for Real Time Recording	6-1
Recording from the Middle or End of a Song	6-2
Overdubbing	6-3

Recording Non-Note Information in Real Time	6-4
Punch In/Out	6-5
Recording System Exclusive	6-6
Roland MKS-80 Super Jupiter	6-7
Roland Alpha Juno 1-2	6-7
Roland JX-8P	6-7
DX-7/ TX-7	6-8
Roland Juno-106	6-9

Section #7

STEP TIME RECORDING

Description of Step Recording	7-1
Pitch	7-1
Note Resolution	7-1
Gate Time	7-1
Velocity	7-1
Selecting a MIDI Channel	7-2
Selecting a Gate Time	7-2
Using an External MIDI Controller	7-2
Selecting the Note Resolution	7-3
Clock Pulse Time (CPT)	7-4
Procedure for Step Recording	
From an External MIDI Controller	7-5
Extra Functions	7-7
Step Loading from the Alpha Dial or Ten Key Pad	7-7
Extra Functions	7-9

Section #8

THE EDIT BUTTON

Description of Edit Button	8-1
Measure Editing Functions	8-1
#1 Erase	8-2
#2 Delete	8-3

#3	Insert	8-4
#4	Merge	8-5
#5	Extract MIDI Channel	8-6
#6	Transpose	8-7
#7	Change Velocity	8-9
	Slope	8-9
	Bias	8-9
#8	Change MIDI Channel	8-11
#9	Quantize	8-12
#10	Copy	8-14

Section #9

MICROSCOPE EDITING

Description of Microscope Editing	9-1
Changing a Single MIDI Event	9-1
Note Event	9-2
Polyphonic After-Touch	9-2
Control Change	9-3
Program Change	9-4
Channel (Monophonic) After-Touch	9-5
Pitch Bend	9-6
System Exclusive	9-7
Delete Event	9-7
Deleting any Single MIDI Event	9-7
Inserting a Single MIDI Event	9-8
Note Event	9-8
Polyphonic After-Touch	9-9
Control Change	9-10
Program Change	9-11
Channel (Monophonic) After-Touch	9-12
Pitch Bend	9-12
System Exclusive	9-13
Tune Request	9-14
Change Clock Pulse Time (CPT)	9-15

Changing the Clock Pulse Time (CPT) of a Single MIDI Event	9-15
---	------

Section #10

TEMPO TRACK

Description of Tempo Track	10-1
Real Time	10-1
Step Time	10-2

Section #11

THE RHYTHM / CONDUCTOR TRACK

Description of the Rhythm/Conductor Track	11-1
Rhythm Pattern	11-1
Rhythm Track	11-1
MIDI Functions	11-2
Rhythm MIDI channel function	11-2
MIDI note numbers	11-3
Rhythm Instrument	
Viewing the Instrument Names and Note Assignments	11-3
Changing the Instrument Name and Note Assignments	11-3
Rhythm Velocity	11-4
Writing a Rhythm Pattern	11-4
Flam	11-6
Erasing a Rhythm Pattern	11-7
Copy Function	11-8
Writing a Rhythm Track	11-8
Edit Function	11-9
Entering Rests	11-10
Using the Rhythm Track as a Conductor Track	11-10
Writing a Conductor Track	11-11
Chart of Individual Rests and Measures	11-13

Section #12

CHAIN PLAY

Description of Chain Play	12-1
Assigning Tempo	12-1
Arranging Songs	12-1
Playing Back a Chain	12-2

Section #13

SYNCHRONIZING TO EXTERNAL DEVICES

Description of Synchronizing to External Devices	13-1
External Device (slave) to the MC-300 (master)	13-1
MC-300 (slave) to an External Device (master)	13-2
Transferring Data	13-2
From the TR-707/727	13-2
From the TR-505 and Other Drum Machines	13-3
From an External Sequencer / Computer	13-3
Explanation of MIDI Song Position Pointer	13-5
Using the SBX-80 with the MC-300	13-6
Returning to Internal Sync	13-6
Tape Sync	13-7
Explanation of Tape Sync	13-7
Tips for Successful Tape Syncing	13-7
Procedure for Syncing the MC-300 to Tape	13-8

Section #14

ERROR MESSAGES

Explanation of Error Messages	14-1
Identification of Error Messages	14-1 - 14-9

MC-300 MICROCOMPOSER

ADVANCED USERS/ APPLICATIONS MANUAL

This manual is designed as a continuation to the "Basic Users/Applications Manual" and will provide advanced information about the operation and use of the MC-300 Microcomposer and MRC-300 software.

Section #2

FORMAT OF THE MC-300 SYSTEM

MRC-300 Software

The MRC-300 software disk turns the MC-300 (hardware) into a MIDI sequencer which will record and playback MIDI performance information. Once recorded, the MIDI information stored into the MC-300 can be extensively edited.

The format of the MC-300 is similar to a recording device like a tape machine. The MC-300 has tracks for storage of the performance information, and STOP, RECORD, and PAUSE buttons which function like those found on a tape machine.

For example, pressing the PAUSE button will stop the performance until the PLAY button is pressed again. To record a part, you simply press the REC button. You may stop recording or playback at any time by pressing the STOP button. The RESET button returns the song to measure #1. The SKIP button locates the song to its last measure.

Alpha Dial

The Alpha Dial is a master incremental controller used for entering information into the MC-300. These changes will be different depending on the mode of the MC-300. By rotating the Alpha Dial clockwise or counter-clockwise, you can scroll through events while in microscope mode, enter new values while editing, change functions, choose parameters you wish to edit and perform a variety of other functions.

Ten Key Pad

The Ten Key Pad is a multi-functional control which can perform different operations depending on which mode you are in. Like the Alpha Dial, the Ten Key Pad can be used for entering information.

Display

The MC-300 is provided with a 20 X 2 character back-lit display which is used to display pertinent information. The MC-300's display will assist you in performing the many functions of the MC-300 by prompting responses with the use of flashing characters and a cursor. The flashing characters

can be changed by rotating the Alpha Dial or by using the Ten Key Pad.

Stand By Mode

All recording and playback functions are performed in this display which is called the Stand By Mode.

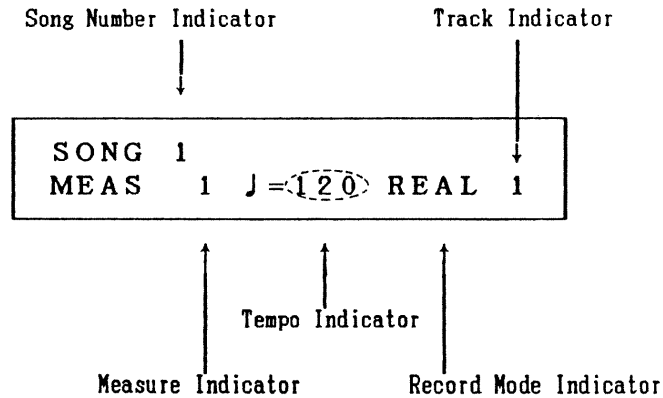

Tracks

The MC-300 is equipped with five tracks: one rhythm track and four tracks for entering MIDI performance information.

Tracks 1 through 4 store the MIDI performance information which can be loaded in real or step time. Once data is entered into a track, it is independent of the other tracks and can be edited without affecting the information on the other tracks.

Information on one track may be separated and sent to another track for further manipulation or editing. The tracks can be toggled "on" or "off" before listening to the performance in any combination simply by pressing the TRACK button. If there is data in the track, the display will light and the data will be played back. By pressing the TRACK button again, the light will disappear and that track will be silent during playback. The last track, which is not visible on the MC-300, is called the tempo track, and is used to store tempo information (such as ritards, accelerandos, and new tempos).

The Rhythm Track functions like a conductor track in that it contains the meter (time signatures) and the total song length. The rhythm track is used for programming drum patterns when using a MIDI drum machine or sampler with the MC-300.

Memory Capacity

The amount of available memory may be monitored at any time while in the Stand By Mode by pressing the AVAIL MEMO button. The display will indicate how much internal memory is available as well as how many songs exist in memory. At this point, pressing #'s 1-8 on the Ten Key Pad will display the percentage of memory each song has used.

The Disk Memory can be checked by holding the SHIFT key and pressing AVAIL MEMO. At this point, pressing the MICROSCOPE button will display how much space each file takes up on the disk. To view the other files on the disk, rotate the Alpha Dial. The MC-300 will store up to 25,000 notes in eight separate songs. When the maximum allotted memory is filled, the display will read "memory full."

The MRC-300 disk will store approximately four times the amount of the internal memory.

Song Number

The MC-300's internal memory allows you to store up to 8 different songs at one time. Numbers 1 to 8 will be automatically assigned with the lowest number (1) assigned to the first song written. To move through the song numbers, press and hold the SHIFT key; to move forward, press SKIP; to move backward, press RESET.

Songs in the internal memory can be saved onto floppy disk and loaded back into the MC-300 at any time (see instructions on "Saving to Disk). Songs can be independently edited.

The Song Numbers can be used in "Chain Playing" to link songs together in any order (see "Chain Play").

Remember, the capacity of the internal memory is limited. When memory reaches 5% of total memory, save your data to disk before proceeding with additional editing or recording functions (see "Saving Data").

Section #3

DISK MANAGEMENT

Disk Management

Disk management allows you to edit and update your song files, initialize new disks, and make back up disks. Disk management provides functions which will prevent the loss of valuable data.

Utility Mode

There are two modes for disk management, Utility and Disk. The Utility Mode contains the functions for formatting new disks, creating back up copies and transferring song files from one disk to another. The Disk Mode contains functions for Load, Save, Delete and Rename song files.

Utility Mode #1 Initializing New Disks

Procedure for Initializing (Formatting) New Disks

This function is used to create new MRC-300 software disks which can be used for storing your song files. It is a good idea to make several of these disks at a time, so you have a formatted disk available when you need it.

1. Go to the Stand By mode.
2. Press MODE button, select #4 (Utility) and press ENTER.
3. To load disk editing Utilities, press REC/LOAD.

Note: This erases all song data currently residing the MC-300 Internal memory (RAM).

① INIT	2 BACK UP
3 XFER	4 RESTART

4. Select #1 and press ENTER.
5. Insert the system disk and press ENTER.
The initializing system is now being loaded into the MC-300 internal memory (RAM). The MC-300 will beep when the loading process is completed. If you wish to exit this function at any time, press STOP to return to the Utility mode.

6. Insert new disk and press ENTER. The MRC-300 system is now being written onto the new disk.
 Note: This function will erase all information on the new disk. The MC-300 will beep when the initializing process is completed. If you want to initialize another new disk, press ENTER and repeat this step. When you are finished formatting new disks, press STOP.
7. Select #4 and press ENTER which restarts the MC-300 and returns you to Stand By mode.

Utility Mode #2
 Backing Up Disks

Procedure for Backing Up Disks

This function copies all of the information on the source disk onto another disk. This will include the MRC-300 system and the song files. It is not necessary to perform the Initialization procedure described in the previous step because initialization is automatically performed during the back up process. Any information on the new disk will be erased during the back up process.

1. Go to the Stand By mode.
2. Press MODE button, select #4 (Utility) and press ENTER.
3. To load disk editing Utilities, press REC/LOAD.

Note: This erases all song data currently residing in the MC-300 Internal memory (RAM).

① INIT	2 BACK UP
3 XFER	4 RESTART

4. Press #2 and ENTER.
5. Insert the disk to be backed up (source disk) and press ENTER. The source disk's information is now loaded into the internal memory (RAM) of the MC-300. The disk memory is approximately 4 times the internal memory of the MC-300. Therefore, backing up a full disk requires you to complete the process of loading the source disk into the MC-300 and saving it to the new disk approximately 4 times.

6. Insert the new disk and press ENTER.
7. If the destination disk already has the MRC-300 software, the display will ask "INIT to MRC again?: Yes: ENTER No: STOP". Press ENTER if you wish to continue. Note: This erases all information on the destination disk.
8. Repeat steps 5 and 6 until the display reads "BACK UP Complete! Press Stop". Turn the protect switch to the protect (on) position on the back up disk.
9. To return to Stand By mode, select #4, and press ENTER. Now the MRC-300 system is loaded into the internal memory.

Utility Mode #3
Transferring Song Files

Procedure for Transferring Song Files between Disks

The utility mode operates like the back up mode. However, song files (only) are copied, not the MRC-300 System program. This is useful for transferring song files to a new disk that already contains song files or updating older song files to a newer version.

1. Go to the Stand By mode.
2. Press MODE button, select #4 (Utility) and press ENTER.
3. To load disk editing Utilities, press REC/LOAD.
Note: This erases all song data currently residing in the MC-300 Internal memory (RAM).

① INIT	2 BACK UP
3 XFER	4 RESTART

4. Press #3 and ENTER.

5. Insert the disk which contains the song files you wish to copy (source) and press ENTER. The information on the source disk is now being loaded into the internal memory (RAM) of the MC-300. When the loading process is completed, the MC-300 will beep. The disk memory is approximately 4 times the internal memory of the MC-300. Therefore to transfer a disk full of song files requires you to complete the process of loading the source disk of the MC-300 and saving it to the new disk approximately 4 times. If you wish to exit this function and return to the Utility mode, press STOP.
6. Insert the new disk and press ENTER. When the saving process is completed, the MC-300 will beep.
7. Repeat steps 5 and 6 until the display reads: "XFER Complete! Press STOP".
NOTE: If the destination disk contains a song file with the same name as a song file on the source disk, the MC-300 will ask you if you wish to RENEW? (update) this song file to the new version. Pressing ENTER changes the destination disk's file to match the source disk's. Pressing STOP returns you to Utility mode.
8. To return to Stand By mode, select #4 and press ENTER. This reloads the MRC-300 system into the internal memory (RAM).

Utility Mode #4 Restarting

Procedure for Restarting (Exit Utility Mode)

This procedure reloads the MRC-300 system into the MC-300 and returns you to the Stand By mode.

1. You should now be in Utility mode.
2. Select #4 and press ENTER. The MC-300 is now loading the system from the disk.

Disk Mode

The Disk Mode contains the functions for loading, saving, removing, and renaming song files on your disk.

Disk Mode #1
Loading Files from
Disk

Procedure for Loading Files from Disk

1. Go to the Stand By mode.
2. Press MODE button.
3. Select #2 and press ENTER to access Disk Mode.

① LOAD	2 SAVE
3 DELETE	4 RENAME

4. Select #1 and press ENTER to access "Load".
5. Select the song number where you would like the song file to be loaded, press ENTER. (The MRC-300 will automatically select the first empty song in sequence. If you don't need a song currently in memory, you can go over it.)
6. Use the Alpha Dial to select which song you wish to load from the disk.
7. Press ENTER.
8. If the song title displayed is the one you wish to load, press REC/LOAD. To exit the Disk Mode, press STOP. When the song file has completed loading, the MC-300 will beep.
9. To return to Stand By mode, press MODE, select #1 (MIDI RECORDER), and press ENTER.

Disk Mode #1
Disk Directory

**Procedure for Using Load as a Disk Directory
Function**

The Load function in the disk mode can be used to view the songs on a disk.

1. Go to the Stand By mode.
2. Press the MODE button.
3. Select #2 and press ENTER to access Disk Mode.

① LOAD	2 SAVE
3 DELETE	4 RENAME

4. Press #1 and ENTER to access "Load".
5. Press ENTER. By moving the Alpha Dial, you get a directory of song files. To return to Disk Mode, press STOP.
6. To return to Stand By Mode, press MODE, the select #1 (MIDI Recorder Mode). Press ENTER.

Disk Mode #2
Saving Songs to Disk

Procedure for Saving Songs to Disk

The song data can be stored on the disk.

1. Go to the Stand By mode.
2. Press the MODE button.
3. Select #2 and press ENTER to access Disk mode.

1	LOAD	2	SAVE
3	DELETE	4	RENAME

4. Press #2 and ENTER to select "Save".
5. Select which song number you want to save, press ENTER.
6. If you wish to change the name of the song before it is saved, use the Alpha Dial to select the appropriate letters, and the "<" or ">" cursor keys after each letter is selected. When you have the desired name in the display, press ENTER.
7. If you wish to save the song to disk, press PLAY/SAVE (if you wish to return to the Disk Mode, press STOP). If there is a song title already on the disk which is the same as the one you are saving, the MRC-300 will ask you if you want to RENEW? (update) the song file on disk to this new version. Pressing ENTER will erase the file on disk and replace it with the new song data. Press STOP to return to the Disk Mode. When the saving process is complete, the MC-300 will beep.
8. To return to the Stand By mode, press MODE button, select #1 (MIDI RECORDER) and press ENTER.

Disk Mode #3
Deleting Songs
from Disk

Procedure for Deleting Songs from Disk

This function removes individual song files from a disk.

1. Go to the Stand By mode.
2. Press MODE, select #2 and press ENTER to access Disk Mode.

①	LOAD	2	SAVE
3	DELETE	4	RENAME

3. Press #3 and ENTER, move the Alpha Dial to select the appropriate song file. Select the song file you wish to delete.
4. Press ENTER. If you wish to delete the file, press PLAY/SAVE.
If you wish to exit the deleting function, press STOP to return to disk mode. When this procedure is completed, the MC-300 will beep.
5. To return to the Stand By mode, press MODE, Select #1 (MIDI RECORDER) and press ENTER.

Disk Mode #4
Renaming a Song
File on Disk

Procedure for Renaming Song Titles on Disk

This function allows you to change the name of the song title permanently on the disk. Rename the song title by using the Alpha Dial and using the cursor keys <-or ->.

1. Go to the Stand By mode.
2. Press MODE, select #2 and press ENTER to access Disk Mode.

①	LOAD	2	SAVE
3	DELETE	4	RENAME

3. Press #4 and ENTER.
4. Move the Alpha Dial to select the appropriate song title and the "<-" or "->" cursor keys after each letter is selected. .

5. Press ENTER, rename the song title using the Alpha Dial to select the appropriate letters, and the "<" or ">" cursor keys after each letter is selected.
6. Press ENTER then press PLAY/SAVE. When the Renaming process is completed, the MC-300 will beep. If you wish to exit the renaming function, press STOP to return to disk mode.
7. To return to the Stand By mode, press MODE, select #1 (MIDI RECORDER) and press ENTER.

Section #4

MIDI BUTTON

MIDI Button

The MIDI button selects the information the MC-300 sends and receives within a MIDI system.

The MIDI button provides the following twelve functions:

<u>Function</u>	<u>Display</u>
1. Receive Channel	"Receive CH"
2. Receive Polyphonic After-Touch	"Receive PAf"
3. Receive Control Change A	"Receive CCa"
4. Receive Control Change B	"Receive CCb"
5. Receive Program Change	"Receive PG"
6. Receive Channel After-Touch	"Receive CAf"
7. Receive Pitch Bender	"Receive PB"
8. Receive System Exclusive	"Receive EX"
9. Transmit Channel	"Transmit CH"
10. Transmit Clock	"Transmit CLK"
11. Transmit System Exclusive	"Transmit EX"
12. Soft Thru Switch	"Soft THRU"

#1 Receive Channel (Receive CH)

The MIDI functions will affect all 8 song numbers in the same way.

The Receive Channel function selects which MIDI channel(s) the MC-300 will receive while recording. This is useful for filtering out individual channels when recording information from another sequencer (see section 13 on "Synchronizing the MC-300 to an External Sequencer").

In normal operation, the Receive Channel function should be left in the "ALL" position so that the MC-300 will receive information from all MIDI channels. Note: This function will not change the incoming MIDI channel to a new channel. You can use the Change MIDI Channel function to reassign a new MIDI channel once the data has been recorded (see section on "Change MIDI Channel function"). If your controller only sends on MIDI Channel 1, you will need a Roland MPU-103 to assign a new MIDI channel in real time (live).

Procedure for Setting the Receive Channel

1. Go to the Stand By mode.
2. Press the MIDI button, press ENTER.
3. Select the MIDI channel(s) you wish to receive (ALL, 1-16).
4. Press ENTER.
5. Press STOP to return to the Stand By mode.

#2 Receive Polyphonic After-Touch (PAf)

After-touch is MIDI information which is produced by applying pressure to the key after it has been struck. Polyphonic after-touch, found on very few keyboard controllers, sends out separate after-touch information for each individual key. Because each note has a separate after-touch value, it uses a large amount of note memory. For this reason, it may be desired to filter out this information while recording.

The Receive Polyphonic After-Touch function allows you to select whether or not the MC-300 will record polyphonic after-touch information.

Procedure for Switching Polyphonic After-Touch Receive On/Off

1. Go to the Stand By mode.
2. Press the MIDI button.
3. Select #2, press ENTER. The on/off indicator will flash.
4. Select the On or Off position. Press ENTER.
5. Press STOP to return to Stand By mode.

Control Change (CC)

The Control Change message is used to modify MIDI data with a controller other than a keyboard. There are 127 controllers defined under MIDI.

CONTROL CHANGE CHART

CONTROL NUMBER (2nd Byte Value)	CONTROL FUNCTION
	123 All notes off
0	Undefined
1	Modulation wheel or lever
2	Breath Controller
3	Undefined
4	Foot controller
5	Portamento time
6	Data entry
7	Main volume
8 to 31	Undefined
32 to 63	LSB for values 0 to 31
64	Damper pedal (sustain)
65	Portamento
66	Sustenuto
67	Soft pedal
68 to 95	Undefined
96	Data increment
97	Data decrement
98 to 121	Undefined
122 to 127	Channel mode messages (local, Omni, Poly, etc.)

#3 Receive Control Change A (CCa)

Control Change A controllers cover a continuous range of values unlike switches which have only two values (on/off). This includes modulation wheel or lever, breath controller, foot controller, portamento time, data entry and MIDI volume. Each continuous controller is represented by a MIDI control change number from 0 - 63. Because a large number of resolution values are required to accurately represent continuous controller information, they consume a large amount of memory. To conserve memory, you may wish use this function to filter out continuous controller information when recording.

Procedure for Switching Control Change A Receive On/Off

1. Go to the Stand By mode.
2. Press the MIDI button.
3. Select #3, press ENTER.
4. Select "CTRL change a" on/off. Press ENTER.
5. Press STOP to return to the Stand By mode.

#4 Receive Control Change B (CCb)

Unlike continuous controllers, Control Change B represents switches which have only two values (off/on). These include hold pedal, portamento on/off, sustenuto, soft pedal, and data increment/decrement. Each switch is assigned a MIDI control change number from 64 - 97.

Control Change B also includes controllers 98 - 127 which are currently undefined by the present MIDI spec.

Procedure for Switching Control Change B Receive On/Off

1. Go to the Stand By mode.
2. Press the MIDI button. Select #4, press ENTER.
3. Select "CTRL change b" on or off. Press ENTER.
4. Press STOP to return to the Stand By mode.

#5 Receive Program Change (PG)

Program Change messages can be sent through MIDI to communicate a sound modules' patch numbers. Program change messages sent from a controller to the MIDI Input the MC-300 can be selectively filtered out by turning off the "Receive program change" message.

For example, when transferring data from an external sequencer to the MC-300, you choose not to record the program changes along with the rest of the data. This function allows you to filter out program changes. For this reason, you may choose to filter out the Program Change message when you are transferring information from another sequencer to the MC-300

Procedure for Switching Program Change Receive On/Off

1. Go to the Stand By mode.
2. Press the MIDI Button, Select #5.
3. Press ENTER. Use the Alpha Dial to select the On or Off position.
4. Press STOP to return to the Stand By mode.

#6 Receive Channel After-Touch (CAf)

After-touch is MIDI information which is produced by applying pressure to the key after it has been struck. Channel after-touch, found on most keyboard controllers, sends out one stream of after-touch information for the entire keyboard. Channel (monophonic) after-touch uses less memory in the MC-300 than polyphonic after-touch but you may still wish to filter out this information while recording to conserve memory.

Procedure for Switching Channel After-Touch Receive On/Off

1. Go to the Stand By mode.
2. Press the MIDI button.
3. Select #6, press ENTER.
4. Using the Alpha Dial, select either On/Off.
5. Press STOP to return to the Stand By Mode.

#7 Receive Pitch Bend (PV)

Pitch Bend, a continuous change in frequency, is generated from pitch bend wheels, levers, and ribbons.

Pitch bending uses a large amount of memory. To conserve memory, you may wish to filter out this information while recording.

Procedure for Switching Pitch Bend Receive On/Off

1. Go to the Stand By mode.
2. Press the MIDI button.
3. Select #7, press ENTER.
4. Use the Alpha Dial to select either On/Off.
5. Press STOP to return to the Stand By mode.

#8 Receive System Exclusive (EX)

System exclusive contains parameter information that is specific to a particular product or device. The MC-300 has the ability to record this information from instruments that can send it. Because System Exclusive information can use a large amount of memory, you may wish to filter out system exclusive information while you are recording.

Procedure for Switching System Exclusive Receive On/Off

1. Go to the Stand By mode.
2. Press the MIDI button.
3. Select #8, press ENTER.
4. Use the Alpha Dial to select either On/Off.
5. Press STOP to return to the Stand By mode.

#9 Transmit Channel
(Transmit CH)

Transmit Channel allows you to select different MIDI channels to be sent to the two outputs of the MC-300.

When large amounts of MIDI information have been recorded (such as 11 to 16 channels of note information with pitch bend, after-touch, and system exclusive patches), the MIDI data stream can become sluggish (i.e. You may notice certain timing errors in the performance).

For this reason, the MC-300 is equipped with two separate MIDI outputs which can be assigned to send all MIDI channels or only selected MIDI channels. The first MIDI output can also be used to send all MIDI channel information except for MIDI clock, which would be the only information transmitted on the second output.

In the Transmit Channel mode, the following options are available:

MIDI Output 1

All (1-16)
Channel 1
Channels 1,2
Channels 1-3
Channels 1-4
Channels 1-5
Channels 1-6
Channels 1-7
Channels 1-8
Channels 1-9
Channels 1-10
Channels 1-11
Channels 1-12
Channels 1-13
Channels 1-14
Channels 1-15
Channel 1-16

MIDI Output 2

All (1-16)
Channels 2-16
Channels 3-16
Channels 4-16
Channels 5-16
Channels 6-16
Channels 7-16
Channels 8-16
Channels 9-16
Channels 10-16
Channels 11-16
Channels 12-16
Channels 13-16
Channels 14-16
Channels 15-16
Channel 16
Clock

For example, drum information is loaded into MIDI channel 10 in the MC-300. Three other musical parts are loaded into channels 1, 2, and 3. Because it is advisable to separate drum information from musical parts for best results, you could select a transmit channel option such as Output 1 (channels 1-9) and Output 2 (channels 10-16).

Procedure for Selecting MIDI Channel Assignments for MIDI Outputs

1. Go to the Stand By mode.
 2. Press the MIDI button.
 3. Select #9.
 4. Press ENTER.
 5. Use the Alpha Dial to select the channel assignments for both outputs.
 6. Press STOP to return to Stand By mode.
- Note: If you are using a split channel output configuration as described in MIDI function #9, the MC-300 will only output exclusive information on output #1. Output #2 will transmit all MIDI information for the assigned channels except for system exclusive and MIDI clock. This is done so that the volume of MIDI information traveling through separate parts will not slow down the MC-300's operation during playback.

#10 Transmit Clock (Transmit CLK)

MIDI timing information (clock) is always running through the MIDI data stream. If you do not want to transmit this information, it can be shut off using this function.

Note: If you are using a split channel output configuration as described in MIDI function #9, the MC-300 will transmit MIDI clock on output #1 only.

Procedure for Switching Transmit MIDI Clock On/Off

1. Go to the Stand By mode.
2. Press the MIDI button.
3. Select #10.
4. Press ENTER.
5. Use the Alpha Dial to select On/OFF.
6. Press STOP to return to the Stand By mode.

#11 Transmit Exclusive (EX)

System Exclusive information recorded into the MC-300 can be transmitted to the receiving sound modules during playback of shut-off and retained (in the internal memory) using this function.

Procedure for Switching System Exclusive Transmission On/Off

1. Go to the Stand By mode.
2. Press the MIDI button.
3. Select #11.
4. Press ENTER.
5. Use the Alpha Dial to select On/OFF
6. Press STOP to return to the Stand By mode.

#12 Soft Thru (THRU)

The Soft Thru function on the MC-300 combines the signal coming to the MIDI Input with the signal transmitted from the MIDI output.

When using a MIDI master keyboard, this function must be in the On position to play any of the connected sound modules. If Soft Thru is Off, the mother keyboard's performance will not pass through the MIDI Out of the MC-300 to the sound module(s). Because the keyboard makes no sound of its own, you will not be able to hear your performance unless Soft Thru is On.

On the Roland MSQ-700 and MSQ-100 sequencers, this function is referred to as "Mix Out." On other sequencers, this function is called Echo, Echo Back, Play Thru, Thru, and Patch Thru.

Procedure for Switching Soft Thru On/Off

1. Go to the Stand By mode.
2. Press the MIDI button.
3. Select #12.
4. Press ENTER.
5. Use the Alpha Dial to select On/Off.
6. Press STOP to return to the Stand By Mode.

Section #5

FUNCTION BUTTON

Function Button

The Function button accesses global commands that affect basic operation functions. They include:

1. Sync Clock
2. Metronome
3. Song Title
4. Rhythm Velocity
5. Rhythm Instrument
6. Rhythm MIDI Channel
7. Block Repeat
8. Auto Stop
9. Basic Tempo

Any Function changes will be stored to disk along with the song data. Each Song Number (1-8) will retain its Function changes.

Individual Functions #1 Sync Clock

The Sync Clock function determines the status (synchronization mode) of the clocking capabilities of the MC-300. The MC-300 can function as either a master clock which will control other instruments (such as drum machines), or as a slave which will sync to the clock of another instrument or device.

When the sync clock function is in the "Tape" sync mode, it also allows you to synchronize the MC-300 (slave) to a tape recorder (master).

For more information on synchronizing the MC-300 with other devices and tape syncing, see the chapter on "Synchronizing to Other Devices."

Procedure for Setting the Sync Clock Mode

1. Go to the Stand By mode.
2. Press the FUNC button.
3. Press ENTER.
4. Using the Alpha Dial, select a sync mode (Internal, MIDI, or Tape).
5. Press STOP to return to the Stand By mode.

#2: Metronome

The metronome function has two purposes. The first is to select the rhythmic value of the metronome. The metronome can be assigned to beep at quarter note or eighth note intervals. The downbeat of each measure is indicated by a higher pitched beep.

The second purpose for the metronome function is to decide when the metronome will be heard. The following options are possible:

- | | |
|-------------|--|
| 1. OFF | The metronome will never be heard. |
| 2. REC only | The metronome will be heard only when recording. |
| 3. REC&PLAY | The metronome will be heard during recording and playback. |
| 4. Always | The metronome will be always be heard (even when the MC-300 is stopped). |

Note: The volume control for the metronome is located on the rear panel of the MC-300. Turn the volume control until the metronome is heard.

Procedure for Changing the Metronome Functions

1. Go to the Stand By mode.
2. Press the FUNC button.
3. Select #2. Press ENTER.
4. Use the Alpha Dial to select the metronome's rhythmic value (eighth note or quarter note). Press ENTER.
5. Use the Alpha Dial to select when the metronome will be heard (OFF, REC only, REC&PLAY, or Always)
6. Press STOP to return to the Stand By mode.

#3 Song Title

Each song may be assigned a name consisting of thirteen alphanumeric characters (with punctuation).

Procedure for Creating a Song Title

1. Go to the Stand By mode.
 2. Press the FUNC button.
 3. Select #3. Press ENTER.
 4. Use the Alpha Dial to select the first character.
 5. Press the -> key to move to the next character.
 6. Repeat steps 5 & 6 until you have completed the song name.
 7. Press STOP to return to the Stand By mode.
- Note: See section on "Disk Management" for information on re-naming song titles on disk.

#4 Rhythm Velocity

#5 Rhythm Instrument

#6 Rhythm MIDI Channel

These functions affect the status of the rhythm track and are described in detail in the section, "The Rhythm Track."

#7 Block Repeat

Block Repeat can be used to repeat a single measure, a phrase, or the entire song. The repeat can begin at any measure, include any number of measures, and continue until you press the STOP button.

For example, you are working on the chorus section of your song. The chorus begins at measure 33 and continues for sixteen measures. By using the Block Repeat function you can play the chorus sequence over and over while you experiment with new parts.

Note: The Block Repeat function will not output MIDI song position pointer.

Procedure for Using the Block Repeat Function

1. Go to the Stand By mode.
2. Press the FUNC button.
3. Select #7, press ENTER.
4. Select the starting measure, press ENTER.

5. Select the number of measures to be repeated, press ENTER.
6. Press STOP to return to the Stand By mode.
7. Hold the SHIFT key, and press PLAY to engage Block Repeat.
8. Press the STOP button to disengage playback.
 Note: Any time you hold the SHIFT key when you press the PLAY button, you will re-engage the Block Repeat function with the most recent measure commands. The PLAY function will operate normally when the SHIFT key is not held.

#8 Auto Stop

When overdubbing, the auto stop function will allow you to stop recording at the last measure of your composition. The recording process will not continue any further than the length of the song currently in memory.

Procedure for Automatically Stopping the Record Function

1. Go to the Stand By mode.
2. Press the FUNC button.
3. Select #8, Press ENTER.
4. Use the Alpha Dial to turn Auto Stop to the "On" position.
5. Press STOP to return to the Stand By mode.
 Note: To continue recording from the next measure, the Auto Stop function must be turned to the OFF position.

#9 Basic Tempo

The Basic Tempo is the tempo that is stored to disk for each song file. You may change the overall tempo of a song at any time using the Alpha Dial or Ten Key pad. However, these changes will be temporary unless they are entered into the Basic Tempo function. For more information on tempo changes, see section #10, "Tempo Track."

Procedure for Entering the Basic Tempo

1. Go to the Stand By mode.
2. Press the FUNC button.
3. Select #9, press ENTER.
4. Select a new tempo (10 - 250 BPM), press ENTER.
5. Press STOP to return to the Stand By mode.

Section #6

Real Time Recording

REAL TIME RECORDING

The MC-300 will record MIDI information in real time from any MIDI controller and will record all of the nuances of your performance exactly as you played them. To find out which performance parameters your particular instrument can send and/or receive through MIDI, check the MIDI implementation chart in your instrument's owners manual.

The MC-300 will record information on all sixteen MIDI channels. When you are recording, the MC-300 will record the channel number of the MIDI controller you are using. The MC-300 will allow you to rechannelize (assign a new MIDI channel) after your performance is recorded. This is especially useful for older MIDI instruments that only send on one channel.

Multitimbral instruments allow you to play more than one sound simultaneously. Instruments that are not multitimbral can only play back one sound at a time. The MC-300 cannot perform beyond the capabilities of the instrument you are using. If your instrument is multitimbral, you can play back different parts simultaneously on different MIDI channels.

Tempo can be changed anytime you are in the Stand By mode by rotating the Alpha Dial or by typing in a new tempo and then pressing the ENTER button.

Procedure for Real Time Recording

1. Go to the Stand By mode.
2. Press the -> key until the load mode (REAL, PUNCH) display flashes. Rotate the Alpha Dial until "REAL" is displayed and is flashing.
3. Press the -> key until the track number flashes, rotate the Alpha Dial and select a track (1-4) where you wish to record the music (performance information).

4. Press the REC button . If this is the first time you will be recording or if you are continuing to record from the end of an existing track, you must enter a time signature. If you would like 4/4 time (the default value), press ENTER twice. If you do not want the 4/4 default, select the beats per measure and press ENTER. Select the note value and press ENTER.
5. Press the PLAY button. You will hear a two measure count off. When the count off is finished, the MC-300 will begin recording.
6. When you have completed recording, press STOP.
7. To play back the part, press RESET to locate back to measure one. Press PLAY.
 Note: If you do not want a count in before recording, press the PAUSE button before pressing the REC button. The MC-300 will begin recording as you play a note on your MIDI controller.

Recording From the Middle or End of a Song

Data can be recorded from any measure in a track. When you enter data into an existing track, the new information will replace the information that previously existed in those measures. The information before and after the measure you recorded will remain intact.

You may also continue recording from the end of a track. The information in the preceding measures will remain.

Procedure for Recording from the Middle or End of a Song

1. Go to the Stand By mode.
2. Press the <- key until the measure number flashes.
3. Rotate the Alpha Dial. Select the measure where you wish to begin recording.
4. Press the -> key until the load mode display flashes. Rotate the Alpha Dial until "REAL" is displayed.
5. Press the -> key until the track display flashes.

6. Rotate the Alpha Dial and select the track (1,2,3,4) where you wish the data to be entered.
7. Press the REC button . To enter information from the end of an existing track, you must enter a time signature. If you would like 4/4 time (the default value), press ENTER twice. If you do not want 4/4 time, select the beats per measure and press ENTER. Select the note value and press ENTER.
8. Press the PLAY button. During the count off you will hear the previous two measures. At the end of the count off, the MC-300 will begin recording.
9. Press STOP to end recording.
10. To play back from the beginning of the song, press RESET, press PLAY. To play back from another measure, press the <- key once, and use the Alpha Dial to select the correct measure number.

Overdubbing

You may overdub data on another track either from the beginning ,middle, or end of the composition. The MC-300 will allow you to hear the data on other tracks while you record a new part . The recording process always starts at the beginning of a measure. This can be valuable for entering parts that do not need to be started from the beginning of the song.

Procedure for Overdubbing

1. Go to the Stand By mode.
2. Press the <- key until the measure display flashes. Select the measure number where you would like to begin recording by rotating the Alpha Dial. If you want to overdub from the beginning of the song, press RESET.
3. Press the -> key until the load mode display flashes.
4. Rotate the Alpha Dial until "REAL" is displayed.
5. Press the -> key until the track number display is flashing. Select a blank track (1,2,3,4).
6. Press the REC button.
7. Press the PLAY button.

8. The two previous measures will play during the count . If you are overdubbing from the beginning of a song, you will hear a two measure count off.
9. When finished recording, press STOP to return to Stand By mode.
10. To play back information, press RESET and then PLAY.
Note: You may overdub on a track that is not blank. However, all the information you record will replace the previously recorded information.

Recording Non-Note Information in Real Time

MIDI performance information other than notes may be overdubbed onto a blank track. This can be very useful for adding information such as modulation, sustain pedal, program change, volume etc. to a performance.

Parameters such as program changes and volume should usually be entered as an overdub since it is difficult enter this information while playing. This way, you can listen to the performance and enter program changes accordingly.

When you are satisfied with the additional performance information you have entered, merge (combine) it with the note information. Before merging the information, the note information should be auto-corrected (quantized) at this time if so desired.

Procedure for Overdubbing Non Note Information

1. Go to the Stand By mode.
2. Press the <- key until the measure display flashes. Select the measure number where you would like to begin recording by rotating the Alpha Dial. If you wish to overdub from the beginning of a song, press RESET.
3. Press the -> key until the load mode display flashes.
4. Rotate the Alpha Dial until "REAL" is displayed.
5. Press the -> key until the track number display is flashing.

6. Select a blank track (1,2,3,4).
7. Press REC button.
8. Press the PLAY button.
9. You will hear a two measure count off while the previous two measures are played. If you are overdubbing from the beginning of a song, you will hear only the count off.
10. Since you are entering non-note information, enter only the parameters for the functions you would like recorded
11. When you are finished recording, press STOP.
12. To play back information, press RESET and then PLAY.
 Note: You may overdub on a track that is not blank. However, the information you enter will replace all previously recorded information for those measures.
 Note: If you are programming program changes, be sure to record the first program change during the count off.

Punching In/Out

You may record at any point on a track by using the punch In/Out function. Like a multi-track tape machine, you can punch into a track at any point in a song. Data will be removed from the point where you punch in to the point where you punch out. During the punch you can then record new data in place of the data being removed. This can be valuable for fixing a part in real time without having to re-record the entire performance. Note: A DP-2 Footswitch can be plugged into the Punch In/Outjack on the rear panel of the MC-300 and used to activate the punches.

Procedure for Punch In/Out

1. Go to the Stand By mode.
2. Press the <- key until the measure display flashes. Select the measure number where you wish to begin monitoring track. If you wish to start monitoring at the beginning of the song, press RESET.
3. Press the -> key until the load mode display flashes. Rotate the Alpha Dial until "Punch" is displayed.
4. Press the -> key until the track display flashes. Rotate the Alpha Dial and select the track (1,2,3,4) you want to fix.

5. Press the REC button (the red indicator will flash). Press PLAY. The MC-300 will begin playing without a count in.
6. When you are ready to punch in, press REC or the DP-2 pedal. (You have now punched into the track. The red indicator will not flash). To punch out, press PLAY or the DP-2 pedal. (the red indicator light above the REC button will resume flashing). You may punch in and out of the track as many times as necessary while the MC-300 is in the punch mode.
7. When you are finished punching in/out, press STOP to return to Stand By mode.
8. To play back the song from its beginning, press RESET and then PLAY.

Recording System Exclusive

One of the most powerful features of the MC-300 is its ability to record system exclusive information. This allows you to store patch data, filter sweeps, waveform changes, and other parameters into the MC-300 in real time from instruments which implement MIDI system exclusive.

The patch information for your instruments can be stored into the MC-300 so that while the song plays back, the correct patch data will be sent to the proper instruments. This alleviates the need for numerous software voicing programs, data RAM cartridges, cassette tapes, and other data storage mediums. This way, all of your patches can be stored on disk with your compositions.

Procedure for Recording System Exclusive Patch Information

Follow the procedure for Real Time Recording, Overdubbing or Punching In/Out. Listed below are tips for using System Exclusive with various MIDI synthesizers. If you need information on products not listed below, contact the manufacturer.

Roland MKS-80 Super Jupiter

1. Connect the MIDI Out of the Super Jupiter to the MIDI In of the MC-300.
2. Set the Super Jupiter function switch to position III.
3. Set the Receive MIDI channel on the MC-300 to the same channel as the MKS-80.
4. Turn off soft-thru on the MC-300.
5. While the MC-300 is recording, select a patch number on the Super Jupiter. This will send the system exclusive data for that patch plus the upper and lower tone data.
6. While your system is hooked up in this manner, you can record parameters edits from the MPG-80 Super Jupiter programmer into the MC-300.

Roland Alpha Juno 1 and Alpha Juno 2

1. Connect the MIDI Out on the Juno to the MIDI In on the MC-300.
2. Turn program change "Off" on the Alpha Juno.
3. Make sure system exclusive is "On" on the Alpha Juno.
4. Turn Soft Thru "Off" on the MC-300.
5. While the MC-300 is recording, select and press a tone number on the front panel of the Alpha Juno. This will send the system exclusive data for the tone you have selected.
6. To record real time parameter changes with the PG-300, connect the MIDI Out of the programmer to the MIDI In of the MC-300. Turn Soft Thru to the "On" position in the MC-300. While you are recording, all parameter changes will be recorded. Note: The PG-300 transmit channel must be set to the same channel as the Juno.

Roland JX-8P

1. Connect the MIDI Out of the JX-8P to the MIDI In of the MC-300.
2. Turn program change "Off" on the JX-8P.
3. Make sure system exclusive is "On" on the JX-8P
4. While the MC-300 is recording, select the patch number on the front panel of the JX-8P. This will send the system exclusive information of the patch you have selected.
5. By using the PG-800 programmer, you can record individual parameter changes from the JX-8P through system exclusive. Change the parameters on the PG-800 while the MC-300 is recording.

Yamaha DX-7 / TX-7

1. Connect the MIDI Out on the DX-7 / TX-7 to the MIDI In on the MC-300.
2. Turn MIDI function #8 to "Sys Info Avail" on the DX-7.
3. Turn off the Internal Memory Protect switch on the DX-7.
4. While the MC-300 is recording, select the patch number on the front panel of the DX-7 with the data increment/decrement button. This will send the system exclusive information for the patch you have selected. For the TX-7, press the "Edit Voice Out" function while the MC-300 is recording. Remember, the DX-7 and TX-7 transmit only on MIDI channel 1, so you may have to use the Edit function #8 "Change MIDI channel" on the MC-300 to re-channelize the patch data to the desired channel.

Note: Yamaha TF-1 modules (TX-816 and 216) do not have the ability to send the System Exclusive information for individual patches. They do, however, respond to individual System Exclusive patches already recorded from a DX-7 or TX-7.

5. By editing the patch on the front panel of the DX-7 while the MC-300 is recording, individual parameter changes (operator level, pitch, algorithms, etc) can occur during play back of the song. The function parameters can be stored by pressing the function button and running your finger over the function parameter buttons (1-32) while the MC-300 is recording.

Note: Only single patches can be transferred to the MRC-300 software. Bulk dumps (MIDI transmit?) can clog the MIDI data stream.

Roland JUNO-106

1. Connect the MIDI Out of the Juno 106 to the MIDI In on the MC-300.
2. Set the function switch on the rear panel to position III.
3. While the MC-300 is recording, select and press a patch number on the front panel of the JUNO-106. This will send the system exclusive information for the patch you have selected.
4. If parameter edits are made on the front panel of the JUNO-106 while the MC-300 is recording, the edits will play back exactly as they were recorded.

Section #7

STEP RECORDING

Step Recording

Step recording allows you to enter music into the MC-300 one note (step) at a time. Step loading allows you to record elaborate performances (performances that may be impossible to record in real time), into the MC-300. Step loading gives you more control than real time recording because the music is entered one note at a time. Notes can be loaded individually or in chords.

There are four elements that a note consists of when step loading. They are pitch, Note Resolution, Gate Time, and velocity.

Pitch

The Pitch is the note sent from either a MIDI controller or the notes assigned using the Alpha Dial or the Ten Key Pad of the MC-300. Pitch is displayed as a note name and an octave number. For example, middle C is displayed as C4.

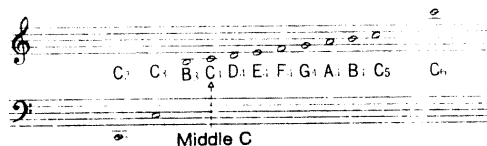

Note Resolution

Note Resolution is the rhythmic value of a note, and is displayed in standard music notation as 1/8, 1/16, 1/32, etc.

Gate Time

Gate Time is the distance between the note on and note off commands, or the articulation of a note. Smaller Gate Time values represent more staccato articulations.

Velocity

Velocity is the dynamic value assigned to a note. In MIDI, 127 velocity increments are possible. MIDI controllers that are velocity sensitive will send velocity information through MIDI with a velocity range from 1 to 127. A value of 64 is the velocity level most controllers use for medium volume, and is the only value sent by non-velocity sensitive instruments.

Notes can be entered into the MC-300 from a MIDI controller or from the front panel of the MC-300 by using the Alpha Dial or Ten Key Pad. When entering in step time from a dynamic MIDI controller, pitch and velocity information is automatically recorded. When entering in step time from the front panel of the MC-300, the pitch, note resolution, gate time, and velocity information can be loaded separately.

You can record or re-record in step time from any point in a track. If data is already recorded on a track, it will be replaced with the new data for the length of the newly recorded measures.

Selecting a MIDI Channel

If a MIDI controller is used, the MC-300 will record the MIDI channel that the MIDI controller sends. If you are entering music from the front panel of the MC-300, you must specify a MIDI channel.

Selecting a Gate Time

Gate time is entered from the Alpha Dial or Ten Key Pad after each note (pitch) is entered. Gate times may range from 1 to 65,535 when entered in this manner.

Using an External MIDI Controller

Music can be entered from an external MIDI controller one note at a time, or in chords. When entering music from an external MIDI controller, the display will show you the note, velocity, and gate time. To enter chords from an external MIDI controller, simply play multiple notes simultaneously. Each time you release all the notes on the keyboard, the step time display will advance to the next step.

Gate Time is the distance between the note on and note off commands, or the articulation of a note. When loading information from an external MIDI controller, the gate time is represented as a percentage (1-200%). This function is very valuable when entering music from an external MIDI controller, because it allows you to articulate notes individually.

For example, if you have chosen a note resolution of 1/16th , you may assign a different articulation to each note by assigning a different gate time percentage to each note. A staccato articulation is selected by a low gate time percentage (30-60%) and a Legato articulation is created by assigning a higher gate time percentage (100-130%).

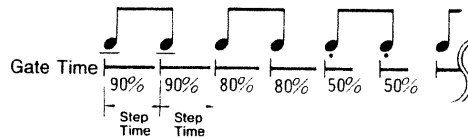

When the TIE key is used to connect notes together (make longer notes), the Gate Time is automatically set to the full value of the note.

Connecting notes with TIE

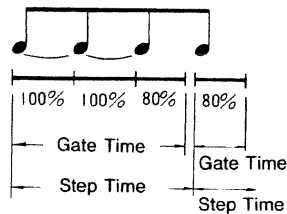

Selecting the Note Resolution

Note resolution is the rhythmic value of each note you will be entering. The display will show both the rhythmic value and the clock pulse value.

The Resolution you select will represent a single step in recording. Available note resolutions in the MC-300 are half notes, quarter notes, quarter note triplets, eighth notes, eighth note triplets, sixteenth notes, sixteenth note triplets, thirty-second notes, thirty-second note triplets, and sixty-fourth notes. Select the smallest rhythmic value you will be using in your composition.

For example, you have selected a Bach fugue to load into the MC-300. If the smallest note value in the fugue is a 1/16th note, you should select a 1/16th note as your note resolution for this composition.

To enter longer note values than your resolution value, notes can be connected using the Tie function. Ties can be used as many times as you like to achieve a note of any duration.

For example, to enter a quarter note in the Bach fugue, enter the 1/16th note and press the <- button three times to make the note a quarter note.

$$1/16 \text{ (note)} + 1/16 \text{ (tie)} + 1/16 \text{ (tie)} + 1/16 \text{ (tie)} = 1/4 \text{ (note)}$$

To enter rests into your composition, press the -> key. If your resolution is 1/16th, each time you hit the -> key will represent a 1/16th rest.

For example, say you need a 1/4 rest in your Bach Fugue and your resolution is set at 1/8th notes. By pressing -> twice, two 1/8th rests will be entered.

$$1/8 \text{ (rest)} + 1/8 \text{ (rest)} = 1/4 \text{ (rest)}$$

CPT (Clock Pulse Time)

A Clock Pulse (CPT) is a measurement of time. Clock Pulse Time is also referred to as Time Base. In the MC-300, a quarter note is subdivided into 96 Clock Pulses, an eighth note is 48, a 16th note is 24, etc. When entering notes into the MC-300 in step time, the CPT will advance in relation to the value of the note you have selected. For example, if entering quarter notes into the MC-300, each time a note is entered, the CPT will advance by a value of 96.

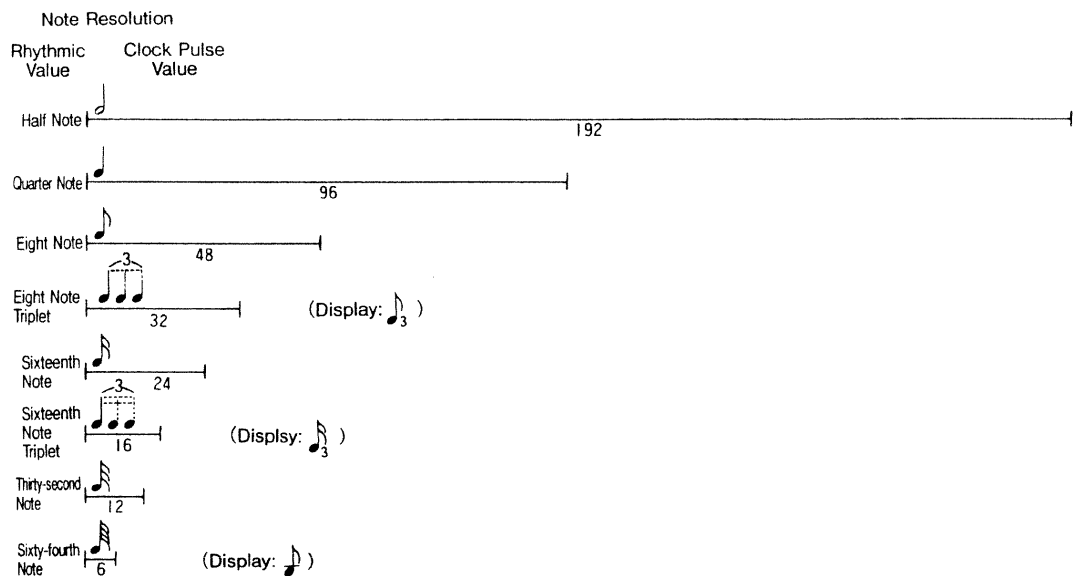

You are allowed a specific number of Clock Pulses per measure depending on the time signature you have selected. For example, in 4/4 time, you have 384 (96 X 4) Clock Pulses per measure. When you assign more than the allotted number of clock pulses in a measure, the following measure will be reduced by that amount.

For example, you are step loading a song in 4/4 time. In the first measure, you have entered three 1/4 notes (CPT=96 each). The Clock Pulse Time indicator shows that you have entered 288 CPT's. If you change the resolution to 1/2 note (CPT=192), and enter one note, you will have entered a total of 480 CPT's in the first measure. Because you are only allowed a total of 384 CPT's in 4/4 time, the amount exceeding 384 (96, or one quarter note), will be deducted from the following measure's total. Therefore, in the next measure, you have a total of 288 CPT's available.

Step Loading from an
External MIDI
Controller

**Procedure for Step Loading from an External MIDI
Controller**

1. Go to the Stand By mode.
2. Press the -> key until the Entry Mode (Real, Step, & Punch) flashes in the display window.

SONG 1
MEAS 1 J = 1 2 0 (STEP) 1

3. Select the Step mode by rotating the Alpha Dial (or Enter with the Ten Key pad) until "Step" is displayed in the window.
4. To select the track you wish to record on, Press the -> key, select the track (1,2,3,4), press ENTER.
5. To enter the Step Record mode, press REC/LOAD. The following window will appear:

TIME SIGN (4) / 4 ?
MEAS 1 J = 1 2 0 STEP 1

6. To select a Time Signature, select the number of beats per measure and press ENTER. Select note value, press ENTER. The default mode (4/4) can be selected by pressing ENTER twice. This procedure will only be necessary the first time you record or when you continue recording from the end of a track.
7. Bypass the MIDI channel entry by pressing ->.
8. Enter Gate Time percentage (1-200%), press ENTER. The default value (80%) can be entered by pressing ENTER. The display will appear as follows:

STEP 1 MEAS 1 CPT 0
CH 1 GT 80% (J) 24

9. Enter note resolution (1/2 - 1/64), press ENTER. The display will appear as follows:

STEP 1	MEAS	1	CPT	0
♪	48	⊖		

10. Enter note information by playing external MIDI controller.
11. Enter rests by holding the SHIFT button, and pressing the -> key.
12. Enter ties by holding the SHIFT button, and pressing the -< key.
13. To Play, press "Stop" to re-enter the Stand By mode, press RESET and then press PLAY.

Extra Functions

The Extra Functions listed below can be performed during the regular loading procedure.

1. To correct an error, press RESET to move back one step. The last note entered will automatically be erased. You can now resume the step loading procedure from this point.
2. To change note resolution, press the <- key. The current resolution value will flash in the display. Enter a new resolution (1/2 - 1/64), and press the -> key to resume note entry.
3. To change the gate time percentage, press <- key twice, enter a new percentage (1-200%), and press the -> key twice to resume note entry.
4. To record from a measure other than measure 1, press STOP to return to the Stand By mode, press the <- key until the MEAS display flashes.

SONG 1
MEAS (4) J = 120 STEP 1

Select the measure number where you wish to begin recording using the Alpha Dial or Ten Key Pad. If you would like to begin step loading anywhere within the track you have already recorded, you will be recording with the time signature previously used. If, however, you wish to continue step loading from the end of a current track, you must enter the appropriate time signature. Press REC/LOAD to return to Step Loading.

Step Loading from the Alpha Dial or Ten Key Pad

All note information can be entered from the Alpha dial or the Ten Key Pad. Pitch is displayed as a note name and an octave number. For example, middle C is displayed as C4.

Procedure for Step Loading from Alpha Dial and/or Ten Key Pad

1. Go to the Stand By mode.
2. Press the -> key until the Entry Mode (Real, Step, & Punch) flashes in the display window.

```
SONG 1
MEAS 4 J = 1 2 0 STEP 1
```

3. Select the Step mode by rotating the Alpha Dial (or Enter with the Ten Key pad) until "Step" is displayed in the window.
4. To select the track you wish to record on, Press the -> key, select the track (1,2,3,4), press ENTER.
5. To enter the Step Record mode, press REC/LOAD. The following window will appear:

```
TIME SIGN 4/4 ?
MEAS 1 J = 1 2 0 STEP 1
```

6. To select a Time Signature, select the number of beats per measure and press ENTER. Select note value, press ENTER. The default mode (4/4) can be selected by pressing ENTER twice. This procedure will only be necessary the first time you record or when you continue recording from the end of a track.

7. Select MIDI channel (1-16), press ENTER. The display will appear as follows:

STEP	1	MEAS	1	CPT	0
CH	1	GT	80%	♪	48

8. Select the gate time percentage by pressing ENTER. The Default value is 80%.
9. Select a note resolution (1/2 - 1/64), press ENTER.
10. Select a pitch (A-G). When selecting a pitch with the Alpha Dial, note name and octave number are assigned together. When entering notes from the Ten Key Pad, pitch must be entered while holding the SHIFT key, release the SHIFT key, press octave number (0 - 9), press ENTER. The display will appear as follows:

STEP	1	MEAS	1	CPT	0
♪	48	C	4	64	

11. Select a velocity level (1-127), press ENTER.
12. Select the gate time (1 - 65,535), press ENTER.
13. To Play, press "Stop" to re-enter the Stand By mode, press RESET and then press PLAY.

Extra Functions

The Extra Functions listed below can be performed during the regular loading procedure.

1. To enter notes with accidentals (flats and sharps), hold the SHIFT key, press the note name (A-G), press FLAT(7) or SHARP(8). Release the SHIFT key, press Octave Number, press ENTER.

2. Chords can be constructed by entering one note at a time using the Alpha Dial or Ten Key Pad. The Pitch, Velocity, and Gate Time for each note is entered exactly as described above (9,10,11). The Pitch, Velocity, and Gate Time for each note of the chord must be loaded separately. After the Gate Time value is selected, hold the SHIFT key, and press ENTER. A star will appear above the Note Status Indicator, and the next note information (Pitch, Velocity, and Gate Time), will be added to the previously entered note. This procedure must be followed for each note of the chord. After you enter the Gate Time Value of the final note of the chord, press ENTER (only). You can now continue to Step Load single notes or chords.

STEP 1	MEAS	1	CPT	4 8
♪	4 8	*C 4	6 4	3 8

3. To correct an error, press RESET to move back one step. The last note entered will automatically be erased. You can now resume the step loading procedure from this point.
4. To change note resolution, press the <- key. The current resolution value will flash in the display. Enter a new resolution (1/2 - 1/64), and press the -> key to resume note entry.
5. To change the MIDI channel, press <- key three times and the current MIDI channel will flash in the display. Select a new channel (1-16), and press ENTER three times to resume note entry.

6. To record from a measure other than measure 1, press STOP to return to the Stand By mode, press the <- key until the MEAS display flashes.

<p>SONG 1 MEAS ④ J = 1 2 0 STEP 1</p>

Select the measure number where you wish to begin recording using the Alpha Dial or Ten Key Pad. If you would like to begin step loading anywhere within the track you have already recorded, you will be recording with the time signature previously used. If, however, you wish to continue step loading from the end of a current track, you must enter the appropriate time signature. Press REC/LOAD to return to Step Loading.

Section #8

EDIT BUTTON

Edit Button

The MC-300 system allows you to edit and process MIDI information in many ways. The Edit functions will allow you to change MIDI information by measure. With the MC-300, it is also possible to edit single events. This will be discussed in the Microscope Editing section of this manual.

The MRC-300 software disk contains the operating system for recording and editing features on the MC-300. Once the MRC-300 software is loaded into the MC-300, the following editing functions reside in the memory and the disk does not need to remain in the MC-300 drive.

1. Erase
2. Delete
3. Insert
4. Merge
5. Extract MIDI Channel
6. Transpose
7. Change Velocity
8. Change MIDI Channel
9. Quantize
10. Copy

Note: To perform any editing functions, there must be MIDI information in a song. Also, you may wish to save an unedited version of your song on disk before performing editing functions.

To access the editing functions, press the EDIT Button and rotate the Alpha Dial (or use the Ten Key Pad) to select the appropriate edit function number. To move backward or forward through the edit procedures, use the <- or -> keys.

When selecting edit function #1, the display will appear as follows:

EDIT 1 ERASE
TRK 

Edit #1 Erase

Erase allows you to remove unwanted MIDI information from any MIDI channel on a track for any number of measures. This function is similar to erasing a track on tape. However, with the MRC-300 software, it is possible to erase specific information within a track.

For example, you could erase only the first eight measures of the brass part in your song while leaving the rest of the parts on the track intact.

In another example, you could clear out one song by erasing all information on all tracks and all channels starting from the beginning measure to the end of the piece.

In a third example, you could erase just the program change information on MIDI Channel 4 without touching the program change on the other channels.

Procedure for Erasing

1. Press ENTER.
2. Select the track you want to erase (All tracks, 1,2,3,4. tempo, or rhythm).
3. Press ENTER. Select what kind of information you would like to erase (Status) using the Alpha Dial. You may erase the following types of information:

Status	All	All MIDI information
	Note	Note information only
	PAf	Polyphonic after-touch only

CC	Continuous Controllers only (modulation wheel, volume, hold pedal, breath controller, etc.)
PG	Program Change only
CAf	Channel (monophonic) after-touch only
PB	Pitch Bender only
EX	System Exclusive information only
TU	Tuning request information only

After you have selected the type of information (Status) you would like to erase.

4. Press ENTER. Select what MIDI channel(s) you want to erase this information from (All, 1 - 16).
5. Press ENTER. Select the measure you wish to begin erasing.
6. Press ENTER. Select the number of measures to be erased.
7. Press ENTER. If you would like to verify your changes, press the <- and -> keys to step through your commands. If you are satisfied that the information is correct, press the -> button until you see "Sure ?>>," Press REC. Press STOP to return to the Stand By Mode.
8. Press RECORD. When the erasing process is completed, the MC-300 will beep.
9. Press STOP to return to the Stand By mode.

Edit #2 Delete

When selecting Edit Function #2 the display appears as follows:

```
EDIT 2  DELETE MEAS  
TRK ALL
```

The Delete function allows you to completely remove entire measures or music. This is similar to the process of tape splicing where you can cut out sections of a tape to rearrange the structure of a composition. However, with the MC-300, it is possible to remove measures from any or all tracks.

For example, a song you have just completed is 4:30 minutes long. The record company wants to release your song as a single, but they want the song length reduced to 3:50 minutes. By using the Delete function, you can cut down the length of the choruses and cut the introduction in half.

Note: If you delete all of the information in the Rhythm Track, the MC-300 will not play.

Procedure for Deleting Measures

1. Press ENTER. Select which track(s) you wish to delete (All tracks, 1,2,3,4, tempo, or rhythm).
2. Press ENTER. Select the measure you want to begin deleting.
3. Press ENTER. Select number of measures you wish to delete.
4. Press ENTER. If you would like to verify your changes, press the <- and -> keys to step through your commands. If you are satisfied that the information is correct, press the -> until you see "Sure?>>Press Rec" appears in the display. If you decide not to delete, press STOP to return to the Stand By mode.
5. Press RECORD. When the erasing process is completed, the MC-300 will beep.
6. Press STOP to return to the Stand By mode.

Edit #3 Insert

When selecting edit function #3 the display appears as follows:

```
EDIT 3   INSERT MEAS
TRK ALL
```

Insert places blank measures into any or all of the tracks at any point in a song. For example, you want to add a second instrumental bridge to your song. you can use this function to insert twelve blank measures into all the tracks. If these twelve measures were inserted starting at measure 30, the musical parts that were originally in measure 30 will now be in measure 42.

Procedure for Inserting Measures

1. Press ENTER. Select the track(s) you wish to insert blank measures into (All tracks, 1,2,3,4,tempo, and rhythm).
2. Press ENTER. Select the measure number where you would like the insert to begin.
3. Press ENTER. Select the number of blank measures to be inserted.
4. Press ENTER. If you are inserting into tracks 1,2,3,4 or tempo, go to step 6. If you are inserting into ALL tracks or the RHYTHM track, you will be asked to select the Time Signature. Select number of beats per measure.
5. Press ENTER. Select the note value, press ENTER.
6. If you would like to verify you changes, press the <- and -> keys to step through your commands. If you are satisfied that the information is correct, press the -> until you see "Sure?>>Press Rec" appears in the display. If you decide not to insert, press STOP to return to the Stand By mode.
7. Press RECORD. When the inserting process is completed, the MC-300 will beep.
8. Press STOP to return to the Stand By mode.

Edit #4 Merge

When selecting Edit #4, the display appears as follows:



Merge allows you to combine the information on one track with the information on another track to provide you with an empty track for additional recording. Using the Merge function, you can record up to 256 parts (16 MIDI channels times 16 voices). MIDI channel information will be retained after tracks have been merged.

The Merge function is similar to "bouncing" or "Ping-Ponging" tracks on a multi-track tape recorder. However, unlike a tape recorder, the sound quality is not affected by merging and an empty third track is not required.

Procedure for Merging

Two tracks can be merged at one time. To do this:

1. Press ENTER. Select a destination track (1-4). The Destination track is the track the data will be merged to. Remember, any data on the Destination track will be retained.
2. Press ENTER. Select the Source track (1-4). The Source track that contains the data you wished to be merged with the Destination track.
3. Press ENTER. If you would like to verify your changes, press the <- and -> keys to step through you commands. If you are satisfied that the information is correct, press the -> until you see "Sure?>>Press Rec" appears in the display. If you decide not to merge, press STOP to return to the Stand By mode.
4. Press RECORD. When the merging process is completed, the MC-300 will beep and the source track light will go out indicating it is now empty.
5. Press STOP to return to the Stand By mode.

If the tracks to be merged have different MIDI channels, they can be separated later using the Extract function (see next section).

Edit #5Extract

When selecting edit #5, the display appears as follows:

```
EDIT 5  EXTRACT
TRK  ⊖ ◀ M. CH  /TRK
```

The Extract function gives you the ability to separate and duplicate one MIDI channel from a merged track to any empty track.

For example, a merged track contains bass, piano, horns, and string parts. You can use the Extract function to move the piano part (only) onto a new track. This way, the new piano track can be edited by punching in new parts or performing other editing functions.

Procedure for Extracting MIDI channels from a Merged Track

1. Press ENTER. Select the Destination track (1-4).
2. Press ENTER. Select the MIDI channel you wish to Extract from the Source track (1-16).
3. Press ENTER. Select a source track (1-4), this is the track that contains the MIDI channel you wish to extract.

Note: The Destination track must be a different track than the merged source track. In the Extract mode, any information on the Destination track will be erased and replaced with information from the new MIDI channel.

4. Press ENTER. If you wish to verify your changes, press the <- and -> keys to step through your commands. If you are satisfied that the information is correct, press the -> until you see "Sure?>>Press Rec" appears in the display. If you decide not to extract, press STOP to return to the Stand By mode.
5. Press RECORD. When the extracting process is completed, the MC-300 will beep.
6. Press STOP to return to the Stand By mode.

Edit #6 Transpose

When selecting edit 6 (transpose), the display appears as follows:

EDIT 6	TRANPOSE
TRK 1-4	M.CH ALL

The Transpose function shifts the pitch (note events) up or down by half-step increments and can be performed for any number of measures. The Transposition range on the MC-300 is two octaves up or down. Data can be transposed more than once if the transposition required is greater than two octaves.

For example: Eight parts with separate MIDI channels have been merged to one track. Assuming you have a Marimba part on MIDI channel 4, you could transpose it up a perfect fifth (+7 half steps). This transposition could begin at measures 32 and continue for 4 measures. At measure 37, the Marimba part would return to its original pitch.

Procedure for Transposing

1. Press ENTER. Select the track(s) (1-4, 1,2,3,&4).
2. Press ENTER. Select a MIDI channel (All, 1-16).
3. Press ENTER. Select the number of half step increments (Bias) you wish (+24 to -24) using the Alpha Dial.
4. Press ENTER. Select the starting measure.
5. Press ENTER. Select the number of measures to be transposed.
6. Press ENTER. If you would like to verify your changes, press the <- and -> keys to step through your commands. If you are satisfied that the information is correct, press the -> until you see "Sure?>>Press Rec" appears in the display. If you decide not to transpose, press STOP to return to the Stand By mode.
7. Press RECORD. When the transposing process is completed, the MC-300 will beep.
8. Press STOP to return to the Stand By mode.

NOTE: Do not transpose MIDI drum parts or you will find the wrong drums playing the wrong parts.

Edit #7 Change
Velocity

When selecting Edit function #7, the display appears as follows:

```
EDIT 7  CHANGE VELO  
TRK 1-4  M. CH ALL
```

The Change Velocity function allows you to alter the dynamic range and scale the overall velocity level of previously recorded MIDI information. This can be performed on any MIDI channel(s), any track(s), and for any number of measures.

This is useful for changing the velocity response of sequenced parts to match different instruments or patches. Change Velocity is also used for creating subtle and dynamic changes (crescendos and decrescendos) within a piece. These changes are made using the Slope and Bias parameters.

Slope

"Slope" is the parameter used to exaggerate or compress the dynamic range of recorded MIDI data. It can be set from 0.0 to 2.0 in 0.1 increments. When the Slope is set to 1.0 (default value), there is no change to the dynamic range. As the slope is increased from 1.0 to 2.0, dynamic range is expanded. In other words, the soft notes get softer and the loud notes get louder. As Slope is decreased to values below 1.0, the dynamic range of the MIDI information is compressed. If Slope is set to 0.0, all notes will be assigned the same dynamic (64).

Bias

Bias allows you to shift the overall velocity amount up or down. If Bias is left at 0 (default mode), no change is made to the dynamics. Positive Bias values shift the velocity so that the performance is played harder. Negative Bias values shift the velocity so that a softer performance is achieved.

Summary

SLOPE	0.0	No dynamic range (completely compressed)
	1.0	No change in dynamic range
	2.0	Expands the dynamic range
BIAS	+	Increases the overall velocity
	-	Decreases the overall velocity
SLOPE: 0.0, BIAS: +0		
	e.g. 1	No dynamic response (velocity: 64) Performance is completely compressed.
SLOPE: 1.0, BIAS +30		
	e.g. 2	No change in dynamics, but increase in the overall velocity. Performance is played harder.
SLOPE: 2.0, BIAS: +0		
	e.g. 3	Expanded dynamic range; no change in overall volume.

MIDI has velocity levels from 0 to 127. When using Slope and Bias, 127 will always be the highest assignable value and 1 will be the lowest. Any value higher than 127 will be substituted with a value of 127. Any value lower than 1 will be assigned a value of 1. When this occurs, the value cannot be rewritten or changed by the Slope setting.

Procedure for Changing Velocity

1. Press ENTER. Select the Track(s) (1-4, 1,2,3,&4).
2. Press ENTER. Select MIDI channel (All, 1-16).
3. Press ENTER. Select the Slope (0.0 to 2.0).
4. Press ENTER. Select the Bias (+/- 1-99) using the Alpha Dial.
5. Press ENTER. Select starting measure.
6. Press ENTER. Select the number of measures you wish to change.
7. Press ENTER. If you would like to verify your changes, press the <- and -> keys to step through your commands. If you are satisfied that the information is correct, press the -> until you see "Sure?>>Press Rec" appears in the display.
8. If you don't want to change velocity, press STOP to return to the Stand By mode.
9. Press RECORD if you want to change the velocity. When the changing velocity function is completed, the MC-300 will beep.
10. Press the STOP button to return to Stand By mode.

Edit #8 Changing MIDI Channels

When edit function #8 is selected, the MC-300 display appears as follows:

EDIT 8 CHANGE M. CH
TRK 

The Change MIDI channel function allows you to take MIDI information on one MIDI channel and move it to a new MIDI channel. This can be done for any number of measures. Change MIDI function is useful for taking a song that was done on one MIDI system using one set of channel assignments and moving the channel assignments to meet your present system.

For example, you have a piano part played on MIDI channel 1 on the JX-8P. Using the Change MIDI Channel function, you can move the part to play on MIDI channel 2, which could be the MKS-80 Super Jupiter set to a brass sound. Since you can change the MIDI channel for each measure, the first 8 measures could be played back on the JX-8P piano sound and the second 8 measures could be played back on the MKS-80 brass sound.

Procedure for Changing MIDI channels

1. Press ENTER. Select the track(s) which contain the MIDI channels you wish to reassign (1-4, 1,2,3,&4).
2. Press ENTER. Select the MIDI Channel(s) you would like to change (All, 1-16).
3. Press ENTER. Select the new MIDI channel (1-16).
4. Press ENTER. Select the starting measure.
5. Press ENTER. Select the number of measures.
6. Press ENTER. If you would like to verify your changes, press the <- and -> keys to step through your commands. If you are satisfied that the information is correct, press the -> until you see "Sure?>>Press Rec" appears in the display. If you decide not to change MIDI channels, press STOP to return to the Stand By mode.
7. Press RECORD. When the MIDI channel changing process is completed, the MC-300 will beep.
8. Press STOP to return to the Stand By mode.

Edit #9 Quantizing

When edit function #9 is selected, the display appears as follows:

EDIT 9	QUANTIZE	f r o m
TRK	⊖	M . C H

Sometimes it is quite difficult to capture a performance which has the right feeling, the right notes, and perfect timing. The Quantize function will automatically correct slight timing inaccuracies recorded in a real-time performance.

Many times it is necessary to quantize a part several times at different resolution to obtain the desired "feel." It is a good idea to correct data to an empty track so you can retain your original performance. Quantization can be performed on individual or multiple measures.

The quantization resolutions in the MRC-300 are half notes, quarter notes, eighth notes, eighth note triplets, sixteenth notes, sixteenth note triplets, thirty-second notes, and sixty-fourth notes. Resolution is the highest note value that the sequencer will play.

Quantization can be applied to individual measures. For example: A performance including sixteenth notes in measure one, thirty-second notes in measure two, and eight-note triplets in measure three, can be quantized to measure to a different resolution for each measure.

Procedure for Quantization

1. Press ENTER. Select tracks (1-4, 1,2,3, or 4).
2. Press ENTER. Select MIDI channels (All, 1-16), select quantize resolution (1/2 - 64th).
3. Press ENTER. Select starting measure.
4. Press ENTER. Select the number of measures to be auto-corrected (Quantized).
5. Press ENTER. Select the destination track (1-4). Remember, it is a good idea to correct to a new track if possible.
6. Press ENTER. If you would like to verify your changes, press the <- and -> keys to step through your commands. If you are satisfied that the information is correct, press the -> until you see "Sure?>>Press Rec" appears in the display. If you decide not to quantize, press STOP to return to the Stand By mode.
7. Press RECORD. When the quantizing process is completed, the MC-300 will beep.
8. Press STOP to return to the Stand By mode.
9. By selecting either the new corrected track or the original track, you can hear the effect of the quantization. If necessary, repeat the process with a new resolution.

Edit #10 Copy

When edit function #10 is selected, the display appears as follows:

EDIT 10	COPY	f r o m
TRK	⊖	

Copy allows you to take MIDI information from anywhere on a track(s) and duplicate it to any location on another track(s) as many times as needed. This can include individual or all MIDI channels, one track, or all tracks (including rhythm and tempo).

The Copy function is similar to cut and paste on a word processor and is the most powerful song structure editing function found on the MC-300.

For example, you have just recorded a two measure bass line on track #1. To extend the bass line, you can copy it 50 times to end up with 100 measure bass line.

In another example, you have an eight measure chorus that starts at measure 60. By using the Copy function, you can copy all of the tracks from measure 60, for eight measures to measures 69 through 77. Now your chorus will repeat twice.

In a third example, you have a synthesizer part on MIDI channel #1 of a merged track which contains five other MIDI channels. If you would like to use this part alone as an intro figure, you can use the Copy function to copy only channel #1 twice from the bridge to measure #1 on track 2.

In another example, you have a piano part (MKS-20) on channel 1 merged with several other parts on track 1. You can copy just the piano part from track 1 to track #2. Now you can change track 2's channel from 1 to 3 for the length of the piece. Now the JX-10's "metallic E piano" (ch.3) will double the MKS-20 for the length of the tune. Remember that this technique will use up memory.

Note: Your copying edits cannot exceed the total number of measures currently in the song. Therefore, it is a good idea to insert plenty of blank measures in an unused track, such as the tempo or rhythm track before proceeding with the copying function.

Procedure for Copying

1. Press ENTER. Select the track(s).
2. Press ENTER. Select the MIDI channel (All, 1-16).
3. Press ENTER. Select the measure where you wish to begin copying.
4. Press ENTER. Select the number of measures you wish to copy.
5. Press ENTER. Select the number of times you want the measures to be copied.
6. Press ENTER. Select the destination track(s).
7. Press ENTER. Select the measure number where the copied measures will begin.
8. Press ENTER. If you would like to verify your changes, press the <- and -> keys to step through your commands. If you are satisfied that the information is correct, press the -> until you see "Sure?>>Press Rec" appears in the display. If you decide not to copy, press STOP to return to the Stand By mode.
9. Press RECORD. When the copying process is completed, the MC-300 will beep.
10. Press STOP to return to the Stand By mode.

Section #9

MICROSCOPE EDITING

Microscope Editing

The Microscope function of the MRC-300 software allows you to perform intricate editing on individual MIDI events. A MIDI event can be pitch, velocity, gate time, program change, pitch bend, modulation depth, after-touch, tune request, system exclusive, and/or continuous controller information. All MIDI events appear in the display window and are indicated by a measure number and a clock pulse. The Alpha Dial is used to scroll through song information. To locate a specific event in a song, rotate the Alpha Dial while listening to the playback.

Any aspect of your performance can be altered after the performance data has been entered into the MC-300. This allows you to correct notes, re-assign MIDI channels, or perform any of the editing functions described below.

Change Event

The Change Event function allows you to alter any aspect of your performance without having to repeat your performance.

For example, when you were recording your performance, you played a wrong note. Except for this one note, the rest of the song was perfect. By using the Change Event function, you can scroll to the incorrect note and replace it with a new note number.

Another example of Change Event editing may involve a non-note event such as program change. For example, when you originally recorded your song, you were playing a JX-8P. Now that you are using a Juno-2, your original program changes no longer coincide with the correct sounds. If you would still like the program changes to occur at the same places in the song, you can change only the program change numbers so that they will coincide with the correct sounds on the Juno-2.

Note: Once you are in Microscope mode, rotating the Alpha Dial will display note information only. To display other MIDI events (Pitch Bend, Program Change, After Touch etc.) as well as note information, hold down the SHIFT button while rotating the Alpha Dial.

Procedure for Changing the Note Event

1. Go to the Stand By mode.
2. Press MICROSCOPE.
3. Press the <- key twice, select the track you wish to edit with the Alpha Dial(1,2,3 or 4).
4. Press the -> key, use the Alpha Dial to select the measure number where you wish to begin editing.
5. Press the -> key until the "CPT" display flashes.
6. Rotate the Alpha Dial to locate the Note event you wish to change.
7. Press the EDIT button ("EDIT 1" will flash), press ENTER.
8. Select a new MIDI channel (1-16), press ENTER (If you wish to default to the existing MIDI channel, press ENTER).
9. Select a new note (C/0 - G/9), press ENTER (If no new note is desired, press ENTER).
10. Select a new velocity (1 - 127), press ENTER (If no new velocity is desired, press ENTER).
11. Select a new gate time (1 - 65,535), press ENTER (If no new gate time is desired, press ENTER).
12. Press Stop to return to the Stand By mode.

Changing Polyphonic After-Touch (PAf)

If you have entered PAf (Polyphonic After-Touch) information into the MC-300, you may change it at a later time. You can change the MIDI channel, the note number, and the value of the polyphonic after-touch (PAf).

For example, if you played too much PAf onto a specific note, you may lower the value without affecting the note. On the other hand, you may have used PAf and are satisfied with the amount of after touch used, but wish to only change the note. This can be useful when you have re-assigned after-touch from one function (i.e. modulation) to another function (i.e. volume).

Procedure for Changing PAF (Polyphonic After-Touch)

1. Go to the Stand By mode (If you are already in MICROSCOPE, hold down the SHIFT key and rotate the Alpha Dial to locate the PAF event. Proceed to step 7).
2. Press MICROSCOPE.
3. Press the <- key twice, select the track you wish to edit (1 - 4).
4. Press the -> key, select the measure number where you wish to begin editing.
5. Press the -> key until the "CPT" display flashes.
6. Hold down the SHIFT key and rotate the Alpha Dial to locate the PAF event you wish to change.
7. Press the EDIT button ("EDIT 1" will flash), press ENTER.
8. Select a new MIDI channel (1-16), press ENTER (If no new MIDI channel is desired, press ENTER).
9. Select a new PAF note number (0 - 127), press ENTER (If no new value is desired, press ENTER).
10. Select a new PAF value, Press ENTER (If no new value is desired, press ENTER).
11. Press Stop to return to Stand By mode.

Control Change (CC)

In MIDI, Control Change refers to many different MIDI parameters. For example, control change #1 is modulation, control change #7 is MIDI volume, and control change #64 is the hold (sustain) function.

Control numbers are assigned values (0-127). For example, you have used control change #7 (MIDI volume) in your piece but want to change it at a later time. You can locate this event and increase or decrease the volume level by changing the control change value. (Please refer to the Control Change chart in section #4-3).

For more information on Control Change, see the explanation in the "MIDI Button" section of this manual.

Procedure for Changing Control Change (CC)

1. Go to the Stand By mode (If you are already in MICROSCOPE, hold down the SHIFT key and rotate Alpha Dial to locate "CC." Proceed to step 7).
2. Press MICROSCOPE.
3. Press the <- key twice, select the track you wish to edit (1 - 4).
4. Press the -> key, select the measure number where you wish to begin editing.
5. Press the -> key until the "CPT" display flashes.
6. Hold down the SHIFT button and rotate the Alpha Dial to locate the CC event you want to change.
7. Press the EDIT button ("EDIT 1" will flash), press ENTER.
8. Select a new MIDI channel (1-16), press ENTER (If no new MIDI channel is desired, press ENTER).
9. Select a new CC number (0-127), press ENTER (If no new CC number is desired, press ENTER).
10. Select a new value (0 - 127), press ENTER, (If no new value is desired, press ENTER).
11. Press Stop to return to Stand By mode.

Changing Program Change (PG)

Program change numbers in the MC-300 range from 1-128 and correspond to specific sounds on a slave MIDI instrument. After you have entered program changes in your composition, you may change the program change number so a different sound or patch will be called up on the slave instrument. This is useful when playing different instruments where the patches do not line up with the program changes currently residing in the sequencer.

Procedure for Changing Program Change (PG)

1. Go to the Stand By mode (If you are already in MICROSCOPE, hold down the SHIFT key and rotate Alpha Dial to locate "PG" event. Proceed to step 7).
2. Press MICROSCOPE.

3. Press the <- key twice, select the track you wish to edit (1 - 4).
4. Press the -> key, select the measure number where you wish to begin editing.
5. Press the -> key until the "CPT" display flashes.
6. Hold down the SHIFT key and rotate the Alpha Dial to locate the PG event you wish to change.
7. Press the EDIT button ("EDIT 1" will flash), press ENTER.
8. Select a new MIDI channel (1-16), press ENTER (If no new MIDI channel is desired, press ENTER).
9. Select a new program change number (1 - 128), press ENTER (If no new program change number is desired, press ENTER).
10. Press Stop to return to the Stand By mode.

Changing Channel After-Touch (CAf)

The value (0-127) of channel after- touch may be changed after it is entered into the MC-300. If you have played an incorrect amount of after-touch, you may increase or decrease the after-touch value for the desired effect.

Changing channel after-touch can also be used if you have routed your after-touch to a different parameter in your instrument and the current value is not producing the desired results.

Procedure for Changing Channel (Monophonic) After-Touch (CAf)

1. Go to the Stand By mode (If you are already in MICROSCOPE, hold down the SHIFT key and rotate the Alpha Dial to locate "CAf" event. Proceed to step 7).
2. Press MICROSCOPE.
3. Press the <- key twice, select the track you wish to edit (1 - 4).
4. Press the -> key, select the measure number where you wish to begin editing.

5. Press the -> key until the "CPT" display flashes.
6. Hold down the SHIFT key and rotate the Alpha Dial to locate the CAf event you wish to change.
7. Press the EDIT button ("EDIT 1" will flash), press ENTER.
8. Select a new MIDI channel (1-16), press ENTER (If no new MIDI channel is desired, press ENTER).
9. Select a new CAf value (0 - 127), press ENTER (If no new CAf value is desired, press ENTER).
10. Press STOP to return to the Stand By mode.

Changing Pitch Bend (PB)

This function is used to change the range of the pitch bend. For example, if you have recorded pitch bend information from an instrument with a narrow range and want to use another instrument with a wider range, this function would be used.

Procedure for Changing Pitch Bend (PB)

1. Go to the Stand By mode (If you are already in MICROSCOPE, hold down the SHIFT key and rotate the Alpha Dial to locate "PB" event, Proceed to step 7).
2. Press MICROSCOPE.
3. Press the <- key twice, select the track you wish to edit (1 - 4).
4. Press the -> key, select the measure number where you wish to begin editing.
5. Press the -> key until the "CPT" display flashes.
6. Hold down the SHIFT key and rotate the Alpha Dial to locate the PB event you wish to change.
7. Press the EDIT button ("EDIT 1" will flash), press ENTER.
8. Choose a new MIDI channel (1-16), press ENTER (If no new MIDI channel is desired, press ENTER).
9. Choose a new PB range (-127 - +127), press ENTER (If no new PB range is desired, press ENTER).
10. Press STOP to return to the Stand By mode.

Changing System Exclusive

Procedure for Changing System Exclusive (EX)

NOTE: Each manufacturer has been assigned a system exclusive code. In order to understand system exclusive, you must know the code for the manufacturer and the instrument you are playing. Please refer to your individual instrument's owner's manual.

(For more information on System Exclusive, see the explanation Recording System Exclusive in the "Real Time Recording" section of this manual.

1. Go to the Stand By mode (If you are already in MICROSCOPE, hold down the SHIFT key and rotate Alpha Dial to locate "EX" event. Proceed to step 7).
2. Press MICROSCOPE.
3. Press the <- key twice, select the track you wish to edit (1 - 4).
4. Press the -> key, select the measure number where you wish to begin editing.
5. Press the -> key until the "CPT" display flashes.
6. Rotate the Alpha Dial to locate the EX event you wish to change.
7. Press the EDIT button ("EDIT 1" will flash), press ENTER.
8. Enter new system exclusive values using the Ten Key pad (only), press ENTER (if no new EX value is desired, press ENTER).
9. Press STOP to return to the Stand By mode.

Delete Event

The Delete Event function allows you to locate and omit any MIDI event by using the Alpha Dial.

For example, in the song you just recorded, when you reached for E-flat you accidentally played an E-natural at the same time. Every other aspect of your performance was perfect. Using the Delete event function, you can remove only the E-natural while leaving the E-flat intact.

In another song, you used modulation on one note of your lead line. If you decide to remove the modulation at a later time, you can use the delete function to remove the modulation without affecting any other aspect of the note.

Deleting Any Event

Procedure for Deleting any Event

1. Go to the Stand By mode (If you are already in MICROSCOPE mode, rotate the Alpha Dial to locate the event you wish to delete. Proceed to step 7.)
2. Press MICROSCOPE.
3. Press the <- key twice, select the track you wish to edit (1 - 4).
4. Press the -> key, select the measure number where you wish to begin editing.
5. Press the -> key until the "CPT" display flashes.
6. Rotate the Alpha Dial to locate the event you wish to delete.
7. Press the EDIT button ("EDIT 1" will flash).
8. Rotate the Alpha Dial until display reads "DELETE Event".
9. Press ENTER.
10. Press the REC Button.
11. Press Stop to return to the Stand By mode.

Insert Event

The Insert Function allows you to add MIDI information to a song you have already recorded.

Going back to the previous example, if you decide you preferred the note with modulation and would like to add pitch bend, you could use the Alpha Dial to scroll to the appropriate note and insert both of these MIDI events.

Inserting a Note

Procedure for Inserting a Note

1. Go to the Stand by Mode. (If you are already in MICROSCOPE, proceed to step 3.)
2. Press MICROSCOPE.
3. Press the <- key twice, select the track you wish to edit (1 - 4).

4. Press the -> key, select the measure number where you wish to begin editing.
5. Press the -> key until the "CPT" display flashes.
6. Select the Clock Pulse Time (CPT) where you want to Insert the new note, press ENTER.
7. Press the EDIT button.
8. Rotate Alpha Dial until "INSERT Event" is displayed, press ENTER.
9. Press ENTER, rotate the Alpha Dial until "NOTE" is displayed, press ENTER.
10. Select MIDI Channel (1-16) , press ENTER.
11. Select Note (C-0 through G-9 127), press ENTER.
12. Select Velocity (1-127), press ENTER.
13. Select Gate Time (1 through 65,535), press ENTER.
14. Press Stop to return to the Stand By mode.

Inserting After-Touch (PAf)

This function allows you to insert after-touch after you have recorded note information. For example, you may have recorded a sequence using a keyboard controller that does not send polyphonic after-touch but the sound module you are using responds to polyphonic after-touch. Inserting PAF in the MC-300 can be accomplished in the following procedure.

Procedure for Inserting Polyphonic Aftertouch (PAf)

1. Go to the Stand By Mode (If you are already in MICROSCOPE, proceed to step 3.)
2. Press the MICROSCOPE button.
3. Press the <- key twice, select the track you wish to edit (1 - 4).
4. Press the -> key, select the measure number where you wish to begin editing.
5. Press the -> key until the "CPT" display flashes.
6. Select the Clock Pulse Time (CPT) where you want to Insert the PAF, press ENTER.
7. Press the EDIT button.

8. Rotate the Alpha Dial until "INSERT Event" is displayed, press ENTER.
9. Press ENTER, rotate Alpha Dial until "PAf" is displayed, press ENTER.
10. Select MIDI Channel (1-16) , press ENTER.
11. Rotate the Alpha Dial to select the PAf note number (0-127), press ENTER.
12. Select the PAf value with the Alpha Dial (0-127), press ENTER.
13. Repeat steps 11 and 12.
14. Press STOP to return to Stand By mode.

Inserting Control Change (CC)

Control change numbers may be entered after the music is recorded. This may be useful if you wish to enter modulation for specific notes, add volume changes to phrases, insert hold pedal (sustain), center (zero) the pitch bend value, or if you are using a MIDI controller which cannot send these parameters. You can be much more precise when inserting control change information in this manner since you are inserting CC numbers and values by clock pulse (CPT).

For more information, see the "Control Change" explanation in the "MIDI Button" section of this manual.

Procedure for Inserting Control Changes (CC)

1. Go to the Stand By Mode (If you are already in MICROSCOPE, proceed to step 3).
2. Press the MICROSCOPE button.
3. Press the <- key twice, select the track you wish to edit (1 - 4).
4. Press the -> key, select the measure number where you wish to begin editing.
5. Press the -> key until the "CPT" display flashes.
6. Using the Ten Key pad, enter the Clock Pulse Time (CPT) where you wish to Insert the CC, press ENTER.
7. Press the EDIT button.
8. Rotate the Alpha Dial until "INSERT Event" is displayed, press ENTER.

9. Press ENTER, rotate the Alpha Dial until "CC" is displayed, press ENTER.
10. Select MIDI Channel (1-16) , press ENTER.
11. Select the CC number (0-127), press ENTER.
12. Select CC Value (0-127), press ENTER.
13. Press Stop to return to the Stand By mode.

Inseting Program Changes (PG)

Program changes are usually entered in between notes during a performance. If you attempt to enter program changes while notes are being played on an instrument, clicking or glitching can occur. The microscope mode can be used to insert program changes by clock pulse. This technique allows you to carefully insert the program changes in between notes so that they do not interfere with the performance data.

Procedure for Inserting Program Change (PG)

1. Go to the Stand By Mode. (If you are already in MICROSCOPE, proceed to step 3).
2. Press the MICROSCOPE button.
3. Press the <- key twice, select the track you wish to edit (1 - 4).
4. Press the -> key, select the measure number where you wish to begin editing.
5. Press the -> key until the "CPT" display flashes.
6. Select the Clock Pulse Time (CPT) where you wish to Insert the PG, press ENTER.
7. Press the EDIT button.
8. Rotate the Alpha Dial until "INSERT Event" is displayed, press ENTER.
9. Use the Alpha Dial to change the CPT. Press ENTER, rotate the Alpha Dial until "PG" is displayed, press ENTER.
10. Select MIDI Channel (1-16) , press ENTER.
11. Select PG number (1 through 128), press ENTER.
12. Press Stop to return to Stand By mode.

Inserting Channel
(monophonic)
After-Touch

You may wish to insert after-touch information after you have recorded your performance. This function can also be useful if you are playing a sound module that accepts after-touch from a keyboard controller that does not send after-touch information.

**Procedure for Inserting Channel (monophonic)
Aftertouch (CAf)**

1. Go to the Stand By mode. (If you are already in MICROSCOPE, proceed to step 3.)
2. Press the MICROSCOPE button.
3. Press the <- key twice, select the track you wish to edit (1 - 4).
4. Press the -> key, select the measure number where you wish to begin editing.
5. Press the -> key until the "CPT" display flashes.
6. Using the Ten Key pad, enter the Clock Pulse Time (CPT) where you want to Insert the CAf, press ENTER.
7. Press the EDIT button.
8. Rotate Alpha Dial until "INSERT Event" is displayed, press ENTER.
9. Press ENTER, rotate the Alpha Dial until "CAf" is displayed, press ENTER
10. Select MIDI Channel (1-16) , press ENTER.
11. Select CAf value (0-127), press ENTER.
12. Press Stop to return to Stand By mode.

Inserting Pitch
Bend (PB)

Procedure for Inserting Pitch Bend (PB)

1. Go to Stand By Mode. (If you are already in MICROSCOPE, proceed to step 3.)
2. Press the MICROSCOPE button.
3. Press the <- key twice, select the track you wish to edit. (1-4).
4. Press the -> key, select the measure number where you wish to begin editing.
5. Press the -> key until the "CPT" display flashes.

6. Using the Ten Key pad, enter the Clock Pulse Time (CPT) where you wish to Insert the PB, press ENTER.
7. Press the EDIT button.
8. Rotate the Alpha Dial until "INSERT Event" is displayed, press ENTER.
9. Press ENTER, rotate the Alpha Dial until "PB" is displayed, press ENTER.
10. Select MIDI Channel (1-16) , press ENTER.
11. Select PB value (-127 through +127), press ENTER.
12. Press STOP to return to Stand By mode.

Inserting System Exclusive (EX)

Parameters such as filter, resonance, wave forms, etc., can be changed during a performance through system exclusive. System exclusive may also contain the commands that some instruments will need before sending their System Exclusive information. This function can be valuable if you understand how to program system exclusive and would like new patches or parameter changes to be entered into the MC-300.

Procedure for Inserting System Exclusive (EX)

NOTE: Each manufacturer has been assigned a system exclusive code. In order to understand system exclusive, you must know the code for the manufacturer and the instrument you are working with. Refer to your individual instrument's owner's manual for more information.

1. Go to the Stand By Mode. (If you are already in MICROSCOPE, proceed to step 3.)
2. Press the MICROSCOPE button.
3. Press the <- key twice, select the track you wish to edit (1 - 4).
4. Press the -> key, select the measure number where you wish to begin editing.
5. Press the -> key until the "CPT" display flashes.
6. Using the Ten Key pad, enter the Clock Pulse Time (CPT) where you want to Insert the EX, press ENTER.
7. Press the EDIT button.

8. Rotate the Alpha Dial until "INSERT Event" is displayed, press ENTER.
9. Press ENTER, rotate the Alpha Dial until "EX" is displayed, press ENTER.
10. Enter system exclusive values, press ENTER.
11. Press Stop to return to Stand By mode.

Inserting Tune Request (TU)

Tune request is a command which tells certain instruments to initiate their "tune up" procedure. The MKS-80 Super Jupiter will respond to a tune request. You can insert a tune request anywhere during the performance to assure precise intonation.

Tune request is usually inserted at the beginning of the composition while a blank lead in measure is being played. You must be careful when using tune request during a performance because most instruments will not respond to note information while going through their tuning routine. Refer to your individual instrument's owner's manual for more information.

Procedure for Inserting Tune Requests (TU)

1. Go to Stand By Mode (if you are already in MICROSCOPE, proceed to step 3.)
2. Press the MICROSCOPE button.
3. Press the <- key twice, select the track you wish to edit (1 - 4).
4. Press the -> key, select the measure number where you wish to begin editing.
5. Press the -> key until the "CPT" display flashes.
6. Using the Ten Key pad, enter the Clock Pulse Time (CPT) where you wish to Insert the TU, press ENTER.
7. Press the EDIT button.
8. Rotate the Alpha Dial until "INSERT Event" is displayed, press ENTER.
9. Press ENTER, rotate the Alpha Dial until "TU" is displayed, press ENTER.
10. Press ENTER again to insert tune request.
11. Press Stop to return to the Stand By mode.

Change CPT (Clock Pulse Time)

The Change CPT function allows you to move any single MIDI event forward or backward by Clock Pulse.

A Clock Pulse is a subdivision of time. In the MRC-300, each quarter note equals 96 clock pulses (384 CPT's per measure in 4/4 time). Every MIDI event occurs in the measure at a specific clock pulse number. Change CPT relocates a MIDI event from one clock pulse to a new clock pulse value. You can experiment with different "feels" or correct timing inaccuracies by changing the timing of the event to a position earlier or later than it was originally recorded in the measure.

For example, all the notes in the song you just recorded were played correctly but one note was played late. Using the

Change CPT function, the note can be moved to an earlier clock pulse making it rhythmically correct.

Changing Clock Pulse Time (CPT) on a Single MIDI Event

Procedure for Changing Clock Pulse Time (CPT) of a Single MIDI Event

1. Go to the Stand By mode. (If you are already in MICROSCOPE, proceed to step 3.)
2. Press the MICROSCOPE button.
3. Press the <- key twice, select the track you wish to edit (1 - 4).
4. Press the -> key, select the measure number where you wish to begin editing.
5. Press the -> key until the "CPT" display flashes.
6. Rotate the Alpha Dial to locate the desired event that you wish to relocate to another CPT.
7. Press the EDIT button.
8. Rotate the Alpha Dial until "CHANGE CPT" is
9. Rotate the Alpha Dial to the CPT where you would like to relocate the desired event, press ENTER.
10. Press STOP to return to the Stand By mode.

Section #10

TEMPO TRACK

Tempo Track

The MC-300 is capable of performing tempo changes during a song. These changes are stored on the tempo track.

The tempo track is used for entering tempo information only, so that tempo changes (accelerandos or ritards) can be attained during playback of your song. New metronome markings (changes in tempo) can be entered in real time or in step time.

Real Time

It is possible to record tempo changes during a song in real time. During playback, the tempo changes are referenced to a base tempo (overall tempo).

When an accelerando begins, an upward pointing arrow will appear next to the BPM (Beats Per Minute). When a ritard begins, downward pointing arrow will appear next to the BPM display. While a song is playing back, the overall tempo can be increased or decreased by using the Alpha Dial. All tempo changes (ritards and accelerandos) will be retained in the new tempo.

Procedure for Entering Tempo Changes in Real Time

1. Go to the Stand-By mode. Select a basic tempo. (See the section on "Selecting A Basic Tempo".)
2. Press the <- key until the measure indicator flashes. Select the measure where you want the tempo changes to begin.
3. Press the -> key until the recording mode indicator flashes. Use the Alpha Dial to select "Real" time recording.
4. Press the -> key until the track selector indicator flashes in the window. Use the Alpha Dial to select "T" (tempo track).
5. Press RECORD. Press PLAY. You will hear a two measure count off before the tempo track begins recording.
6. Use the Alpha Dial or the Ten Key pad to record the tempo changes.
7. Press STOP when you are finished recording the tempo changes.

Step Time

Tempo changes can be recorded into the tempo track in Step Time. This procedure is similar to the way note information is recorded in step time.

Procedure for Entering Tempo Changes in Step Time

1. Go to the Stand By mode.
2. Press the FUNC button. Press #9 and ENTER.
Select the Basic Tempo using the Alpha Dial or the Ten Key Pad. Press ENTER to store Basic Tempo. You have now chosen a basic (overall) tempo to which all tempo changes will be referenced.
3. Press STOP to enter the Stand By mode.

```
SONG 1  
MEAS 1 J = 120 REAL 1
```

4. Use the -> key to move to the Record Mode indicator. The record mode indicator will flash in the display. Use the Alpha Dial until "STEP" appears in the display.
5. Press -> to move to the track display. The track number will now flash. Turn the Alpha Dial again until "T" is displayed. Press the REC button.

```
STEPT MEAS 1 CPT 0  
24 J = 120
```

The note resolution display will now flash and prompt you to select a rhythmic value. The MC-300 will allow you to enter a different tempo change for each rhythmic value (CPT). For instance, if you select 1/64th notes (6 CPTs) as your resolution, you will be able to enter a different tempo for every 6th clock pulse (1/64th note). This will allow you to record tempo changes (accelerandos or ritards) in small increments. If you do not need this type of resolution, you may wish to go to a higher resolution such as 1/2 note (192). This will allow you to have a different tempo for every other beat (192 CPT).

You may now select a resolution for step entry ranging from half notes to 1/64th notes. Select a rhythmic value and then press ENTER

6. The metronome marking display will now flash. Select a new tempo (10 - 250 BPM), press ENTER. Using this method, you can have a different tempo for each Clock Pulse resolution. If you would like this tempo to continue for subsequent CPTs, press ENTER as many times as you want this tempo repeated. You may also enter a new tempo at any time.
7. Press STOP to return to the Stand By mode.
NOTE: Tempo information can be step loaded from any measure. To do this, press the <- key until the measure display flashes. Choose the measure where you would like to enter the new tempo information. Press REC, select a rhythmic resolution, and press ENTER. Select a new tempo, and press ENTER. If you change the basic tempo after you have entered the tempo track, this change will be remembered and all tempo changes you have entered will be relative to this new basic tempo.

For more information about tempo, see the "Basic Tempo" explanation in the function section of this manual.

Section #11

The Rhythm Track

The Rhythm Track

The MC-300 software allows you to write up to 90 Rhythm Patterns. These patterns can be assigned common or complex time signatures with resolutions up to 1/32nd note. Patterns can be linked together to form complete drum and percussion score. The Rhythm Track will allow you to enter different time signatures into every measure which makes it useful as a conductor track.

Patterns are created in the Rhythm Pattern (R-PTN) mode. Linking patterns is accomplished in the Rhythm Track (R-TRK) mode.

Rhythm Pattern (R-PTN)

A Rhythm Pattern (R-PTN) is a complete measure of a drum part with a defined time signature. These drum patterns can be written using different time signatures for each pattern.

Although the patterns are created on the MC-300 in the R-PTN mode, the actual drum sounds will come from any MIDI drum machine connected to the MC-300. The Rhythm Patterns are written by utilizing a series of step write functions within the sequencer.

Most MIDI compatible drum machines (such as the Roland TR-707, TR-727, and TR-505) can be used for R-PTN mode. The MC-300 can send drum data (note number/velocity) 32 different drum sources. These 32 voice capability allows you to utilize all of the combined drum and percussion voices of the TR-707 and TR-727 Rhythm Composers.

Rhythm Track (R-TRK)

In the Rhythm Track (R-TRK), you can link together rhythm patterns written in the R-PTN mode to create a complete drum score for a song. The R-TRK mode also doubles as a conductor track so you can program time signature variations for each song.

MIDI Functions of the Rhythm Track

The following MIDI functions must be matched between the MC-300 and the MIDI drum machine you are using before you can begin creating rhythm patterns and tracks:

1. **MIDI Channel Assignment:** The MIDI drum machine and the Rhythm Track must be assigned to the same MIDI channel (1-16).
2. **MIDI Note Number Assignments:** The MIDI drum machine and the Rhythm Track must be assigned to the same note numbers.
3. **Naming the Drum Voice:** The drum names stored in the Rhythm Track can be changed to match the names of the drums on the MIDI drum machine you are using.
4. **Rhythm Velocity (1 through 8):** When you are using drum machines that respond to velocity information, the Rhythm Track will send 8 variable velocity levels.

Rhythm MIDI Channel Function #6

Procedure for Changing the R-PTN MIDI Channel Number

MIDI channel 10 is the default channel number for the Rhythm Pattern (R-PTN) on the MC-300. You may assign a different channel number by following this procedure:

1. Press the FUNC button.
2. Rotate the Alpha Dial until the display reads "RHYTHM M. CH" (FUNC 6). Press ENTER.
3. Rotate the Alpha Dial until the display indicates the desired MIDI Channel Number (1-16). Press ENTER.
4. Press STOP to return to the Stand By mode.

Note: Make sure the MIDI drum machine you are using is set to receive on the same MIDI channel number assigned as the MC-300 software. Refer to the Owner's Manual of your drum machine for information about changing MIDI channels.

MIDI Note Numbers

The MRC-300 software allows you to re-assign MIDI note numbers to match specific drum voices on your MIDI drum machine. Your drum machine owner's manual will have a list indicating the MIDI note numbers for each drum voice (i.e. MIDI note number, etc).

Rhythm Instrument Function #5

Procedure for Viewing the Default Instrument Names and Note Number Assignments

1. Press the FUNC button.
2. Rotate the Alpha Dial until the display reads "RHYTHM INST" (FUNC 5). Press ENTER.
3. Rotate the Alpha Dial slowly to view the individual instrument names and their note numbers.
4. Press STOP to return to the Stand By mode.

Procedure for Changing the Instrument Name and MIDI Note Number

1. Press the FUNC button.
2. Rotate the Alpha Dial until the display reads "RHYTHM INST" (FUNC 5). Press ENTER.
3. Rotate the Alpha Dial until the desired instrument number is displayed. Press ENTER.
4. Rotate the Alpha Dial slowly until the display indicates the desired symbol (upper/lower case letters, numbers, etc.).
5. Use the -> key to move to the next symbol.
6. Continue steps 7 and 8 until the drum voice is renamed (up to 3 characters). Press ENTER.
7. Rotate the Alpha Dial until the desired note number is obtained (0-99). Press ENTER.
8. To continue the process for the remaining drum names and note numbers, press ENTER and follow steps 4 through 12.
9. Press STOP to return to the Stand By mode.

Rhythm Velocity Function #4

The rhythm track of the MC-300 has 8 levels of velocity. The default values cover a usable range for most applications. If desired, each of these eight levels can be reassigned to have a different velocity level (1-127).

Procedure for Changing the Rhythm Velocity

1. Press the FUNC button.
2. Rotate the Alpha Dial until the display reads "RHYTHM VELO" (FUNC 4). Press ENTER.
3. Rotate the Alpha Dial until the desired velocity level is obtained (1 - 127) for the first rhythm velocity. Press ENTER.
4. Continue steps 4 and 5 until the eight levels of velocity have been reprogrammed.
5. After programming rhythm velocity # 8, Press ENTER.
6. Press STOP to return to the Stand By mode.

Note: It is advised that you program the eight levels of rhythm velocity in ascending order with each level having a higher velocity value than the previous rhythm velocity number. For example:

Level 8 = 127
Level 7 = 100
Level 6 = 95
Level 5 = 86, etc.

Writing a Rhythm Pattern

Procedure for Writing a Rhythm Pattern

1. Go to the Stand By mode.
2. Press the -> or <- button until "Record Mode" flashes in the display.
3. Rotate the Alpha Dial until the display indicates "R-PTN."
4. Press the REC button.

5. Rotate the Alpha Dial to select the R-PTN number you wish to write (1 through 90). Press ENTER.
6. Rotate the Alpha Dial to select the BPM (beats per measure). Press ENTER.
7. Rotate the Alpha Dial to select what note will receive one beat (2, 4, 8, 16). Press Enter.
8. Rotate the Alpha Dial to select the first INST (instrument) you want to write (1 through 32).
Note: The name and key number of the instrument appear to the right of the INST number. Press ENTER.
9. Hold down the SHIFT key and press the PLAY button. This will start the pattern so that you will hear the drum voices as you load each step. To stop the pattern from playing, press the PLAY button again.
10. Rotate the Alpha Dial to select the resolution (32nd, 16th triplet, 16th, 8th triplet, 8th, or quarter).
Note: The resolution indicates how many steps are contained in the selected time signature. For example, if 4/4 time is selected, a resolution of a 16th note will have 16 steps per bar for the instrument selected. Press ENTER.
Note: The display will now indicates that it is ready to receive the rhythm velocity numbers for each step.
EX: Rhythm 1-1
11. Press the desired rhythm velocity number (1-8) for the first step by pressing that number on the Ten Key pad.
Note: If you want to insert a Rest on any of the steps within the R-PTN, press the 0 key.
12. After entering the rhythm velocity number, the display will automatically advance to the next step.
13. Continue procedure 15 until you have entered in all the necessary steps and rhythm velocity levels for the instrument.
Note: If you make a mistake while entering, use the -> and <- buttons to move the cursor underneath the step you wish to edit. Select numbers 0 through 8 on the Ten Key pad to enter the necessary edit. Press ENTER.

14. Rotate the Alpha Dial until the display shows the next instrument you want to load (1-32) Press Enter.
15. Follow procedures 9 through 13 until you have entered all the necessary instruments for the Rhythm Pattern (R-PTN). Press ENTER. The individual steps with assigned velocity levels will be displayed.
16. To write another R-PTN number, hold down the SHIFT button, then press the ENTER button.
17. Rotate the Alpha dial to select the new R-PTN you want to write (1-32).
18. Follow the above procedures to write the new R-PTN.
19. Press STOP to return to the Stand By mode.

Flam

A flam is a grace note that occurs slightly before the programmed beat. On the MC-300, you can enter flams into the Rhythm Pattern mode for Snares, Toms, Bongos, Timbales, and other instruments with drum heads. A flam can be used on most MIDI drum/percussion devices including the TR-707, TR-505, TR-727 and DDR-30 Digital Drums.

Procedure for Entering a Flam

1. Press the -> button until "Record Mode" appears in the display.
2. Rotate the Alpha Dial until the display indicates "R-PTN."
3. Press the REC button.
4. Rotate the Alpha Dial until the display indicates the correct pattern number for entering the flam. Press ENTER.
5. Rotate the Alpha Dial to select the BPM (Beats Per Measure), press Enter. Rotate the Alpha Dial to select the note value, press ENTER.
6. Rotate the Alpha Dial until the display indicates the correct instrument (INST) for adding the flam. Press ENTER.

7. Rotate the Alpha Dial to select the desired resolution.
Note: The resolution function will determine the degree of the flam. For example, a quarter note resolution will allow you to create an open sounding flam while a higher resolution of a 16th will create a tighter sounding flam. You may want to experiment for different effects Press ENTER.
8. Use the -> button to cursor to the step where you want to enter the flam.
9. Press and hold the SHIFT button.
10. Select the appropriate rhythm velocity level (1-8) with the Ten Key pad.
11. Press the ENTER button to select another drum voice.
12. Press STOP to return to the Stand By mode.
Note: The flam procedure (procedures 12 and 13) can also be performed while you are writing the original pattern.

Erase Function

Procedure for Erasing a Pattern

Any rhythm pattern can be erased.

1. Press the -> button until "Recording Mode" flashes in the display.
2. Rotate the Alpha Dial until the display indicates "R-PTN".
3. Press the REC button.
4. Rotate the Alpha Dial until the display indicates the Rhythm Pattern number you want to erase.
5. Press and hold the SHIFT button.
6. Press # 4 button on the ten key pad. Press ENTER.
7. To erase other patterns, follow procedures 3 through 6.
8. Press the STOP button to return to the Stand By mode.

Copy Function

The Copy function of R-PTN allows you to copy an existing pattern to another Rhythm Pattern number. This function is useful if you need a similar pattern to one you have already entered. After copying the pattern, you can edit the pattern by changing the velocity levels, changing instruments, etc.

Procedure for Copying a R-PTN

1. Press the -> button until "Record Mode" flashes in the display.
2. Rotate the Alpha Dial until the display indicates "R-PTN."
3. Press the REC button.
4. Rotate the Alpha Dial until the display indicates the Rhythm Pattern number you wish to Copy to.
5. Press and hold the SHIFT button.
6. Press the # 2 key on the ten-key pad. The word "COPY" appears in the display next to the pattern #.
7. Press ENTER.
8. Rotate the Alpha Dial until the display indicates the R-PTN number you wish to Copy from. Press ENTER.
Note: By following the procedures for "Writing A R-PTN," you can now edit the copied Rhythm Pattern.
9. Continue procedures 3 through 7 to Copy other Rhythm Patterns (R-PTN).
10. Press STOP to return to the Stand By Mode.

Writing a Rhythm Track (R-TRK)

The complete drum score (track) is created by linking the various patterns you have created in the Rhythm Pattern mode. This function is called Rhythm Track (R-TRK) and is similar in function to writing tracks on MIDI drum machines such as the Roland TR-Series Rhythm Composers. It is good practice to write out a Rhythm Pattern / Rhythm Track score on a sheet of paper. Arrange the page in such a way that it will detail which Rhythm Pattern numbers are to be used for a particular measure.

Procedure for Writing a Rhythm Track (R-TRK)

1. Press the -> button until "Record Mode" flashes in the display.
2. Rotate the Alpha Dial until the display indicates "R-TRK."
3. Press the REC button.
4. Rotate the Alpha Dial until the display indicates the Rhythm Pattern number you want to use as the first measure of the song. Press ENTER.
5. Continue procedures 4 and 5 until you have entered in the desired number of R-PTNs and measures.
6. After you have completed the R-TRK, press STOP to return to the Stand By Mode.

Edit Function

Procedure for Editing the Rhythm Track (R-TRK)

After listening to the Rhythm track you have programmed, you may change one or more of the pattern numbers.

1. Press the -> button until "Record Mode" flashes in the display.
2. Rotate the Alpha Dial until the display indicates "R-TRK."
3. Press the REC button.
4. Press the <- button until the measure number flashes.
5. Rotate the Alpha Dial until the display indicates the measure you want to edit. Press ENTER.
6. Rotate the Alpha Dial until the display indicates the R-PTN you want to insert. Press ENTER.
7. Continue procedures 4 through 8 to edit other measures if necessary.
8. Press STOP to return to the Stand By mode.

Entering Rests

The MC-300 allows you to enter measures or beats of rests in two ways:

- 1) By creating blank measures in the Rhythm track that contain only the time signature data (see creating a Conductor Track).
- 2) By utilizing R-PTN numbers 91 through 122 to create individual beats or measures of rests

R-PTN numbers 91 through 122 indicate rests (by beat). For example, R-PTN number 91 is equal to a 16th note rest, 92 equals an 8th note rest, 93 equals a dotted 8th, etc. See the chart below for a complete listing of these values.

This function is valuable when working with scores for video and film where the ability to insert or delete individual beats can prove essential.

Procedure for Entering Rests into the R-TRK

1. Press the -> button until "Record Mode" flashes in the display.
2. Rotate the Alpha Dial until the display indicates "R-TRK".
3. Press the REC button.
4. Rotate the Alpha Dial until the display indicates the rest number you wish to enter (91 through 122). Press ENTER.
5. Continue procedures 4 and 5 until the necessary number of rests and/or measures of rest have been entered.
6. Press STOP to return to the Stand By Mode.

Using the Rhythm Track as a Conductor Track

A Conductor Track enables you to enter time signature (meter) changes for each measure. The Conductor Track can be used with or without patterns actually written in the Rhythm Track. Creating a Conductor Track is accomplished by inserting measures that contain only time signature information into the Rhythm Track.

Writing the Conductor Track

Procedure for Programming the Rhythm Track for use as a Conductor Track

1. Go to the Stand By mode.
 2. Press the EDIT button.
 3. Select #3 (Insert), press ENTER.
 4. Rotate the Alpha wheel until Rhythm Track "R" appears in the display. Press ENTER.
 5. Select the starting measure for the new time signature, press ENTER.
 6. Select the number of measures. Press ENTER.
 7. Select the BPM (Beats Per Measure). Press ENTER.
 8. Select the note value. Press ENTER.
 9. If you would like to verify your changes, use the -> and <- keys to step through your commands. If you are satisfied that the information is correct, press the -> key until you see "Sure?>> Press Rec" in the display. If you decide not to insert, press STOP to return to the Stand By mode.
 10. Press the REC button to insert the new measures with this time signature.
 11. Repeat steps 2-10 until you have completed the conductor track.
 12. Press STOP to return to the Stand By mode.
- Note: This procedure can also be used to re-format the time signature of an existing song.

Procedure for Listening to the Conductor Track

1. Press the FUNC button.
2. Rotate the Alpha Dial until the display indicates "METRONOME" (FUNC 2). Press ENTER.
3. Rotate the Alpha Dial to select a quarter or eighth note value for the metronome. Press ENTER.
4. Rotate the Alpha Dial until the display indicates "REC&PLAY." Press ENTER.
5. Press STOP to return to the Stand By mode.
6. Press the PLAY button to hear the Conductor Rhythm Track.

**Chart of Individual Rests and Measures of Rest for R-PTN Numbers 91
Through 122**

R-PTN #	Rest Value	Relative Time Signature
91	16th note	1/16
92	8th note	1/8 or 2/16
93	8th + 16th	3/16
94	quarter	1/4 or 2/8
95	quarter + 16th	5/16
96	quarter + 8th	3/8
97	quarter + 8th + 16th	7/16
98	half note	2/4
99	half + 16th	9/16
100	half + 8th	5/8
101	half + 8th + 16th	11/16
102	half + quarter	3/4
103	half + quarter + 16th	13/16
104	half + quarter + 8th	7/8
105	half + quarter + 8th + 16th	15/16
106	whole note	4/4
107	whole + 16th	17/16
108	whole + 8th	9/8
109	whole + 8th + 16th	19/16
110	whole + quarter	5/4
111	whole + quarter + 16th	21/16
112	whole + quarter + 8th	11/8
113	whole + quarter + 8th + 16th	23/16
114	whole + half	6/4
115	whole + half + 16th	25/16
116	whole + half + 8th	13/8
117	whole + half + 8th + 16th	31/16
118	whole + half + quarter	7/4
119	whole + half + quarter + 16th	29/16
120	whole + half + quarter + 8th	15/8
121	whole + half + quarter + 8th + 16th	31/16
122	whole + whole	8/4

Section 12

Chain Play

Chain Play

Eight independent songs can be stored in the internal memory of the MRC-300. Chain Play allows you to arrange these eight songs in any order you wish. This is valuable in live performance applications where you may need to make rapid changes to the order of your songs.

Chain Play can also be used for organizing sections within a song. For example, the verse of your song could be loaded into song one, song two could be your chorus, song three could be your bridge, song four could be our turnaround, etc. By using chain play, you can arrange the sections of the song in any order that you choose and experiment with different arrangements.

Tempo

When using chain play, each song can have its own tempo. The tempo information must be programmed for each song before you enter the Chain Play mode. Once you have entered the chain play mode, the tempo cannot be changed.

Chain Play information cannot be stored into memory and will disappear after you leave the Chain Play mode.

Arranging Songs

Procedure for Arranging Songs Using Chain Play

1. Load several songs into the MC-300 from disk. (See instructions on "Loading Files from Disk")
2. Select the song number of the first song you would like to play. The name and number of the song will be displayed. Press ENTER.
3. Select the number of the first song section you would like to play. The name and number of the song will be displayed. Press ENTER.
4. Select the number of the next song section you would like to play. Press ENTER. This procedure can be repeated eight times.
5. After you have entered the last song number, press ENTER. Press Stop.

Playing Back a Chain

Procedure for Playing Back a Chain

Songs must already be arranged in Chain mode to perform this procedure.

1. To hear the chain played back, press PLAY. While the MC-300 is playing, the cursor will be under the current song number while the song title is displayed.
2. When the song chain is completed, the cursor will return to the first position in the chain and flash.
3. To return to Stand By mode, press the MODE button and ENTER. Once you press the MODE button, the chain play will disappear from memory. It is impossible to preserve the chain play sequence after you have left the chain play mode.

Note: The MC-300 can be started and stopped at any point while the song chain is being played. To stop the MC-300 in the middle of a song chain, press PAUSE. To restart from this point, press the PLAY button. While the MC-300 is stopped, the chain position can be selected by pressing the <- and -> keys. The song chain can be continued from this point by pressing PLAY.

If you wish to have the song chain repeat indefinitely, hold down the SHIFT button and press PLAY. The song sequence will loop until the STOP button is pressed.

Final note: It is possible to skip forward or backwards through the songs using the RESET and SKIP keys while the chain is playing.

Section #13

SYNCHRONIZING TO EXTERNAL DEVICES

Synchronizing to External Devices

MIDI has the ability to send and receive clock information within the data stream. When two devices are connected, one must be used as the master clock, and the other must be used as a slave. In MIDI, the master device is set to its own internal clock and the slave device is set to receive the external MIDI clock.

Procedure for Synchronizing an External Device to the MC-300 (MC-300 as the Master)

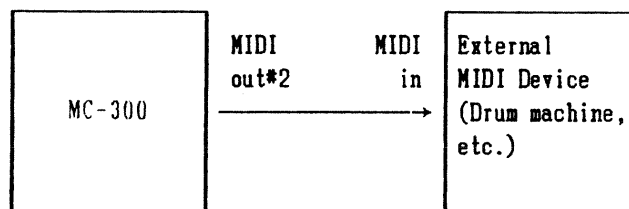

When using an external MIDI drum machine or sequencer it is usually best to keep the MC-300 as the master (internal) clock and set the drum machine or sequencer to be the slave device (MIDI clock). This way the MC-300 can control the tempo and start/stop of the slave instrument.

1. Go to the Stand By mode.
2. Press the FUNC button and press ENTER.
3. Use the Alpha Dial to select "Internal" clock.
4. Press STOP to return to the Stand By mode.
5. Press the MIDI button. Select #10 and press ENTER.
6. Use the Alpha Dial to turn the transmit clock on.
7. Press STOP to return to the Stand By mode.
8. Set the external device to the MIDI sync mode (check your Owner's Manual for this procedure). If your slave device cannot read MIDI clock, you may use an SBX-10 Sync Box to convert the MIDI clock to the necessary time base (clock).
9. The MC-300 will now start, stop, and control the tempo of the external instrument.

Procedure for Synchronizing the MC-300 to an External Device (MC-300 as the Slave)

To use the external device as the master and the MC-300 as the slave, connect the devices as in fig. 4-2.

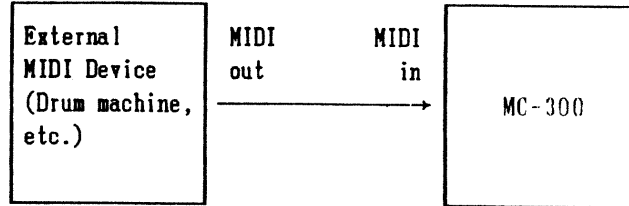

1. Go to the Stand By mode.
2. Select the internal clock mode on the external device.
3. Press the FUNC button and press ENTER.
4. Use the Alpha Dial to select the "MIDI" sync mode. If your device cannot send MIDI clock, you may use an SBX-10 Sync Box to convert the device's clock (sync) to MIDI clock).
5. Press the STOP button to return to the Stand-By mode.
6. Start the external device and the MC-300 will start playing in sync.

Procedure for Transferring Data from the TR-707/727 to the MC-300

Connect the MIDI Out of the 707/727 to the MIDI In of the MC-300.

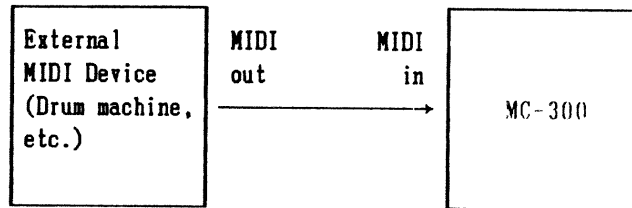

1. Go to the Stand By mode.
2. Press the FUNC button, press ENTER.
3. Use the Alpha Dial to select "MIDI" clock.
4. Press STOP to return to the Stand By mode.
5. Set the TR-707/727 to the internal clock mode.
6. Make sure the TR-707/727 is in the track play mode. Hold down the SHIFT, MIDI CHANNEL and INST/GUIDE buttons (in that order).
7. Press the REC button on the MC-300. Press the START button on the TR-707/727 (If you have completed step 6 correctly, the data will now transfer in real time. You will not hear the TR-707/727 play).

Transferring Data from the TR-505 and most other drum machines

Most other drum machines (TR-505, Yamaha RX series, etc.) transmit their data in real time and do not require any special commands.

Transferring Data to the MC-300 from an External Sequencer

It is possible to transfer recorded data into the MC-300 from another sequencer such as the Roland MSQ-700, MSQ-100, or a computer sequencing program. This is useful for organizing and managing data and to access the extensive editing capabilities of the MC-300.

The MC-300 can be used to organize all of your MIDI song data, regardless of the sequencer that was used for recording. The extensive memory capacity of the MC-300 (25,000 notes) allows it to store and recall large volumes of MIDI data very quickly. Data may be loaded into the eight song locations of the MC-300 and assigned names for easy reference. Once data has been transferred to the MC-300, it can be stored on a 3.5 inch floppy disk.

Data recorded on any MIDI sequencer can be transferred to the MC-300 to access its extensive editing capabilities. Any of the editing functions of the MRC-300 software (Microscope, Change MIDI Channel, Transpose, etc.) can be performed on data recorded on other MIDI sequencers.

The MC-300 records data from other sequencers in real time (only). You may use the "Punch In/Out" feature while transferring information. Punch In/Out allows you to choose which information you would like to record from the external sequencer while it is playing.

To record data into the MC-300 from another sequencer, use a standard MIDI cable to connect the MIDI Out of the sequencer to the MIDI In of the MC-300.

Diagrams w/ dedicated seq. & MPU-401 /software

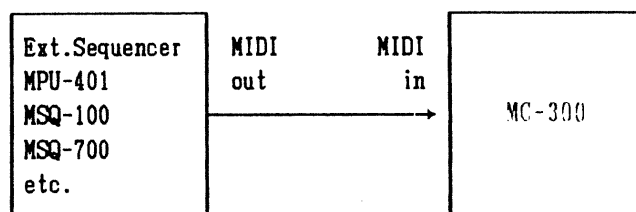

Procedure for Transferring Data from an External Sequencer/Computer to the MC-300

1. Go to the Stand By mode.
2. Press the FUNC button and then press ENTER. Rotate the Alpha Dial until "MIDI" flashes in the display.
3. Press STOP to re-enter the Stand By mode. The MC-300 will now be synchronized to the external device.
4. Press the <- key until the measure indicator flashes. Select the measure where you wish to begin recording.
5. Press the <- key until the song number flashes. Select a song number to store this new information. Songs can be loaded into any song numbers currently occupied or to the next available song number. For example, if songs 1-4 are currently occupied with data you may load data into song numbers 1,2,3, 4 or 5.

6. Press the -> key until the Record mode ("REAL or PUNCH") flashes in the display.



7. Press the -> key and choose the track (1,2,3, or 4) you wish to record to.
8. Press REC/LOAD.
9. If this is the first time you will be recording data into the song number you have selected, the MRC-300 will ask you to assign a time signature. To do this, select the beats per measure and press ENTER. Select the note value, press ENTER. The MC-300 will now display the message, "Start MIDI Clock".
10. Press PLAY on the external sequencer. The MC-300 will now begin recording. The clock of the external sequencer is now the master clock. Information will be loaded into the MC-300 in real time.
Note: Once the MC-300 is in MIDI clock mode, it can be started by using the external sequencer or by pressing PLAY. While the MC-300 is in MIDI clock mode, the external sequencer will always be the tempo controller. This will be true whether the MC-300 is started by its own PLAY button or by the external sequencer.

Song Position Pointer

Song Position Pointer is the MIDI measure number in a song. The MC-300 has the ability to send and receive MIDI song pointer information. When an external MIDI drum machine that has the capability to receive MIDI song pointer information is connected to the MC-300, the measures of the MC-300 and the drum machine will line up during recording and playback if the transmit clock on the MC-300 is turned on.

By using a device like the SBX-80 Sync Box, it is possible to sync the MC-300 to a SMPTE track on a video or audio tape. This type of control is invaluable when synchronizing your sequencers to a video tape.

Procedure for Using the SBX-80 with the MC-300

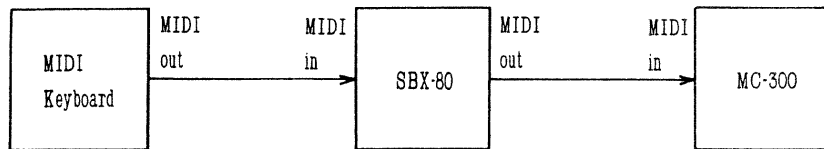

1. Go to the Stand-By mode.
2. Press the FUNC button and press ENTER.
3. Use the Alpha Dial to select MIDI clock.
4. Press STOP to return to the Stand By mode.
5. Program the song into the SBX-80 (see the SBX-80 Owner's Manual for instructions).
6. Record (Stripe) SMPTE on the video or audio tape.
7. Set the SBX-80 to the external SMPTE mode.
8. You may fast forward or rewind to any point on the tape. Press PLAY on the tape machine. The SBX-80 will follow the SMPTE on the tape and send the correct measure number (song pointer) to the MC-300. To record in sync with the tape, press the RECORD button.
Note: There is approximately one second between the time the MC-300 receives the song pointer (measure number) to the time it receives the MIDI start command. To record (real time or punch in/out only), press the REC button during this pause. If you do not press the REC button, the sequencer will automatically play in sync with the tape.

Internal Sync

Procedure for Returning to Internal Sync

This procedure will return the tempo control to the Internal clock of the MC-300.

1. Press the FUNC button.
2. Press ENTER, the clock mode will flash. Select "Internal" by using the Alpha Dial.
3. Press the STOP button to return to the Stand By mode. The tempo on the MC-300 can now be changed by rotating the Alpha Dial or using the Ten Key Pad. If you are using the Ten Key Pad, type in the tempo (10-250) and press ENTER.

Tape Sync

The tape sync function on the MC-300 allows you to synchronize the performance in the sequencer to an audio tape track. The advantage of syncing to tape is that you can use the MC-300 to synchronize sequenced parts to taped performances.

Tape sync can overcome the problem of not having enough tracks on a tape machine. For example, if you have a four track cassette recorder and have recorded vocal parts on three of the tracks, you have only one track available for the instrumental parts. By using this remaining track to record the sync tone, the tape sync function of the MC-300 can synchronize your sequenced MIDI instruments with the vocals. Since the MC-300 can play as many synthesizers as you have available, you can mix down the entire song (sequenced parts plus vocals) to a two track machine (digital or analog) or a cassette deck and get first generation sound quality.

FSK (Frequency Shift Key) is the tape sync code which is generated and read by the MC-300.

Note: Not all manufacturer's tape sync signals are the same, so a previously recorded sync signal on a tape may not be compatible with the MC-300.

Tips

For successful tape syncing:

1. Record the sync tone on an "edge" track such as track #1 or the last track on the tape machine.
2. Never use noise reduction (DBX, Dolby B, C, etc.) on your sync track.
3. Do not E.Q. the sync tone.
4. Do not record high frequency parts (cymbals, hi hat, etc.) or high transient parts (kick drum, slap bass, etc.) on the track adjacent to the sync tone.
5. Record the sync tone level at approximately -3dB on semi-pro recording equipment. On professional recording equipment, record the sync tone level at approximately -10dB.

Procedure for Syncing the MC-300 to Tape

1. Connect the Tape Sync Out on the rear panel of the MC-300 to the Input of the TapeTrack where you wish to record the sync tone.
2. Adjust the input level on the tape machine.

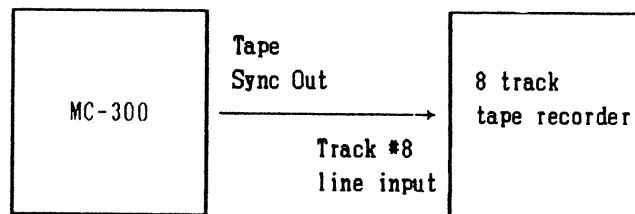

3. Set the tempo of the MC-300.
Note: This tempo cannot be changed once it is recorded on tape.
4. Record five seconds of the pilot tone on tape before pressing the PLAY button on the MC-300. The pilot tone is a continuous pitch generated by the MC-300. The MC-300 must recognize the pilot tone before it can read the modulated sync tone (FSK).
5. While the sync tone is being recorded, you may use the Alpha Dial or the Ten Key pad to change the tempo. However, these tempo changes will be permanently recorded on the sync track.
6. The MC-300 will stop when the song is completed. You are now ready to sync the MC-300 to the sync track.

7. Connect the output of the sync track to the Tape Sync In jack on the rear panel of the MC-300.

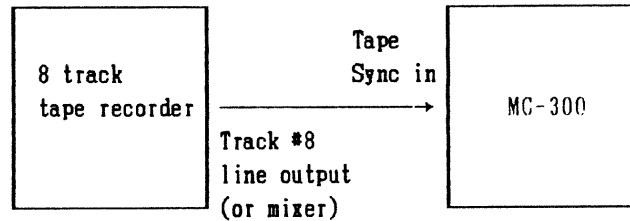

8. Press the FUNC button on the MC-300. Press ENTER.
9. Rotate the Alpha Dial to select "Tape" sync. Press STOP to return to the Stand By mode.
10. Rewind the tape to the beginning of the song . Play the tape. You may now playback or record data.
11. To record while syncing to tape, press the REC button on the MC-300. You can record in sync with a tape in "Real" time or "Punch" in/out mode. When the pilot tone begins on the tape, press the PLAY button on the MC-300. When the modulated tone (FSK) begins, the MC-300 will start.
12. To play the MC-300 synchronized to the sync track, press the PLAY button on the MC-300 when the pilot tone begins on the tape. When the modulated tone (FSK) begins, the MC-300 will start.

Note: Any tempo changes (accelerandos and ritards) recorded into the Tempo Track will be stored on the sync track when the sync tone is recorded. For more information on programming tempo changes, see the section on "Tempo Track."

Chapter #14

ERROR MESSAGES

Error Messages

When the display shows an error message, escape it as follows. Some error messages have numbers and some do not.

Error Number



```
Error ☆ ☆☆☆☆☆☆☆☆  
See owner's manual!
```

Error message numbers

Error Number 1

```
Error 1 RAM CHECK  
See owner's manual!
```

The MC-300's internal memory (RAM) has been damaged. Contact an authorized Roland service center.

Error Number 2

```
Error 2 ILLEGAL DISK  
See owner's manual!
```

The disk you have tried to use does not contain the MRC-300 system data. Remove the disk, insert an initialized disk, and press ENTER.

Error Number 3

```
Error 3 DISK I/O  
See owner's manual!
```

The MC-300 cannot load the disk program.

Replace the disk with an initialized disk, press ENTER. Do not use this disk anymore. There is a possibility that your song data remains on the disk. Take the Transfer procedure in the Mode 4 with an initialized disk.

*This error message is also shown when an uninitialized disk is inserted.

Error Number 4

```
Error 4 MEMOLY FULL  
Press STOP
```

The MC-300's internal memory is full.

Press STOP to return to the Stand By mode.

Error Number 5

```
Error 5 ILLEGAL OPEN  
See owner's manual!
```

The disk is not inserted

Insert the disk and press ENTER.

Error Number 6

```
Error 6 NOT READY  
See owner's manual!
```

This disk is not inserted

Insert the disk and press ENTER.

If you do not want to save the data, press STOP, and the MRC-300 will return to MODE 2.

Error Number 10

```
Error 10 ILLEGAL DISK  
Change Disk & STOP
```

The disk you have tried to use is not the right one for the MRC-300 system.

Insert the MRC-300 system disk, and press STOP.

Error Number 11

```
Error 11 PROTECTED  
Protect OFF & STOP
```

The Protect tab on the disk is set to the PROTECT position. Remove the disk, set the Protect Tab to WRITE, re-insert the disk and press STOP.

Error Number 12

```
Error12 DISK I/O  
See owner's manual!
```

The MC-300 cannot load the recorded data.

Replace the disk with an initialized disk and press STOP. Do not use the disk that causes this error message. There is a possibility that the data is retained. Try taking the Transfer procedure in the MODE 4 with an initialized disk.

*This error message is shown when an uninitialized disk is inserted. Replace it with an initialized disk.

Error Number 14

```
Error14 NOT JOB Disk  
Change Disk & STOP
```

If you change disks after selecting a song in the loading, deleting or renaming process, this error message appears in the Display.

Remove the disk and replace with the disk which was used in selecting the song, then press STOP.

Error Number 15

```
Error15 DISK FULL  
Change Disk & STOP
```

The memory of the disk is full.

Replace with an initialized disk that has sufficient space, then press ENTER.

Error Number 16

```
Error 16 CANNOT READ  
See owner's manual!
```

The MC-300 cannot load the recorded data.

Replace the disk with an initialized disk and press STOP. Do not use the disk that causes this error message. There is a possibility that the data is retained on the disk. Try taking the transfer procedure in the Mode 4 with an initialized disk.

Error Number 20

```
Error 20 ILLEGAL DISK  
Change Disk & ENTER
```

The disk is not compatible with the MC-300.

Replace the disk with an initialized and compatible disk, then press ENTER.

Error Number 21

```
Error 21 PROTECTED  
Protect OFF & ENTER
```

The Protect Tab on the disk is set to the PROTECT position.

Remove the disk, set the Protect Tab to the WRITE position, reinsert the disk and press ENTER.

Error Number 22

```
Error22 DISK I/O
See owner's manual!
```

The MC-300 cannot load the recorded data.

Replace the disk with an initialized disk and press STOP. Do not use the disk that causes this error message. There is a possibility that the data is retained on the disk. Try taking the Transfer procedure in the Mode 4 with an initialized disk.

*This error message is also shown when an uninitialized disk is inserted. Replace it with an initialized disk.

Error Number 23

```
Error23 NOT JOB DISK
Change Disk & ENTER
```

This error message is shown if you use an improper disk for the Back-up or Transfer procedure.

Change the disk with an appropriate one and press ENTER.

Error Number 24

```
Error24 DISK FULL
Change Disk & ENTER
```

The disk memory is full.

Replace with an initialized disk that has sufficient space, then press ENTER.

Error Messages
without numbers

Error Message shown during initialization or Back-up
procedure (1)

```
INIT to MRC Again?  
Yes: ENTER      No: STOP
```

This message tells you that the disk inserted in the MC-300 has already been initialized. Therefore, the disk may store some recorded data.

If you still wish to execute Initialization or Back-up, press ENTER. To cancel, press STOP.

Error Message shown during Initialization or Back-up
procedure (2)

```
Remake into MRC?  
Yes: ENTER      No: STOP
```

This message tells you that the disk connected to the MC-300 has been previously used with another device, such as a computer, wordprocessor, sampler, etc.

If you want to convert it to a MRC-300 disk, press ENTER. To cancel, press STOP.

Error Messages shown during Transfer Procedure (1)

```
RENEW? ▶☆☆☆☆☆☆☆☆☆☆  
Y e s : E N T E R      N o : S K I P
```

This indication is seen when the New Disk destination and the Source Disk (data giving disk) happen to have the same song names. On a disk, song names can only be used once.

Pressing ENTER will erase the song on the new disk, updating it with the data from the Source Disk. Pressing the SKIP button will transfer all data except that song from the Source Disk to the New Disk, retaining the song on the New Disk.

Error Messages shown during Transfer Procedure (2)

```
▶☆☆☆☆☆☆☆☆☆☆  
C A N N O T   R E A D   >>   S K I P
```

This indication tells you that the data to be transferred contains damaged data.

Pressing the SKIP button will transfer all data except the damaged song.

Error Messages shown during the Saving or Renaming Procedure.

```
RENEW? ▶☆☆☆☆☆☆☆☆☆☆  
Yes: ENTER      No: STOP
```

This message tells you that the same song name has already been used on the disk.

Pressing ENTER will erase the data on disk, replacing it with the new version in memory. If you wish to retain both songs, press STOP, then rename the data to be saved.

Error Messages shown during Loading, Renaming or Deleting (Disk)

```
SONG FILE NOT FOUND  
Change Disk & STOP
```

There is no song stored in the disk.

Change disks and press STOP.

Mother Keyboard/Rack Sound Module System

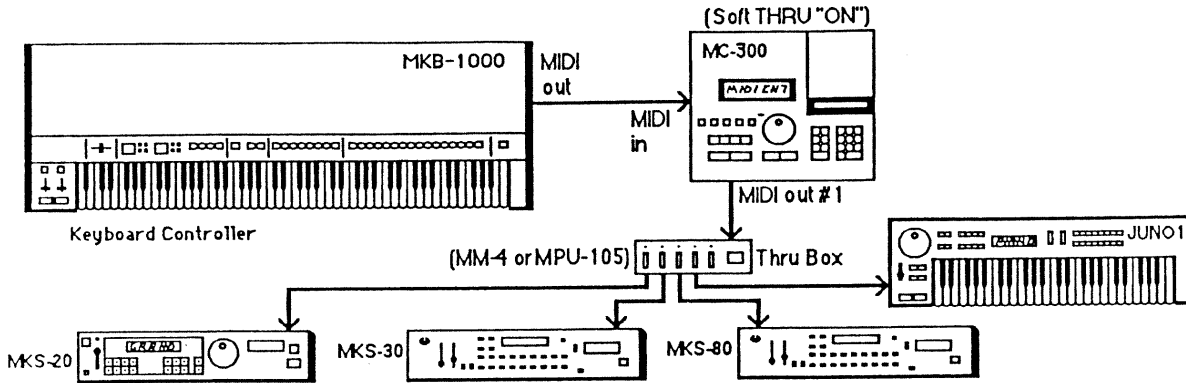

Note: Do not plug the output of the thru box or the MC-300 back into the Mother Keyboard or MIDI Feedback will occur.

Small MIDI Composing System

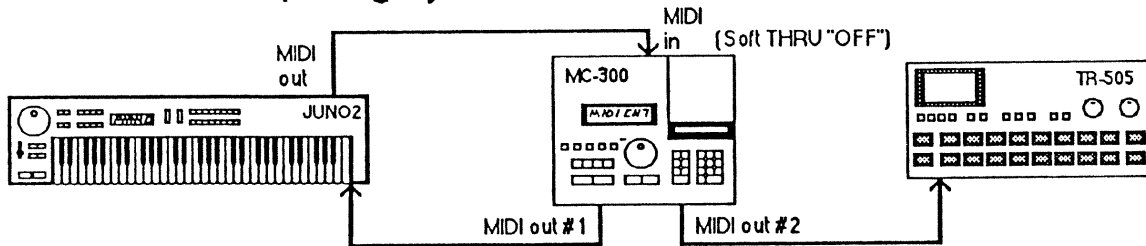

Large Studio System

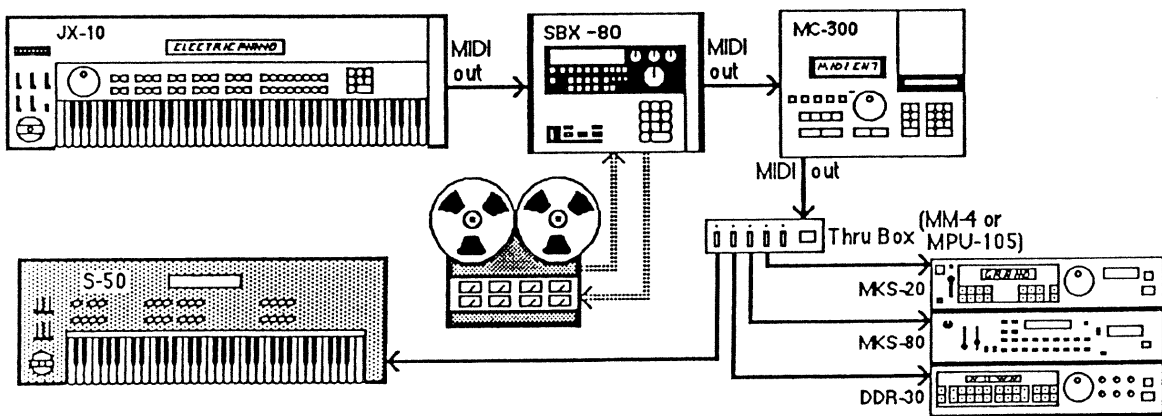

MIDI MICRO COMPOSER

MODEL MC-300 MIDI Implementation Chart

Function.....		Transmitted	Recognized	Remarks
Basic Channel	Default Changed	all ch ×	all ch 1-16 each	not BASIC ch
Mode	Default Messages Altered	Mode 3 OMNI OFF, POLY *****	× ×	**
Note Number	True voice	0-127 *****	0-127 0-127	
Velocity	Note ON Note OFF	○ × 9n v=0	○ ×	
After Touch	Key's Ch's	○ ○	* *	
Pitch Bender		○	*	
Control Change	0-63	○	*	
	64-121	○	*	
Prog Change	True #	○ *****	* 0-127	
System Exclusive		*	*	
System Common	Song Pos Song Sel Tune	* * ○	○ (SYNC CLOCK=MIDI) ○ (SYNC CLOCK=MIDI) ○	
System Real Time	Clock Commands	* *	○ (SYNC CLOCK=MIDI) ○ (SYNC CLOCK=MIDI)	
Aux Messages	Local ON OFF All Notes OFF Active Sense Reset	○ ○ (123) × ×	○ ○ (123-127) × ×	
Notes		* Can be set to ○ or × manually. ** When power is first applied, OMNI OFF, POLY ON are sent for all channels(1-16).		

Mode 1 : OMNI ON, POLY
Mode 3 : OMNI OFF, POLY

Mode 2 : OMNI ON, MONO
Mode 4 : OMNI OFF, MONO

○ : Yes
× : No

MIDI MICRO COMPOSER

MODEL MC-300 MIDI Implementation

1. RECOGNIZED RECEIVE DATA

1.1 Memorized messages while in RECORD mode

Status	Second	Third	Description	
1000 nnnn	0kkk kkkk	0vvv vvvv	Note OFF	#1
1001 nnnn	0kkk kkkk	0000 0000	Note OFF	
1001 nnnn	0kkk kkkk	0vvv vvvv	Note ON vvvvvvv = 1 - 127	
1010 nnnn	0kkk kkkk	0vvv vvvv	Polyphonic Key Pressure	#2
1011 nnnn	0ccc cccc	0vvv vvvv	Control Change	#2
1100 nnnn	0ppp pppp		Program Change	#2
1101 nnnn	0vvv vvvv		Channel Pressure	#2
1110 nnnn	0vvv vvvv	0vvv vvvv	Pitch Wheel Change	#2
1111 0000	...	1111 0111	Exclusive message	#2,3
1111 0110			Tune Request	

1.2 Recognized only

Status	Second	Third	Description	
1011 nnnn	0111 1011	0000 0000	ALL NOTES OFF	#4
1011 nnnn	0111 1100	0000 0000	OMNI OFF	#5
1011 nnnn	0111 1101	0000 0000	OMNI ON	#5
1011 nnnn	0111 1110	000m mmmm	MONO ON	#5
1011 nnnn	0111 1111	0000 0000	POLY ON	#5
1111 0010	0ppp pppp	0ppp pppp	Song Position Pointer	#6,7
1111 0011	0sss ssss		Song Select sssssss = 0-7 (SONG 1-8)	#6,7

1.3 Recognized messages for sync.

Status	Description	
1111 1000	Timing Clock	#7
1111 1010	Start	#7
1111 1011	Continue	#7
1111 1100	Stop	#7

notes : #1 Memorized as

1001 nnnn 0kkk kkkk 0000 0000.

#2 Memorized when corresponding function is set to ON.

#3 The message is ignored if the data byte count is over 300.

#4 When all notes are not OFF, this unit creates OFF's for those notes.

#5 Recognized as only an ALL NOTES OFF.

#6 Recognized while in STOP mode.

#7 When SYNC CLOCK is set at MIDI.

2. TRANSMITTED DATA

2.1 All memorized messages are transmitted on Playing.

2.2 All received messages are transmitted if SOFT THRU is ON.

2.3 Created messages

Status	Second	Third	Description	
1011 nnnn	0111 1011	0000 0000	ALL NOTES OFF	#1
1011 nnnn	0111 1100	0000 0000	OMNI OFF	#2
1011 nnnn	0111 1111	0000 0000	POLY ON	#2
1111 0010	0ppp pppp	0ppp pppp	Song Position Pointer	#3
1111 0011	0sss ssss		Song Select sssssss = 0-7 (SONG 1-8)	#3
1111 1000			Timing Clock	#3
1111 1010			Start	#3
1111 1011			Continue	#3
1111 1100			Stop	#3

notes : #1 When all notes turn to off.

#2 When power is first applied, these MODE MESSAGES are transmitted for all channels (1-16).

#3 When SYNC CLOCK is set at INTERNAL or TAPE.

 Roland

MIDI REAL TIME RECORDER

MRC-300

for MC-300

BASIC USERS/APPLICATIONS MANUAL



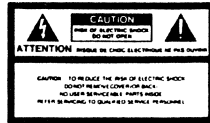

The lightning flash with arrowhead symbol, within an equilateral triangle, is intended to alert the user to the presence of un-insulated "dangerous voltage" within the product's enclosure that may be of sufficient magnitude to constitute a risk of electric shock to persons.

The exclamation point within an equilateral triangle is intended to alert the user to the presence of important operating and maintenance (servicing) instructions in the literature accompanying the product.

INSTRUCTIONS PERTAINING TO A RISK OF FIRE, ELECTRIC SHOCK OR INJURY TO PERSONS.

IMPORTANT SAFETY INSTRUCTIONS

WARNING When using electric products, basic precautions should always be followed, including the following:

1. Read all the instructions before using the product.
2. To reduce the risk of injury, close supervision is necessary when a product is used near children.
3. Do not use this product near water—for example, near a bathtub, washbowl, kitchen sink, in a wet basement, or near a swimming pool, or the like.
4. This product should be used only with a cart or stand that is recommended by the manufacturer.
5. This product, either alone or in combination with an amplifier and headphones or speakers, may be capable of producing sound levels that could cause permanent hearing loss. Do not operate for a long period of time at a high volume level or at level that is uncomfortable. If you experience any hearing loss or ringing in the ears, you should consult an audiologist.
6. The product should be located so that its location or position does not interfere with its proper ventilation.
7. The product should be located away from heat sources such as radiators, heat registers or other products that produce heat.
8. The product should avoid using in where it may be effected by dust.
9. The product should be connected to a power supply only of the type described in the operating instructions or as marked on the product.
10. The power-supply cord of the product should be unplugged from the outlet when left unused for a long time.
11. Do not tread on the power-supply cord.
12. Do not pull the cord but hold the plug when unplugging.
13. When setting up with any other instruments, the procedure should be followed in accordance with instruction manual.
14. Care should be taken so that objects do not fall and liquids are not spilled into the enclosure through openings.
15. The product should be serviced by qualified service personnel when:
 - A: The power-supply cord or the plug has been damaged, or
 - B: Objects have fallen, or liquid has been spilled into the product; or
 - C: The product has been exposed to rain; or
 - D: The product does not appear to operate normally or exhibits a marked change in performance; or
 - E: The product has been dropped, or the enclosure damaged.
16. Do not attempt to service the product beyond that described in the user-maintenance instructions. All other servicing should be referred to qualified service personnel.

SAVE THESE INSTRUCTIONS

WARNING

THIS APPARATUS MUST BE EARTH GROUNDED.

The three conductors of the mains lead attached to this apparatus are identified with color as shown in the table below, together with the matching terminal on the UK type power plug. When connecting the mains lead to a plug, be sure to connect each conductor to the correct terminal, as indicated.

"This instruction applies to the product for United Kingdom."

MAINS LEADS		PLUG
Conductor	Color	Mark on the matching terminal
Live	Brown	Red or letter L
Neutral	Blue	Black or letter N
Grounding	Green-Yellow	Green, Green-Yellow, letter E or symbol

Bescheinigung des Herstellers /Importeurs

Hiermit wird bescheinigt, daß der/die/das

ROLAND MICRO COMPOSER MC-300

(Gerät, Typ, Bezeichnung)

in Übereinstimmung mit den Bestimmungen der

Amtsbl. Vfg 1046 / 1984

(Amtsblattverfügung)

funk-entstört ist.

Der Deutschen Bundespost wurde das Inverkehrbringen dieses Gerätes angezeigt und die Berechtigung zur Überprüfung der Serie auf Einhaltung der Bestimmungen eingeräumt.

Roland Corporation Osaka / Japan

Name des Herstellers/Importeurs

RADIO AND TELEVISION INTERFERENCE

Warning — This equipment has been verified to comply with the limits for a Class B computing device, pursuant to Subpart J, of Part 15, of FCC rules. Operation with non-certified or non-verified equipment is likely to result in interference to radio and TV reception.

The equipment described in this manual generates and uses radio frequency energy. If it is not installed and used properly, that is, in strict accordance with our instructions, it may cause interference with radio and television reception.

This equipment has been tested and found to comply with the limits for a Class B computing device in accordance with the specifications in Subpart J, of Part 15, of FCC Rules. These rules are designed to provide reasonable protection against such interference in a residential installation.

However, there is no guarantee that the interference will not occur in a particular installation. If this equipment does cause interference to radio or television reception, which can be determined by turning the equipment on and off, the user is encouraged to try to correct the interference by the following measure:

- Disconnect other devices and their input/output cables one at a time. If the interference stops, it is caused by either the other device or its I/O cable.
- These devices usually require Roland designated shielded I/O cables. For Roland devices, you can obtain the proper shielded cable from your dealer. For non-Roland devices, contact the manufacturer or dealer for assistance.

If your equipment does cause interference to radio or television reception, you can try to correct the interference by using one or more of the following measures:

- Turn the TV or radio antenna until the interference stops.
- Move the equipment to one side or the other of the TV or radio.
- Move the equipment farther away from the TV or radio.
- Plug the equipment into an outlet that is on a different circuit than the TV or radio. (That is, make certain the equipment and the radio or television set are on circuits controlled by different circuit breakers or fuses.)
- Consider installing a rooftop television antenna with coaxial cable lead-in between the antenna and TV.

If necessary, you should consult your dealer or an experienced radio/television technician for additional suggestions. You may find helpful the following booklet prepared by the Federal Communications Commission:

"How to Identify and Resolve Radio-TV Interference Problems"
This booklet is available from the U.S. Government Printing Office, Washington, D.C. 20402, Stock No. 004-000-00345-4.

Please read the separate volume "MIDI", before reading this owner's manual.

Copyright © 1988 by ROLAND CORPORATION

All rights reserved. No part of this publication may be reproduced in any form without the written permission of ROLAND CORPORATION.

Panel Description

1. Front Panel

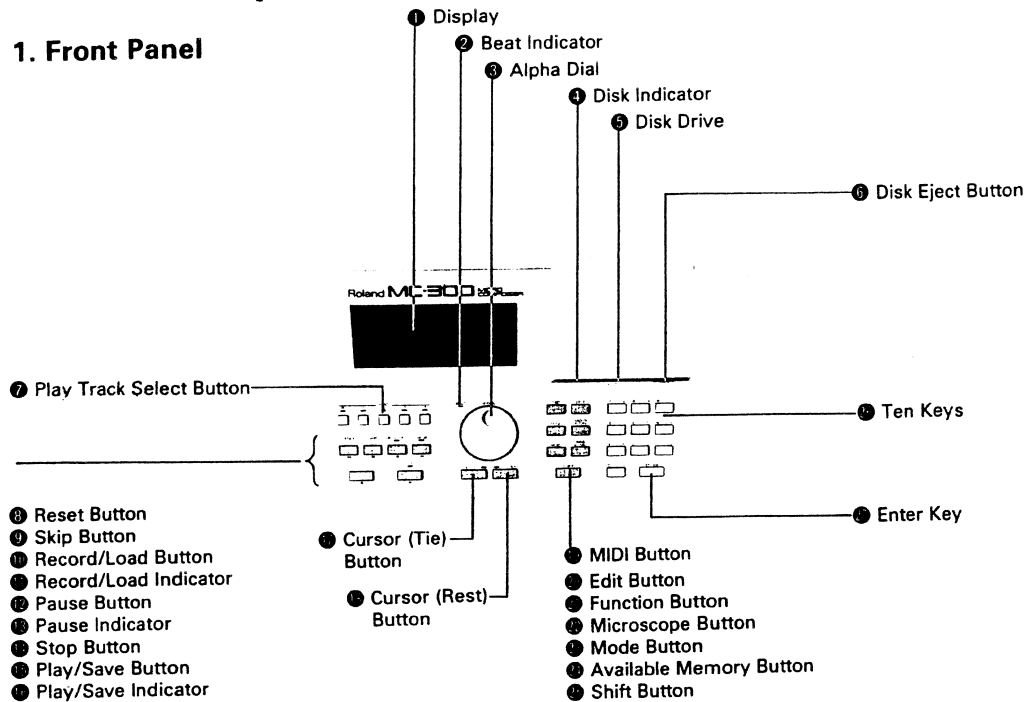

2. Rear Panel

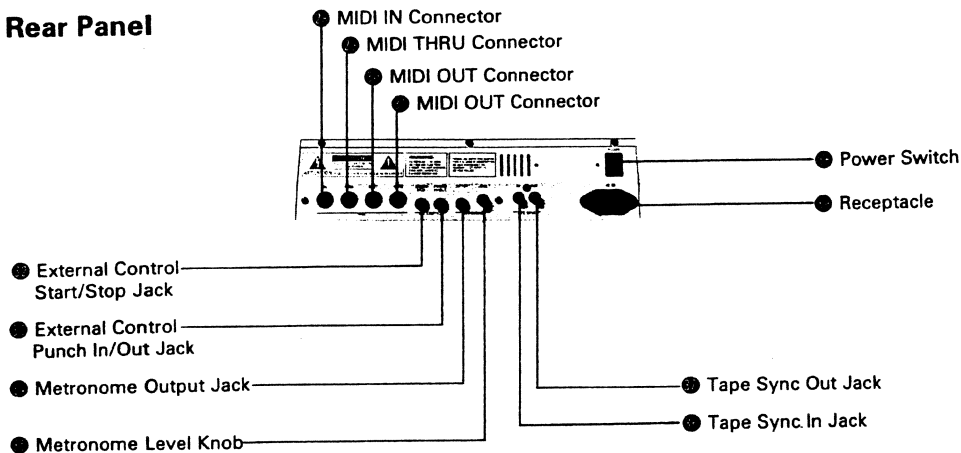

CONTENTS

1	System Floppy Disk Of The MC-300	7	3	Basic Course II	22
2	Basic Course I	9	1.	Display of the Available Memory	23
	1. Basic Operation	9	2.	Overdubbing	24
	2. Recording	10	3.	Punch-in Recording	26
	3. Playback	12	4.	Tempo Writing	27
	4. Saving	14	5.	Other Useful Functions	28
	5. Loading	16	6.	Review of the Basic Course (II)	29
	6. Initialization	18			
	7. Review of the Basic Course (I)	20			

The Software for the MRC-300 is a 3.5 inch micro floppy disk that turns the MC-300 into a high quality real time recorder. With the MRC-300 disk and MC-300, the following functions are possible.

FEATURES

- Large amounts of MIDI information can be quickly and accurately recorded.
- The memory capacity of the MC-300 is 25,000 notes of music data divided up into 8 songs with their titles.
- You can record up to four tracks of polyphonic MIDI information, program change messages, pitch bend messages, etc.
- Two methods for recording are provided: real time recording and step recording.
- You can punch-in and overdub on the existing music data while it is being played back.
- The data recorded in two individual tracks can be merged in one of the tracks.
- Any number of bars can be copied or deleted.
- The Microscopic editing function allows you to change the gate time and velocity.
- When playing back the recorded data, you can program and adjust the tempo, creating accelerando or ritardando.
- A built-in rhythm track is available for step programming external MIDI drum machines.
- The music data programmed on the MC-300 can be saved and loaded on the MRC-300 system floppy disk. The memory capacity of the MRC-300 is 100,000 notes which is approximately 100 songs.
- The Alpha Dial and the Ten Keys serve for quick operation, and the operation instructions which appear in the Display window aid in the operation of the MC-300.
- The MC-300 can synchronize to other MIDI instruments or tape recorders.

IMPORTANT NOTES

- The appropriate power supply for this unit is shown on its name plate. Please make sure that the line voltage in your country meets the requirement.
- Please do not use the same socket used for any noise generating device (such as motor, variable lighting system).
- This unit might not work properly if turned on immediately after turned off. If this happens, simply turn it off and turn it on again a few seconds later.
- Before setting up this unit with other devices, turn this unit all the other units off.
- This unit might be heated while operating, but there is no need to worry about it.
- Use a soft cloth and clean only with a mild detergent.
- Do not use solvents such as paint thinner.
- Avoid using this unit in excessive heat or humidity or where it may be affected by direct sunlight or dust.

Operating this unit near a neon, fluorescent lamp, TV or CRT Display may cause noise interference. If so, change the angle or the position of the unit.

The built-in disk drive of the MC-300 is a precision machine. So, please handle it gently.

CONNECTION

1. Setup with a Keyboard

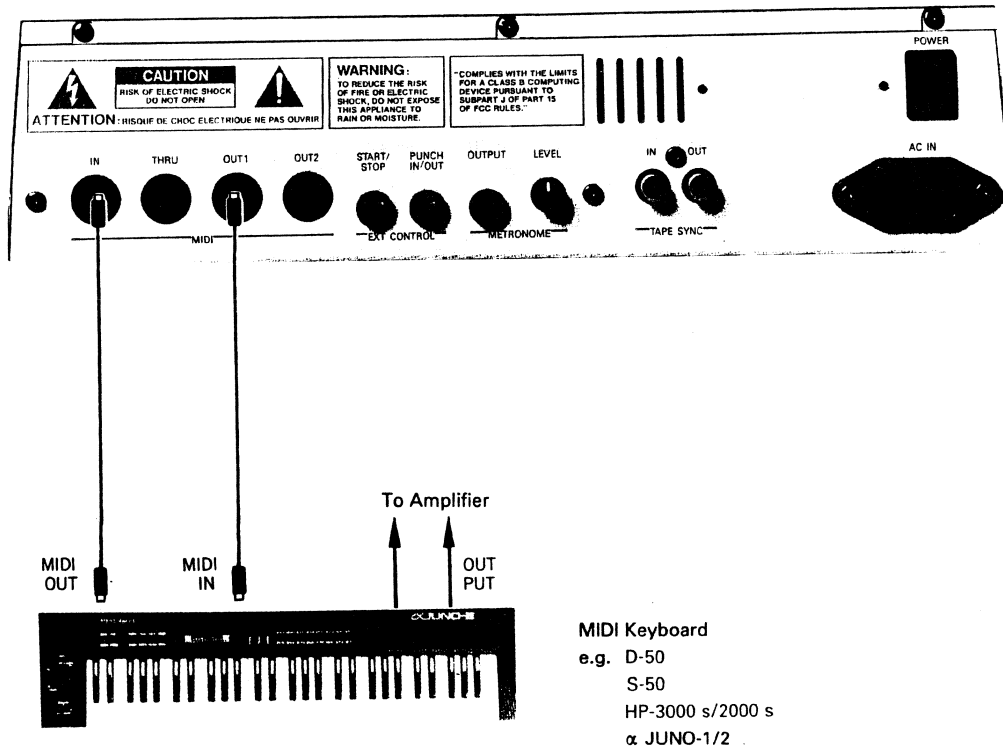

- * Before setting up the MC-300 to the keyboard, turn both units off.

2. Setup with MIDI Keyboard Controller and Sound Module

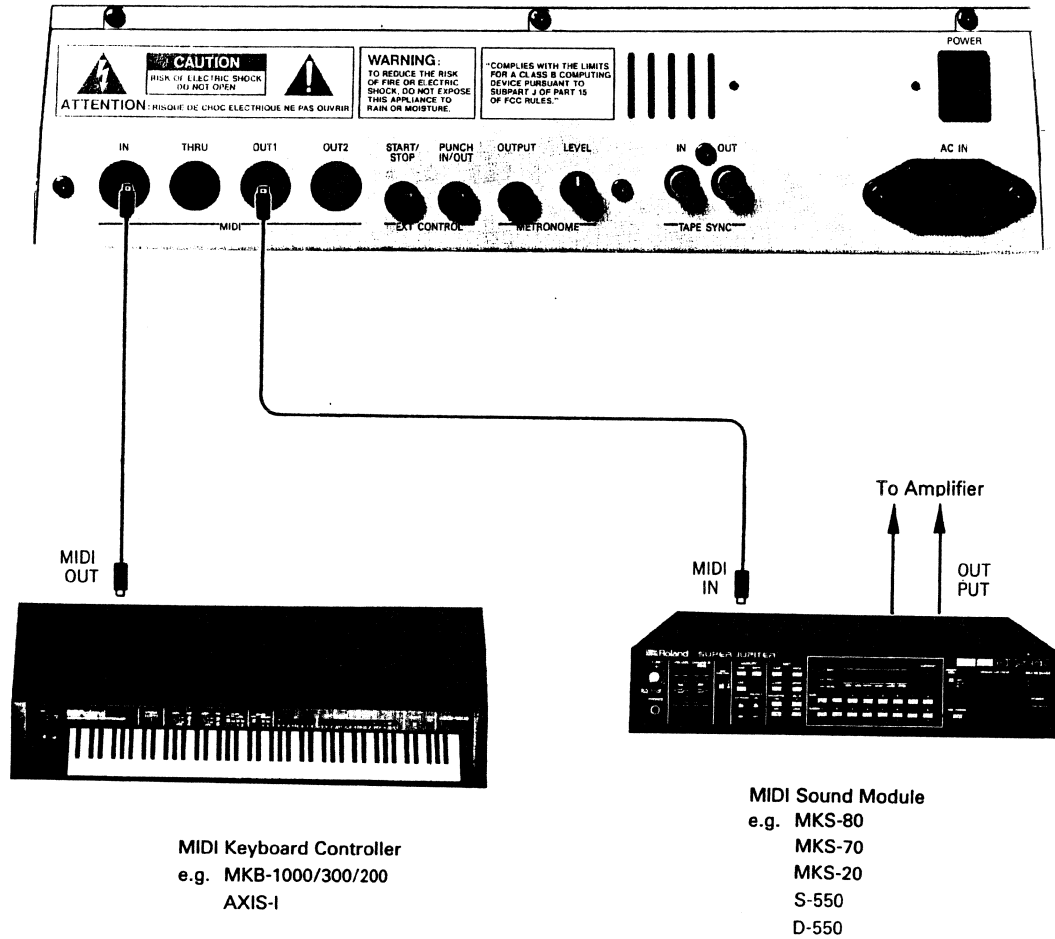

NOTE)

When setting up the keyboard controller and the sound module, be sure to follow SOFT THRU procedure (on page 10) every time after the Basic Operation (on page 9).

1 SYSTEM FLOPPY DISK OF THE MRC-300

The MC-300 does not function as a real time sequencer unless the MRC-300 system disk has been loaded into the MC-300. The MRC-300 system disk is also used for saving the recorded data.

The memory capacity of the floppy disk is not infinite (approx. 100,000 notes), so, if the disk in use becomes full, you need another MRC-300. System floppy disk of the MRC-300 has a self-duplicate function.

Before operating the MRC-300 system, please be sure to prepare at least one initialized disk. How to initialize a disk is shown on page 18.

This function is called initialization. (This is fully explained later in this manual.) You must save your song data on a disk which has already been initialized.

Floppy disks are delicate and can be ruined if not handled properly. Disks will also become erased naturally after a certain length of time. To ensure a long life for your data disks, be sure to follow the instructions.

Instructions on handling the floppy disks

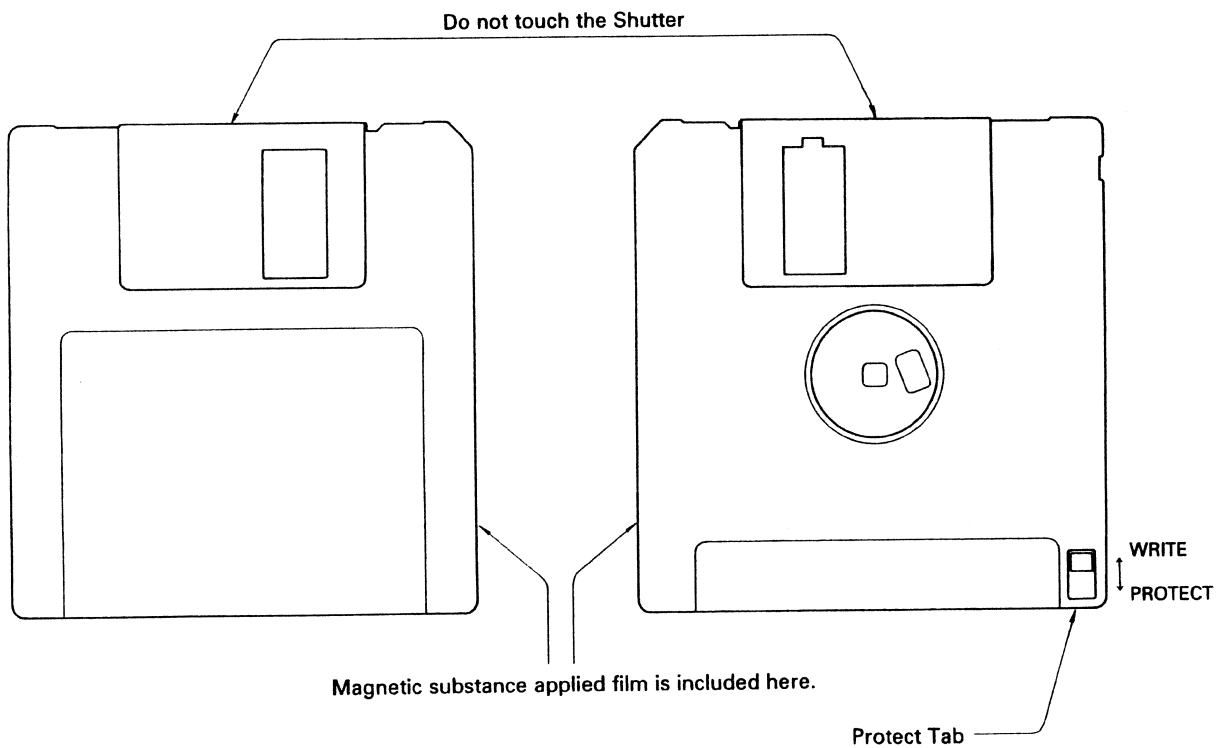

☆ To prevent accidental loss of data, be sure to set the Protect Tab to the PROTECT position except when writing (recording) data.

Please do not touch the shutter of the disk.

Do not use the disk where it may be affected by dust.

Do not use the disk near anything magnetic such as headphones or speakers.

Keep disks away from extremely hot and cold temperatures.

To avoid accidental loss of data, be sure to set the Protect Tab on the disk to the PROTECT position.

Never remove or insert the disk, or switch the MC-300 off while the indicator of the disk drive is lighted, or the disk may be erased.

The MC-300's internal memory cannot read the data recorded on the invalid disk. So we recommend that you should make a few copies of your important data.

The marks \triangle ☆ and ★ shown in this manual means as follows in the actual Display.

\triangle : Flashing number, letter or sign.

☆ : Lighted number, letter or sign

★ : Set number, letter or sign

When the Display responds with a different indication from explained in this manual, refer to "Error Messages" in the separate manual "Advanced Course".

2 BASIC COURSE I

This course covers the basic operation of the MRC-300 system.

1. BASIC OPERATION

The following explains how to turn the MC-300 into a real time sequencer.

Make sure that the MC-300 is properly setup with other devices.

- ① Turn on all devices connected to the MC-300.
- ② Switch the MC-300 on.

```
R o l a n d   M C - 3 0 0
```

- * The metronome will play and the Display will change to as shown below.

```
I n s e r t   S y s t e m   D i s k  
a n d   P r e s s   E N T E R
```

- ③ Insert the MRC-300 system disk into the disk drive as shown below.

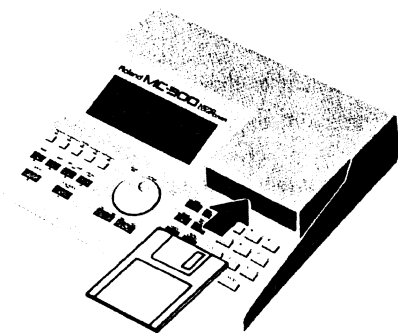

Make sure the Protect Tab is set to the PROTECT position
Insert the disk with the right side (where the letters MF-2DD are seen) facing upward and the shutter forward.

- ④ Hit **ENTER**

```
L o a d i n g   S y s t e m  
P l e a s e   W a i t
```

Now, the MC-300 is reading the system program that turns it into a real time recorder.

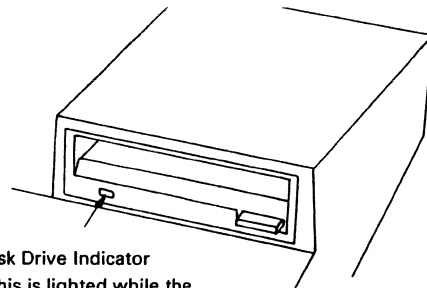

Disk Drive Indicator
(This is lighted while the
Disk Drive is working.)

When the disk drive is running, the indicator is lit. Never remove or insert the disk while the indicator light is on, or the floppy disk may become corrupted.

The Display will respond with:

```
M R C - 3 0 0   V e r   1 . 0 0  
C o p y r i g h t   R o l a n d
```

After about 30 seconds, the MC-300 is ready for recording or playing.

(Stand By Mode)

```
S O N G   1  
M E A S   1   J = 1 2 0   R E A L   1
```

The Beat Indicator is flashing.

In this manual, we call this "Stand By Mode" of the MRC-300 system.

When Setting up Keyboard Controller and Sound Module

When setting up a keyboard controller with a sound module, you need to connect the MIDI OUT of the controller to the MIDI IN of the sound module. Usually, in the MRC-300 system, the signal fed into the MIDI IN cannot be sent to the MIDI OUT. So, it is necessary to open the MIDI IN through MIDI OUT (we call it SOFT THRU procedure).

Otherwise, the sound module cannot be operated by the signal fed from the keyboard.

- * When using a synthesizer, do not take SOFT THRU procedure with the synthesizer turned to LOCAL ON. Otherwise, the system may not function properly.

SOFT THRU Procedure

- ① Push **[MIDI]**, **[1]** and **[2]** of the Ten Keys, then **[ENTER]**.

```
MIDI 1 2   S o f t   T H R U
OUT 1 :   O F F , O U T 2 :   O F F
```

↑
Flashing

- ② Push **[1]**, then **[ENTER]**.

Flashing
↓

```
MIDI 1 2   S o f t   T H R U
OUT 1 :   O N , O U T 2 :   O N
```

- ③ Push **[STOP]**.

```
S O N G   1
M E A S   1   J = 1 2 0   R E A L   1
```

↑
Flashing

Now, you can go to the recording procedure.

Please take the SOFT THRU procedure every time after "1. Basic Operation" on page 9.

2. RECORDING

The MRC-300 system features four tracks that work just like tracks of a multitrack recorder.

You can record the data of all the MIDI channels in a track.

Before you start recording, set the tempo of the music you are about to record.

• How to set the tempo

When the MC-300 is switched on, the Display responds with:

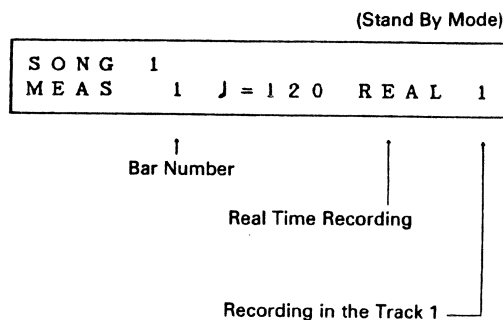

The flashing number shows the tempo. This can be changed with the Alpha Dial or the Ten Keys.

- * The number represents how many quarter notes (beats) are played within a minute(BPM).

Pushing **[←]** or **[→]** moves the flashing positions. The flashing number (red) can always be changed with the Alpha Dial or Ten Key Pad just like the tempo. When the unit is returned to the Stand-by mode, the flashing point goes back of the tempo position.

- While holding the **PAUSE** Button, push the **REC** Button.

The indicator of the **REC** Button flashes and the indicator of the **PAUSE** lights up.

The Display responds with:

Flashing
(Time Signature Setting)

```

T I M E   S I G N   4 / 4   ?
M E A S   1   J = 1 2 0   R E A L   1
  
```

Whenever you record from the new bar, the above indication will be seen in the Display.

- Set the BPM you like as shown below using the Ten Keys and the **ENTER**.



Flashing

```

T I M E   S I G N   4 / 4   ?
M E A S   1   J = 1 2 0   R E A L   1
  
```

Push **6**.

Push **ENTER**.



Flashing

```

T I M E   S I G N   6 / 4   ?
M E A S   1   J = 1 2 0   R E A L   1
  
```

Push **8**

"8" and "+" flash alternately

```

T I M E   S I G N   6 / 8   ?
M E A S   1   J = 1 2 0   R E A L   1
  
```

Push **ENTER**

```

K e y   o n   s t a r t
M E A S   1   J = 1 2 0   R E A L   1
  
```

Now, the metronome will be heard.

- Set the tempo you like with the Alpha Dial.

- Play the MIDI instrument (Keyboard, Octapad, etc.)

What you play on the keyboard will be faithfully recorded.

- When you finish playing, push the **STOP** button.

The metronome stops in the end of the bar, and the recording stops.

(Stand By Mode)

```

S O N G   1
M E A S   ☆ ☆ ☆   J = △ △ △   R E A L   1
  
```

↑

Bar Number

The number shown in the Display is the number of the next bar.

The indicators of the RHYTHM and the PLAY TRACK 1 buttons light up, showing that what you have played is recorded into the Track 1. In the Rhythm track, rests are automatically recorded.

- The volume of the metronome can be changed with the knob on the back panel of the MC-300.
- If you want louder metronome sounds using an amplifier and speakers, connect the amplifier to the jack on the back panel of the MC-300.
- Up to 999 (or 4096 quarter notes) bars can be recorded into the MC-300.

3. PLAYBACK

The recorded sequencer data can be played on the MIDI instrument connected to the MC-300.

a. BASIC PLAY BACK

When the recording is completed, the Display shows as below.

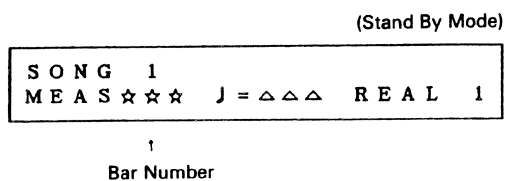

Now, the recorded data can be played back as follows.

- ① Push  (Reset) button.

The Display shows "1". This means that the bar number is returned to 1. The  (Reset) button has the functions of stopping playback or recording, and of setting to the beginning bar. (On Stand-by Mode, it has only the function of setting to the beginning bar.)

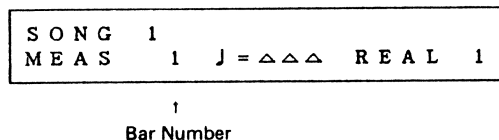

- ② Push the  button.

The indicator of the  button lights up, and the data will be played back.

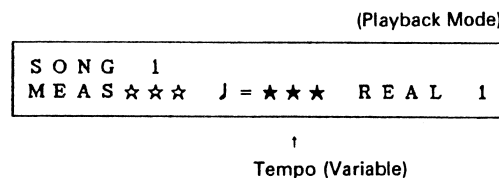



During playback, the tempo can be changed with the Alpha Dial.

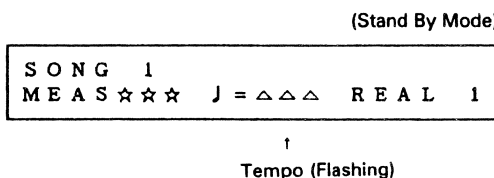

When all the data is played back, the indicator of the  button goes out and the MC-300 stops.

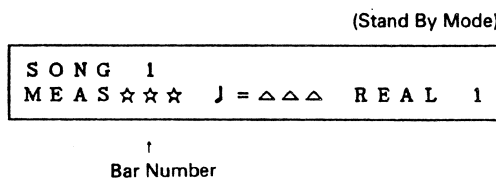



To stop playing data before it is finished, push the  button, and the MC-300 stops playing at the end of the bar.



Now, pushing the  button will continue to play from the bar shown in the Display.

If you wish to stop playing the data before it is played up, and go back to the first bar at the same time, push the  button instead of  button. The MC-300 immediately stops and will be reset.

- If you wish to repeat playing, instead of step ②, press the  while holding the  down.

b. PAUSE

If you wish to stop playing the data immediately without it being played up to the end of the bar, push the **PAUSE** button instead of **STOP**. In this way, the data stops playing at once instead of played up to the end of the bar. Pushing the **PLAY** button will continue to play the data from where it is stopped.

- * When the MC-300 is a master device to which an external MIDI device is syncing to (see page 46 in "Advanced Course"), pushing **PAUSE**, **STOP**, then **PLAY/SAVE** may spoil the sync.

c. START/STOP WITH THE PEDAL SWITCH

Instead of using the **PLAY** and **STOP** buttons, you can use the pedal switch DP-2 (optional) for starting or stopping the MRC-300 system.

Rear Panel

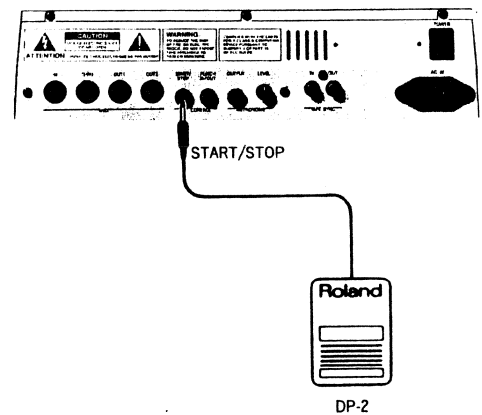

Push the pedal to start, and push it again to stop.

4. SAVING

The recorded data in the MC-300's memory can be saved onto the MRC-300 system floppy disk. The memory capacity of the MRC-300 system floppy disk is approximately 100,000 notes which is about 100 songs. In this manual, we call the operation for writing a title on a song "Naming". One song can be saved on to a MRC-300 disk at a time.

PROCEDURE

First of all, set the MRC-300 system to the Stand By Mode.

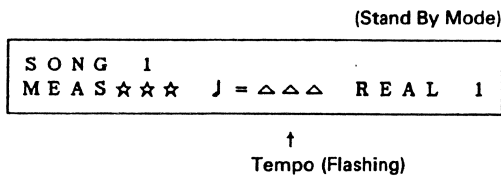

- ① Push **MODE**, then **2**.

The Display will change, showing that it is now in the Disk mode.

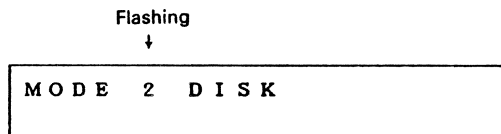

- ② Hit **ENTER**.

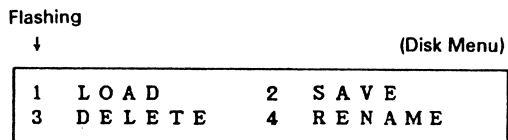

- ③ Type **2**.

The number "2" (SAVE) flashes.

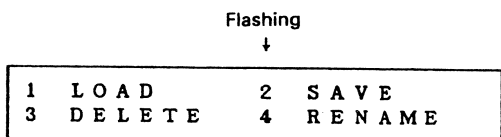

Data Contents of a Song (Tune)

- Phrase Track (X4)
- Rhythm Track
- Rhythm Patterns
- Tempo Track
- Functions (All)

- ④ Hit **ENTER**.

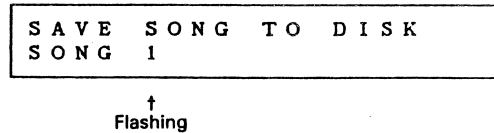

#1 flashing will indicate you are about to save song 1 to disk.

- ⑤ Hit **ENTER**.

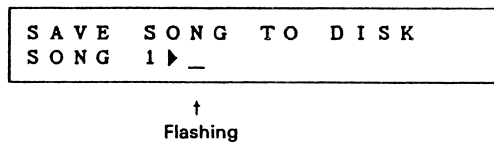

Now, you can go to the Naming procedure. The flashing bar in the Display is the cursor which is effectively used for the naming operation.

- ⑥ Rotate the Alpha Dial until the Display shows the alphabet, number or the sign you want.

The alphabets, numbers and the signs are programmed in the series as shown on the next page.

- Do not make a space at the beginning of the song name.
- ⑦ By pressing the **→** button that moves the cursor to the right, you can move to the next position.

Repeating the above procedure, complete the naming. Up to 13 letters are available for naming. The Ten Keys cannot be used in the naming operation. If you make a mistake, go back to the relevant letter using the **←** button that moves the cursor leftward, and correct it with the Alpha Dial.

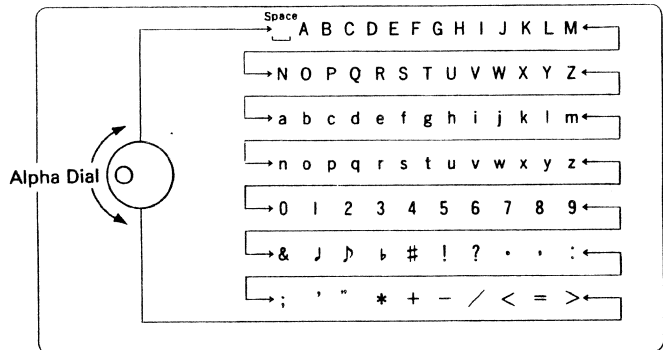

* If the first letter of a name is a space, the name cannot be saved.

⑧ When you have finished naming, hit **ENTER**.

```
SONG 1 ▶★★★★★★★★★★★
Sure? >> Press SAVE
```

To correct the title you have written at this stage, push **STOP** to return to the step ⑧.

⑨ Make sure that the indicator of the disk drive is not lit, push the Eject Button which is located at the far-right of the indicator, and remove the disk.

⑩ Set the Protect Tab on the disk to the WRITE position, and re-insert the disk.

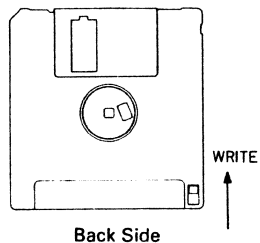

⑪ Push **PLAY**.

The indicators of the **PLAY** button and the disk drive indicator will light up. Please do not remove the disk until the indicator goes out.

The Display shows as below.

```
SONG 1 ▶★★★★★★★★★★★
Saving Please Wait
```

When the saving is completed, metronome is heard and the Display changes to Disk Menu.

Now, the recorded data is saved on the disk.

⑫ Take the disk out, and return the Protect Tab to the PROTECT position.

To return to the Stand By Mode, push **MODE** **I**, then **ENTER**.

(Stand By Mode)

```
SONG 1 ★★★★★★★★★★★★
MEAS 1 J = △△△ REAL 1
```

The song title you have written in saving will also be shown.

Before you turn the MC-300 off, make sure that the indicator of the disk drive is dark and take the disk out.

Please be sure to turn the MC-300 on or off WITHOUT THE DISK CONNECTED.

* The same song title as already written on the same disk cannot be saved. (See page 72 in "Advanced Course".)

5. LOADING

The data saved on the disk can be loaded back to the MC-300 at any time you like.

PROCEDURE

First of all, turn the MC-300 to the Stand By Mode of the MRC-300 system.

Loading (Stand By Mode)

```
SONG ☆☆☆☆☆☆☆☆☆☆
MEAS☆☆☆ J = △△△ REAL 1
```

- ① Push **MODE** then **2**.

The Display will change to as below showing that the MC-300 is now in the Disk mode.

Flashing
↓
MODE 2 DISK

- ② Hit **ENTER**.

Flashing
↓ (Disk Menu)

```
1 LOAD      2 SAVE
3 DELETE   4 RENAME
```

Make sure that "1" (LOAD) flashes.

- ③ Hit **ENTER**.

```
LOAD SONG FROM DISK
SONG △
```

The flashing number in the Display represents the song number. The MRC-300 system can store up to 8 songs in the MC-300's internal memory. The lowest number is always called first.

When any data is stored in the MC-300's internal memory, the next available song number will automatically be called and shown in the Display. In this way, the song number which already has MIDI data stored in it will not be erased.

When all eight songs have been used, there is no song number displayed. In this case, you must choose a song number which is to be erased to make space for the new song. To do this, you can rotate the Alpha Dial or use the Ten Keys.

- ④ Hit **ENTER**.

```
LOAD SONG FROM DISK
SONG ☆☆☆☆☆☆☆☆☆☆
```

↑
Song Title

A song title stored in the disk will be shown in the Display.

- ⑤ Using the Alpha Dial, select the song which you wish to load into the MC-300's internal memory.

- ⑥ Hit **ENTER**.

```
SONG ☆☆☆☆☆☆☆☆☆☆
Sure? >> Press LOAD
```

⑦ Push **REC LOAD** button.

The indicators of the **REC LOAD** button and the disk drive light up. Do not remove the disk now.

The Display changes to as shown below.

```
SONG ★◀★★★★★★★★★★
Loading Please Wait
```

When loading is completed, the metronome is heard and the Display returns to the Disk Menu.

Now the loading is completed.

To return to Stand By Mode of the MRC-300 system, push **MODE**, **I**, then **ENTER**.

(Stand By Mode)

```
SONG ★★★★★★★★★★★
MEAS 1 J = ΔΔΔ REAL 1
```

The loaded song title is also shown in the Display.

SEARCHING A SONG TITLE FROM MORE THAN ONE DISK

When you are looking for a song and you do not remember which disk it is saved to. Follow this procedure.

When you cannot find the song you want in disk in the step ⑥, check if the indicator of the disk drive is dark then replace the disk with the one on which the song may be saved.

When you remove the disk, the Display will show the error message, but it will disappear when the other disk is connected. Hit **ENTER**, and the song titles on that disk can be ready to be called in sequence. Search for the song you want by following steps ⑥ to ⑦.

6. INITIALIZATION

A brand new floppy disk does not function properly unless it is initialized. Initialization involves copying the MRC-300 system disk that contains the program necessary for driving the MC-300 as a real time sequencer. This floppy disk also is a storage for the sequencer data. You must preserve one copy of the system disk in case that the whole data on the system disk is accidentally erased.

One floppy disk may not be able to store the entire song data. So, it is a good idea to initialize a disk before the remaining memory becomes less than 25%. (See page 23 in "Display of the Available Memory".)

Initialization (copying the system disk) will erase the data currently retained in the MC-300's internal memory. If you wish to retain the data, save the data onto a floppy disk (which has been already initialized) before copying the system disk.

A 3.5 inch floppy disk is supplied with the MC-300. First, try initializing this disk. You may purchase additional 3.5 inch floppy disks from an authorized Roland dealer, or you may a high-quality MF-2DD disk as an alternative.

Initialization involves only loading the MRC-300 system program. In other words, initialization does not copy the sequencer data saved on the disk.

How to initialize your brand new disk

First of all, return to the Stand By Mode.

(Stand By Mode)

```
SONG ☆☆☆☆☆☆☆☆☆☆
MEAS☆☆☆ J = △△△ REAL 1
```

① Push **MODE**, then **4**.

Flashing

↓

```
MODE 4 UTILITY
```

② Hit **ENTER**

```
Clear RAM & Load M4
Sure? >> Press LOAD
```

If there is any data recorded in the MC-300, next procedure will erase it. The Display asks you if you do not mind erasing it. To cancel this mode, push **STOP** then **ENTER**.

③ Push **1**.

```
Loading UTILITY
Please Wait
```

Now, the MC-300 is reading the system program necessary for the next operation.

Flashing

↓

```
1 INIT          2 BACK UP
3 XFER          4 RESTART
```

The functions (1 to 4) available in this mode are shown in the Display. 1 (initialization) flashes.

- ④ To enter the INIT (initialization) mode, push **[1]**, then **[ENTER]**.

```
Insert System Disk
and Press ENTER
```

- ⑤ Make sure that the MRC-300 system disk is connected, and hit **[ENTER]**.

```
Loading INIT System
Please Wait
```

Now, the MC-300 is reading the system program necessary for initialization. For about 25 seconds, the Play Track Buttons will light up from R to 4, all the five buttons lighted after all. With this, you can see how far the program has been read from the disk. When the loading is completed, the metronome will sound.

```
Insert New Disk
and Press ENTER
```

- ⑥ Making sure that the indicator of the disk drive is dark, push the Eject Button located at the far-right of the indicator, and take the disk out. Connect the disk (MF-2DD) to be initialized of the disk drive with its Protect Tab set to WRITE.

- ⑦ Hit **[ENTER]**.

```
Initializing Disk
Please Wait
```

Now, the disk is being initialized. It takes about 2 minutes for initialization, and during this, the number shown at the lower right of the Display will count-up from 0 to 159. Then the Play Track Buttons go out from 4 to R, all five gone out when the process is finished. This helps you know how far the initialization has been executed.

When the initialization is completed, the metronome beep will sound.

```
INIT Complete! Cont?
Yes: ENTER      No: STOP
```

If you wish to continue to initialize some more disks, hit **[ENTER]** and go back to the step ⑥.

- ⑧ When you have finished initialization, push **[STOP]**.

Flashing
↓

```
1  INIT      2  BACK UP
3  XFER      4  RESTART
```

- ⑨ Take out the disk, set the Protect Tab to PROTECT, then replace it in the disk drive.

- ⑩ Push **[4]**, then **[ENTER]** to select RESTART.

The Display changes three times, then goes back to the Stand By Mode.

(Stand By Mode)

```
SONG 1
MEAS 1 J = 120 REAL 1
```

Now, you have completed making copies of the MRC-300 system disk.

NOTE)

When setting up the keyboard controller and the sound module, be sure to follow SOFT THRU procedure (on page 10) every time after the Basic Operation (on page 9).

7. REVIEW OF THE BASIC COURSE (I)

a. STAND BY MODE OF THE MRC-300 SYSTEM

When the Display shows as below, the MRC-300 system is in the Stand By Mode. In the basic course, all recording, playing, saving and loading functions start from the Stand By Mode, then after these functions have been executed, the system goes back to the Stand By Mode again.

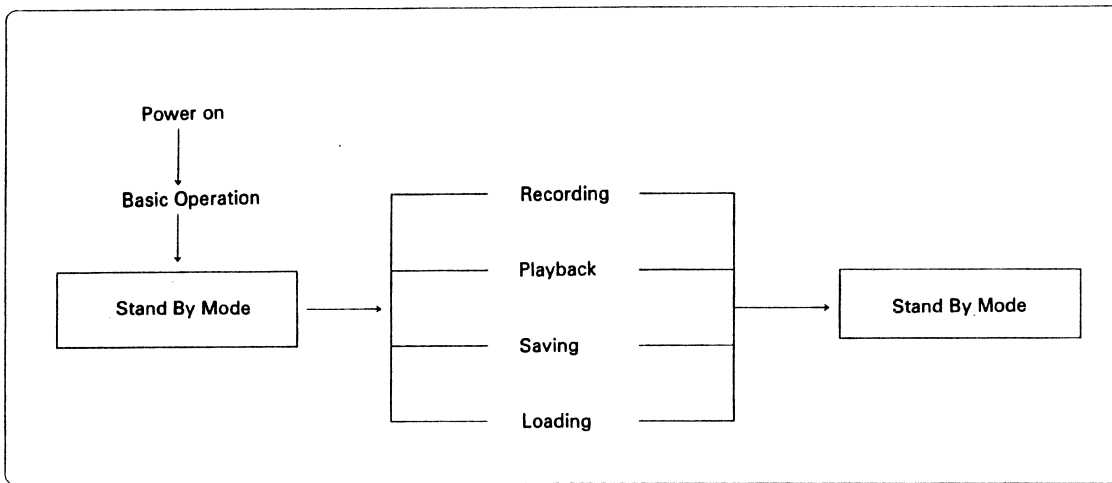

Review

During recording or playing, pushing the **STOP** button will enter the Stand By Mode.

Stand By Mode

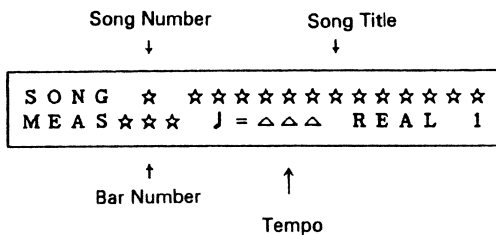

DISPLAY

● Song Number

Up to 8 songs (1 to 8) can be stored in the MC-300's internal memory.

If the memory becomes full, no more songs can be written.

● Song Title

You can write a different song title to each song.

● Measure Number

When you stop playing back the data on the MC-300, the Display shows you a bar number. When you push the **PLAY** button, the data will play from this bar.

You can call up any measure using the Alpha Dial or the Ten Keys. (See P22)

● Tempo

The number shown in the Display is how many quarter notes are played within a minute.

b. PROCEDURE

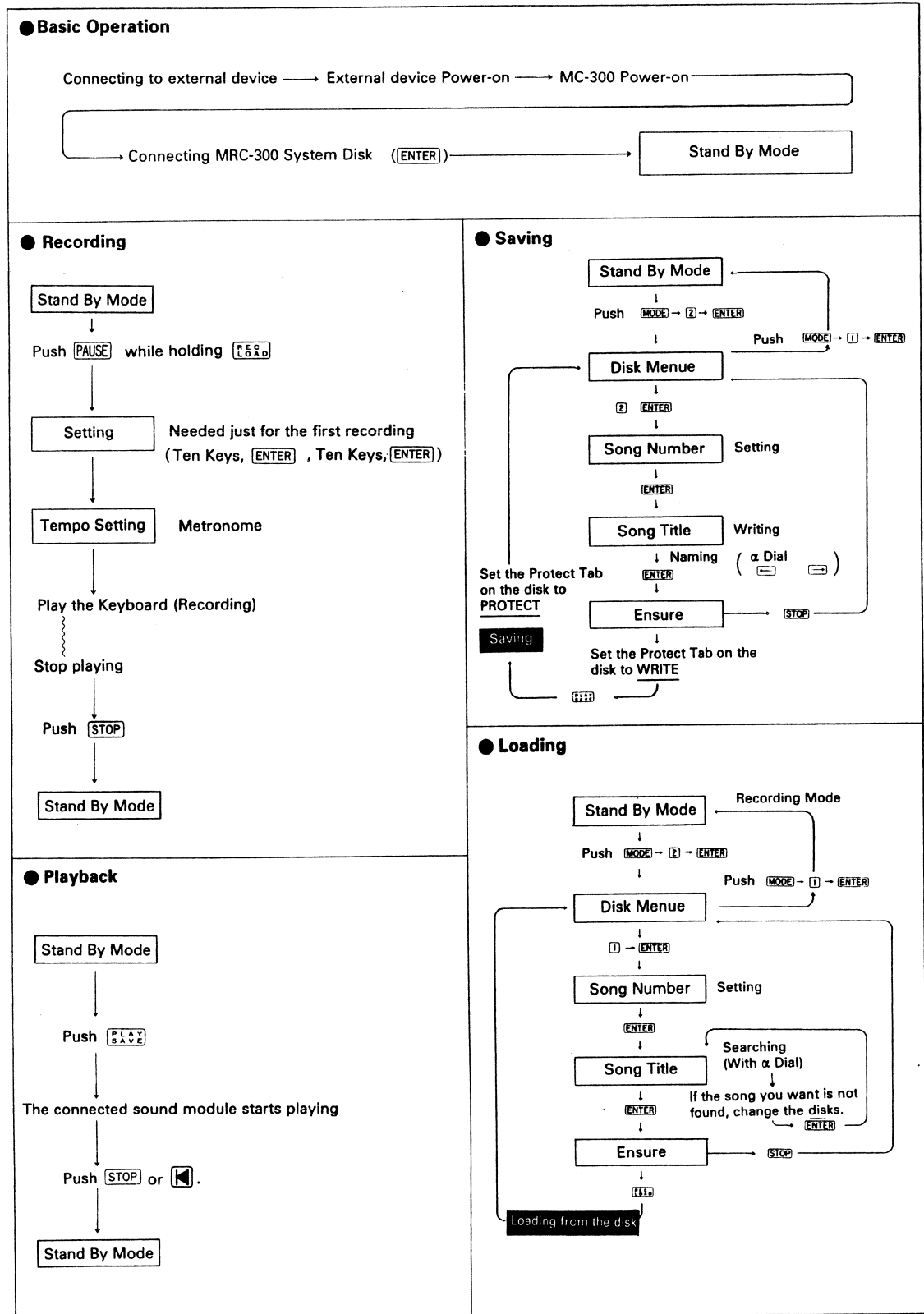

3 BASIC COURSE (II)

Many more functions are available in the MRC-300 system than are explained in the Basic Course (I).

• Alpha Dial and Ten Keys

The value and letters shown in the Display are easily edited with the Alpha Dial or Ten Keys. The parameter that can be edited is always the one that is flashing.

For instance, when the tempo number is flashing, rotating the Alpha Dial clockwise will increase the number up to 250 and counterclockwise will decrease up to 10. The Ten Keys also can be used for changing the value of the tempo. Just like when using a calculator, push the appropriate number buttons (within the range of 10 to 250), then hit **ENTER** in the end.

The value or letters available for each function differ, and both the Alpha Dial and the Ten Keys can be used for editing almost all functions.

When using the Ten Keys, the value is not changed until the **ENTER** key is pushed. Before pushing the **ENTER**, the new value and "+" alternately flash showing the edition is not yet completed.

When you wish to edit another parameter shown in the Display, use **→** or **←** button to cause the relevant parameter to flash, then edit it.

• Four Modes of the MRC-500 System

The MRC-300 system has four modes as follows.

Mode 1

This mode turns the MC-300 to a conventional sequencer.

Mode 2

This mode is used when transferring the data from MC-300's internal memory to a disk or vice versa, such as saving or loading.

Mode 3

This mode can playback the data saved on the MC-300's internal memory sequentially in an order you have set.

Mode 4

This mode should be selected when initializing the disk or copying the program on the system disk to other disk. This mode needs particular care, because the data in the MC-300's internal memory will be automatically erased.

Push the **MODE** button and rotate the Alpha Dial, and each of the four modes will be shown in the Display in sequence. You can also call the mode by assigning the number of the mode with the Ten Keys.

In Mode 1, the various buttons (MIDI, FUNC, EDIT etc.) serve to select the corresponding functions. First, push the relevant button, then select the function you want by rotating the Alpha Dial. Each function has its number just like the above four Modes, so you can call the function you want by using the Ten Keys, then hitting **ENTER**.

1. DISPLAY OF THE AVAILABLE MEMORY

You can see in the Display how much memory is left in the MC-300's internal memory or on the floppy disk.

a. DISPLAY OF THE MC-500'S AVAILABLE MEMORY

Push the **AVAIL** button while in the Stop Mode, and the Display will change as shown below.

Available Memory (Remaining Memory)

```
A V A I L O N M E M O R Y ▶ ☆ ☆ ☆ %  
☆ S O N G s E x i s t
```

The upper line shows what percentage of the memory capacity remains, while the lower line shows how many songs are written in memory.

To turn to the Stop Mode, push STOP.

The memory capacity of the MC-300's internal memory is about 25,000 notes, therefore, you can roughly tell how much more data can be recorded. (When using bender while recording, the memory capacity will be less than 25,000 notes.)

If the memory becomes full during recording, the Display will respond with:

```
E r r o r 4 M E M O R Y F U L L  
P r e s s S T O P
```

This means that no more note can be recorded.

b. DISPLAY OF THE AVAILABLE MEMORY ON THE DISK

Before saving the data in the MC-300's onto the disk, check if there is sufficient memory left on the disk as follows.

While in the Stop Mode, press **AVAIL** while holding the **SHIFT** down, and the Display will respond with:

```
A V A I L O N D I S K ▶ ☆ ☆ ☆ %  
☆ S O N G s E x i s t
```

The upper line shows what percentage of the memory is still available, while the lower line shows how many songs have been written on the disk.

To turn to the Stop Mode, push STOP.

To save the MC-300's entire data onto the disk, at least 25 percent of the memory should be left on the disk. Even if the available memory on the disk is less than 25 percent, you can save the small amount of data of the MC-300. To know whether it is possible to save the data in the MC-300 onto the disk, take the step ① on page 15, and if the Display responds with as below, replace the disk with a new disk which have been initialized.

```
E r r o r 1 4 D I S K F U L L  
C h a n g e D i s k & S T O P
```

2. OVERDUBBING

As you listen to the existing data recorded in a track, you can play the keyboard, recording it into another track. This is called Overdubbing.

a. OVERDUBBING FROM THE BEGINNING OF THE SONG

After two bar count-in (metronome), play the keyboard.

At the Measure Number Display, the number of the beats contained in the two bar count-in are shown, then it counts down with the metronome up to 1. After that, 1 (This represents Measure Number 1) is shown, where the recording starts.

Stop Mode after recording

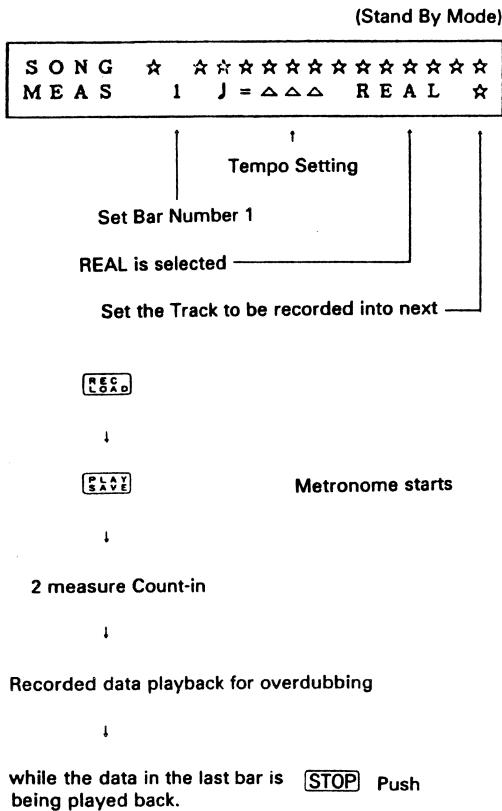

b. OVERDUBBING FROM THE MIDDLE OF THE SONG

Stand by Mode after recording

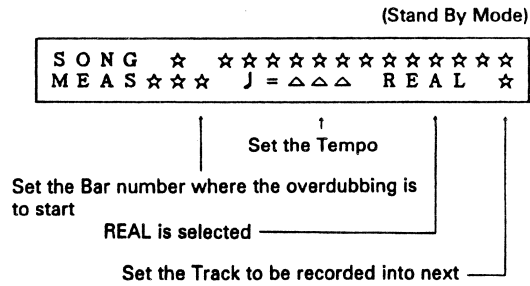

- The necessary procedure for this is exactly the same as "Overdubbing from the beginning of the song", except that you need to set the beginning bar where the overdubbing is to start. Also, note that the Track data recorded will play during two bar count-in.

c. AUTO STOP

When you are overdubbing, even after the existing data is played up to the end, the MC-300 continues to record what you are playing on the keyboard until you push the [STOP] button. Auto Stop is the function that automatically stops recording where the existing data is played back to the end.

(Stand By Mode)

```

SONG ☆ ☆☆☆☆☆☆☆☆☆☆☆
MEAS☆☆☆ J = △△△ ☆☆☆☆☆
    
```

[FUNC] → [8] → [ENTER] Select the Auto Stop

```

FUNC 8 AUTO STOP
  OFF
    
```

↑
Flashing

- When the flashing ON or OFF is shown in the Display, you can select Auto Stop On or Off by using the appropriate Ten Keys. "0" for Auto Stop On and "1" for Off.

[0] : OFF

[1] : ON

(e.g.) To turn the Auto Stop on;

[1] → [ENTER]

```

FUNC 8 AUTO STOP
  ON
    
```

[STOP]

(Stand By Mode)

```

SONG ☆ ☆☆☆☆☆☆☆☆☆☆☆
MEAS☆☆☆ J = △△△ REAL 1
    
```

- The Auto Stop On/Off which is Function 8 can be written for each song.
- When you are adding more data to the recorded data, turn the Auto Stop off.

d. SELECTING THE TRACK TO BE PLAYED

When more than one Track is used for overdubbing, you may not want to listen to all of the Tracks. The Play Track Buttons which are in use are lighted, so, simply push the Play Track Buttons which you do not want to hear, and the pushed buttons will go out, and the corresponding Tracks will be muted.

- This procedure does not erase the previously recorded data, therefore, pushing the Play Track Buttons again will call the sound recorded in that Track.

3. PUNCH-IN RECORDING

The Punch-in Recording function is useful for when you want to rerecord a part of the recorded data. From the Punch-in position to the Punch-out position, the MRC-300 system is in the recording mode, that is, the data previously recorded will be erased. It may be too difficult to set the Punch-in position with the buttons. Use the pedal switch DP-2 (optional).

Connecting the Pedal Switch to the Punch In/Out Jack

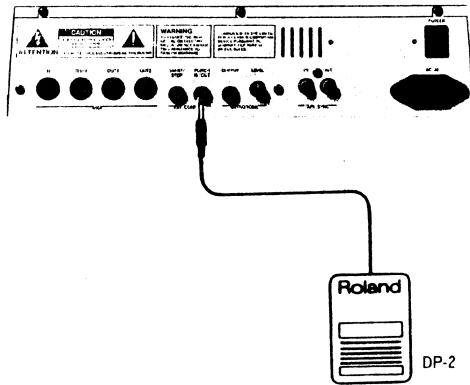

(e.g.) Punch-in Recording in the Track 2

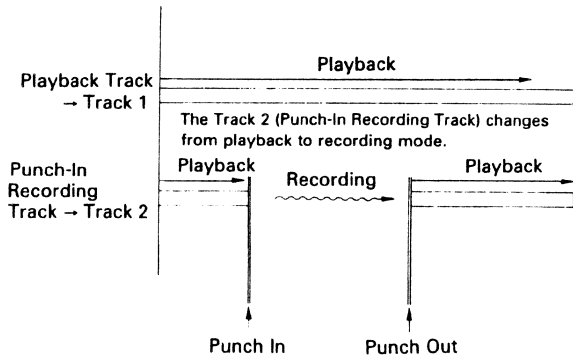

Stop Mode after Recording

(Stand By Mode)

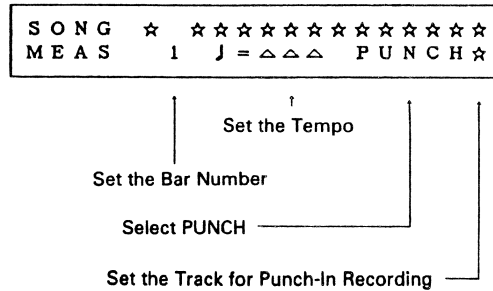

First go to the bar slightly before the bar where you are to set the Punch-in position, then set the Punch-in as you listen to the data being played back.

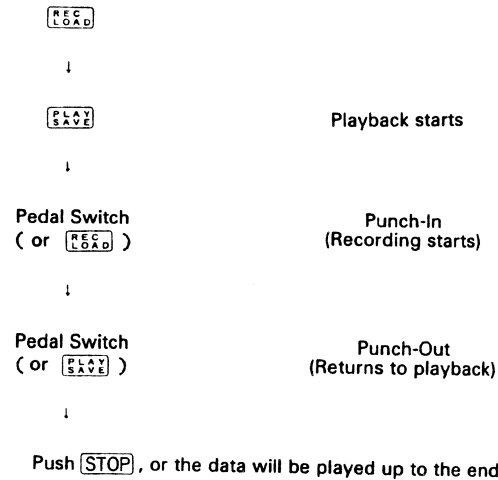

* The Punch-in recording function cannot be used for the data which has been recorded with bender or hold effect on. Otherwise, there would be several troubles caused, such as the MC-300 keeps sounding, the pitch of the sound is altered.

4. TEMPO WRITING

The tempo you have set in recording is not automatically written into memory, therefore can be changed during playback. The changed tempo can be saved onto the disk by taking appropriate saving procedure. Once the tempo is saved onto a disk, even if you change it during playback, it is only temporary, therefore when the data is loaded and played back, it is played in the saved tempo.

It is also possible to change the tempo while playing back the recorded data, and save it into a Tempo Track.

a. BASIC TEMPO WRITING

(Stand By Mode)

```

SONG ☆ ☆☆☆☆☆☆☆☆☆☆☆☆
MEAS☆☆☆ J = △△△ ☆☆☆☆☆
    
```

[FUNC] → [9] → [ENTER] Select the function Number 9

```

FUNC 9 BASIC TEMPO
      J = △△△
    
```

Set the Tempo

[ENTER]

Flashing

```

FUNC 9 BASIC TEMPO
      J = ☆☆☆
    
```

[STOP]

(Stand By Mode)

```

SONG ☆ ☆☆☆☆☆☆☆☆☆☆☆☆
MEAS☆☆☆ J = ☆☆☆ ☆☆☆☆☆
    
```

b. RECORDING INTO A TEMPO TRACK

Here, you quicken or slower the basic tempo. If you wish to change the overall tempo of the song, take "Basic Tempo Writing" procedure.

(Stand By Mode)

```

SONG ☆ ☆☆☆☆☆☆☆☆☆☆☆☆
MEAS☆☆☆ J = △△△ REAL T
    
```

Select REAL

Select T

[PLAY]

```

Press PLAY Button!
MEAS☆☆☆ J = ☆☆☆ REAL T
    
```

[PLAY]

After two bar Count-in, recording starts

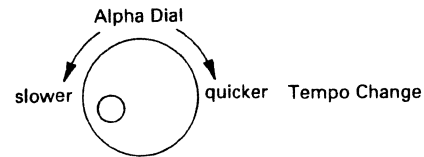

```

SONG ☆ ☆☆☆☆☆☆☆☆☆☆☆☆
MEAS☆☆☆ J = ☆☆☆ REAL T
    
```

Tempo Display

Recording stops at the end of data

To change the tempo drastically, assign the number for the tempo using the Ten Keys instead of the Alpha Dial, then hit the [ENTER] at the right moment.

- While the data with the tempo alteration saved is playing back, the Display shows as below telling you whether the tempo is faster or slower than the saved tempo.

```

SONG ☆ ☆☆☆☆☆☆☆☆☆☆☆☆
MEAS☆☆☆ J = △△△ ↑ ☆☆☆☆☆
    
```

↑
When the tempo is too quicker ↑
When the tempo is too slower ↓

5. OTHER USEFUL FUNCTIONS

a. METRONOME ON/OFF

Usually, the metronome is heard in quarter note timing. This can be changed to eighth note timing, if you like. Also, it is possible to turn the metronome on just in recording, both in recording and playback, or in the Stop Mode.

(Stand By Mode)

```
SONG ☆ ☆☆☆☆☆☆☆☆☆☆☆
MEAS☆☆☆ J = △△△ ☆☆☆☆☆
```

[FUNC] → [2] → [ENTER] Select Function Number 2

```
FUNC 2 METRONOME
  △ REC only
```

↑
Select J or J with the Alpha Dial

[ENTER]

```
FUNC 2 METRONOME
  ☆ △△△△△△△△
```

OFF	Metronome Off
REC only	Metronome On only during recording
REC & PLAY	Metronome On during recording and playing
Always	Metronome On in any mode of recording, playing or stop

Select any of the above modes with the Alpha Dial

[ENTER]

(Stand By Mode)

```
SONG ☆ ☆☆☆☆☆☆☆☆☆☆☆
MEAS☆☆☆ J = △△△ ☆☆☆☆☆
```

b. BLOCK REPEAT

Block Repeat function is playing sequence of bars repeatedly. Set the beginning bar and the number of the bars to be repeated, then push [PLAY] while holding the [SHIFT] down.

(Stand By Mode)

```
SONG ☆ ☆☆☆☆☆☆☆☆☆☆☆
MEAS☆☆☆ J = △△△ ☆☆☆☆☆
```

[FUNC] → [7] → [ENTER] Select Function Number 7

```
FUNC 7 BLOCK REPEAT
FROM △ FOR☆☆ MEAS
```

Ten Keys → ↑
[ENTER] Set the beginning bar

```
FUNC 7 BLOCK REPEAT
FROM ☆ FOR△△△ MEAS
```

↑
Set how many bars to be repeated with the Ten Keys

[ENTER] Flashing

```
FUNC 7 BLOCK REPEAT
FROM ☆ FOR△△△ MEAS
```

[STOP]

(Stand By Mode)

```
SONG ☆ ☆☆☆☆☆☆☆☆☆☆☆
MEAS☆☆☆ J = △△△ ☆☆☆☆☆
```

■ Naming the Data in the Internal Memory.

It is possible to name each song data in the internal memory.

- * To distinguish un-saved song in the internal memory from the song loaded from a disk, it may be a good idea not to name a song before saving it.

① [FUNC] → [3] → [ENTER] Select function 3.

② Name a song using the Alpha Dial, [←] and [→].

③ [STOP] → (Stand By Mode)

6. REVIEW OF THE BASIC COURSE (II)

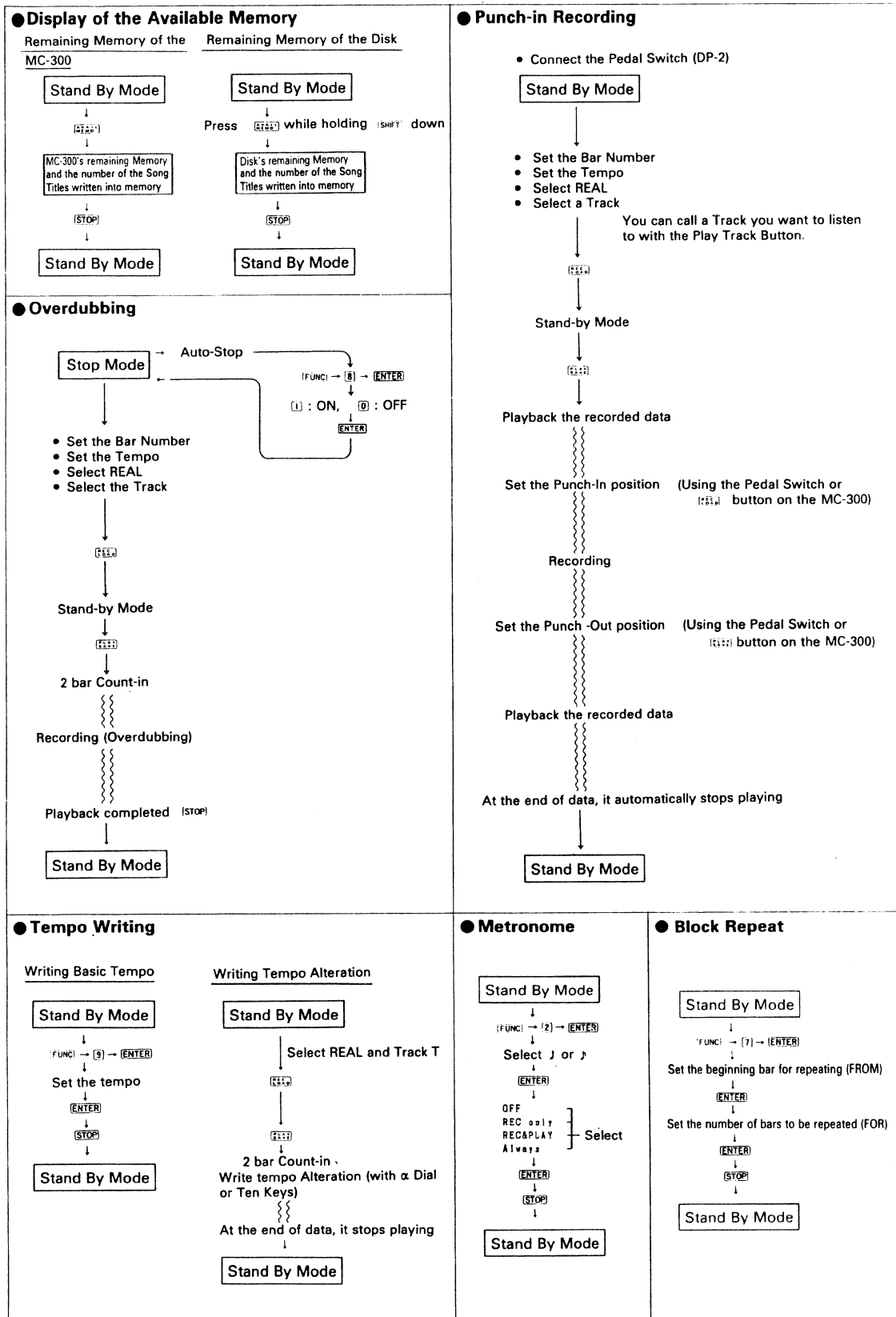

MRC-300 | **BASIC USERS/APPLICATIONS MANUAL**

88-8-AE2-4B



MRC-300 Quick Operation Table

MIDI
CHANNEL

NOTE/
STATUS

VELOCITY

GATE TIME

▶ Please use this operation table after reading the owner's manual thoroughly.

 **Roland**

1 Recording (Mode : 1)

a. Real Time Recording

P. 6-1

Select REAL (track 1 to 4) → **PAUSE** + **REC LOAD** → Enter Time Signature and Tempo → The MC-300 begins recording the moment you play the Keyboard without a count in (Auto Start) → **STOP**

b. Punch In Recording

P. 6-5

Select PUNCH → **REC LOAD** → **PLAY SAVE** → Press Pedal Switch (DP-2) to Punch In → Press Pedal Switch (DP-2) to Punch Out → **STOP**

c. Recording Tempo Changes

P. 10-1

Select REAL T → **REC LOAD** → **PLAY SAVE** → Record Tempo Changes Using the Alpha Dial or the Ten Key Pad → The MC-300 stops recording Tempo at the last measure of the composition

d. Step Recording (one note at a time)

P. 7-5

Select STEP (track 1 to 4) → **REC LOAD** → Default Setting will appear → Enter notes and rests with the Keyboard or Ten Key Pad → **STOP**

e. Step Recording (Tempo)

P. 10-2

Store Basic Tempo using FUNC and #9 → Assign a Bar → Select STEP T → **REC LOAD** → Select a Note (resolution) → Select a New Tempo

f. Rhythm Pattern

P. 11-4

Select R-PTN → **REC LOAD** → Select R-PTN number, Time Signature, Instrument, and Resolution → Desired Rhythm Velocity Number on the Ten Key Pad → **SHIFT** + **ENTER** → Write another R-PTN → **ENTER**

* Flam = **SHIFT** + Ten Key Pad

g. Rhythm Track

P. 11-9

Select R-TRK → **REC LOAD** → Repeat Pattern Number Selecting procedures → **STOP**

2 Edit (Mode : 1)

a. Erase (Edit : 1)	P.8-2
[EDIT] → [1] → [ENTER] → Select Track, Status, MIDI Channel → Assign the measures to be erased → Verify → [REC LOAD]	
b. Delete (Edit : 2)	P.8-4
[EDIT] → [2] → [ENTER] → Select Track → Assign the measures to be deleted → Verify → [REC LOAD]	
c. Insert (Edit : 3)	P.8-5
[EDIT] → [3] → [ENTER] → Select Track → Assign where and how many blank measures to be inserted → Select Time Signature → Verify → [REC LOAD]	
d. Merge (Edit : 4)	P.8-6
[EDIT] → [4] → [ENTER] → Select Destination Track and Source Track → Verify → [REC LOAD]	
e. Extract (Edit : 5)	P.8-7
[EDIT] → [5] → [ENTER] → Select Destination Track, MIDI CH you wish to extract from the Source Track and Source Track → Verify → [REC LOAD]	
f. Transpose (Edit : 6)	P.8-8
[EDIT] → [6] → [ENTER] → Select Track(s), MIDI CH, Bias and measures to be transposed → Verify → [REC LOAD]	
g. Change Velocity (Edit : 7)	P.8-11
[EDIT] → [7] → [ENTER] → Select Track(s), MIDI CH, Slope, Bias and measures to be transposed → Verify → [REC LOAD]	
h. Change MIDI Channels (Edit : 8)	P.8-12
[EDIT] → [8] → [ENTER] → Select Track, MIDI CH to be changed, New MIDI CH and assign measures → Verify → [REC LOAD]	
i. Quantize (Edit : 9)	P.8-13
[EDIT] → [9] → [ENTER] → Select Tracks, MIDI CH, Resolution, measures to be quantized and Destination Track → Verify → [REC LOAD]	
j. Copy (Edit : 10)	P.8-15
[EDIT] → [1] → [0] → [ENTER] → Select measures to be copied, the number of times you want the measures to be copied, Destination Track(s), the measure number where the copied measures begin → Verify → [REC LOAD]	

3 Microscope (Mode : 1)

⊙ Locating a Note Event

P.9-2 etc.

Select Track → **MICROSCOPE** → Scroll to the Note with Alpha Dial

⊙ Locating MIDI Event

P.9-3 to 9-7

Select Track → **MICROSCOPE** → Scroll to the MIDI Event to be changed with **SHIFT** + Alpha Dial

a. Change Event

P.9-3 to 9-7

MICROSCOPE → Locate the MIDI Event to be changed → **EDIT** → **1** → **ENTER** → Enter new value → **STOP**

b. Delete Event

P.9-8

MICROSCOPE → Locate the MIDI Event to be deleted → **EDIT** → **2** → **ENTER** → **REC LOAD** → **STOP**

c. Insert Event

P.9-8 to 9-15

MICROSCOPE → **EDIT** → **3** → **ENTER** → Select CPT where you want to insert the Event(s) → Enter each value → MICROSCOPE Display → **STOP**

d. Change CPT (Clock Pulse Time)

P.9-9

MICROSCOPE → Locate the Event to be changed to another CPT → **EDIT** → **4** → **ENTER** → Change CPT value → **STOP**

4 Monitor Available Memory (Mode : 1)

a. Internal Memory

P.2-4

AVAIL MEMO → **STOP**

b. Disk Memory

P.2-4

SHIFT + **AVAIL MEMO** → **STOP**

5 Functions (Mode : 1)

a. Sync Clock (Func : 1)

P.5-1

FUNC → 1 → ENTER → Select Sync Mode (Internal, MIDI or Tape) → STOP

b. Metronome (Func : 2)

P.5-2

FUNC → 2 → ENTER → Select ♩ or ♪ → Select when the Metronome is heard (OFF, REC only, REC & PLAY or Always) → STOP

c. Song Title (Func : 3)

P.5-3

FUNC → 3 → ENTER → Name Song Title → STOP

d. Rhythm Velocity (Func : 4)

P.11-4

FUNC → 4 → ENTER → Reprogram the eight levels of velocity → STOP

e. Rhythm Instrument (Func : 5)

P.11-3

FUNC → 5 → ENTER → Rename drum names and note numbers → STOP

f. Rhythm MIDI Channle (Func : 6)

P.11-2

FUNC → 6 → ENTER → Change Transmit MIDI Channels for Rhythm Data → STOP

g. Block Repeat (Func : 7)

P.5-3

FUNC → 7 → ENTER → Set measures to be repeated → STOP

h. Auto Stop (Func : 8)

P.5-4

FUNC → 8 → ENTER → Select ON/OFF of Auto Stop → STOP

i. Basic Tempo (Func : 9)

P.5-4

FUNC → 9 → ENTER → Select New Tempo → STOP

6 MIDI Receive Information (Mode : 1)

a. Receive Channel (MIDI : 1)	P.4-1
MIDI → 1 → ENTER → Select Receive Channel(s) → STOP	
b. Polyphonic Aftertouch (MIDI : 2)	P.4-2
MIDI → 2 → ENTER → Select ON or OFF → STOP	
c. Control Change [0~63] (MIDI : 3)	P.4-4
MIDI → 3 → ENTER → Select ON or OFF → STOP	
d. Control Change [64~122] (MIDI : 4)	P.4-4
MIDI → 4 → ENTER → Select ON or OFF → STOP	
e. Program Change (MIDI : 5)	P.4-5
MIDI → 5 → ENTER → Select ON or OFF → STOP	
f. Channel Aftertouch (MIDI : 6)	P.4-5
MIDI → 6 → ENTER → Select ON or OFF → STOP	
g. Pitch Bender (MIDI : 7)	P.4-6
MIDI → 7 → ENTER → Select ON or OFF → STOP	
h. Exclusive (MIDI : 8)	P.4-6
MIDI → 8 → ENTER → Select ON or OFF → STOP	

7 MIDI Output Information (Mode : 3)

a. MIDI Output Assignments (MIDI : 9)	P.4-8
MIDI → 9 → ENTER → Select the Channel Assignments for both outputs → STOP	
b. Sync Signal (MIDI : 10)	P.4-7
MIDI → 1 → 0 → ENTER → Select ON or OFF → STOP	
c. Exclusive (MIDI : 11)	P.4-7
MIDI → 1 → 1 → ENTER → Select ON or OFF → STOP	
d. Soft Thru	P.4-9
MIDI → 1 → 2 → ENTER → Select ON or OFF → STOP	

8 Disk Mode (Mode : 2)

a. Loading from Disk	P.3-5
MODE → 2 → ENTER → 1 → Select Song Number → Select Song Title → ENTER → Verify → REC LOAD → MODE → 1 → ENTER	
b. Saving to Disks	P.3-6
MODE → 2 → ENTER → 2 → Select Song Number → Make Song Title → ENTER → Verify → REC LOAD → MODE → 1 → ENTER	
c. Deleting Songs from Disk	P.3-7
MODE → 2 → ENTER → 3 → Select Song Title → ENTER → Verify → REC LOAD → MODE → 1 → ENTER	
d. Renaming a Song File on Disk	P.3-7
MODE → 2 → ENTER → 4 → Select Song Title → ENTER → Chang Song Title → Verify → REC LOAD → MODE → 1 → ENTER	

9 Chain Play (Mode : 3)

a. Chain Play

P. 12-2

MODE → 3 → ENTER → REC LOAD → Arrange the songs in chain → STOP → PLAY SAVE → Chain Playing → STOP → MODE → 1 → ENTER

10 Disk Utility (Mode : 4)

a. Initializing New Disks

P. 3-1

MODE → 4 → ENTER → REC LOAD → 1 → ENTER → Insert MRC-300 System Disk → Insert New Disk → ENTER → 4 → ENTER (Restart)

b. Backing Up Disks

P. 3-2

MODE → 4 → ENTER → REC LOAD → 2 → Insert the Disk to be backed up (Source Disk) → Insert New Disk → 4 → ENTER (Restart)

c. Transferring Song Files

P. 3-3

MODE → 4 → ENTER → REC LOAD → 3 → Insert the Disk to be backed up (Source Disk) → Insert New Disk → 4 → ENTER (Restart)

■ NOTE ON HANDLING THE FLOPPY DISK

Handling the floppy disk properly will maximize its life time. It, however will be erased some day in the course of nature. Please be sure to copy the system disk onto the supplied or a brand new disk and preserve the original system disk safely.

Roland®
RUS10010

UPC

RUS10010



10981

MRC-300

ADVANCED USERS/APPLICATIONS MANUAL

Roland

88-8-AE2-4B