

MATTEL ELECTRONICS™

# BASEBALL

## INSTRUCTIONS

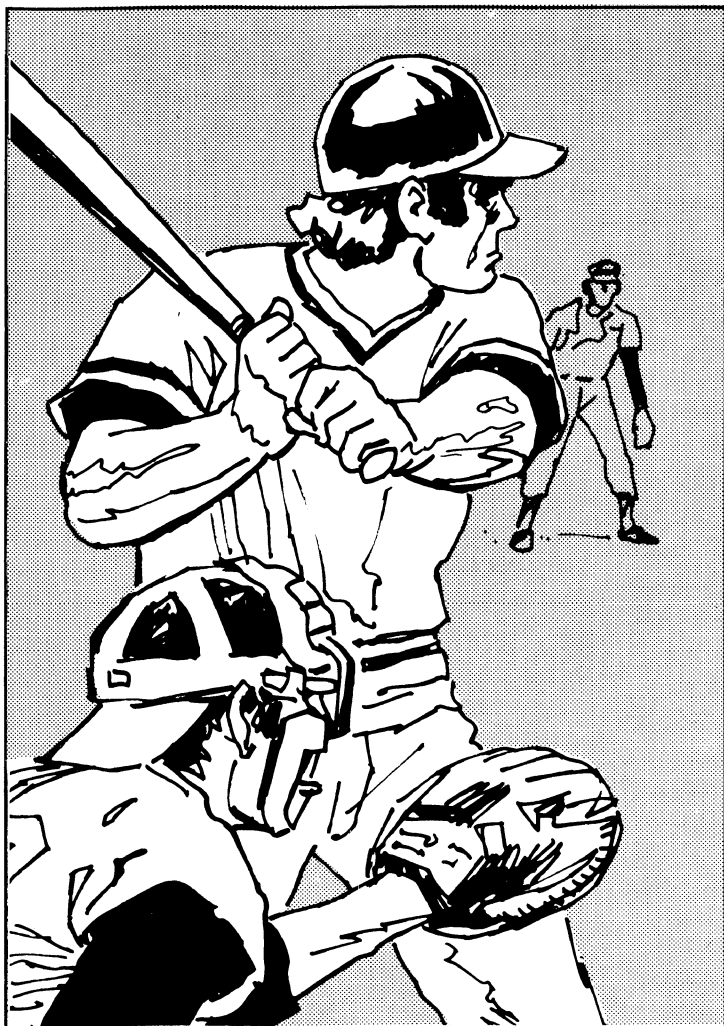

Mattel, Inc. 1978. Hawthorne, CA 90250.

PRINTED IN HONG KONG. All Rights Reserved.

2942-0920

- Computer controls pitching and plays defense.
- You control hitting and base running.
- You swing away at a fast one, hit a curve, stretch a single, even hit a home run!

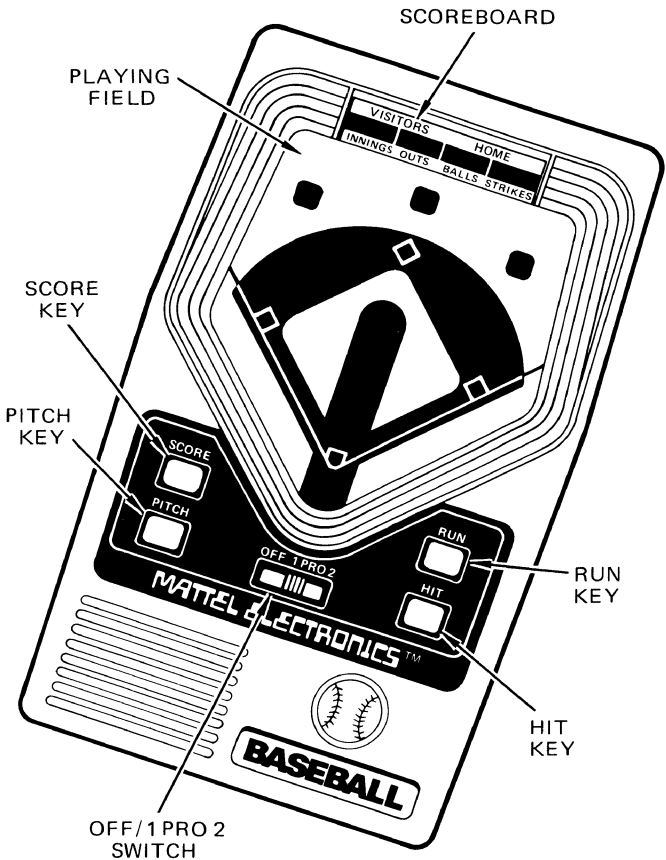

## HOW TO INSTALL THE BATTERY

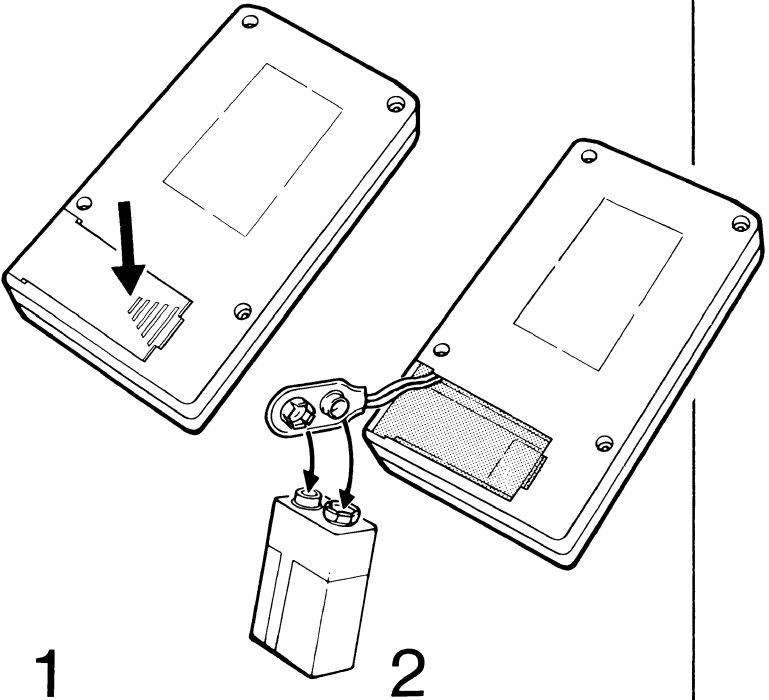

1

Press down on center of cover. Slide cover out to remove.

2

Attach one 9-volt battery to connector. Replace cover.

---

### IMPORTANT INFORMATION

If the blips of light representing the players or Scoreboard appear to be malfunctioning, this is the first sign of battery wear. A fresh battery should solve the problem. For longer battery life, use a 9-volt Alkaline battery.

## BASEBALL

Your Electronic Baseball Game is designed to provide either one or two players with the thrills and suspense of real baseball. Players compete against the computer and each other, trying to score as many runs as possible during the 5-inning game. Number of balls, outs, bases, etc. . . . is the same as in real baseball. You can get any kind of a hit, even walk on balls called. You'll need a good "batter's eye" to handle the tricky pitching, and you'll also need to keep on top of game conditions (number of outs, men on base, etc.) in order to make the most of your opportunities.

Plenty of excitement awaits you, so **play ball!**

## CONTROL KEYS

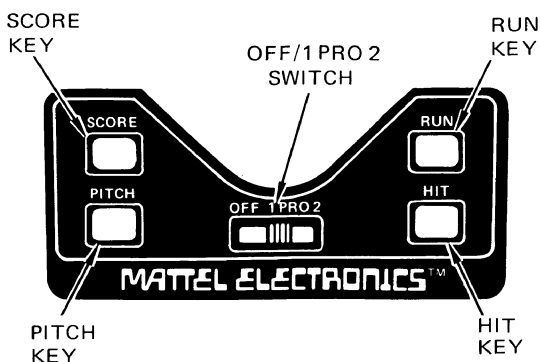

## OFF / PRO 1 / PRO 2 SWITCH

With this switch you turn the game on and simultaneously choose the range of pitching speeds you wish to bat against. The position "PRO 2" is super-fast, a challenge for any hitter. (PRO 1 and PRO 2 affect the speed of the entire game.) Be sure to switch to OFF when the game is over.

Game can be switched between PRO 1 and PRO 2 between plays allowing players of different skills to compete.

## PITCH Key

Press this key to deliver the pitch. There will be a delay (of 1.5 to 2.5 seconds) before the pitch is actually delivered, so just like a hitter in a real game, you'll need to be on your toes. You will be subject to a variety of pitches, including curve balls, all controlled by the computer. The pitching motion toward home plate is indicated by sequential lights moving from the pitchers mound toward the plate.

## HIT Key

When you think the pitched ball has entered the strike zone, (see diagram) press the HIT key. The result of your swing will be determined by the computer, based on the type of pitch thrown and where and when you make contact in the strike zone.

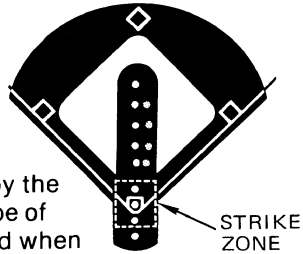

If you choose not to swing, that is, not to press HIT you will get either a called strike or ball.

## RUN Key

After you have pressed the HIT key and the computer has determined that you have made a hit (see HOW TO PLAY section to distinguish between a "hit" and a "fly out") you must press and HOLD DOWN the RUN key to advance your batter or lead runner if you already have a man on base. His running speed will be selected at random by the computer. It is very important for you to observe the speed of your runner (sequential lights around the basepath) so you can decide how many bases you will attempt to reach relative to the number of bases indicated by the computer for each hit. (For instance, it is possible to stretch a single into a double, double into a triple, etc.) If your man is caught off base after the ball has been fielded, the computer automatically calls out the batter or lead runner as the case may be. (Details in HOW TO PLAY) To stop the progress of the runner, just release the RUN key.

## SCORE Key

This key has two function:

1. To learn the score of the game, press this key anytime during a break in the action (between batters or innings). The score will appear on the scoreboard display.
2. After each half-inning (after each side has its turn at bat) you must press the SCORE key to reset the game for the next half-inning. The end of each half-inning will be signalled by a distinctive sound and you will be unable to operate any of the other keys until you press the SCORE key to reset.

## SCOREBOARD

During the course of play:

| VISITORS |      | HOME  |         |
|----------|------|-------|---------|
| 1        | 0.   | 2     | 1       |
| INNINGS  | OUTS | BALLS | STRIKES |

The scoreboard display shows the innings, balls outs, and strikes. A decimal point is lit to display which team is at bat. NOTE: Visitor at bat is displayed by decimal point in OUTS box. Home at bat is displayed by decimal point in STRIKES box. At the end of the five-inning game the score is automatically displayed.

| VISITORS |      | HOME  |         |
|----------|------|-------|---------|
| 0        | 5    | 0     | 3       |
| INNINGS  | OUTS | BALLS | STRIKES |

Pressing the SCORE key shows the score of each team. Here we see the score is 5 for the visitors and 3 for the home team.

# LIGHTS

The lights on the playing field perform several functions:

1. Each of the 3 bases plus home plate has a light of its own. They light when a runner lands on them.

2. Between every two bases are two other lights (A1, B1, A2, B2, etc.) which also indicate the progress of the baserunner.

3. The path of the pitched ball is indicated by sequentially lit lights, including lights in the strike zone that remain lit a moment after you have pressed the HIT key to show where the ball was when you "swung."

4. Lights behind first base (called "deep first") and third base ("deep third"), plus outfield lights in left, center, and right, will light to indicate in which fielder's direction you have hit the ball. When you have made a hit, the fielder in whose direction you have hit the ball, will stay lit until the ball is retrieved and thrown in. If you hit a "fly out" the same lights will flash intermittently. (In this condition it will not be possible for you to run) You will also note an audible sound after each contact with the ball. It is these

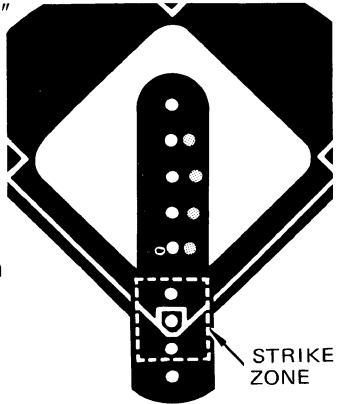
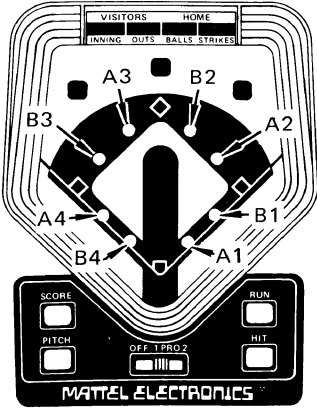

sounds, will, along with the lights, indicate if you have "flied out" or hit safely, and will also indicate the number of bases you might be able to get on that hit (see details and examples in HOW TO PLAY). Whether or not you can actually make the number of bases indicated by the sound effects depends on the speed of your runner. You will have to observe your runner's speed as well as the game situation in order to determine whether you want to take the chance advancing your runner to the number of bases indicated or beyond. Stop sooner to avoid the possibility of a runner being caught off base when the ball is fielded or stretched out an extra base.

## HOW-TO-PLAY

1. Move OFF-PRO 1 PRO 2 switch to position PRO 1 - normal speed - or PRO 2, fast speed.

| VISITORS |      | HOME  |         |
|----------|------|-------|---------|
| 1        | 0.   | 0     | 0       |
| INNINGS  | OUTS | BALLS | STRIKES |

Scoreboard will read, from left to right, inning #1, 0 outs, 0 strikes, 0 balls, and Visitors at bat (decimal point). Pressing SCORE key will show a 0-0 score.

PITCH



2. Press PITCH key. After a short delay, a pitch will be delivered. The pitch can be a fast, medium, slow, straight or curve. You should try to hit the ball when it is in the strike zone.

HIT



3. Press HIT key if you want to swing at the pitch. Upon doing so, any of the following can occur:



**A.** You might swing too soon, before the ball reaches the strike zone. This is counted as a strike, and you will hear a short, high-pitched "squeak." The scoreboard will register the strike.

**B.** You might swing too late, after the ball has passed the strike zone. This is also a strike (strike "sound").

**C.** You might swing and miss within the strike zone, also a strike.

**D.** You might not swing at all, and the pitch can be called a strike or a ball. The sound for a ball is the same as a strike (short squeak) but the scoreboard will register the ball. Three strikes and you're out. Four balls is a walk to first base, but you must press the "run" key to walk your man.

**E.** You may swing and connect for a "hit." The lights behind first and third base and in the outfield will indicate where your ball has been hit. Hitting the ball does not necessarily mean you can reach base safely:

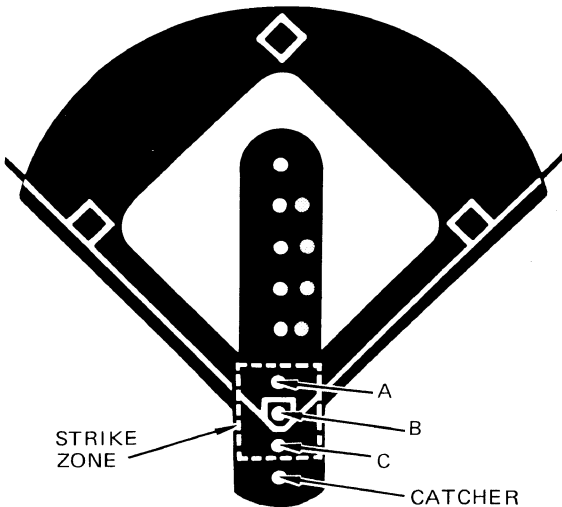

4. If you hit the ball and one of the fielder lights flashes intermittently, you have flied out. You will also hear a "plop" sound indicating you have made an out. The scoreboard will register the out. Remember that in this situation it will not be possible for you to run. If you hit the ball and one of the fielder lights goes on and remains **STEADILY** lit, then you have made a hit for which you run the bases using the accompanying beeping sound effects as an indicator as to how far you might go.

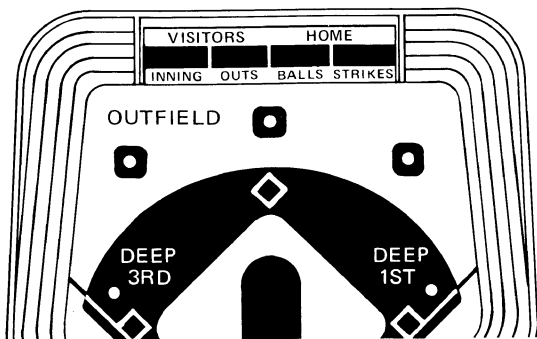

5. **STAY PARTICULARLY ALERT** to the "beep" sounds when hitting as they, **NOT THE LIGHTS**, are your main indicators for determining how many bases you may get:

One "beep" = one base.

Two "beeps" = two bases.

Three "beeps" = three bases.

For example, suppose after pressing HIT you hear two beeps and see that the centerfield light has lit and stayed on. This light indicates a good chance at a two base hit. However, you may not actually be able to reach 2nd base. This depends on the running speed of your batter and where, within that fielder's territory you have hit the ball. This will be decided by the computer. As a result, the time it takes a fielder to get the ball and throw it in, within a given number of beeps, will vary. By observing the speed of your runner, you then must estimate your chances

of reaching the number of bases indicated against the possibility that your hit turns out to be close to the fielder and your runner may get caught between bases and be called out, (by the same token, the computer may determine that the ball has been hit far from the fielder and you may want to stretch out an extra base.) Of course, your runner's speed will not be known until you have performed the next step.

**6.** If, after pressing HIT key, you get a hit (hit sound and steady fielder light), you next press the RUN key to advance your batter. His path around the bases is indicated by sequentially lit lights at each base as well as two additional lights in between every two bases, see example below (A1, B1, A2, B2, etc.). Your runner can advance at three different speeds, slow, medium, and fast, chosen at random

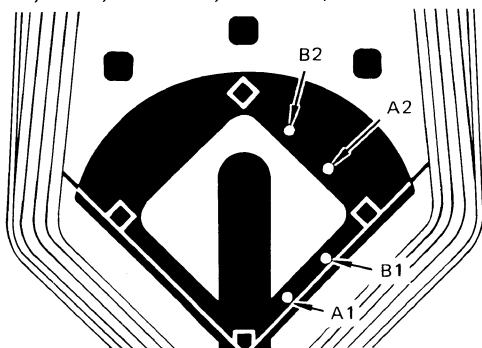

by the computer. It is up to you, by observing your runner's speed and keeping game circumstances in mind, to determine how far you want to risk running before releasing the RUN key and stopping your runner on a particular base. If the computer fields the ball (his light will go out) while your runner is in between bases, either he, or the lead baserunner ahead of him, will be out. Be particularly mindful that if you attempt to hold down the RUN key while simultaneously swinging at the ball, the runner will not move. (You must wait until you have first released the HIT key.)

The rules concerning runners caught off base when the fielders light goes out are as follows: If batter did

not get to first base he is out and any runners already on base return to last occupied bases. If batter passed first base, and there is a runner or runners already on base, the leading runner is out and the remaining runners including the batter move back to base if on "A" points (A1, A2, etc.) or forward to the next base if on "B" points. Thus, if there are men on first and second and the batter hits a possible double but the ball is fielded as he is running between first and second base while closer to second base (on point B1), the lead runner who was on second base originally would be out, the man who was on first would end up on third (because he was on point B2), and the batter would end up on second base. After a little experience you will become familiar with these rules.

## **THE HOME RUN**

When you hit a home run, the entire field will light up repeatedly and the run scored sound (ta ta!) will be heard 4 times. You must then press and hold down the RUN key to advance your batter around the bases, after which the run scored sound will be heard again indicating the total number of runs scored. Thus a home run with 2 men on base will produce 3 run scored sounds after all runners have crossed home plate.

## **Let's play a practice half-inning to review the rules:**

It is the very beginning of the game. The visiting side is up in the top half of the first inning. A decimal point is lit on the VISITORS side of the scoreboard. Speed has been set at PRO 1, normal speed.

Player presses PITCH and after a short delay the pitch is delivered. Waiting until the ball reaches a point somewhere in the strike zone between points A and C, player presses HIT. He immediately hears a "plop" sound ("out" sound) and sees a blinking fielder's light. This means he has hit a fly out, so there is no need for him to press the RUN key. The scoreboard registers 1 out.

Player presses PITCH again. He then presses HIT and hears a "squeak." This means he has missed the ball (or swung too early or too late) and the scoreboard registers a strike.

He presses PITCH again but this time does not press HIT. He hears the same "squeak" but this time the scoreboard registers a ball. So, the count is now one ball and one strike, and there is one out (from the previous fly out).

He pitches and hits again. This time he hears two beeps and sees the leftfield light go on and remain steadily lit. This means he has made a hit and has a chance to get two bases. He next presses and holds down RUN, and observes that his batter advances toward first base at medium speed (one of three possible speeds chosen at random by the computer). Judging the situation, that the game has just begun and there are no other baserunners in scoring position, player decides to see if he can advance his batter to second base before the computer completes the play. But the computer this time has determined the ball is hit close to the fielder and player finds his man caught between first and second base when the fielder's light goes out. He hears the "out" sound, and his man is removed from the basepath. The scoreboard registers the second out.

Pitch and hit again, and this time one beep is heard and the light at deep third stays lit, a chance for a single. Player presses RUN and the batter advances safely to first base. Two out, man on first.

Pitch and hit again. Two beeps are heard with the centerfield light going on steadily. This means a chance for a double. Player presses RUN and observes the running speed of his batter to be slow. He decides to try to run the man to first base and hold him there. It is now two out, men on first and second.

Pitch and hit again. Two beeps are heard with the right fielder's light lit steadily. Another chance at a double. Player presses RUN and observes the running speed of the batter to be fast. He decides to

try to stretch it into a triple and bring home the two men on base. He succeeds and as each crosses home plate, the run scored sound is heard (ta ta!) It is now two out, two runs scored, and a man on third.

Player presses PITCH and HIT and we see the light at deep first blink intermittently, the "out" sound is heard, followed by the three-outs "horn" indicating the end of the half-inning. Men left on base remain lit, in this case the runner on third who does not score, and the "out" light continues to flash until player presses the SCORE key to reset the game for the next half-inning.

Pressing SCORE key again reveals the score, 2-0 in favor of VISITORS. The HOME team now comes to bat.

| VISITORS |      | HOME  |         |
|----------|------|-------|---------|
| 2        | 0.   | 0     | 0       |
| INNINGS  | OUTS | BALLS | STRIKES |

## SOUNDS

**Strike/ball** — "squeak"

**Out** — "plop" (declining in pitch)

**Score** — rising two tones (ta ta!)

**Home Run** — same as Score, repeated 4 times

**End of half-inning, teams change** — "horn"

**End of game** — loud "horn"

**Hit** — 1, 2 or 3 "beeps"

## Here is a brief review of the main rules

Game time, 5-innings. Game can end in a tie.

**Strike** — swinging too soon, or too late, missing within strike zone, or a called strike.  
"Squeak" sound.

**Ball** — no swing. Computer calls a ball. "Squeak" sound.

**Out** — by striking out (three strikes) or by flying out (flashing outfield or deep first or third light) or by being caught off base. “Plop” sound. Three outs to a side.

**Hit** — outfield or deep first or third light on steadily. Particular light indicates maximum possible number of bases that may be gained. “Hit” sound.

**One Beep** — possible one base

**Two Beeps** — possible two bases

**Three Beeps** — possible three bases

**Score** — Each time a player reaches home plate, the score sound (rising two tones).

**Home Run** — all lights flashing and the score sound repeated 4 times. Player must press RUN to advance batter around bases.

**Men on Base** — if batter does not reach first base he is out and other batters return to last occupied bases. If batter passes first base but is caught between bases when play is completed, the lead runner is out and remaining runners move forward or back depending on which base they are closer to when ball comes to rest.

After a couple of warm-up games, you should master all the rules, so play ball!

---

## **CARE OF YOUR GAME**

Treat Electronic Baseball with care. Don't drop it or get it wet or dirty. Malfunctioning lights usually means it's time for a battery change.

## **90 DAY LIMITED WARRANTY**

Mattel electronics warrants to the original consumer purchaser of any of its hand-held electronic games that the product will be free of defects in material or workmanship for 90 days from the date of purchase.

During the 90-day warranty period the game will either be repaired or replaced with a new model without charge to the purchaser when returned either to the dealer with proof of the date of purchase, or when returned prepaid and insured, with proof of the date of purchase, to Mattel Electronics Repair Center, 5150 Rosecrans Avenue, Hawthorne, California 90250.

Units returned after the 90-day warranty period has expired, will be repaired for a service charge of \$10. Payment must be made by check or money order. This out-of-warranty service will only be available for one year from the date of purchase. All out-of-warranty units must be returned postage prepaid and insured to Mattel Electronics Repair Center.

**MATTEL ELECTRONICS WILL NOT BE LIABLE FOR LOSS OF USE OF THE PRODUCT OR OTHER INCIDENTAL OR CONSEQUENTIAL COSTS, EXPENSES OR DAMAGES INCURRED BY THE PURCHASER. ANY IMPLIED WARRANTIES ARE LIMITED IN DURATION TO THE 90-DAY PERIOD FROM THE ORIGINAL DATE OF PURCHASE.**

This warranty gives you specific legal rights and you may also have other rights which vary from state to state so the foregoing limitations may not apply to you. This warranty does not cover damage resulting from accident, unreasonable use, neglect, improper service or other causes not arising out of defects in material or workmanship.

### **HOW TO GET SERVICE FROM THE MATTEL ELECTRONICS REPAIR CENTER ON YOUR ELECTRONIC GAME DURING AND AFTER THE 90-DAY WARRANTY PERIOD**

During the 90-Day Warranty Period, you may have a defective game replaced at the dealer from which it was purchased. If, however, during this 90-Day Warranty Period, you choose to obtain repair or replacement service from the Mattel Electronics Repair Center, please make the arrangements described below.

- 1.** Pack the game carefully in the original box. If the game box is not available, use a good carton with plenty of newspaper or other padding all around and tie it securely.
- 2.** Carefully print on the box or carton the following name and address: **MATTEL ELECTRONICS REPAIR CENTER, 5150 ROSECRANS AVENUE, HAWTHORNE, CALIFORNIA 90250.** Also, don't forget to show your return address.
- 3.** Put parcel post stamps on the package; insure the package; then mail.

After the 90-Day Warranty Period and up to one year from the date of purchase, do all of the above plus enclose your check or money order for \$10.00 as payment for the repair service.