

 Roland

MIDI POLYPHONIC SYNTHESIZER

JX-8P

Owner's Manual



Radio and television interference

“Warning — This equipment has been verified to comply with the limits for a Class B computing device, pursuant to Subpart J, of Part 15, of FCC rules. Operation with non-certified or non-verified equipment is likely to result in interference to radio and TV reception.”

The equipment described in this manual generates and uses radio-frequency energy. If it is not installed and used properly, that is, in strict accordance with our instructions, it may cause interference with radio and television reception.

This equipment has been tested and found to comply with the limits for a Class B computing device in accordance with the specifications in Subpart J, of Part 15, of FCC Rules. These rules are designed to provide reasonable protection against such an interference in a residential installation.

However, there is no guarantee that the interference will not occur in a particular installation. If this equipment does cause interference to radio or television reception, which can be determined by turning the equipment on and off, the user is encouraged to try to correct the interference by the following measure:

- Disconnect other devices and their input/output cables one at a time. If the interference stops, it is caused by either the other device or its I/O cable.

These devices usually require Roland designated shielded I/O cables. For Roland devices, you can obtain the proper shielded cable from your dealer. For non Roland devices, contact the manufacturer or dealer for assistance.

If your equipment does cause interference to radio or television reception, you can try to correct the interference by using one or more of the following measures:

- Turn the TV or radio antenna until the interference stops.
- Move the equipment to one side or the other of the TV or radio.
- Move the equipment farther away from the TV or radio.
- Plug the equipment into an outlet that is on a different circuit than the TV or radio. (That is, make certain the equipment and the radio or television set are on circuits controlled by different circuit breakers or fuses.)
- Consider installing a rooftop television antenna with coaxial cable lead-in between the antenna and TV.

If necessary, you should consult your dealer or an experienced radio/television technician for additional suggestions. You may find helpful the following booklet prepared by the Federal Communications Commission:

“How to Identify and Resolve Radio-TV Interference Problems”

This booklet is available from the U.S. Government Printing Office, Washington, D.C., 20402, Stock No. 004-000-00345-4.

CONTENTS

1	Panel Description	3	4.	WRITE MODE	21	
2	Connection	6		A. Writing Operation	21	
3	Operation	7		B. Copying	21	
	1. PLAY, EDIT and WRITE	7		C. Editing Patch Chain	22	
	2. PLAY MODE	7		5. MEMORY CARTRIDGE	23	
	A. Selecting a Tone Color	8		A. Saving and Loading	23	
	B. Performance Control Section	8		6. OTHER FUNCTIONS	24	
	1) Pitch Bender/LFO Lever	8		A. Master Tune	24	
	2) After Touch	8		B. Selecting MIDI Function	24	
	3) Portamento	9		C. Error Indication	26	
	4) Key Mode Select	9		4	Specifications/Options	27
	C. Patch Chain	10				
	3. EDIT MODE	11				
	A. Editing without Programmer	11				
	B. Editing using Programmer PG-800	12				
	C. Parameter Table	14				
	D. Naming	20				

Please read the separate volume “MIDI”, before reading this owner’s manual.

1 PANEL DESCRIPTIONS

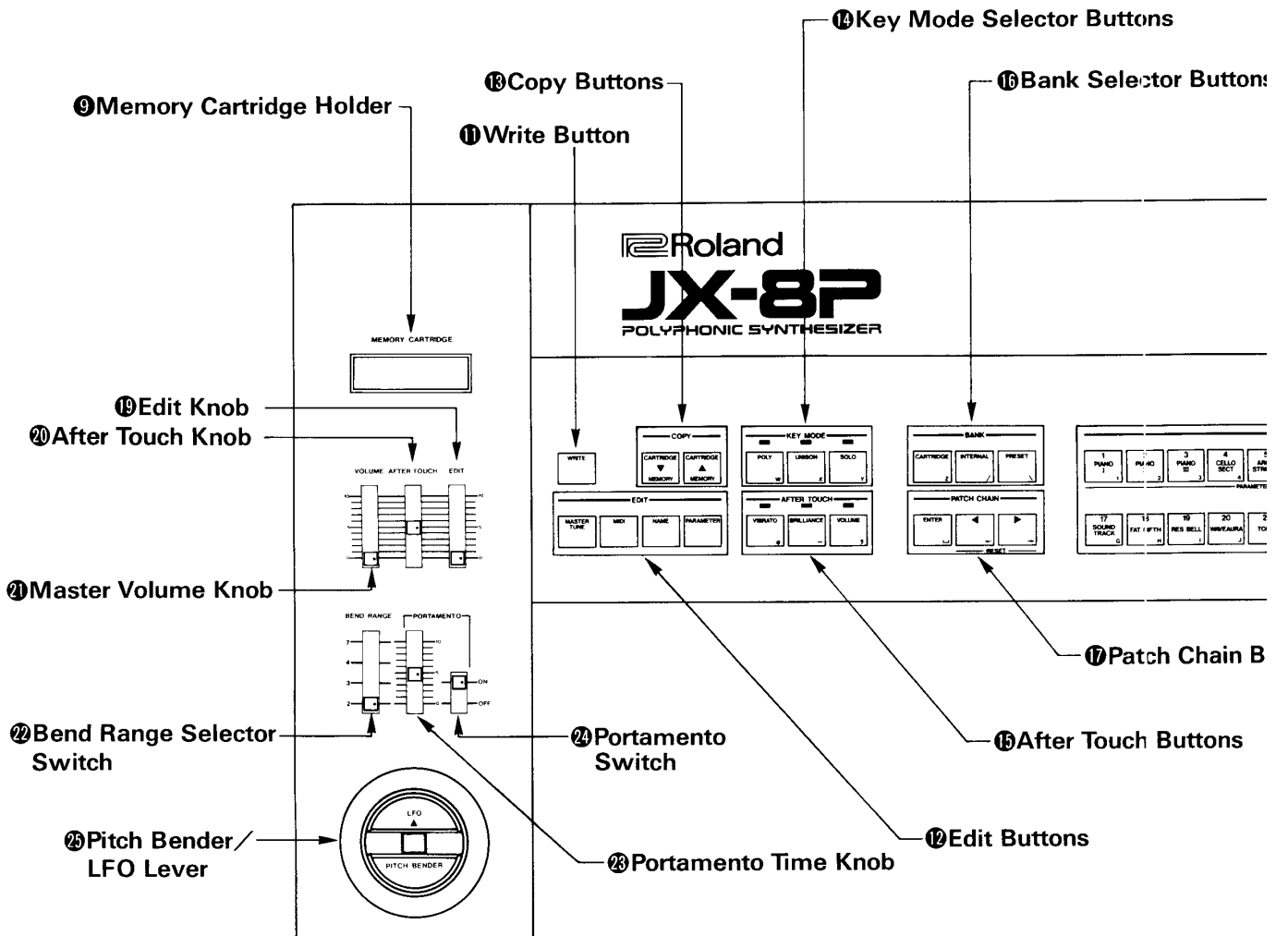
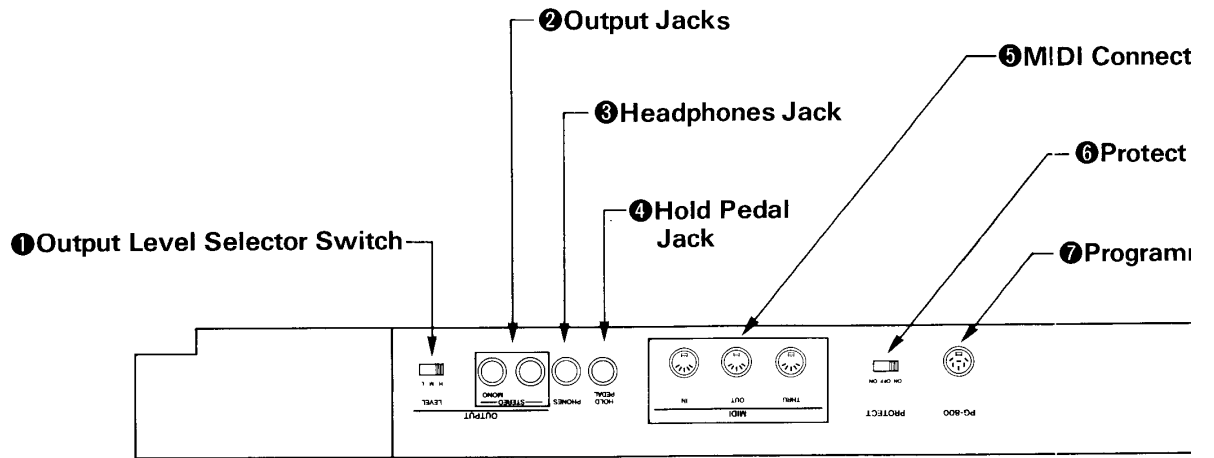

I Connectors

6 Protect Switch

Programmer Connector

8 Power Switch

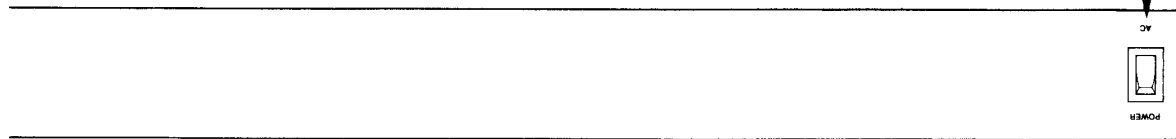

S

or Buttons

10 Display

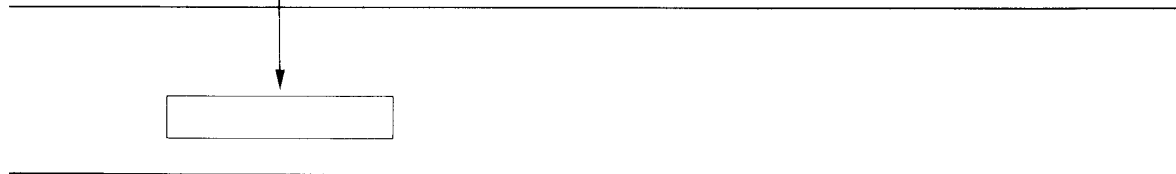

TONE															
3	4	5	6	7	8	9	10	11	12	13	14	15	16		
PIANO	CELLO	ARCO	LOW	HIGH	VOICES	ORGAN	ORGAN	PIPE	TUBALES	MUSIC	WIND	E. BASS	SYNTH		
19	20	21	22	23	24	25	26	27	28	29	30	31	32		
RES. BELL	TRUMPET	TROMBONE	CLAR.	RES. LEAD	SQUARE	STRG.	HORN	SOFT	STR.	ADGDO	CHURCH	BUBBLES	PITCHD		
					LEAD	LEAD	BRASS	BRASS	BRASS	BELL	BELL		MELLOW		

EDIT MAP																					
DCO-1	DCO-2	DCO-MID	MIXER	VCF	PCA	CHORUS	LFO	ENVLOPE-1	ENVLOPE-2	MIX											
11	NAME	21	RANGE	31	DYNAMICS	41	DCO-1	51	HP	61	LEVEL	71	WAVEFORM	81	ATTACK	91	ATTACK	101	DAMPEN	111	MODE
21	WAVEFORM	31	WAVEFORM	41	DCO-2	51	FREQUENCY	61	WAVEFORM	71	DELAY	81	DECAY	91	DECAY	101	PROPORT	111	MODE	121	MODE
31	TONE	41	ADJUSTION	51	DYNAMICS	61	FREQUENCY	71	WAVEFORM	81	DELAY	91	DECAY	101	PROPORT	111	MODE	121	MODE	131	MODE
41	LFO	51	NAME	61	DYNAMICS	71	FREQ	81	CHORUS	91	WAVEFORM	101	DELAY	111	WAVEFORM	121	MODE	131	MODE	141	MODE
51	ENVLOPE-1	61	NAME	71	FREQUENCY	81	ENVLOPE	91	ENVLOPE	101	ENVLOPE	111	ENVLOPE	121	ENVLOPE	131	ENVLOPE	141	ENVLOPE	151	ENVLOPE
61	ENVLOPE-2	71	NAME	81	FREQUENCY	91	ENVLOPE	101	ENVLOPE	111	ENVLOPE	121	ENVLOPE	131	ENVLOPE	141	ENVLOPE	151	ENVLOPE	161	ENVLOPE
71	ENVLOPE-3	81	NAME	91	FREQUENCY	101	ENVLOPE	111	ENVLOPE	121	ENVLOPE	131	ENVLOPE	141	ENVLOPE	151	ENVLOPE	161	ENVLOPE	171	ENVLOPE
81	ENVLOPE-4	91	NAME	101	FREQUENCY	111	ENVLOPE	121	ENVLOPE	131	ENVLOPE	141	ENVLOPE	151	ENVLOPE	161	ENVLOPE	171	ENVLOPE	181	ENVLOPE
91	ENVLOPE-5	101	NAME	111	FREQUENCY	121	ENVLOPE	131	ENVLOPE	141	ENVLOPE	151	ENVLOPE	161	ENVLOPE	171	ENVLOPE	181	ENVLOPE	191	ENVLOPE
101	ENVLOPE-6	111	NAME	121	FREQUENCY	131	ENVLOPE	141	ENVLOPE	151	ENVLOPE	161	ENVLOPE	171	ENVLOPE	181	ENVLOPE	191	ENVLOPE	201	ENVLOPE

Chain Buttons

Buttons

18 Tone Selector Buttons

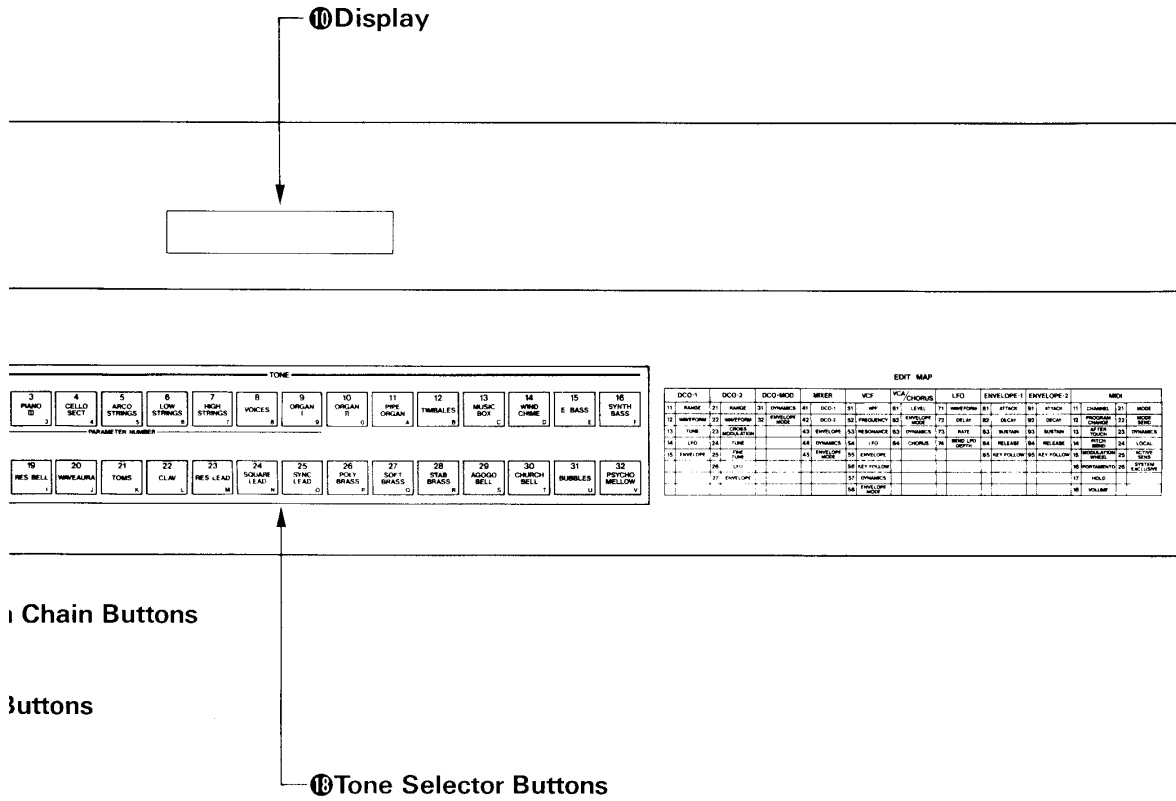

FEATURES

The Roland JX-8P is a 6 voice programmable synthesizer with Dynamics and After Touch functions. Its memory retains as many as 96 patch programs; 64 preset tone colors which are non-volatile and 32 in its internal memory which are freely programmable.

- The optional Memory Cartridge (M-16C), can expand the JX-8P's memory capacity by 32 programs.
- The JX-8P's Edit function allows you to alter any of the tone colors in it to your taste. The optional PG-800 can be used for faster and easier editing operation.
- The JX-8P allows you to put a name to each tone color using up to 10 letters before saving it.
- The name of the tone color or parameter currently in use is shown in the Display Window.
- The Patch Chain function is effectively used specially during live performance, allowing you to call up to 8 patch programs one after another in the order you have set.
- Incorporated with MIDI, the JX-8P can be set up with other MIDI devices.

IMPORTANT NOTES

POWER SUPPLY

- The appropriate power supply for this unit is shown on its name plate. Please make sure that the line voltage in your country meets that.
- Please do not use the same socket used for any noise generating device (such as motor, variable lighting system).
- This unit might not work properly if turned on immediately after turned off. If this happens, simply turn it off and turn it on again a few seconds later.
- Before setting up this unit with other devices, turn all of them off.
- This unit might get hot while operating, but there is no need to worry about it.

CLEANING

- Use a soft cloth and clean only with a mild detergent.
- Do not use solvents such as paint thinner.

LOCATION

- **Avoid using this unit in excessive heat or humidity or where it may be affected by direct sunlight or dust.**

REPAIRING

- Save the necessary data on a cartridge before having the JX-8P repaired, in case it happens to be accidentally erased.

2 CONNECTION

* Before making or breaking the connections, be sure to turn all the relevant units off.

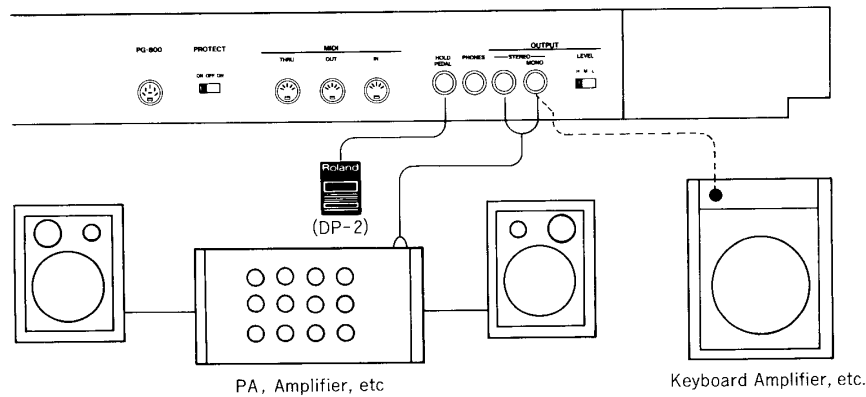

1. OUTPUT (Output Jacks)

These jacks are to connect amplifiers. To benefit the full advantages of the JX-8P, use the amplifiers and speakers for keyboard, PA, or audio equipment. Also, if using two amplifiers in stereo, the chorus effect will sound more effective.

2. LEVEL (Level Selector Switch)

With this switch, select an appropriate output level depending on the type of the amplifier you use. The knack is to select the position that allows undistorted sound of desirable level with the amplifier's volume set to 5 to 7.

3. PHONES (Headphones Jack)

Connect headphones to this jack.

4. HOLD PEDAL (Hold Pedal Jack)

Connect the damper pedal DP-2 (optional), and the Hold effect can be turned on or off by pressing the pedal.

5. MIDI (MIDI Connectors)

These are to connect other MIDI devices. Use the MIDI/Sync Cable MSC-25 or 50 (optional).

6. PG-800 (Programmer Connector)

Connect the programmer PG-800 (optional) here by using the 6P DIN Cable.

7. PROTECT (Protect Switch)

With this switch set to ON, the data will be protected from accidental loss.

8. MEMORY CARTRIDGE (Memory Cartridge Holder)

Connect the optional Memory Cartridge here. As shown in the picture below, set the Protect Switch on the cartridge to the On position. Then securely connect the cartridge into the holder with the Protect Switch side facing backward.

***Before connecting or disconnecting the cartridge, be sure to set the Protect Switch to the On position. To prevent the accidental loss of the data, never move the Protect Switch to the Off position, unless it is specifically instructed in the manual.**

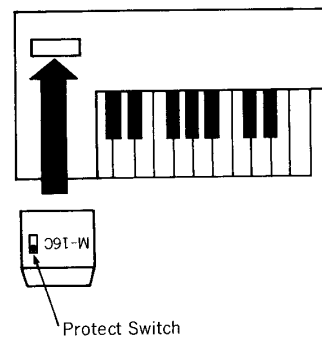

③ OPERATION

1. PLAY, EDIT & WRITE

Set up the JX-8P with the necessary equipment (such as amplifier and speaker), then turn the JX-8P, and it will be ready to be played (= **PLAY Mode**).

There are 96 different tone colors preprogrammed in the JX-8P's memory; 64 preset tone colors, another 32 in the internal memory, (and 32 on the optional cartridge). You can recall any of those patches by flick of a switch, then edit it to your taste (= **EDIT Mode**). This editing operation, however, does not automatically rewrite the existing tone color.

If you wish to write the edited tone color, an appropriate writing operation is required. The 64 Preset tone colors, however will never be erased, while the other 32 can be inevitably replaced with new patches by the writing operation (= **WRITE Mode**).

2. PLAY MODE

Check if all the connections are correctly made, then turn all the units on. The Display will respond with:



ROLAND JX-8P 12

While the above display is seen, the JX-8P is being tuned up, therefore cannot be played. When the tuning-up is finally completed, the number at the right side of the Display will become "1".

Then the Display will be as shown below.

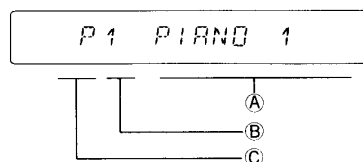

- Ⓐ Name of the tone color in use
- Ⓑ Number of the tone color (1 to 32)
- Ⓒ Bank in use (P, -P: Preset, I: Internal Memory, C: Cartridge Memory)

*Bank is a block which consists of 32 tone colors each.

A. SELECTING A TONE COLOR

Any tone color can be recalled by using the Bank Selector Button **Ⓟ** and the Tone Selector Button **Ⓢ**. There are four Banks in the JX-8P as follows.

P: 32 Preset tone colors which cannot be erased from memory

-P: 32 Preset tone colors which cannot be erased from memory

I: 32 tone colors in the Internal Memory

C: 32 tone colors on the Cartridge Memory

In each bank of **P** and **-P**, there are 32 tone colors preprogrammed.

All the tone colors can be edited to your taste, but the Preset tone colors cannot be erased for new patches. Other 64 tone colors in the internal memory and cartridge can be replaced with new patches by the writing operation.

The Memory Cartridge can be easily connected or disconnected, therefore, can be effectively used to expand the memory of the JX-8P.

Operation to select a tone color

① Assign the bank you want by pressing the relevant Bank Selector Button **Ⓟ**.

Press the Preset Button, and the Bank **P** and **-P** are alternately selected.

② Assign the number of the tone color you wish to call by pressing the relevant Tone Selector Button **Ⓢ**.

B. PERFORMANCE CONTROL SECTION

1) Pitch Bender/LFO Lever

Move this lever to change the pitch. Guitar's bending like effect can be obtained. At its center position, this has no effect on the JX-8P's sound, while the left and right extremes of movement achieve the same amount of the pitch bend effect. The maximum effect of the bender can be optional with the Bend Range Switch **Ⓡ**; Major 2nd, Minor 3rd, Major 3rd, and Perfect 5th.

Pushing this lever forward will result in vibrato effect. If the sound has no vibrato, the sound will take on usual vibrato effect, and if the sound already takes on vibrato, the effect will be deepened.

2) After Touch

After Touch is the effect caused by pressing down a key hard after pressing the key in usual manner. The JX-8P's After Touch can change any of the following 3 effects.

Vibrato The vibrato effect is deepened.

Brilliance The higher frequency is emphasized, therefore the sound becomes brighter.

Volume The volume is increased.

Operation for After Touch

① Select the effect on which you wish to have the After Touch effect, by pushing the After Touch Button **Ⓢ**.

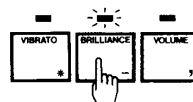

The indicator lights up.

② Adjust the intensity of the After Touch effect by using the After Touch Knob **Ⓡ**.

When this knob is set to zero, there is no after touch effect obtained.

More than one effect cannot be obtained at a time.

3) Portamento

The portamento effect will be on by setting the Portamento Switch to ON. The time needed for a sound to change from a pitch to the other can be altered by using the Portamento Time Knob .

4) Key Mode Select

The JX-8P contains 6 sound modules. Six different key assign modes are provided to decide how these 6 synthesizer modules will be assigned to the keys played.



POLY with the Indicator lighted

This mode turns the JX-8P to a 6 voice polyphonic synthesizer assigning one synthesizer module to each key pressed. This is suitable for the sound whose envelope curve is similar to piano's or guitar's, therefore chosen for usual performance.



POLY with the Indicator flashing

This mode is very similar to Poly mode above assigning only one synthesizer voice to each key pressed. The primary advantage of this mode is that only the last note or notes played together receive natural release length. This mode is suitable for the performance with portamento effect.



UNISON with the Indicator lighted

In this mode, two sound modules are assigned to each key, therefore the created sound is richer than in Poly mode. That is, the JX-8P becomes 3 voice synthesizer.



UNISON with the Indicator flashing

This is similar to the Unison mode above, but the one module of the two modules is one octave lower than the other.



SOLO with the Indicator lighted

This mode turns the JX-8P to a single voice synthesizer that assigns one module to each key.



SOLO with the Indicator flashing



This mode turns the JX-8P to the monophonic synthesizer that assigns 6 modules to one key pressed.

Please be sure that you are not touching any key on the keyboard while changing the key modes. Otherwise, JX-8P will lose the sound. If this happens, release the key once, then press the key again.



C. PATCH CHAIN

There may be some tone colors which are more often used. It will be handy if these patches are collected in sequence and called during live performance in the same sequence. The JX-8P's Patch Chain function allows you to write 8 particular patches in sequence and recall them one after another, just by pressing buttons. Each patch in the Patch Chain can retain a tone color with different settings of Key Mode, After Touch, Bender Range, Portamento ON/Off, Bend LFO Depth, Unison Detune and Portamento time.

Operation for calling the Patch Chain

- ① Press either the Patch Chain Button  or  . Then the Display shows "1" at the left side, and the number and name of the corresponding patch.



- ② Press either  or  to advance or back up a patch program in the Patch Chain.

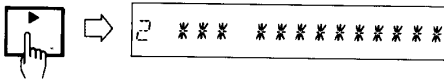

While using a patch program of the Patch Chain, you may notice that it does not sound faithful to each position of the knobs in the Performance Control Section (such as Bend Range, Portamento). This is because the settings of the Performance Control Section are written into each patch program together with other settings, and the actual positions of knobs have no effect on the sound. However, if you move the knob even slightly, the value of the parameter written in memory is temporarily cancelled and ready to be controlled manually. This does not rewrite the value in memory, so if you want to retain it, appropriate writing operation is required. (See Editing Patch Chain in "3 4 WRITE MODE" on page 22.)



Patch Chain is a function of remembering the combination of the 8 patch programs with different effect and mode settings, that is, it has no ability of retaining the nature of the patch programs in the Chain. Therefore, if the patch programs are edited and overwritten or a replaced with new patches, the Patch Chain accordingly changes.

If you want to return to the usual Play mode, turn the Power Switch  OFF once, then turn it ON again.

Patch Chain

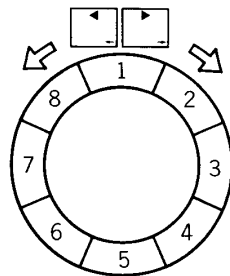
Each number in the Patch Chain contains a patch program with tone color and several effect settings.



← Pressing  and  at the same time will reset to 1.

3. EDIT MODE

Like any analog synthesizer, the JX-8P had various parameters which can be edited for sound synthesis. The JX-8P, however, does not feature knobs or switches on its panel for you to touch or move. Instead, there are two methods of synthesizing. One is calling each parameter and changing its value with the Edit Knob. The other is using the optional programmer PG-800 which works just like panel controls of a synthesizer.

For quicker and easier editing or synthesis from scratch, the PG-800 may be essential.

A. EDITING WITHOUT PROGRAMMER

A number (11 to 95) is assigned to each parameter. Call the parameter whose value you wish to change by using the Tone Selector Buttons ⑩.

*Use the Edit Map located in the right to the Tone Selector Buttons ⑩ to find out the number of each parameter.

① Call the patch you wish to edit by using the Bank Selector Button and the Tone Selector Button.

② Press the  of the Edit Buttons ⑪.

The JX-8P is turned to the Edit mode, and the Display will show;

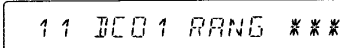

11 DEC 1 RANG ***

*** indication differs depending on the tone color.

Pressing the  button will always cause the Display to respond with the same indication as above.

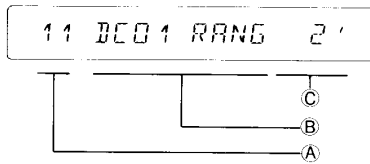

- Ⓐ **Number of the parameter you have called (11 to 95)**
- Ⓑ **Name of the parameter**
- Ⓒ **Value of the parameter** (The same number means different values according to the parameters, refer to Parameter Table on page 14 to 19.)
- ③ By using the Tone Selector Buttons 1 to 9, assign the number of the parameter whose value you wish to change. (11 to 95)
- ④ Play the JX-8P, and while listening to the sound, change the value of the parameter with the Edit Knob ⑩.
- ⑤ Repeat steps ③ and ④ as many times as necessary.

B. EDITING USING PROGRAMMER PG-800

The Programmer PG-800 works just like panel controls of a synthesizer. That is, using the PG-800 with the JX-8P, you can easily select any patch you like and edit it by knobs and switches which are tangible, as you would with a usual synthesizer.

*Refer to "Parameter Table" shown on page 14 to 19 to study the function of each parameter.

*To set up the PG-800 with the JX-8P, use the 6P DIN Cable of the PG-800.

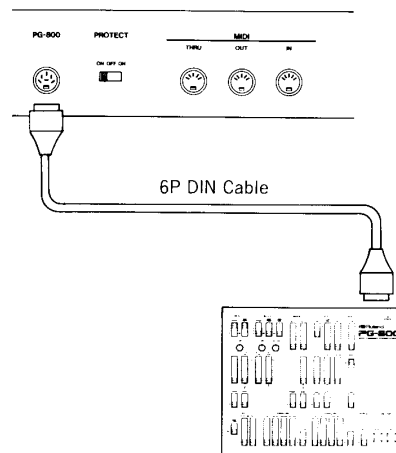

The PG-800 operates with the JX-8P set to either Play or Edit mode.

1) When the JX-8P is set to the Play mode:

Using the controls on the programmer, you can edit the tone color currently in use. The Display, then shows



with the tone number flashing.

2) When the JX-8P is set to the Edit mode:

The programmer works just like in Play mode above, and moreover, by assigning the parameter number you like, you can change the Display to see the parameter value.

3) When the Manual Button on the programmer is pressed:

In this case, the whole panel setting of the PG-800 decides the tone color. That is, now, existing patch program in memory has nothing to do with your sound synthesis. You make a new patch from scratch.

The Display Window will respond as shown below.

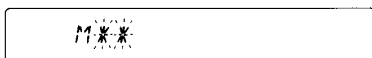

*While editing a parameter with the PG-800, even if the current set positions of the knobs or switches are exactly what you desire, change the position once then return it. Otherwise, the parameter value might not be affected by the PG-800, thereby remain unchanged.

Recall in Edit

While or after editing a patch program, you may wish to listen to the original tone color before edited. The JX-8P allows you to recall the original patch program without erasing the edited program.

Operation

① Make sure that the JX-8P is now set to the Play mode. If not, turn the JX-8P to the Play mode.

② Press the Tone Selector Button of the edited tone color.

Now, the original tone color will be heard. The display will respond as shown below with the tone number lighted.



③ To return to the edited tone color, simply press the same Tone Selector Button.

The Display will respond as shown below with the tone number flashing.







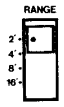

The original and edited tone colors can be alternately selected by pressing the relevant Tone Selector Button.

C. PARAMETER TABLE

DCO (Digitally Controlled Oscillator)

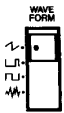
DCO is the digitally controlled oscillator that controls the pitch and generates the waveforms that are the sound source of the synthesizers. Owing to its digital control system, this offers superior pitch stability compared to the VCO (Voltage Controlled Oscillator). The JX-8P has 2 DCO's.

Parameter Number	Parameter Display	Data Value	Function	Programmer
11	DCO1 RANG	2'	This is to change the pitch range of the DCO in exact one octave steps from 2' to 16' (2', 4', 8', 16'). 8' is standard.	
	DCO-1 Range	4'		
21	DCO2 RANG	8'		
	DCO-2 Range	16'		
12	DCO1 WF	SAWT	This is to choose the output waveform of the DCO. SAWT:  (Saw Tooth) PULS:  (Pulse Wave) SQUR:  (Square Wave) NOIS:  (Noise)	
	DCO-1 Waveform	PULS		
22	DCO2 WF	SQUR		
	DCO-2 Waveform	NOIS		
13	DCO1 TUNE	+ 12	This changes the frequency (pitch) of the DCO, in semi-tones steps. •Variable Range: ± 12 (± 1 Octave)	
	DCO-1 Tune	00		
24	DCO2 TUNE	00		
	DCO-2 Tune	- 12		

Note 1

Depending on the position of the Dynamics Range Selector, the tone color alteration differs as shown below.

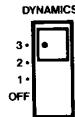
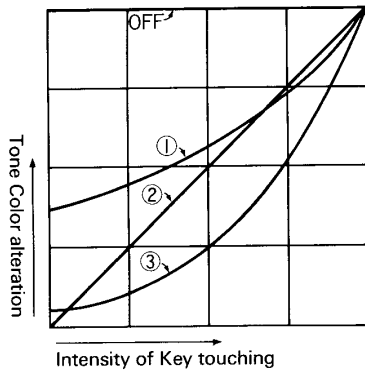



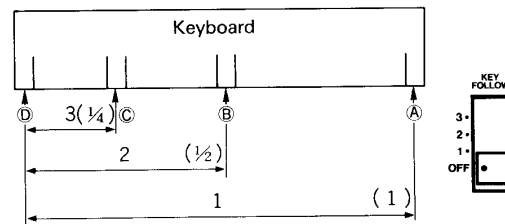

Note 2

Envelope Key Follow



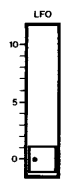
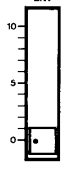
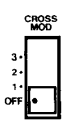



OFF: All Keys have the same Envelope time.

- 1: The highest Key (A) has the ENV time exactly half length of the lowest Key (D)'s.
- 2: The Key (B) has the ENV time exactly half length of the lowest Key (D)'s.
- 3: The Key (C) has the ENV time exactly half length of the lowest Key (D)'s.

Parameter		Data Value	Function	Programmer	
Number	Display				
14	DCO1 LFO	99	When the LFO output is modulating the DCO, this parameter is used to adjust the depth of the modulation. For vibrato effect, select "SINE" with the LFO Waveform.		
	DCO-1 LFO Depth				
26	DCO2 LFO	}			
	DCO-2 LFO Depth				
15	DCO1 ENV	00	When the ENV output is modulating the DCO, this parameter is used to adjust the depth of the modulation.		
	DCO-1 Envelope Depth				
27	DCO2 ENV				
	DCO-2 Envelope Depth				
23	DCO XMOD	XMOD	<ul style="list-style-type: none"> • SNC 1: The pitch is determined by DCO-1, and the harmonic contents by DCO-2. The waveform is determined by the DCO-2's synchronization to DCO-1. • SNC 2: Both SYNC 1 and X MOD work together. • * MOD: DCO-1 and DCO-2 affect each other, pitch, harmonic contents, and waveform. • OFF: Each DCO-1 and DCO-2 can have different pitch and waveform. 		
	Cross Modulation	SNC2			
		SNC1			
		OFF			
25	DCO2 FTUN	+50	The frequency (pitch) of the DCO-2 can be adjusted with this parameter.		
	DCO-2 Fine Tune	-50			• Variable range... ± 50 cent
31	DCO DYNA	3	When the DCO's pitch is controlled by the ENV, and the amount of the ENV is controlled by Dynamics (Key Touch), this parameter adjusts the sensitivity of Key Touch. (Note 1)		
	DCO Dynamics Range	2			
		1			
		OFF			
32	DCO MODE	U-1	This selects the polarity of the Envelope curve. Normally, ^ is used. In V mode, ADSR pattern will be all inverted.		
	DCO Envelope Mode	U-1			U-1: ENV 1 ^
		U-2			U-1: ENV 1 V
		U-2			U-2: ENV 2 ^ U-2: ENV 2 V



MIXER



This is where the volume balance of the DCO-1 and DCO-2 is controlled.

Number	Parameter Display	Data Value	Function	Programmer	
41	MIX DCO1	99) 00	This adjusts the level of DCO-1.		
	DCO-1 Level				
42	MIX DCO2		This adjusts the level of DCO-2.		
	DCO-2 Level				
43	MIX ENV	00	When ENV controls the DCO-2's level, this sets the amount of ENV signal.		
	DCO-2 Envelope Depth				
44	MIX DYNA	3 2 1 OFF	When the DCO-2's level is controlled by ENV Depth and then by Dynamics, this sets the maximum sensitivity of the Key Touch. [NOTE 1]		
	DCO-2 Dynamics Range				
45	MIX MODE	0-1	Normally, ^ is used, and in v mode, ADSR pattern will be inverted.		
	DCO-2 Envelope Mode	0-1			0-1 : ENV 1 ^
		0-1			0-1 : ENV 1 v
		0-2			0-2 : ENV 2 ^
	0-2	0-2 : ENV 2 v			

VCF (Voltage Controlled Filter)

The output signal goes to the Mixer then to the VCF to be filtered. Each VCF lets lower frequency harmonics pass and cuts off the higher ones. In other words, it is a usual low pass filter. By controlling the cutoff point and resonance, the waveform changes, thereby the tone color alters.

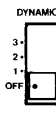



Number	Parameter Display	Data Value	Function	Programmer
51	HPF FREQ	3 2 1 0	The HPF (High-Pass Filter) is a filter that passes higher frequency harmonics and cuts off the lower ones. As you increase the value, cutoff point goes up, lower frequency harmonics being cut off.	
	High-pass Filter Cutoff Frequency			
52	VCF FREQ	99) 00	This is for changing the cutoff point of the VCF. As you decrease the value, cutoff frequency will come down, and the waveform gradually becomes approximation of a sine wave, then the sound will fade out.	
	Cutoff Frequency			

Parameter		Data Value	Function	Programmer
Number	Display			
53	VCF RES	99) 00	<p>This emphasizes the cutoff point. As you increase the value, the created sound will become more unusual, more electronic in nature.</p> <p>This controls the cutoff point by the waveform selected at the LFO section. Increasing the value deepens the modulation.</p> <p>This controls the cutoff point of the VCF in each note with the ENV curve set in the ENV section. As you increase the value, tone color within one note changes more drastically.</p> <p>This can shift the cutoff point by key position (pitch). At 100%, it prevents any inconsistency in the harmonic contents caused by pitch alteration.</p> <p>Parameter value 83 (=Programmer's Knob"8")=100%</p>	
	Resonance			
54	VCF LFO			
	LFO Depth			
55	VCF ENV			
	Envelope Depth			
56	VCF KEY	00	<p>Parameter value 83 (=Programmer's Knob"8")=100%</p>	
	Key Follow			
57	VCF DYNA	3	<p>When the VCF is controlled by ENV and Key Touch (Dynamics), this parameter determines the sensitivity of the Key Touch. (Note 1)</p>	
	Dynamics Range	2		
		1		
		OFF		
58	VCF MODE	0-1	<p>This is to select the polarity of the Envelope curve that controls VCF. Usually ^ may be used. In v mode, ADSR pattern will be inverted.</p> <p>0-1: ENV1 ^ 0-1: ENV1 v 0-2: ENV2 ^ 0-2: ENV2 v</p>	
	Envelope Mode	0-1		
		0-2		
		0-2		

VCA (Voltage Controlled Amplifier)/
Chorus

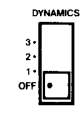

After filtered in the VCF, the signal is fed to the VCA where the volume (amplitude) of the sound is controlled.

Parameter		Data Value	Function	Programmer
Number	Display			
61	VCA LEVEL	99	<p>This is to adjust the volume level, and can be effectively used in the writing mode. If it is set too high, sound may be distorted.</p>	
	VCA Level	00		

Parameter		Data Value	Function	Programmer
Number	Display			
62	VCA MODE	ENV2	This is to select whether to control the VCA by the signal from the ENV-2 () or by the Gate signal ().	
	VCA Mode	GATE		
63	VCA DYNA	3	This parameter determines the sensitivity of the Key Touch (Dynamics, effect). (Note 1)	
	VCA Dynamics Range	2		
		1		
		OFF		
64	CHORUS	2	OFF: Chorus is off 1: Expansive Chorus effect is obtained. 2: Rich Chorus effect is obtained.	
	Chorus Mode	1		
		OFF		

LFO (Low Frequency Oscillator)

This oscillator generates extremely low frequency, so produces a vibrato or growl effect by controlling the DCO or VCF.

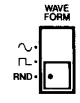
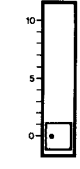
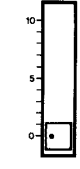
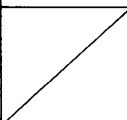
Parameter		Data Value	Function	Programmer
Number	Display			
71	LFO WF	SINE	This is for selecting the LFO output waveform. SINE:  (Sine Wave) SQR:  (Square Wave) RAND: Random	
	LFO Waveform	SQR		
		RAND		
72	LFO DELAY	99	This sets the time needed for the modulation by the LFO to start.	
	Delay Time	00		
73	LFO RATE	99	This sets the rate (frequency) of the LFO.	
	Rate	00		
74	BEND LFO	99	This determines the depth of the vibrato effect obtained by pushing the Pitch Bender/LFO Lever. As the value is increased, vibrato becomes deeper. This value can be written only in the Patch Chain.	
	(Bend LFO Depth)	00		

ENV (Envelope Generator)

This generates the control voltage (Envelope) which controls the DCO, VCF and VCA, therefore, alters the pitch, tone color and volume in each note.

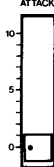
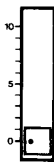
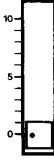
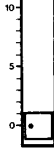
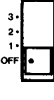



Parameter		Data Value	Function	Programmer
Number	Display			
81	ENV 1 ATT		This determines the time required for the voltage to reach its maximum from the moment the key is played.	
	ENV-1 Attack Time			
91	ENV 2 ATT			
	ENV- Attack Time			
82	ENV 1 DEC Y	99	This determines the time required for the voltage to drop from the maximum to the sustain level.	
	ENV-1 Decay Time			
92	ENV 2 DEC Y)		
	ENV-2 Decay Time			
83	ENV 1 SUS	00	This sets the sustain level to which the voltage falls at the end of the decay time. Therefore, at its maximum setting, Decay Time Knob has no effect.	
	ENV-1 Sustain Level			
93	ENV 2 SUS			
	ENV-2 Sustain Level			
84	ENV 1 REL		This sets the time needed for the voltage to reach zero from the moment the key is released.	
	ENV-1 Release Time			
94	ENV 2 REL			
	ENV-2 Release Time			
85	ENV 1 KEY	3	This changes the time required for an ENV curve to complete its curve (= ENV time). At OFF, all the pitches have the same ENV time. As the value is increased, higher keys have shorter ENV time. (Note 2)	
	ENV-1 Key Follow	2		
95	ENV 2 KEY	1		
	ENV-2 Key Follow	OFF		



D. NAMING

You can write a name (with up to 10 letters) to each patch program. The names of the 64 preset patches cannot be changed just like their tone colors, but the names of the 32 preprogrammed patches can be changed as you like.

Operation

① Push the Edit Button . The Display shows the name of the current tone color, with the 7th letter from the left flashing. This tells you that the 10 letters from the 7th are ready to be changed. Entering new letters will replace the old ones.

② Using the Tone Selector Buttons , Bank Selector Buttons , Key Mode Selector Buttons  and After Touch Buttons  which all have letters or marks at their down right corner, enter the name you like. The Display responds with the entered letter.

Use the Patch Chain Buttons   to move on to the next letter without changing the current one. Also, use the  Button to make a space.

*To change from the Edit mode to the Play mode, simply press the Edit Button , and the Display first responds as below.

EXIT EDIT MODE

Then the JX-8P is returned to the Play mode. Here, the Display responds as above with the tone number flashing. This tells you that the tone color and / or the name have been edited but not yet written, therefore selecting other patch program will automatically erase this patch. If you wish to retain the edited tone color, the following Writing procedure is required.

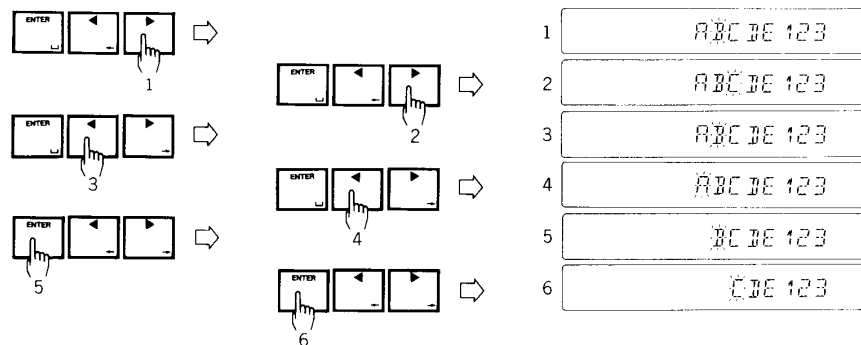

4. WRITE MODE

The Edit function does not automatically rewrite the existing program, unless the appropriate writing procedure is taken.

A. WRITING OPERATION

- ① When editing is completed, press the Write Button **Ⓜ**.

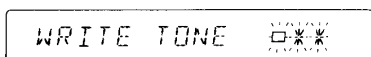

The bank and tone numbers flash.

- ② Set the Protect Switch on the JX-8P to the OFF position.
- ③ Select the Bank (Internal Memory or Cartridge) by using the Bank Selector Button.



- ④ Select the location for the edited program by using the Tone Selector Button.

Here, let's select 17.

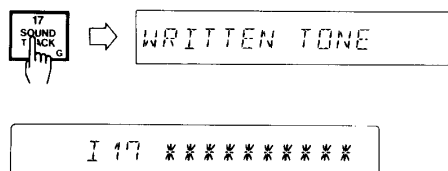

Now, the edited tone color is written into tone number 17. The JX-8P returns to the Play mode, and the Display reacts as above. If you have given a new name to the edited tone color, that name will be also shown in the Display.

- ⑤ Return the Protect Switch on the JX-8P to ON.

B. COPYING

By using the Writing function, you can copy a patch program to a new location. This applies to between the internal memory and Cartridge, or within the same memory area.

Operation

- ① With the JX-8P in the Play mode call the patch program you wish to copy, then push the Write Button **Ⓜ**.

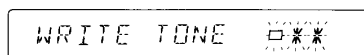

The flashing numbers are Bank and Tone numbers of the patch program which has been selected.

- ② To copy a patch program within the internal memory, or from the Cartridge memory to internal, set the Protect Switch on the JX-8P to OFF.

To copy a patch program within the Cartridge memory, or from the internal memory to the Cartridge, set the Protect Switch on the Cartridge to OFF.

- ③ Assign the Bank and Tone number of a new location.

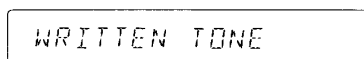

When the above is seen in the Display, copying is completed. And soon the JX-8P is automatically returned to the Play mode.

***Please note that the copying function erases the patch program previously written in that location.**

- ④ Return the Protect Switch to the ON position.



*To turn from the Write mode to the Play mode, simply press the Write Button **Ⓜ** again. The Display will show;





Then soon, the JX-8P is returned to the Play mode.

C. EDITING PATCH CHAIN

Writing a new patch replaces the previous one within the Patch Chain, which is seen at the left of the Display Window. To write a new patch is:

① By using the Patch Chain Button  and  ①, call the patch program you wish to replace with a new one.

② Select the patch number (tone color) you wish to write, by using the Bank Selector Button  and Tone Selector Button .

③ Adjust the controls for the Key Mode, After Touch, Bend Range, Portamento On/Off, Bend LFO Depth, Unison Detune and Portamento Time to your taste.

④ Set the Protect Switch on the JX-8P to OFF.

⑤ Press the Patch Chain Button  ⑤.

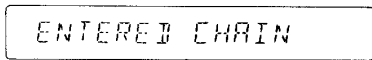

The Display reacts as shown above, then the JX-8P is returned to the Play mode.

⑥ Return the Protect Switch to the ON position.

e.g.)

If you press the  Button ⑤ while the Display shows Patch Chain number 4:

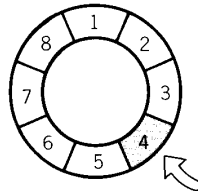

The new patch program is written here erasing the previous one.

If you want to change the Patch Chain number 5 consecutively, call 5, by using the  Button, and repeat procedure ② to ⑥.

5 MEMORY CARTRIDGE

The data in the internal memory of the JX-8P can be saved on the optional Memory cartridge (M-16C). Also, the saved data can be loaded from the cartridge to the JX-8P at any time later. This expands the memory capacity of the JX-8P practically twice as much.



*Before connecting or disconnecting the Cartridge, set the Protect Switch to ON.

*To set the data in the Cartridge memory ready to be used, press the Bank Selector Button "CARTRIDGE".

A. Saving and Loading

1) Saving on the Cartridge

① Set the Protect Switch on the cartridge to OFF.

② While holding the Write button , push the Copy Button . The Display responds as shown below, but **LOADING IS NOT DONE AT THIS STAGE.**

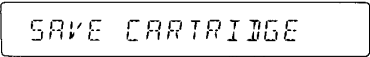

SAVE CARTRIDGE

③ Press the  Button again. When the Display responds as below, copying is done. And, soon, the JX-8P is automatically returned to the Play mode.

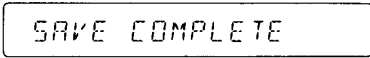



SAVE COMPLETE

④ Return the Protect Switch on the Cartridge to ON.

2) Loading to the JX-8P

① Set the Protect Switch on the JX-8P to OFF.

② While holding the Write button , push the Copy Button . The Display responds as shown below, but **LOADING IS NOT DONE AT THIS STAGE.**

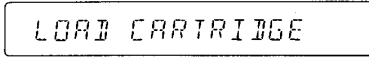

LOAD CARTRIDGE

③ Push the  Button again. When the Display responds as shown below, copying is done. And, the JX-8P is automatically returned to the Play mode.

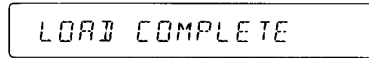

LOAD COMPLETE

④ Return the Protect Switch to the ON.

② Select the Function Number which value you want to change, by using the Tone Selector buttons 1 to 9. The Display will show the corresponding number, Function name, and its value or On/Off.

③ By using the Edit Knob **10**, change the value or On/Off.

2) Writing the edited setting of MIDI Function

Operation

① Set the Protect Switch on the JX-8P to OFF.

② Push the Write Button **11**. The Display responds as below, showing that writing is done. And the JX-8P is automatically returned to the Play mode.

WRITTEN MIDI

③ Return the Protect Switch on the JX-8P to ON.

Function Number	Display	Function Name	Description	Display Value	Factory Preset
11	MIDI CH	Channel	MIDI Channel Selection	1 - 16	1
12	P. CHANGE	Program Change	Patch Selection	ON/OFF	ON
13	A. TOUCH	After Touch	After Touch Value	ON/OFF	ON
14	P. BEND	Pitch Bend	Pitch Bend Value	ON/OFF	ON
15	MOD. WHEEL	Modulation Wheel	LFO Switch On/Off	ON/OFF	ON
16	PORTAMENTO	Portamento	Portamento Value	ON/OFF	ON
17	HOLD	Hold	Hold On/Off	ON/OFF	ON
18	VOLUME	Volume	Volume Value	ON/OFF	ON
21	POLY OMNI	Mode	This sets the JX-8P's mode.	ON/OFF	ON
22	MODE SEND	Mode Send	When this Function is on, even if the receiver is not able to set the mode on its own, the JX-8P can send the mode it selects to the receiver.	ON/OFF	OFF
23	DYNAMICS	Dynamics	This adjusts the intensity of the Dynamics effect caused by velocity sensitivity. At 99, the effect is its maximum, and no effect at zero.	00 - 99	99
24	LOCAL	Local	This Function (OFF) disconnects the keyboard section from the synthesizer section within the JX-8P.	ON/OFF	ON
25	ACTI SENS	Active Sense	When this Function is turned on, the JX-8P sends the signal that can prevent the receiver from getting out of control in case of accident such as accidental disconnection of the MIDI Cable, etc.	ON/OFF	ON
26	EXCLUSIVE	System Exclusive	When this Function is turned on, the JX-8P sends the Exclusive Message for connecting itself to a computer and other MIDI devices.	ON/OFF	OFF

ON = Sent, OFF = Not Sent

C. ERROR INDICATION

If you make a mistake during writing, saving or loading, the following Error indication will be seen in the Display.

1. MEMORY PROTECTED

MEMORY PROTECTED

This is seen when you have tried to do Writing or push the  button with the Protect Switch of the device to which data is to be written set to ON.

➔ Set the Protect Switch to OFF, and repeat the writing procedure.

2. SELECT BANK C I

SELECT BANK C I

This is seen when you have tried to write a tone color to the Preset Bank.

➔ Select the Bank (either Internal or Cartridge Memory), then repeat the Writing.

3. INSERT CARTRIDGE

INSERT CARTRIDGE

This is seen when you have tried to select the Cartridge Memory Bank without the Cartridge connected to the JX-8P.

➔ Insert the Memory Cartridge securely, then try again.

4 SPECIFICATIONS/OPTIONS

JX-8P : 6 Voice Synthesizer with Dynamics, After Touch

Keyboard

61 keys

Memory Capacity

Preset	64 Patch Programs
Internal Memory	32 Patch Programs
(Memory Cartridge)	32 Patch Programs

Edit

Parameters, Names
MIDI Functions, Master Tune

Panel Buttons

Tone Selector (1 to 32)
Bank Selector (Preset, Internal, Cartridge)
Patch Chain (Enter, ◀, ▶)
Key Mode (Poly, Unison, Solo)
After Touch (Vibrato, Brilliance, Volume)
Edit (Parameter, Name, MIDI, Master Tune)
Copy (Cartridge → Internal, Internal → Cartridge)
Write

Controls & Switches

Pitch Bender/LFO Lever
Bend Range Select
Portamento Time
Portamento On/Off
Edit
After Touch
Volume

Display Window

16 figures

Memory Cartridge Holder

Rear Panel

Output Jacks × 2
(Stereo/Mono 1/4 Standard Phone Jack, 5k Ω)
Output Level Switch (H/M/L)
Headphones Jack (8 Ω , Stereo)
Hold Pedal Jack (DP-2)
MIDI Connectors × 3
(In, Out, Thru — 5P DIN)
Programmer Connector (6P DIN)
Protect Switch
Power Switch

Dimensions

977 (W) × 375 (D) × 92 (H) mm
38-7/16" (W) × 14-3/4" (D) × 3-9/16" (H)

Weight

11.5kg
25 lb 60 oz

Consumption

25W

Accessories

Connections Cables × 2
Owner's Manual
MIDI guide book

Options

Programmer PG-800
Memory Cartridge M-16C
Pedal Switch DP-2
Carrying Case AB-2

PANEL DESCRIPTION OF THE PG-800 (OPTION)

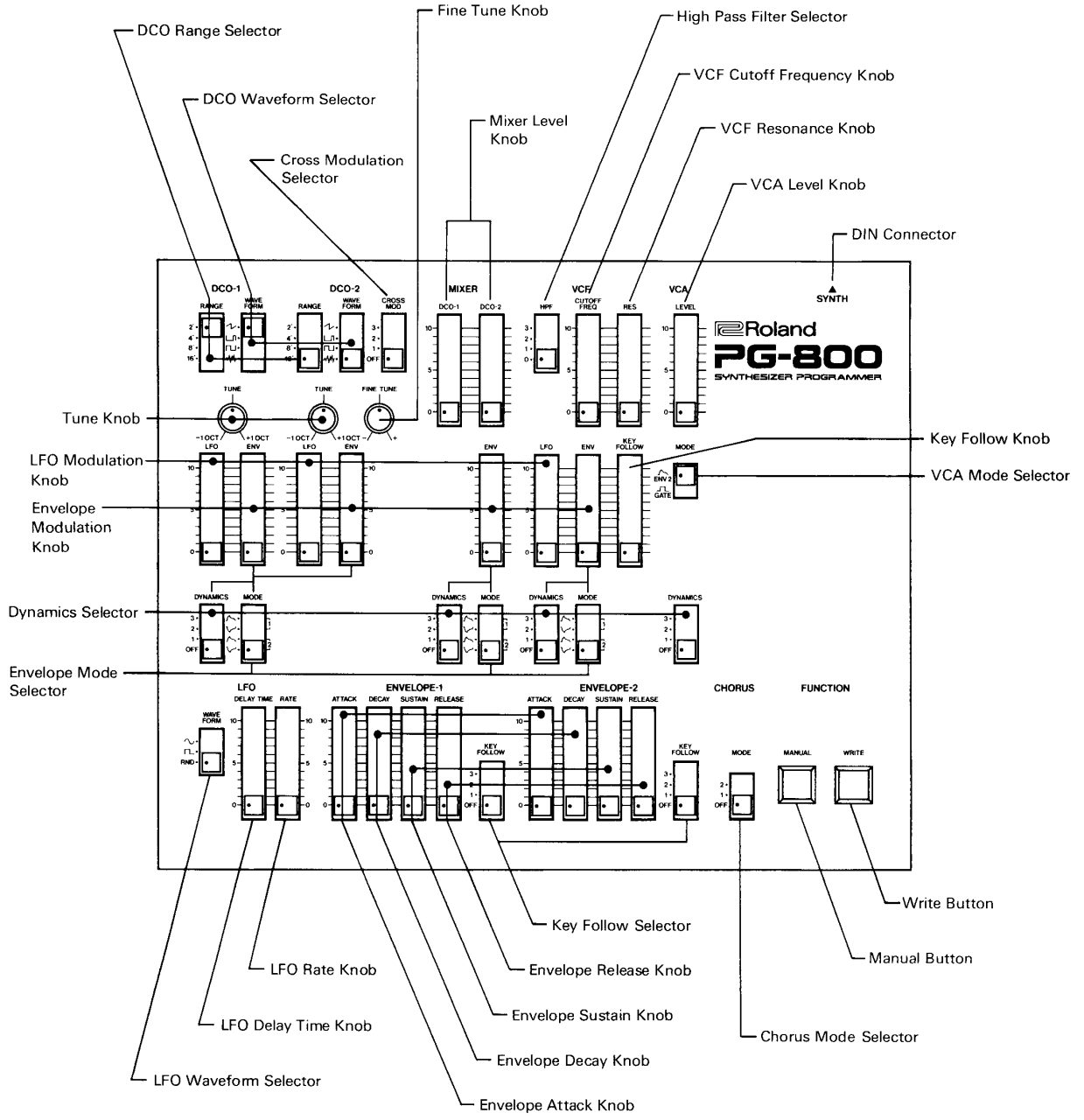

6-voice polyphonic synthesizer

MODEL **JX-8P** MIDI Implementation Chart

Function.....		Transmitted	Recognized	Remarks
Basic Channel	Default Changed	1 - 16 1 - 16	1 - 16 1 - 16	memorized
Mode	Default Messages Altered	Mode 1, 3 POLY, OMNI ON/OFF IO *****	Mode 1, 3 POLY, OMNI ON/OFF	memorized MONO ignored
Note Number	True voice	36 - 96 *****	0 - 127 21 - 108	
Velocity	Note ON Note OFF	○ ×	* ×	v = 1-127
After Touch	Key's Ch's	× *	× *	
Pitch Bender		*	*	
Control Change	1. 5 7 64 65	* * × * *	* * * * *	Modulation Portamento Time Volume Hold Portamento Switch
Prog Change	True #	* 0-127 *****	* 0 - 127 .. 0 - 127	
System Exclusive		*	*	
System Common	Song Pos Song Sel Tune	× × ×	× × ×	
System Real Time	Clock Commands	× ×	× ×	
Aux Messages	Local ON/OFF All Notes OFF Active Sense Reset	× ○ (123) * ×	○ ○ (123-127) * ×	Default ON
Notes	* : Can be set ○ or × manually, and memorized.			

Mode 1 : OMNI ON, POLY
Mode 3 : OMNI OFF, POLY

Mode 2 : OMNI ON, MONO
Mode 4 : OMNI OFF, MONO

○ : Yes
× : No

6-voice polyphonic synthesizer

MODEL JX-8P MIDI Implementation

1. TRANSMITTED DATA

Status	Second	Third	Description	
1001 nnnn	Okkk kkkk	0000 0000	Note OFF kkkkkkk = 36 - 96	
1001 nnnn	Okkk kkkk	Ovvv vvvv	Note ON kkkkkkk = 36 - 96 vvvvvvv = 1 - 127	
1011 nnnn	0000 0001	Ovvv vvvv	Modulation vvvvvvv = 0 - 127	*1
1011 nnnn	0000 0101	Ovvv vvvv	Portamento time vvvvvvv = 0 - 127	*1
1011 nnnn	0100 0000	Oxxx xxxx	Hold ON xxxxxxx = 1 - 127	*1
1011 nnnn	0100 0000	0000 0000	Hold OFF	*1
1011 nnnn	0100 0001	Oxxx xxxx	Portamento ON xxxxxxx = 1 - 127	*1
1011 nnnn	0100 0001	0000 0000	Portamento OFF	*1
1100 nnnn	Oppp pppp		Program Change ppppppp = 0 - 127	*1, *2
1101 nnnn	Ovvv vvvv		Channel After Touch vvvvvvv = 0 - 127	*1
1110 nnnn	0000 0000	Ovvv vvvv	Pitch Bender Change	*1
1011 nnnn	0111 1011	0000 0000	ALL NOTES OFF	
1011 nnnn	0111 1100	0000 0000	OMNI OFF	
1011 nnnn	0111 1101	0000 0000	OMNI ON	
1011 nnnn	0111 1111	0000 0000	POLY ON	
1111 1110			Active Sensing	*1

Notes :

- *1 Transmitted if the corresponding function switch is ON.
- *2 0 - 31 : Internal Memory
32 - 63 : Memory Cartridge
64 - 95 : Preset #1
96 - 127 : Preset #2

2. RECOGNIZED RECEIVE DATA

Status	Second	Third	Description	
1000 nnnn	Okkk kkkk	Ovvv vvvv	Note OFF, velocity ignored	
1001 nnnn	Okkk kkkk	0000 0000	Note OFF kkkkkkk = 0 - 127 (21 - 108)	*1
1001 nnnn	Okkk kkkk	Ovvv vvvv	Note ON kkkkkkk = 0 - 127 (21 - 108) vvvvvvv = 1 - 127	*1
1011 nnnn	0000 0001	Ovvv vvvv	Modulation vvvvvvv = 0 - 127	*3
1011 nnnn	0000 0101	Ovvv vvvv	Portamento time vvvvvvv = 0 - 127	*3
1011 nnnn	0000 0111	Ovvv vvvv	Volume vvvvvvv = 0 - 127	*3
1011 nnnn	0100 0000	Oxxx xxxx	Hold ON xxxxxxx = 1 - 127	*3
1011 nnnn	0100 0000	0000 0000	Hold OFF	*3
1011 nnnn	0100 0001	Oxxx xxxx	Portamento ON xxxxxxx = 1 - 127	*3
1011 nnnn	0100 0001	0000 0000	Portamento OFF	*3
1100 nnnn	Oppp pppp		Program Change ppppppp = 0 - 127	*3, *4
1101 nnnn	Ovvv vvvv		Channel After Touch vvvvvvv = 0 - 127	*3
1110 nnnn	0000 0000	Ovvv vvvv	Pitch Bender Change	*3
1011 nnnn	0111 1010	0000 0000	Local OFF	
1011 nnnn	0111 1010	0111 1111	Local ON	
1011 nnnn	0111 1011	0000 0000	ALL NOTES OFF	
1011 nnnn	0111 1100	0000 0000	OMNI OFF	*2
1011 nnnn	0111 1101	0000 0000	OMNI ON	*2
1011 nnnn	0111 1110	0000 0000	ALL NOTES OFF (MONO ON)	*2
1011 nnnn	0111 1111	0000 0000	POLY ON	*2
1111 1110			Active Sensing	*3

Notes :

- *1 Note numbers outside of the range 21 - 108 are transposed to the nearest octave inside this range.
- *2 Mode Messages (123 - 127) are also recognized as ALL NOTES OFF. MONO ON messages are ignored.
- *3 Received if the corresponding function switch is ON.
- *4 0 - 31 : Internal Memory
32 - 63 : Memory Cartridge
64 - 95 : Preset #1
96 - 127 : Preset #2

When the memory cartridge is not connected, 32 thru 63 are ignored.

3. TRANSMITTED EXCLUSIVE MESSAGES

3.1 All Tone Parameters (APR)
When the 'Tone Button' is pressed.

Byte	Description
a 1111 0000	Exclusive status
b 0100 0001	Roland ID #
c 0011 0101	Operation code = APR (all parameters)
d 0000 nnnn	Unit # = MIDI basic channel, nnnn = 0 - 15 where nnnn + 1 = channel #
e 0010 0001	Format type (JX-8P)
f 0010 0000	Level # = 1
g 0000 0001	Group #
h 0vvv vvvv	Value (0 - 127)
:	In sequence (59 byte total)
i 1111 0111	End of System Exclusive

3.2 Individual Tone Parameter (IPR)
When the Parameter is changed.

Byte	Description
a 1111 0000	Exclusive status
b 0100 0001	Roland ID #
c 0011 0110	Operation code = IPR (individual parameter)
d 0000 nnnn	Unit # = MIDI basic channel, nnnn = 0 - 15 where nnnn + 1 = channel #
e 0010 0001	Format type
f 0010 0000	Level # = 1
g 0000 0001	Group #
h 0ppp pppp	Parameter # (0 - 58)
i 0vvv vvvv	Value (0 - 127)
:	h and i (respectively)
j 1111 0111	End of System Exclusive

Note :

Parameter #	Function	Value
0-9	NAME-0..9	In ASCII
10	Undefined	
11	DCO-1 RANGE	0 - 31 = 16' 32 - 63 = 8' 64 - 95 = 4' 96 - 127 = 2'
12	DCO-1 WAVEFORM	0 - 31 = Noise 32 - 63 = Sawtooth Wave 64 - 95 = Pulse Wave 96 - 127 = Square Wave
13	DCO-1 TUNE	0 - 127 (-1 oct -- +1 oct)
14	DCO-1 LFO MOD DEPTH	0 - 127
15	DCO-1 ENV MOD DEPTH	0 - 127
16	DCO-2 RANGE	0 - 31 = 16' 32 - 63 = 8' 64 - 95 = 4' 96 - 127 = 2'
17	DCO-2 WAVEFORM	0 - 31 = Noise 32 - 63 = Sawtooth Wave 64 - 95 = Pulse Wave 96 - 127 = Square Wave
18	DCO-2 CROSSMOD	0 - 31 = OFF 32 - 63 = SYNC 1 64 - 95 = SYNC 2 96 - 127 = XMOD (cross modulation)
19	DCO-2 TUNE	0 - 127 (-1 oct -- +1 oct)
20	DCO-2 FINE TUNE	0 - 127
21	DCO-2 LFO MOD DEPTH	0 - 127 (-50 cent -- +50 cent)
22	DCO-1 ENV MOD DEPTH	0 - 127
23	Undefined	
24	Undefined	
25	Undefined	
26	DCO DYNAMICS	0 - 31 = OFF 32 - 63 = 1 64 - 95 = 2 96 - 127 = 3
27	DCO ENV MODE	0 - 31 = ENV-2 Inverted 32 - 63 = ENV-2 Normal 64 - 95 = ENV-1 Inverted 96 - 127 = ENV-1 Normal
28	MIXER DCO-1	0 - 127
29	MIXER DCO-2	0 - 127
30	MIXER ENV MOD DEPTH	0 - 127
31	MIXER DYNAMICS	0 - 31 = OFF 32 - 63 = 1 64 - 95 = 2 96 - 127 = 3
32	MIXER ENV MODE	0 - 31 = ENV-2 Inverted 32 - 63 = ENV-2 Normal 64 - 95 = ENV-1 Inverted 96 - 127 = ENV-1 Normal
33	HPF CUTOFF FREQ	0 - 31 = 0 32 - 63 = 1 64 - 95 = 2 96 - 127 = 3
34	VCF CUTOFF FREQ	0 - 127
35	VCF RESONANCE	0 - 127
36	VCF LFO MOD DEPTH	0 - 127
37	VCF ENV MOD DEPTH	0 - 127
38	VCF KEY FOLLOW	0 - 127
39	VCF DYNAMICS	0 - 31 = OFF 32 - 63 = 1 64 - 95 = 2 96 - 127 = 3
40	VCF ENV MODE	0 - 31 = ENV-2 Inverted 32 - 63 = ENV-2 Normal 64 - 95 = ENV-1 Inverted 96 - 127 = ENV-1 Normal
41	VCA LEVEL	0 - 127
42	VCA DYNAMICS	0 - 31 = OFF 32 - 63 = 1 64 - 95 = 2 96 - 127 = 3

```

43 CHORUS          0 - 31 = OFF
                  32 - 63 = 1
                  64 - 127 = 2
44 LFO WAVEFORM   0 - 31 = Random
                  32 - 63 = Square Wave
                  64 - 127 = Triangle Wave
45 LFO DELAY TIME 0 - 127
46 LFO RATE       0 - 127
47 ENV-1 ATTACK TIME 0 - 127
48 ENV-1 DECAY TIME 0 - 127
49 ENV-1 SUSTAIN LEVEL 0 - 127
50 ENV-1 RELEASE TIME 0 - 127
51 ENV-1 KEY FOLLOW 0 - 31 = OFF
                  32 - 63 = 1
                  64 - 95 = 2
                  96 - 127 = 3
52 ENV-2 ATTACK TIME 0 - 127
53 ENV-2 DECAY TIME 0 - 127
54 ENV-2 SUSTAIN LEVEL 0 - 127
55 ENV-2 RELEASE TIME 0 - 127
56 ENV-2 KEY FOLLOW 0 - 31 = OFF
                  32 - 63 = 1
                  64 - 95 = 2
                  96 - 127 = 3
57 Undefined
58 VCA ENV MODE   0 - 63 = Gate
                  64 - 127 = ENV-2 Normal

```

3.3 All Patch Parameters (APR)
When the 'Patch Chain' button is pressed.

Byte	Description
a 1111 0000	Exclusive status
b 0100 0001	Roland ID #
c 0011 0101	Operation code = APR (all parameters)
d 0000 nnnn	Unit # = MIDI basic channel, nnnn = 0 - 15 where nnnn + 1 = channel #
e 0010 0001	Format type (JX-8P)
f 0011 0000	Level # = 2
g 0000 0001	Group #
h 0vvv vvvv	Value (0 - 127)
:	In sequence (8 byte total)
i 1111 0111	End of System Exclusive

3.4 Individual Patch Parameter (IPR)
When the Patch Parameter is changed.

Byte	Description
a 1111 0000	Exclusive status
b 0100 0001	Roland ID #
c 0011 0110	Operation code = IPR (Individual parameter)
d 0000 nnnn	Unit # = MIDI basic channel, nnnn = 0 - 15 where nnnn + 1 = channel #
e 0010 0001	Format type
f 0011 0000	Level # = 2
g 0000 0001	Group #
h 0ppp pppp	Parameter # (0 - 8)
i 0vvv vvvv	Value (0 - 127)
:	h and i (repetitively)
j 1111 0111	End of System Exclusive

Note :

Parameter #	Function	Value
0	BEND RANGE	0 = 2 Semi Tones 32 = 3 Semi Tones 64 = 4 Semi Tones 96 = 7 Semi Tones
1	PORTAMENTO TIME	0 - 127
2	PORTAMENTO SW	0 = OFF 64 = ON
3	ASSIGN MODE SELECT	0 = Poly-1 1 = Unison-1 2 = Solo-1 4 = Poly-2 5 = Unison-2 6 = Solo-2
4	AFTER TOUCH SELECT	0 = OFF 1 = Vibrato ON 2 = Brilliance ON 4 = Volume ON
5	BEND LFO DEPTH	0 - 127
6	UNISON DETUNE	0 - 127
7	TONE NUMBER	0 - 31
8	BANK NUMBER	0 - 3

4. RECOGNIZED EXCLUSIVE MESSAGES

4.1 Program number (PCR)

Byte	Description
a 1111 0000	Exclusive status
b 0100 0001	Roland ID #
c 0011 0100	Operation code = PCR (program number)
d 0000 nnnn	Unit # = MIDI basic channel, nnnn = 0 - 15 where nnnn + 1 = channel #
e 0010 0001	Format type (JX-8P)
f 0010 0000	Level # = 1
g 0000 0001	Group #
h 0xxx xxxx	Extension of program #
i 0ppp pppp	Program # ('Program Number')
j 0fff ffff	Function #
k 1111 0111	End of System Exclusive

Note :

Write data to memory with the program #
xxx xxxx = 0
fff ffff = 2
Manual mode Flag
xxx xxxx = 127
fff ffff = 0

4.2 Other Exclusive messages described in section 3.