

 Roland

---

**MIDI POLYPHONIC SYNTHESIZER**

---

**SUPER JX**

---

**JX-10**

---

Owner's Manual

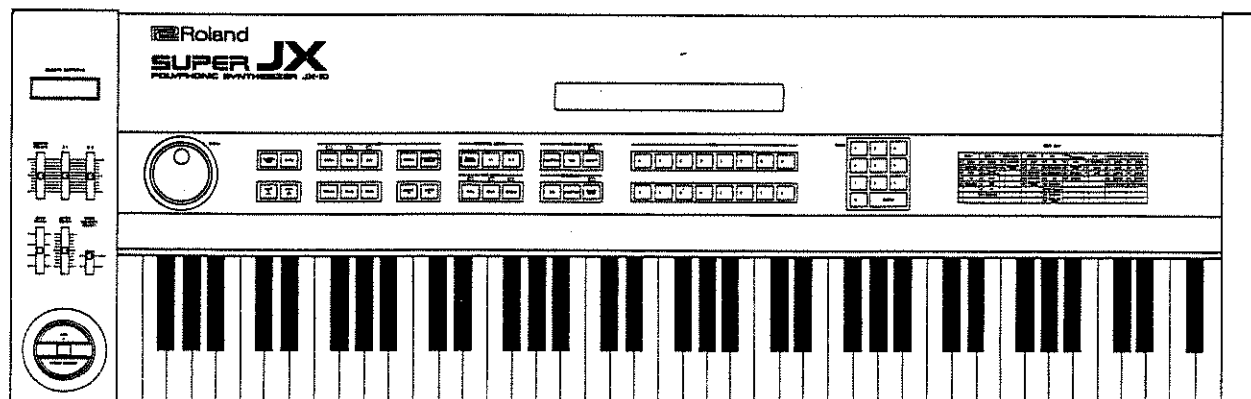

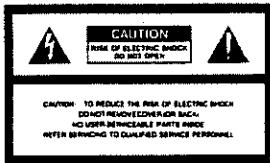

The lightning flash with arrowhead symbol, within an equilateral triangle, is intended to alert the user to the presence of un-insulated "dangerous voltage" within the product's enclosure that may be of sufficient magnitude to constitute a risk of electric shock to persons.



The exclamation point within an equilateral triangle is intended to alert the user to the presence of important operating and maintenance (servicing) instructions in the literature accompanying the product.

INSTRUCTIONS PERTAINING TO A RISK OF FIRE, ELECTRIC SHOCK OR INJURY TO PERSONS.

## IMPORTANT SAFETY INSTRUCTIONS

**WARNING** When using electric products, basic precautions should always be followed, including the following:

1. Read all the instructions before using the product.
2. Do not use this product near water- for example, near a bathtub, washbowl, kitchen sink, in a wet basement, or near a swimming pool, or the like.
3. This product should be used only with a cart or stand that is recommended by the manufacturer.
4. This product, either alone or in combination with an amplifier and headphones or speakers, may be capable of producing sound levels that could cause permanent hearing loss. Do not operate for a long period of time at a high volume level or at level that is uncomfortable. If you experience any hearing loss or ringing in the ears, you should consult an audiologist.
5. The product should be located so that its location or position does not interfere with its proper ventilation.
6. The product should be located away from heat sources such as radiators, heat registers or other products that produce heat.
7. The product should avoid using in where it may be affected by dust.
8. The product should be connected to a power supply only of the type described in the operating instructions or as marked on the product.
9. The power-supply cord of the product should be unplugged from the outlet when left unused for a long period of time.
10. Do not tread on the power-supply cord.
11. Do not pull the cord but hold the plug when unplugging.
12. When setting up with any other instruments, the procedure should be followed in accordance with instruction manual.
13. Care should be taken so that objects do not fall and liquids are not spilled into the enclosure through openings.
14. The product should be serviced by qualified service personnel when:
  - A: The power-supply cord or the plug has been damaged; or
  - B: Objects have fallen, or liquid has been spilled into the product; or
  - C: The product has been exposed to rain; or
  - D: The product does not appear to operate normally or exhibits a marked change in performance; or
  - E: The product has been dropped, or the enclosure damaged.
15. Do not attempt to service the product beyond that described in the user-maintenance instructions. All other servicing should be referred to qualified service personnel.

## SAVE THESE INSTRUCTIONS

### ADVARSEL !

Lithiumbatteri. Eksplosionsfare.  
Udskiftning må kun foretages af en sagkyndig,  
og som beskrevet i servicemanual.

### VARNING !

Lithiumbatteri. Explosionsrisk.  
Får endast bytas av behörig servicetekniker.  
Se instruktioner i servicemanualen.

### ADVARSEL !

Lithiumbatteri. Fare for eksplotion.  
Må bare skiftes av kvalifisert tekniker som  
beskrevet i servicemanualen.

### VAROITUS !

Lithiumparisto. Räjähdyksvaara.  
Pariston saa vaihtaa ainoastaan  
alan ammottimies.

### WARNING

THIS APPARATUS MUST BE EARTH GROUNDED.

The three conductors of the mains lead attached to this apparatus are identified with color as shown in the table below, together with the matching terminal on the UK type power plug. When connecting the mains lead to a plug, be sure to connect each conductor to the correct terminal, as indicated.  
"This instruction applies to the product for United Kingdom."

MAINS LEADS		PLUG
Conductor	Color	Mark on the matching terminal
Live	Brown	Red or letter L
Neutral	Blue	Black or letter N
Grounding	Green-Yellow	Green, Green-Yellow, letter E or symbol

#### Bescheinigung des Herstellers /Importeurs

Hiermit wird bescheinigt, daß der/die/das

**ROLAND PROGRAMMABLE POLYPHONIC SYNTHESIZER JX-10**

(Gerät, Typ, Bezeichnung)

in Übereinstimmung mit den Bestimmungen der

Armtsbl. Vfg 1046 / 1984

(Arbeitsverteilung)

funk-entstört ist.

Der Deutschen Bundespost wurde das Inverkehrbringen dieses Gerätes angezeigt und die Berechtigung zur Überprüfung der Serie auf Einhaltung der Bestimmungen eingeräumt.

Roland Corporation Osaka / Japan

Name des Herstellers/Importeurs

#### RADIO AND TELEVISION INTERFERENCE

**Warning** - This equipment has been verified to comply with the limits for a Class B computing device, pursuant to Subpart J, of Part 15, of FCC rules. Operation with non-certified or non-verified equipment is likely to result in interference to radio and TV reception.

The equipment described in this manual generates and uses radio-frequency energy. If it is not installed and used properly, this use, in strict accordance with our instructions, it may cause interference with radio and television reception.

This equipment has been tested and found to comply with the limits for a Class B computing device in accordance with the specifications in Subpart J, of Part 15, of FCC Rules. These rules are designed to provide reasonable protection against such interference in a residential installation. However, there is no guarantee that the interference will not occur in a particular installation. If this equipment does cause interference to radio or television reception, which can be determined by turning the equipment on and off, the user is encouraged to try to correct the interference by the following measures:

- Disconnect other devices and their input/output cables one at a time. If the interference stops, it is caused by either the other device or its I/O cable.
- These devices usually require Roland designated shielded I/O cables. For Roland devices, you can obtain the proper shielded cable from your dealer. For non-Roland devices, contact the manufacturer or dealer for assistance.
- If your equipment does cause interference to radio or television reception, you can try to correct the interference by using one or more of the following measures:
  - Turn the TV or radio antenna until the interference stops.
  - Move the equipment to one side or the other of the TV or radio.
  - Move the equipment farther away from the TV or radio.
  - Plug the equipment into an outlet that is on a different circuit than the TV or radio. (That is, make certain the equipment and the radio or television set are on circuits controlled by different circuit breakers or fuses.)
  - Consider installing a rooftop television antenna with coaxial cable lead-in between the antenna and TV.

If necessary, you should consult your dealer or an experienced radiotelevision technician for additional suggestions. You may find helpful the following booklet prepared by the Federal Communications Commission:

"How to Identify and Resolve Radio-TV Interference Problems"

This booklet is available from the U.S. Government Printing Office, Washington, D.C., 20402, Stock No. 504-000-0004-4.

Please read the separate volume "MIDI", before reading this owner's manual.

Copyright © 1986 by ROLAND CORPORATION

All rights reserved. No part of this publication may be reproduced in any form without the written permission of ROLAND CORPORATION.

# 1 PANEL DESCRIPTION

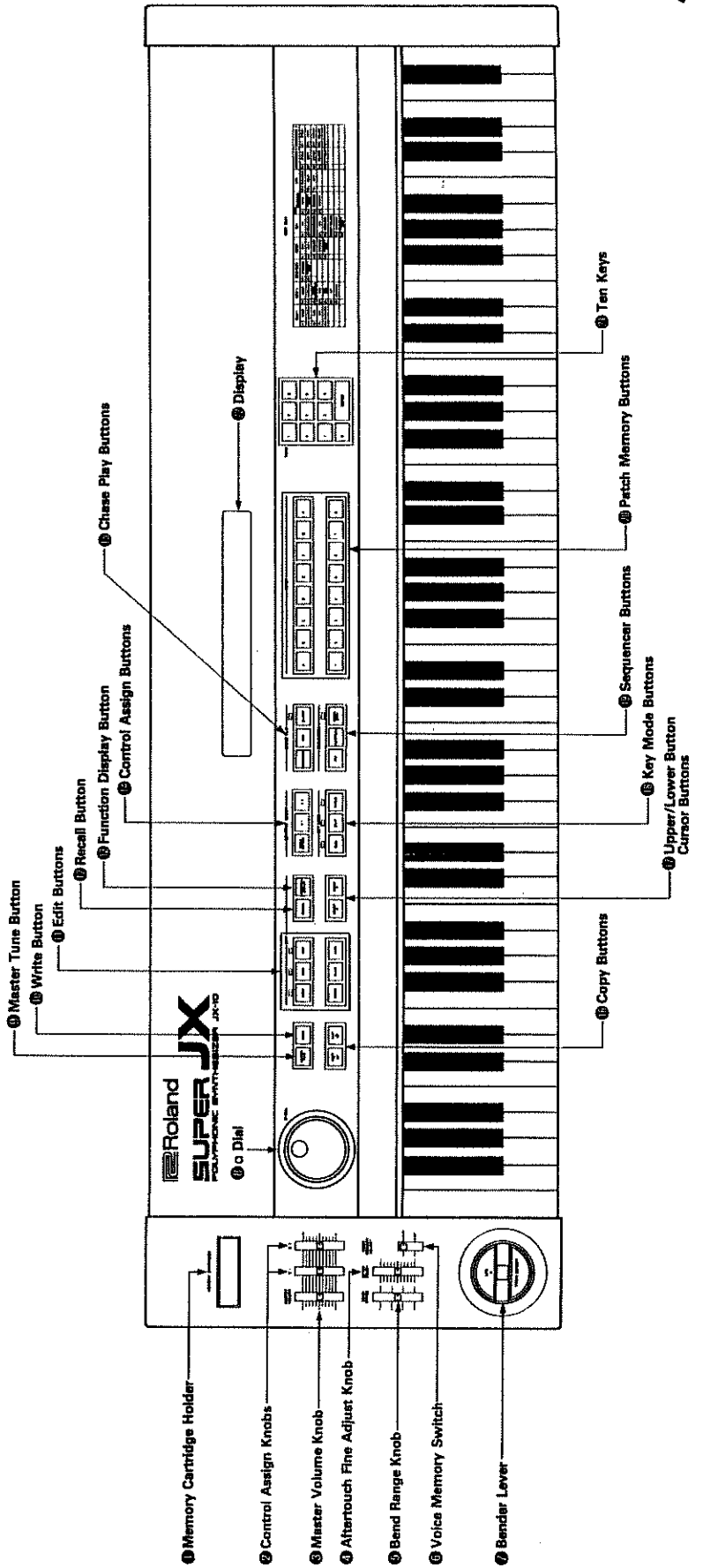
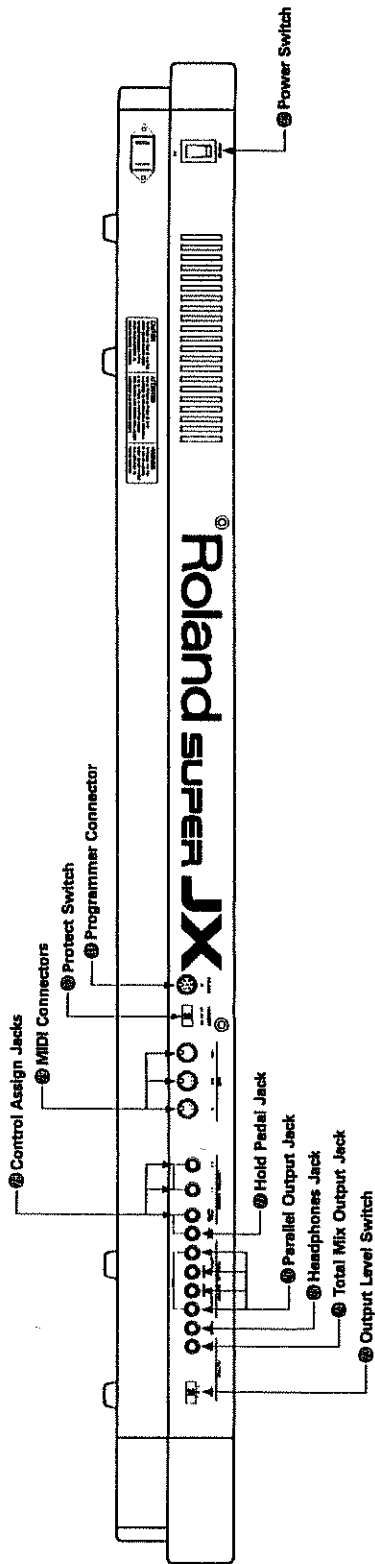



■ The Roland JX-10 is fully programmable 12 voice polyphonic synthesizer. Various sounds and performance control functions can be stored ready to be used.

- The JX-10 features the memory capacity that can retain up to 64 different programs (= Patch Memory) which are the combinations of sounds and performance control functions.
- Any of the Patch Memory can be called just by pushing appropriate buttons.
- The Patch Memory you have written into memory can be easily edited whenever you like.
- The JX-10 contains the sequencer which can record and playback what you play on the keyboard.
- Using the Memory Cartridges, it is possible to expand the memory capacity and to save the sequencer data.
- The 76 key keyboard and MIDI functions make the JX-10 an excellent mother keyboard.

## CONTENTS

1	PANEL DESCRIPTION .....	3
2	CONNECTIONS .....	6
3	OUTLINE OF THE JX-10 .....	8
4	OPERATION .....	10
1.	Selecting a Patch Memory .....	11
2.	Functions of the Control Knobs .....	12
3.	Control Assign .....	14
4.	Quick Editing of Patch Memory .....	16
a.	Key Mode .....	16
b.	Tone Number .....	18
c.	Chase Play .....	19
5.	Sequencer .....	21
a.	Recording Sequencer Data .....	21
b.	Playing the Recorded Data .....	22
6.	Edit .....	24
a.	Editing a Patch Memory .....	24
b.	Editing a Tone .....	31
c.	Recalling a Tone .....	40
7.	Writing into Memory .....	41
a.	Writing a Patch Memory .....	41
b.	Writing a Tone .....	42
c.	Naming .....	43
d.	Writing the Whole Data .....	46
8.	Memory Cartridge .....	47
a.	Copying the Entire Data (All Patch Memories and 50 Tones) ...	47
b.	Copying a Patch Memory .....	49
c.	Copying a Tone .....	51
9.	Other Useful Functions .....	53
a.	Tuning .....	53
b.	Function Display .....	54
c.	Error Messages .....	55
10.	MIDI .....	56
a.	Receiving and Transmitting MIDI .....	57
b.	MIDI Functions available for a Patch Memory .....	60
5	SPECIFICATIONS .....	67

## IMPORTANT NOTES

- The appropriate power supply for this unit is shown on its name plate. Please make sure that the line voltage in your country meets the requirement.
- Please do not use the same socket used for any noise generating device (such as motor, variable lighting system).
- This unit might not work properly if turned on immediately after turned off. If this happens, simply turn it off and turn it on again a few seconds later.
- Before setting up this unit with other devices, turn all of them off.
- This unit might generate slight heat while operating, but there is no need to worry about it.
- Use a soft cloth and clean only with a mild detergent.
- Do not use solvents such as paint thinner.
- Avoid using this unit in excessive heat or humidity or where it may be affected by direct sunlight or dust.
- Save the necessary data on a cartridge or make data memo before having the JX-10 repaired, in case it should happen to be accidentally erased.
- Before connecting or disconnecting the cartridge, be sure to set the Protect Switch to the On position. To prevent the accidental loss of the data, never move the Protect Switch to the Off position, unless it is specifically instructed in the manual.

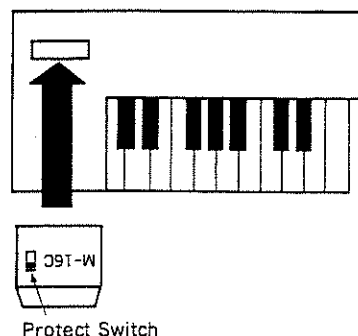

## 2 CONNECTIONS

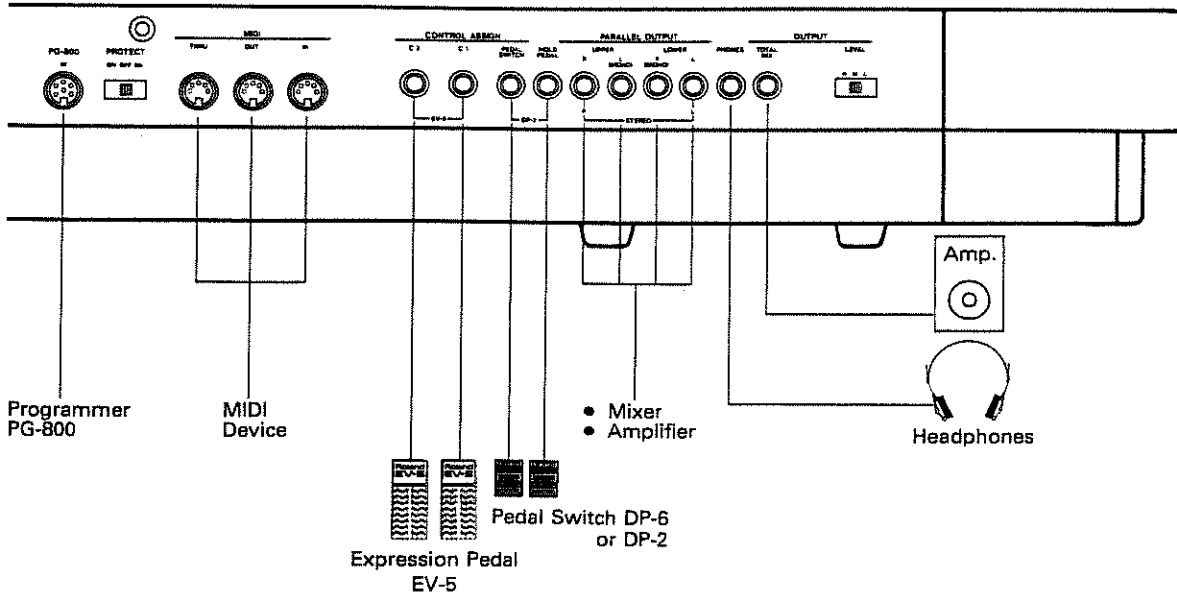

### Example Setups

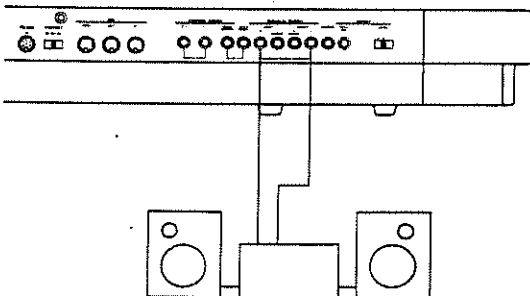
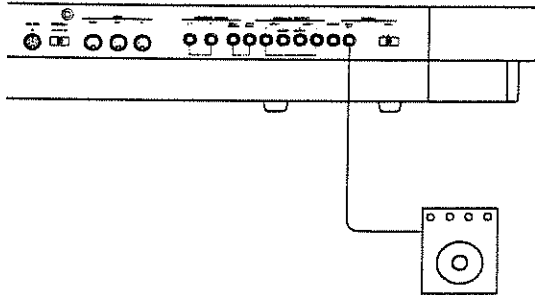

### 1. Total Mix Output Jack 24

Connect this to the amplifier. To make the best use of the JX-10, use the amplifier and speaker of wide frequency response and dynamic range such as keyboard amplifier.

### 2. Parallel Output Jacks 26

These are also for connecting amplifiers. Different ways of connections will make various sound effects.

The following shows several different ways for using the Output Jacks.

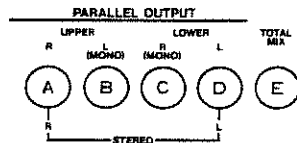

Connection	Jack	Output Power
1 Jack	E	Monaural Output
2 Jacks	A D	Mixed Output of Upper and Lower
	B C	B: Monaural Output of Upper C: Monaural Output of Lower
	A B	Stereo Output of Upper
	C D	Stereo Output of Lower
4 Jacks	A B C D	Stereo Output of Upper and Lower

\* When the JX-10 is set to the Whole mode, connecting a stereo amplifier to the UPPER MONO and LOWER MONO of the Parallel Output Jacks 26 (output jacks C and D shown in the above picture) will cause the sounds to be output irregularly through L or R. It is normal for this unit to behave like this.

### 3. Output Level Switch 28

Use this switch to select the output level depending on the amplifier connected to the Total Mix Output.

\* This switch does not work on the signal sent from the Parallel Output Jack.

### 4. Headphones Jack 25

Connect stereo headphones to this jack.

### 5. Hold Pedal Jack 27

By connecting the optional pedal switch DP-6 or DP-2, the Hold effect can be turned on or off by pressing the pedal. "Hold" is the effect of keeping the sound even after the key is released.

### 6. MIDI Connector 29

This is for connecting to other MIDI device using the MIDI/SYNC cable (optional).

### 7. Programmer Connector 31

Connect this to the programmer PG-800 (optional) using the supplied 6P DIN cord.

### 8. Protect Switch 30

Always make sure that this switch is set to the ON position to protect the data in the JX-10, except when saving or loading data.

### 9. Control Assign Jack 23

Use this jack when assigning the Control Changes with the expression pedal or pedal switch.

## **3** OUTLINE OF THE JX-10

The JX-10 features the functions that are quite different from those of the past synthesizers. So, it is very important to understand the functions. Read the following explanation, then go to "**4** OPERATION".

1. The JX-10 retains 100 different sounds (**Tones**) – 50 of them can be rewritten, other 50 non-volatile – and more, the 64 combinations of the Tones and various performance control functions (this combination is called **Patch Memory**). That is, a Patch Memory consists of a Tone or a pair of Tones and performance control functions which we call **Factors** in this manual. Normally, to change sounds during live performance, select a different Patch Memory.

(See page 11 "1. Selecting a Patch Memory".)

2. The Factors of the Patch Memory can be edited easily whenever you want.

(See page 24 "a. Editing a Patch Memory".)

3. The Tone of a Patch Memory can be edited just like you would do on a usual synthesizer, A tone consists of various parameters, and a tone is edited by changing these parameters.

(See page 31 "b. Editing a Tone".)

4. To write the edited Patch Memory into the JX-10's memory, take an appropriate writing procedure.

(See "a. Writing a Patch Memory" on page 41.)

(See "b. Writing a Tone" on page 42.)

5. By using the supplied Memory Cartridge (M-64C), the following data transfer is possible.

- a. **Saving each Patch Memory or Tone to the memory cartridge and loading it back to the JX-10.**

- b. **Saving the entire data (50 Tones and 64 Patch Memories) on the JX-10 to the memory cartridge and loading it back to the JX-10.**

(See page 47 "8. Memory Cartridge".)

6. The sequencer data can be saved on the supplied Memory Cartridge (M-16C). By using one more Memory Cartridge M-64C which is optional, you can save the data four times more.

(See page 21 "5. Sequencer".)

7. All the Patch Memories and Tones have their own names which can be changed as you like.

(See page 43 "c. Naming".)

8. The JX-10 features the MIDI functions necessary for operating or being operated with other MIDI devices. The MIDI functions can be changed according to your requirement.

(See page 56 "10. MIDI".)

9. To make the above operations quicker and easier, the JX-10 has a display window. If the operation is wrong, the Display will respond with error messages.

(See page 55 "c. Error Message".)



# JX-10 Basic Operation Table

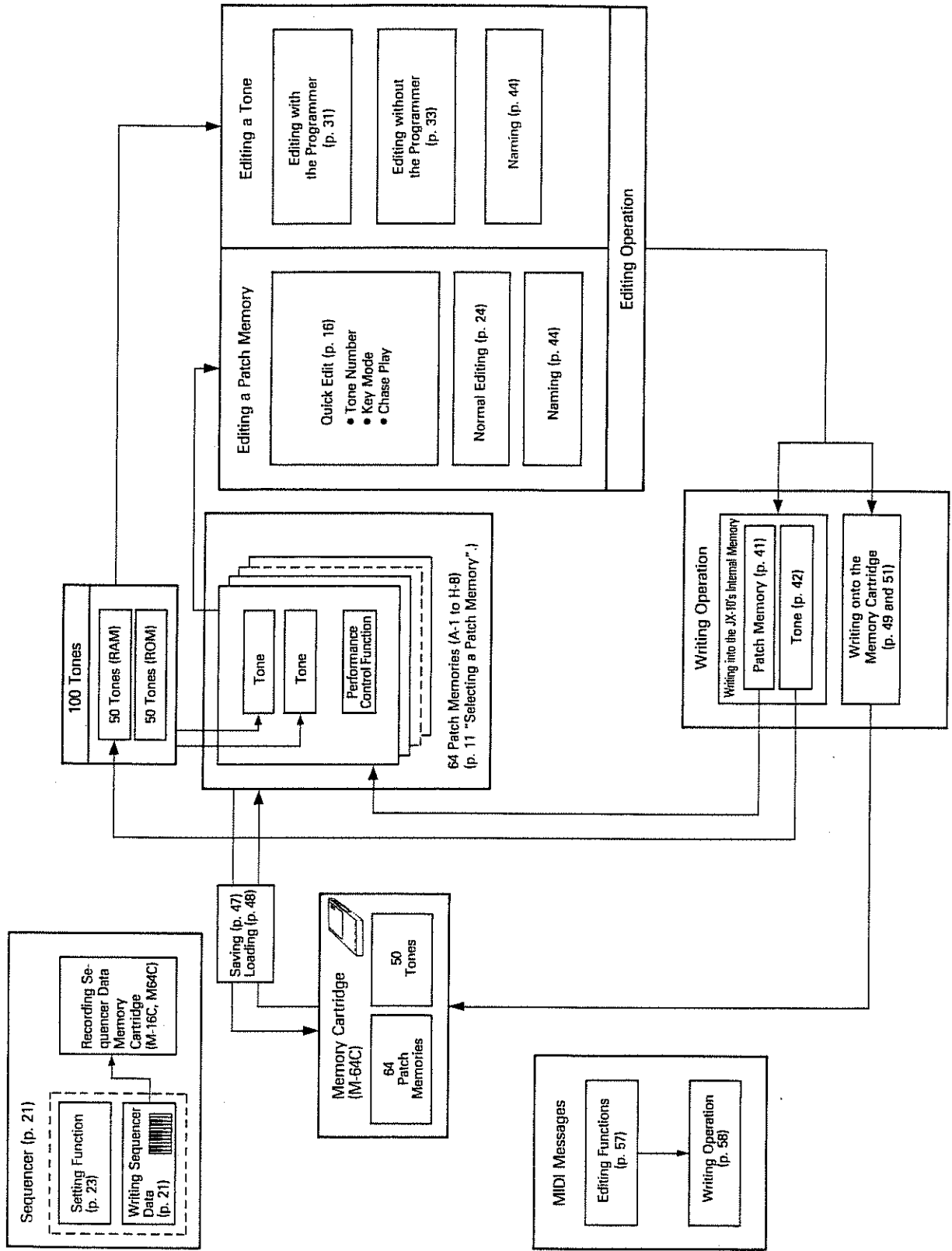

## 4 OPERATION

Set up the JX-10 with the external devices such as amplifier and speaker, then switch it on, and the JX-10 is ready to be played with any of the 64 Patch Memories.

A Patch Memory is made of one or a pair of the 100 different Tones and various performance control functions such as Split Point, Bender Sensitivity, etc.

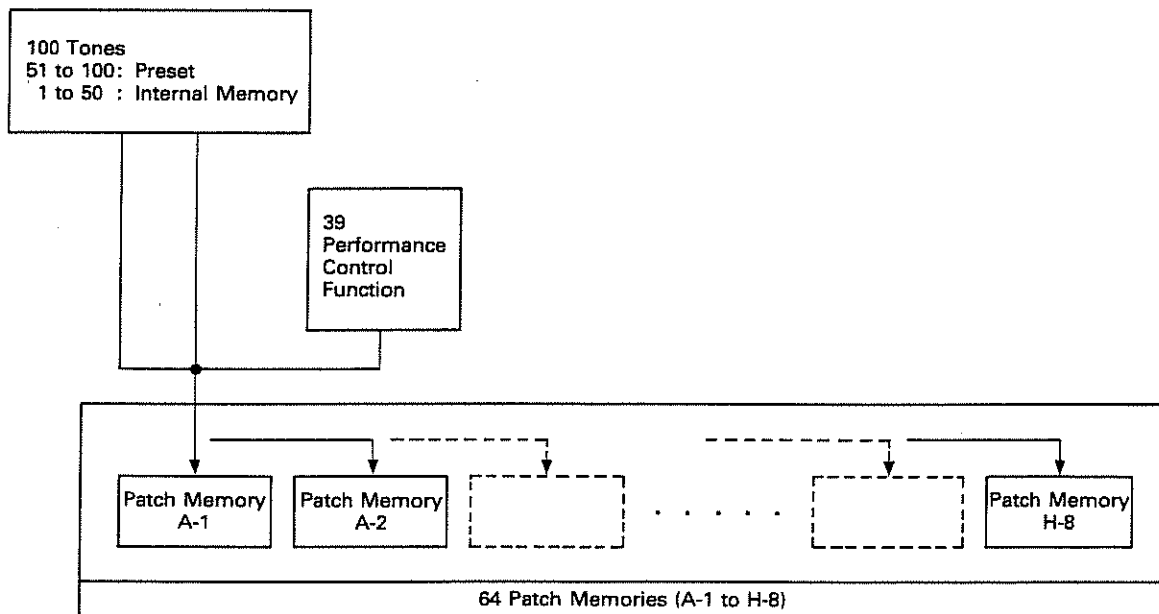

# 1. Selecting a Patch Memory

Make sure that the connections are made securely and correctly, then switch the JX-10 on.

The Display will show "ROLAND JX-10" for several seconds, then change to as below.

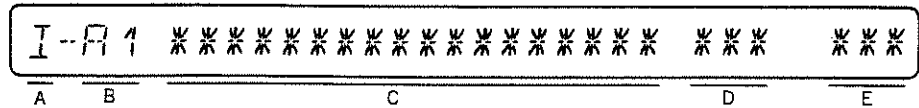

**A** : The 64 Patch Memories are stored either in the JX-10's internal memory or on the Memory Cartridge (M-64C). The display here shows whether the Patch Memory currently selected is in the JX-10 or on the Cartridge.

**I** : Internal Memory of the JX-10

**[** : Cartridge Memory

**B** : The 64 Patch Memories are stored in the locations of 8 Banks (1 to 8) and the Numbers (1 to 8). The display here shows the Bank and the Number of the Patch Memory.

**C** : Each Patch Memory can be named with up to 18 characters (this is called Patch Name.) Here, the patch name is displayed.

**D, E** : The numbers 1 to 100 are assigned to the 100 Tones in the JX-10's memory. The numbers of the Tones used for the Patch Memory currently selected are displayed here. The Tone number of the lower section of the keyboard is shown at D and that of the upper section is shown at E.

\* What are shown at A (Memory Mode) and at B (Bank and Number of the Patch Memory) are always displayed there except for in the Writing (see page 41.) and Master Tuning (see page 53.) modes.

To select a Patch Memory, assign the Bank and Number by using the Patch Memory Buttons ⑩.

\* The JX-10 is designed to produce no sound while you are changing Patch Memories. This serves to mute the noise which otherwise would be heard. If you do not like cutting sound, instead of changing Patch Memories, change the Tones (See page 18 "Selecting a Tone Number"). In this way, you can call the sound you like without any silence at all.

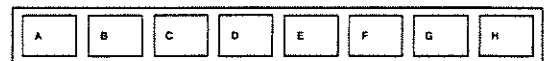

Example

Push B → 3 ⇒ I-B3

Push 6 ⇒ I-B6

Push G ⇒ I-G6

## 2. Functions of the Control Knobs

The following controls can be operated even while you are playing the JX-10.

### a. Control Assign Knob ②

Each of these two knobs can be used for controlling the performance control function you select with the Control Assign Button. (See page 14 "3. Control Assign".)

### b. Bender Lever ⑦

This Bender Lever can be used during live performance for creating guitar's choking-like effect. The left and right extremes of movement create the same amount of pitch bending effect. The maximum effect of the bender can be selected with the Bend Range Switch: major 2nd, minor 3rd, major 3rd or perfect 5th higher or lower.

Pushing this lever forward will create the vibrato effect. When the tone you are using has already taken in a vibrato effect, the effect will be deepened.

### c. Aftertouch Fine Adjust Knob ④

The Aftertouch effect is the sound's alteration obtained by pressing the key stronger after playing it in a normal manner. The JX-10's aftertouch effect works on the Vibrato, Brilliance and Volume.

**Vibrato:** The depth of the vibrato effect is deepened.

**Brilliance:** The tone will become brighter.

**Volume:** The volume of the sound will increase.

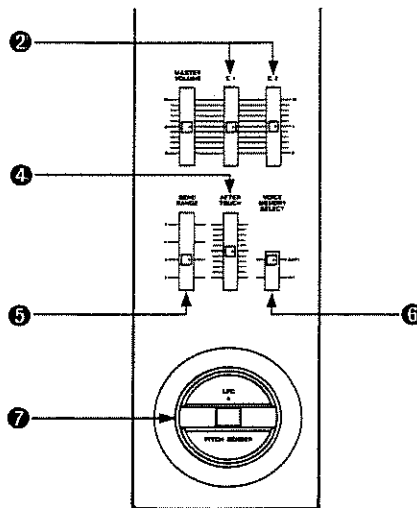

The setting of On/Off or value of each aftertouch effect can be written in each Patch Memory independently, but the Aftertouch Fine Adjust Knob allows even more delicate adjustment of the effect. When this knob is set to the center position, the same effect as set in the Patch Memory can be obtained, and no effect is obtained at the lowest position [–].

\* Different On/Off settings and values of the aftertouch and bender are written in each of the 64 Patch Memories. Therefore, those effects you actually gain will greatly differ depending on how these are set in the Patch Memories. No effect may be obtained in some particular settings.

**d. Voice Memory Switch ⑥**

This switch selects which memory mode; the JX-10's internal memory or the Cartridge memory to be used.



	CART	INT
Patch Memory	You can call a Patch Memory in the Cartridge	You can call a Patch Memory in the JX-10
Tone	Tone Numbers 1 to 50 = Tones in the Cartridge	Tone Number 1 to 50 = Tones in the JX-10
	Tone Number 51 to 100 = Tones in the JX-10	

\* Even after you have changed the Memory modes with the Voice Memory Switch, the new position does not affect the memory unless you select a new Patch Memory.

When you select a new Patch Memory, " I " (internal) or " C " (cartridge) is shown at the left end of the Display, depending on which position has been selected with the Voice Memory Switch.

\* When the Memory Cartridge is not connected, be sure to set the Voice Memory Switch to the INT position.

### 3. Control Assign

The JX-10 allows you to control some of the performance control functions with the Control Assign Knobs on the control panel and the Pedal Switch (DP-6 or DP-2). This is excellent in live performance. However, the functions which can be controlled are only two of the four with the two Control Assign Knobs and one of the four by the pedal switch at a time. (See the table shown on

the next page). The following explains how to assign the functions to the knobs and the pedal switch. The function assigned to each knob is controlled by moving the slider, and the function assigned to the pedal switch is controlled with the pedal operation. We call these eight functions Control Assign functions.

---

#### PROCEDURE

- ① Select the Control Assign Knob 1, 2 or Pedal Switch where you wish to assign the function by pushing the appropriate Control Assign Button; C1, C2 or PEDAL SWITCH Button.

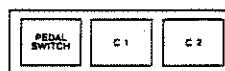

The Display will show the Control Assign function that is previously assigned.

- ② Rotating the  $\alpha$  Dial, call the new function to be assigned. (See the table shown on the next page.)
- ③ To continue to assign other functions, repeat the step ① and ②.
- ④ When you have completed assigning all the Control Assign functions, push the Control Assign Button currently in use.

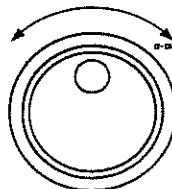

The Display will return to the usual indication.

While the Display shows Control Assign function, nothing can be done on the JX-10 except for playing the keyboard.

When the Expression Pedal EV-5 is connected to the Control Assign Jack on the rear panel, the assigned Control Assign function cannot be controlled with the Control Assign Knob but only with the pedal.

---

#### • Writing the Control Assign

The Control Assign functions you have set can be written into the JX-10's internal memory as follows.

After step ③, set the Protect Switch ⑩ on the JX-10 to the OFF position, then push the WRITE Button ⑪.

A rectangular display area with a black border. Inside, the words 'WRITTEN CONTROL' are displayed in a pixelated, uppercase font.

The Display will respond with as above, then return to the usual indication.

When C1 or C2 is selected, any of the following four functions can be assigned.

<div style="display: flex; justify-content: space-around; align-items: center;"> <div style="border: 1px solid black; padding: 2px 5px;">C1</div> <div style="border: 1px solid black; padding: 2px 5px;">C2</div> </div>		“. ” in the Display actually shows 1 or 2 depending which of <input type="checkbox"/> or <input type="checkbox"/> is pushed. ** shows the value set in the Patch Memory.
Display	Description	
<div style="border: 1px solid black; padding: 5px; display: inline-block;">                     C· ASSIGN 11 U/L BAL **                 </div> (Upper/Lower Balance)	Adjusts the volume balance of the Upper and Lower. Raising the Knob increases the Upper volume, and lowering the Knob increases the Lower volume.	
<div style="border: 1px solid black; padding: 5px; display: inline-block;">                     C· ASSIGN 15 PORTA. TIME **                 </div> (Portamento Time)	Adjusts the Portamento Time. Raising the Knob makes longer Portamento Time.	
<div style="border: 1px solid black; padding: 5px; display: inline-block;">                     C· ASSIGN 18 TOTAL VOL **                 </div> (Total Volume)	Adjusts the volume within the range of the maximum volume set with the Master Volume. Raising the Knob raises the volume, reaching the maximum volume. At the same time, the MIDI volume of the Upper and the Lower change.	
<div style="border: 1px solid black; padding: 5px; display: inline-block;">                     C· ASSIGN 65 UP MIDI VOL **                 </div> <div style="border: 1px solid black; padding: 5px; display: inline-block;">                     C· ASSIGN 66 LO MIDI VOL **                 </div> (MIDI Volume)	Controls the MIDI messages of the Upper or Lower section. Refer to “MIDI” on page 56.	

\* When PEDAL SWITCH is selected, any of the following four functions can be assigned.

<div style="border: 1px solid black; padding: 2px 5px; display: inline-block;">                     PEDAL SWITCH                 </div>		“. ” in the Display actually shows 1 or 2 depending which of <input type="checkbox"/> or <input type="checkbox"/> is pushed. ** shows the value set in the Patch Memory.
Display	Description	
<div style="border: 1px solid black; padding: 5px; display: inline-block;">                     PS ASSIGN PATCH SHIFT                 </div> (Patch Shift)	Pressing the pedal changes the bank and the number of the Patch Memory. A1 → A2..... A8 → B1 → B2.....	
<div style="border: 1px solid black; padding: 5px; display: inline-block;">                     PS ASSIGN PORTAMENTO                 </div> (Portamento ON/OFF)	Turns the Portamento ON or OFF.	
<div style="border: 1px solid black; padding: 5px; display: inline-block;">                     PS ASSIGN CHASE PLAY                 </div> (Chase Play ON/OFF)	Turns the Chase Play Function (p. 19) ON or OFF.	
<div style="border: 1px solid black; padding: 5px; display: inline-block;">                     PS ASSIGN UPPER HOLD                 </div> <div style="border: 1px solid black; padding: 5px; display: inline-block;">                     PS ASSIGN LOWER HOLD                 </div> (Upper Hold, Lower Hold)	Turns on or off the Hold Effect of the Upper and/or the Lower section.	

## 4. Quick Edit of a Patch Memory

The following three Factors can be quickly edited even during live performance just by touching the relevant button.

- **Key Mode Select:** Whole (Upper, Lower), Dual and Split
- **Tone Number:** Tone(s) in a Patch Memory
- **Chase Play:** When the Key Mode is Dual, delay-like effect can be obtained

\* The above editing function does not automatically rewrites the data in memory unless you take the appropriate writing procedure explained on page 46. Therefore, selecting a new Patch Memory will erase the edited data.

### a. Key Mode

There are following 6 Key Modes

1. **UP WHOLE (Upper Whole)**
2. **LO WHOLE (Lower Whole)**
3. **DUAL**
4. **SPLIT**
5. **T. VOICE (Touch Voice)**
6. **X-FADE (Cross Fade)**

1 to 4 Key Modes can be called with Quick Edit. 5 to 6 Key Modes can be set just when editing the Patch Memory.

The three Key Mode Buttons are used for setting the Key Mode. The indicator of the pushed button will light up.

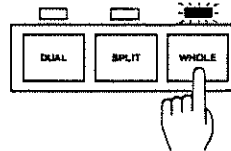



### Split Mode

This mode divides the keyboard of the JX-10 into the upper and the lower sections where two different Tones can be used. That is, the JX-10 works just like two sets of 6 voice synthesizers of different sounds.

The JX-10's unique Split system allows to set the lowest key in the Upper section and the highest key of the Lower section separately on the same keyboard. The Quick Edit, however, does not include this function. This is possible only when editing a Patch Memory.

#### PROCEDURE

While holding the SPLIT of the Key Mode Button down, press the key which is to be the Split Point.

While holding this button down.

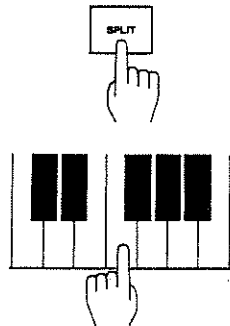

Push the Key where the keyboard should be divided into two sections, Upper and Lower.

The right side including the pushed key will be the Upper, and the left will be the Lower keyboard.

### Whole Mode

In this mode, the JX-10 can be used as a usual 12 voice polyphonic synthesizer. That is, all the 76 keys will have the same Tone. Therefore, it is required to select one of the two different Tones provided for the upper and the lower sections. When the Tone for the upper section is selected, it is called Upper Whole Mode, and when the lower Tone is selected, called Lower Whole. Pressing the Whole Button will alternately select the Lower and Upper Tones.

The Display shows the Tone Number currently selected.

### Dual Mode

The Dual Mode turns the JX-10 to the 6 voice synthesizer that allows both the Upper and the Lower Tones to sound simultaneously. A rich sound is obtained.





There are two independent parallel outputs for the upper and lower Tones, which serve to create the effect as if two synthesizers were simultaneously played.

## b. Tone Number

To change the Tones in a Patch Memory, simply assign the Tone Number of the relevant Tone by using the Ten Keys.

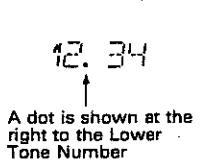
### PROCEDURE

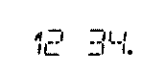
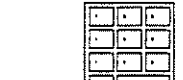
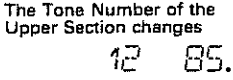
- ① Push the Upper or the Lower Button ⑬ to select the Upper or Lower Tone which you wish to change.
- ② Pushing the appropriate Ten Keys, assign the new Tone Number, then hit the Enter Key.

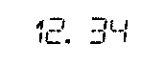
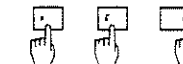
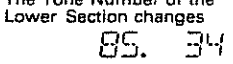
Tone Numbers of the Patch Memory currently selected are displayed	Select the Upper or Lower Section		Assign the Tone Number you want by using the Ten Keys	
				The Tone Number of the Upper Section changes 
				The Tone Number of the Lower Section changes 

\*"0" of the Ten Keys can be used instead of the UPPER and LOWER Buttons.

Even when using the Patch Memory of the JX-10's internal memory, the Tone Number of the Cartridge can be called.

After taking the step ①, change the Voice Memory Switch ⑥ to the CART position. Then return it to the INT position after taking the step ②.

If you call other Patch Memory without writing it into memory, the Tone called from the Cartridge memory will be erased.

To call the Tone from the Memory Cartridge (M-16C), take exactly the same procedure as above. The available Tone Numbers, however, are from 1 to 32.

### c. Chase Play

The Chase Play function makes it possible to output the Lower sound slightly later than the Upper sound. This function, however, is available just in the Dual Mode.

Depending on the delaying time and the Tone in use, the effects created differ; delay-like effect, sound-on-sound like effect etc.

#### PROCEDURE

- ① Push ON/OFF of the Chase Play Buttons **Ⓛ**.

The corresponding indicator will light up, showing that now the Chase Play function is turned on.

- ② Set the following 3 functions: Time, Level and Mode so that the desired effect will be obtained.

The "Level" and "Mode" are alternately selected by pressing the FUNCTION of the Chase Play Buttons. The Display shows the function selected. The "Time" function can be selected by pressing the TIME of the Chase Play Buttons. The value of the selected function can be changed by using the  $\alpha$  Dial.

#### 1) Level

This sets the level of the delayed sound (= lower sound).

Rotating the  $\alpha$  Dial, set the value you like. The value changes from 00 to 99, and the higher number sets higher level.

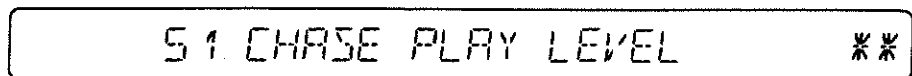

\*\*\*: 00 to 99

## 2) Mode

This sets how the delayed sounds are output sequentially. As you rotate the  $\alpha$  Dial, the Display changes as "U-L-U-", "U-L-L-" or "U-L".

- **U-L-U-**: In this mode, Upper sound is output first, then Lower, Upper, Lower repeatedly.
- **U-L-L-**: In this mode, Upper sound is output first, then Lower sounds repeatedly.
- **U-L**: In this mode, Upper sound is first output then Lower. No more sound is output.

52 CHASE PLAY MODE \* \* \* \* \*

\* \* \* \* \* : U-L-U-  
U-L-L-  
U-L  
Three Modes

## 3) Time

This sets the time between the first (Upper) sound and the second (Lower) sound.

Push the TIME of the Chase Play Buttons to turn to the Time adjusting mode, then change the value rotating the  $\alpha$  Dial. 01 to 99 are valid and the higher number is longer time.

53 CHASE PLAY TIME \* \*

\* \*: 01 to 99

When you have completed editing all the functions, hit the Enter Key.

\* As the level described on the previous page in "1) Level" is set higher and the key touch is stronger, more delay sounds are obtained. If the Tone Parameter Number 63 "VCA Dynamics Range" is set to OFF, the volume of the sound does not change, but repeats in the same volume.

## 5. Sequencer

The JX-10 contains the Sequencer function that is obtained by using the supplied Memory Cartridge (M-64C, M-16C). What you play on the keyboard will be recorded in the sequencer and faithfully played back.

### a. Recording Sequencer Data

The messages available for the JX-10's Sequencer are as follows:

1. Note On/Off
2. Patch Memory Selection
3. Hold On/Off
4. Portamento On/Off

Patch Memory Selection messages can be recorded by using the appropriate Patch Memory Buttons and the Hold and Portamento On/Off messages are recorded by pushing the pedal in the writing procedure 3 on this page.

\* If you wish to record the Portamento messages, connect a pedal switch to the PEDAL SWITCH of the Control Assign Jacks 28, then select PORTAMENTO with the PEDAL SWITCH of the Control Assign Functions.

#### NOTE

The Pitch Bend and Vibrato effects obtained with the Bender Lever and the Aftertouch effect are not available for the JX-10's Sequencer.

- ① Turn the Protect Switch on the Memory Cartridge to the OFF position.
- ② While holding the REC of the Sequencer Buttons down, push the START/STOP.

The Display will change to as shown below and the indicator of the START/STOP will flash. This tells you that the Sequencer is ready to record the data.

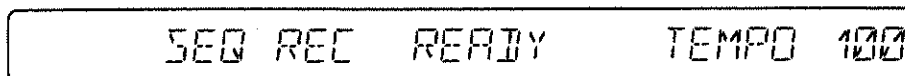

SEQ REC READY      TEMPO 100

This shows the recording speed of the sequencer. Can be set with the  $\alpha$  Dial. (The default value is 100.)

\* The Sequencer of the JX-10 does not work without using the Memory Cartridge.

The capacity of the Memory Cartridge for the sequencer data:

- M-16C      Approx. 400 notes
- M-64C      Approx. 1600 notes

Writing a new data will automatically erase the data previously written.

When using the Memory Cartridge for the Sequencer function, you do not need to move the positions of the Voice Memory Switch ⑥.

- ③ Play the keyboard.

The moment you start playing, the Display will change to as below.



This shows the Patch Name of the Patch Memory currently selected.

This shows how much memory is left for the sequencer data. The number (percent) will count-down as you play the keyboard.

- ④ When you have completed playing, press the START/STOP button.

The sequencer continues to record the data even after you stop playing until the START/STOP button is pushed. That is, rests are recorded after you stop playing until you push the START/STOP button.

- ⑤ Return the Protect Switch on the Memory Cartridge to the ON position.

### About Tempo

If you wish to see the tempo indication of the sequencer data when you are playing it back, you need to record the data to the flashing of the indicator. Otherwise, the tempo shown during playing back the data will not be correct. That is, after taking the step ②, with the α Dial, make the tempo (= flashing indicator) in which you think the most comfortable speed for playing the keyboard. If you do not take this procedure, the tempo will be automatically set to 100.

## b. Playing the Recorded Data

- ① Push the START/STOP of the Sequencer Buttons.

The indicator of the START/STOP flashes and the Sequencer starts playing back the recorded data. The Display will change to as shown below.



This shows the Patch Name of the patch Memory currently selected.

The tempo of the music you play is shown in number from 40 to 200.

When the data is played up, it will automatically stop. To stop playing back in the middle of the data, push the START/STOP button. In either case, pushing the START/STOP button again will start playing from the beginning of the data.

To change the tempo of the playing data, simply rotate the α Dial. Rotating it clockwise will quicken the tempo and counterclockwise will slow down.

While the sequencer is playing back the data, you can change the Patch Memories, but not the Tones or performance control functions.

## 1) Repeat Function

The sequencer data can be played back repeatedly.

### PROCEDURE

- ① With the sequencer stopped, push the FUNCTION of the Sequencer Buttons once.

The Display will show REPEAT.

- ② Rotate the  $\alpha$  Dial clockwise.

The Display will show ON, and now the sequencer data is ready to be played back repeatedly. To stop playing push the START/STOP button.

To return the Display to the usual indication, push the ENTER Key with the sequencer stopped.

To cancel the Repeat mode, push the FUNCTION button to select REPEAT, then rotate the  $\alpha$  Dial counterclockwise until the Display shows OFF.

## 2) Tempo Setting

The recorded data will be played back in the same tempo as recorded if no special operation is taken. It, however, is possible to playback the data in a different tempo using the  $\alpha$  Dial. You can spontaneously change the tempo during playback, but to set the tempo before playing back the data, take the following procedure.

- ① Push the FUNCTION of the sequencer Buttons with the sequencer stopped.

The Display will show the current tempo.

- ② Rotating the  $\alpha$  Dial, change the tempo.

Rotating the dial clockwise will set higher number (quicker tempo), and counterclockwise will set lower number (slower tempo).

Each time you push the FUNCTION of the Sequencer Buttons, the Display will change as shown below.

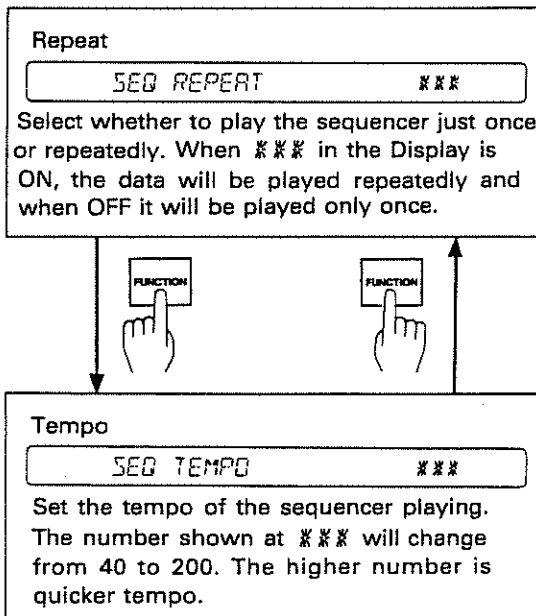

To reset the sequencer function, push the ENTER Key.

## NOTES

The supplied Memory Cartridge M-16C is specially for saving the sequencer data. The M-64C can be used for either the sequencer data or Patch Memories and 50 Tones. If you try to use the cartridge used for the Patch Memories, the Display will respond with the error message MISMATCH. If this happens correct it as shown "3) MISMATCH" on page 55.

## 6. Edit

The Tones and Patch Memories written in the JX-10's internal memory or in the cartridge memory can be edited to your taste. This editing does not automatically rewrite the previous data. To write the edited data, take an appropriate writing procedure as explained on page 41.

Upper/Lower Balance	11
---------------------	----

11 UPPER/LOWER BALANCE \*\*\*

00 to 99

Dual Detune	12
-------------	----

12 DUAL DETUNE \*\*\*

-50 to 00 to +50

Upper Split Point	13
Lower Split Point	14

13 UPPER SPLIT POINT \*\*\*

14 LOWER SPLIT POINT \*\*\*

E1 to G7

Portamento Time	15
-----------------	----

15 PORTAMENTO TIME \*\*\*

00 to 99

### a. Editing a Patch Memory

Each of the A-1 to H-8 Patch Memories consists of 39 different Factors and changing the values of the Factors will edit a Patch Memory. Editing is quite simple; the value of each Factor has two figure number, so use the appropriate number to call the Factor whose value you wish to change then change it.

This Factor determines the volume balance of the Upper and the Lower. When the value is about 50, the volumes of the both sections are the highest, and as the value increases, the Lower volume decreases, the Upper volume remaining the highest. That is, when the value in the Display is 99, only the Upper sound will be heard. When the value is smaller than 50, the opposite effect will be obtained.

This Factor can detune the Lower sound from the Upper sound. At "+" value, the Lower sound is raised, at zero, the pitch is the same as the Upper, and at "-" value, it is lowered.

The Split Point set with the Quick Edit is restricted to the lowest note of the Upper section. Here, however, these two Factors are used for setting two different Split Points; the lowest note of the Upper section, and the highest note of the Lower section. The value and the note name. The lowers note is E1, the middle C is C4 and the highest is G7. ("+" indication represents #.)

This Factor adjusts the Portamento time. Higher value is the longer Portamento time.



**Bender Range** 15

15 BENDER RANGE \*

2  
3  
4  
7

**Key Mode** 17

17 KEY MODE \*\*\*\*\*

UP WHOLE  
LO WHOLE  
DUAL  
SPLIT  
T. VOICE  
X-FADE

This Factor sets the maximum effect of the Bender. The value in the Display represents semi-tone. 2 is major 2nd, 3 is minor 3rd, 4 is major 3rd and 7 is perfect 5th.

The Key Modes which can be selected with the Quick Edit Function are restricted to four modes; Upper Whole, Lower Whole, Dual and Split. Here, however, two more Key Modes, altogether 6 modes can be set. T. VOICE and X-FADE can be selected by rotating the  $\alpha$  Dial counterclockwise, and other modes can be selected by rotating it clockwise.

• **Touch Voice Select Mode (T. VOICE)**

In this mode, either the Upper or Lower Tone is output depending how you play the keyboard. That is, when you play the keyboard hard, the Upper Tone is selected, and when you play softly, the Lower Tone sounds. As shown in the left picture, the key touch pressure that selects the Upper or the Lower Tone changes depending on the Upper Split Point (= Factor 13). When the Split Point is set to higher note, stronger key touch will be needed for obtaining the Upper Tone.

TOUCH VOICE SELECT (T. VOICE)

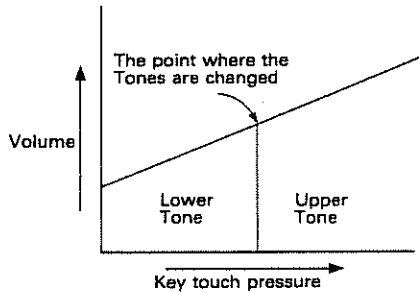

• **Cross Fade Mode (X-FADE)**

This is a kind of Dual mode. In this mode, the volume of the Lower Tone decreases by stronger key touch, and the volume of the Upper Tone decreases by weaker key touch. This mode, therefore can be effectively used to change the volume balance of the Tones by changing the playing manners when you are using different Tones for the Upper and the Lower.

CROSS FADE (X-FADE)

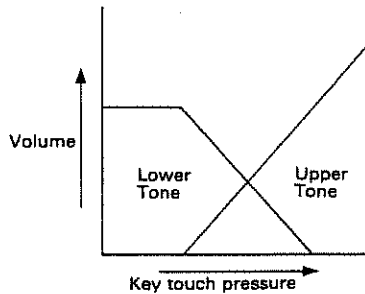

<b>Total Volume</b>	18
---------------------	----

18 TOTAL VOLUME      \*\*  
00 to 99

This Factor allows to set an individual volume for each Patch Memory. This is useful to reduce the volume difference between the Patch Memories. 00 is the minimum value and 99 the maximum.

<b>Aftertouch Vibrato</b>	21
<b>Aftertouch Brilliance</b>	22
<b>Aftertouch Volume</b>	23

21 AFTER TOUCH VIB      \*\*  
00 to 99

22 AFTER TOUCH BRD      \*\*  
00 to 99

23 AFTER TOUCH VOL      \*\*  
00 to 99

The sensitivity of each Aftertouch can be set. At 00 value, the effect is off, and the higher value deepens the effect.

<b>Upper Tone Number</b>	31
<b>Lower Tone Number</b>	41

31 UPPER TONE      \*\*\*  
1 to 100

41 LOWER TONE      \*\*\*

These Factors select the Tones for the Upper and Lower sections.

<b>Upper Chromatic Shift</b>	32
<b>Lower Chromatic Shift</b>	42

32 UP CHROMATIC SHIFT      \*\*\*

42 LO CHROMATIC SHIFT      \*\*\*

Using these Factors, you can shift the pitches of the Upper and the Lower keyboards separately in semi-tone steps in the range of 4 octaves; 2 octaves upper and lower. If a number higher than +5 is assigned, the highest octave substitutes it, and the value lower than -7 (such as -8, -9 etc.) is assigned, the lowest octave substitutes it.

Upper Key Assign	33
Lower Key Assign	43

33 UPPER KEY ASSIGN \*\*\*\*\*

43 LOWER KEY ASSIGN \*\*\*\*\*

POLY 1  
POLY 2  
UNISON 1  
UNISON 2  
MONO 1  
MONO 2

• **POLY 1**

This mode turns each of the Upper and the Lower Keyboards of the JX-10 to a 6 voice polyphonic synthesizer assigning one synthesizer module to each key pressed. This is suitable for the sound whose envelope curve is similar to piano's or guitar's, therefore chosen for usual performance.

• **POLY 2**

This mode is very similar to Poly mode above assigning only one synthesizer voice to each key pressed. However, the same module as assigned to the key previously played is assigned to the note played later. So, this mode is suitable for the performance with portamento effect.

• **UNISON 1**

In this mode, two sound modules are assigned to each key, therefore the created sound is richer than in Poly mode. That is, each of the Upper and the Lower sections becomes 3 voice synthesizer.

• **UNISON 2**

This is similar to the Unison mode above, but the one of the two modules is one octave lower than the other.

The JX-10 features 6 modules for the Upper section of the keyboard and another 6 for the Lower section, altogether 12 modules. Each of the modules consists of two sound sources. The Key Assign Factor determines how to assign these modules to the keyboard.

• **MONO 1**

This mode turns each of the Upper and the Lower Keyboard to a single voice synthesizer that assigns one module to each key.

• **MONO 2**

This mode turns each of the Upper and the Lower Keyboard to the monophonic synthesizer that assigns 6 modules to one key pressed.

The Upper and the Lower sections of the keyboard can have different Key Assign modes, which makes various interesting combinations. However, please note that when the Whole key Mode is selected, the Key Assign Factor you set will be ignored, and when the Portamento is turned on, the Poly 2 is automatically selected, and when it is off, the Poly 1 mode is selected. Also, when the Key Mode is either the Touch Voice or Cross Fade, the Key Assign selected on the Lower will be ignored and the Key Assign of the Upper will work.

Upper Unison Detune	34
Lower Unison Detune	44

34 UP UNISON DETUNE \*\*\*

44 LO UNISON DETUNE \*\*\*

-50 to 00 to +50

When the Key Assign is set to either the Unison 1 or Unison 2, either of the two modules can be detuned using these Factors. "+" works to raise the pitch and "-" to lower it.

Upper Hold	35
Lower Hold	45

35 UPPER HOLD \*\*\*

45 LOWER HOLD \*\*\*

ON  
OFF

When the Pedal Switch is used for the Hold effect, these Factors can turn on or off the Hold effect separately on the Upper and Lower.

Upper LFO Modulation Depth	36
Lower LFO Modulation Depth	46

36 UPPER LFO MOD DEPTH \*\*

46 LOWER LFO MOD DEPTH \*\*

00 to 99

These Factors can set the depth of the Vibrato effects obtained with the Bender lever. At 00 value, no effect is obtained, and increasing the value deepens the effect.

Upper Portamento	37
Lower Portamento	47

37 UPPER PORTAMENTO \*\*\*

47 LOWER PORTAMENTO \*\*\*

ON  
OFF

These Factors can turn on or off the Portamento effects of the Upper and the Lower separately.

Upper Bender	38
Lower Bender	48

38 UPPER BENDER \*\*\*

48 LOWER BENDER \*\*\*

ON  
OFF

These Factors can select whether to turn the Bender functions on or off separately on the Upper and the Lower.

Chase Play Level	51
Chase Play Mode	52
Chase Play Time	53

51 CHASE PLAY LEVEL \*\*

52 CHASE PLAY MODE \*\*\*\*\*

53 CHASE PLAY TIME \*\*

Refer to page 19.

Chase Play Switch	54
-------------------	----

54 CHASE PLAY SWITCH \*\*\*

ON  
OFF

This Factor turns the Chase Play function on or off.

PROCEDURE

- ① Push the PATCH of the Edit Buttons.

The indicator of the PATCH button lights up showing that it is now in the Editing mode. The Display changes to as shown below.



- (A): Factor Number and Factor Name are displayed.
- (B): The value of each Factor is displayed.

- ② Using the Ten Keys, assign the number of the Factor whose value is to be changed.

As shown right, push the key in a correct order, then hit the Enter Key.

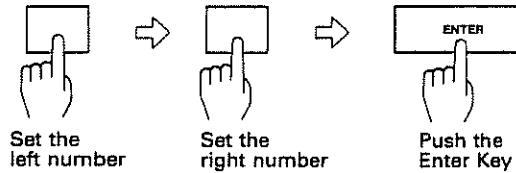

- ③ Using the  $\alpha$  Dial, change the value as you like. It may be necessary to actually listen to the sound while changing the value.
- ④ To continue to edit other Factor, repeat the step ② and ③.

It is also possible to use the  $\alpha$  Dial for calling a Factor. After pushing the PARAM button, rotate the  $\alpha$  Dial, and the Factor shown in the Display will change in sequence. When the Factor you wish to edit appears in the Display, push the VALUE of the Edit Buttons, then change the value with the  $\alpha$  Dial. This method is useful for when you are editing the Factor of close number.

However, to continue to edit other Factor, be sure to push the PATCH then the PARAM buttons, then call the Factor you want by using the  $\alpha$  Dial.

When you have completed editing the Patch Memory, push the PATCH button. The indicator of the PATCH goes out and the display returns to the usual indication except that the Bank and the Number of the Patch Memory flash showing that the Patch Memory is edited but not yet written into memory. If you call other Patch Memory at this stage, the edited Patch Memory will be erased.

## b. Editing a Tone

A Tone consists of various parameters. Like any usual synthesizer, the JX-10 allows editing these parameters for sound synthesis. The JX-10, however, does not feature knobs or switches on its panel for you to touch or move. Instead, there are two methods of synthesizing. One is calling each parameter and changing the value. This method does not allow to edit more than one parameter at a time, so may be used for making a slight edit during live performance, etc. The other method is using the optional programmer PG-800 which works just like the panel controls on the usual synthesizer. For quicker and easier editing or synthesis from scratch, the PG-800 may be essential.

### 1) Editing with the Programmer PG-800

As shown right, set up the programmer and the JX-10 using the 6P DIN cable supplied with the composer.

The PG-800 works just like the control panel of a usual synthesizer, that is, you can edit the existing Tone or make a complete new Tone from scratch, by actually using the tangible knobs and buttons. The PG-800 does not work when the JX-10 is set to the Writing mode.

In the Display, the Tone numbers of the Patch Memory currently selected are shown, and a dot is shown at the lower corner of either Tone number. Always, the Tone number with a dot at the lower corner can be edited. So, it is necessary to make sure that a dot is seen at the corner of the Tone number which you wish to edit. If the dot is seen at the corner of the other Tone number, simply push the Upper or Lower Button which is relevant.

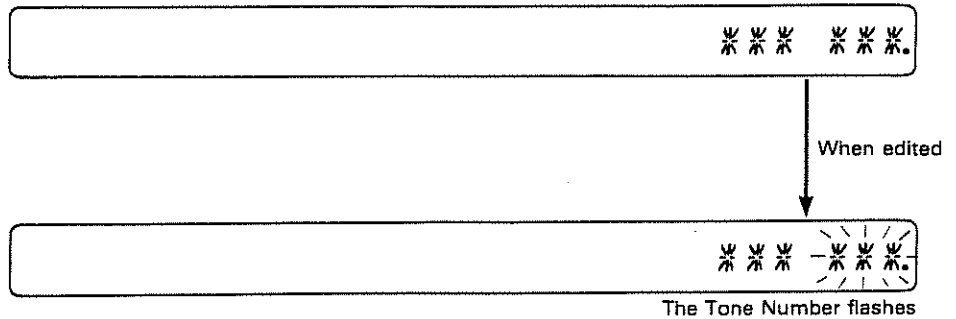
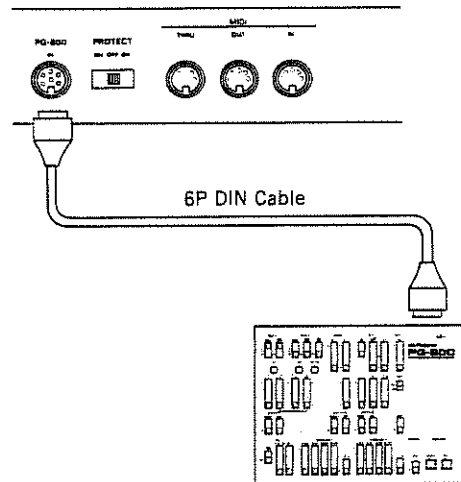

If any of the switches or buttons on the programmer is even slightly moved, the Tone number in the Display flashes. This flashing always means that the Tone is edited, therefore different from the one in memory.

To see the name or the value of the parameter which you are now editing, do as follows.

- ① Push the TONE of the Edit Buttons.

The Display will respond with:



Abbreviation of the Voice Memory mode and Patch Number      Tone Number to be edited

- ② Edit with the PG-800.

The parameter name and its value are shown in the Display.

## MANUAL MODE

The JX-10 features Manual mode in which the whole panel setting of the programmer decides the Tone. That is, now existing Tone written in memory has nothing to do with your sound synthesis. To turn the JX-10 to this mode, simply push the Manual Button on the PG-800.

\* If there is no change by moving the knob or switch on the programmer, it is because the position you have set is exactly the same as the preprogrammed. If it happens, just ignore it and move to the next procedure.

\* It may be quicker and easier to select a Tone that is similar to the one you want to synthesize, then modify it.



## 2) Editing without using the Programmer



The parameters of a Tone have two figure numbers. To edit a Tone without using the programmer, call each parameter by assigning the appropriate number and change the value with the  $\alpha$  Dial.

## PARAMETER TABLE

### DCO (Digitally Controlled Oscillator)

DCO is the digitally controlled oscillator that controls the pitch and generates the waveforms that are the sound source of the synthesizers. Owing to its

digitally controlled system, this offers superior pitch stability compared with the VCO (Voltage Controlled Oscillator). The JX-10 has 2 DCO's.

Number	Parameter Display	Data Value	Function	Programmer
11	DCO1 RANG	2'	This is to change the pitch range of the DCO in exact one octave steps from 2' to 16' (2', 4', 8', 16'). 8' is standard.	
	DCO-1 Range	4'		
21	DCO2 RANG	8'		
	DCO-2 Range	16'		
12	DCO1 WF	SAWT	This is to choose the output waveform of the DCO.  SAWT:  (Saw Tooth) PULS:  (Pulse Wave) SQUA:  (Square Wave) NOIS:  (Noise)	
	DCO-1 Waveform	PULS		
22	DCO2 WF	SQUA		
	DCO-2 Waveform	NOIS		
13	DCO1 TUNE	+12	This changes the frequency (pitch) of the DCO, in semi-tones steps. •Variable Range: $\pm 12$ ( $\pm 1$ Octave)	
	DCO-1 Tune	00		
24	DCO2 TUNE	00		
	DCO-2 Tune	-12		

#### Note 1

Depending on the position of the Dynamics Range Selector, the tone color alteration differs as shown below.

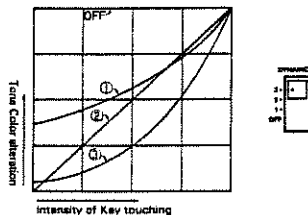





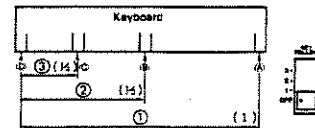

#### Note 2

##### Envelope Key Follow

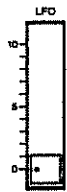

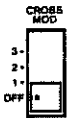
OFF: All Keys have the same Envelope time.

- ①: The highest Key ③ has the ENV time exactly half length of the lowest Key ①'s.
- ②: The Key ② has the ENV time exactly half length of the lowest Key ①'s.
- ③: The Key ① has the ENV time exactly half length of the lowest Key ①'s.

Parameter		Data Value	Function	Programmer
Number	Display			
14	DCO1 LFO	99	When the LFO output is modulating the DCO, this parameter is used to adjust the depth of the modulation. For vibrato effect, select "SINE" with the LFO Waveform.	
	DCO-1 LFO Depth			
26	DCO2 LFO	)		
	DCO-2 LFO Depth			
15	DCO1 ENV	00	When the ENV output is modulating the DCO, this parameter is used to adjust the depth of the modulation.	
	DCO-1 Envelope Depth			
27	DCO2 ENV			
	DCO-2 Envelope Depth			
23	DCO XMOD	XMOD	<ul style="list-style-type: none"> <li>•SNC 1: The pitch is determined by DCO-1, and the harmonic contents by DCO-2. The waveform is determined by the DCO-2's synchronization to DCO-1.</li> <li>•SNC 2: Both SYNC 1 and X MOD work together.</li> <li>•X MOD: DCO-1 and DCO-2 affect each other, pitch, harmonic contents, and waveform.</li> <li>•OFF: Each DCO-1 and DCO-2 can have different pitch and waveform.</li> </ul>	
	Cross Modulation	SNC2		
		SNC1		
		OFF		
25	DCO2 FTUN	+50	The frequency (pitch) of the DCO-2 can be adjusted with this parameter. •Variable range... ± 50 cent	
	DCO-2 Fine Tune	-50		
31	DCO DYNA	3	When the DCO's pitch is controlled by the ENV, and the amount of the ENV is controlled by Dynamics (Key Touch), this parameter adjusts the sensitivity of Key Touch. (Note 1)	
	DCO Dynamics Range	2		
		1		
		OFF		
32	DCO MODE	U-1	This selects the polarity of the Envelope curve. Normally, ^ is used. In V mode, ADSR pattern will be all inverted.	
	DCO Envelope Mode	U-1		
		U-2		
		U-2		

**MIXER**

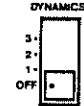
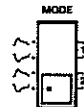

This is where the volume balance of the DCO-1 and DCO-2 is controlled.

Parameter		Data Value	Function	Programmer	
Number	Display				
41	MIX DCO1	99	This adjusts the level of DCO-1.		
	DCO-1 Level				
42	MIX DCO2	5	This adjusts the level of DCO-2.		
	DCO-2 Level				
43	MIX ENV	00	When ENV controls the DCO-2's level, this sets the amount of ENV signal.		
	DCO-2 Envelope Depth				
44	MIX DYNA	3	When the DCO-2's level is controlled by ENV Depth and then by Dynamics, this sets the sensitivity of the Key Touch. [NOTE 1]		
	DCO-2 Dynamics Range	1 OFF			
45	MIX MODE	0-1	Normally, ^ is used, and in v mode, ADSR pattern will be inverted.		
	DCO-2 Envelope Mode	0-1			0-1 : ENV 1 ^
		0-2			0-1 : ENV 1 v
		0-2			0-2 : ENV 2 ^
		0-2	0-2 : ENV 2 v		

**VCF (Voltage Controlled Filter)**

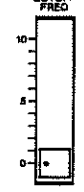
The output signal goes to the Mixer then to the VCF to be filtered. Each VCF lets lower frequency harmonics pass and cuts off the higher ones. In other words, it is a usual low pass filter. By controlling the cutoff point and resonance, the waveform changes, thereby the tone color alters.

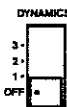

Parameter		Data Value	Function	Programmer
Number	Display			
51	HPF FREQ	3	The HPF (High-Pass Filter) is a filter that passes higher frequency harmonics and cuts off the lower ones. As you increase the value, cutoff point goes up, lower frequency harmonics being cut off.	
	High-pass Filter Cutoff Frequency	2 1 0		
52	VCF FREQ	99	This is for changing the cutoff point of the VCF. As you decrease the value, cutoff frequency will come down, and the waveform gradually becomes approximation of a sine wave, then the sound will fade out.	
	Cutoff Frequency	5 00		

Parameter		Data Value	Function	Programmer
Number	Display			
53	VCF RES	99 ) 00	<p>This emphasizes the cutoff point. As you increase the value, the created sound will become more unusual, more electronic in nature.</p> <p>This controls the cutoff point by the waveform selected at the LFO section. Increasing the value deepens the modulation.</p> <p>This controls the cutoff point of the VCF in each note with the ENV curve set in the ENV section. As you increase the value, tone color within one note changes more drastically.</p> <p>This can shift the cutoff point by key position (pitch). At 100%, it prevents any inconsistency in the harmonic contents caused by pitch alteration.</p> <p>Parameter value 83 (=Programmer's Knob "8")= 100%</p>	
	Resonance			
54	VCF LFO			
	LFO Depth			
55	VCF ENV			
	Envelope Depth			
56	VCF KEY			
	Key Follow			
57	VCF DYNA	3 2 1 OFF	<p>When the VCF is controlled by ENV and Key Touch (Dynamics), this parameter determines the sensitivity of the Key Touch. (Note 1)</p>	
	Dynamics Range			
58	VCF MODE	∩-1 ∪-1 ∩-2 ∪-2	<p>This is to select the polarity of the Envelope curve that controls VCF. Usually ∩ may be used. In ∪ mode, ADSR pattern will be inverted.</p> <p>∩-1: ENV1 ∩ ∪-1: ENV1 ∪ ∩-2: ENV2 ∩ ∪-2: ENV2 ∪</p>	
	Envelope Mode			

**VCA (Voltage Controlled Amplifier)/  
Chorus**

After filtered in the VCF, the signal is fed to the VCA where the volume (amplitude) of the sound is controlled.

Parameter		Data Value	Function	Programmer
Number	Display			
61	VCA LEVEL	99 ) 00	<p>This is to adjust the volume level, and can be effectively used in the writing mode.</p> <p>If it is set too high, sound may be distorted.</p>	
	VCA Level			

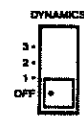
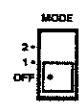
Parameter		Data Value	Function	Programmer
Number	Display			
62	VCA MODE	ENV2	This is to select whether to control the VCA by the signal from the ENV-2 (  ) or by the Gate signal (  ).	
	VCA Mode	GATE		
63	VCA DYNA	3	This parameter determines the sensitivity of the Key Touch (Dynamics effect). (Note 1)	
	VCA Dynamics Range	2		
		1 OFF		
64	CHORUS	2	OFF: Chorus is off 1: Expansive Chorus effect is obtained. 2: Rich Chorus effect is obtained.	
	Chorus Mode	1		
		OFF		

### LFO (Low Frequency Oscillator)

This oscillator generates extremely low frequency, so produces a vibrato or growl effect by controlling the DCO or VCF.

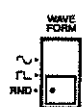
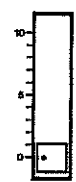
Parameter		Data Value	Function	Programmer
Number	Display			
71	LFO WF	SINE	This is for selecting the LFO output waveform.	
	LFO Waveform	SQUA		
		RAND		
72	LFO DELAY	99	This sets the time needed for the modulation by the LFO to start.	
	Delay Time	00		
73	LFO RATE	99	This sets the rate (frequency) of the LFO.	
	Rate	00		

ENV (Envelope Generator)

This generates the control voltage (Envelope) which controls the DCO, VCF and VCA, therefore, alters the pitch, tone color and volume in each note.

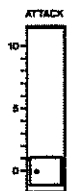
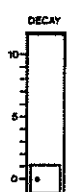
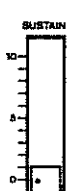
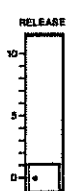
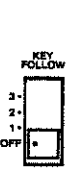
Parameter		Data Value	Function	Programmer
Number	Display			
81	ENV 1 ATT		This determines the time required for the voltage to reach its maximum from the moment the key is played.	
	ENV-1 Attack Time			
91	ENV 2 ATT			
	ENV- Attack Time			
82	ENV 1 DECAY	99	This determines the time required for the voltage to drop from the maximum to the sustain level.	
	ENV-1 Decay Time			
92	ENV 2 DECAY	)		
	ENV-2 Decay Time			
83	ENV 1 SUS	00	This sets the sustain level to which the voltage falls at the end of the decay time. Therefore, at its maximum setting, Decay Time Knob has no effect.	
	ENV-1 Sustain Level			
93	ENV 2 SUS			
	ENV-2 Sustain Level			
84	ENV 1 REL		This sets the time needed for the voltage to reach zero from the moment the key is released.	
	ENV-1 Release Time			
94	ENV 2 REL			
	ENV-2 Release Time			
85	ENV 1 KEY	3	This changes the time required for an ENV curve to complete its curve (= ENV time). At OFF, all the pitches have the same ENV time. As the value is increased, higher keys have shorter ENV time. (Note 2)	
	ENV-1 Key Follow	2		
95	ENV 2 KEY	1		
	ENV-2 Key Follow	OFF		

## PROCEDURE

- ① Push the TONE of the Edit Buttons.

The Display will respond with:

I-A4 UPPER 100 11 DC01 RANG \*\*\*

Abbreviation of the Voice Memory mode and Patch Number	Tone Number to be edited
--	--------------------------

- ② Using the relevant Ten Keys, assign the number of the parameter you wish to edit.

As shown right, push the key in the correct order, then hit the Enter Key.

- ③ As you actually hear the sound, change the value.
- ④ To continue to edit other parameter, repeat the step ② to ④.

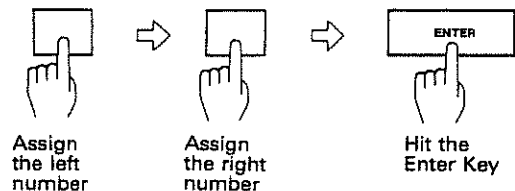

The  $\alpha$  Dial also can be used for calling a parameter. Push the TONE then the PARAM buttons, then rotate the  $\alpha$  Dial, and the parameter shown in the Display changes sequentially. When the parameter you want is shown, push the VALUE of the Edit Buttons, then edit the value with the  $\alpha$  Dial.

When you have completed editing the Tone, push the TONE button. The indicator of the TONE will go out and the Display returns to the usual indication except that the Tone Number flashes showing that the Tone is edited but not yet written into memory. If you call other Patch Memory at this stage, the edited Tone will be erased.

### c. Recalling a Tone

"Recalling a Tone" is the function which can be used during a Tone editing. While you are editing a Tone, you may want to call the original Tone which is intact to probably compare it with the one you have edited.

#### PROCEDURE

- ① Push the Recall Button **12**.

The Display will respond with:

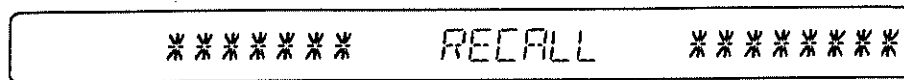

Playing the keyboard will instantly recall the original Tone.

\* Naturally, this Tone cannot be edited.

- ② Push the Recall Button.

The edited Tone is retrieved.

Likewise, each time you push the Recall Button, the original and the edited Tones are alternately called.



## 7. Writing into Memory

Editing a Patch Memory or Tone does not automatically rewrite the existing data. That is, calling other Patch Memory or Tone will erase the edited data, retaining the existing data.

To retain the edited data, you can overwrite the existing data in the internal memory, or write on the Memory Cartridge.

You can also change the names of the Patch Memories and Tones. We call this NAMING.

It is possible to edit the Patch Memory, Tones and the Names, then rewrite them altogether by one action of the writing procedure.

### NOTE

Rewriting a Tone will naturally change the Patch memories that use that Tone. In other words, if a Tone which is used in a Patch Memory is rewritten, the newly written Tone replaces the original one, therefore the Patch memories which used to contain the original Tone will now contain the new Tone. Please remember this fact, otherwise you may be puzzled at unexpected alteration of the Patch Memories when you call them later.

---

### a. Writing a Patch Memory

When you want to write the edited Patch Memory, select a location for it from A-1 to H-8. right after editing the Patch Memory (with the indicator of the PATCH button is lighted) and take the writing operation as follows.

#### PROCEDURE

- ① To write the edited Patch Memory into the JX-10's memory, set the Protect Switch on the JX-10 to the OFF position. To write onto the Cartridge memory, set the Protect Switch on the cartridge to the OFF position.
- ② Push the Write Button **Ⓜ**.

The Display will respond with:



WRITE PATCH TO \*\*\*\* \*\* OK?

A                      B  
A: Internal or Cartridge  
B: Bank and Number of the  
Patch Memory currently  
selected

If you wish to write the edited Patch Memory into the same location, in other words, to overwrite it, that is already shown in the display (Bank and Number), so skip the next step ③ and go to the step ④.

If you wish to write the edited Patch Memory into a different location, take the step ③, then go to ④.

③ Set the Voice Memory Switch ① to the appropriate position depending on which of the JX-10's memory or Cartridge memory to be used for the new location, then assign the Bank and the Number of the new location using the Patch Memory Buttons ②.

④ Push the Enter Key.

The Display will respond with as below, showing that the writing is completed, then return to the usual indication.

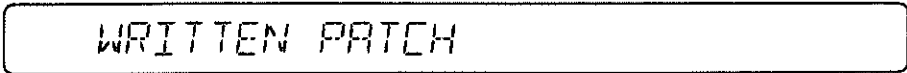

⑤ Return the Protect Switch to the ON position.

### b. Writing a Tone

The Tones of 51 to 100 in the JX-10's internal memory cannot be rewritten. Other Tones (1 to 51 in the internal memory and all 1 to 50 Tones in the cartridge) can be rewritten.

Right after you have edited the Tone (with the indicator of the TONE lighted), take the following writing operation.

① To write the edited Tone into the JX-10's internal memory, set the Protect Switch on the JX-10 to the OFF position. To write onto the Cartridge Memory, set the Protect Switch on the cartridge to the OFF position.

② Push the Write Button ⑩.

The Display will respond with:

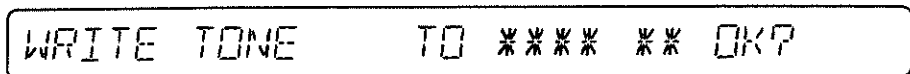

A                      B  
A: Internal or Cartridge  
B: Tone Number of the Patch  
Memory currently selected

If you wish to write the edited Tone into the same location, in other words, to overwrite it, the Tone number is already shown in the Display. So, skip the next step ③ and ④ then go to the step ⑤.

If you wish to write the edited Tone into a different location, take the step ③, then go to ④.

③ Set the Voice Memory Switch ⑥ to the appropriate position depending on which of the JX-10's memory or Cartridge memory to be used for the new location, then assign the new location (Tone Number) using the Ten Keys.

④ Push the Enter Key.

⑤ Push the Enter Key again.

The Display will respond with as below showing that the writing is completed, then return to the usual indication.



WRITTEN TONE

⑥ Return the Protect Switch to the ON position.

To cancel the Tone Writing mode before executing the writing, push the WRITE button instead of the step ⑤. The edited Tone returns without being written into memory, and the Display returns to the usual indication.

### c. Naming

For naming a Patch Memory, 18 letters are valid, and for a Tone, up to 10 letters can be used.

Naming procedures are exactly the same for a Patch Memory and a Tone, except for the first few steps which are for calling the Patch Memory or the Tone to be named.

### 1) How to call the Patch Memory to be named

- ① Call the Patch Memory to be named with the Patch Memory Buttons.
- ② Push the PATCH then the NAME of the Edit Buttons. Then go to the "3) Naming Procedure".

- Patch Name Display

↙ A dot lights up at the first letter of the Patch Name



Available range for a Patch Name

### 2) How to call the Tone to be named

- ① Call the Patch Memory which has the Tone to be named, using the Patch Memory Buttons.
- ② Select either of the Upper or Lower Tone by using the Upper/Lower Button.
- ③ Push the TONE then the NAME of the Edit Buttons. Then go to "3) Naming Procedure".

- Tone Name Display



Available range for a Tone Name

### 3) Naming Procedure

In the Display you will see a dot at the lower right corner of the letter in the left end of the name. We call this dot cursor. You can change the letter that has the cursor at its lower right corner.

- ① Press either of the Cursor Buttons ⑩ to move the cursor to the letter you wish to change.
- ② To write an alphabet, use the α Dial, and to write a number, use the Ten Keys ⑪. For other signature, use the appropriate Patch Memory Button ⑫.



\* The available characters are as shown below.

• Using α Dial

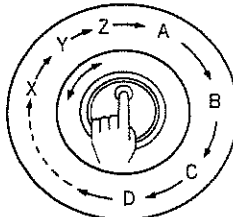

Alphabet  
(Capital Letter)

• Using Number Keys

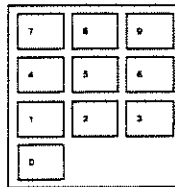

Number

• Using the Lower Patch Memory Buttons (1 to 8)

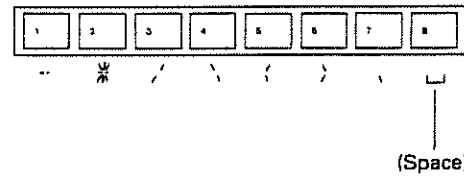

Special Signature

Repeat the above procedure as many times as necessary to complete naming.

To cancel the naming mode, push the Edit Button whose indicator is lighted. The display will return to the usual indication.

To write the name of a Patch memory, take the appropriate writing procedure as explained in "a. Writing a Patch Memory" and for writing the name of a Tone, "b. Writing a Tone".

**NOTE**

Even when a Patch Memory or Tone is edited but not yet written into memory, taking the naming procedure will automatically write the edited Patch Memory or Tone into memory erasing the original data written in memory.

#### d. Writing the Whole Data

Without separately writing each edited data such as Patch Memory, Tone, Name or the Quick Edit data, the whole edited data can be written into memory all at once.

##### PROCEDURE

- ① When you have finished all the necessary edition, push the Edit Button **Ⓜ**.

The Display will return to the usual indication, showing the relevant data is edited.

- ② Push the Write Button **Ⓜ**.

REWRITE VOICE

- ③ Push the Enter Key.

WRITTEN PATCH

After the above display, change to:

WRITTEN TONE

The whole edited data is now written into memory, and the Display will return to the usual indication.

## 8. Memory Cartridge

The Memory Cartridge can be effectively used for the Sequencer Memory that retains the sequencer data or for saving the Patch Memory or Tone data.

The JX-10's internal memory cannot store the sequencer data, therefore the Memory Cartridge is essential, while the Patch Memory and Tone data can be retained in the internal memory. The entire data of the JX-10's internal memory can be transferred to the Cartridge memory, and also the data in the Cartridge memory can be loaded back to the internal memory.

---

### a. Copying the Entire Data (All Patch Memories and 50 Tones)

All the 64 Patch Memories and the 50 Tones can be copied to the Memory Cartridge M-64C, and loaded it back to the JX-10's internal memory at any time.

#### 1) Saving

- ① Set the Protect Switch on the Memory Cartridge to the OFF position.
- ② While holding the Write Button ⑩ on the JX-10 down, push the  of the Copy Buttons ⑪.

The Display will respond with:



COPY INTERNAL MEMORY TO CARTRIDGE

- ③ Push the Enter Key.

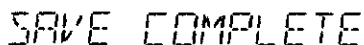

SAVE COMPLETE

When the Display shows as above, saving is complete.

In a few seconds, the Display will return to the Patch Memory indication.

- ④ Return the Protect Switch on the Memory Cartridge to the ON position.

## 2) Loading

- ① Set the Protect Switch on the JX-10 to the OFF position.
- ② While holding the Write Button down, push the  of the Copy Buttons **10**.

The Display will respond with:

COPY CARTRIDGE TO INTERNAL MEMORY

- ③ Push the Enter Key.

LOAD COMPLETE

When the Display shows as above, loading is completed.

In a few seconds, the Display will return to the Patch Memory indication.

- ④ Return the protect Switch on the JX-10 to the ON position.



## b. Copying a Patch Memory

The JX-10 allows to copy only one Patch Memory onto the Memory Cartridge or load one Patch Memory from the Cartridge memory to the internal memory.

### 1) Saving a single Patch Memory onto the Cartridge

- ① Set the Protect Switch on the Memory Cartridge to the OFF position.
- ② Set the Voice Memory Switch ⑥ to the INT position.
- ③ Call the Patch Memory to be saved onto the Cartridge.
- ④ Push the Write Button ⑩.

The Display will respond with:

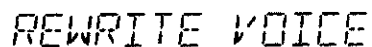

REWRITE VOICE

- ⑤ Push the PATCH of the Edit Buttons ⑪.



WRITE PATCH TO \*\*\*\* \*\* OK?

A                      B  
A: Internal or Cartridge  
B: Bank and Number of the  
Patch Memory currently  
selected

- ⑥ Set the Voice Memory Switch to the CART position.
- ⑦ Using the Patch Memory Buttons, ⑫ assign the Bank and the Number of the Patch Memory that is to be the new location for the Patch Memory you have selected in the step ③.
- ⑧ Push the Enter Key.
- ⑨ Return the Protect Switch on the Memory Cartridge to the ON position.

2) Loading a single Patch Memory to the JX-10's internal memory

- ① Set the Protect Switch on the JX-10 to the OFF position.
- ② Set the Voice Memory Switch ⑩ to the CART position.
- ③ Call the Patch Memory to be copied to the JX-10.
- ④ Push the Write Button ⑪.

The Display will respond with:

REWRITE VOICE

- ⑤ Push the PATCH of the Edit Buttons ⑫.

WRITE PATCH TO \*\*\*\* \*\* OK?

A                      B  
A: Internal or Cartridge  
B: Bank and Number of the  
Patch Memory currently  
selected

- ⑥ Set the Voice Memory Switch to the INT position.
- ⑦ Using the Patch Memory Buttons ⑬, assign the Bank and the Number of the new location on the JX-10 where the Patch Memory you have called in the step ③ is to be copied.
- ⑧ Push the Enter Key.
- ⑨ Return the Protect Switch on the JX-10 to the ON position.

**NOTE**

When a Patch Memory is copied from the internal memory to the Cartridge and vice versa, the Tones used for the Patch Memory are also copied. Therefore corresponding Tone numbers will be rewritten.

### c. Copying a Tone

A Tone in the JX-10's internal memory can be copied onto the Memory Cartridge and vice versa.

#### 1) Saving a Tone to the Cartridge

- ① Set the Protect Switch on the Memory Cartridge to the OFF position.
- ② Set the Voice Memory Switch ⑥ to the INT position.
- ③ Call the Patch Memory that contains the Tone you wish to copy.

\* In the Dual or Split mode, the Tone with a dot is copied. In the Upper whole mode, the Tone of the Upper section is copied.

- ④ Push the Write Button ⑩.

The Display will respond with:

REWRITE VOICE

- ⑤ Push the TONE of the Edit Buttons ⑪.

WRITE TONE TO           OK?

A                      B

A: Internal or Cartridge  
B: Tone Number of the Patch  
Memory currently selected

- ⑥ Set the Voice Memory Switch to the position.
- ⑦ Using the Ten Keys, assign the new location (= Tone number) where you wish the Tone you called in the step ③ to be copied.
- ⑧ Push the Enter Key.
- ⑨ Return the Protect Switch on the Memory Cartridge to the ON position.

2) Copying a Tone in the Cartridge to the JX-10's internal memory

- ① Set the Protect Switch on the JX-10 to the OFF position.
- ② Set the Voice Memory Switch to the CART position.
- ③ Call the Patch Memory that contains the Tone to be copied.

\* In the Dual or Split mode, the Tone with a dot is copied. In the Upper Whole mode, the Tone of the Upper section is copied.

- ④ Push the Write Button .

The Display will respond with:

REWRITE VOICE

- ⑤ Push the TONE of the Edit Buttons.

WRITE TONE TO \*\*\*\* \*\* OK?

A                      B  
A: Internal or Cartridge  
B: Tone Number of the Patch Memory currently selected

- ⑥ Set the Voice Memory Switch to the INT position.
- ⑦ Using the Ten Keys, assign the new location (= Tone number) where you wish the Tone you called in the step ③ to be copied.
- ⑧ Push the Enter Key.
- ⑨ Return the Protect Switch on the JX-10 to the ON position.

## 9. Other Useful Functions

### a. Tuning

You can tune the JX-10 using the  $\alpha$  Dial as follows.

- ① With the Display showing the Patch Memory, push the Master Tune Button ⑨.
- ② As you play the keyboard, tune the JX-10 by rotating the  $\alpha$  Dial.

As you rotate the  $\alpha$  Dial clockwise, the created pitch will be higher and counterclockwise will lower the pitch.

The Display will show the set pitch.



The pitch shown in the Display changes in 1Hz steps, but the actual pitch changes continuously.

- ③ Set the Protect Switch on the JX-10 to the OFF position, and push the Write Button ⑩.

The Display will respond with as below, showing the tuning is completed.



- ④ Return the Protect Switch on the JX-10 to the ON position.

## b. Function Display

Even while you are playing the keyboard, you can change what is currently shown in the Display to other indication. Three different displays are optional as follows.

- **Tone Name:** The names of the Tones currently in use are displayed.
- **Split Point:** In the Split mode, the Split Points of the Lower and Upper sections are displayed.
- **MIDI Channel:** The MIDI Channel number currently in use is displayed.

If you wish to see any of the left three displays, simply press the Function Display Button **F**, and the Display changes from the usual indication to Tone Name, Split Point and MIDI Channel as shown below.

While the Tone number is being displayed, selecting a different Tone will display the new Tone number.

When you call a different Patch Memory, the Function Display will accordingly change.

To return to the usual Display, push the Enter Key.

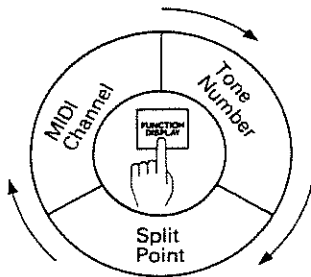

\* To return to the usual display, push the Enter Key.

### Tone Name

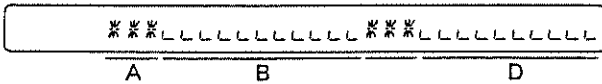

- A: Tone Number of Lower Section
- B: Tone Name of Lower Section
- C: Tone Number of Upper Section
- D: Tone Name of Upper Section

### Split Point

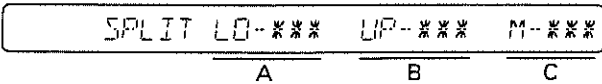

- A: The highest note of the Lower Section
- B: The lowest note of the Upper Section
- C: When the Split Point is set with MIDI Send, it will be displayed

### MIDI Channel

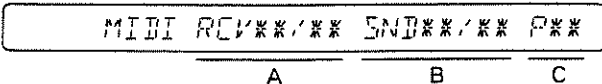

- A: MIDI Channel number of the Receiver (LOWER/UPPER)
- B: MIDI Channel number of the Transmitter (LOWER/UPPER)
- C: Patch Memory Channel (These are displayed when they have been set with MIDI Send.)

For the detailed explanation, see "MIDI" on page 56.

### c. Error Messages

If the Display reacts differently from what is said in the manual, (we call this error message), it is most likely that you have taken a wrong operation. The following shows the error messages of the JX-10 and explains how to correct them.

1) **MEMORY PROTECTED**

You have tried to take writing procedure without setting the relevant Protect Switch to the OFF position. When the Voice Memory Switch on the JX-10 is set to the INT position, the Protect Switch on the JX-10 should be set to the OFF, and when it is in the CART position, the Protect Switch on the Cartridge should be set to the OFF position.

2) **INSERT CARTRIDGE**

When the Voice Memory Switch is set to the CART position, in other words, when the JX-10 is in the Cartridge mode, this error message may be seen if the cartridge is not securely connected. Remove the cartridge then securely connect it in the correct direction (with the Protect Switch side facing upward).

3) **MISMATCH**

This error message is indicated when you have tried to use the Memory Cartridge for the sequencer data to calling or writing Patch Memory or Tone data, and vice versa. Change the cartridge to the correct one.

However, if you wish to clear the data on the cartridge currently connected and use it for different data, repeat the same writing procedure you have taken twice more. The Display will show MISMATCH again at the first time, but just carry on, writing will be done at the second time.

4) **NOT M-64C**

This error message is shown when you have tried to write Patch Memory and Tone data onto the M-16C which does not have the capacity to store it. Change the cartridge to the M-64C.

5) **SELECT NO. 1-50**

This error message is shown when you have tried to write the edited Tone to the Tone Number other than 1 to 50. Tone numbers from 51 to 100 are ROM, therefore cannot be rewritten.

6) **SELECT NO. 1-32**

When using the Memory Cartridge of the JX-8P, this error message is seen by assigning the Tone numbers other than 1 to 32.

7) **MEMORY FULL**

When writing the Sequencer data, this error message is displayed to tell that the memory is full. No more data can be written into memory, so you need to cut down the data.

8) **MEMORY ERR**

When this is shown several times, the JX-10 is in trouble. You need to have it repaired.

## 10. MIDI

Read the separate book "MIDI" before entering this chapter.

The JX-10 can be set up with other MIDI devices as shown below.

### 1. Controlling other MIDI device with the JX-10



### 2. Controlling the JX-10 with other MIDI device



\* The MIDI signal fed into MIDI IN of the JX-10 is not sent out through MIDI OUT.

### 3. Using THRU

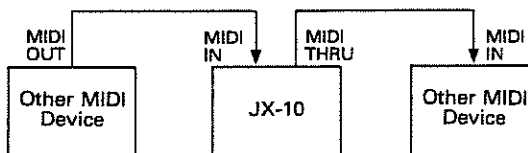

The JX-10 allows to write some MIDI functions with each Patch Memory. Therefore, when the JX-10 is controlling other MIDI device, changing Patch Memories on the JX-10 will automatically change the relevant transmitting MIDI functions. In other words, some MIDI functions are Factors of Patch Memories.



## a. Receiving and Transmitting MIDI Messages

### 1) Setting MIDI Channels

The JX-10's MIDI allows to set two different channels separately for the Upper and the Lower sections.

Even when different channels are assigned to the upper and the lower, in the Dual Key Mode, the JX-10 will be played with the Note ON/OFF messages (Key information) sent on the MIDI channel assigned to the upper. The MIDI channel of the lower is ignored. Likewise, when the Key Mode is the Lower Whole, the JX-10 is played with the Note ON/OFF messages of the lower section. And when in the Split Key Mode, the upper and lower sections are played independently with the messages sent on each MIDI channel.

The Program Change messages basically work to change the Tone Numbers. Therefore, if two different MIDI channels are separately set for the upper and the lower sections, the Tone of each section can be changed independently.

The Program Change messages can also change the Patch Memories. This is fully explained later in "Selecting a Patch Memory with MIDI Program Change".

- 
- ① Push the MIDI of the Edit Buttons .

The corresponding indicator will light up, and the Display will show the MIDI function previously selected.

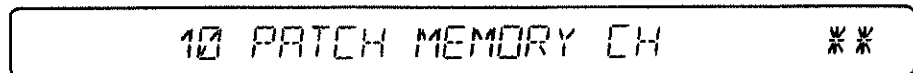

Now, using the Ten Keys , assign the number of the MIDI Function you wish to change. Here, it is MIDI Channel for the upper section, so the number is 2, 0.

- ② Push 2, 0 and ENTER of the Ten Keys.
- ③ Using the  $\alpha$  Dial, change the MIDI channel number.

To set the MIDI channel for the lower section, push 3, 0 and ENTER in the step ②.

The MIDI channels you have set as this will be erased from the memory of the JX-10 unless you follow the writing procedure.

### Writing Procedure

- ① Set the Protect Switch on the JX-10 to the OFF position.
- ② Push the WRITE button , then the Enter Key.

WRITTEN MIDI

The Display will react as above, then return to the Patch Memory indication.

- ③ Return the Protect Switch on the JX-10 to the ON position.

---

### 2) Selecting a Patch Memory with MIDI Program Change

You can select a Patch Memory using the MIDI program change messages. In this case, a MIDI channel different from those used for the upper and the lower sections is available. This is useful for when playing the JX-10 with a computer; you can change the Tones of the upper and the lower using corresponding channels and change the Patch Memories using the third channel (Patch Memory CH).

\* The JX-10 is designed to produce no sound while you are changing Patch Memories. This serves to mute the noise which otherwise would be heard. If you do not like cutting sound, instead of changing Patch Memories, change the Tones. In this way, you can call the sound you like without any silence at all.

If you assign the same channels to the Patch Memory (Patch Memory CH) and the upper section (Upper MIDI CH), the Program Change of the upper MIDI channel can change the Patch Memories. In this case, however, the Tone numbers of the upper cannot be changed with the Program Change.

Only when the lower MIDI channel is different from that of the upper, the lower Tone numbers can be changed.

To set the MIDI channel for the Patch Memory, call the Function number 10 with the Ten Keys and set the channel number (1 to 16, OFF) with the  $\alpha$  Dial. Select OFF, if you do not need to change Patch Memories with the Program Change.

### 3) Program Change ON/OFF

The Program Change ON/OFF function can select whether to use Program Change or not. On/Off can be set independently for the upper and the lower.

Call the upper or lower using the corresponding number (21 for Upper, 31 for Lower), then select ON or OFF using the  $\alpha$  Dial.

### 4) Other MIDI Functions

The following MIDI Functions can be set to ON or OFF using the  $\alpha$  Dial.

- **Aftertouch**  
Upper ..... Number 22  
Lower ..... Number 32
- **Bender**  
Upper ..... Number 24  
Lower ..... Number 34
- **Modulation**  
Upper ..... Number 25  
Lower ..... Number 35
- **Portamento**  
Upper ..... Number 26  
Lower ..... Number 36
- **Hold**  
Upper ..... Number 27  
Lower ..... Number 37
- **Volume**  
Upper ..... Number 28  
Lower ..... Number 38

The Volume On/OFF can be set with the  $\alpha$  Dial, but selecting the MIDI Volume with the Control Assign will automatically set it to ON.

- **System Exclusive**

This message is not affected by channel setting. Call it by assigning its Function Number 11, then turn it on or off with the  $\alpha$  Dial.

- **Local**  
Upper ..... Number 23  
Lower ..... Number 33

Usually this function should be set to ON. Local OFF separates the keyboard section from the synthesizer section. Therefore, the keyboard messages sent out from the MIDI OUT does not cause the JX-10 to sound. The JX-10's synthesizer section is played with the messages fed into the MIDI IN.

\* For assigning the Function Number of a MIDI message, the  $\alpha$  Dial can be used instead of the Ten Keys. After pushing the MIDI then PARAM, rotate the  $\alpha$  Dial, and the Function shown in the Display will change in sequence. When the Function you wish to edit appears in the Display, push the VALUE of the Edit Buttons, then change value with the  $\alpha$  Dial. However, to continue to edit other Function, be sure to push the PARAM button, then call the Function you want by using the  $\alpha$  Dial.

\* To cancel the MIDI function editing mode, simply push the MIDI of the Edit Buttons **11**.

**b. MIDI Functions available for a Patch Memory**

The MIDI Function shown in the following table can be written into memory as Factors of a Patch memory. You may, however, want the JX-10 to send the MIDI messages to the receiver without being affected by the Patch Memory's MIDI setting. If so, you can turn the relevant MIDI Functions in a Patch Memory off. The necessary procedure is exactly the same as when editing a Patch Memory.

Upper MIDI Channel	61
Lower MIDI Channel	62

61 UP MIDI CH SEND \*\*\*

62 LO MIDI CH SEND \*\*\*

1  
to  
16  
OFF

These Factors can select 1-16 number or OFF for the Uper and Lower separately.

Upper Program Change	63
Lower program Change	64

63 UP PROG CHANGE SEND \*\*\*

64 LO PROG CHANGE SEND \*\*\*

1  
to  
128  
OFF

These Factors can select 1-128 Program Change or OFF separately for the Upper and the Lower sections.

Upper Volume	65
Lower Volume	66

65 UPPER VOLUME SEND \*\*\*

66 LOWER VOLUME SEND \*\*\*

00  
to  
99  
OFF

These Factors are used for transmitting the Volume messages in the Control Change separately on the MIDI Channels selected by the Upper and the Lower.

Key Mode 67

67 MIDI KEY MODE \*\*\*\*\*

UPPER,  
LOWER,  
SPLIT,  
LAYER  
OFF

This Factor can select Upper, Lower, Split, Layer or Off independently of the Key Mode set on the JX-10. The Upper mode sends the JX-10's keyboard information on the MIDI channel selected at the Upper. Likewise, the Lower mode sends it on the channel of the Lower. The Split mode sends it separately on the Upper and Lower at the Split Point set with Number 68. The Layer mode sends the entire information on the both channels of the Upper and Lower. At OFF, no information is sent with MIDI, therefore sent with the Key Mode set on the JX-10.

Split Point 68

68 MIDI SPLIT POINT \*\*\*

1E  
to  
7G

When the SPLIT is selected at Number 67, this Factor 68 serves to set the Split Point. Set it with the Octave number and Note name from 1E to 7G.

# JX-10 Operation Table

## A. Selecting a Patch Memory

Page 11

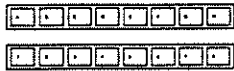

## B. Control Knobs

Page 12

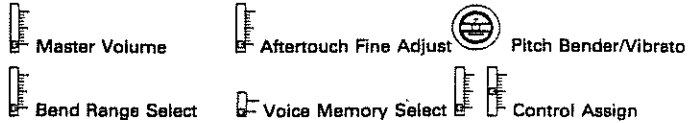

## C. Quick Edit of Patch Memory

Page 16

### 1. Key Mode

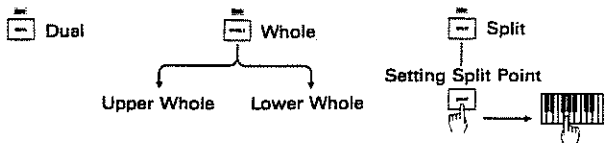

### 2. Tone Number

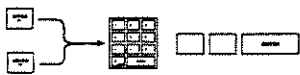

### 3. Chase Play

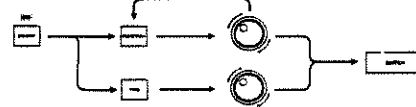

## D. Control Assign

Page 14



## E. Sequencer (with Memory Cartridge)

Page 21

### 1. Recording

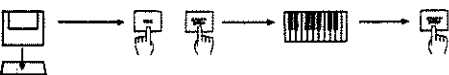

### 2. Playback



## F. Editing a Patch Memory

Page 24

1



2



## G. Editing a Tone

Page 31

1



### 3. Recalling a Tone



2



## H. Writing

Page 41

### 1. Rewriting a Patch Memory and Tones all at once

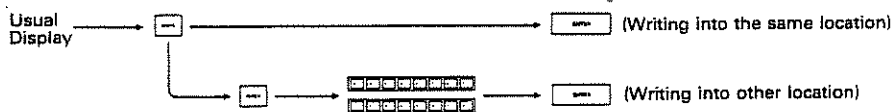

### 2. Writing a Patch Memory



### 3. Writing a Tone

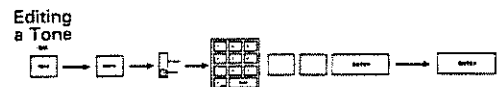

## I. Naming

Page 43

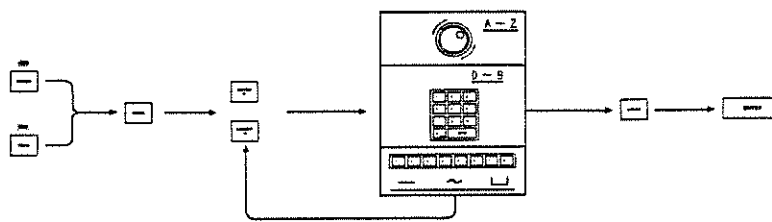

## J. Memory Cartridge (Copy)

Page 47

### 1. Saving

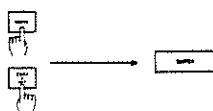

### 3. Copying a single Patch Memory

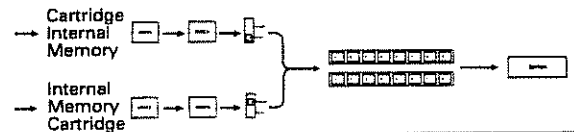

### 2. Loading

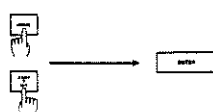

### 4. Copying a single Tone

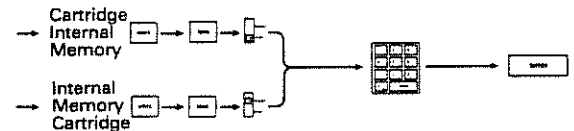

## K. Tuning

Page 53



## L. Function Display

Page 54

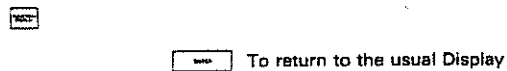

## M. MIDI

Page 56

### 1. Setting Receive and Transmit Messages



### 2. Setting Transmit Messages

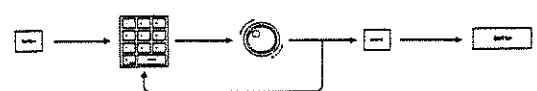

12-voice polyphonic synthesizer

MODEL **JX-10** MIDI Implementation Chart

Date : Feb. 19. 1981  
Version : 1.00

Function.....		Transmitted	Recognized	Remarks
Basic Channel	Default Changed	UP:1-16 LO:1-16 UP:1-16 LO:1-16	UP:1-16 LO:1-16 LO:1-16 LO:1-16	memorized
Mode	Default Messages Altered	Mode 3 OMNI OFF, POLY *****	Mode 3 X	memorized
Note Number	True voice	28 - 103 *****	0 - 127 21 - 108	
Velocity	Note ON Note OFF	○ X 9n v=0	○ v=1-127 X	
After Touch	Key's Ch's	X ○	X *	
Pitch Bender		*	* 2/3/4/7 semi	8 bits reso.
Control Change	1 5 7 64 65	* ○ * * *	* ○ * * *	Modulation Portamento Time Volume Hold SW. Portamento SW.
Prog Change	True #	* 0-99 (0-127) *****	* 0-99 (0-127) 0-99 (0-127)	**
System Exclusive		*	*	
System Common	Song Pos Song Sel Tune	X X X	X X X	
System Real Time	Clock Commands	○ When sequencer ○ cartridge is set	X X	
Aux Messages	Local ON/OFF All Notes OFF Active Sense Reset	X ○ X X	○ ○ (123-127) X X	Default ON
Notes		* Can be set to ○ or X manually, and memorized. ** As tone # : 0-99 (100-127 ignored if received.) As patch # : 0-127 As optional Prog # (transmitted only) : 0-127 See each implementation notes for details.		

Mode 1 : OMNI ON. POLY  
Mode 3 : OMNI OFF. POLY

Mode 2 : OMNI ON. MONO  
Mode 4 : OMNI OFF. MONO

○ : Yes  
X : No



# 12-voice polyphonic synthesizer

## MODEL JX-10 MIDI Implementation

Date : Feb. 19, 1986  
Version : 1.00

### 1. TRANSMITTED DATA

Status	Second	Third	Description	
1001 nnnn	0kkk kkkk	0000 0000	Note OFF kkkkkkk = 28 - 103	
1001 nnnn	0kkk kkkk	0vvv vvvv	Note ON kkkkkkk = 28 - 103 vvvvvvv = 1 - 127	
1011 nnnn	0000 0001	0vvv vvvv	Modulation vvvvvvv = 0 - 127	*1
1011 nnnn	0000 0101	0vvv vvvv	Portamento time vvvvvvv = 0 - 127	
1011 nnnn	0000 0111	0vvv vvvv	Volume vvvvvvv = 0 - 127	*1,*2
1011 nnnn	0100 0000	0111 1111	Hold ON	*1
1011 nnnn	0100 0000	0000 0000	Hold OFF	*1
1011 nnnn	0100 0001	0111 1111	Portamento ON	*1
1011 nnnn	0100 0001	0000 0000	Portamento OFF	*1
1100 nnnn	0ppp pppp		Program Change ppppppp = 0 - 99 (0 - 127)	*1,*3
1101 nnnn	0vvv vvvv		Channel After Touch vvvvvvv = 0 - 127	
1110 nnnn	0vvv vvvv	0vvv vvvv	Pitch Bender Change	*1
1011 nnnn	0111 1011	0000 0000	ALL NOTES OFF	*4
1011 nnnn	0111 1100	0000 0000	OMNI OFF	*5
1011 nnnn	0111 1111	0000 0000	POLY ON	*5
1111 1000			Timing clock	*6
1111 1010			Start	*6
1111 1100			Stop	*6

#### Notes :

Normally, transmitting channel depends on UPPER/LOWER CHANNEL and KEY MODE.  
If MIDI SEND OPTION UPPER/LOWER CHANNEL and MIDI SEND OPTION KEY MODE is set, channels are followed to its settings.

- \*1 Transmitted if the corresponding function switch is ON.
- \*2 a. When 'C1' or 'C2' slider is assigned as VOLUME, and moved :  
The value is transmitted if the corresponding function switch is ON.  
b. When PATCH # is changed :  
MIDI SEND OPTION VOLUME is transmitted if it was set.
- \*3 a. When TONE # is changed :  
TONE # is transmitted if the corresponding function switch is ON.  
ppppppp = 0 - 99 : TONE No. 1 - 100  
b. When PATCH No. is changed :  
TONE # for new PATCH is transmitted. (See note a.)  
If OPTION PROGRAM CHANGE NUMBER is set, the Number is transmitted instead of TONE #.  
ppppppp = 0 - 127 : PROGRAM CHANGE NUMBER 1 - 128  
If PATCH MEMORY CHANNEL is set, PATCH # is transmitted to PATCH MEMORY CHANNEL, after transmitting TONE # (or OPTION PROGRAM CHANGE NUMBER).  
ppppppp = 0 - 83 : Internal Memory PATCH A1 - H8  
84 - 127 : Cartridge Memory PATCH A1 - H8
- \*4 When all keys on the keyboard are released, this message is sent.
- \*5 When power is first applied while MIDI button being held down, these messages are transmitted for all channels (1-16).
- \*6 When the CARTRIDGE - that stores sequence data - is set.

### 2. RECOGNIZED RECEIVE DATA

Status	Second	Third	Description	
1000 nnnn	0kkk kkkk	0vvv vvvv	Note OFF, velocity ignored	
1001 nnnn	0kkk kkkk	0000 0000	Note OFF kkkkkkk = 0 - 127 (21 - 108) *1	
1001 nnnn	0kkk kkkk	0vvv vvvv	Note ON kkkkkkk = 0 - 127 (21 - 108) *1 vvvvvvv = 1 - 127	
1011 nnnn	0000 0001	0vvv vvvv	Modulation vvvvvvv = 0 - 127	*2
1011 nnnn	0000 0101	0vvv vvvv	Portamento time vvvvvvv = 0 - 127	
1011 nnnn	0000 0111	0vvv vvvv	Volume vvvvvvv = 0 - 127	*2
1011 nnnn	0100 0000	01xx xxxx	Hold ON	*2
1011 nnnn	0100 0000	00xx xxxx	Hold OFF	*2
1011 nnnn	0100 0001	01xx xxxx	Portamento ON	*2
1011 nnnn	0100 0001	00xx xxxx	Portamento OFF	*2
1100 nnnn	0ppp pppp		Program Change vvvvvvv = 0 - 127 (0 - 99) *2,*3	
1101 nnnn	0vvv vvvv		Channel After Touch vvvvvvv = 0 - 127	*2
1110 nnnn	0vxx xxxx	0vvv vvvv	Pitch Bender Change	*2
1011 nnnn	0111 1010	0000 0000	Local OFF	*2
1011 nnnn	0111 1010	0111 1111	Local ON	*2
1011 nnnn	0111 1011	0000 0000	ALL NOTES OFF	

### Notes :

All messages except PATCH# (Program Change) are received from UPPER and/or LOWER CHANNEL according to KEY MODE.

\*1 Note numbers outside of the range 21 - 108 are transposed to the nearest octave inside this range.

\*2 Received if the corresponding function switch is ON.

- \*3 a. When PATCH MEMORY CHANNEL is OFF :  
Received as TONE # if the corresponding function switch is ON.  
ppppppp = 0 - 99 : TONE No. 1 - 100
- b. When PATCH MEMORY CHANNEL is set :  
Received as PATCH #, from PATCH MEMORY CHANNEL.  
ppppppp = 0 - 83 : Internal Memory PATCH A1 - H8  
84 - 127 : Cartridge Memory PATCH A1 - H8

### 3. HANDSHAKING COMMUNICATION

- \* How to enter to 'DUMP' or 'LOAD' mode :  
1. Press both MIDI and WRITE button.  
2. Select DUMP or LOAD by ALPHA-DIAL, then press ENTER.

\* Exclusive messages are transmitted and received if SYSTEM EXCLUSIVE (MIDI FUNCTION #111) is ON.

#### 3.1 Message type

##### 3.1.1 Want to send a file (WSF)

Byte	Description	
a 1111 0000	Exclusive status	
b 0100 0001	Roland ID #	
c 0100 0000	Operation code = WSF	
d 0000 nnnn	Unit # = UPPER MIDI basic channel, nnnn = 0 - 16 where nnnn + 1 = channel #	
e 0010 0100	Format type ( JX-10 )	
f 0fff ffff	File name ( 1 byte )	*1
g 0aaa aaaa	Check sum	*2
h 1111 0111	End of System Exclusive	

##### 3.1.2 Request a file (RQF)

Byte	Description	
a 1111 0000	Exclusive status	
b 0100 0001	Roland ID #	
c 0100 0001	Operation code = RQF	
d 0000 nnnn	Unit # = UPPER MIDI basic channel, nnnn = 0 - 15 where nnnn + 1 = channel #	
e 0010 0100	Format type ( JX-10 )	
f 0fff ffff	File name ( 1 byte )	*1
g 0aaa aaaa	Check sum	*2
h 1111 0111	End of System Exclusive	

#### Notes :

\*1 There are two kinds of file names as shown below.

Byte	Description
f 0001 0110	Memory Cartridge M-16C
f 0110 0100	Memory Cartridge M-84C

\*2 Summed value of the byte of file name and the check sum must be 0 (7bits).

##### 3.1.3 Data (DAT)

Byte	Description	
a 1111 0000	Exclusive status	
b 0100 0001	Roland ID #	
c 0100 0010	Operation code = DAT	
d 0000 nnnn	Unit # = UPPER MIDI basic channel, nnnn = 0 - 15 where nnnn + 1 = channel #	
e 0010 0100	Format type ( JX-10 )	
f 0000 tttt	CARTRIDGE MEMORY data (repeated 256 times = 128 bytes)	*1
g 0aaa aaaa	Check sum	*2
h 1111 0111	End of System Exclusive	

#### Notes :

\*1 CARTRIDGE MEMORY data is sent in four-bit nibbles.

##### \*data format

CRTRIDGE MEMORY data		send data	
byte		byte	
1	aaaa bbbb	1	0000 aaaa
		2	0000 bbbb
2	cccc dddd	3	0000 cccc
		4	0000 dddd

\*2 Summed value of the all bytes in data and the check sum must be 0 (7bits).

##### 3.1.4 Acknowledge (ACK)

Byte	Description
a 1111 0000	Exclusive status
b 0100 0001	Roland ID #
c 0100 0011	Operation code = ACK
d 0000 nnnn	Unit # = UPPER MIDI basic channel, nnnn = 0 - 15 where nnnn + 1 = channel #
e 0010 0100	Format type ( JX-10 )
f 1111 0111	End of System Exclusive

3.1.5 End of file (EOF)

Byte	Description
a 1111 0000	Exclusive status
b 0100 0001	Roland ID #
c 0100 0101	Operation code = EOF
d 0000 nnnn	Unit # = UPPER MIDI basic channel, nnnn = 0 - 15 where nnnn + 1 = channel #
e 0010 0100	Format type { JX-10 }
f 1111 0111	End of System Exclusive

3.1.6 Communication error (ERR)

Byte	Description
a 1111 0000	Exclusive status
b 0100 0001	Roland ID #
c 0100 1110	Operation code = ERR
d 0000 nnnn	Unit # = UPPER MIDI basic channel, nnnn = 0 - 15 where nnnn + 1 = channel #
e 0010 0100	Format type { JX-10 }
f 1111 0111	End of System Exclusive

3.1.7 Rejection (RJC)

Byte	Description
a 1111 0000	Exclusive status
b 0100 0001	Roland ID #
c 0100 1111	Operation code = RJC
d 0000 nnnn	Unit # = UPPER MIDI basic channel, nnnn = 0 - 15 where nnnn + 1 = channel #
e 0010 0100	Format type { JX-10 }
f 1111 0111	End of System Exclusive

3.2 Sequence of communication

3.2.1 In the 'Dump' mode.

this unit	message	objective unit
	WSF ----->	
	<----- ACK or ( RQF )	
	DAT ----->	
	<----- ACK	
	:	
	:	
	DAT ----->	
	<----- ACK	
	EOF ----->	
	<----- ACK	

3.2.2 In the 'Load' mode.

this unit	message	objective unit
	RQF ----->	
	( <----- WSP	
	ACK -----> )	
	<----- DAT	
	ACK ----->	
	:	
	:	
	<----- DAT	
	ACK ----->	
	<----- EOF	
	ACK ----->	

Notes :

- \* This unit sends RJC and the sequence is discontinued when it receives ERR or detects some error.
- \* This unit sends RJC when the sequence is discontinued manually.
- \* This unit stops the sequence if unit receives RJC.
- \* IF the CARTRIDGE is M-16C, then DAT message repeats 16 times.  
IF the CARTRIDGE is M-84C, then DAT message repeats 64 times.

## **5** SPECIFICATIONS

**The JX-10:** 12 Voice Polyphonic Synthesizer with Dynamics and Aftertouch

**Keyboard:** 76 Keys

**Memory:**

**a. Patch Memory**

Internal Memory: 64 Patch Memories  
Memory Cartridge: 64 Patch Memories

**b. Tone**

Preset: 50 Tones  
Internal Memory: 50 Tones  
Memory Cartridge: 50 Tones

**c. Sequencer Data**

(using the supplied Memory Cartridge M-16C or M-64C)

M-16C: Approx. 400 notes  
M-64C: Approx. 1600 notes

**Edit Functions**

Patch Memory Factors  
Tone Parameters  
MIDI Functions  
Naming Function  
Master Tune Function

### **Front Panel**

**Panel Switches**

Ten Keys (0 to 9, ENTER)  
Patch Memory Selectors (A to H, 1 to 8)  
Chase Play Buttons (ON/OFF, FUNCTION, TIME)  
Sequencer Buttons  
(FUNCTION, START/STOP, REC)  
Control Assign Buttons (PEDAL SWITCH, C1, C2)  
Key Mode Buttons (WHOLE, DUAL, SPLIT)  
Edit Buttons  
(PATCH, TONE, MIDI, PARAM, VALUE, NAME)  
Function Display  
Recall Button  
Upper/Lower Select (or Cursor Up/Down) Button  
Copy Button  
Write Button  
Master Tune Button

**Control Knobs and Switches**

Bender Lever  
Bend Range Selector  
Voice Memory Selector  
Control Assign  
Aftertouch Fine Adjust  
Volume

**Display**

32 figures, Fluorescent Indicator

**Memory Cartridge Holder**

Compatible with M-16C or M-64C

### **Rear Panel**

Mixed Output Jack  
Parallel Output Jack × 4  
Headphones Jack  
Output Level Switch  
Hold Pedal Jack  
Control Assign Jack  
MIDI Connector × 3  
Programmer Connector  
Protect Switch  
Power Switch

**Dimensions:**

1186(W) × 375(D) × 101(H) mm  
46<sup>11</sup>/<sub>16</sub>" × 14<sup>3</sup>/<sub>4</sub>" × 4"

**Weight:** 14 kg/30 lb 14 oz

**Consumption:** 28W

### **Accessories**

**Connection Cord** × 2

**Memory Cartridge**

M-16C × 1  
M-64C × 1

**Edit Map**

**Music Rest**

**Owner's Manual**

**MIDI Guide Book "MIDI"**

### **OPTIONS**

**Programmer PG-800**

**Expression Pedal EV-5**

**Pedal Switch DP-6, DP-2**

**Memory Cartridge M-16C, M-64C**

**Carrying Case**



# **JX-10**

**Supplementary  
explanation**

**on**

**MIDI**

 **Roland**

## JX-10-MIDI DATA Factory Preset

### ■ Patch Memory Factor

No.	Factor Name	Value
61	UP MIDI CH SEND	OFF
62	LO MIDI CH SEND	OFF
63	UP PROG CHANGE SEND	OFF
64	LO PROG CHANGE SEND	OFF
65	UPPER VOLUME SEND	99
66	LOWER VOLUME SEND	99
67	MIDI KEY MODE	OFF
68	MIDI SPLIT POINT	C4

## ■ MIDI FUNCTION

No.	Function Name	Value
10	PATCH MEMORY CH	1
11	SYSTEM EXCLUSIVE	ON
20	UPPER MIDI CH	1
30	LOWER MIDI CH	2
21, 31	PROG CHANGE	OFF
22, 32	AFTER TOUCH RECEIVE	ON
23, 33	LOCAL	ON
24, 34	BENDER	ON
25, 35	MODULATION	ON
26, 36	PORTAMENTO	ON
27, 37	HOLD	ON
28, 38	VOLUME	ON

**1 Sending the Program Change to the MIDI Sound Module by changing Patch Memories on the JX-10.**

\* MIDI Setting on the JX-10.

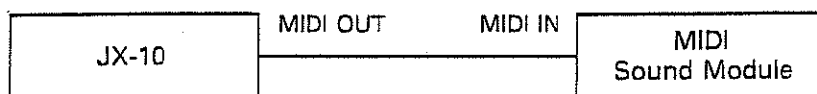

● **MIDI setting on the MIDI Sound Module**

MIDI CHANNEL ..... 1  
 PROGRAM CHANGE ..... ON

In this setting the Program Change Number which corresponds to the Bank and Number of the Patch Memory you have selected is sent on the MIDI CH 1 of the MIDI Sound Module.

	Bank and Number of the JX-10 (Bank) (Number)	MIDI Program Change No. which is sent
INTERNAL	A — 1	1
INTERNAL	H — 8	64
CARTRIDGE	A — 1	65
CARTRIDGE	H — 8	128



**2 Sending Program Change to the Sound Module by changing Tone numbers on the JX-10.**

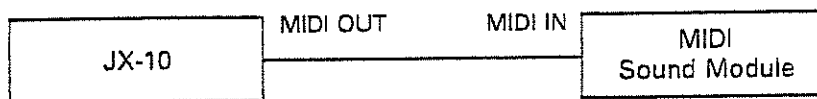

● **MIDI setting on the MIDI Sound Module**

MIDI CH ..... 1  
 PROGRAM CHANGE ..... ON

● **MIDI setting on the JX-10**

[10 PATCH MEMORY CH → OFF]  
 [20 UPPER MIDI CH → 1]  
 [21 UP PROGRAM CHANGE → ON]  
 [31 LO PROGRAM CHANGE → OFF]

In this setting, the Program Change number which corresponds to the Tone number of the Upper section you have selected is sent on the MIDI CH 1 of the MIDI Sound Module.

Tone number of the JX-10	MIDI Program Change number which is sent
1	1
50	50
100	100

**3 Sending two different Program Change numbers separately to two MIDI Sound Modules by changing Patch Memories on the JX-10.**

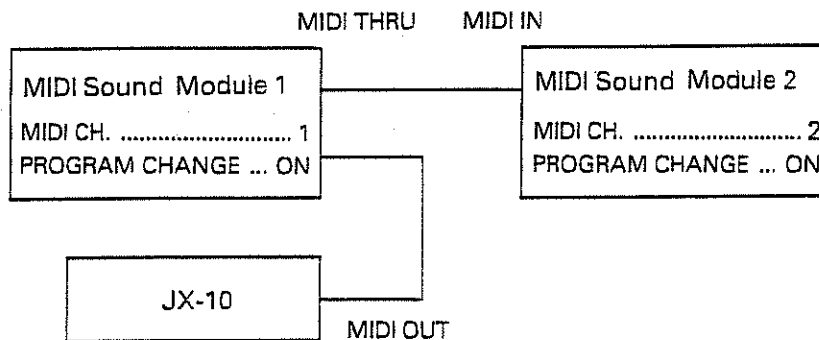

● **MIDI setting on the JX-10**

- [10 PATCH MEMORY CH → OFF]
- [20 UPPER MIDI CH → 1]
- [30 LOWER MIDI CH → 2]
- [21 UP PROGRAM CHANGE → ON]
- [31 LO PROGRAM CHANGE → ON]

In this setting, the Program Change number which corresponds to the Tone number of the Upper section in the Patch Memory you have selected is sent on the MIDI CH 1 of the MIDI Sound Module 1. Likewise the Program Change number assigned to the Lower Tone number is sent on the MIDI CH 2 of the MIDI Sound Module 2. (only when the Factors 63 and 64, "PROGRAM CHANGE SEND" of the Patch Memory are set to OFF)

How to assign the Program Change number to the Tone number is the same as the way of [2] on page 5.

The Factors 63 and 64 "PROGRAM CHANGE SEND" of the Patch Memory can be set separately from the value 1 to 128. The Upper and Lower Program Change numbers which you have set in the Factors 63 and 64 are transmitted independently to each MIDI CH of the MIDI Sound Modules regardless of Program Change ON/OFF messages of the Upper and Lower sections in the MIDI functions.

TONE NUMBER		PROGRAM CHANGE SEND		PROGRAM CHANGE NUMBER	
31 UPPER	41 LOWER	63 UPPER	64 LOWER	UPPER	LOWER
1	2	OFF	OFF	1	2
1	2	3	4	3	4

## 4 MIDI CHANNEL SEND

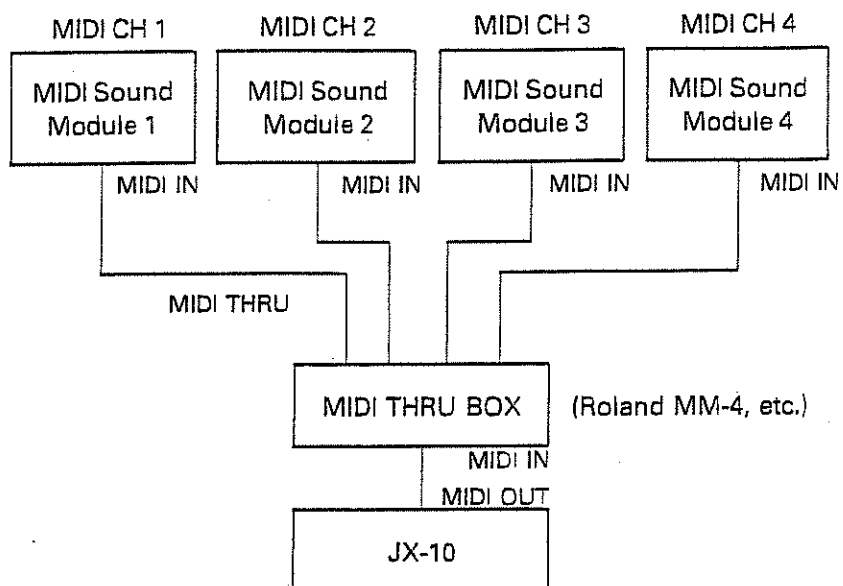

### ● MIDI setting on the JX-10

[20 UPPER MIDI CH → 1]  
[30 LOWER MIDI CH → 2]

In this setting, if the factors 61 and 62, "MIDI CH SEND" of a Patch Memory are set separately from the value 1 to 16, the transmitting MIDI Channels of the JX-10 are selected regardless of the Upper and Lower Channels which are set in the Factors 20 and 30 of the MIDI functions.

If the Factor 62 is set to OFF, the Lower CH in the Factor 30 is selected.

[61 UPPER MIDI CH SEND]	[62 LOWER MIDI CH SEND]	Transmitting MIDI CH	
		UPPER	LOWER
OFF	OFF	1	2
3	4	3	4
2	1	2	1
4	OFF	4	2

In this way, changing Patch Memories selects two of the MIDI Sound Modules to be used.

## 5 Relation between MIDI CH (transmitting) and Key Mode

When the Patch Memory Factor 67 "MIDI KEY MODE" is set to OFF, MIDI CH which sends Key messages is selected with the Factor 17 "KEY MODE".

[17 KEY MODE]	MIDI CH which sends Key messages
DUAL	only the Upper MIDI CH
T-VOICE	only the Upper MIDI CH
X-FADE	only the Upper MIDI CH
SPLIT	the Upper MIDI CH and the Lower MIDI CH at the set split point
UP WHOLE	only the Upper MIDI CH
LO WHOLE	only the Lower MIDI CH

The Factor 67, "MIDI KEY MODE"; SPLIT, UPPER, LOWER or LAYER determines the MIDI CH which sends Key messages regardless of the Key Mode of the JX-10.

[67 MIDI KEY MODE]	MIDI CH which sends Note On/Off messages
SPLIT	the Upper MIDI CH and the Lower MIDI CH that vary depending on the Factor 68, "MIDI SPLIT POINT"
UPPER	only the Upper MIDI CH
LOWER	only the Lower MIDI CH
LAYER	both the Upper MIDI CH and the Lower MIDI CH's send the same Key messages simultaneously

## **6 Using the JX-10 as MIDI Sound Module**

- a) To use the JX-10 as one MIDI Sound Module

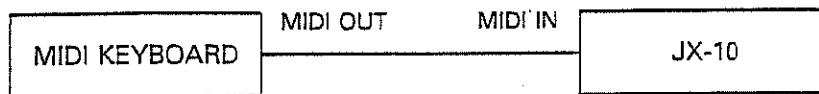

### ● MIDI setting on the MIDI Keyboard

MIDI CH ..... 1  
PROGRAM CHANGE ..... ON

### ● Set the MIDI functions on the JX-10 as follows

MIDI FUNCTION  
[10 PATCH MEMORY CH → 1]  
[20 UPPER MIDI CH → 1]  
[21 UP PROGRAM CHANGE → OFF]  
[30 LOWER MIDI CH → 1]  
[31 LO PROGRAM CHANGE → OFF]

In this setting, Patch Memories of the JX-10 are changed by the Program Change messages transmitted from the external MIDI Keyboard.

Program Change number which is transmitted to the MIDI IN of the JX-10	Patch Memory of the JX-10 which will change
1	INTERNAL A—1
64	INTERNAL H—8
65	CARTRIDGE A—1
128	CARTRIDGE H—8

Unless a Memory Cartridge (M-64C) which contains Patch Memories for the JX-10 is connected to the JX-10, Patch Memories which correspond to Program Change Numbers from 65 to 128 will not change.

**b) To use the JX-10 as two MIDI Sound Modules**

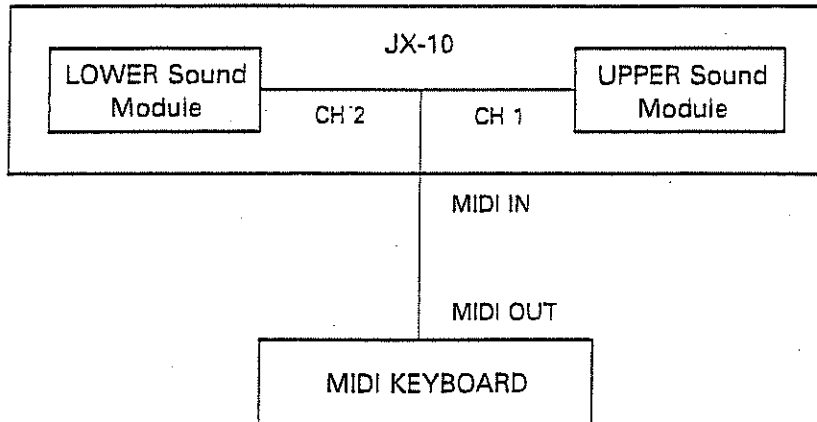



- Set the MIDI Keyboard to the Split mode, then set the MIDI Functions as follows.

UPPER MIDI CHANNEL ..... 1  
UPPER PROGRAM CHANGE ..... ON  
LOWER MIDI CHANNEL ..... 2  
LOWER PROGRAM CHANGE ..... ON

- Set the MIDI Functions and Patch Memory Factors of the JX-10 as follows.

**MIDI FUNCTION**

[10 PATCH MEMORY CH → OFF]  
[20 UPPER MIDI CH → 1]  
[21 UP PROGRAM CHANGE → ON]  
[30 LOWER MIDI CH → 2]  
[31 LO PROGRAM CHANGE → ON]

**PATCH MEMORY FACTOR**

[17 KEY MODE → SPLIT]

In the above setting, the Tone number of the Upper section will be changed by the Program Change Number transmitted on the MIDI CH 1. Likewise, the Tone number of the Lower will be changed by the Program Change number transmitted on the CH 2. The JX-10 works as two 6-voice synthesizers.

Even if any of the Program Change Numbers from 101 to 128 is transmitted, the Tone number will not change. It is because the JX-10 has the Tone numbers from 1 to 100.

## **7** Relation between Key Mode of the JX-10 and MIDI CH (receiving)

When using the JX-10 as MIDI Sound Module, the receiving MIDI Channels are set only in the Factors 20 and 30 "MIDI CH". The Patch Memory Factor 17, "KEY MODE", determines which channel will be selected; the Upper MIDI Channel, the Lower MIDI Channel or both the Upper and Lower Channels.

[17 KEY MODE]	Receiving MIDI CH
DUAL X-FADE T-VOICE UP WHOLE	The Upper MIDI CH is selected
LO WHOLE	The Lower MIDI CH is selected
SPLIT	The Upper MIDI CH and the Lower MIDI CH are selected separately

## **8 Relation between MIDI and the JX-10's built-in Sequencer**

1. When the Memory Cartridge which contains the sequencer data is connected, the clock signals synchronized with the Tempo of the JX-10's Sequencer is being transmitted through MIDI OUT.  
When a Rhythm machine or a Sequencer is connected to the JX-10, be sure to select the Mode in which the MIDI device (a Rhythm machine etc.) can synchronize to the external MIDI clock. (How to change the Modes is shown in the owner's manual of each device).
2. The Sequencer Data is not sent through MIDI OUT.
3. The message sent through MIDI IN cannot be written into the JX-10's Sequencer Memory.

**JX-10**

(Supplementary explanation on MIDI)

BB-7-E2-6S

# Super JX サウンド・チャート / Sound Chart



## PATCH MAP

	1	2	3	4	5	6	7	8
<b>A</b>	ELECTRIC PIANO	BACK-UP FOR MICHASE	VOICES	AFRICAN WALLETS	STIFF PAN	BREATHING BRASS	LOW STRINGS PAD	DCO WAVV 1
	83 PIANO 4 39 HARMO 1	49 BACK-SAW 41 SHORT SAW 1	11 VOICE HISS 10 VOICES A	27 MARIMBA B 44 TICK 2	74 GOWESTBRS 2 74 GOWESTBAS 2	1 HORNZ 1 76 POLY BRASS	88 STRINGS 1 56 LO STRINGS	14 WAVEOLA 2 32 TABLE 1
<b>B</b>	GHORUSED PIANO	METAL CHASE	ESPIQUINIUM CHOIR	METAL ON WOOD	OBESS HISS	SLOW BRASS	ORCHESTRATED FLUTE	LIBELAN BELLS
	52 E GRANO 1 83 PIANO 4	20 E/PIANO A 77 GAMELANET	90 CHOIR 1 HORNZ 1	92 MARIMBA 45 TICK 3	4 FAT FIFTH 46 TICK 4	7 S/BRASS B 6 S/BRASS A	69 FLUTE 1 88 STRINGS 1	63 MISC BOX 64 WINDCHIMES
<b>C</b>	METALLIC E-PIANO	SLAP BACK PAD	HOLLOW VOICES	STEEL DRUM BAND	POLY SYNTH	SLAP BRASS BVA	BOWED STRINGS	SYNTH BELLS
	82 PERKEPIANO 43 RESO-TINK 6	51 PIANO 1 70 FRENOT 1	100 GOWESTVOX 68 HOLLOW PAD	62 DRYSTLDRUM 36 REELSTEEL 1	73 POLY/SYNTH 2 76 POLY BRASS	74 GOWESTBAS 2 75 GOWESTBAS 1	55 ARCO STRNG 55 ARCO STRNG	94 SYNTHBELL 2 40 RESO-TINK 2
<b>D</b>	LAZZY ORGAN	DANCING FLUTES	SOUNDTRACK	CELESTE	BIG DIGITAL	SAMPLE BRASS	REVERB STRINGS	HAND BELL CHOIR
	58 BEE-THREE 38 ORGAN PEC	69 FLUTE-1 69 FLUTE-1	56 LO STRINGS 67 SOUNDTRACK	78 CELESTE 2 43 RESO-TINK 6	16 RASPWAVE 1 48 WAVE-TINK 3	11 VOICE HISS 3 MELLOW BRS	9 R/STRING B 8 R/STRING A	96 VIBES 39 HARMO 1
<b>E</b>	ELECTRIC PIANO 2	BACKWARDS PAN L-R	CALOPE	CLOCK VIBES	CATHEDRAL ORGA	HORN SECTION	CELLO ORCHESTR	DCO WAVE 2
	29 TINES B 28 RHODES A	49 BACK SAW 70 FRENOT 1	33 BREATH 60 CALOPE	95 XMAS BELLS 43 RESO-TINK 6	61 PIPE ORGAN 61 PIPE ORGAN	5 SAXOPHONES 2 HORNS 2	54 CELLO SECT 88 STRINGS 1	15 WAVEOLA 3 47 WAVE-TINK 2
<b>F</b>	METALLIC E-PIANO 2	SYNTH BASS/PAD	MELLOW/PAD	STICK VIBES	TOUGH POLY SYNTH	WINDY FLUTE	SLOW HIGH STRINGS	DCO WAVE 3
	83 PIANO 4 79 AGOGO BELL	12 PAD 1 66 SYNTH BASS	3 MELLOW BRS 3 MELLOW BAS	24 VIBE TINK 23 VIBISH A	17 TOUCH POLY 17 TOUCH POLY	33 BREATH 69 FLUTE 1	89 STRINGS 2 57 HI STRINGS	14 WAVEOLA 2 50 TOYZ-TINK 1
<b>G</b>	ROCK ORGAN	E-BASS/E-PIANO	SYNCPAD	BOTTLE MARIMBA	SYNTH SOLO	WOOD METALLET	SLOW HUGE STRINGS	DCO WAVE 4
	58 BEE-THREE 59 ORGAN 1	83 PIANO 4 65 E-BASS	19 SYNCSOLO 1 19 SYNCSOLO 1	26 ATTACK 1 27 MARIMBA B	18 SYNTHLEAD 1 18 SYNTHLEAD 1	37 LOG-DRAM A 26 ATTACK 1	89 STRINGS 2 57 HI STRINGS	13 WAVEOLA 1 32 TABLE 1
<b>H</b>	ACOUSTIC PIANO	SYNTH BASS/CLAV	STRINGS/HORN FADE	XYLOPHONE	SYNCSOLO	WAVEPAD	STICK BELLS	HIGH TINEY PIANO
	22 PIANO 1-B 21 PIANO 1-A	30 FUNK CLAV 1 66 SYNTH BASS	1 HORNZ 1 88 STRINGS 1	26 ATTACK 1 25 MARIMBA A	19 SYNCSOLO 1 19 SYNCSOLO 1	91 MAY'S WIND 67 SOUNDTRACK	35 STICKY 1 34 BELLS A	53 PIANO 3 42 RESO-TINK 4

**PATCH MEMORY**

	1	2	3	4	5	6	7	8
<b>A</b>	ELECTRIC PIANO 1	BACK/FORTH CHASE	VOICES	AFRICAN MALLETS	IS THIS FAT ?	BREATHING BRASS	LOW STRINGS PAD	DCO WAVE 1
<b>B</b>	CHORUSED PIANO	METAL CHASE	EUPHONIUM CHOIR	METAL ON WOOD	OBESE FIFTHS	SLOW BRASS	ORCHESTRATED FLUTE	TIBETAN BELLS
<b>C</b>	METALLIC E.PIANO1	SLAP BACK PAD	HOLLOW VOICE	STEEL DRUM BAND	POLY SYNTH	STAB BRASS 8VA	BOWED STRINGS	SYNTH BELLS
<b>D</b>	JAZZ ORGAN	DANCING FLUTES	SOUNDTRACK	CELESTE	BIG DIGITAL	SAMPLE BRASS	REVERB STRINGS	HAND BELL CHOIR
<b>E</b>	ELECTRIC PIANO 2	BACKWARDS PANL>R	CALOPE	GLOCK VIBES	CATHDRAL ORGAN	HORN SECTION	CELLO ORCHESTRA	DCO WAVE 2
<b>F</b>	METALLIC E.PIANO 2	SYNTH BASS/PAD	MELLOW PAD	STICK VIBES	TOUCH POLY SYNTH	WINDY FLUTE	SLOW HIGH STRINGS	DCO WAVE 3
<b>G</b>	ROCK ORGAN	E. BASS/E.PIANO	SYNC PAD	BOTTLE MARIMBA	SYNTH SOLO	WOOD METALLET	SLOW HUGE STRINGS	DCO WAVE 4
<b>H</b>	ACOUSTIC PIANO	SYNTH BASS/CLAV	STRING/HORN X-FADE	XYLOPHONE	SYNC SOLO	MAY'S PAD	STICK BELLS	HIGH TINEY PIANO

**tone MEMORY**

	0	1	2	3	4	5	6	7	8	9
<b>00</b>		HORNS 1	HORNS 2	MELLOW BRS	FAT FIFTH	SAXPHONES	S/BRASS A	S/BRASS B	R/STRINGS A	R/STRINGS B
<b>10</b>	VOICES A	VOICE HISS	PAD 1	WAVEOLA 1	WAVEOLA 2	WAVEOLA 3	RASPWAVE 1	TOUCH POLY	SYNTH LEAD1	SYNC SOLO 1
<b>20</b>	E/PIANO A	PIANO 1-A	PIANO 1-B	VIBISH A	VIBE TINK	MARIMBA A	ATTACK 1	MARIMBA B	RHODES A	TINES B
<b>30</b>	FUNK CLAV 1	WAVE TINK 1	TABLE 1	BREATH	BELLS A	STICKY 1	REEL STEEL 1	LOG-DRUM A	ORGAN PERC	HARMO 1
<b>40</b>	RESO.-TINK 2	SHORT SAW	RESO.-TINK 4	RESO.-TINK 6	TICK 2	TICK 3	TICK 4	WAVE.-TINK 2	WAVE-TINK 3	BACK SAW
<b>50</b>	TOYZ-TINK 1	PIANO 1	E.GRAND 1	PIANO 3	CELLO SECT	ARCO STRING	LO STRINGS	HI STRINGS	BEE-THREE	ORGAN 1
<b>60</b>	CALOPE	PIPE ORGAN	DRYSTIDRUM	MUSIC BOX	WINDCHIMES	E.BASS	SYNTH BASS	GROUND RACK	HOLLOW PAD	FLUTE 1
<b>70</b>	FRETNOT 1	BIG OL PAD	STABBASS 2	POLY SYNTH 2	GOWESTBRS	GOWESTBRS	POLY BRASS	GAMEPLANET	CELESTE 2	AGOGO BELL
<b>80</b>	SYNDULCIMR	GUITARCLAV	PERKPIANO	PIANO 4	SYNC LEAD	SEQ 1	REGGIDERS	BRIGHT BOW	STRINGS 1	STRINGS 2
<b>90</b>	CHOIR	MAY'S WIND	MARIMBA	METALLET	SYNTH BELL 2	XMAS BELLS	VIBES	CHURCH BELL	RES BELL	KALIMBA 2
<b>100</b>	GOWESTVOX									

INT MEMORY

PRESET MEMORY



**Roland®**

**10499**

UPC 10499



10499