

PROGRAMMABLE POLYPHONIC SYNTHESIZER

JUNO-106

OWNER'S MANUAL



- **The Roland Juno-106 is 61 Key, six voice fully programmable polyphonic synthesizer.**
- The digitally controlled oscillator (DCO) guarantees an extremely stable pitch.
- The Juno-106 is the complete 6 voice synthesizer provided with 6 VCF's, 6 VCA's, and 6 ENV's.
- The Juno-106 includes memory capacity to retain up to 128 different patch programs.
- The Juno-106 features battery back up system to retain the programs even when switched off.
- If connecting the Pedal Switch to the PATCH SHIFT jack, you can call the 8 patch programs stored in the same bank one after another, simply by pressing the pedal.
- Transposition to any key is possible by the Transpose function.
- The Portament function is provided.
- The Chorus effect produces rich and expansive sounds.
- Featured with MIDI BUS, the Juno-106 can be set up with other MIDI devices.

Warning – This equipment has been verified to comply with the limits for a Class B computing device, pursuant to Subpart J, of Part 15, of FCC rules. Operation with non-certified or non-verified equipment is likely to result in interference to radio and TV reception.”

The equipment described in this manual generates and uses radio-frequency energy. If it is not installed and used properly, that is, in strict accordance with our instructions, it may cause interference with radio and television reception.

This equipment has been tested and found to comply with the limits for a Class B computing device in accordance with the specifications in Subpart J, of Part 15, of FCC Rules. These rules are designed to provide reasonable protection against such a interference in a residential installation.

However, there is no guarantee that the interference will not occur in a particular installation. If this equipment does cause interference to radio or television reception, which can be determined by turning the equipment on and off, the user is encouraged to try to correct the interference by the following measure:

- Disconnect other devices and their input/output cables one at a time. If the interference stops, it is caused by either the other device or its I/O cable.

These devices usually require Roland designated shielded I/O cables. For Roland devices, you can obtain the proper shielded cable from your dealer. For non Roland devices, contact the manufacturer or dealer for assistance.

If your equipment does cause interference to radio or television reception, you can try to correct the interference by using one or more of the following measures:

- Turn the TV or radio antenna until the interference stops.
- Move the equipment to one side or the other of the TV or radio.
- Move the equipment farther away from the TV or radio.
- Plug the equipment into an outlet that is on a different circuit than the TV or radio. (That is, make certain the equipment and the radio or television set are on circuits controlled by different circuit breakers or fuses.)
- Consider installing a rooftop television antenna with coaxial cable lead-in between the antenna and TV.

If necessary, you should consult your dealer or an experienced radio/television technician for additional suggestions. You may find helpful the following booklet prepared by the Federal Communications Commission:

“How to Identify and Resolve Radio–TV Interference Problems”

This booklet is available from the U.S. Government Printing Office, Washington, D.C., 20402, Stock No. 004-000-00345-4.

Waveforms
You can select the output waveform of the DCO. Each of them can be switched on and off individually.

PWM Mode Switch
To select the pulse width controlling signal.

Pulse Width Modulation Knob
<MANUAL> When the PWM Mode Switch is set to MAN, this knob sets the pulse width ratio. <LFO> When the same switch is set to LFO, this knob sets the depth of the modulation.

LFO Modulation Knob
It adjusts the depth of the vibrato effect.

Range Selector Switches
These switches are used to shift the range of the keyboard. (1 octave up or down)

Delay Time Knob
This determines the time required for the LFO modulation (Vibrato or Gravel effect) to start.

FATE Knob
This controls the rate of the LFO.

Assign Mode Switches
POLY 1, for usual performance
POLY 2, for performance with portamento effect.

Key Transpose Button
Hold this button down and press the key to which you want to transpose.

Portamento Time

Volume Knob
This controls the Volume.

Portamento Switch

Band Saws Knob
This control sets the maximum effect of the BEN, DEF.

LFO Saws Knob
This sets the depth of the bander modulation.

Gender Law
Moving this lever to the left or right changes the effect and pushing it backward will result in vibrato effect.

Noise Level Knob
This is the volume knob for another sound source. Noise.

Sub Oscillator Level Knob
This adjusts the Sub Oscillator's volume.

HPF Cutoff Frequency Knob
As you raise the knob, fundamental and low frequency harmonics are cut off. (The sound is getting brighter.)

Cutoff Frequency Knob
As you lower the knob, high frequency harmonics are cut off. (The sound is getting softer.)

Resonance Knob
This emphasizes the Cut-off Four (creating unusual sounds).

Polarity Switch
This determines the polarity of the Envelopes. (Negative polarity is for special effect.)

ENV Modulation Knobs
This adjusts the level of the ENV signal which controls the Cutoff Point of the VCF.

LFO Modulation Knob
This adjusts the depth of the growl/wah effects.

Key Follow Knob
As you lower the knob, the difference of the tone colors between different notes becomes larger.

Control Signal Selector Switch
This selects the signal which controls the VCA. (It decides whether to change the volume by using ENV signal or Gate signal.)

VCA Level Knob
This controls the volume level in writing mode.

Attack Time Knob
This determines the time needed for the voltage to reach its maximum level after the key is pressed.

Decay Time Knob
This determines the time needed for the voltage to reach the sustain level.

Sustain Level Knob
This determines the Sustain level to which the voltage falls at the end of the Decay time.

Release Time Knob
This sets the time required for the sound to finally fade out after the key is released.

Chorus Mode Switch
The effect becomes stronger from left to right, that is, it is stronger than 1. It is not possible to use 11 and 11 at the same time.

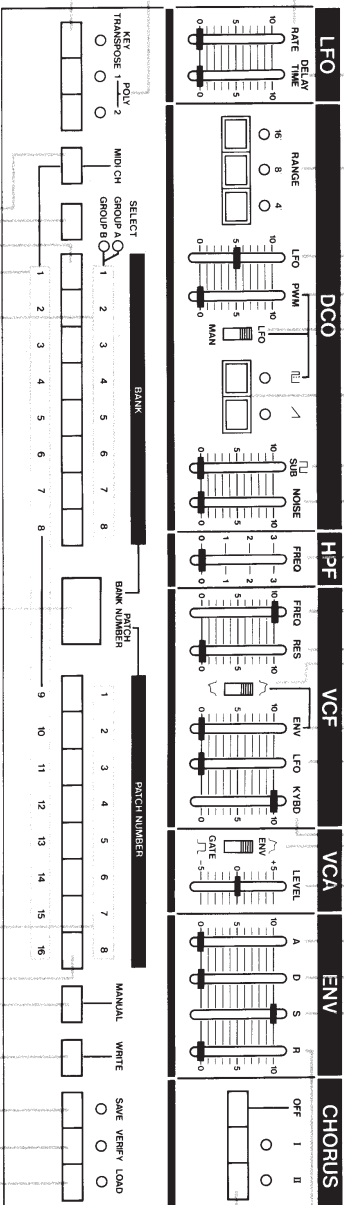

BANK NUMBERS

MIDI Channel Numbers
With the MIDI Channel Button depressed, the Bank Buttons and Patch Number Buttons will serve as MIDI Channel Number Setting Buttons (1 to 16).

Bank Number/MIDI Channel Number Button
This is used to select a Bank or change the Channel Numbers (1 to 8).

Bank Group Selector Button
This selects either Bank Group A or B.

MIDI Channel Button

Pressing this Button will cause the Display Window to show the current Channel Number. To change MIDI Channels, press an appropriate Bank or Patch Number Button while holding the Button down.

Display Window

This shows Bank/Patch Number, MIDI Channel Number, Manual Error, Memory Protect, Key/A to G, etc.

Patch Number

Patch Number/MIDI Channel Number Button
This is used to assign a Patch Number or MIDI Channel Number (8 to 16).

Manual Button

Press this button when synthesizing without using a patch program at all.

Write Button
Press this button when storing a patch program into memory.

Save Button
Press this button when saving the patch programs onto a tape.

Verify Button
Press this button when checking the recorded Data.

Load Button
This button is used to load the data onto a tape into the Juno-105's memory.

Contents

• Basic Connections	5	III. Functions for Playing	22
• Functions		Keyboard	22
I. Memory Functions	6	Assign mode	22
Memory	6	Controllers	23
Tape Interface	11	Key Transpose	24
II. Functions for Sound Creating	16	Remote Controls	24
DCO	16	MIDI	25
HPF	18	IV. Chorus Effect	29
VCF	18		
VCA	20	• Sound Synthesis Memo	30
ENV	20	• Specifications	32
LFO	21	• Options	33

Basic Connections

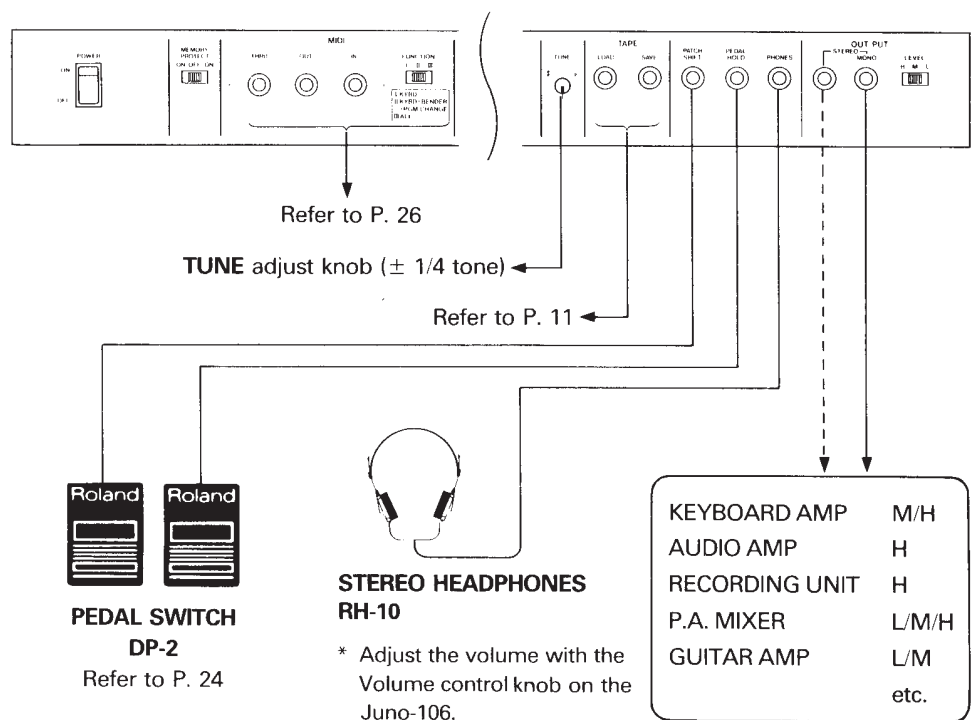

Important Notes

Power Supply

- The appropriate power supply for this unit is shown on its name plate. Please make sure that the voltage system in your country meets that.
- When setting up the Juno-106 with an external amplifier, turn both of them off and plug in the Juno-106 first, then the amplifier.
- This unit might not work properly if turned on immediately after turned off. If this happens, simply turn it off and turn it on again a few seconds later.
- This unit might get hot while operating, but there is no need to worry about it.

Location

- Operating the Juno-106 near a neon or fluorescent lamp may cause noise interference. If so, change the angle of the Juno-106.
- Avoid using the Juno-106 in excessive heat or humidity or where it may be affected by direct sunlight or dust.

Cleaning

- Use a soft cloth and clean only with a neutral detergent.
- Do not use solvents such as paint thinner.

Memory

The Juno-106 includes enough memory capacity to retain up to 128 different patch programs which you can change from one to another during live performance just by flick of a button.

Also, you can edit any patch program in use by moving the controls. It also features battery back-up circuit to retain the programs even when switched off.

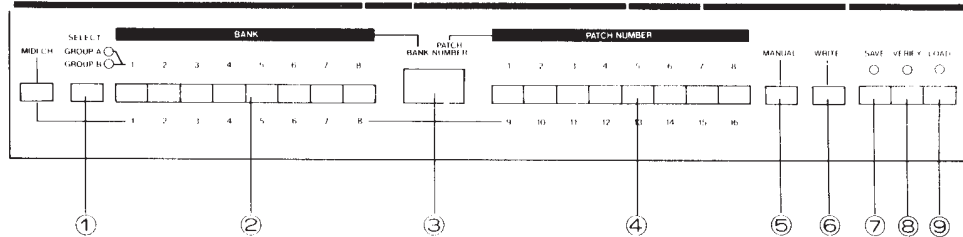

- ① Bank Group Selector Button & Indicator
- ② Bank Number Buttons
- ③ Bank Patch Number Display
- ④ Patch Number Buttons
- ⑤ Manual Button
- ⑥ Write Button

The Juno-106 features battery back-up system to retain the programs even when switched off. The battery should be replaced with a new set in every five years. In this case, please have your local Roland dealer replace the battery. (The first replacement might be required before five years.)

<Tape Interface>

- ⑦ Save Button & Indicator
- ⑧ Verify Button & Indicator
- ⑨ Load Button & Indicator

(a) Tone Color Selection

You can select any patch in the Memory by using the Bank Number Button ② and Patch Number Button ④.

Firstly, select one of the Bank Groups A or B by pressing the Bank Group Selector Button. This Button alternately selects A and B each time you press it. Turning the Juno-106 on will automatically select Bank A (the corresponding indicator lights up). Then press any Bank Number and Patch Number Buttons you like. The Display Window ③ will show the Bank and Patch numbers currently selected.

* In Juno-106, you can select any combination of either of Bank Group A or B, one of the Bank Numbers 1 to 8 and one of the Patch Numbers 1 to 8. You do not need to press the Bank Number Button to select a patch in the same Bank as the one currently in use. Also, if you are to select a patch of the same Patch Number in a different Bank, you only need to press the relevant Bank Selector Button.

* It is possible to change the Patch Number by pressing the Pedal Switch. (Refer to p.24)

► Example

- B-23 (Bank Group B, Bank 2, Patch 3)

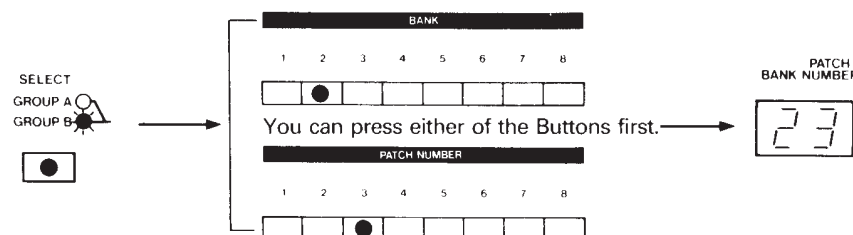

(b) Editing

You can edit any patch program in use as you play. If you move a desired control even slightly, its setting position of that patch program will be deleted and ready to be manually controlled. As soon as you start editing, the two dots in the Program Number Display window will light, showing that the Juno-106 is in Edit mode.

This Editing function may be used as a real time performance control since it does not automatically rewrite the existing program, unless the appropriate operation for rewriting is done. (Refer to P.8) Therefore, if selecting the same patch program later, you will hear the original tone color unchanged.

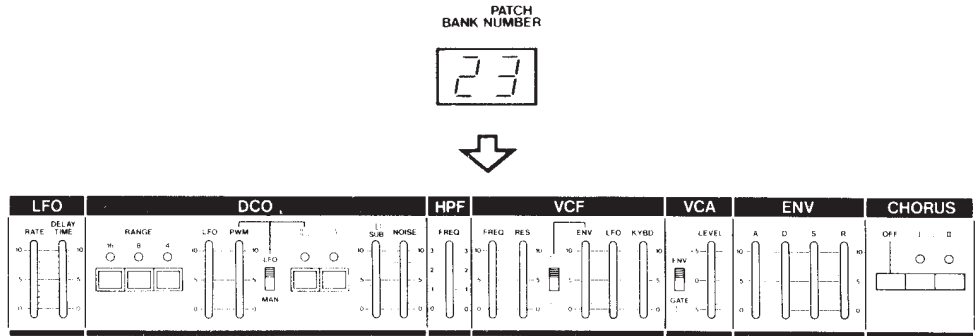

* Adjust the desired controls.



← The dots will light.

* Editing does not affect the original patch program.

(c) Writing

You can write a new patch or an Edit into memory. The setting on the front panel under the red belt is memorized as a patch program. (Refer to the diagram below).

* The old patch program previously stored is automatically deleted when you have written a new patch.

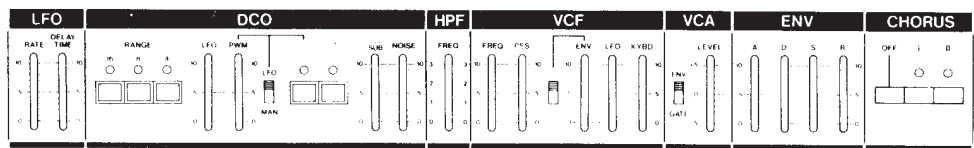

(c) Writing

► **Operation**

1) Writing a new patch program

- ① Depress the Manual Button, then synthesize your own sound.
- ② Set the Memory Protect Switch on the rear panel to the OFF position.

- ③ While holding the Write Button down, press the Bank Number Button and the Patch Number Button. (Either of the buttons can be pressed first.)

- The Bank and the Patch numbers of the selected patch program is shown in the Display Window. Now, writing is completed.

- ④ Set the Memory Protect Switch to On.

► **Example 1**

Writing a new patch program into B-18.

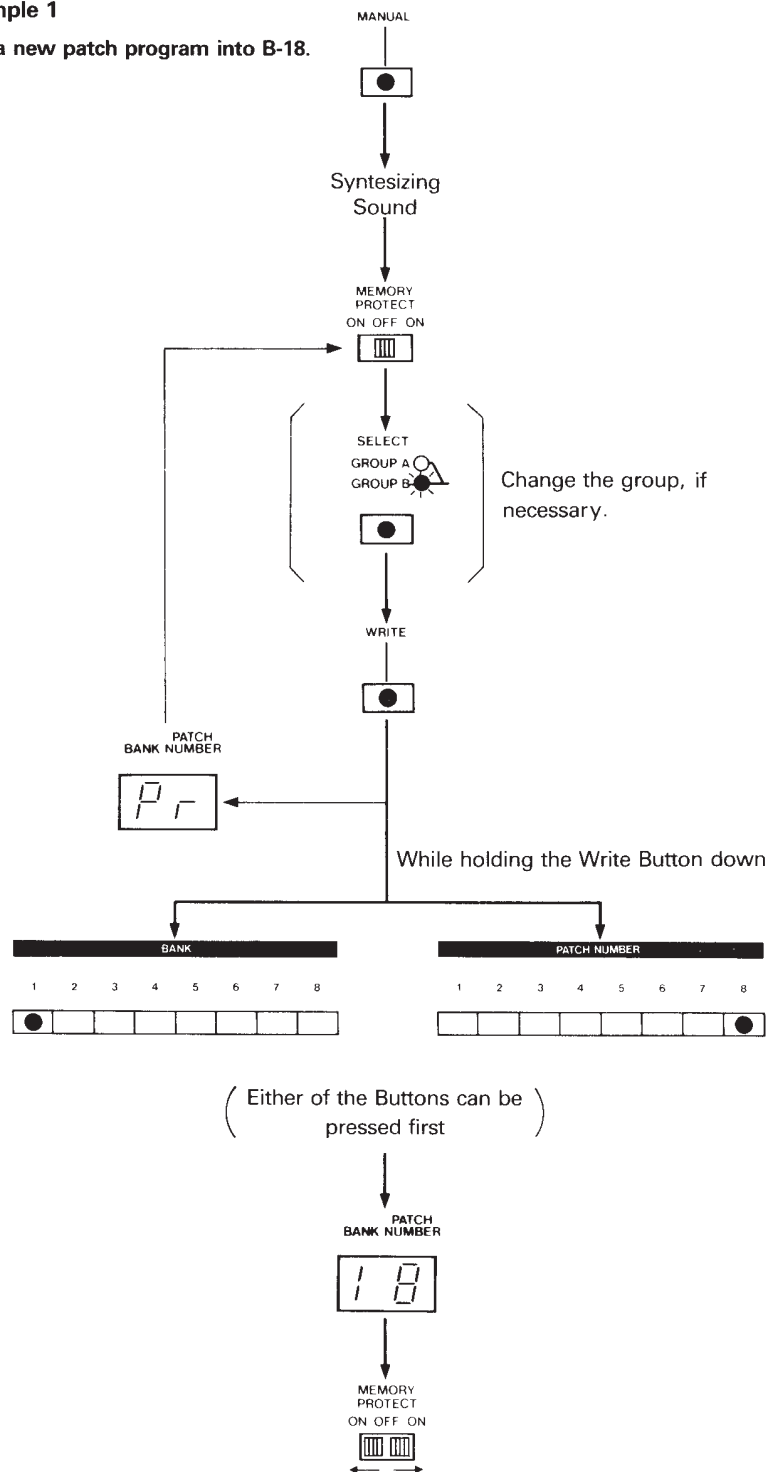

2) Writing an Edit

- ① Recall any Patch Program you like from memory, then edit it to your taste.
- ② Set the Memory Protect Switch on the rear panel to OFF.
- ③ If you wish to write the edited patch into the same Bank Group, do not touch the Bank Group Selector Button, but press the Bank and the Patch Number Button while holding the Write Button down. To write into a different Bank Group, while holding the Write Button down, initially press the Bank Group Selector Button, then the Bank and the Patch Number Buttons.

Please note that either of the Bank Number and the Patch Number Buttons can be pressed first. It is totally unnecessary to press the Bank Number Button first.

- Now the Bank and Patch numbers are displayed in the Display Window and writing is completed.
- ④ Set the Memory Protect Switch to ON.

► Example 2

Editing a patch A-13, then writing into A-88, or into B-23.

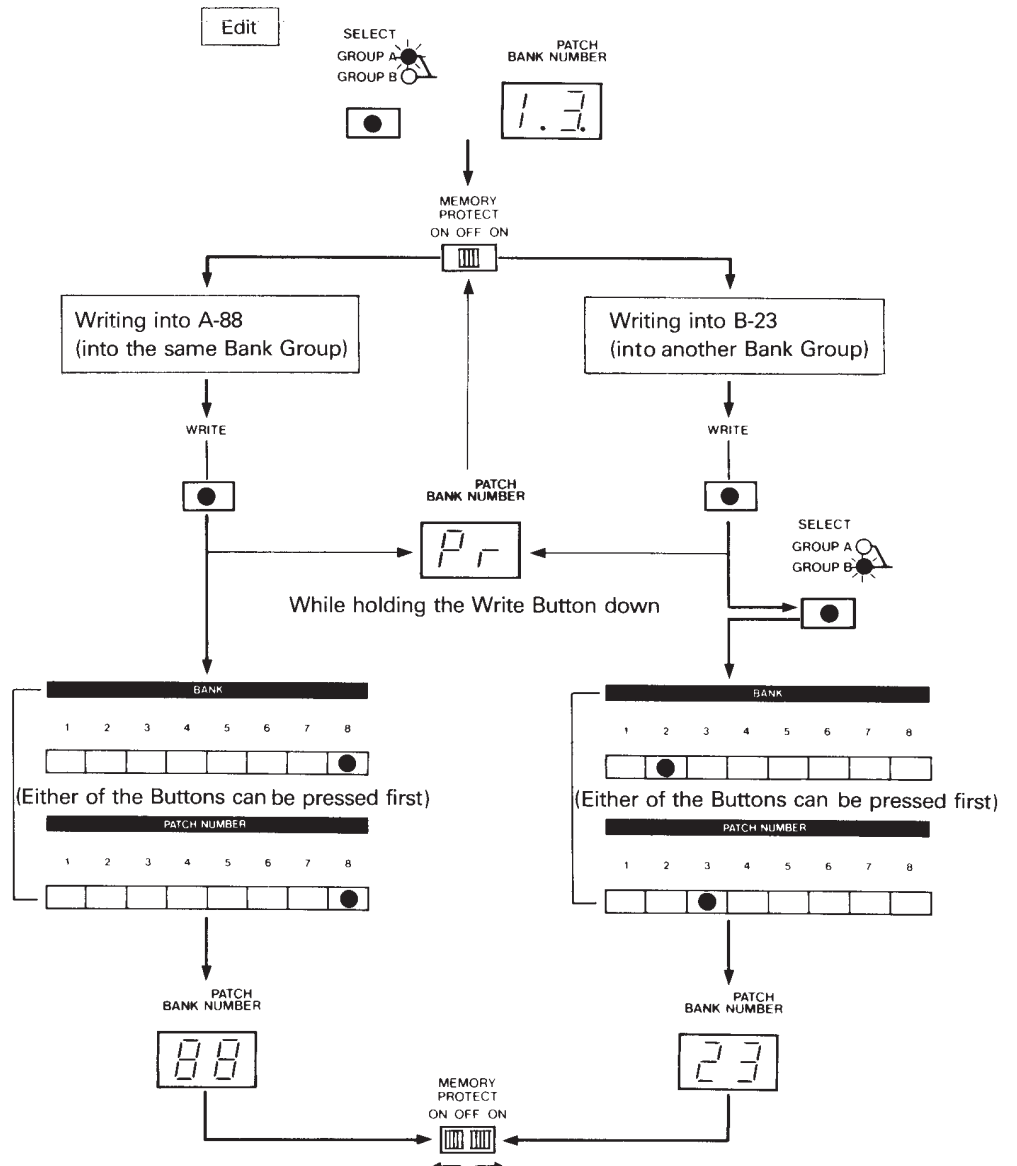

(d) Copy function

This copy function allows the user to copy any patch program and arrange the program numbers. There may be some patch programs which are more often used than others. If these patches are collected in the same bank, it will be easier to decide where to write a new patch, which after all save a great deal of work and time.

* This function is particularly useful when the Patch Shift Function (Refer to 24) is being used.

► Operation

- ① Set the Memory Protect Switch on the rear panel to OFF.
- ② Assign the patch program to be copied by pressing the Bank Group Selector Button first, then the Bank Number and Patch Number Buttons. (The Bank and the Patch Numbers are shown in the Display.)
- ③ If you are to copy the patch into the same Bank, press the relevant Bank Number and Patch Number Buttons, while holding the Write Button. To copy the patch program into another Bank Group, it is required to assign the Bank Group. Hold the Write Button down and press the Bank Group Selector Button before pressing the Bank Number and Patch Number Buttons.
 - The Bank and the Patch numbers are shown in the Display Window, and writing is completed.
- ④ Set the Memory Protect Switch to ON.

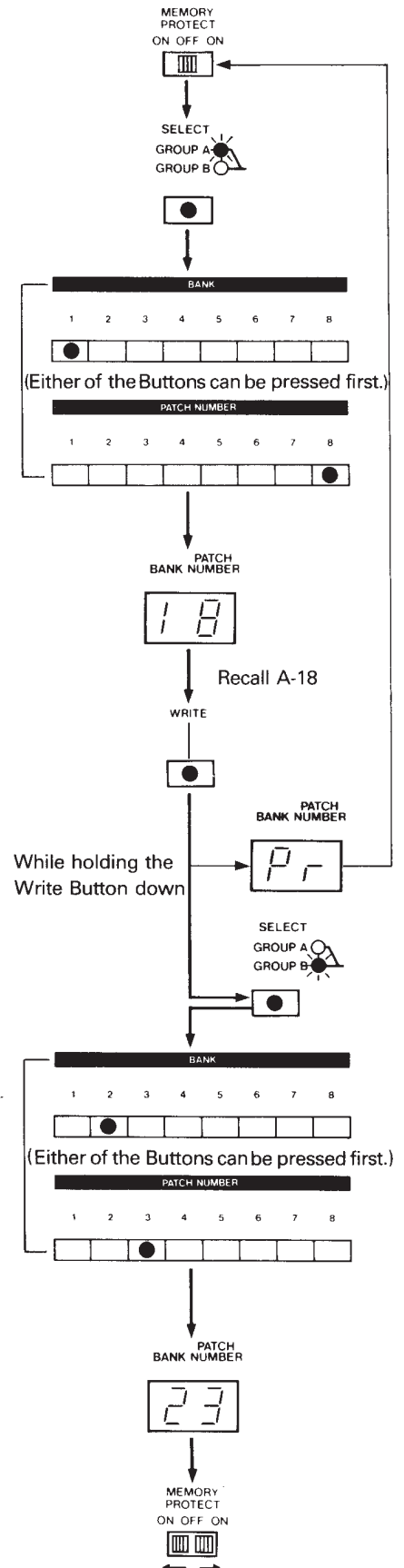
► Example
Copying a patch from A-18 to B-23

Tape Interface

The Juno-106 features the Tape Interface system which allows its patch programs in its memory to be saved onto an ordinary tape recorder. The patch programs in the Juno-106's

memory are fully supported by battery, but it may be a good idea to save them onto a tape sometime or other to prevent accidental loss of the data.

► Connections

▪ SAVE

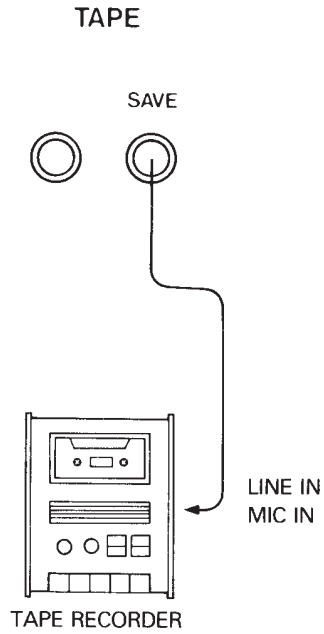

▪ VERIFY, LOAD

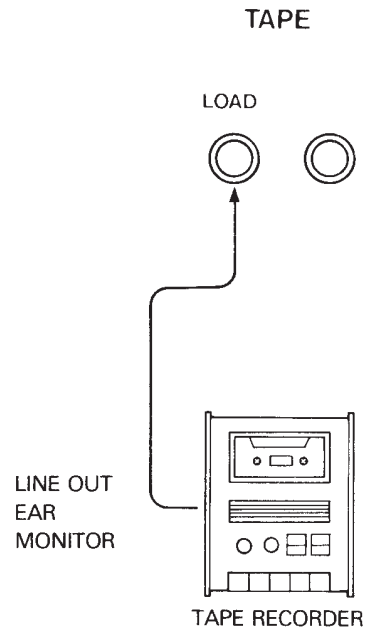

★ A whole Bank Group is saved, verified or loaded.

Save

► Operation

- ① Set the tape recorder to recording mode.
- ② Make sure the appropriate Bank Group Indicator is lighted (if Group A, the red one, and if Group B, the green one). If not, press the Bank Group Selector Button and change it.
- ③ Press the Save Button.

- The Save Indicator lights up and the indication in the Display Window goes out (Here, Pilot tone is output through the Save Jack).

- ④ If your tape recorder features a recording level control, set the level so that the Pilot tone will read around 0 VU.

- In about 4 to 5 seconds, the Pilot tone will turn to Modulated tone, and saving will start. (Please be sure to adjust the level while the Pilot tone is still heard.)

- * Press the Manual Button to stop saving in the middle.

- If the Save Indicator goes out and the Display shows "--", saving is completed.

- * Every data will be automatically saved twice just in case.

- ⑤ Stop the tape recorder.

- * It may be a good idea to verify every one of the data you have saved.

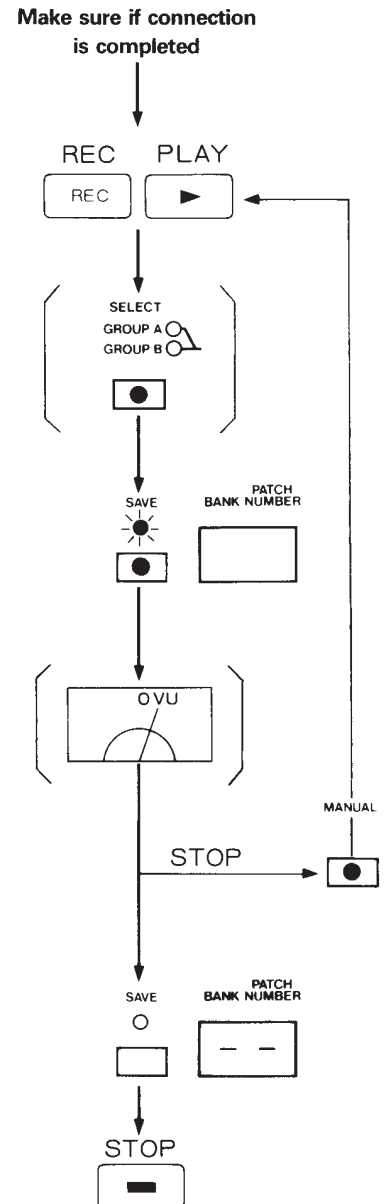

Verify

► Operation

① Set the tape so that the beginning of the data will start (where you hear Pilot tone).

* If your tape recorder features a playback level control, set it to medium volume.

② Assign the Bank Group A or B you wish to verify, by pressing the Bank Group Selector Button.

③ Set the tape recorder to playback mode, then press the Verify Button.

• The Verify Indicator will light up and Bank Patch Number Display will go dark. Then verify will begin.

• If the Verify Indicator goes out and the display shows Manual indication "--", verify is completed.

* Press the Manual Button to stop verifying in the middle.

④ Stop the tape recorder.

* If there is any error, "Er" will be indicated in the Display Window. If so, carefully repeat verify procedures. Also, try changing the volume and tone color of the tape recorder.

★ If error is indicated again and again, refer to P.15.

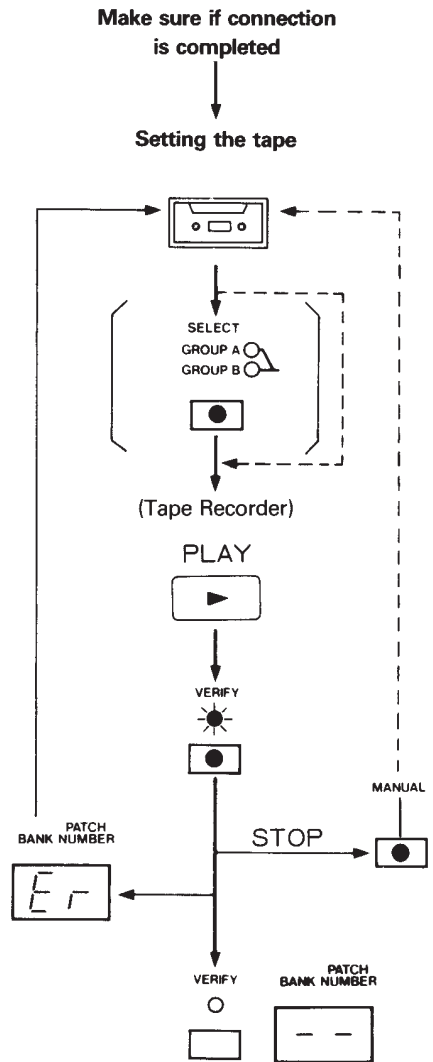

Load

► Operation

- ① Set the tape so that the data starts from the beginning (where you hear pilot tone).
 - ② Set the Protect Switch on the rear panel to OFF.
 - ③ Select either Bank Group A or B where you are to load the data, by pressing the Bank Group Selector Button.
 - ④ Set the tape recorder to playback mode and press the Load Button.
- The Load Indicator lights up and the indication in the Display Window will go out. And loading will start.
 - * Be sure to press the Load Button before the Pilot tone turns to Modulated tone.
 - * Press the Manual Button to stop loading in the middle.
- ⑤ If loading is completed, set the Memory Protect Switch to ON, and stop the tape recorder.
- * If error is indicated, carefully repeat Load procedure.
 - ★ If error is indicated again and again, refer to P.5.

[Note]

In the Juno-106, a whole Bank Group is saved, verified and loaded. It is possible to load the Bank Group A data saved on a tape into the Bank Group B in memory. The reverse way is also possible (Bank Group B→Bank Group A).

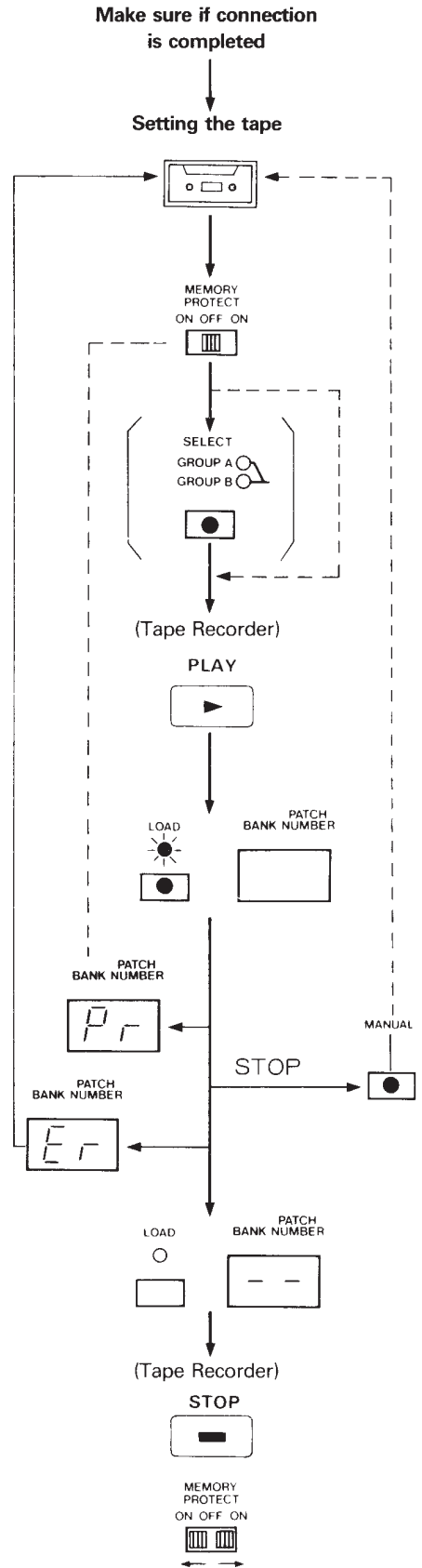

★ Important Notes on Operating the Tape Interface

If error is indicated in Verify or Load procedure of Tape Interface, carefully repeat each procedure taking care of the following points.

▶ When to press the Key

- Press the Verify or Load key before the data you are to verify or load starts.

▶ Where to start recording

- Please do not start recording from the very head of the tape, but after slightly winding it.

▶ Connection

- Make sure that connections are made properly.
- If your tape recorder has two kinds of In/Out Jacks (i.e. MIC/LINE In, EAR/LINE Out, etc), try using different ones this time.
- Some tape recorders do not allow proper operation when both Save and Load connections are made at the same time. In such a case, make only the relevant connection.

▶ Tape you use

- Use a new and high quality tape, if possible. An old tape is liable to have drop-out, therefore likely to cause error more often.
- Use a cassette tape shorter than C-60. The one longer than C-90 is too thin for proper operation.

▶ Tape Recorder

- Try using the same tape recorder in Saving and Loading, so that possibility of error will be reduced.
- Clean and demagnetize the head of the tape recorder.

★ **If error is still indicated, use a different tape recorder.**

▶ Preserving Data Tape

Please do not keep the data recorded tape in extreme heat or humidity or near strongly magnetic units such as speaker or an amplifier. Also, be sure that the tape is completely rewinded.

DCO

(Digitally Controlled oscillator)

DCO is the digitally controlled oscillator that controls the pitch and creates two types of waveforms which are the sound source of the synthesizer. Compared to VCO (Voltage Con-

trolled Oscillator), DCO has superior stability. The operations and functions of the DCO are virtually the same as those of the VCO.

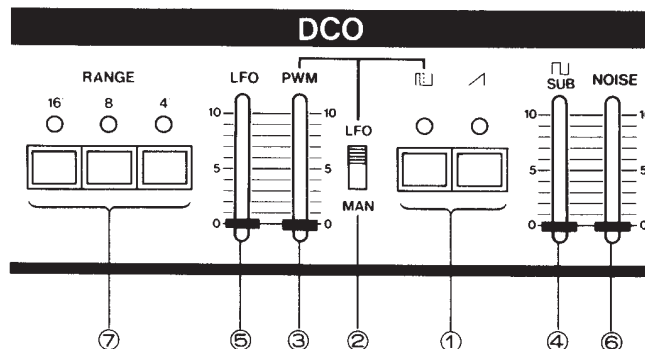

① **WAVEFORMS**

You can select the output waveform of the DCO. Each switch can be individually turned on or off and can be simultaneously used with another switch.

② **PWM Mode Switch**

When it is set to MAN, pulse width can be set to a certain ratio. When it is set to LFO, pulse width is controlled by the signal from the LFO.

③ **PWM • Pulse Width Modulation Knob**

When PWM Mode switch ② is set to MAN, this knob controls the pulse width, and controls the intensity of the modulation when it is set to LFO.

④ **SUB • Sub Oscillator Level Knob**

It controls the volume of the Sub Oscillator.

⑤ **LFO • Modulation Knob**

It adjusts the depth of the vibrato effect when the LFO is controlling the pitch of the DCO.

⑥ **NOISE • NOISE Level Knob**

It controls the volume of the NOISE.







⑦ **Range Selector Button**

This selects the pitch of the DCO. When it is set to 8', "do "(C) 3rd from the lowest falls on the Middle C of a piano keyboard. By using 4' or 16' position, one octave is shifted up or down, changing total range of the keyboard. (Refer to P. 24 for the details)

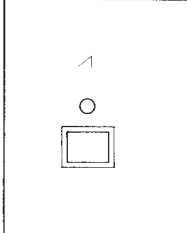
<Pulse Width>

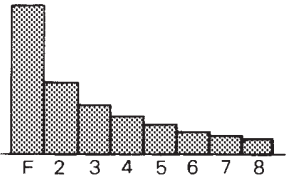
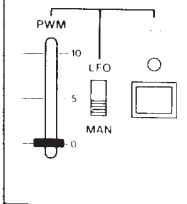
When the top and bottom portions of the square wave are unequal, the result is what is called a pulse wave. The harmonic content of the pulse wave will depend greatly on the width of the pulses. It is possible to modulate, or change the pulse width by means of the LFO.

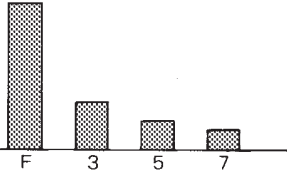
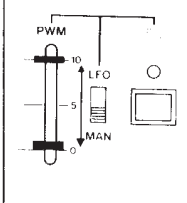
Waveform

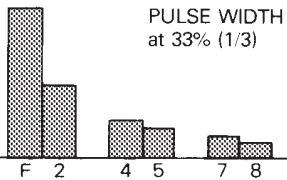
Setting	Waveform	Description	Harmonic Content
	 <p>Saw Tooth</p>	<p>The sawtooth wave contains a fundamental sine wave and its integral harmonic sine waves at a fixed ratio. The level of each harmonic is as shown on the right. When fundamental content is 1, the content of nth harmonic is $1/n$.</p>	
	 <p>Square</p>	<p>The square wave contains a fundamental sine wave and its odd numbered harmonics at a fixed ratio. The level of each harmonic is the same as sawtooth wave: the content of nth harmonic is $1/n$; except that there are no even numbered harmonics.</p>	
	 <p>Pulse</p>	<p>With pulse wave, the harmonic content greatly varies depending on the pulse width. It is characterized by a lack of the nth harmonic series when the pulse width is $1/n$. The example on the left lacks 3rd, 6th, and 9th harmonics because the pulse width is $1/3$ (33%).</p>	

Pulse Width

► Manual PWM

PWM Mode Switch ② → Set to MAN

Pulse Width Modulation Knob ③ →

→ Determines the Pulse width.

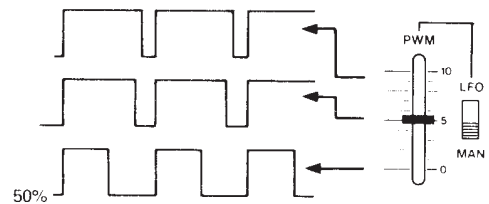

► PWM by LFO

PWM Mode Switch ② → Set to LFO

Pulse Width Modulation Knob ③ →

→ Adjusts the intensity of the modulation.

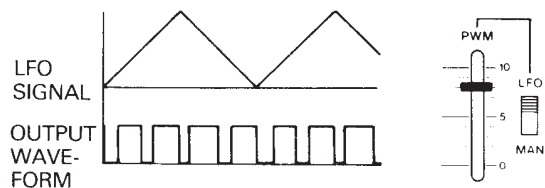

HPF

(High Pass Filter)

This filter lets the high frequency harmonics pass and cuts off the low frequency harmonics. As this filter is not voltage controlled, Cutoff Point is changed by only moving the knob.

① Cutoff Frequency Knob

This knob sets the Cutoff point of the HPF. With this set to 1, the DCO output passes the filter unprocessed, and as it is raised, Cutoff point is heightened, higher harmonics being passed. In the meantime, at its lowest position "0", lower frequencies are boosted. (This is specially useful for boosting bass sound of organ, etc.)

VCF

(Voltage Controlled Filter)

This filter changes the tone color by cutting off or emphasizing harmonics. This filter lets the low frequency harmonics pass and cuts off the high frequency, and is controlled by a voltage.

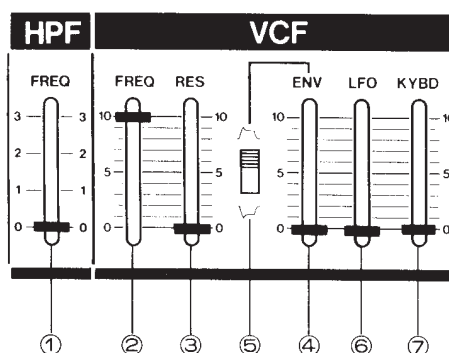
**② FREQ • Cutoff Frequency Knob**

This knob is to change the Cutoff Point of the VCF. As you lower the knob, higher frequency will be cut off, and the sound will fade out when the waveform becomes nearest to Sine Wave.

③ RES • Resonance Knob

This control emphasizes the Cutoff Point set by Cutoff Frequency knob ②. As you raise the knob, certain harmonics are emphasized and the created sound will become more unusual, more electronic in nature. If you alter the Cutoff Frequency Knob while the Resonance Knob is set to a high level, you can create a type of sound that is attainable only from a synthesizer. If you raise the Resonance knob up to the maximum, the VCF will start its self oscillation.

④ ENV • Envelope Modulation Knob

When the Cutoff Point of the VCF is being modulated by the output of the Envelope Generator, this knob is used to adjust the intensity of the modulation. You can change the Cutoff Point of the VCF in each note with the ADSR pattern previously set. So the tone color within one note can be changed quite drastically.

⑤ Polarity Switch

This is the selector switch for the polarity of the Envelope. When it is set at reverse polarity, the ADSR pattern will be reversed and the tone color alteration will be the other way round.

⑥ LFO • LFO Modulation Knob

When the Cutoff Point of the VCF is being modulated by the output CV of the LFO, this knob adjusts the depth of the growl or wah effect.

⑦ KYBD • Key Follow Knob

When the Cutoff Point is being controlled by the KYBD-CV (Keyboard control voltage), this knob adjusts the level of the KYBD-CV. It prevents any inconsistency in the harmonic content caused by pitch alteration. Consequently this knob is usually set to the maximum on such a long keyboard, but can be set to your taste.

► NOTE

- * The self-oscillation of the VCF does not guarantee an accurate pitch. Therefore, you cannot expect a correct scale when playing the keyboard.
- * If using the VCF self-oscillation as a sound source, its pitch may turn out unstable, since the Cutoff frequency does not change continuously. In such a case, change the position of the FREQ Knob ② until you get a stable pitch. (If you write it into memory once and recall it, the pitch will be stable)

Cutoff Frequency

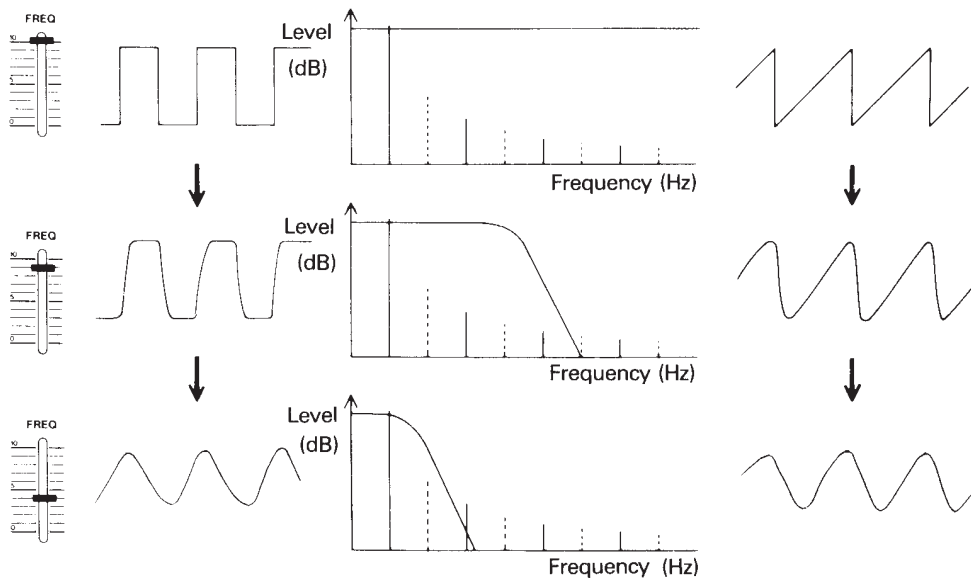

Resonance

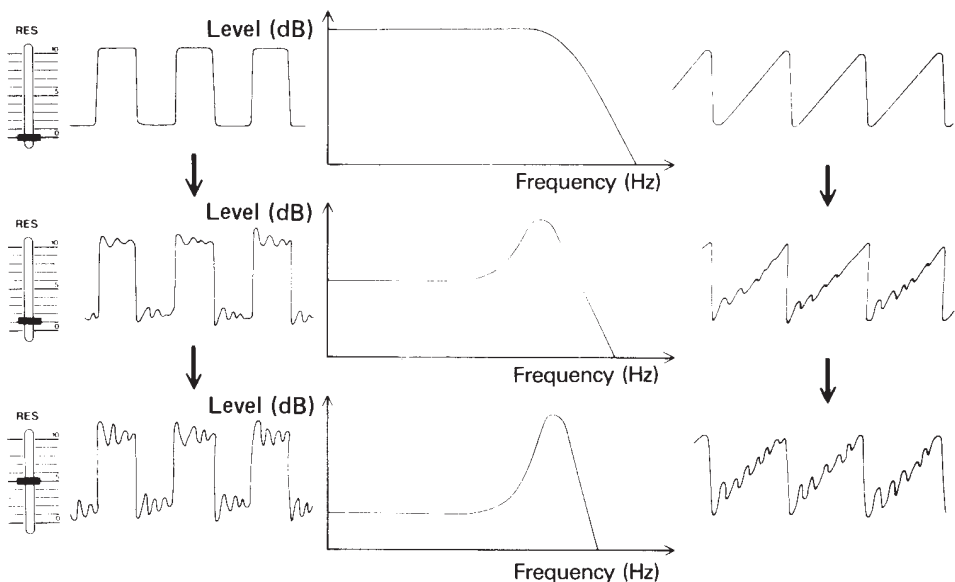

ENV Modulation

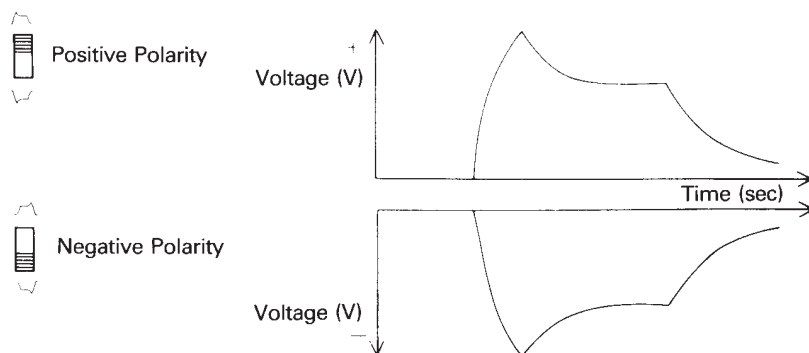

► **NOTE**

When modulating the VCF using the Envelope, set the knob ② to a fairly low level in case of positive polarity, and set it to a fairly high level in case of negative. Otherwise there will be little effect.

VCA

(Voltage Controlled Amplifier)

This is to control the volume (amplitude) of the sound, and is normally controlled by the output voltage from the Envelope Generator.

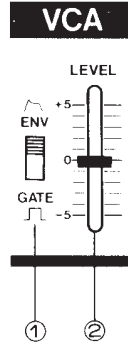

① **Control Signal Selector switch**

This switch enables you to select whether to control the VCA by the signal from the Envelope Generator or by the Gate signal.

② **VCA Level Knob**

This adjusts the volume level in the writing mode.

* This knob can be used to match the amplitudes (the volume sounds to your ears) of all the patch programs. This makes the live performance much more comfortable as there will be no volume difference realized between two different patches. While writing a patch into memory, adjust its level with this knob.

* When this knob is set too high, a sound distortion might occur, but this is not because of the trouble of the Juno-106.

ENV

(Envelope Generator)

This generates the Control Voltage applied to the VCF and the VCA, thereby controlling the volume and the tone color of each note. This output voltage is generated whenever you press a key.

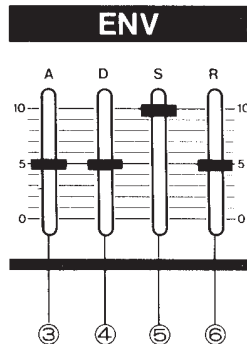

③ **A (Attack Time) Knob**

This sets the time required for the voltage to reach its maximum from the moment the key is pressed down.

④ **D (Decay Time) Knob**

This determines the time required for the voltage to drop from the maximum to the sustain level. When the sustain level is high, the Envelope curve does not change by adjusting the Decay Time.

⑤ **S (Sustain Level) Knob**

This knob determines the Sustain Level to which the voltage falls at the end of the Decay Time.

⑥ **R (Release Time) Knob**

This sets the time needed for the voltage to reach zero.

■ ENV OUTPUT (ADSR)

■ KEYBD GATE

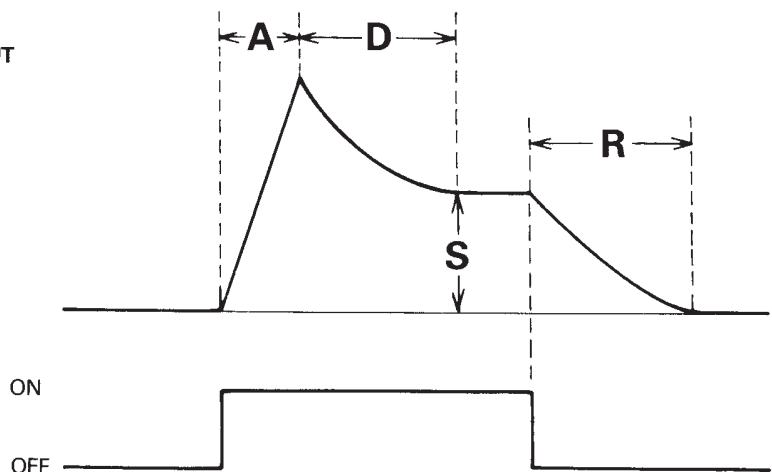

• The variation of each knob.

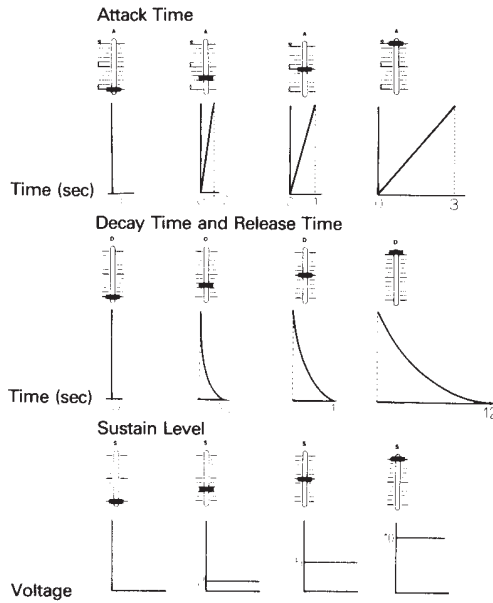

* In the figure shown above, the positions of the knob are not meant to be exactly correct, so the knob position does not necessarily correspond with the time and the voltage.

• Setting of ADSR and Envelope Curve.

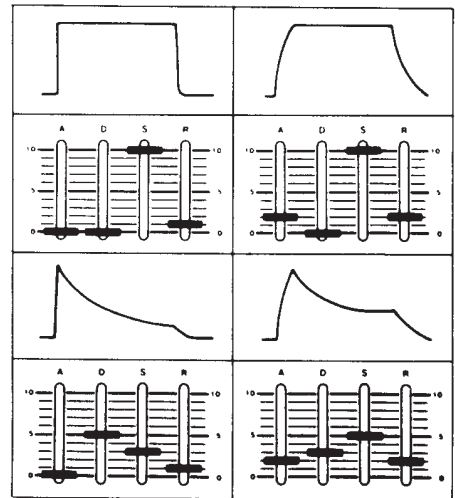

** When all of the **ADSR** sliders are set to zero, the waveform will be an extremely short Pulse wave, and only a short "click" is heard. **Please be careful.**

LFO

(Low Frequency Oscillator)

This oscillator generates only low frequency signal. It controls the VCO and the VCF to produce vibrato and growl effects.

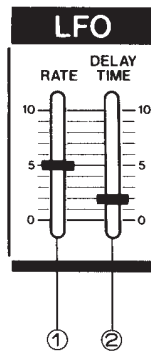

① **Rate Knob**

This sets the rate of the LFO.

② **DELAY TIME Knob**

This sets the time needed for the LFO to start to function.

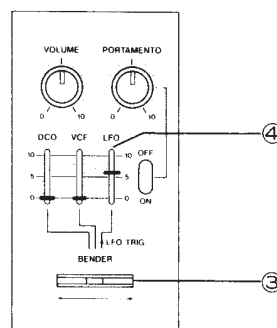

③ **Bender Lever**

While this lever is being pushed back, vibrato effect by LFO is obtained.

④ **LFO Modulation Depth Knob**

This determines the depth of the LFO Modulation.

* Refer to P.23 for the details of the Bender Lever and LFO Modulation Depth Knob.

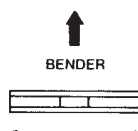

Keyboard

The Juno-106 has 5 octaves, 61 keys, but can be played as a 7 octave keyboard (as shown below) by using the Range Selector Switch.

When the Range Selector Switch is set to 8', the third C from the bottom corresponds to the Middle C on a piano keyboard. So, if you wish to use the Juno-106 with the other keyboards. This knowledge will help you to align the Middle C of the two keyboards.

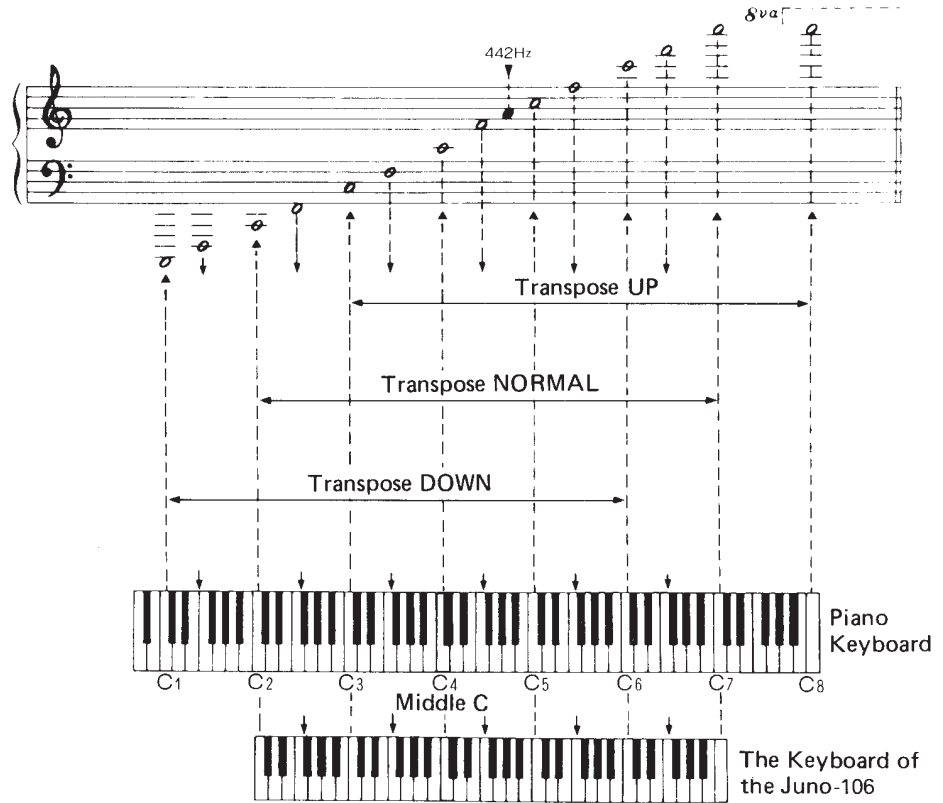

Highest and Lowest Tones

When you are using any of the Key Transpose (± 1 octave), Bender (± 1 octave), or LFO Functions, there is range limit of highest and lowest tones. That is, when 8' is selected in the Range Selector Switch, C₁ is the lowest and C₈ is the highest tone. In this case, the Bender and LFO modulation does not include the lower tone than C₁.

If you play the key higher than C₈, the sound will become lower (if it is saw-tooth wave), or no sound is generated (if square wave). Also, 16' pitch range covers C₀ to C₇ and 4' covers C₂ to C₉.

* The external information sent into the Juno-106 through MIDI Bus is processed likewise.

Assign Mode

Poly 1

This mode turns the Juno-106 to a 6 voice polyphonic synthesizer assigning one synthesizer voice to each key pressed. This is suitable for the sound whose envelope curve is similar to piano or guitar, therefore chosen for usual performance.

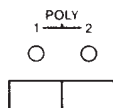

Poly 2

This mode is very similar to Poly 1 assigning only one synthesizer voice to each key pressed. The primary advantage of Poly 2 is that only the last note or notes played together receive natural release length. This mode is suitable for the performance with portamento effect.

- If 6 keys are simultaneously pressed, no more key will sound.

* Pressing the Poly 1 and Poly 2 at the same time will turn the Juno-106 to the Solo unison mode, therefore it can be played as a monophonic synthesizer that assign 6 voices to each key pressed.

Controller

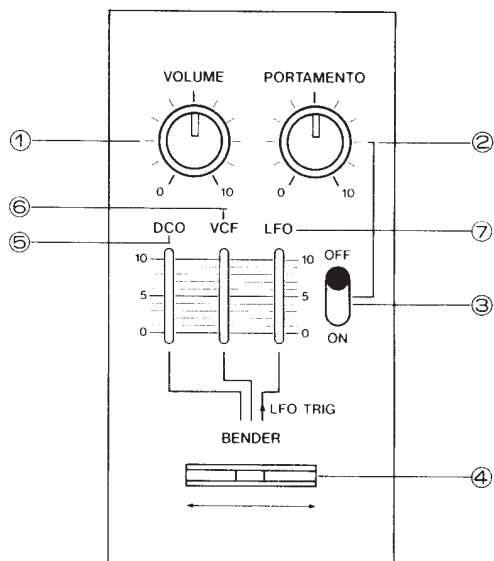

① **Volume Knob**

② **Portamento Time Knob**

Portamento is a slide from one pitch to another. This Portamento Knob determines the time required to change pitches.

③ **Portamento Switch**

There are two positions to be selected depending on your requirement.

OFF : When the Portamento Switch is set to this position, the portamento effect is not available at all.

ON : With the Portamento Switch in this position, the portamento effect is always obtained.

④ **Bender Lever / LFO Trigger Switch**

⑤ **DCO Bend Sens Knob**

This sets the variable range of the DCO's pitch, when it is controlled by the Bender ④. (Max. ± 1 octave).

⑥ **VCF Bend Sens Knob**

This slider knob sets the maximum effect of the Bender, when it is controlling the cutoff point of the VCF.

⑦ **LFO Modulation Depth Knob**

If the Bender Lever is being pushed back, LFO output controls the DCO (vibrato effect). This knob controls the depth of the vibrato effect. Regarding the rate, adjust it by using the Rate Knob in the LFO.



BENDER

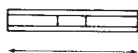

Key Transpose

Transposition to any key is possible.

By using the appropriate key, you can shift the pitch of the entire keyboard. Therefore, you can play a music with many \sharp 's and \flat 's in the key of C major (=A minor).

■ How to transpose

Pressing the Transpose Button will cause the Display Window to show the current key (A to G). While holding the Transpose Button down, press any key in any octave you like. If the Transpose Indicator lights, and the Display Window shows the new key (A to G), transposition is completed and the Juno-106 will now play in the key of the chosen note. Also, "." in the Display represents \sharp . (ex. F. = F \sharp)

* If you press the key on the keyboard lower than middle C (third "do" from the lowest), it will be transposed down, and if higher than that, transposed upper. That is ± 1 octave transposition is possible.

If it is transposed up, the new key will be displayed. In case of downward transposition, minus "-" will be displayed on the left of the new key indication. (e.g. "-A").

* Please be sure no key on the keyboard is held down when pressing the MIDI Channel Button.

■ How to return to the normal key (Ckey)

Pressing the Key Transpose Button will cause the Display Window to show the current key (A to G). While holding the Transpose Button down, press the Middle C key. If the "C" is shown in the Display, and the Key Transpose Indicator goes out, the Juno-106 has returned to the normal condition (the key C).

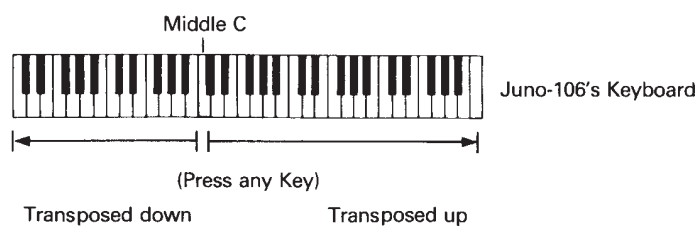

Remote Control

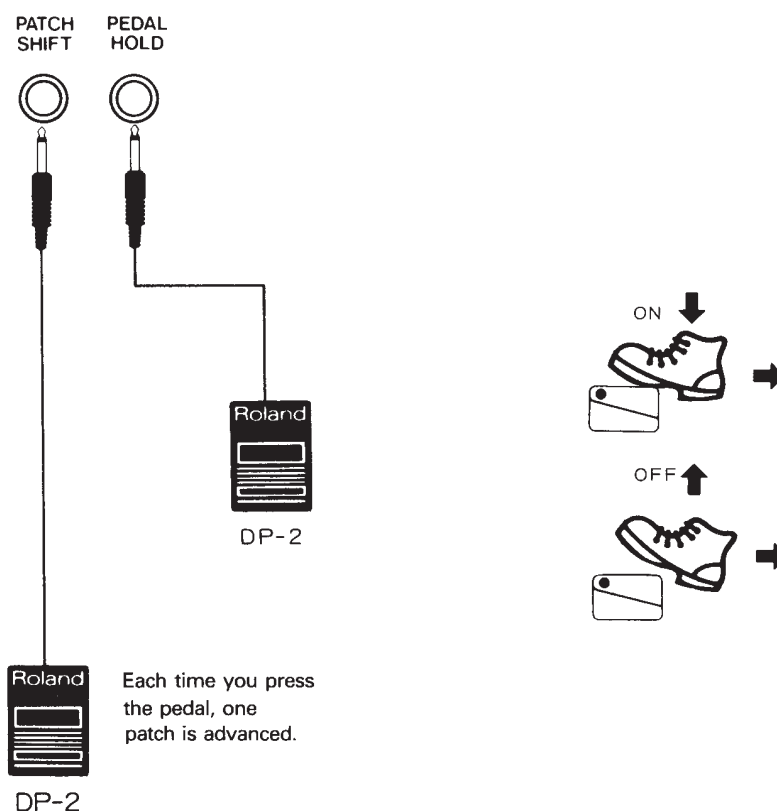

MIDI

(Musical instrument Digital interface)

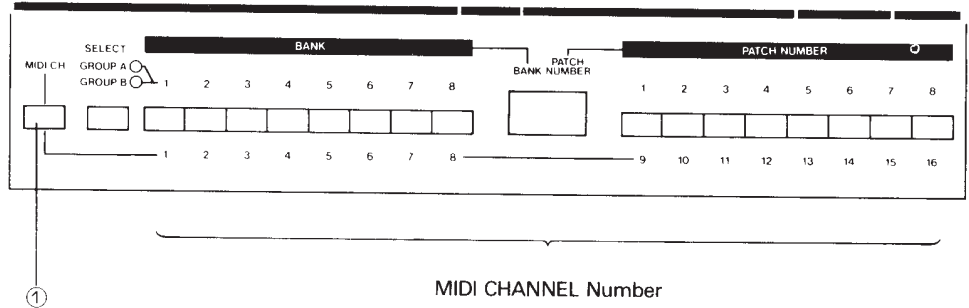

MIDI Channel Button

Pressing the MIDI Channel Button will cause the Display Window to show the MIDI Channel number currently set (1 to 16).

- Turning the Juno-106 on will automatically select Channel 1.

[Special Function]

MIDI Channel Button includes the function of clearing information input through the MIDI Bus. If you are annoyed by a sound that would not stop at all, or Vibrato or Bender effect that remains against your will, press this button to stop it.

■ **Changing MIDI Channels**

While holding the MIDI Channel Button, press the Bank or Patch Number Button, and the new MIDI Channel number will be shown in the Display. Bank Buttons can be used for setting MIDI Channels 1 to 8, and the Patch Number Buttons 1 to 8 correspond to MIDI Channel numbers 9 to 16.

Both receive and transmit functions are included in a MIDI Channel, For instance, changing the channel to "2" will turn both receive and transmit to Channel "2".

* If the receiving MIDI Channel is different from the transmit Channel number, MIDI information is not received (except the unit is set to Omni mode).

► **MIDI BUS**

The MIDI Bus enables communication between two units (or more than two units) by means of digitally controlled signal. The information that can be communicated through the Juno-106's MIDI Bus are as follows.

- 1) Keyboard
- 2) Hold (when a Pedal Switch is used)
- 3) Bender
- 4) Modulation by Bender
- 5) Patch Selections
- 6) Reception and transmission of tone color parameter by System Exclusive Message.

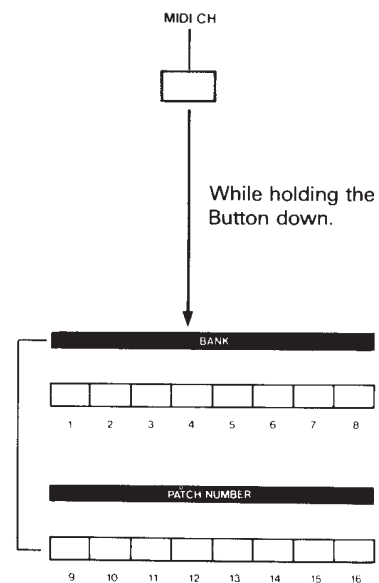

Depending on the position of the MIDI Function, the information to be communicated will differ (Refer to "MIDI Function").

MIDI Jacks

Three jacks are provided to allow connection of the devices featuring the same system. (Connecting non-MIDI devices to the Juno-106 will cause various troubles.)

① **MIDI IN**

By feeding digitally controlled signal of other MIDI device through this input jack, the Juno-106 can be controlled externally.

② **MIDI OUT**

Through this jack, digitally controlled signal is sent out from the Juno-106 driving the MIDI device connected.

* In the Juno-106, the signal fed through MIDI In will not be output from the MIDI Out.

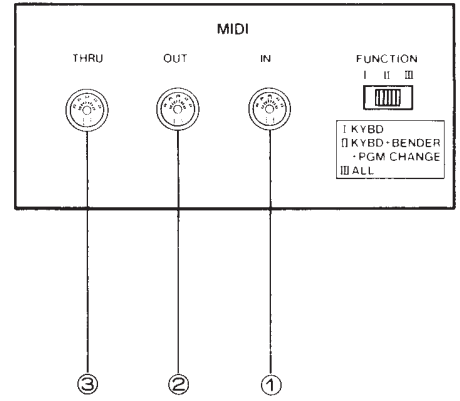

1) Parallel Setup with a Keyboard.

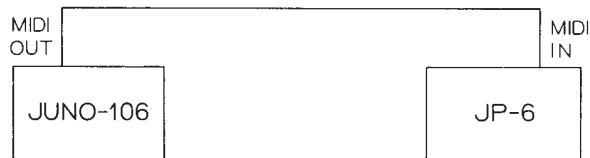

* In a parallel setup of the Juno-106 and other keyboard, set the MIDI Function Switches to I or II.

2) Setup with a Keyboard Recorder

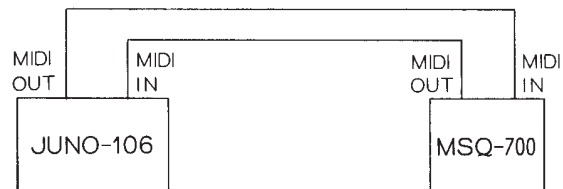

* If setting up the Juno-106 with a keyboard recorder, set the MIDI Function Switch to I or II. Also, set the MIX OUT Switch on the back of the keyboard recorder to off. The output through MIDI OUT is different from the input through MIDI IN.

③ **MIDI THRU**

The digitally controlled signal fed into the MIDI In Jack will be output without processed from this MIDI THRU Jack. By using this jack, it is possible to control more than one device.

[Note]

Please do not set up more than 3 units at a time by using the MIDI THRU Jack. Use the MIDI THRU Box MM-4 (optional).

e. g.) Simultaneous control over the ② and ③ by the Juno-106 ①.

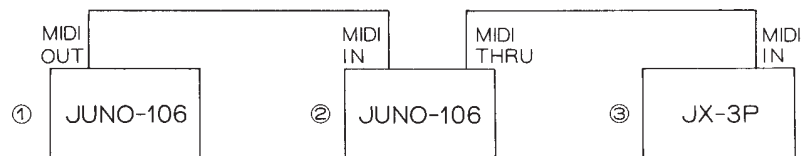

MIDI Function Selector Switch

- I. Select this position for communication of only Keyboard and Hold information.
- II. Select this position for communication of the Keyboard, Hold, Bender on/off control, and Patch Selection information.
- III. This position is to be selected to communicate the information of II plus tone color parameter information by means of System Exclusive message. Regarding Patch Selection information, it can be received by the Juno-106, but is not transmitted from it.

FUNCTION

I II III



I	KYBD
II	KYBD+BENDER +PGM CHANGE
III	ALL

[Note 1]

The remote on/off function of Hold effect by Pedal operation is assigned to No. 64 (40H) in the MIDI Format's Control Change.

HOLD ON BOH, 40H, 7FH

HOLD OFF..... BOH, 40H, 00H

(This applies only when the MIDI Channel 1 is selected).

BOH means Control Change Status.

[Note 2]

The Modulation on/off function of Bender effect is assigned to No. 1.

Modulation on BOH, 01H, 7FH

Modulation off..... BOH, 01H, 00H

(This applies when MIDI Channel 1 is selected).

[Note 3]

The Bender sensitivity and the Modulation depth information cannot be communicated.

* If you wish to obtain such effects on the other keyboard, adjust the relevant controls on it, on the contrary, to obtain such effects on the Juno-106, adjust the Juno-106's controls.

[Note 4]

Regarding Patch Selections, MIDI Format "00" to "7F" are assigned to the Patch programs of Group A-11 to Group B-88.

MIDI Format for Patch Selections

Patch Bank	Patch							
	1	2	3	4	5	6	7	8
1	00 (40)	01 (41)	02 (42)	03 (43)	04 (44)	05 (45)	06 (46)	07 (47)
2	08 (48)	09 (49)	0A (4A)	0B (4B)	0C (4C)	0D (4D)	0E (4E)	0F (4F)
3	10 (50)	11 (51)	12 (52)	13 (53)	14 (54)	15 (55)	16 (56)	17 (57)
4	18 (58)	19 (59)	1A (5A)	1B (5B)	1C (5C)	1D (5D)	1E (5E)	1F (5F)
5	20 (60)	21 (61)	22 (62)	23 (63)	24 (64)	25 (65)	26 (66)	27 (67)
6	28 (68)	29 (69)	2A (6A)	2B (6B)	2C (6C)	2D (6D)	2E (6E)	2F (6F)
7	30 (70)	31 (71)	32 (72)	33 (73)	34 (74)	35 (75)	36 (76)	37 (77)
8	38 (78)	39 (79)	3A (7A)	3B (7B)	3C (7C)	3D (7D)	3E (7E)	3F (7F)

* Numbers in () corresponds to the Bank Group B

[Note 5] MIDI Function (Application of System Exclusive Communication)

In parallel setup of two Juno-106's, if the MIDI Function Switch is set to III, the master Juno can perfectly control the slave one. That is, Information of each parameter of the patch selected in the master Juno will be sent to the slave Juno by means of Exclusive Message. The Information here includes the setting of each control and switch. Here, the Patch Program number Information is not transmitted to the slave Juno, but its tone color will turn out exactly the same as the master Juno's, because of the parameter Information sent from the master Juno.

Changing patches in the master Juno does not alter the Program Number currently shown in the Display on the slave Juno, only dots will light indicating that Exclusive Message has been received.

* Even if the slave Juno is set to Manual mode, dots lighting is seen in the Display when the Exclusive message is received. Also if any of the controls or switches under a red belt of the master Juno is moved even slightly, corresponding parameter Information is transmitted to the slave Juno, by means of Exclusive Message, therefore the slave Juno is perfectly controlled by it, regardless of its own panel setting.

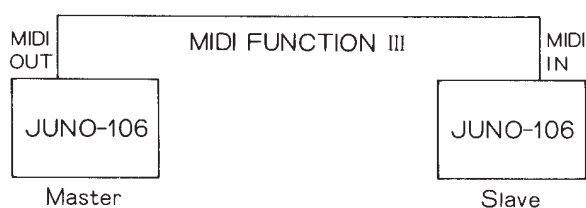

- Exclusive Message is a special kind of message that allows several informations to be communicated between two (or more) Juno-106's, or the Juno-106 and a computer. This Exclusive Message is available only when the MIDI Function Switch is set to III. In the setup with a keyboard other than the Juno-106 or a keyboard recorder, set the MIDI Function to I or II which does not allow communication by Exclusive Message.

Sound Range

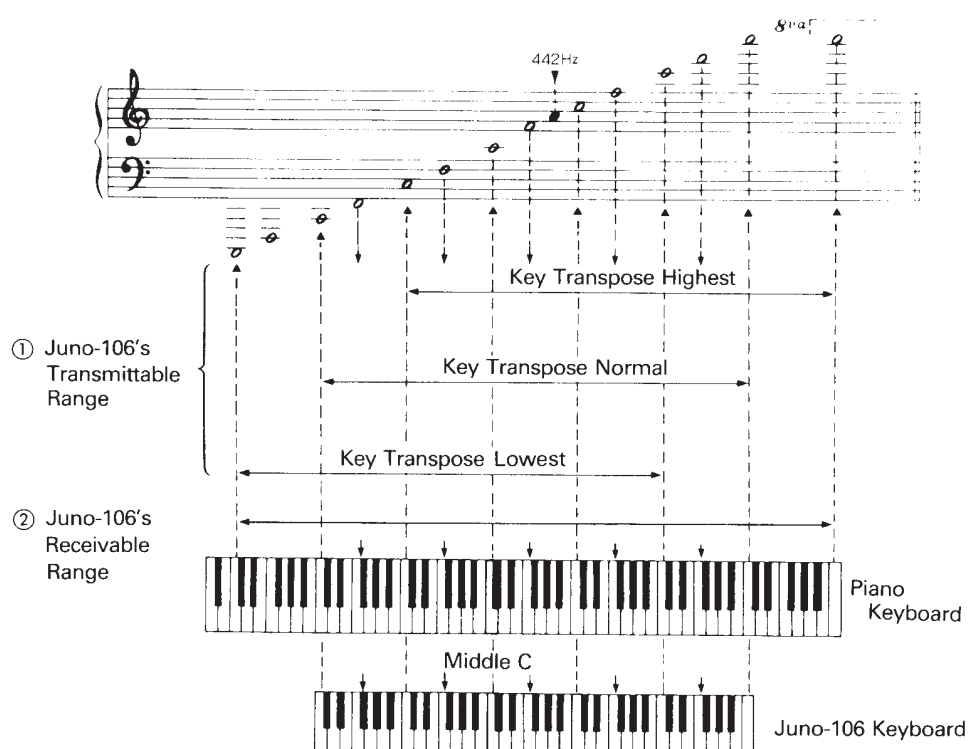

(1) The Juno-106 features Key Transpose function that allows the entire keyboard to be shifted one octave up or down. ① in above figure shows the sound range of key information that can be transmitted by means of MIDI.

(2) ② in above figure shows the sound range (7 octaves) of Key Information that can be received by the Juno-106. If the data sent exceeds this range, it will be automatically transposed up or down to fit in the range. Also, the key Transpose function does not work on the information sent through the MIDI In.

IV. Chorus Effect

The chorus effect gives spaciousness and richness to the sound. The effect becomes stronger from left to right, that is II is stronger than I. It is not possible to use I and II at the same time.

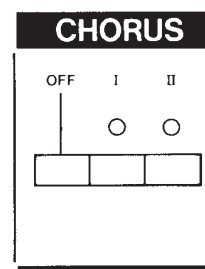

LFO RATE DELAY TIME (0-10)

DCO RANGE (16, 8, 4), LFO, PWM, MAN, SUB, NOISE

HPF FREQ (0-3)

VCF FREQ (0-3), RES (0-5), ENV (0-10), LFO, KYBD (0-10)

VCA LEVEL (+5, 0, -5), GATE

ENV A, D, S, R (0-10)

CHORUS OFF, I, II

KEY TRANSPOSE 1 POLY 2 MIDI CH SELECT BANK PATCH NUMBER (1-16) MANUAL WRITE SAVE VERIFY LOAD

VOLUME (0-10) PORTAMENTO (0-10)

DCO VCF LFO (0-10)

OFF ON LFO TRIG

BENDER

LFO RATE DELAY TIME (0-10)

DCO RANGE (16, 8, 4), LFO, PWM, MAN, SUB, NOISE

HPF FREQ (0-3)

VCF FREQ (0-3), RES (0-5), ENV (0-10), LFO, KYBD (0-10)

VCA LEVEL (+5, 0, -5), GATE

ENV A, D, S, R (0-10)

CHORUS OFF, I, II

KEY TRANSPOSE 1 POLY 2 MIDI CH SELECT BANK PATCH NUMBER (1-16) MANUAL WRITE SAVE VERIFY LOAD

VOLUME (0-10) PORTAMENTO (0-10)

DCO VCF LFO (0-10)

OFF ON LFO TRIG





BENDER

Group()

Patch Bank	1	2	3	4	5	6	7	8
1	11	12	13	14	15	16	17	18
2	21	22	23	24	25	26	27	28
3	31	32	33	34	35	36	37	38
4	41	42	43	44	45	46	47	48
5	51	52	53	54	55	56	57	58
6	61	62	63	64	65	66	67	68
7	71	72	73	74	75	76	77	78
8	81	82	83	84	85	86	87	88

• JUNO-106

• 6 Voice programmable Polyphonic Synthesizer

Keyboard	61 keys, 5 octaves
DCO	LFO Modulation Knob Pulse Width Modulation Knob PWM Mode Switch (LFO/MANUAL) Pulse Wave (ON/OFF) & Indicator Sawtooth (ON/OFF) & Indicator } Waveforms Range Selector Buttons (16", 8", 4") Sub Oscillator Level Knob Noise Level Knob
HPF	Cutoff Frequency Knob (0/1/2/3)
VCF	Cutoff Frequency Knob Resonance Knob (0~Self Oscillation) ENV Modulation Knob Polarity Switch ( , ) LFO Modulation Knob Key Follow Knob (0~100%)
VCA	Control Signal Selector Switch (ENV  /GATE ) VCA Level Knob
ENV	Attack Time Knob (1.5ms~3s) Decay Time Knob (1.5ms~12s) Sustain Level Knob (0~100%) Release Time Knob (1.5ms~12s)
LFO	Rate Knob (0.1Hz~30Hz) Delay Time Knob (0~3s)
Controllers	Volume Knob Portamento Time Knob Portamento Switch (ON/OFF) LFO Trigger Sens Knob Bend Sens (DCO) Knob Bend Sens (VCF) Knob Bender Lever
Assign Mode	Poly I Switch Poly II Switch
Key Transpose	Key Transpose Button & Indicator
MIDI Channel	MIDI Channel Selector Button
Memory	Patch Number Buttons (1~8) Bank Buttons (1~8) Bank Group Selector Button (A/B) Manual Button Write Button Save Button & Indicator Verify Button & Indicator Load Button & Indicator Program Number/MIDI Channel Display Window
Chorus	OFF / I / II Switches
Power	Power Switch

Rear panel	Output Jacks (Mono, Stereo) Phones Jack (Stereo) Pedal Hold Jack (DP-2) Patch Shift Jack (DP-2) Save Jack Load Jack Memory Protect Switch MIDI Function Selector Switch (I, II, III) MIDI In Jack MIDI Out Jack MIDI Thru Jack Tune Adjust Knob (± 50 cent)
Dimensions	992(W) \times 320(D) \times 120(H)mm/ 39-1/16(W) \times 12-5/8(D) \times 4-11/16(H) inch
Weight	10kg/ 22 lb.
Consumption	25W
Accessories	2.5m connection cables..... 1

* Specifications are subject to change without notice.

Options

- Headphones RH-10



- Foot Volume FV-200

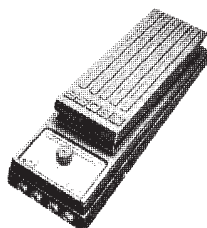

- Pedal Switch DP-2



- Carrying Case AB-1

- Stand KS-2

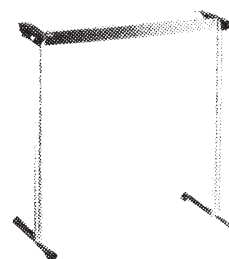

MODEL JUNO-106 MIDI Implementation Chart

Function.....	Transmitted			Recognized			Remarks
	1	2	3	1	2	3	
Basic Channel Default Changed	1 1-16			1 1-16			Tx=Rx
Mode Default Messages Altered	3 OMNI OFF, POLY *****			1 OMNI ON/OFF, POLY MONO (M<>1) → 1, (M=1) → 3			
Note Number True voice	24-108 *****			0-127 24-108			
Velocity Note ON Note OFF	× 9n v=64 fixed × 9n v=0			× ×			n= 0 - \$F
After Touch Key's Ch's	× × × × × ×			× × × × × ×			
Pitch Bender	× ○ ○			× ○ ○			
Control Change	1 64 × ○ ○ ○ ○ ○			× ○ ○ ○ ○ ○			Modulation Hold Modulation value is 0 or 127
Prog Change True #	× ○ × *****			× ○ ○ 0-127			0-127
System Exclusive	× × ○			× × ○			Tone parameters
System Common Song Pos Song Sel Tune	× × ×			× × ×			
System Real Time Clock Commands	× ×			× ×			
Aux Messages Local ON/OFF All Notes OFF Active Sense Reset	× ○ (123) × ×			× ○ (123-127) × ×			
Notes	When power up, OMNI OFF, POLY ON are sent in channel 1. The Note Number message that gives less than 5 ms from Note ON to Note OFF cannot be received.						

Mode 1 : OMNI ON, POLY
Mode 3 : OMNI OFF, POLY

Mode 2 : OMNI ON, MONO
Mode 4 : OMNI OFF, MONO

○ : Yes
× : No

6-voice synthesizer

MODEL JUNO-106 MIDI Implementation

1. TRANSMITTED DATA

1.1 When MIDI FUNCTION is 1.

Note events, Hold on/off and Channel Mode messages are sent.

Status	Second	Third	Description
1001 nnnn	0kkk kkkk	0100 0000	Note on
1001 nnnn	0kkk kkkk	0	Note off
1011 nnnn	0100 0000	0111 1111	Hold on from rear panel jack
1011 nnnn	0100 0000	0	Hold off
1011 nnnn	0111 1011	0	ALL NOTES OFF *2
1011 nnnn	0111 1100	0	OMNI OFF *1
1011 nnnn	0111 1111	0	POLY ON *1

notes:

nnnn : MIDI channel number - 1. (if ch-1, nnnn = 0000)
 kkkkkk : 24 - 108
 *1 When power up or MIDI channel number is set.
 *2 When all Notes turn Off.

1.2 When MIDI FUNCTION is 2.

Messages in FUNCTION 1, Program Change, Bender and LFO Modulation are sent.

Status	Second	Third	Description
1100 nnnn	Oppp pppp		Program Change Group-A : 0 - 63 Group-B : 64 - 127
1110 nnnn	0bb0 0000 (LSB)	0bbb bbbb (MSB)	Pitch Bender MSB LSB MAX (high) 127 96 CENTER 64 0 MIN (low) 0 0
1011 nnnn	0000 0001	0111 1111	LFO Modulation On
1011 nnnn	0000 0001	0	LFO Modulation Off

1.3 When MIDI FUNCTION is 3.

Messages in FUNCTION 1, Bender, LFO Modulation and Exclusive Messages are sent.

2. RECOGNIZED RECEIVE DATA

2.1 When MIDI FUNCTION is 1.

When power is first applied, receiver's mode is OMNI ON, POLY mode.

Notes events, Hold on/off and Channel Mode Messages are recognized.

Status	Second	Third	Description
1000 nnnn	0kkk kkkk	0vVV vvvv	Note OFF, velocity ignored
1001 nnnn	0kkk kkkk	0000 0000	Note OFF kkkkkkk = 0 - 127 (24 - 108)
1001 nnnn	0kkk kkkk	0vVV vvvv	Note ON kkkkkkk = 0 - 127 (24 - 108) vvvvvvv = 1 - 127, velocity ignored
1011 nnnn	0100 0000	0	hold OFF
1011 nnnn	0100 0000	0vVV vvvv	hold ON vvvvvvv = 1 - 127
1011 nnnn	0111 1011	0	ALL NOTES OFF
1011 nnnn	0111 1100	0	OMNI OFF
1011 nnnn	0111 1101	0	OMNI ON
1011 nnnn	0111 1110	0mmm mmmm	MONO ON
1011 nnnn	0111 1111	0	POLY ON

Notes:

Mode messages (123 - 127) are also recognized as ALL NOTES OFF.
 The JUNO-106 does not respond to MONO ON message.

Mode messages are recognized as follows:

OMNI OFF (&7C)	: POLY ON	: MONO ON	: MONO ON
	: mmmmmmm = 1	: mmmmmmm <> 1	
OMNI ON (&7D)	: OMNI = OFF	: OMNI = OFF	: OMNI = ON
	: POLY	: POLY	: POLY
OMNI ON (&7E)	: OMNI = ON	: OMNI = ON	: OMNI = ON
	: POLY	: POLY	: POLY

Recognized channels are as follows:

mode	voice messages	mode messages
OMNI OFF mode	basic channel only	basic channel only
OMNI ON mode	all channels	basic channel only

2.2 When MIDI FUNCTION is 2.

Messages in FUNCTION 1, Program Change, Bender and LFO Modulation are recognized.

Status	Second	Third	Description
1100 nnnn	Oppp pppp		Program Change 0 - 63 : Group-A 11 - 88 64-127 : Group-B 11 - 88
1110 nnnn	0b00 0000	0bbb bbbb	Pitch Bender LS 6 bits are ignored
1011 nnnn	0000 0001	0vVV vvvv	LFO Modulation v = 0 (min) --> 127 (max)

note: Sensitivity of the pitch bender and modulation can be adjusted by receiver.

2.3 When MIDI FUNCTION is 3.

Messages in FUNCTION 2 and EXCLUSIVE messages are recognized.

3. EXCLUSIVE MESSAGES

3.1 When Group, Bank or Patch number is changed.

byte	description
a 1111 0000 \$FO	Exclusive
b 0100 0001 \$41	Roland ID #
c 0011 0000 \$30	function type
d 0000 nnnn \$0N	N+1 = MIDI channel, N = 0 - 15
e 0xxx xxxx	Program number 0 - 127
f 0zzz zzzz	value 0 - 127 (18 bytes total for values)
g 1111 0111 \$F7	EOX

*** Example ***

a b c d e f f
FO 41 30 00 00 39 2D 00 37 00 55 00 00 00

f g
19 34 3B 20 56 28 00 1A 18 F7

3.2 When Manual Button is pressed.

byte	description
a 1111 0000 \$FO	Exclusive
b 0100 0001 \$41	Roland ID
c 0011 0001 \$31	function type
d 0000 nnnn \$0N	N+1 = MIDI channel, N = 0 - 15
e 0000 0000 \$00	Number indicates "Manual"
f 0zzz zzzz	value 0 - 127 (18 bytes total for values)
g 1111 0111 \$F7	EOX

*** Example ***

a b c d e f f
FO 41 31 00 00 03 00 00 00 00 3F 3C 00 00

f g
7F 45 00 00 7F 00 00 2A 19 F7

3.3 When volume controllers or switches are changed.

byte	description
a 1111 0000 \$FO	Exclusive
b 0100 0001 \$41	Roland ID
c 0011 0001 \$32	function type
d 0000 nnnn \$0N	N+1 = MIDI channel, N = 0 - 15
e 0yyy yyyy	parameter number 0 - 17
f 0zzz zzzz	value 0 - 127
g 1111 0111 \$F7	EOX

*** Example ***

a b c d e f g
FO 41 32 00 03 04 F7

3.4 Parameter number table

* for potentiometers

p #	function	p #	function
0	LFO rate	8	VCF LFO
1	LFO delay	9	VCF KYBD
2	DCO LFO	10	VCA level
3	DCO PWM	11	attack
4	noise level	12	decay
5	VCF cutoff	13	sustain
6	resonance	14	release
7	VCF ENV	15	sub level

* for switches

bit	5	4	3	2	1	0
p #	function					
16	chorus	chorus	saw	pulse	range	
	1: 1	1:off	1:on	1:on	100 : 4'	
	0: 2	0:on	0:off	0:off	010 : 8'	
					001 : 16'	
17	0	0	HP filter	VCA	ENV	PWM
			11 : off	1:gate	1: -	1:MAN
			10 : 1	0:ENV	0: +	0:LPO
			01 : 2			
			00 : 3			

