

HP 9800 Computers



9845B/C CE Handbook



Part No. 09845-90039
E0182
Requires Binder No. 9282-0683

Printed in U.S.A.
First Edition, January 1982

9845B/C CE Handbook

© Copyright Hewlett-Packard Company, 1982

This document refers to proprietary computer software which is protected by copyright. All rights are reserved. Copying or other reproduction of this program except for archival purposes is prohibited without the prior written consent of Hewlett-Packard Company.

Hewlett-Packard Company
3404 East Harmony Road, Fort Collins, Colorado 80525

Product Information	1
Environmental/Installation/PM	2
Configuration	3
Troubleshooting	4
Diagnostics	5
Adjustments	6
Peripherals	7
Replaceable Parts	8
Diagrams	9
Reference	10
Service Notes	11

Printing History

New editions of this manual will incorporate all material updated since the previous edition. Update packages may be issued between editions and contain replacement and additional pages to be merged into the manual by the user. Each updated page will be indicated by a revision date at the bottom of the page. A vertical bar in the margin indicates the changes on each page. Note that pages which are rearranged due to changes on a previous page are not considered revised.

The manual printing date and part number indicate its current edition. The printing date changes when a new edition is printed. (Minor corrections and updates which are incorporated at reprint do not cause the date to change.) The manual part number changes when extensive technical changes are incorporated.

January 1982...First Edition

| April 1984...Second Edition. Updated pages.

Warranty Statement

Hewlett-Packard products are warranted against defects in materials and workmanship. For Hewlett-Packard Fort Collins Systems Division products sold in the U.S.A. and Canada, this warranty applies for ninety (90) days from the date of delivery.* Hewlett-Packard will, at its option, repair or replace equipment which proves to be defective during the warranty period. This warranty includes labor, parts, and surface travel costs, if any. Equipment returned to Hewlett-Packard for repair must be shipped freight prepaid. Repairs necessitated by misuse of the equipment, or by hardware, software, or interfacing not provided by Hewlett-Packard are not covered by this warranty.

HP warrants that its software and firmware designated by HP for use with a CPU will execute its programming instructions when properly installed on that CPU. HP does not warrant that the operation of the CPU, software, or firmware will be uninterrupted or error free.

HEWLETT-PACKARD MAKES NO WARRANTY OF ANY KIND WITH REGARD TO THIS MATERIAL, INCLUDING, BUT NOT LIMITED TO, THE IMPLIED WARRANTIES OF MERCHANTABILITY AND FITNESS FOR A PARTICULAR PURPOSE. Hewlett-Packard shall not be liable for errors contained herein or for incidental or consequential damages in connection with the furnishing, performance or use of this material.

* For other countries, contact your local Sales and Support Office to determine warranty terms.

Table of Contents

Chapter 1: 9845B/C Mainframe Product Information

9845B/C Computer Specifications	1-1
Option Information	1-2
Field Installed Options	1-3
Factory Installed Options	1-4
Accessories Supplied	1-5
Accessories Available	1-6
Mainframe Serial Numbers	1-6
9845B/C Options	1-7

Chapter 2: 9845B/C Environmental, Installation, and Preventive Maintenance

Environmental Specifications,	
Electrical	2-1
Physical	2-1
Installation,	
Introduction	2-2
Table Mounting	2-2
CRT	2-3
Option ROMs	2-6
Interface Cards	2-8
Checking Fuses, Voltage, and Power Cords	2-9
Initiating Power	2-13
Loading Printer Paper	2-13
Inserting and Removing the Tape Cartridge	2-15
9845B/C Mainframe Verification,	
System Exerciser	2-15
Turn-On Self Test	2-15
Exerciser Starting Procedure	2-16
9845B/C Mainframe Exercisers,	
Selecting an Exerciser	2-17
Memory Exerciser	2-18
Tape Exerciser	2-18
Printer Exerciser	2-20
ROM Revision Exerciser	2-21
9845B/C Operating Basics,	
Basic Keyboard Operation	2-23
Mass Storage	2-24
Automatic Start for Programs	2-25
9845B/C Mainframe Preventive Maintenance	2-25

Chapter 3: 9845B/C Configuration

System Configurations	3-1
Software Compatibility	3-3

Chapter 4: 9845B/C Mainframe Troubleshooting

Troubleshooting Checklist	4-1
Troubleshooting Tables	4-3
Troubleshooting Flowchart	4-4
Memory Troubleshooting	4-10

Chapter 5: 9845B/C Mainframe Diagnostics

Introduction	5-1
Quick Checks	5-1
Diagnostic Programs	5-3
ROM and Cartridge Tests	5-3
Using the Test ROM Only	5-4
Using the Test Binary Cartridge Only	5-5
Processor/Memory Control Test	5-5
Initial Memory Test	5-5
ROM and Read/Write Memory Tests	5-5
k1 Keyboard Test	5-6
k2 Cartridge Drive Exerciser	5-8
k3 Printer Test	5-10
k6 Display Results	5-11
k7 Rewind T15	5-12
k8 Read/Write Memory Troubleshooter	5-12
k9 Read/Write Memory Test	5-14
k10 Choose Rack Test Sequence	5-14
ROM Checksum Test	5-15
k11 Automatic Rack Test	5-15
k15 Run Operating System	5-15
k15 Operating System Acceptance Test	5-16

Chapter 6: 9845B/C Mainframe Adjustments

Adjustments to the Thermal Printer	6-1
--	-----

Chapter 7: 9845B/C Mainframe Peripherals

Supported Peripherals	7-1
Hardware Compatibility Information	7-2

Chapter 8: 9845B/C Mainframe Replaceable Parts

Repair Philosophy	8-1
Repair Parts/Part Numbers	8-3
Service Kits	8-13

Chapter 9: 9845B/C Mainframe Diagrams

Processor (A15)	9-1
Memory Map	9-2
Power Supply (A80)	9-5
PowerSupply (A81)	9-6
Power Supply Specifications	9-7
Processor (A30)	9-8
Memory Assemblies	9-9
Cartridge Drive	9-11
Keyboard	9-12
Printer	9-13
Keyswitch Diagrams	9-14

9845B/C Mainframe References

Manual References	10-1
Error Messages	10-2
ASCII Table	10-12

Chapter 11: 9845B/C Service Notes 11-1

9845B/C Mainframe Product Information

Chapter
1

9845B/C Computer Specifications

The following specifications are common to both the System 45B and 45C.

COMPUTATIONAL

- Memory**
- Dynamic Range -10^{99} to -10^{-99} , 0, $+10^{-99}$ to $+10^{99}$
- Internal Calculation**
- Range -10^{511} to -10^{-511} , 0, $+10^{-511}$ to $+10^{511}$
- Tape Cartridge**
- Capacity (per cartridge) 217 000 bytes
- Access directory (stored in r/w memory), file-by-name
- Search Speed (bidirectional) 2 286 mm/s. (90 in/s.)
- Average Access Time 6 s.
- Average Transfer Rate 1 440 byte/s.
- Rewind Time 19 s. (end to end)
- Cartridge Size 63.5 x 82.5 x 12.7mm (2.5 x 3.25 x 0.5 in.)

Read/write

- Verification program recording
- Error Check check sum

Note: Tape cartridges are intended for nominal program or data storage; the typical life cycle is 50-100 hours of use, depending upon the application. It is suggested that tape transports be cleaned regularly and tape cartridges removed from drives after use.

THERMAL LINE PRINTER

- Printing Speed up to 480 lines/minute
- Plotting Speed:
 - normal mode 25.4 mm/s. (1 in./s.)
 - CRT transfer 3.5 to 25 mm/s. (0.14 to 1 in./s.)

Character Matrix 5 x 7 dots (7 x 12 field)

Noise Level:

9 hours @ 100% duty cycle 68 dba (max.)

0.5 hours @ 100% duty cycle 55 dba (avg.)

Paper Feed automatic load

Paper Dimensions:

- English version 216 mm x 61m (8.5 in. x 200 ft.)
- Metric version 210mm x 60m (8.27 in. x 197 ft.)

Paper Types

..... black print, perforated

..... blue print, continuous roll

Note: The 9845 printer is designed to print approximately 50 000 Ft. of paper (about 250 rolls) prior to print head replacement. However, actually print head life may vary widely depending upon usage.

CRT ALPHANUMERIC MODE

- Character Generation 7 x 9 character font in a 9 x 15 character cell
- Cursor blinking underline
- Highlighting inverse video, blinking and underlining
- MOS Memory 7 680 bytes of non-user read/write memory

KEYBOARDS

- Standard ASCII,
- also available in French, Spanish, German Katakana, Swedish/Finnish

The following specifications vary between the HP 9845B and HP 9845C.

SPECIFICATIONS	HP 9845B (with standard processor and CRT)	HP 9845B (with enhanced processor and CRT)	HP 9845C
ALPHA RASTER SIZE	236 x 122.94mm (9.3 x 4.84 in.)	236 x 149mm (9.3 x 5.9 in.)	247 x 154mm (9.72 x 6.06 in.)
SCREEN CAPACITY	26 lines x 80 characters (2 080 characters)	26 lines x 80 characters (2 080 characters)	26 lines x 80 characters (2 080 characters)
DOT SPACING	0.328mm (0.013 in.)	0.328mm (0.013 in.)	0.343mm (0.0135 in.)
GRAPHICS MODE			
Raster Size	200x162.5mm (7.9x6.4in.)	184x149mm (7.2x5.8in.)	192x156mm (7.5x6.1 in.)
Display Speed			
(Vectors/s., overlapped and not clipped)			
For/Next	~ 50	~ 270	Opt. 100 Opt. 200 ~95 ~145
Matrix Plot	N.A.†	~430	~200 ~240
Absolute Plot	N.A.†	~5000	~5000 ~5000
Circles/s., not clipped	N.A.†	~240	~2 ~5
Linearity	1.5% full screen	1.5% full screen	<2% full screen
Array Size	560 x 455 dots	560 x 455 dots	560 x 455 dots
Dot Resolution	0.357mm (0.014 in.)	0.33mm (0.013 in.)	0.034mm (0.013 in.)
CURSOR			
Plotting Mode	Full screen or blinking crosshair	Full screen or blinking crosshair	Full screen or small crosshair
Letter Mode	Blinking underline	Blinking underline	Blinking underline
Character Editing	Overstrike in letter mode	Overstrike in letter mode	Overstrike in letter mode

HP 9845 Computer Option Information

Both the System 45B and the System 45C are available in expanded, standard and minimum configurations. The expanded configuration has been designed to handle even the most demanding computation, design or I/O applications. The standard configuration has been selected as the system that will best meet most computer needs. The minimum configuration contains those features that are part of every 9845B and 9845C.

Features Features included with unit/option	HP 9845C Expanded 190 270 290			HP 9845B Expanded 190 270 290			HP 9845C Standard 150 250			HP 9845B Standard 150 250			HP 9845C Minimum 100 200			HP 9845B Minimum 100 200		
High-resolution color graphics CRT	X	X	X				X	X					X	X				
High-speed language processor		X	X		X	X		X			X			X				X
Color graphics ROM	X	X	X				X	X					X	X				
Standard monochrome CRT					X						X							X
High-performance monochrome CRT					X	X					X							X
Monochrome graphics ROM					X	X					X	X						X
Monochrome Graphics CRT subsystem					X	X					X	X						X
Alphanumeric CRT	X	X	X	X	X	X	X	X	X	X	X	X	X	X	X	X	X	X
Interactive light pen	X	X	X		X	X	X	X	X	X	X	X						
449k bytes r/w memory	X		X	X		X												
318k bytes r/w memory		X			X													
187k bytes* r/w memory							X	X	X	X	X	X						
56k bytes* r/w memory													X	X	X	X	X	X
Mass storage ROM	X	X	X	X	X	X												
80-column thermal line printer	X	X	X	X	X	X	X	X	X	X	X	X						
CRT softkeys	X	X	X	X	X	X	X	X	X	X	X	X	X	X	X			X
Dual tape cartridge drives	X	X	X	X	X	X	X	X	X	X	X	X						
Single tape cartridge drive													X	X	X	X	X	X
Powerful HP enhanced BASIC language	X	X	X	X	X	X	X	X	X	X	X	X	X	X	X	X	X	X
Advanced Programming ROM	X	X	X	X	X	X												
Structured Programming ROM	X	X	X	X	X	X												
Typewriter-like alphanumeric keyboard	X	X	X	X	X	X	X	X	X	X	X	X	X	X	X	X	X	X
Dual processors	X	X	X	X	X	X	X	X	X	X	X	X	X	X	X	X	X	X
15 assignable levels of priority interrupt	X	X	X	X	X	X	X	X	X	X	X	X	X	X	X	X	X	X
Direct Memory Access	X	X	X	X	X	X	X	X	X	X	X	X	X	X	X	X	X	X
I/O ROM	X	X	X	X	X	X												
Asynchronous Data Communications capability	X		X	X		X												
Data Base Management capability	X		X	X		X												

*Can be upgraded with memory options.

Note: Minimum and Standard systems can be upgraded to Expanded systems.

Field Installed Options

Product No.	Description
98425A 98426A 98427A Opt. 207	READ/WRITE MEMORY 130 880 bytes incremental 261 760 bytes incremental 392 640 bytes incremental 512K bytes of RAM. May be ordered in quantities of one or two.
98411A 98412A 98413A 98414A 98415A 98417A 98418A 98430A 98438A 98439A	READ ONLY MEMORIES Graphics ROM (9845B Opt. 100 only) I/O ROM Mass Storage ROM Advanced Programming ROM Structured Programming ROM BASIC Datacomm ROM IMAGE/45 (ROMs only) Note: You must specify appropriate language version Opt. 330 English DBMs Opt. 331 French DBMs Opt. 332 German DBMs Data Base Management System (IMAGE/45, QUERY/45) Note: You must specify appropriate language version Opt. 330 English DBMs Opt. 331 French DBMs Opt. 332 German DBMs Assembly Language Execution ROM Assembly Execution and Development ROM
Opt. 040 Opt. 041 Opt. 061	THERMAL LINE PRINTERS Note: ASCII/EUR printer is shipped with all models unless otherwise stated. Order only one. 8.5 inch paper width, Katakana character set. 210mm paper width, Katakana character set. 210mm paper width, ASCII/EUR character set.
98460A	SECOND TAPE CARTRIDGE DRIVE (9845B and 9845C Opt. 100 or 200 only)
98470A Opt. 101	GRAPHICS DISPLAY SUBSYSTEM (9845B Opt. 100 only) (order with 98411A) Field Installation character for above options.
98775A	LIGHT PEN (9845B Opt. 200) 9845C Opt. 100 or 200 (NA for 9845B Opt. 175)
98401A Opt. 312 Opt. 313 Opt. 800 Opt. 810 Opt. 820 Opt. 830 Opt. 840 Opt. 850 98402A Opt. 311 Opt. 560 98403A 98404A Opt. 041 Opt. 775 98405A Opt. 041 Opt. 775 98771A Opt. 101 Opt. 771	UPGRADE KITS 9845S to 9845B Opt. 150 includes 576K bytes of R/W memory, Graphics ROM, and Printer ROM. I/O ROM Mass Storage ROM ASCII Keyboard French Keyboard Spanish Keyboard German Keyboard Katakana Keyboard Swedish/Finnish Keyboard Options 800 through 850 are the language options and include the language ROM's in the mainframe, the appropriate ROM for the printer, and the CRT. 9845A to 9845B Opt. 100 Upgrade Kit includes 56K bytes of R/W memory. Graphics ROM for 98402A ASCII/EUR printer ROM. The options listed under 98401A are also available for 98402A. Fast language Processor (for 9845B/C only). Monochromatic Display Upgrade kit. for the 9845B Enhanced Graphics. Requires 98403A. Katakana Display. Light Pen. Combines 98403A and 98404A. Katakana Display. Light Pen. 9845B to 9845C upgrade kit. Katakana Character set. ASCII/EUR Character set.

Factory Installed Options

Product No.	Description
	READ/WRITE MEMORY
	9845B (Opt. 100, 200)
Opt. 204	187 146 total bytes
Opt. 205	318 026 total bytes
Opt. 206	448 906 total bytes
	9845C (Opt. 100, 200)
	186 940 total bytes
	317 820 total bytes
	448 700 total bytes
	9845B (Opt. 150, 250)
	9845C (Opt. 150, 250)
215	318 026 total bytes
216	448 906 total bytes
	448 700 total bytes
	READ ONLY MEMORIES
98411B	Graphics ROM (for 9845B-100).
98412A	I/O ROM
98413C	Mass Storage ROM.
98414A	Advanced Programming ROM.
98415A	Structured Programming ROM.
98417A	BASIC Datacomm ROM.
98418A	RJE Bisync Datacomm ROM (Requires 98417A)
98419B	Resource Management ROM (also order 98029A with one option)
98429A	IMAGE/45 Data base management.
98430A	Data Base Management System (IMAGE/45 management ROM and Query/45 software) Requires 98413C and 98414A. I/O ROM not required, but if used with IMAGE must be Revision C. Order one of the following:
Opt. 330	English Language.
Opt. 331	French Language.
Opt. 332	German Language.
98438A	Assembly Language Executive ROM.
98439A	Assembly Executive and Development ROM.
	98411, 412, 413, 414, and 415 are all supplied with all 9845B/C computers.
	9845B-175, 275, and 9845C-275 all include 98417.
	9845B/C-280 include 98430 (which includes 98429).
	READ ONLY MEMORIES
Opt. 311	Graphics ROM (for 9845B Opt. 100 only).
Opt. 312	I/O ROM
Opt. 313	Mass Storage ROM.
Opt. 314	Advanced Programming ROM.
Opt. 438	Assembly Language Execution ROM
Opt. 439	Assembly Language Execution and Development ROM
	THERMAL LINE PRINTERS (order only one)
	For 9845B and 9845C Opt. 100 or 200
Opt. 560	8½ in. paper, ASCII or European character sets
Opt. 561	210mm paper, ASCII or European character sets
Opt. 540	8½ in. paper, Katakana character set
Opt. 541	210mm paper, Katakana character set
	For 9845B/C Opt. 150,250,270,190,290
Opt. 060	8½ in. paper, ASCII or European character sets
Opt. 061	210mm paper, ASCII or European character sets
Opt. 040	8½ in. paper, Katakana character set
Opt. 041	210mm paper, Katakana character set
	SECOND TAPE CARTRIDGE DRIVE
Opt. 600	Order for 9845B and 9845C Opt. 100 or 200 only.
	GRAPHICS DISPLAY SUBSYSTEM
Opt. 700	9845B Opt. 100 only, order with Opt. 311
	LIGHT PEN
Opt. 775	Order or 9845B Opt. 200 or 9845C Opt. 100 or 200

Product No.	Description
	KEYBOARDS
	Note: Keyboards are available only as factory installed options.
Opt. 800	ASCII
Opt. 810	French
Opt. 820	Spanish
Opt. 830	German
Opt. 840	Katakana
Opt. 850	Swedish/Finnish
98407A	512K bytes of incremental RAM (any 9845B/C). Up to 1.6M bytes total may be installed. (existing 128K RAM may need to be removed to make room) Are compatible.
Opt. 001	Memory upgrade kit. Required for 9845B/C-100, 160, 190, 200, 250, 270, or 290 when the first 512K board is installed.
Opt. 002	Enhanced graphics ROM upgrade kit. Required for any 9845B/C that has Rev A. Enhanced graphics ROM or Color graphics ROM installed.
Opt. 003	Image upgrade kit. Required if the 9845B/C has a rev B or earlier Image ROM in the left hand ROM drawer.

9845B/C Accessories

Accessories Supplied

The following items are packaged with each 9845

Item	Part Number	9845B "100" Models	9845B "200" Models	9845C "100" Models	9845C "200" Models
Operating and Programming Manual	09845-93000	1	1	1	1
Installation Operation and Test Manual	09845-93005	1	1	1	1
Quick Reference	09845-93015	1	1	1	1
Color Graphics Manual	09845-92051			1	1
Monochromatic Graphics	09845-93050		1		
BASIC Language Interfacing Concepts	09835-90600	1	1	1	1
Manual Binder	9282-0898	2	2	2	2
System Exerciser Cartridge #1	09845-92041	1	1	1	1
System Exerciser Cartridge #2	09845-92042	1	1	1	1
9845B Introductory Training Package:	09845-10120	1	1		
9845B Introductory Training Cartridge	09845-10124	1	1		
System 45 Workbook	09845-93090	1	1		
9845C Introductory Training Package:	09845-10220			1	1
9845B Introductory Training Package	09845-10120			1	1
Graphics Training Cartridge	09845-10225			1	1
System 45 Graphics Workbook	09845-93091			1	1
9845C Advanced Color Graphics Pack:	09845-10230			1	1
Color Utilities Tape	09845-10234			1	1
Color Examples Tape	09845-10235			1	1
Advanced Color Graphics Manual	09845-93055			1	1
Utility Library Software Pack	09845-10200			1	1
Special Function Key Overlays	7120-6164	5	5	5	5
Blank Tape Cartridges	next table	2	2	2	2
Dust Cover	9222-0592	1			
Dust Cover	9222-0728	1	1	1	1
Magnetic Head Cleaner	8500-1251	1	1	1	1
Spare fuses:					
4 Amp (5B)	2110-0365	1		1	
8 Amp (NB)	2110-0342	1		1	
6 Amp (NB)	2110-0056		1	1	2
10 Amp (NB)	2110-0051		1	1	2

Accessories Available

Single items may be purchased using the appropriate part number.

Peripheral devices, ROMs and interface cards are packaged separately from the 9845; each of these has its own manual or operating note and may also have extra items packaged with it.

Item	9845B/C All Options
Blank Tape Cartridges (package of 5)	98200-67000
High-contrast Blue-print Continuous Thermal Paper: Standard Metric	92161N 92161B
High-contrast Black-print Continuous Thermal Paper: Standard Metric	92161P 92161C
High-contrast Black-print Perforated Thermal Paper: Standard Metric	92161R 92161E

9845B/C Mainframe Serial Numbers

Serial numbers for the 9845B/C mainframes are keyed to three situations. An example and explanation is as follows:

Serial # 1832A00123

Located on the back panel next to the power connector.



5 digit sequential number, allocated as such;
00001-00050 Prototype Units
00051-00100 Pilot Run Units
00101-99999 Production Units

Country of origin code; A is United States (DCD).
G is West Germany (BDD).
J is Japan (YHP).

The 9845B/C product code decoded as such:
First 2 digits + 60 = Last 2 digits of the year product was introduced.

Last 2 digits = Number of week in year product was introduced.

18 = year 1978; 32 = thirty second week.

* When using Metric Thermal Paper, a spacer must be used in the paper tray. p/n 5040-8145

9845B/C Options

	9845B Opt.									
	100	150	175	190	200	250	270	275	280	290
09845-66515 (Standard LPU Processor)	X	X	X	X						
09845-67930 (Fast LPU Processor)					X	X	X	X*	X	X
09845-66527 (PPU RAM/ROM)	X	X		X	X	X	X			X
09845-66528 (LPU RAM/ROM)	X	X	X	X						
09845-66529 (PPU RAM/ROM)			X					X*	X	
09845-66546 (LPU RAM/ROM)				X	X	X	X	X*	X	
Standard Monochromatic CRT.	X	X	X	X						
High-performance Monochromatic CRT.				X	X	X	X	X*	X	
Color Graphics CRT.										
09845-66593 (Alpha Leg)	X	X	X	X						
98770-66534 (Alpha Leg)					X	X	X	X*	X	X
Single Tape Drive	X									
Dual Tape Drives		X	X	X	X	X	X	X*	X	X
Thermal Printer		X	X	X	X	X	X	X*	X	X
09845-65517 (Graphics ROM)		X	X	X						
98770-65501 (Graphics ROM)					X	X	X	X*	X	X
98780-65501 (Enhanced Graphics ROM)					X	X	X	X*	X	X
Graphics Package	X	X	X	X	X	X	X	X*	X	X
Light Pen						X	X			X
09845-65518 (LPU I/O ROM)			X	X			X	X*	X	X
09845-65519 (PPU I/O ROM)			X	X			X	X*	X	X
09845-65516 (Mass Storage ROM)			X	X			X	X*	X	X
09845-65528 (Structured Prog. ROM)			X	X			X	X*	X	X
09845-65521 (Advanced Prog. ROM)			X	X			X	X*	X	X
56K bytes of R/W Memory	X				X					
187K bytes of R/W Memory		X				X				
318K bytes of R/W Memory			X							
448K bytes of R/W Memory		X								X
512K bytes of R/W Memory	X							X	X	
09845-10270 (Graphics Utilities Software)							X			
BASIC Datacomm ROM			X					X		X
9846B Opt 001 (Datacomm. Interface)			X					X		X
High Speed Terminal Emulator)			X					X		X
Data Base Management Capability									X	X
09845-65527 (PPU, Image/45 ROM)									X	X
09845-65526 (LPU, Image/45 ROM)									X	X
QUERY/45 Software									X	X
98034B HP-IB Interface									X	X
Statistics Library Software									X	X
DBM/Statistics Linkage Software									X	X
Graphics Presentations Software									X	X

	9845C Opt.								
	100	150	190	200	250	270	275	280	290
09845-66515 (Standard LPU Processor)	X	X	X						
09845-67930 (Fast LPU Processor)				X	X	X	X	X	X
09845-66527 (PPU RAM/ROM)	X	X	X	X	X	X			X
09845-66528 (LPU RAM/ROM)	X	X	X						
09845-66529 (PPU RAM/ROM)							X	X	
09845-66546 (LPU RAM/ROM)			X	X	X	X	X	X	
Standard Monochromatic CRT.									
High-performance Monochromatic CRT.									
Color Graphics CRT.									
09845-66593 (Alpha Leg)	X	X	X	X	X	X	X	X	X
98770-66534 (Alpha Leg)	X	X	X	X	X	X	X	X	X
Single Tape Drive									
Dual Tape Drives	X	X	X	X	X	X	X	X	X
Thermal Printer	X	X	X	X	X	X	X	X	X
09845-65517 (Graphics ROM)									
98770-65501 (Graphics ROM)	X	X	X						
98780-65501 (Enhanced Graphics ROM)				X	X	X	X	X	X
Graphics Package	X	X	X	X	X	X	X	X	X
Light Pen		X	X		X	X			X
09845-65518 (LPU I/O ROM)			X			X	X	X	X
09845-65519 (PPU I/O ROM)			X			X	X	X	X
09845-65516 (Mass Storage ROM)			X			X	X	X	X
09845-65528 (Structured Prog. ROM)			X			X	X	X	X
09845-65521 (Advanced Prog. ROM)			X			X	X	X	X
56K bytes of R/W Memory	X			X					
187K bytes of R/W Memory		X			X				
318K bytes of R/W Memory									X
448K bytes of R/W Memory			X						X
512K bytes of R/W Memory							X	X	
09845-10270 (Graphics Utilities Software)						X			
BASIC Datacomm ROM							X		X
9846B Opt 001 (Datacomm. Interface)							X		X
High Speed Terminal Emulator)							X		X
Data Base Management Capability								X	X
09845-65527 (PPU, Image/45 ROM)								X	X
09845-65526 (LPU, Image/45 ROM)								X	X
QUERY/45 Software								X	X
98034B HP-IB Interface								X	X
Statistics Library Software								X	X
DBM/Statistics Linkage Software								X	X
Graphics Presentations Software								X	X

9845B/C

Environmental/Installation/PM

Chapter

2

9845B/C Environmental Specifications

9845B/C Electrical Specifications

The following specifications are common to both the System 45B and 45C.

POWER REQUIREMENTS

Source	110 Vac + 15%, -20%
(selected by rear panel switch)	220 Vac + 15%, -20%
Line Frequency	48-66Hz
Power Consumption	500 watts (max.)
	7.5A @ 90-126V
	3.5A @ 198-252V

550 watts (max.) add'l for 9845C CRT display only

Powerline Susceptibility	passes \pm 400Vac pulse
(duration = 800 nanoseconds, rise time = 1 nanosecond) with 60Hz pulse repetition	

Environmental Range

Operating Temperature	5°C to 40°C
Storage Temperature	-40°C to +65°C
Relative Humidity	5% to 80% @40°C

9845B/C Physical Specifications

SPECIFICATIONS	HP 9845B (with standard processor and CRT)	HP 9845B (with enhanced processor and CRT)	HP 9845C
SIZE			
Height	478mm (18.8 in.)	546mm (21.5 in.)	546mm (21.5 in.)
Depth	671mm (26.4 in.)	762mm (30 in.)	762mm (30 in.)
Width	478mm (18.8 in.)	482.5mm (19 in.)	482.5mm (19 in.)
Cube	0.15m ³ (5.4 ft. ³)	.20m ³ (7.09 ft. ³)	.20m ³ (7.09 ft. ³)
NET WEIGHT			
Standard Mainframe	18.6 kg (41 lb.)	18.6 kg (41 lb.)	18.6 kg (41 lb.)
Standard CRT	10.43 kg (23 lb.)	18.6 kg (41 lb.)	29.5 kg (65 lb.)
Graphics Option	0.9 kg (2 lb.)	0.9 kg (2 lb.)	
Second Tape Drive	0.9 kg (2 lb.)	0.9 kg (2 lb.)	0.9 kg (2 lb.)
Optional Thermal Printer	5.22 kg (11.5 lb.)	5.22 kg (11.5 lb.)	5.22 kg (11.5 lb.)
SHIPPING WEIGHT (Approximate):			
(Approximate):	Opt. 100 = 53.6 kg. (118 lb.)	Opt. 200 = 63.5 kg (140 lb.)	Opt. 100, 200 = 75.4 kg. (166 lb.)
	Opt. 150 = 61.4 kg. (135 lb.)	Opt. 250 = 69.9 kg (154 lb.)	Opt. 150, 250 = 81.8kg. (180 lb.)
CRT			
Screen	310mm (12.2 in.) diagonal	310mm (12.2 in.) diagonal	330mm (13 in.) diagonal
Screen Brightness	Manually adjustable from 12 to 30 ft.-Lamberts	Manually adjustable from 12 to 30 ft.-Lamberts	Manually adjustable from 12 to 40 ft.-Lamberts (white)
X-ray Emission	\leq 0.5mR/hr.	\leq 0.5mR/hr.	\leq 0.5mR/hr.
Refresh Rate	60 Hz. (independent of line frequency)	60 Hz. (independent of line frequency)	60 Hz (independent of line frequency)
Tube Phosphor	P31	P31	P22
Implosion Protection	Tension band	Implosion panel	Tension band
Maximum Altitude	4 572m (15 000 ft.)	4 572m (15 000 ft.)	4 572m (15 000 ft.)

9845B/C Installation

Introduction

The following pages cover installation, maintenance, and system testing for the HP 9845B and HP 9845C Desktop Computers. Where similar, the computers are referred to as the "System 45" or the "9845". Any differences between computers or models are noted when necessary. The following table shows the configuration for the model numbers which are referred to.

	Monochromatic CRT (98750A)	Monochromatic CRT With Enhanced Graphics (98780A)	Color CRT (98770A)
Standard Processor	9845B Model 100	—	9845C Model 100
Enhanced Processor	—	9845B Model 200	9845C Model 200

There are other models which are based on the model numbers in the previous table. The 9845B Model 150, for instance, is a 9845B Model 100 with a thermal printer, two tape drives, graphics, and 187 K-bytes of read/write memory. For simplicity, this manual refers to Models 100 and 200 only. If you have a 9845B Model 150, just remember that your computer is referred to as the 9845B Model 100 in this manual.

Table Mounting

The System 45 mainframe can be attached to a table top by replacing each foot with an internally threaded device and bolting up through the table top. Bolting the main frame to a desk which has a lockable drawer secures the computer from theft. Care must be taken in laying out the bolt holes so that the front edge of the computer overhangs the edge of the table top. This ensures that the air filters can still be removed and cleaned.

The computer can be secured to the top of a table or desk in the following manner:

- Drill four holes in the top surface of a table to accommodate 5/16-24 NF-2A screws according to the following diagram.
- Replace the four rubber feet attached to the bottom of the computer with the four hexagonal spacers supplied with the Table Mounting Accessory (P/N 09845-61201), using the 6-19X.438 Pan Head, Pozidrive, Plastite screws, also supplied.
- Attach the computer to the table top, using four 5/16-24 NF-2A machine screws that are 3/8 inch longer than the thickness of the table top. The hexagonal spacers should be held with a wrench while these screws are tightened to prevent stripping the smaller screws out of the plastic base.
- The keyboard should extend 8.25 inches in front of the table top, as shown, to make the air filters accessible for periodic cleaning or replacement.

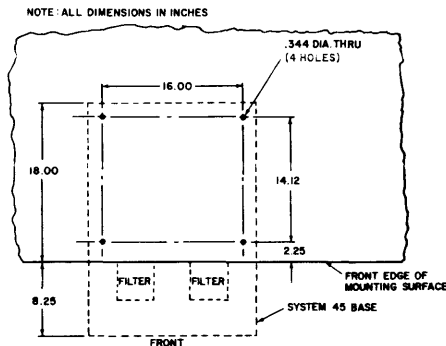

Installing the CRT

The System 45 comes equipped with a CRT (Cathode Ray Tube) display. The eight keys directly below the CRT screen on the 9845B Model 200 and the 9845C are called softkeys. The "CRT pull-out cards" (under the CRT) serve as a handy reference for operating the computer.

Installing the 9845B Model 100 CRT

Align the guides on the CRT assembly with the mainframe support legs, as shown here. Notice that the buttons on the bottom of the CRT assembly align with the notches in the support legs.

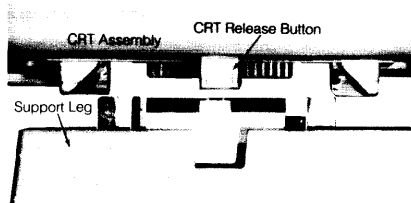
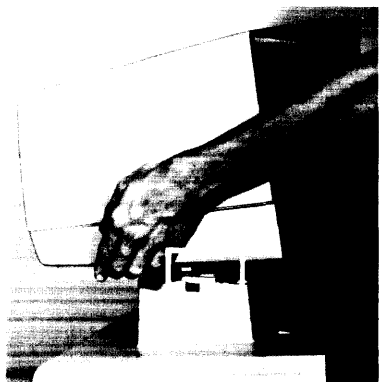

After careful alignment, allow the CRT to rest on the support legs.

To remove the CRT, press the CRT release buttons and pull up.

Installing the 9845B Model 200 CRT or the 9845C CRT

WARNING

THE 9845C COLOR DISPLAY (CRT) WEIGHS 29.5 KILOGRAMS (65 LBS.). TO AVOID PERSONAL INJURY OR DAMAGE TO THE EQUIPMENT, IT IS RECOMMENDED THAT THE COLOR DISPLAY ALWAYS BE LIFTED BY TWO PEOPLE.

Inspect the interconnect PC assemblies in both legs of the display, making certain that they are straight. Also check the metal tab guides on the support legs of the mainframe. They should be straight or bent slightly toward the PC board connector.

2-4 9845B/C Environmental, Installation, and Preventive Maintenance Requirements

The sliding lock handles¹ — on each leg of the display — should be pulled out (in the open position).

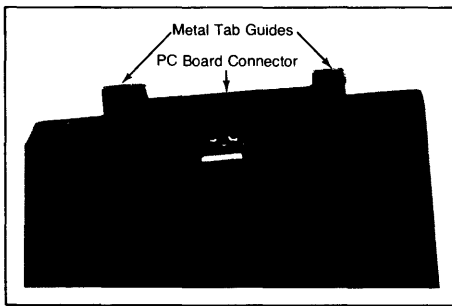
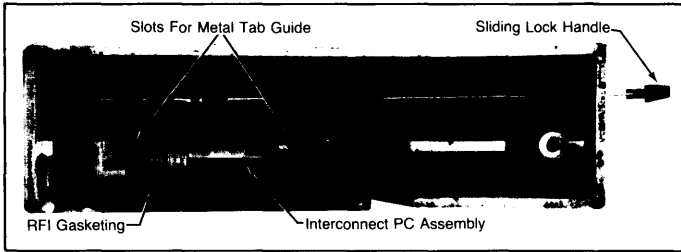

Working on one leg at a time, tilt the display slightly to the right and guide the right leg into place. Pull the display to the left toward the other leg, and position the left leg into place.

The back of both display legs should now be resting on the top cover of the mainframe. (If not, check both sliding lock handles — they should be pulled out.) There should be a gap (about $\frac{1}{4}$ inch) between the mainframe top cover and the front of the display legs. If the display does not appear to be sitting properly on the mainframe, repeat the previous step.

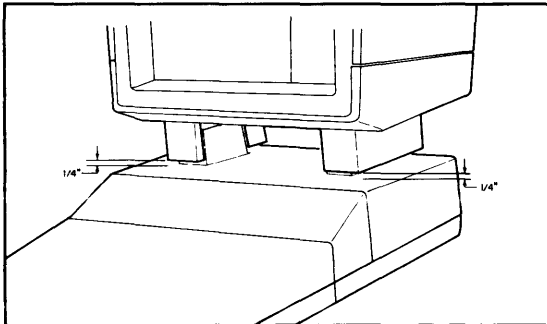

¹ Ignore the references to the sliding lock handles if the 9845C is not equipped with the sliding lock mechanism.

With the display sitting level, push down firmly on the top front of the display. This compresses the RFI gasketing and ensures proper contact with the mainframe.

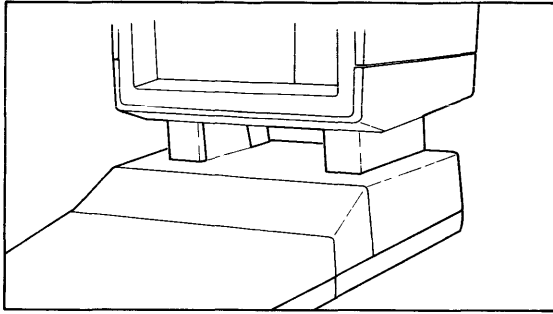

Now push the sliding lock handles in, to secure the CRT to the mainframe.

To remove the CRT, pull the sliding lock handles out and lift the CRT straight up. (Remember that two people are needed to lift the color display.)

CRT Intensity

Once the System 45 has been set up and is operating, CRT brightness is controlled by a small dial underneath the CRT. It is located on the right-hand side of the 9845B Model 100 and on the left-hand side of the 9845B Model 200 and the 9845C.

Note

Hewlett-Packard products which use Cathode Ray Tubes are designed to limit X-radiation levels to values of 0.5 mR/hour¹ or below at 5cm distance. This level has been established by the United States Bureau of Radiological Health and conforms to similar international requirements. All measurements are made using equipment that is VDE certified, and are conducted with the equipment operating under normal conditions as well as worst case maladjustment.

¹ mR/hour: Milli-Roentgen per hour

Functional Areas of the CRT

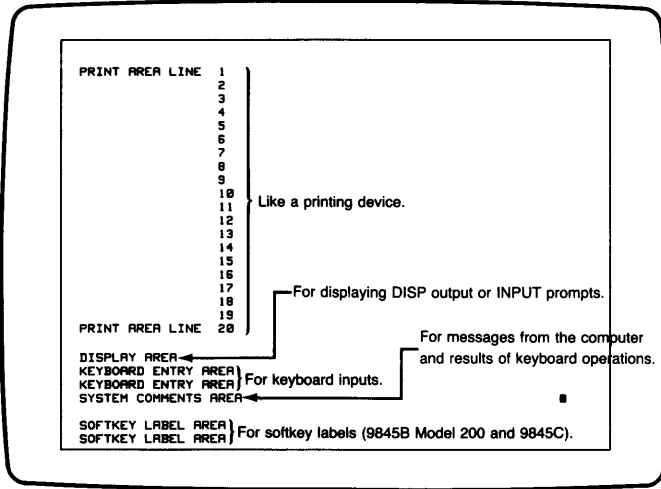

CAUTION

ALWAYS SWITCH OFF THE COMPUTER WHEN INSERTING OR REMOVING ROMS. FAILURE TO DO SO COULD DAMAGE THE EQUIPMENT.

ROMs Update List

Plug-in Option ROMs available for use with the 9845 are shown in the following table.

Option ROM Name	Option ROM Number	Amount of Read/Write Memory Used
Graphics (9845B Model 100 only)	HP 98411B or Opt. 311	90 bytes
Enhanced Graphics (9845B Model 200 and 9845C)	(standard)	264 bytes
I/O	HP 98412A or Opt. 312	640 bytes
Mass Storage	HP 98413B or Opt. 313	None
Advanced Programming	HP 98414A or Opt. 314	None
Structured Programming	HP 98415A	None
Basic Datacomm	HP 98417A	380bytes
Bisync Datacomm	HP 98418A	40 bytes
Assembly Execution	HP 98438A or Opt. 438	See the Assembly Execution ROM Manual
Assembly Execution and Development	HP 98439A or Opt. 439	See the Assembly Development ROM Manual
Data Base Management System	HP 98430A or Model 190, Opt. 330, 331, or 332 (Model 280 includes these ROMs also)	120 bytes

The Option ROM Drawers

The 9845 has two ROM drawers which contain the ROMs. They are located on each side of the machine at the base of the dark stripe.

The ROMs that belong in the left-hand drawer have green labels, and those that belong in the right-hand drawer have black labels. Since it is important that each ROM be inserted in the proper drawer, the drawers are designed to prevent inserting a ROM in the wrong drawer.

The labels on the drawers and the ROMs have symbols on them: a circle, square, or triangle. Use these symbols as a guide for matching ROMs to the appropriate slots.

- ○ ROMs can go in ○ or □ slots.
- □ ROMs must go in □ slots.
- Δ ROMs must go in Δ slots.

Installing and Removing ROMs

To insert a ROM:

- Slide the drawer all the way out and make sure the label color matches that of the ROM you want to insert.
- Open the clear plastic cover by squeezing the sides of the cover to gain access to the connectors.
- Orient the ROM so that the tops of the letters on the label are toward the computer.
- Make sure that the shape (○, □ or Δ) on the ROM corresponds to the shape for the slot.
- Insert the ROM vertically so that it goes all the way to the bottom of the connector. The small raised rib on the top of the drawer should fit into the recess on the bottom of the ROM. If it doesn't, make sure you have made the proper color, shape and orientation matches.
- When the ROM is inserted, snap the clear cover shut and close the drawer until it is flush with the outside cover of the computer.

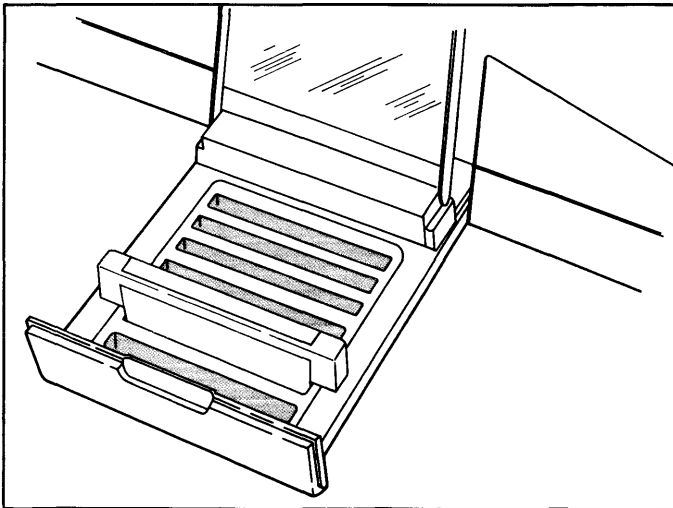

To remove a ROM:

- Turn the power switch off.
- Slide out and open the proper drawer.
- Gently pull the ROM straight up.
- Close the cover and slide the drawer in.

Connecting Interfaces

CAUTION

ALWAYS SWITCH OFF THE COMPUTER WHEN INSERTING OR REMOVING INTERFACES. FAILURE TO DO SO COULD DAMAGE THE EQUIPMENT.

Peripheral devices are connected to the 9845 computer with an interface. An interface can be inserted into any of the four I/O slots in the back of the computer, as shown.

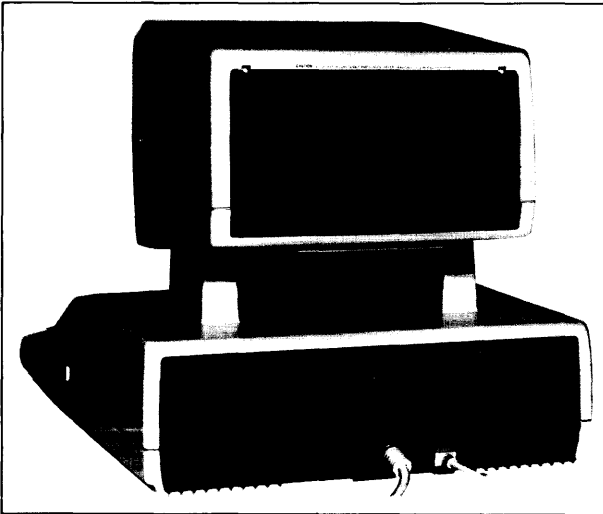

Interface Select Codes

A select code is set on each interface at the factory. To change the select code, use a small screwdriver to rotate the switch which is accessible through the top of the interface rear housing. Do not set two or more interfaces to the same select code number.

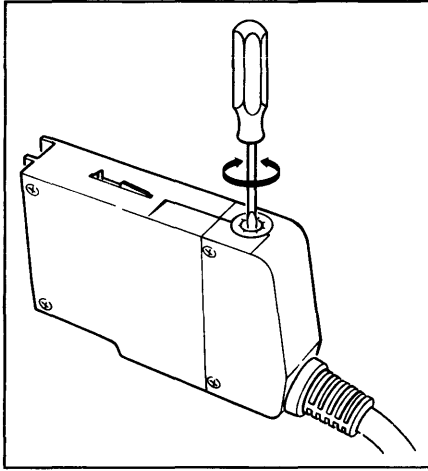

The following select codes are permanently reserved by the system and should not be set on any interface:

- 0 — Internal thermal printer and keyboard
- 13 — Graphics
- 14 — Left tape cartridge drive
- 15 — Right tape cartridge drive
- 16 — CRT

Checking Fuses, Voltage and Power Cords

Introduction

The 9845B has a power cord connector, a fuse, and a voltage selector switch located on the rear panel of the mainframe, as shown.

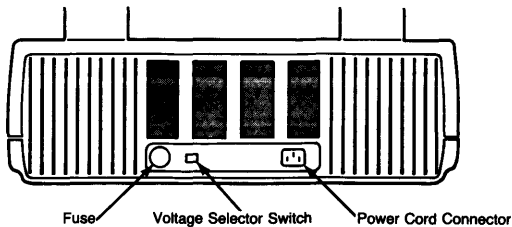

2-10 9845B/C Environmental, Installation, and Preventive Maintenance Requirements

The 9845C mainframe and CRT each has its own power cord connector and fuse. The mainframe has one voltage selector switch and the CRT has two. These are located on the rear panels of the CRT and mainframe, as shown.

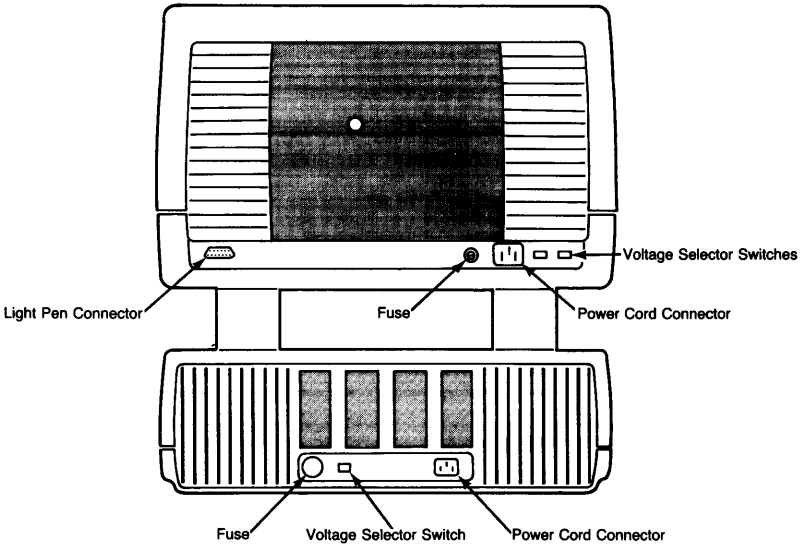

Fuses

WARNING

TO AVOID THE POSSIBILITY OF SERIOUS INJURY, DISCONNECT THE AC POWER CORD(S) BEFORE REMOVING OR INSTALLING A FUSE.

A different fuse is required for each of the two voltage ranges of 120 Vac and 240 Vac. The proper types and ratings are shown in this table.

Voltage Rating	Fuse Rating	Part Number
100,120	10 NB	2110-0051
220,240	6 NB	2110-0056

Always be sure that the correct fuse is installed. Failure to do so may result in damage to the computer. When changing a fuse, make sure that the replacement is the proper rating and type.

The previous drawings show the location of the fuse(s) on the System 45. (The 9845B has one fuse, the 9845C has two fuses.) To change a fuse, first disconnect the power cord(s) from the computer.

Voltage

WARNING

ALWAYS DISCONNECT THE COMPUTER FROM ANY AC POWER SOURCE BEFORE SETTING A VOLTAGE SELECTOR SWITCH.

The 9845B voltage selector switch is located on the rear panel of the mainframe. The 9845C switches are located on the rear panels of the computer and CRT. To alter the setting of a switch, slide the switch so that the position of the slot corresponds to the correct voltage, as previously shown.

CAUTION

CHECK THE SELECTOR SWITCH SETTING BEFORE APPLYING POWER. DAMAGE TO THE COMPUTER WILL OCCUR IF A SELECTOR SWITCH IS SET TO 110 VOLTS AC AND 220 VOLTS AC IS APPLIED TO THE POWER INPUT CONNECTOR.

Next, ensure that the voltage selector switch (three switches on the 9845C) is set for the nominal line voltage, as shown here.

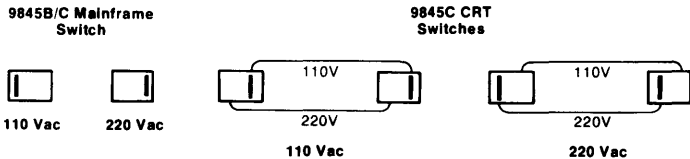

Power Cords

WARNING

IF IT IS NECESSARY TO REPLACE A POWER CORD, THE REPLACEMENT CORD MUST HAVE THE SAME POLARITY AS THE ORIGINAL. OTHERWISE A SAFETY HAZARD FROM ELECTRICAL SHOCK TO PERSONNEL, WHICH COULD RESULT IN INJURY OR DEATH, MIGHT EXIST. IN ADDITION, THE EQUIPMENT COULD BE SEVERELY DAMAGED IF EVEN A RELATIVELY MINOR INTERNAL FAILURE OCCURRED.

The 9845B has one power cord, and the 9845C has two (one for the mainframe, one for the CRT). Power cords with different plugs are available for the 9845. The cord(s) packaged with each computer depends upon where that computer is to be delivered.

Power cords supplied by HP have polarities matched to the power-input socket on the computer:

- L = Line or Active Conductor (also called "live" or "hot")
- N = Neutral or Identified Conductor
- E = Earth or Safety Ground



2-12 9845B/C Environmental, Installation, and Preventive Maintenance Requirements

Power cords with different plugs are available for the equipment; the part number of each cord is shown below. Each plug has a ground connector. The cord packaged with the equipment depends upon where the equipment is to be delivered.

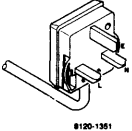
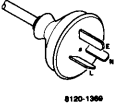
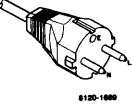
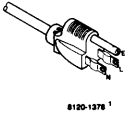
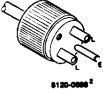
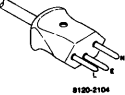
		<u>Option Number</u>
 8120-1351	HP Part Number 8120-1351; 250V, 13A, 1 ϕ plug rating. (Furnished for use in Great Britain, Cyprus, Nigeria, Rhodesia, Singapore)	900
 8120-1369	HP Part Number 8120-1369; 250V, 10A, 1 ϕ plug rating. (For use in Australia, New Zealand)	901
 8120-1689	HP Part Number 8120-1689; 250V, 10 / 16A, 1 ϕ plug rating. (Furnished for use in East and West Europe, Saudi Arabia, Egypt)	902
 8120-1378 ¹	HP Part Number 8120-1378; 125V, 15A, 1 ϕ plug rating (UL approved; for use in United States, Canada, Japan, Mexico, Philippines, Taiwan)	903
 8120-0698 ²	HP Part Number 8120-0698; 250V, 15A 1 ϕ plug rating. (For use in United States)	904
 8120-2104	HP Part Number 8120-2104; 250V, 10A, 1 ϕ plug rating. (For use in Switzerland)	906

Grounding Requirements

To protect operating personnel, the National Electrical Manufacturer's Association (NEMA) recommends that all equipment be properly grounded. HP 9845 systems are equipped with three-conductor power cables which, when connected to an appropriate power receptacle, ground the computer. To preserve this protection feature, do not operate the computer from an AC power outlet which has no ground connection.

¹UL and CSA approved for use in the United States of America and Canada with equipment set for either 100 or 120 Vac operation.

²UL and CSA approved for use in the United States of America and Canada with equipment set for either 200 or 240 Vac operation.

FCC Radio Frequency Interference Statement

**FEDERAL COMMUNICATIONS COMMISSION
RADIO FREQUENCY INTERFERENCE
STATEMENT (U.S.A. ONLY)**

The Federal Communications Commission (in Subpart J of Part 15, Docket 20780) has specified that the following notice be brought to the attention of the users of this product.

Warning: This equipment generates, uses, and can radiate radio frequency energy and if not installed and used in accordance with the instructions manual, may cause interference to radio communications. As temporarily permitted by regulation it has not been tested for compliance with the limits for a Class A computing device pursuant to Subpart J of Part 15 of FCC Rules, which are designed to provide reasonable protection against such interference. Operation of this equipment in a residential area is likely to cause interference in which case the user at his own expense will be required to take whatever measures may be required to correct the interference.

Initiating Power

Once the computer is set up properly, it is ready to turn on. Before you do, here are some things to check:

- Is the proper type of fuse installed?
- Is the proper voltage set?
- Are the ROMs installed?
- Are the interfaces and peripherals connected?

Next connect the power cord (two on the 9845C) to the power input connector on the rear panel of the mainframe (and CRT — 9845C). Plug the other end of the cord into an AC power outlet.

CAUTION

SHOULD A SINGLE, BRIGHT, HORIZONTAL LINE APPEAR
ACROSS THE CENTER OF THE CRT, IMMEDIATELY SWITCH
THE COMPUTER OFF TO AVOID DAMAGE.

Now that the system is set up, set the power switch on the right side of the machine to the "1" position to turn it on.

Set the CRT intensity using the knob under the front of the CRT.

Loading Printer Paper

The internal printer is an 80-character line printer used for hardcopy output. Refer to the section entitled "Accessories Supplied" for part numbers of the types of paper.

CAUTION

HP SUPPLIED THERMAL PAPER IS FORMULATED SPECIFICALLY TO WORK WITH THE SYSTEM 45 INTERNAL PRINTER. THERMAL PAPER FROM OTHER SOURCES MAY OR MAY NOT WORK WITH THE INTERNAL PRINTER AND, THEREFORE, HP IS NOT RESPONSIBLE FOR DAMAGES CAUSED BY USING NON-HP PAPER.

2-14 9845B/C Environmental, Installation, and Preventive Maintenance Requirements

The average life of the internal thermal printhead is about 50,000 feet of paper, or about 250 rolls.

Note

If you want to use Metric paper in the thermal printer, the Metric Paper Spacer (P/N 5040-8145) must be installed in the paper holder, on the right-hand side.

Two keys are used to control the printer paper. The PAPER ADVANCE key advances the paper until the key is released. The TOP OF FORM key advances the paper past perforations to the top margin (approximately 1.25 cm, or ½ inch, below the perforations). If the paper is not perforated, it is advanced 30.5 cm (12 inches).

Printer paper is loaded using the following procedure.

- Make sure the computer is switched ON.
- Lift or remove the access cover on the top of the printer by pushing down on the raised surface at the rear of the door. The door can be removed by lifting up and pulling it toward you.
- Remove and discard the paper core of any previous roll. If the remaining roll of paper is small and a new roll is to be installed, remove the old roll. To do this, first unroll and lift the old roll upward. Then tear the paper off using the paper guide.
- If any paper remains in the printer mechanism, remove it by pressing the PAPER ADVANCE key until the paper is completely out.
- Remove the first layer of paper from the new roll. Be sure the paper has a cleanly torn or cut edge. Fold the corners in to form a point.
- Insert the new roll such that the free end is positioned as shown. Press the PAPER ADVANCE key until the paper appears at the front of the printer. Then reinstall the access door by placing it on the hinge pins and pushing until it snaps into place.

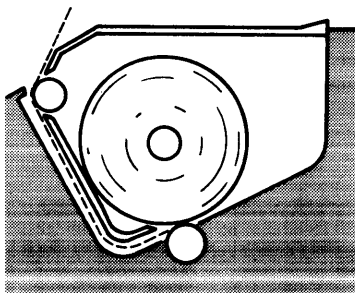

Inserting and Removing the Tape Cartridge

Insert the tape cartridge so that its label is up and the open edge is toward the computer, as shown below. Both the drive window and the door beneath it open when a cartridge presses on the lower door. The cartridge can then be inserted.

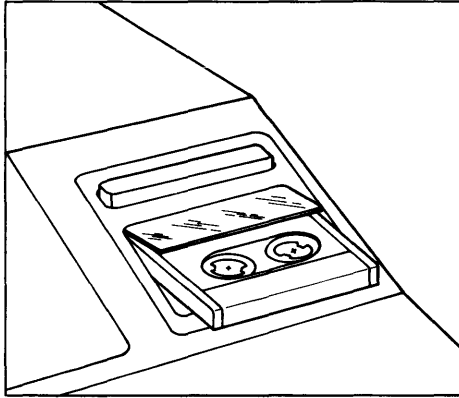

To remove the tape cartridge, press the eject bar. If it is pulled out without pressing the eject bar, another cartridge cannot be inserted until the eject bar is pressed. Do not remove the tape or execute reset while it is moving; damage to the tape may result.

9845B/C Mainframe Verification

9845B/C System Exerciser

The programs on the System Exerciser Cartridges (HP P/N 09845-92041 Revision C and 09845-92042 Revision A) are designed to assure you that the System 45 is operating properly, and if it is not, to identify problem areas which may exist. Some exercisers require that you compare what is displayed or printed to what is described in this manual. All of the exercisers display error messages when errors are detected.

If any exerciser should fail, please note the error and refer to Section 4, Troubleshooting.

The exercisers are divided into three types: internal mainframe, peripheral, and interface. The internal mainframe exercisers should be run first to exercise the System 45 mainframe thoroughly before running any of the external peripheral or interface exercisers. Refer to the appropriate chapter of this handbook for interface and peripheral exercisers.

9845B/C Turn-On Self Test

When the 9845 is turned on, a self test occurs. The processors go through a test routine, if successful, the 9845 will beep at least once. The numbers of beeps isn't important. The processors also check to see the type of CRT they'll send display data to, and determine which processor is PPU/LPU. A CRT must be attached for this processor ID routine to finish, if none is connected, the processors hang up, the 9845 appears dead.

Next, RWM is tested to ensure at least 16K bytes exists in block 0, and tests graphics RWM if graphics is installed. The graphics raster may be seen flashing different patterns during the graphics RWM test, followed by "MEMORY TEST IN PROGRESS" on the display. Normally, the CRT circuits may not be warmed up enough for the graphics RWM tests to be seen. Should errors be trapped during the RWM tests, the CRT should display "PART OF MEMORY FAILED SELF-TEST". The amount of RWM that's lost can be determined by executing LIST and comparing available RWM with the amount of RWM the 9845 should have.

When the turn-on tests are successfully completed, the display should read: "9845 READY FOR USE". If AUTOST had been latched, and a tape inserted in T15, the tape should rewind and load the AUTOST program and run it.

Refer to the 9845B/C Mainframe Troubleshooting, Section 4, if this test has errors or fails.

Exerciser Starting Procedure

Before starting, use the following checklist to ensure that the 9845B/C is ready for testing.

- Switch power off.
- On the back panel, check to ensure that the line voltage selector switches are set, and that the correct fuse(s) is (are) installed.
- Verify that the ROMs and interfaces are properly installed.

Latch the AUTOST key on the computer. Begin by inserting System Exerciser Cartridge #1 in the right-hand tape drive so that the cartridge label faces up and out. Switch on power to the System 45, and the computer should load and run the supervisory exerciser program. If this does not happen, or if a blinking cursor does not appear on the CRT within about 20 seconds after turn-on and cannot be obtained by pressing CONTROL STOP, refer to Section 4, Troubleshooting.

The supervisory exerciser program can also be loaded by typing LOAD "AUTOST:T15" and pressing EXECUTE.

When the supervisory exerciser program begins to run, the following information is displayed:

```
9845B/C SYSTEM EXERCISER Do you want PRINTED outPut (Y,N)?
```

Answer Y for yes or N for no, and press CONT. If you want the printout to appear on the CRT, answer no. If you answer yes, you are asked to:

```
Please enter the PRINTER select code...
```

For non-HP-IB printers, enter the interface select code. (Enter 0 for the internal printer.)

If you have an HP-IB printer, answer with the select code and the device address entered together as a three or four digit number. The interface select code can be a one or two digit number which represents a valid select code. The device address must be a two digit number. For example, a 9871A Printer (HP-IB option only) connected on interface 7 with its address set to 6 is entered as "706". (Secondary addressing of HP-IB devices is not allowed.)

The choices of exercisers for System Exerciser Cartridge #1 are then printed on the specified printer (or the CRT).

An asterisk (*) appearing before any of the MAINFRAME exercisers shows that that particular option is not installed.

Use the same procedure to run the exercisers on System Exerciser Cartridge #2.

Now select and run exerciser(s) as explained on the following pages.

9845B/C Mainframe Exercisers

Selecting an Exerciser

There are three exercisers that you should run to exercise your System 45 Mainframe.

- The memory (MEMORY) exerciser performs a checksum on the System 45 ROMs and also checks the read/write memory.
- The tape (TAPE) exerciser checks the tape drive(s) on the System 45. It first exercises the right-hand tape drive, and then the left-hand tape drive (if it is present).
- The printer (PRNTR) exerciser checks the operation of the thermal printer (if it is installed).

The ROM revision (ROMREV) exerciser (located on System Exerciser Cartridge #2) determines the components (processor, CRT, and ROMs) that comprise your System 45. You do not need to run it unless you want to know exactly what the internal system includes.

If you have decided that you want to run only one of the mainframe exercisers, type its name and press CONT.

It is possible to enter up to eight exercisers, to be run one after another, as long as they are all located on the exerciser cartridge. The exercisers are run starting with the first one in the list. Each exerciser name is separated from the next with the divide (/) symbol, as shown here:

```
PRNTR/TAPE/DISPLA,ADJ/9B72A,701/9B035A,5
or ROMREV/9111A,706
```

Entering COMP as the exerciser results in four (DISPLA, TAPE, PRNTR, and GRPHC, CLRGR, or ENHGR) of the exercisers being run.

Once you have entered the exerciser name(s) and pressed CONT, you are asked to enter the number of times you want each exerciser to be run. The maximum number of repetitions is 25. However, the MEMORY exerciser cannot be run more than once at a time. Before you enter the number of times the exerciser(s) should be run and press CONT, refer to the appropriate parts of this chapter for more detailed information about each exerciser.

Each exerciser should run as described in this chapter. If any exerciser does not run properly, note the error and refer to the Diagnostics, Section 5.

After any exerciser has completed its operation, the following message is displayed:

```
_ message(s), # runs = _, Press CONT
```

This tells you the total number of errors which occurred during the total number of exerciser repetitions.

Note

Except for MEMORY and the graphics memory tests, you can stop an exerciser at any time for careful examination of the display by pressing PAUSE. A program line will also appear on the screen. Press CONT to complete the exerciser.

Memory Exerciser (MEMORY)

Due to the comprehensive nature of the MEMORY exerciser, the following special circumstances exist:

- There is no printed output available. Test results are displayed on the CRT.
- Multiple repetitions of the MEMORY exerciser are not allowed.
- When you wish to run the MEMORY exerciser, it must be the only exerciser selected.

Pressing any keys on the keyboard while the MEMORY exerciser is running may cause an error. Error messages are displayed if errors occur. If you want to stop the exerciser while it is running, press the STOP key.

The exerciser begins by displaying a blinking:

```
ROM CHECKSUM TEST RUNNING
```

A ROM checksum failure is indicated by the message:

```
ROM CHECKSUM FAILURE BLK X ADDRESS XXXXXX-XXXXXX
```

Refer to Section 4, Troubleshooting to interpret messages. If this message is displayed, press CONT to continue the exerciser. The memory check is run next while the CRT displays a blinking:

```
R/W MEMORY EXERCISER RUNNING
```

During the memory check, the CRT displays various characters and lines on its print area. This is normal.

A read/write memory failure is indicated by the message:

```
MEMORY ERROR BLK X ADDRESS XXXXXX HAS XXXXXX NOT XXXXXX
```

Note

The display may have a variety of patterns on it for a short period of time during the MEMORY exerciser. This is normal.

A message is displayed when the exerciser has completed.

Tape Exerciser (TAPE)

In order to run this exerciser, the system exerciser cartridge in the right-hand tape drive must be unprotected (tab slid to the right). If you want to exercise the left tape drive, an unprotected tape cartridge (which has been initialized) must be installed in it.

Note

If files named DATA1, DATA2, DATA3, DATA4, or DATA5 exist on the tape which you insert in the left tape drive, they will be purged by this exerciser.

It is suggested that you set the print all mode by pressing and latching the PRT ALL key. This enables you to see every message which is displayed. When the exerciser has completed, press and unlatch the PRT ALL key to turn off the print all mode.

The tape exerciser begins by prompting you with these messages:

```
CREATING FILE DATA1
CREATING FILE DATA2
CREATING FILE DATA3
CREATING FILE DATA4
CREATING FILE DATA5
ASSIGNING & FILLING FILE DATA1
ASSIGNING & FILLING FILE DATA2
ASSIGNING & FILLING FILE DATA3
ASSIGNING & FILLING FILE DATA4
ASSIGNING & FILLING FILE DATA5
```

followed by various read and write messages.

When the right-hand tape drive (T15) test is finished, this message is displayed:

```
TAPE VERIFY DONE :T15
```

Then the exerciser checks for the presence of the left tape drive (T14). If it is present, the exerciser is re-executed for T14. If it is not present, the exerciser continues normal operation. If your System 45 has a left tape drive, but a tape cartridge is not installed in it, the following message is displayed (or printed):

```
TAPE CARTRIDGE OUT :T14-EXERCISER NOT RUN
```

ROM Revision Exerciser (ROMREV)

The ROM revision exerciser gives you a report similar to this one:

Rom Revision and Compatibility
Rev. A 1/7/81

Addr;Block	ROM Name	Revision					Part Number	PROBLEMS??
00K;3	SYS Fast LPU	Rev. A			*	*	1818-1506/02	
20K;3	SYS Fast LPU	Rev. A			*	*	1818-1507/03	
40K;3	SYS Fast LPU	Rev. A			*	*	1818-1508/04	
60K;3	SYS Fast LPU	Rev. A			*	*	1818-1509/05	
00K;5	TOPS PPU	Rev. A		*	*	*	1818-1592/91	
20K;5	KBD PPU AMER	Rev. C	*	*	*	*	1818-0832/36	
40K;5	SYSTEM PPU	Rev. D	*	*	*	*	1818-0833/37	
60K;5	SYSTEM PPU	Rev. D	*	*	*	*	1818-0834/38	
20K;7	GRAPHICS	Rev. A	*	*	*	*	98780-65501	

To check for problems, first find your particular machine configuration at the top of the report (9845B (Fast LPU) Fast Black & White, for instance). Then check that column to see if it is filled with asterisks (*'s). If one or more are missing, or if there are any messages under "PROBLEMS??", refer to the troubleshooting section.

Note

If your report shows the message "Unknown ROM!", you may or may not have a problem. It is possible that one of the ROMs in your machine is so new that this exerciser does not recognize it.

9845B/C Operating Basics

Here is a step-by-step guide to the basic operation of the System 45 (if you have already set up and tested the computer as described in the preceding pages). Simple arithmetic operations, and storing, loading, running, and listing a program are covered in this section.



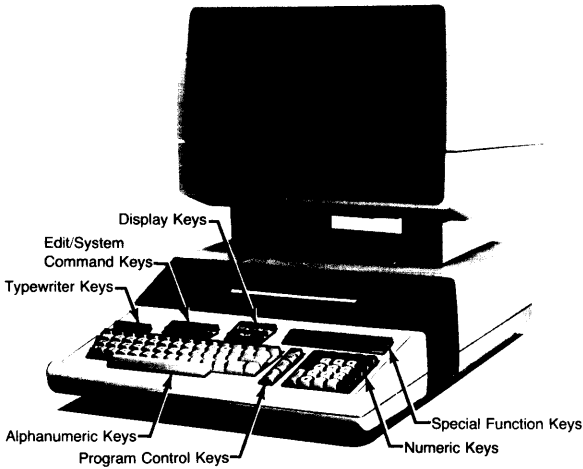

CAUTION

OPERATING THE COMPUTER BEFORE IT IS PROPERLY SET UP COULD DAMAGE IT, SO IF THE COMPUTER IS NOT ALREADY INSTALLED AND READY TO USE, READ THE PROCEDURES IN THE PRECEDING PAGES FIRST.

System 45



Basic Keyboard Operations

If you make a typing error in a line, use the  and  **display keys** to move the cursor until it is under the character you wish to change. Then type the correct character in its place. Use the  and  **display keys** to move to another line that you wish to change.

Executing Computations

To do simple arithmetic, use the **numeric** section of the keyboard. First, try converting some Fahrenheit temperatures to Celsius temperatures. The formula to use is $(F-32)*(5/9)$. Type the following to convert 54°F:

$(54-32)*(5/9)$ 

In general, spaces are not important, so you get the same answer if you type:

$(54 - 32) * (5 / 9)$ 

By pressing the RESULT key, the answer to the previous calculation can be used as part of another calculation. Use it to convert the 12.22°C answer back to its Fahrenheit value. Type this calculation, pressing the RESULT key for the RES function:

$(RES*9/5)+32$ 



Simultaneous Computations

Two or more computations can be entered and solved at the same time by separating each with either a semicolon (for close spacing of the results) or a comma (for 20-character fields). These calculations which convert 212°F to Celsius degrees and 100°C to Fahrenheit degrees:

$(212-32)*(5/9);(100*9/5)+32$ 

Using Variables at the Keyboard

Variables can be assigned values using an equals sign to create an assignment statement. For example, to assign 45 to F_lowtemp and 80 to F_hightemp, enter:

F_lowtemp=45 
F_hightemp=80 

Now that some variables have assigned values, they can be used in place of numbers in math calculations. Type the following:

$F_average_temp=(F_hightemp+F_lowtemp)/2$ 

Assignment statements and calculations such as these can be put together in a logical sequence to form a program. Here is an example. Press the STORE key after typing each line.

```
10 PRINTER IS 16
20 Ftemp=155
30 Ctemp=(Ftemp-32)*(5/9)
40 PRINT Ftemp;Ctemp
50 END
```

Run the program by pressing .

Mass Storage

Now you should store this program on a tape cartridge so that you can run it again at a later date.

To record on a tape cartridge, the record tab must be in the rightmost position, in the direction of the arrow (as shown):

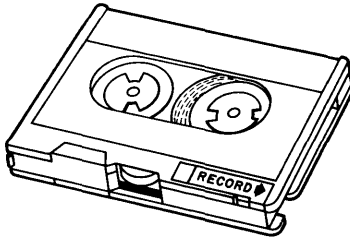

The left tape drive is referred to as :T14 and the right-hand one is :T15. Insert a tape cartridge into the right-hand tape drive, type `CAT " : T15 "` and press EXECUTE. You should see a listing of the files that are stored on that tape cartridge.

If the display shows error 85, then the tape has not been used yet. Before you can use a tape cartridge for storing programs or data, it must be initialized. Type `INITIALIZE " : T15 "` and press EXECUTE. The initialization procedure takes approximately three minutes to complete.

After the tape has been initialized and is unprotected (tab slid to the right), you can store the program (above) on it. Type the following:

```
STORE "TEMP:T15" EXECUTE
```

Now you can edit "TEMP" so that the message is printed on the computer's thermal printer instead of on the CRT. (If your machine does not have the printer option, you should not edit your program.) First, press the EDIT **special function key**, type the number 10, and press EXECUTE.

Using the ← display key, move the cursor over until it is under the "1" in 16. Change that 16 to a zero by pressing the "0" key and the space bar. Store this new line by pressing the STORE key.

Your program should now look like this:

```
10 PRINTER IS 0
20 Ftemp=155
30 Ctemp=(Ftemp-32)*(5/9)
40 PRINT Ftemp;"DEGREES FAHRENHEIT =" ;Ctemp;"DEGREES CELSIUS."
50 END
```

You can change the temperature to be converted by changing the value in line 20 and pressing STORE.

Your "new" program can also be stored on the tape cartridge. Press the STOP key and then type the following:

```
STORE "TEMP2:T15" EXECUTE
```

Run the "TEMP2" program by pressing RUN. A message similar to this one should be printed on the thermal printer:

```
155 DEGREES FAHRENHEIT = 68.3333333334 DEGREES CELSIUS.
```

If you would like to see the first program "TEMP" again, you can load it back into the machine's memory from the tape cartridge by typing:

```
LOAD "TEMP:T15" EXECUTE
```

The program can be listed:

- on the CRT by typing LIST#16 and pressing EXECUTE
- on the thermal printer by typing LIST#0 and pressing EXECUTE

To see what is stored on your tape cartridge. The names TEMP and TEMP2 should be shown.

Automatic Start for Programs

You can take advantage of the computer's automatic start capability by naming a program "AUTOST".

If a tape cartridge with a file named "AUTOST" is present in the right-hand tape drive and the AUTOST key is latched when you turn the machine on, the computer automatically loads and runs the "AUTOST" program.

9845B/C Mainframe Preventive Maintenance

There is no scheduled preventive maintenance for the 9845B/C computer.

However, care of the air filters and tape read/write heads is explained in the Installation, Operation, and Test Manual.

9845B/C Configuration

Chapter

3

9845B/C Mainframe Configuration

Configurations of the 9845B/C mainframe and CRT are shown in the following table. Additional and more specific information regarding internal hardware requirements to support peripherals is listed in Section 7, Supported Peripherals.

System Configurations

Product No.	Description
9845B (Opt. 100)	MINIMUM SYSTEM <ul style="list-style-type: none"> • 56 266 bytes r/w memory • Standard Language Processor • Standard monochromatic CRT • Tape Cartridge Drive • Keyboard option MUST be ordered
9845B (Opt. 150)	STANDARD SYSTEM <ul style="list-style-type: none"> • 187 146 bytes r/w memory (Opt. 204) • Standard Language Processor • Standard monochromatic CRT • Graphics pkg. (Graphics ROM Opt. 311 and display subsystem Opt. 700) • Second tape cartridge drive (Opt. 600) • Thermal printer (Opt. 040 or 041, 060 or 061) • Keyboard and printer options MUST be ordered
9845B (Opt. 190)	EXPANDED SYSTEM <ul style="list-style-type: none"> • 448 906 bytes r/w memory (Opt. 206) • Standard Language Processor • Standard monochromatic CRT • Graphics pkg. (Graphics ROM Opt. 311 and display subsystem Opt. 700) • Second tape cartridge drive (Opt. 600) • Thermal printer (Opt. 040 or 041, 060 or 061) • I/O ROM (Opt. 312) • Mass Storage ROM (Opt. 313) • Advanced Programming ROM (Opt. 314) • Structured Programming ROM (98415A) • Basic Datacomm ROM (98417A) • Datacomm Interface (98046B) • Terminal Emulator software • Data Base Mgmt. System (98330A)‡ • Keyboard and printer options MUST be ordered
9845B (Opt. 200)	MINIMUM SYSTEM <ul style="list-style-type: none"> • 56 266 bytes r/w memory • Fast Language Processor • High-performance monochromatic CRT • Graphics package (Enhanced Graphics ROM and display subsystem) • Tape cartridge drive • Keyboard option MUST be ordered
9845B (Opt. 250)	STANDARD SYSTEM <ul style="list-style-type: none"> • 187 146 bytes r/w memory (Opt. 204) • Fast Language Processor • High-performance monochromatic CRT • Graphics package (Enhanced Graphics ROM and display subsystem) • Light pen (Opt. 775) • Second tape cartridge drive (Opt. 600) • Thermal printer (Opt. 040 or 041, 060 or 061)
9845B (Opt. 270)	GRAPHICS SYSTEM <ul style="list-style-type: none"> • 318 026 bytes read/write memory (Opt. 205) • Fast Language Processor • Enhanced display (98780A) • Enhanced Graphics ROM • CRT Graphics hardware • Light pen (Opt. 775) • Thermal printer (Opt. 040 or 041, 060 or 061) • Second tape drive (Opt. 600)

Product No.	Description
	<ul style="list-style-type: none"> • I/O ROM (Opt. 312) • Mass Storage ROM (Opt. 313) • Advanced Programming ROM (Opt. 314) • Structured Programming ROM (98415A) • Graphics Utility software • Keyboard and printer options MUST be ordered
9845B (Opt. 290)	EXPANDED SYSTEM <ul style="list-style-type: none"> • 448 906 bytes r/w memory (Opt. 206) • Fast Language Processor • High performance monochromatic CRT • Graphics Package • Light pen (Opt. 775) • Second tape cartridge drive (Opt. 600) • Thermal printer (Opt. 040 or 041, 060 or 061) • I/O ROM (Opt. 312) • Mass Storage ROM (Opt. 313) • Advanced Programming ROM (Opt. 314) • Structured Programming (98415A) • Basic Datacomm ROM (98417A) • Datacomm Interface (98046B) • Terminal Emulator software • Data Base Management System (98330A)‡ • Keyboard and printer options MUST be ordered
9845C (Opt. 100)	MINIMUM SYSTEM <ul style="list-style-type: none"> • 56 060 bytes r/w memory • Standard Language Processor • Color graphics package • Tape cartridge drive • Keyboard option MUST be ordered
9845C (Opt. 150)	STANDARD SYSTEM <ul style="list-style-type: none"> • 186 940 bytes read/write memory (Opt. 204) • Standard Language Processor • Color Graphics package • Light Pen (Opt. 775) • Second tape cartridge drive (Opt. 600) • Thermal printer (Opt. 040 or 041, 060 or 061) • Keyboard and printer options MUST be ordered
9845C (Opt. 190)	EXPANDED SYSTEM <ul style="list-style-type: none"> • 448 700 bytes r/w memory (Opt. 206) • Standard Language Processor • Color graphics package • Light pen (Opt. 775) • Second tape cartridge drive (Opt. 600) • Thermal printer (Opt. 040 or 041, 060 or 061) • I/O ROM (Opt. 312) • Mass Storage ROM (Opt. 313) • Advanced Programming ROM (Opt. 314) • Structured Programming ROM (98415A) • Basic Datacomm ROM (98417A) • Datacomm Interface (98046B) • Terminal Emulator software • Data Base Management System (98430A)‡ • Keyboard and printer options MUST be ordered

3-2 9845B/C Configuration

Product No.	Description
9845C (Opt. 200)	MINIMUM SYSTEM <ul style="list-style-type: none"> • 56 060 bytes r/w memory • Fast Language Processor • Color graphics package • Tape cartridge drive • Keyboard option MUST be ordered
9845C (Opt. 250)	STANDARD SYSTEM <ul style="list-style-type: none"> • 186 940 bytes r/w memory (Opt. 204) • Fast Language Processor • Color graphics package • Light Pen (Opt. 775) • Second tape cartridge drive (Opt. 600) • Thermal printer (Opt. 040 or 041, 060 or 061) • Keyboard and printer options MUST be ordered
9845C (Opt. 270)	GRAPHICS SYSTEM <ul style="list-style-type: none"> • 317 820 bytes r/w memory (Opt. 205) • Fast Language Processor • Light pen (Opt. 775) • Thermal printer (Opt. 040 or 041, 060 or 061) • Second tape cartridge drive (Opt. 600) • I/O ROM (Opt. 312) • Mass Storage ROM (Opt. 313) • Advanced Programming ROM (Opt. 314) • Structured Programming ROM (98415A) • Graphics Utility software • Keyboard and printer options MUST be ordered
9845C (Opt. 290)	EXPANDED SYSTEMS <ul style="list-style-type: none"> • 448 700 bytes r/w memory (Opt. 206) • Fast Language Processor • Color graphics package • Light pen (Opt. 775) • Second tape cartridge drive (Opt. 600) • Thermal printer (Opt. 040 or 041, 060 or 061) • I/O ROM (Opt. 312) • Mass Storage ROM (Opt. 313) • Advanced Programming ROM (opt. 314) • Structured Programming ROM (98415A) • Basic Datacomm ROM (98417A) • Datacomm Interface (98046B) • Terminal Emulator software • Data Base Management System (98330A)† • Keyboard and printer options MUST be ordered

3-4 9845B/C Configuration

9845B/C Mainframe Troubleshooting

Chapter

4

Troubleshooting Checklist

Here's a list of checkpoints when your 9845 doesn't seem to work at all or correctly. Several items are identified and their respective reference page in the 9845B/C Mainframe Handbook is shown.

Checkpoint	Page
Power source	
Correct Voltage	2-1
Correct Frequency	2-1
Ample Power Available	2-1
Proper Receptacle Contact	2-12
Proper Grounding	2-12
Noise/Interference Free	2-13
Power Cord;	
Correct Connector Polarity	2-12
Wiring Continuity	2-11
Plugged In, Receptacle and 9845	2-10
Mainframe Configuration;	
Power Selector Switches,	2-11
Correct for Line Voltage	2-11
AC Line Switch at "1" Position	2-13
Fuse,	
Correct Size, Rating and Type	2-10
Power Supply,	
Proper Assembly for Option 1XX or 2XX	9-7
Output Voltage Within Specifications	9-7
Correct LED Indications on Opt. 2XX A81	9-7
Processors,	
Correct revision for application.	9-8
Memory,	
System ROM-	
Correct Revisions of ROM Chips for Application	7-2
Proper Type for CRT used	9-2
Correct Type for Keyboard Language	7-3
Proper Type for Processor	
OptionROM-	
Proper Type for Application	7-2
Correct Revision for Application	
Installed in Correct Location	2-7
Drawers Properly Seated/Installed	2-7
Standard RWM-	
Correct Assemblies for Opt. 1XX or 2XX	9-9
Option RWM-	
Block Jumpers In Correct Position	9-9
Sufficient Optional RWM for Application	3-3
Keyboard-	
Correct ROM Chip In A27 for Language	7-3
Ribbon Cables Connected	

4-2 9845B/C Mainframe Troubleshooting

Checkpoint	Page
Tape-	
Ribbon Cables Connected	
Good Fuse on A61	
Clean Read/Write Head	
Data Cartridge Not Damaged	
Tape Free of Wrinkles	
Sense Lamps Turned On	
Printer-	
Proper Paper Installed	2-14
Paper Correctly Installed	2-14
Spacer Used if Metric Paper Installed	2-14
Print Head Assembly Compatible with A55 or A52 Assembly	7-3
Correct Print Head Alignment	6-1
Interfacing-	
Good Fuses on A2	
Correct Select Code	2-9
General Situations;	
Wiring,	
Ground Wires Properly Connected	
Ribbon Cables Correctly Installed	
Insulation Intact	
Tight Connections On Terminal Boards and Spade Lugs	
PC Assemblies,	
Edge Connectors Clean	
Fully Seated in Motherboard	
Cooling,	
Air Filters Clean	
Fans Turning/Drawing Air	
Cleanliness,	
All Areas Free of Dust, Corrosion, and Contamination	
Software,	
Program Compatible With Configuration	3-3

Troubleshooting Tables

This table shows the assemblies that most likely have failed causing certain exercisers, tests, or diagnostics to fail. Across the top are the four main configurations of 9845 desktop computers. The left column is a listing of system exerciser and diagnostic tests. Under each mainframe type is a list of assemblies that could cause the failure, the most probable listed first followed by other assemblies that could also cause the problem.

For RWM and ROM failures, memory troubleshooting permits failure pointers to the chip level. See the memory map on page 9-4.

TEST	9845B Opt 1XX	9845B Opt 2XX	9845C Opt 1XX	9845C Opt 2XX
TURN ON SELF TEST				
EXERCISER, MEMORY				
Blk 0, 3	28, 15	46, 30	28, 15	46, 30
1, 5	27/29, 15	27/29, 30	27/29, 15	27/29, 30
4, 6, 10, 12,				
14, 16, 20, 40, 60	26, 90, 15	26, 90, 30	26, 90, 15	26, 90, 30
7, 13, 17, 19	44, 15	44, 30	44, 15	44, 30
11	42, 15	42, 30	42, 15	42, 30
TAPE	61, 62	(same)	(same)	(same)
PRNTR				
No Dots	Prt. Head, Chip Module, 53, 51	(same)	(same)	(same)
Bad Char.	151	(same)	(same)	(same)
No Char.	151, 55, 53	(same)	(same)	(same)
No Feed	155, Motor	(same)	(same)	(same)
DIAGNOSTICS				
k1	32, keyswitches	(same)	(same)	(same)
k2	61, Xport, 16,	(same)	(same)	(same)
k3	Prt. Hd., 51,55	(same)	(same)	(same)
k4	2, 16	2, 16	2, 16	2, 16
k7	See k2	See k2	See k2	See k2
k8j				
Blk 0	28, 15, 16	46, 30, 16	28, 15, 16	46, 30, 16
1	27/29, 16, 15	27/29, 16, 30	27/29, 16, 15	27/29, 16, 30
4, 6, 10, 12				
14, 16, 20, 40, 60	26, 90, 15, 16, 28	26, 90, 30, 16, 46	26, 90, 15, 16, 28	26, 90, 30, 16, 46
k9	Same as k8	Same as k8	Same as k8	Same as k8
k10, B	(Not used)	130, 46	(Not used)	130, 46
M	Same as k8	Same as k8	Same as k8	Same as k8
O	Upt. 62, 61	(same)	(same)	(same)
P	See SysEx, PRNTR	(same)	(same)	(same)
R	See Memory Map	(same)	(same)	(same)
T	Std. 62, 61	(same)	(same)	(same)
k13	115, 28	130, 46	115, 28	130, 46
k15	115, 16, 28, 27/29	130, 16, 46, 27/29	115, 16, 28, 27/29	130, 16, 46, 27/29

Troubleshooting Flowchart

This flowchart is intended to guide you through various procedures to identify hardware failures in the 9845B/C Mainframe. QUICK CHECKS are used in virtually all cases. System exerciser and/or diagnostics are referred to when needed. Pointers are given to the 9845B/C CRT Chapter of this handbook when troubleshooting decisions indicate the failure is in the CRT.

In some cases, it may be necessary to substitute assemblies and parts not carried in the FSI kits. When total substitution is required, insure the following items are substituted:

Motherboards	Wire harnesses
Ribbon cables	Ground wires
Option ROM Drawers	Software Packages

Terms used in the flow chart and their meanings are:

Configuration	The combination of parts, assemblies, modules, switch settings, power, interface cards, peripherals, and software. Includes appropriate revisions and model numbers where applicable.
Exchange:	Remove the defined assembly/part out of the mainframe and install an exchange part of the same number and revision. New assemblies/parts may be used.
Install:	Place into the mainframe a part/assembly that was not previously installed.
Remove:	Take the defined part/assembly out of the product.
Reinstall:	Place back into the product the defined part/assembly that was previously removed.
Replace:	Remove the defined assembly/part and discard it. Install a new part of the same number and revision.
Repair:	Use tools and/or component parts to correct failure on the defined assembly.
Substitute:	Remove the identified part/assembly from the product. Install an identical part/assembly. This is a temporary situation used to verify hardware failures.

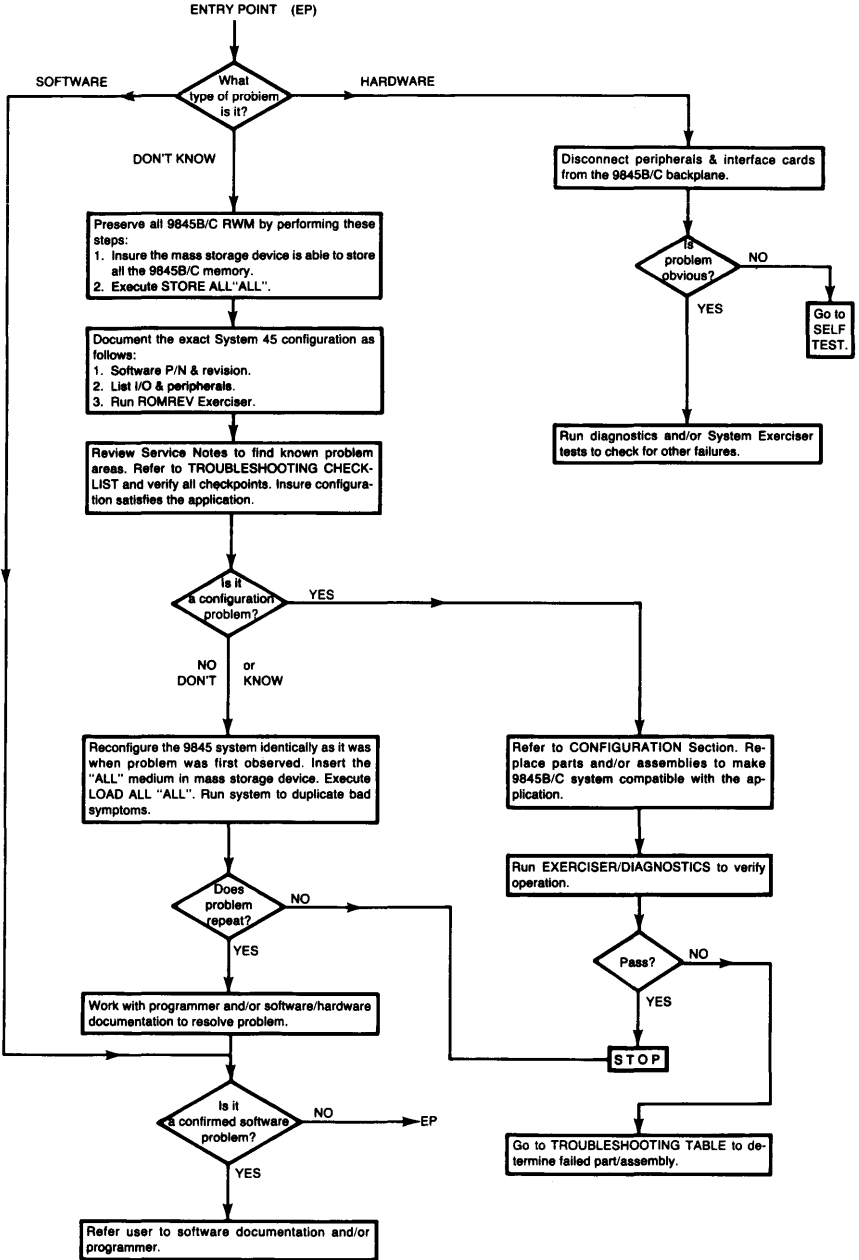

4-6 9845B/C Mainframe Troubleshooting

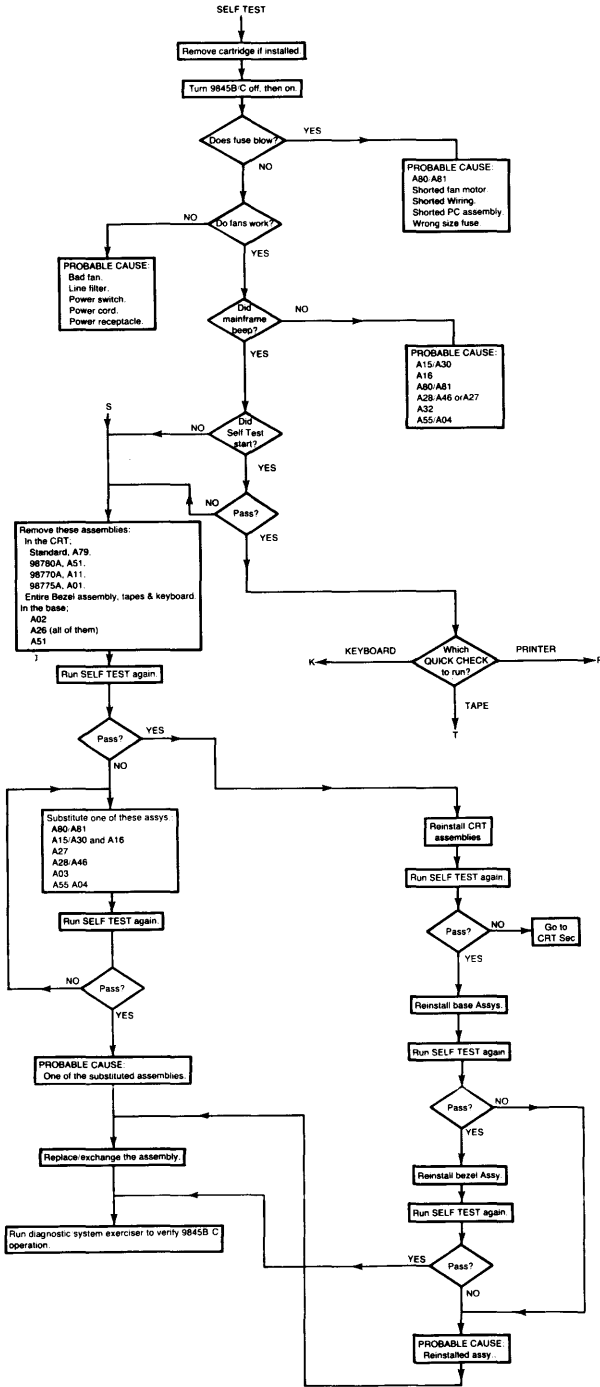

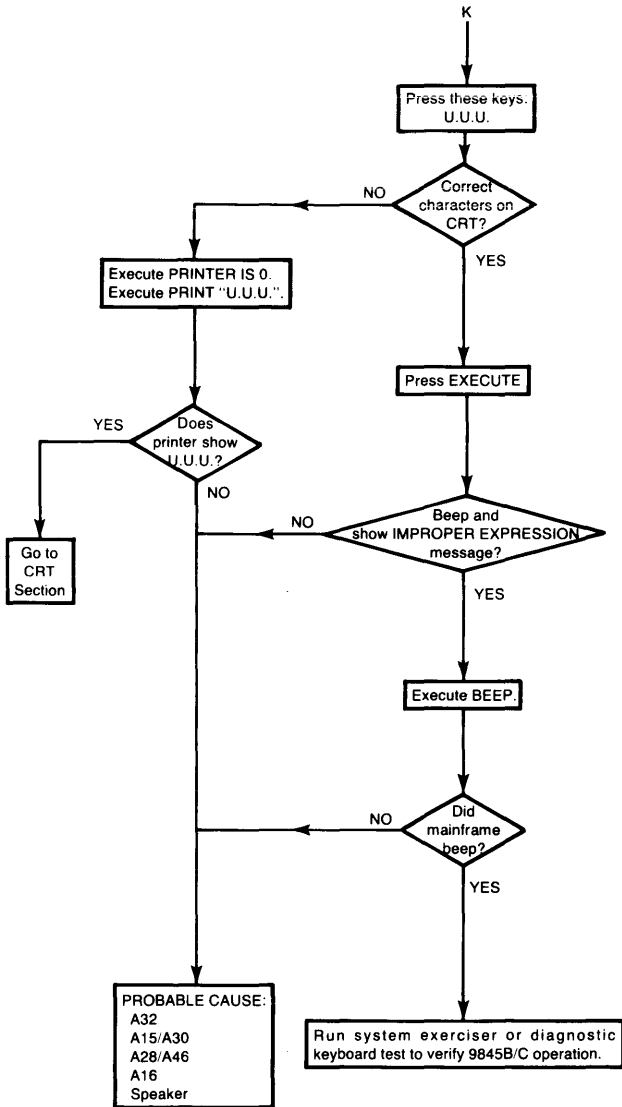

4-8 9845B/C Mainframe Troubleshooting

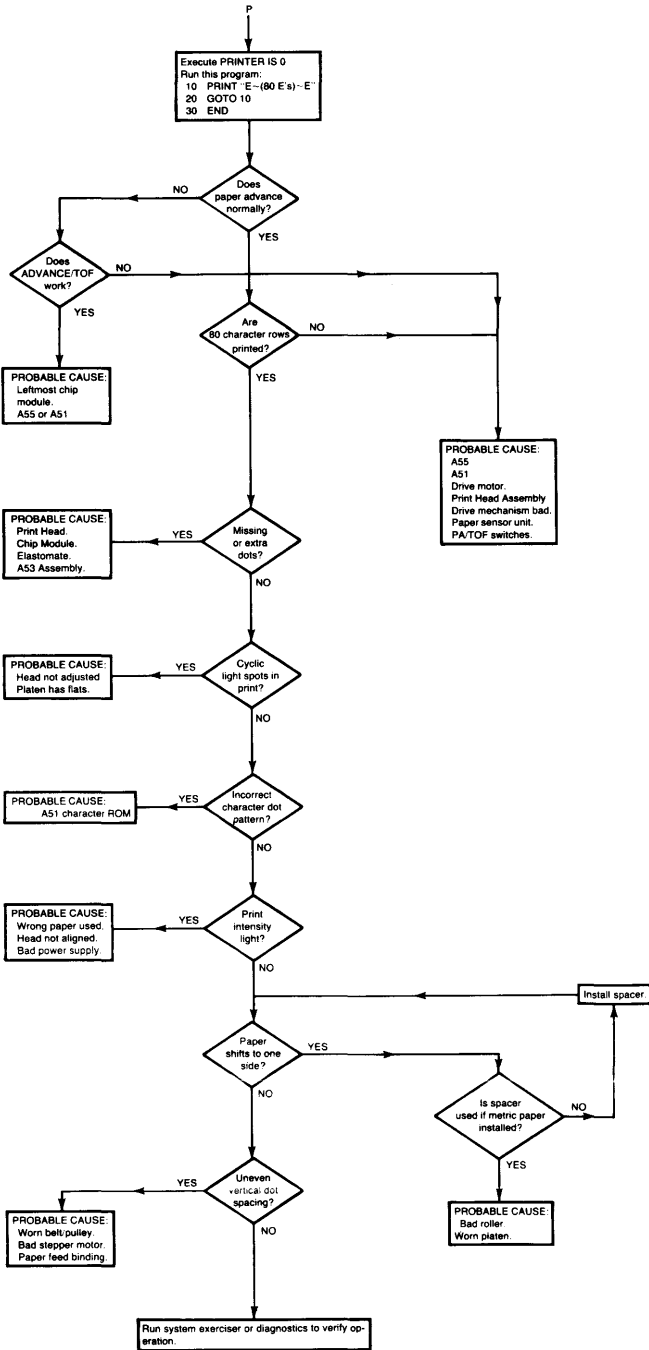

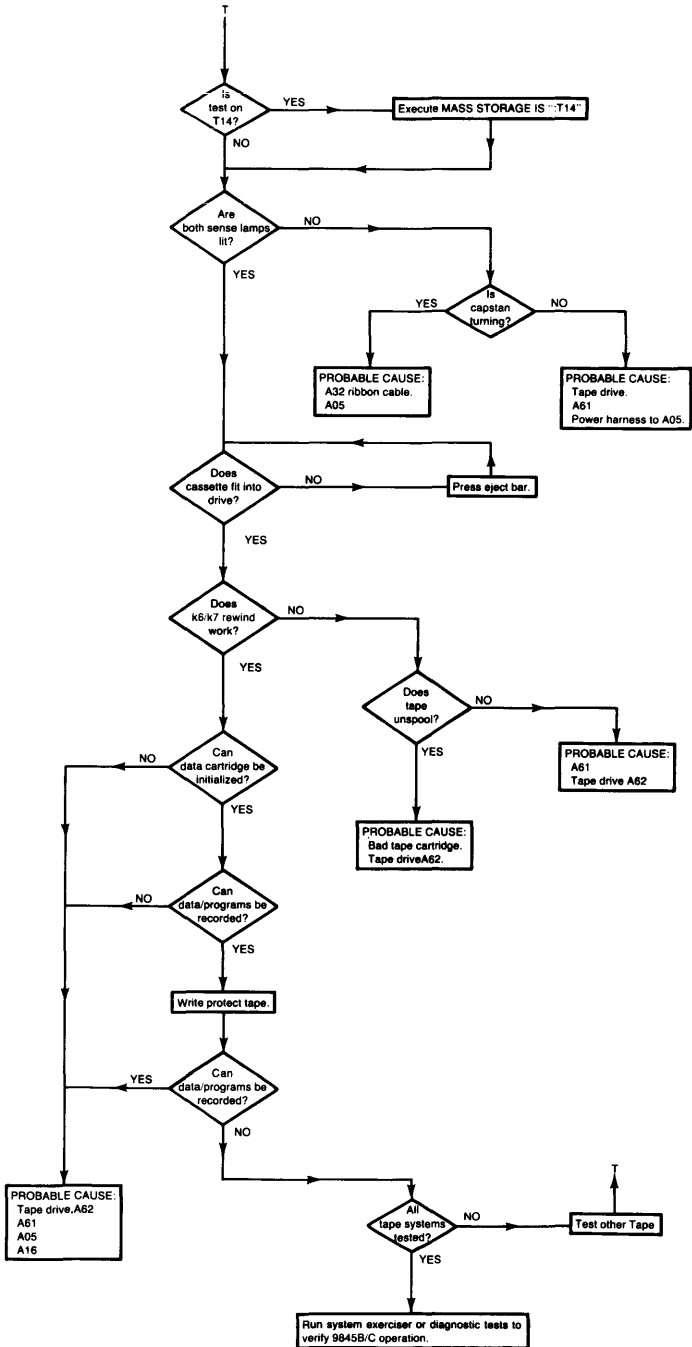

Memory Troubleshooting

These memory maps and hardware locators show how to interpret memory error messages obtained from system exerciser and diagnostic memory tests.

Error message decoding:

RWM error example;

MEMORY ERROR BLK BB ADDRESS AAAAA HAS XXXXXX NOT YYYYYY

BB = The octal block number, hardware correlation is;

0 = A28

1 = A27

2, 4, 6, 10, 12, 14, 16 are on A26. 2 is not used.

AAAAA = Is the octal address in the range 000040-077777,

If most significant digit is 0-3, address is low.

If most significant digit is 4-7, address is high.

XXXXXX = Data read from address.

YYYYYY = Data written into address.

To determine bit that failed, convert octal data to binary.

Example, XXXXXX = 000400 = 000 000 000 100 000 000

YYYYYY = 000000 = 000 000 000 000 000 000

Failed bit 

Count binary bits from the right starting with zero, the failed bit is 8. Refer to the hardware diagrams for bit/chip location on the memory board.

ROM error example:

ROM CHECKSUM FAILURE BLK BB ADDRESS SSSSSS - EEEEE

BB = Octal block number, the hardware correlation is;

3 = A28(46)

5 = A27

7, 13, = A44

11, 15 = A42

SSSSSS = Starting address of the ROM that failed.

EEEEEE = Ending address of the failed ROM.

Memory Troubleshooting

Memory errors in the read/write memory tests or the ROM checksum test can be translated to give the physical location of the memory error. Generally multiple failures indicate that the memory control logic is defective.

Read/Write Memory Errors

Read/Write memory errors are displayed slightly different for the two RAM boards used in the HP 9845B/C computer. The display will be in one of the following forms:

- a. For the 128k byte RAM board (HP p/n 09845-66526):

```
MEMORY ERROR BLOCK 04 ADDRESS 002052 HAS 000400 NOT 000000 or
                ^           ^           ^           ^
```

- b. For the 512k byte RAM board (HP p/n 09845-66590):

```
MEMORY ERROR BLOCK 24 ADDRESS 002052 HAS 000400 NOT 000000
                ^           ^           ^           ^
                Block      Octal      Actual    Expected
                (Octal)    Word       Octal     Octal
                                Address  Data      Data
```

1. First determine which memory assembly contains the block indicated in the error display. Refer to the following Figure for help:

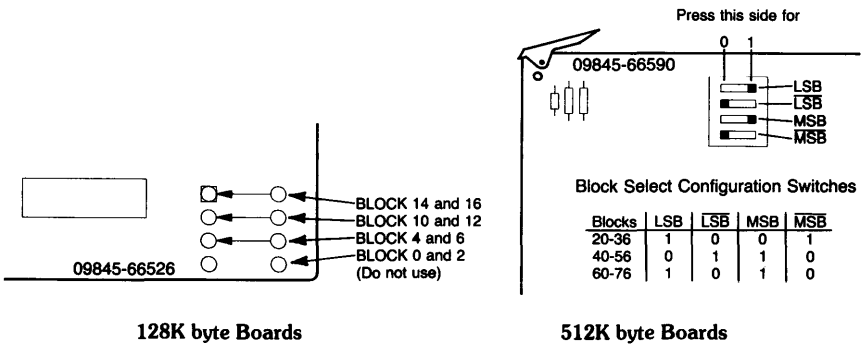

128K byte Boards

512K byte Boards

Block Select Settings

```
MEMORY ERROR BLOCK 04 ADDRESS 002052 HAS 000400 NOT 000000
                ^
```

2. This digit of the octal word address indicates either the upper half (high address) or the lower half (low address) of a block. Note that this information is not needed for the 512K board. The Block information is enough to locate the row of IC chips.
- If this digit is 0 through 3, the low address is indicated.
 - If this digit is 4 through 7, the high address is indicated.
3. Decode the data into binary values and compare the bits:
- Actual Data 0 000 000 100 000 000
 - Expected Data 0 000 000 000 000 000
4. The bits that do not compare indicate a defective RAM location. The following illustrations show the RAM chips that correspond to each bit position.

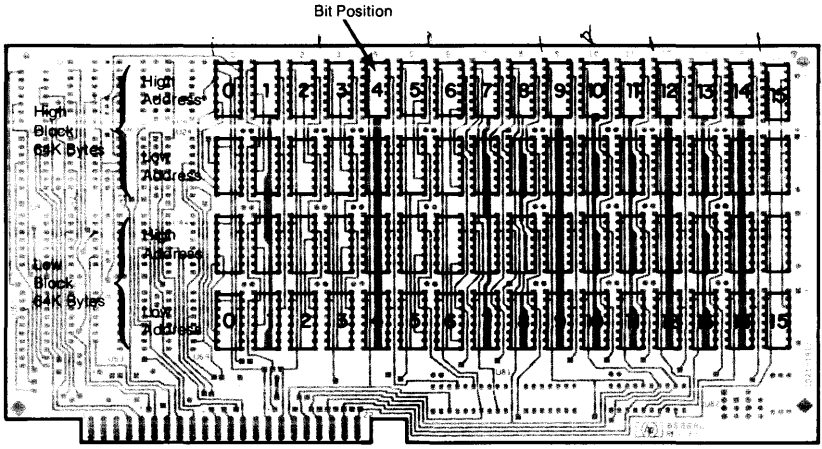

A26 Assembly

128K byte RAM Boards

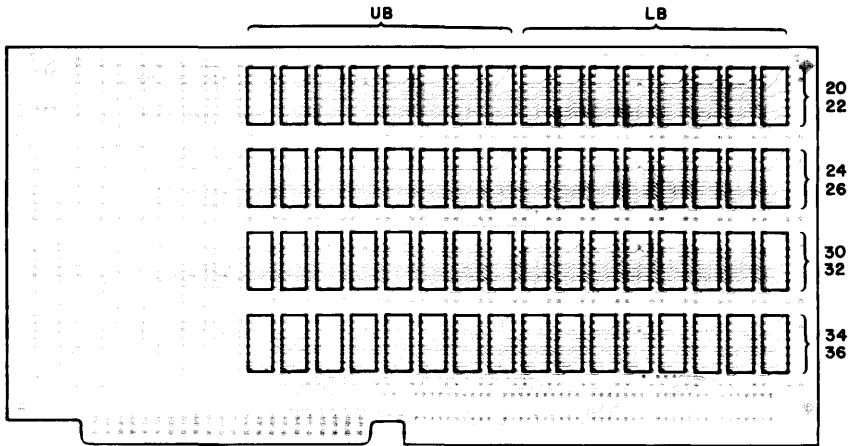

512K byte RAM Boards

9845B/C Mainframe Diagnostics

Chapter

5

9845B/C Mainframe Diagnostics

Introduction

This chapter will help you diagnose the 9845B/C Mainframe. The method used relies on the 9845B/C Test ROM and Binary Test Cartridge to isolate a faulty computer section. Both ROM and cartridge must be of the same revision letter.

This chapter is divided into the major mainframe sections. Each section consists of the description of the tests for that section. Use Table to find the tests and sections in this chapter.

9845B/C Mainframe Diagnostics are:

- Processor/Memory Addressing
- Memory (ROM and Read/Write)
- Keyboard
- Cartridge Drive
- Printer

Before you get to the various sections, use the trouble isolation procedures described in the quick check service procedure.

Quick Checks

From the keyboard you can perform three checks to determine the basic condition of the computer. Press the CONTROL and STOP keys, then run one or more of these three quick checks.

- Keyboard** Press random alpha keys on the keyboard (three or four X's should do it) and press execute. This generates an "improper expression" or an "improper character" error and an audible beep. If a beep occurs, the processor and operating system are probably working correctly. The CRT section may be defective.
- Tape** Here is a more demanding processor-memory test. See if a program can be entered into memory from tape. Install a tape and "GET" a data file from it, or "LOAD" a program file.
- Printer** If the printer is installed, execute the following lines:
 PRINTER IS 0 press EXECUTE
 PRINT "characters" press EXECUTE
 If the characters are printed, the printer is basically working and the processor/memory addressing is basically operating.

Note

The keyboard bezel assembly may cause the computer to appear inoperative. To eliminate this possibility exchange the complete keyboard bezel assembly including tape logic, keyboard logic and keyswitch assembly.

5-2 9845B/C Diagnostics

If the quick checks have failed, an assembly may be causing the problem by "hanging up" the computer's memory bus (IDA lines). To eliminate this problem, remove all the assemblies non-essential to basic processor operation.

Remove the CRT assembly and the mainframe top cover; then remove the following assemblies:

- I/O Backplane Assembly A2
- Option ROM Drawers, A42, A44
- Printer Control Logic Assembly A51 (if printer installed)

Reinstall the CRT assembly and perform quick checks 1 and 2 again. The printing test won't work since the printer assembly is removed.

If the quick checks now work, then one of the assemblies you removed is probably defective. Isolate the problem by returning the removed assemblies to the mainframe one at a time.

If some of the quick checks work, the computer is basically functioning and you may need further information about symptoms from the customer in order to determine the section that should be tested.

If the printer or tape cartridge quick checks do not work, the problem may be associated with that particular section.

If none of the quick checks have worked the problem can be in the following sections:

- Power supply — check voltage and exchange if necessary.
- Processor/memory control — A15 (LMC), A16 (PMC), A30 (LMC).
- Memory — A28 (LRR), A27 (PRR), A26 (R/W), A46 (200 LRR).
- CRT assembly or A3/A34, see 9845B CRT Section of CE Handbook.

To further isolate one of the sections listed above, use this procedure.

- Check the power supplies for proper voltage output.
- Install the test ROM (09845-65520) and test cartridge (09845-91031) (see 9845B Diagnostic Programs).

Note

The A3 or A34 assembly and the CRT assembly must be installed to perform the test ROM routines.

- Refer to the processor/memory control and memory sections and run the memory tests (the processor test is run automatically, but can be run by itself).

Note

The Test ROM or test cartridge can fail; when in doubt about test results, try the system exerciser tape.

9845B Diagnostic Programs

The 9845B/C Diagnostics are contained in a plug-in ROM and a data cartridge. The test programs will help you to:

- Confirm a failure using exerciser programs
- Identify the failure using error printouts and displays
- Verify the solution using the exerciser program

Refer to Table XX for a summary of the tests contained in the ROM and cartridge.

The diagnostics are designed to test functional areas rather than assemblies. Functional areas often involve more than one PC assembly.

Installation

In all cases:

- The test ROM is installed in the PPU ROM drawer (left drawer, A42).
- The binary test cartridge is installed in the right-hand drive (T15).

Usage Combinations

	ROM and Cartridge	ROM	Cartridge
Tests Available	ALL	Processor/Memory Addressing Read/Write Memory Test T14 and T15 cartridge drive test	All other mainframe tests
Modes	Automatic RunMode	Automatic Run Mode	Automatic Run Mode
	Operator Mode	Operator Mode	Operator Mode
9845B Operating System Requirements	Operating system can be: • Faulty • Operational	Operating system can be: • Faulty • Operational	Operating system must be operational
Installation	ROM installed in PPU ROM Drawer A42 Cartridge installed in T15	RCM installed in PPU ROM Drawer A42	Cartridge installed in T15

ROM and Cartridge Tests

The Test ROM Contains	Initiated By
Processor/memory addressing test	Automatic
Read/write memory test	k9
Cartridge drive tests (T14 and T15)	k2
LPU Processor Test	k13
The Test Binary Cartridge Contains	Initiated by
CRT Alpha test ¹	k0
Keyboard test	k1
Printer test	k3
I/O test	k4
CRT graphic test ¹	k5
Rewind T15	k7
Result printout	k6
Memorytroubleshooter	k8
Choose rack test sequence	k10
Automatic rack test	k11
Return to System/Program test	k15

¹ These tests are in the 9845B/C CRT section of the CE handbook.

Using Both the Test ROM and Test Binary Cartridge

With both the test ROM and cartridge installed, tests are initiated by initial turn-on or pressing the CONTROL STOP keys.

Note

If the ROM tests are being performed, the binary tape must be loaded to do the binary tape tests. Once in the binary tests, press the CONTROL STOP keys to return to the ROM tests.

Two modes are possible depending on the position of the autostart key.

Mode	Mode Determined By	Tests Are
Automatic Run Mode	Auto Start Key Down	Run automatically using the RACK TEST sequence
Operator Mode	Auto Start Key Up	Selected by the Operator

In the automatic run mode;

1. The processor and memory tests contained in ROM are performed.
2. Binary test programs are loaded from the test cartridge.
3. The "automatic rack test" sequence of tests is run.

Refer to the individual tests for details on each test. Press the STOP key to exit the automatic run mode.

In the operator mode;

1. The tests contained in ROM are performed.
2. Press the STOP key to skip the memory tests.
3. Binary test programs are loaded from the data cartridge.
4. Select the test to be performed and refer to the appropriate section for test details.

Note

Errors during any test in any mode will halt the test to preserve the error condition. Press the CONTINUE key to continue the same test. Press the STOP key to start another test.

Using the Test ROM Only

When only the test ROM is installed, testing is limited to the tests contained in the test ROM. Initial turn-on or pressing the CONTROL STOP keys will initiate the automatic run mode.

Requirements using only the test ROM:

- Auto start key should be up.
- A known-good, blank cartridge should be installed in T15 or T14 if the cartridge tests are to be performed.

When the ROM's tests are complete, the read/write memory or the tape cartridge drives can be tested separately without the binary programs.

Using the Test Binary Cartridge Only

Install the cartridge and press: LOADBIN "TBIN" EXECUTE. Two modes are possible depending on the position of the auto start key.

Mode	Mode Determined By	Tests Are
Automatic Run Mode	Auto Start Key Down	Run automatically using the automatic rack test sequence
Operator Mode	Auto Start Key Up	Selected by the operator

Press the STOP key to exit the automatic rack test and enter the operator mode. The tests available on the cartridge are listed in Table XX.

Processor/Memory Control Test

The processor/memory control test is run immediately after the test ROM receives control of the system. The test includes:

- Binary Instructions test.
- Input/Output Controller test.
- Mathematics Chip test.
- Memory addressing test.

An error will abort the test, preserving the error condition. If possible, error messages will be displayed. The computer beeps and displays:

```
PPU TESTED
LPU TESTED
BLK 0 SA-000040 EA-077777
```

when the test is complete.

Initial Memory Test

The initial memory test is run automatically after the processor test. It tests the areas of memory needed to load and run the binary programs from the test cartridge. Specifically:

- Unique block test determines if any block is answering to two block address.
- Block 1 PPU read/write test.
- Block 0 LPU read/write test.

An error will stop the test, preserving the error condition.

Press the STOP key to exit this test.

ROM and Read/Write Memory Tests

General Information

The test binary is originally loaded into block 0. When memory tests are performed on block 0, the binary is transferred into the next highest block available which has no error. If the binary cannot be transferred into another block, then "UNABLE TO TEST BLOCK 0" is displayed.

The test binary uses block 1 for basepage read/write locations. When testing block 1, these basepage locations are temporarily transferred to another block. If the transfer cannot be made, "UNABLE TO TEST BLOCK 1" is displayed.

Part of block 1 is used by the display. When block 1 is tested, the display is lost. If an error in block one is found, it is displayed, however, this destroys the test conditions in block 1 and causes other errors.

K1 Keyboard Test

This test is used to check all the keyboard keys and features for proper operation.

Before starting the test, all double-position keys like PRT ALL, AUTOST and SHIFT LOCK must be in the up position.

Press ;

If any of the double-position keys mentioned above are down, the display will tell you to release the key and then to press A.

If all the double-position keys are up, the CRT displays:

WHICH KEY TO START
TO END PRESS +

Press the key that you wish to start the test with. Any key shown below may be selected. Then press that key again. The display tells you which key to press next.

After selecting a key to begin, press the keys in the sequence shown above. To end the test, press . A bad key or a key pressed out of sequence will result in a beep and a message describing the key pressed in error. The key sequence described in Figure XX can be used for any keyboard option although the key caps and characters will be different.

If the spacebar is pressed as the first key, the test starts with the special keys (i.e., CONTROL, SHIFT LOCK, SHIFT).

If a bad key is found, restart the test and continue with the key after the bad key to test the rest of the keyboard.

The keys have to be pressed lightly and then pressed down fully. Pressing the arrow keys down fully will check the repeat function of these keys. A continuous beep should be heard when these keys are fully depressed.

Test the REPEAT key by pressing a key and the REPEAT key at the same time. A continuous beep should occur.

Keyboard Test Sequence

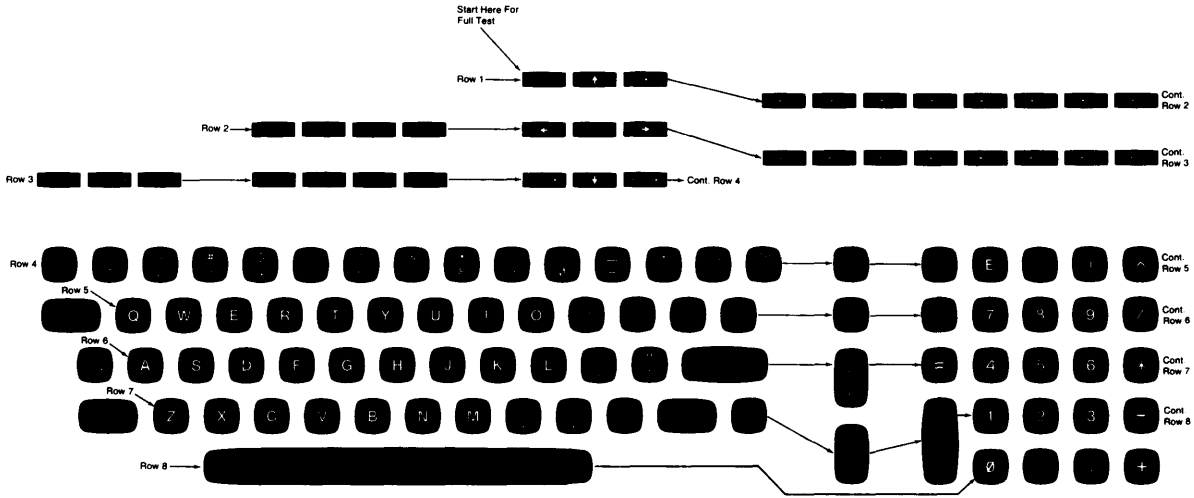

k2 Cartridge Drive Exerciser

Y Test Mode

CAUTION

DO NOT USE THE 9845B/C TEST BINARY TAPE FOR THE READ, WRITE, MOTOR DRIVE, OR TAPE LOGIC TESTS. USE A SCRATCH TAPE.

CRT displays TEST?

To write data on the blank tape cartridge, press these keys:

W CRT displays ENTER PATTERN FROM KEYBOARD
On math keys, enter a 6 digit octal number, 000000 thru 177777.

CONTINUE Tape rewind, starts continuous writing on one track, erasing previously recorded data. At end of track, tape stops, but can be stopped at any time by pressing

STOP Stops writing data and stops tape movement.

To read data from the same tape, press these keys:

C Tape rewinds, reads data, CRT displays this message:
LOW THRESHOLD READ DATA=DDDDDD wherein the D's should be the octal pattern used in the write test. If the write test was stopped before the entire track was written on, the octal pattern should change at the place the **W** test was stopped at. To change read threshold to high, press **H**. Data read should be the same for both thresholds.

STOP Ends the read and tape drive operations and the CRT displays TEST?, you may press another letter key to repeat or start a new test.

Motor Drive Tests:

CAUTION

THIS TEST CAN UNSPOOL THE TAPE, EOT/BOT DETECTION IS NOT USED. BE CAREFUL AND FOLLOW THESE DIRECTIONS.

Use the above read or write test to position the tape in the center of the track, each spool should have the same amount of tape. Read the following directions through once before you actually perform the test.

Press the following keys to perform the tape drive test:

Note

Pressing the HOME or STOP keys will stop the motor.

M Enables the tape drive test, the CRT displays
 INSERT DUMMY CARTRIDGE
 ENTER DIRECTION/SPEED

Place a scratch tape in the selected drive if not already done. If the tape is all on the left hand spool, it is rewound and should only be moved forward.

Pressing the left/right arrow display keys fully down will cause the drive motor to go fast; unless stopped, the tape will unspool and continue to drive. Pressing the display arrow keys half way down results in a slow drive speed. Pressing the arrow keys twice results in fast drive speed. Be careful you don't unspool the tape.

HOME or **STOP** will stop the tape drive.

→

Pressed halfway down results in slow forward motion.

→

Pressed full down results in fast forward motion.

←

Pressed halfway down results in slow reverse motion.

←

Pressed fully down results in fast reverse motion.

This test verifies the tape can move both directions and speeds.

Tape System Logic Test:

Press the following keys and perform the indicated steps;

T

Starts the tape logic test, the CRT displays

REMOVE CARTRIDGE **CONTINUE**

Remove the tape cartridge from the drive, then press

CONTINUE

This checks the cartridge in switch OUT position. To test the switch's IN position, the CRT prompts:

INSERT DUMMY CARTRIDGE **CONTINUE**

Place an unprotected scratch tape in the drive, then press

CONTINUE

The computer tests the tape drive and logic circuits then the CRT displays the following message;

INSERT CARTRIDGE **CONTINUE**

The T test is finished, insert the test binary cartridge and press the CONT key. Other tests can now be run.

If you wish to change the character that is being printed, simply press the desired key.

Pressing **STOP** whether a character was selected or not, ends the printer test.

Pressing **PAUSE** stops the printing; entering a character will begin printing again.

If a non-character key is pressed, E's are printed.

If the **CONTINUE** key is pressed, continuous rows of 560 dots are printed.

When printing the characters, the default page length of 70 lines is used.

k6 Display Results

Pressing **k6** displays option and test result information.

- Memory blocks not present in the computer are not displayed. The block numbers are octal. The addresses are octal word addresses.
- Other options are shown as "not present" if they are not installed.
- The number of times the test has been run is displayed in "Test Count". This number is decimal.
- The number of errors that occurred during a particular test is displayed in "Error Count". This number is decimal.

Here is an example k6 display.

	TEST COUNT	ERROR COUNT
BLOCK 1 000000-037777	00000	00000
BLOCK 1 040000-077777	00007	00000
BLOCK 0 000000-037777	00007	00000
BLOCK 0 040000-077777	00007	00000
BLOCK 2 000000-037777	00007	00000
BLOCK 2 040000-077777	00007	00000
BLOCK 4 000000-037777	00007	00000
BLOCK 4 040000-077777	00006	00000
BLOCK 6 000000-037777	00006	00000
BLOCK 6 040000-077777	00006	00000
BLOCK 10 000000-037777	00006	00000
BLOCK 10 040000-077777	00006	00000
BLOCK 12 000000-037777	00006	00000
BLOCK 12 040000-077777	00006	00000
BLOCK 14 000000-037777	00006	00000
BLOCK 14 040000-077777	00006	00000
BLOCK 16 000000-037777	00006	00000
BLOCK 16 040000-077777	00006	00000
GRAPHICS MEMORY	00006	00000
TRANSPORT-15	00006	00000
TRANSPORT-14	00006	00000
PRINTER	00006	00000
SYSTEM ROM	00006	00000

Press **STORE** to print the displayed information on the printer.

Press **STOP** to clear the display and to continue with the other tests.

k7 Rewind T15

Pressing **k7** rewinds a tape cartridge installed in the right-hand cartridge drive (T15).

k8 Read/Write Memory Troubleshooter

This test allows you to select specific memory tests. If the SHIFT LOCK key is down, the test will not stop on an error.

More than one test can be selected. Here is a list of the available tests and the key to press to select each test.

The **M**, **R**, **B** and **W** keys select different memory tests. Pressing the **P** key enters the “peek and poke” portion of the memory troubleshooter program. Peek and poke is described at the end of this test description.

Press	Test
M	Marching Pattern — A test pattern is stored in memory. The first word is read and verified and the complement of the test pattern is stored in the first word. This sequence is continued for every word in the block of memory. Once the pattern has been “walked up” memory, its complement is walked down. The marching pattern test walks up and down six different patterns. This test verifies that ones and zeros can be stored in all memory cells, and checks for opens and shorts in data bus lines.
R	Refresh — Zeros are stored in memory. The memory is left alone for ten seconds and then verified. Ones are then stored in memory and the sequence repeated. This test checks the refresh circuitry.
B	Byte — Zeros are stored in memory. Ones are then stored in the right-byte using the byte operation. Memory is then verified. Zeros are stored in memory and ones are stored in the left byte. Memory is verified. The sequence is then repeated with ones stored in memory and zeros stored in left and right bytes. This test checks memory byte operations.
W	Walking bit (ones and zeros) — Every cell in a byte half block of memory is set to zero. A one is written in the first cell, and all other cells are read to verify that it is still one. The tested cell is then restored to a zero and the next cell is set to a one. All cells are again read to verify their contents. The sequence is continued for every cell in the block. Its complementary pattern walking zeros completes the test. Each 64k block is tested, 32k bytes at a time. This test checks for memory cell row and column interactions. This test takes about six hours to test each 64k byte block of memory.

Select the tests in the order you want them to run; then press **CONTINUE**. If no tests are specified all the tests will be run.

Enter the octal block address of the memory block to be tested and press **CONTINUE**. If the specified block is not present, BLK NOT PRESENT is displayed. Press **CONTINUE** to enter another block address. If no block address is entered, the default is to test all blocks of memory.

Press **A** to test all blocks.

Once a block address has been entered, enter one of the following keys to select which portion of the block is to be tested.

Key	Selects the
U	Upper 32k bytes (addresses 40000-77777)
L	Lower 32k bytes (addresses 00000-37777)
B	Test full block (addresses 00000-77777)

Note

Since block 1 is only 32k bytes, block 1 testing is automatic (if selected) without the above block portion selection.

Then press **CONTINUE** to start the test.

Blocks are continuously tested. The block number and the starting and ending addresses are displayed (no display during block 1 testing).

Press **STOP** to exit the test.

Memory errors are displayed with the following format:

```
MEMORY ERROR BLK BB ADDRESS AAAAAA HAS XXXXXX NOT YYYYYY
```

```

BB- Octal block number
AAAAAA- Octal memory address
XXXXXX- Actual octal data
YYYYYY- Expected octal data
```

To recover from an error:

Press **CONTINUE** to continue with the next address.

Press **A** to continue testing with the next block.

Press **STOP** to exit the test.

After recovering from an error, the inverse video on the error message is turned off.

Peek and Poke

This feature allows you to read data from a specified memory location and to write data into a specified memory location.

6 digit octal addresses are accepted, in the range 000040-177777.

Locations 0 through 37 in any block should not be written into. These locations correspond to processor register numbers. Accessing these locations may stop the mainframe activity.

The test binary and the basepage can be destroyed by writing in the blocks that contain them (usually blocks 0 and 1). Read address 000033 for the current binary block and address 000036 for the current basepage block.

Press **P** ;

To read the contents of a memory location use this syntax; example Address 123456, Blk 4
123456 ;4 **EXECUTE**

5-14 9845B/C Diagnostics

To write into a memory location use this syntax;

123456;4=177777 **EXECUTE**

To write or read continuously, include a / after the pattern: 123456;4/

Multiple statements can be executed by separating them with a comma:

123456;4, 123457;4, 123460;4

k9 Read/Write Memory Test

This test performs marching pattern, refresh and byte tests on a selected memory block. Enter the octal block number and press **CONTINUE**.

If 100000 is entered, all even blocks are tested.

The block starting address and ending address are displayed. The block is continuously tested until **STOP** is pressed. Errors are treated as described in the memory troubleshooter.

k10 Choose Rack Test Sequence

This test allows you to arrange and set up your own rack testorder.

Note

The tests are performed only if the options are installed, otherwise, the tests are skipped. Likewise, if the printer has no paper the printer test will not be performed and if a tape cartridge is not installed the cartridge drive test will not be performed.

Disconnect all interfaces from the computer during this test.

When k10 is pressed, the sequence of desired tests can be entered. Here is a list of the tests and the key to press to select each test.

Keys to Press	Test
G	Graphics memory test
M	Read/Write memory test
O	Optional T14 Cartridge test
P	Printer test
R	System and Option ROMchecksum test
T	T 15 Cartridge test
B	A30 Fast LPU only
L	Light Pen Test (98775A)

Up to ten choices can be entered. After the tenth choice, testing is automatic.

Press **CONTINUE** to start the rack test sequence.

Press **S** to skip a test and continue with the next test.

Press **STOP** to exit the test.

When **STORE** is pressed after the test is running, information displayed on the CRT is printed if the printer is installed.

k10 ROM Checksum Test

The ROM checksum test is a part of the k10 choose rack test and the k11 automatic rack test. The contents of each option and system ROM are read and a checksum for each ROM is computed. If the checksum for a particular ROM is all zeros, the ROM is not there. If the checksum is all ones, the ROM is correct. If the checksum is other than all ones or zeros, a checksum failure is displayed in the following form.

ROM CHECKSUM FAILURE BLK X ADDRESS YYYYYY - ZZZZZZ

X = the octal block number

YYYYYY = the ROM starting address

ZZZZZZ = the ROM ending address

Press **CONTINUE** to continue the test after an error occurs.

Refer to memory map for ROM locations.

Refer to the appropriate sections in this chapter for test descriptions.

k11 Automatic Rack Test

This test is used to exercise the computer over an extended period of time. The k11 rack test runs the following tests continuously.

- System and Option ROM checksum test
- Graphics memory test
- Tape cartridge exerciser tests (T15 and T14)
- Printer tests
- Read/write memory tests¹

Note

The tests are performed only if the options are installed, otherwise, the tests are skipped. Likewise, if the printer has no paper the printer test will not be performed and if a tape cartridge is not installed the cartridge drive test will not be performed.

Press **S** to skip a test and continue with the next test. This test starts automatically if the auto-start key is depressed when the computer is switched on or power is recycled. Refer to the appropriate section in this chapter for test descriptions.

k15 Run Operating System

This special function allows you to return to normal computer operation. When using only the test binary cartridge, press **k15** to exit the tests and return to the 9845 operating system. Before returning to the system, however, the LPU/PPU is tested for BASIC language functions. Directions and prompts are displayed on the CRT.

If ROM checksum errors occur, or if the system ROMs are not present, the following error message is displayed:

WILL NOT JUMP TO SYSTEM, ROMERROR

Press any key after an error to exit this routine.

k15 Return To Operational System, 9845B/C Opt. ZXX

Note

This test is the **only** valid bit-slice processor test.

When the k15 return to system SFK is pressed and the AUTOST key is latched, the LPU processor and ROM checksum tests are performed. At that point, an AUTOST file is brought in to run the BIT-SLICE processor tests as desired.

Entry point for the Bit Slice Microcode test is either from k15 by answering yes to conduct bit slice microcode tests, or by doing a LOAD "AUTOST", 1 with TBIN in.

Note

If the AUTOST key is unlatched, the message "Autost must be latched before returning to the system" is displayed. When the AUTOST key is latched the Autost file will be brought in.

If CTL STOP is pressed after the 9845B/C has returned to normal operation and the Test ROM is installed, the Test ROM turnon test will run and the mainframe is back in the diagnostic mode.

9845B/C Mainframe Adjustments

Chapter

6

Adjustments

Special tools are not required for any mainframe adjustments.

Adjustments to the Thermal Printer

Instructions:

1. Turn off the 9845B/C and disconnect the power cord.
2. Remove the printer paper, CRT and shell.
3. Remove the bezel and use the service bracket to hold the bezel in the upright position. Do not disconnect the wiring.
4. Loosen the 2 adjustment lock screws on either side of the print head, located in the adjustment cams.
5. Install the CRT, printer paper, and power cord.
6. Turn on the 9845B/C and advance enough printer paper to extend back over the rear of the base.
7. Run any one of the following tests:
 - a. 9845B/C System Exerciser, PRNTR.
 - b. 9845B/C Diagnostic, k3.
 - c. Key in and run a program to continuously print 80 characters.
8. Adjust the cams for darkest print across the entire width of the printing area.
9. Tighten the lock screws on the adjustment cams and run the test program again to verify correct adjustment.
10. Turn off the 9845B/C and remove the CRT and printer paper.
11. Install the shell, bezel assembly, and printer paper.
12. Return the 9845B/C to normal operation.

6-2 9845B/C Mainframe Adjustments

9845B/C Mainframe Peripherals

Chapter

7

Supported Peripherals

Ordering Information

Product Number	Description	Required Interface	Required ROMs*
PRINTERS			
2601A Opt. 826 ¹	Daisywheel Letter Quality Printer	98036A Opt. 445	
2608A Opt. 845	Dot Matrix Line Printer (HP-IB)	98034B Opt. 445	
2631B Opt. 845 ¹	Serial 180 CPS Impact Printer (HP-IB)	98034B Opt. 445	
Opt. 009	European character set		
2631C Opt. 845 ¹	Serial 180 CPS Graphics Impact Printer (HP-IB)	98034B Opt. 445	
Opt. 009	European character set		
9876A Opt. 035	Thermal Line Printer	98034B Opt. 445	
Opt. 001	8-bit parallel interface	98032A Opt. 076	
Opt. 003	Metric paper and 5041-1503 spacer		
PLOTTERS			
7225B	Graphics Plotter (HP-IB)	98034B Opt. 445	Graphics ROM
17601A	Personality module for 7225B (required)		
Opt. 001	100 Vac Primary		
Opt. 002	120 Vac Primary		
Opt. 003	220 Vac Primary	order one of these	
Opt. 004	240 Vac Primary		
7245B Opt. 045	Plotter/Printer (HP-IB)	98034B Opt. 445	Graphics ROM
7580A Opt. 002 ²	Drafting Plotter (HP-IB)		
Opt. 045	For 9845B	98034B Opt. 445	Graphics ROM
Opt. 145	For 9845C	98034B Opt. 445	Graphics ROM
9872C Opt. 045 ¹	Eight-Pen Plotter (HP-IB)	98034B Opt. 445	Graphics ROM
9872T Opt. 045 ¹	Eight-Pen Plotter with paper advance (HP-IB)	98034B Opt. 445	Graphics ROM
WINCHESTER DISC DRIVES			
9134A ¹	Winchester Fixed Disc Drive (4.6M byte)	98034B Opt. 445 ²	Mass Storage ROM
CARTRIDGE DISC DRIVES			
7906M Opt. 102	Cartridge Disc Drive Master (20M byte)	98041A Opt. 045	Mass Storage ROM
7906S	Slave (20M byte)		
7920M Opt. 102	Cartridge Disc Drive Master (50M byte)	98041A Opt. 045	Mass Storage ROM
7920S	Slave (50M byte)		
7925M Opt. 102	Cartridge Disc Drive Master (120M byte)	98041A Opt. 045	Mass Storage ROM
7925S	Slave (120M byte)		
7925T	Two slaves (120M byte/slave)		
DISC/TAPE DRIVES			
7908P ¹	Integrated Disc/Tape Drive (16.5M byte)	98034B Opt. 445 ²	Mass Storage ROM
7911P ¹	Integrated Disc/Tape Drive (28.1 Mbyte)	98034B Opt. 445 ²	Mass Storage ROM
7912P ¹	Integrated Disc/Tape Drive (65.6 Mbyte)	98034B Opt. 445 ²	Mass Storage ROM
	Note: All three drives should be ordered with Product #09845-10840 CS-80 Backup Utilities.		
FLEXIBLE DISC DRIVES			
9885M Opt. 045 ¹	0.5M byte Flexible Disc Drive Master	98032A Opt. 485	Mass Storage ROM
9885S ¹	0.5M byte Flexible Disc Drive Slave		
9895A ¹	2.36M byte Flexible Disc Drive (HP-IB)	98034B Opt. 445 ²	Mass Storage ROM
Opt. 045	HP Flexible Disc Utilities		
Opt. 145	IBM Flexible Disc Utilities	order one of these	
MISCELLANEOUS			
7970E Opt. 826	9-Track Magnetic Tape Drive	98041A Opt. 045	I/O ROM or Graphics ROM
9111A ¹	Graphics Tablet	98034B Opt. 445	
Opt. 045	For 45B		
Opt. 145	For 45C	you must specify one	
9874 Opt. 045 ¹	Digitizer	98034B Opt. 445	I/O ROM or Graphics ROM
9878A Opt. 045	I/O Expander (increases number of slots from 4 to 10)**	Built-in	
9884A Opt. 045	Paper tape punch	98032A Opt. 484	

* Included with all 9845B/C Option 175, 275 and 280 mainframes.

¹ FCC Class A and VDE (level A) approved.² HP-IB mass storage devices require a dedicated 98034B Opt. 445 HP-IB Interface.

** Expander slots may not be used for mass storage interlacing.

Hardware Compatibility Information

This information lists various peripheral devices supported by HP for the 9845B/C Desktop Computers. ROM names, part numbers, revisions, and memory locations are referenced. Some software information is also provided. The Service Note referencing the data is shown in parentheses.

Running the ROMREV test (9845B/C System Exerciser #2) can list the current configuration of the 9845B/C mainframe.

1. Mass Memory Devices.

See also 98028-90039 Disc Drive CE Handbook Section.

a. Hard discs 7906/7920/7925. These discs require the following:

1. Revision E or later backplane (9845B/C-7).
2. Revision B or later Block 5 Address 20K ROM pair (9845B/C-5).
3. Revision D or later Block 5 Address 40K ROM pair (9845B/C-5).
4. Revision D or later Block 5 Address 60K ROM pair (9845B/C-5).
5. Revision B or later Block 3 Address 0K ROM pair (9845B/C-3).
6. Revision B or later Mass Storage ROM 98413A/B, (9845B/C-10).
7. 98041A Disc Interface, one per mainframe.
8. 12745B/13037A Disc Controller with HPIB interface.
9. Limited to one 98041 per mainframe with one 79xx master per 98041A and up to three 79xx slaves, or two 79xx slaves plus one 7970E.

b. 7910H and 9895 discs. These discs require the following:

1. 98034A/B Revised HPIB interface (66501/66502 boards Rev E or later, or 66503/66504 boards all Revs).
2. Revision B or later Block 5 Address 20K ROM pair (9845B/C-5).
3. Revision D or later Block 5 Address 40K ROM pair (9845B/C-5).
4. Revision B or later Block 3 Address 0K ROM pair (9845B/C-3).
5. Revision C or later Mass Storage ROM 98413B, (9845B/C-10).
6. Only mass storage devices on the 98034A/B card (i.e. 9895/7910 combinations).

c. 7970E Tape Drives. These drives require the following:

1. The 7970E must be an option 826.
2. Revision E or later A02 assembly (9845B/C-7).
3. 98041A Disc Interface.
4. 09845-15524 Tape Utilities Revision C or later for EBCDC.
5. No more than one 7970E per 98041A, may also have a hard disc on the same 98041A. (Max configuration is 98401A, 79xxM, 79xxS, 79xxS, 7970E).
6. Mass Storage ROM is NOT required for the 7970E.

d. 9885M/S Flexible Disc Drives. These drives require the following:

1. 98032A requires one shot timing changes (9845B/C-8).
2. 9885M/S requires A4 board changes (9885M/S-4A, 9885M/S-5A).
3. Revision B or later Block 5 Address 20K ROM pair (9845B/C-5).
4. Revision D or later Block 5 Address 40K ROM pair (9845B/C-5).

5. Revision D or later Block 5 Address 60K ROM pair (9845B/C-5).
 6. Revision B or later Block 3 Address 0K ROM pair (6845B/C-3).
 7. Revision A or later Mass Storage ROM. (Revision B or later if DBM ROM is installed.) (9845B/C-10.)
- e. Internal Tape Drives. These drives require the following:
1. Revision B or later Block 5 Address 20K ROM pair (9845B/C-5).
 2. Revision D or later Block 5 Address 40K ROM pair (9845B/C-5).
 3. Revision D or later Block 5 Address 60K ROM pair (9845B/C-5).
 4. Revision B or later Block 3 Address 20K ROM pair (9845B/C-3).
 5. Mass Storage ROM is NOT required.
2. Printers.
- a. Internal Printer.
 1. Requires printer option including A52 or A55, and A51 assemblies plus the printer bucket. Note that A51 has the printer character ROM (currently Revision A).
 2. Hardware compatibility considerations:
Printheads manufactured after 1978 are NOT compatible with the the A52 board (09845-66552) and must be used with an A55 board (09845-66555). (9845B/C-2.)
 - b. External printers will work for lists etc., using PRINTER IS syntax, for full capabilities they require an I/O ROM; all Revisions are okay (LPU presently is A, PPU presently is C).
 - c. H-P Supplied Printers information:
 1. 2631A/G; HP supports only the HPIB version on a 98034A/B. The 2631G version requires a Graphics ROM and the graphics support boards.
 2. 9876A; HP supports either the HPIB version, or the GPIO version with a 98034A/B or 98032A Opt. 076 respectively. DCD does NOT support the serial version on Desktops due to handshake difficulties with the 98036A card. Graphics capabilities require a Graphics ROM and the graphics support boards.
 3. 9871A; HP supports the HPIB version with a 98034A/B, or the GPIO version with a 98032A Opt. 071.
 4. 2608A; Requires Graphics ROM and Graphics support boards in the main-frame. HPIB is the only interface supported on 9845B/C with the 98034A/B. Note that the HPIB control board 02608-60026 on the 2608 must have jumpers in locations WT1 to WT2, WT3 to WT4, and WT5 to WT6.
3. Plotters and Digitizers.
- a. HP Plotters.
 1. Require either the IO ROM pair, or the Graphics ROM; with a 98034A/B. Graphics ROM must be Revision B or later (9845B/C-5).
 2. The plotters can be driven using "HPGL" syntax with IO ROM.
 3. 8 pen plotters require either the Revision C 09845-65517 Graphics ROM with the "PLOTTER IS 7,5,'9872A'" syntax, or Revision A or later of the Enhanced Graphics ROM 98780-65501 with the "PLOTTER IS 7,5,'HPGL'" syntax.

4. The use of other syntax or ROM revisions will only support 4 pen operation, as the operating system will do a modulus 4.
 - b. Non H-P Plotters. These plotters use the Graphics ROM with a 98034A/B and the "INCREMENTAL" syntax. Note that an I/O ROM can be used in place of the Graphics ROM if appropriate software drivers are written. The graphics ROM, if used, should be Revision B or later (9845B/C-10).
 - c. Digitizers. These use the 98034A/B and the IO ROM pair.
4. HPIB Instruments.
- a. Data Acquisition Systems. These systems (usually multiprogrammer based) require a Revised HPIB interface (98034A/B). If the 98034 interface has a 66503 Rev A or B, or a 66501 Rev E or F board, then the internal HPIB address of the card should be changed from the factory default of 21 to a non-parity generating address such as 20. Some kind of software driver has to be written for these cards to recover from an occasional invalid setting of the SRQ line. Interfaces with 66503 Rev C and later can utilize any HPIB address and do not require the software driver.
 - b. Secondary Addressing. Option 2XX models of the 9845B/C do not support secondary addressing in the same manner as option 1XX models. Option 2XX models require the use of SENDBUS syntax to prevent the sending of an unintentional secondary command of 0 and to allow sending of any other value secondary command.
 - c. All 9845B/C models require the use of a Revised HPIB interface.
 - d. HPIB bus configuration commands result in a different sequence of operations on ENTER or READ BIN than done by a 9825. SENDBUS syntax can be used in those situations where a peripheral is sequence dependent (such as utilizing a secondary command sequence to get the status of a 2631 printer).
5. Graphics/Plotters.
- a. 9845B Option 1XX. This option requires: (9845B/C-10A)
 1. Graphics ROM 09845-65517 Revision C or later to support 8 pen plotters and DSN/DL. This ROM requires mainframe ROM pair 1818-0835 and 1818-0831.
 2. Left Support A3 (09845-66503).
 3. Graphics Scanner A77 (09845-66577).
 4. Graphics Memory A79 (09845-66579).
 - b. 9845B Option 2XX. This option requires: (9845B/C-10A).
 1. Enhanced Graphics ROM 98780-65501 Revision A or later with mainframe ROM pair 1818-1591 and 1818-1592.
 2. Alpha Control A34 (98770-66534).
 3. 98780A Fast Monochromatic CRT.
 - c. 9845C Option 1XX. This option requires: (9845B/C-10A).
 1. Either Enhanced Graphics ROM 98780-65501 Revision A or later with mainframe ROM pair 1818-1591 and 1818-1592; or Color Graphics ROM 98770-65501 any revision with mainframe ROM pair 1818-1208 and 1818-1209. The Enhanced Graphics ROM trio is the preferred configuration. NOTE that the mainframe ROM pairs match up with a specific Graphics option ROM and cannot be mixed.
 2. Alpha Control A34 (98770-66534).

3. 98770A Color CRT.
- d. 9845C Option 2XX. This option requires: (9845B/C-10A).
 1. Enhanced Graphics ROM 98780-65501 and mainframe ROM pair 1818-1591 and 1818-1592.
 2. Alpha Control A34 (98770-66534).
 3. 98770A Color CRT.
 - e. 9845B Option 1XX with 98403A Fast Processor Upgrade Kit. This option requires: (9845B/C-10A).
 1. Graphics ROM 09845-65517 and mainframe ROM pair 1818-0835 and 1818-0831.
 2. Left Support A3 (09845-66503).
 3. Graphics Scanner A77 (09845-66577).
 4. Graphics Memory A79 (09845-66579).
6. Assembly Development and Executing ROM.
This ROM requires a PPU processor board with an AEC chip manufactured after July 1979 (9845B/C-10).
 7. DBM ROM. Use of this ROM requires the following configuration:
 - a. Revision C or later IO ROM (PPU side) (9845B/C-10).
 - b. Revision D or later Block 5 Address 40K ROM pair (9845B/C-5).
 - c. Revision B or later Mass Storage ROM for all mass storage devices except 9895, which requires Revision C or later (9845-10).
 - d. If the mass storage device is a 9885, then the following is required:
 1. 98032A must have correct one shot timing (9845B/C-8).
 2. 9885M/S must have A4 board changes per 9885M/S-4A and -5A.

7-6 9845B/C Peripherals

9845B/C Mainframe Replaceable Parts

Chapter

8

Repair Philosophy

The 9845B/C mainframe assemblies are divided into those that can be exchanged (X) and those that can be repaired (R) or discarded in the field. This table identifies each mainframe assembly by its assembly number and field repair philosophy. Comments relating to the assembly are given where necessary.

ASSEMBLY	DESCRIPTION	IX/R	COMMENTS
CASE PARTS	Covers, card cages, wire harnesses, fasteners, connectors, air filters, brackets, other mechanical items.	R	
POWER			
A80	Option 1XX Power Supply	X	Assemblies A81 through A85 must be included.
A81	Option 2XX Power Supply	X	Assemblies A82 through A85 must be included.
Back panel	Line filter, fuse, voltage sel. sw.	R	
PROCESSORS			
A15	Option 1XX Language Processor	X	
A16	Peripheral Processor	X	
A30	Option 2XX Fast Language Processor	X	Includes all 3 PCA's.
MEMORY			
A26 A29	Optional RWM assembly 64 Kbyte Optional RWM assembly 0.5 Mbyte	X	Block select jumper must be correct for memory location.
A27	Standard PPU RWM-ROM assy.	X	Remove these 4 chips: 81K, S, Add. 0 & 20K, low & high byte. Insert them in the exchanged A27/29 assy. Individual RWM-ROM chips may be replaced.
A28	Opt. 1XX Standard LPU RWM-ROM Assy.	X	Individual RWM-ROM chips may be replaced.
A42	LPU Option ROM Drawer PC assembly	X	Does not include the plug-in Option ROMs.
A44	PPU Option ROM Drawer PC Assembly	X	Does not include the plug-in Option ROMs.
A46	Opt. 2XX Std. Fast LPU RWM-ROM Assy	X	Individual RWM-ROM Chips may be replaced.
Opt. ROMs	Plug-in ROMs for A42 and A44.	R	

8-2 9845B/C Mainframe Replaceable Parts

KEYBOARD			
A32	Keyboard Logic Assembly	X	
Keys	Keypress PC Assembly	R	Individual keyswitches and caps are replaced.

TAPE			
A5	Bezel Interconnect Assembly	R	
A61	Cartridge Drive Logic Assembly	X	Fuse may be replaced.
A62	Tape Transport Assembly	X	Includes sheet metal.

PRINTER			
A51	Printer Control Logic Assembly	X	Socketed Char. ROM can be replaced.
A53	Print Head PC Assembly	R	
A55	Print Motor Logic Assembly	X	
Head	Print Head	R	Return head to DCD QA Red Stripe for failure analysis.
Bucket	Bucket Assembly, Motor, parts of Print Head Assembly	R	Entire bucket is component repair.

OTHER ASSY.			
A2	Interface Backplane Assembly	R	Fuses may be replaced.
A3	Opt. 1XX Alpha Control Logic Assy.	X	
A4	Graphics Interconnect Assy.	R	Replaced by A55 if the Printer is installed.
A34	Opt. 2XX Alpha Control Logic Assy.	X	

Assembly Level	Reference Designator	CD	HP Part No.	TQ	Description
					ROM Drawers
1		8	09845-60346	1	Right ROM Drawer Assembly
2		8	0624-0418	6	.625 in., FH pozidriv tapping screw
2		5	09845-04119	1	Right ROM Drawer Bottom
2	A42	8	09845-66542	1	LPU Option ROM PC Assembly
2		0	5040-8368	1	ROM Drawer Cover
2		4	5041-1439	1	Right ROM Drawer Top
1		9	09845-60347	1	Left ROM Drawer Assembly
2		5	09845-04119	1	Left ROM Drawer Bottom
2	A44	0	09845-66544	1	PPU Option ROM PC Assembly
2		0	5040-8368	1	ROM Drawer Cover
2		3	5041-1438	1	Left ROM Drawer Top
					Mainframe Top Cover
1		6	09845-67902	1	Mainframe Top Cover Assembly
2		6	0624-0333	2	.250 in., PH Pozidriv Tapping Screw
2		6	0624-0408	4	.375 in., 100°, FH Pozidriv Tapping Screw
2		1	09845-04412	1	Shell, Top Cover
2		4	09845-21203	2	Printer Door Bracket
2		1	09845-23701	2	Printer Door Shaft
					Mainframe
1		9	09845-67921	1	Mainframe Assembly
2	A2	0	09845-66502	1	I/O Backplane Assembly
3		8	1251-2026	4	36-Pin PC Edge Connector (2X18)
3					
3					
2	A3	1	09845-66503	1	CRT Alpha Control Assembly (98750A)
3	A34		98770-66534	1	Alpha Control Logic Assembly (98770 or 98780)
3		0	0624-0402	2	.250 in., PH Pozidriv Tapping Screw
3		6	09845-04706	1	Left Support Latch
3		3	1251-4978		
3		7	5040-7995	1	36-Pin PC Edge Connector (2X18)
2		5	5040-7995	1	Connector Support
2	A15	5	09845-66515	1	LPU Processor-Memory Control Assembly
2	A16	6	09845-66516	1	PPU Processor-Memory Control Assembly
2	A27	9	09845-66527	1	PPU RAM/ROM Assembly
3			1818-0391	16	16k RAM chip
3			1818-0831	1	PPU ROM Blk 5 Add OK High Byte
3			1818-1591	1	ROM Blk 5, OK Low Byte Enh CRT
3			1818-1208	1	ROM Blk 5, OK Low Byte Cir CRT
3			1818-1209	1	ROM Blk 5, OK High Byte Cir CRT
3			1818-0836	1	ROM Blk 5, 20k Low Byte U.S.
3			1818-0832	1	ROM Blk 5, 20k High Byte U.S.
3			1818-0844	1	ROM Blk 5, 20k Low Byte French
3			1818-0839	1	ROM Blk 5, 20k High Byte French
3			1818-0846	1	ROM Blk 5, 20k Low Byte German
3			1818-0841	1	ROM Blk 5, 20k High Byte German
3			1818-0845	1	ROM Blk 5, 20k Low Byte Spanish
3			1818-0840	1	ROM Blk 5, 20k High Byte Spanish
3			1818-0848	1	ROM Blk 5, 20k Low Byte Swe/Fin
3			1818-0843	1	ROM Blk 5, 20k High Byte Swe/Fin

8-4 9845B/C Mainframe Replaceable Parts

Assembly Level	Reference Designator	CD	HP Part No.	TQ	Description
3			1818-0847	1	ROM Blk 5, 20k Low Byte Katakana
3			1818-0842	1	ROM Blk 5, 20k High Byte Katakana
3			1818-0837	1	ROM Blk 5, 40k Low Byte
3			1818-0833	1	ROM Blk 5, 40k High Byte
3			1818-0898	1	ROM Blk 5, 60k Low Byte
3			1818-0899	1	ROM Blk 5, 60k High Byte
3			1818-1592	1	ROM Blk 5, 0K High Byte Enh CRT
2	A28		09845-66528	1	LPU RAM/ROM Assembly (Option 1XX)
3			1818-0391	16	16k LPU RAM Chip
3			1818-0827	1	LPU ROM, Add 0k Low Byte
			1818-0823	1	LPU ROM, Add 0k High Byte
3			1818-0828	1	LPU ROM, Add 20k Low Byte
3			1818-0824	1	LPU ROM, Add 20k High Byte
3			1818-0829	1	LPU ROM, Add 40k Low Byte
3			1818-0825	1	LPU ROM, Add 40k High Byte
3			1818-0830	1	LPU ROM, Add 60k Low Byte
3			1818-0826	1	LPU ROM, Add 60k High Byte
2	A46		09845-66546	1	LPU RAM/ROM Assembly (Option 2XX)
3			1818-0391	32	16k LPU RAM Chip
3			1818-1506	1	LPU ROM, Add 0k Low Byte
3			1818-1502	1	LPU ROM, Add 0k High Byte
3			1818-1507	1	LPU ROM, Add 20k Low Byte
3			1818-1503	1	LPU ROM, Add 20k High Byte
3			1818-1508	1	LPU ROM, Add 40k Low Byte
3			1818-1504	1	LPU ROM, Add 40k High Byte
3			1818-1509	1	LPU ROM, Add 60k Low Byte
					Base Assembly
2		7	09845-04411	1	Base Assembly
3		3	1403-0106	4	Rubber Foot
3		8	0403-0268	4	PC Guide, 4.5 in. long
3		1	0624-0403	17	.375 in., PH Pozidriv Tapping Screw
3		5	0624-0407	2	.250 in., 100° FH Pozidriv Tapping Screw
3		6	0624-0408	6	.375 in., 100° FH Pozidriv Tapping Screw
3		0	0624-0410	14	.437 in., PH Pozidriv Tapping Screw
3		3	09845-01212	1	Base Strap
3		5	09845-01214	1	Power Switch Strap
3		6	09845-01215	1	Left PC Clamp
3		7	09845-01216	1	Right PC Clamp
3		0	09845-04411	1	Base
3		5	09845-04713	1	Left ROM Drawer Guide
3		6	09845-04714	1	Right ROM Drawer Guide
3		6	09845-05001	1	Right Latch Hook
3		9	09845-05004	1	Left Latch Hook
3		9	09845-60181	1	Power Supply Chassis Assembly
4		3	0360-1841	1	Terminal Block
4		7	0403-0225	6	PC Guide
4		5	09845-01206	1	PC Guide Bracket

Assembly Level	Reference Designator	CD	HP Part No.	TQ	Description
4		8	09845-60180	1	Power Supply Sheet Metal Chassis
3		4	09845-04423	1	Keyboard Bezel, Plastic Only, 9845B
			09845-04413	1	Keyboard Bezel, Plastic Only, 9845A
			09845-04433	1	Keyboard Bezel, Plastic Only, 9845C
		8	09845-05003	2	Plate Latch
3		2	09845-23702	1	Hinge Pin
3		6	09845-61607	1	Cable from Cartridge Drive to A61 (T15) T14 Cable is 09845-61611
3	A61	1	09845-66561	1	Cartridge Drive Logic Assy
3		3	09845-67800	1	Keyboard (See keyboard drawings for keycap part numbers)
4	A5	3	09845-66505	1	Bezel Interconnect Assembly
4	A32	6	09845-66532	1	Keyboard Logic Assembly
4					
5		8	09845-00201	1	Keyboard Panel
5		8	09845-01215	1	Left PC Hold Down Bracket
5		1	09845-01216	1	Right PC Hold Down Bracket
5		8	09845-61609	1	Cable from A31 to A32
5		5	9160-0246	1	Loud Speaker
3		7	09845-67961	1	Cartridge Drive Bezel Assembly
4		5	0624-0340	6	.188 in., Slot Tapping Screw
4		9	1460-1589	1	Extension Spring
4		7	1600-0656	4	Window and Ramp Retainer
4		0	2260-0014	1	4-40, .135 in. ID, Nut
4		9	5040-8226	1	Cartridge Drive Ramp
4		2	5040-8229	1	Cartridge Drive Window
4		6	5040-8231	1	Lower Link - Small Piece for Opening Tape Door
4		7	5040-8232	1	Upper Link - Large Piece for Opening Tape Door
4		4	5040-8263	1	Bezel
3		8	09845-67962	1	Cartridge Drive
			2140-0221		End of Tape Lamp
3		8	1460-1588	1	Torsion Spring
3		8	2200-0521	6	4-40, .250 in., PH Pozidriv Screw
3		8	2360-0333	4	6-32, .250 in., FH Pozidriv Screw
3		6	2360-0422	10	6-32, 1.562 in., PH Pozidriv Screw
3			2360-0423	2	6-32, .562 in., PH Pozidriv Screw
					Rear Panel
3		6	09845-60302	1	Rear Panel Assembly
4		7	09845-04111	1	I/O Port Cover
4		3	09845-04414	1	Rear Panel
4		2	09845-61603	1	Power Switch Cable
5		4	3101-2267	1	Switch, Main Power
			9135-0066	1	Old Line Filter
			9135-0132	1	New Line Filter
			2110-0051	1	10A NB Fuse for 100/120V
			2110-0056	1	6A NB Fuse for 220/240V
3		0	09845-61601	1	10 Conductor Ribbon Cable (Power, A0 to A5)
4		6	1251-3808	2	Polarizing Plug
4		1	1251-4182	18	Crimp Terminals
4		4	1251-4565	2	10-Pin Connector Housing
3		8	09845-66500	1	Motherboard
4		4	1251-0472	1	12-Pin PC Edge Connector (2X12)

8-6 9845B/C Mainframe Replaceable Parts

Assembly Level	Reference Designator	CD	HP Part No.	TQ	Description
4		6	1251-1365	7	44-Pin PC Edge Connector (2X22)
4		8	1251-2026	1	36-Pin PC Edge Connector (2X18)
4		8	1251-2034	2	20-Pin PC Edge Connector (2X10)
4		1	1251-2582	2	48-Pin PC Edge Connector (2X24)
4		3	1251-4572	1	10-Pin Connector
4		9	1251-4677	2	36-Pin PC Edge Connector (2X18)
4		4	1251-5000	2	56-Pin PC Edge Connector (2X28)
4		4	1251-5597	2	Connector
3		4	09845-66605	1	Left PC Card Cage Assembly
3		5	09845-66606	1	Right PC Card Cage Assembly
3		8	1460-1603	1	Wire Form
3		8	2360-0333	6	6-32, .250 in., FH Pozidriv Screw
3		9	2360-0433	6	6-32, .500 in., FH Pozidriv Screw
3		5	5061-4201	2	Foam Filter and Frame
3		5	5040-8230	1	Switch Bezel, Power Switch
			3160-0311	2	Fan
					Miscellaneous
1		7	09845-04301	1	USA Serial Plate
1	A4	2	09845-66504	1	Graphics Interconnect Assembly
2		0	0624-0402	2	.250 in., PH Pozidriv Tapping Screw
2		5	09845-04705	1	Right Support Latch
1		3	2360-0370	4	6-32, .375 in., PH Pozidriv Screw
1		6	7120-4930	1	Serial Plate Label
1		5	7120-6167	1	Information Label
1		4	7120-6851	1	Left Center Error Card
1		1	7120-7301	1	Information Card
1		2	7120-7302	1	Syntax Card
1		3	7120-7303	1	Error Card
1		5	7120-7305	1	Option Error Card
			7120-7844	1	9845B Paste on Logo
			7120-7836	1	9845B Paste on Serial Tag
1	A26	8	09845-66526	1	Option 204, 205 and 206 128k-Byte Memory Assembly
1		5	09845-65517	1	Option 311
2		3	5041-1446	1	Graphics ROM Pack
1		3	7120-6834	1	LPU ROM Cap
					Graphics Error Card Label
2		0	7120-7293	1	Graphics ROM Label
1		6	09845-91050	1	Graphics Manual
					Option 312
1		6	09845-65518	1	I/O ROM Pack (LPU)
2		3	5041-1446	1	LPU ROM Cap
2		8	7120-7291	1	I/O ROM Label (LPU)
1		7	09845-65519	1	I/O ROM Pack (PPU)
2		9	5041-1442	1	PPU ROM Cap
2		7	7120-7290	1	I/O ROM Label (PPU)
1		8	09845-92060	1	I/O Manual
			7120-7309	1	Error Card Sticker

Assembly Level	Reference Designator	CD	HP Part No.	TQ	Description
1		4	09845-65516	1	Option 313 Mass Storage ROM Pack
2		9	5041-1442	1	PPU ROM Cap
2		9	7120-7292	1	Mass Storage ROM Label
1		0	09845-92070	1	Mass Storage Manual
			7120-7640	1	Error Card Sticker
					Option 314
1		1	09845-65521	1	Advanced Programming ROM Pack (LPU)
2		3	5041-1446	1	LPU ROM Cap
					Option 540, 541
1	A51	9	09845-66551	1	Control Logic Assembly
1	A55	3	09845-66555	1	Motor Control Assembly
1		9	09845-67905	1	Printer Door
1		5	09845-67951	1	Bucket Assembly (see exploded drawing)
1		8	09845-67954	1	Paper Advance Assembly
1		4	1818-2691	1	Katakana Printer Character ROM
1		1	5040-8145	1	Spacer Plate for Option 541 (Metric Paper Spacer)
					Option 560, 561
1	A51	9	09845-66551	1	Printer Control Logic Assembly
1	A55	3	09845-66555	1	Printer Motor Control Assembly
1		9	09845-67905	1	Printer Door Assembly
1		5	09845-67951	1	Bucket Assembly (see exploded drawing)
1		8	09845-67954	1	Paper Advance Assembly
1		9	1818-2687	1	ASCII Character ROM
1		1	5040-8145	1	Spacer Plate for Option 561 (Metric Paper Spacer)
					Option 600
1		9	09845-01218	1	Cartridge Drive Bracket
1		2	09845-61611	1	T14 Cable from A61 to Cartridge Drive See keyboard parts for other drive parts.
					Option ROMs
			09845-65526		Data Base Management ROM (LPU)
			09845-65527		Data Base Management ROM (PPU)
			09845-65524		Assembly Language Execution
			09845-65525		Assembly Language Development and Execution
			09845-67985		Data Comm
			09845-67986		Data Comm
			98770-65501		98770 Color Graphics

8-8 9845B/C Mainframe Replaceable Parts

Here is a list of the unique Model 200 replaceable parts.

Assembly Level	Reference Designator	CD	HP Part No.	TQ	Description
1			09845-60303	1	Rear Panel Assembly
2			3160-0365	2	Fan
2			7121-1181	1	Serial Number Label
2			9135-0132	1	Line Filter
1			09845-66607	1	Right Hand Card Cage
1	A30		09845-67930	1	Processor Assembly
1	A81		09845-67981	1	Power Supply
2			1600-1057	1	Power Supply Keying Bracket
1			09845-60356	1	PC Hold Down Bracket
1			2200-0103	2	Screws for Hold Down Bracket
1	A46		09845-66546	1	LPU RAM/ROM Assembly (See Table 5-2 for ROM Part Numbers)
			09845-67155		Key switch assembly, w key caps
			09845-68000		Key switch assembly, w/o key caps
			09845-68800		45A kybd assy complete. ASCII. incl. 1 transports
			09845-68805		45B kybd assy complete. ASCII. incl. 2 transports
			09845-68815		45B kybd assy complete. FRENCH. incl. 2 transports
			09845-68825		45B kybd assy complete. SPANISH. incl. 2 transports
			09845-68835		45B kybd assy complete. GERMAN. incl. 2 transports
			09845-68845		45B kybd assy complete. KANA. incl. 1 transports
			09845-68855		45B kybd assy complete. SWD-FIN. incl. 2 transports
			09845-68890		45C kybd assy complete. ASCII. incl. 2 transports
			09845-68891		45C kybd assy complete. FRENCH. incl. 2 transports
			09845-68892		45C kybd assy complete. SPANISH. incl. 2 transports
			09845-68893		45C kybd assy complete. GERMAN. incl. 2 transports
			09845-68894		45C kybd assy complete. KANA. incl. 1 transports
			09845-68895		45C kybd assy complete. SWD-FIN. incl. 2 transports

Print Mechanism Parts

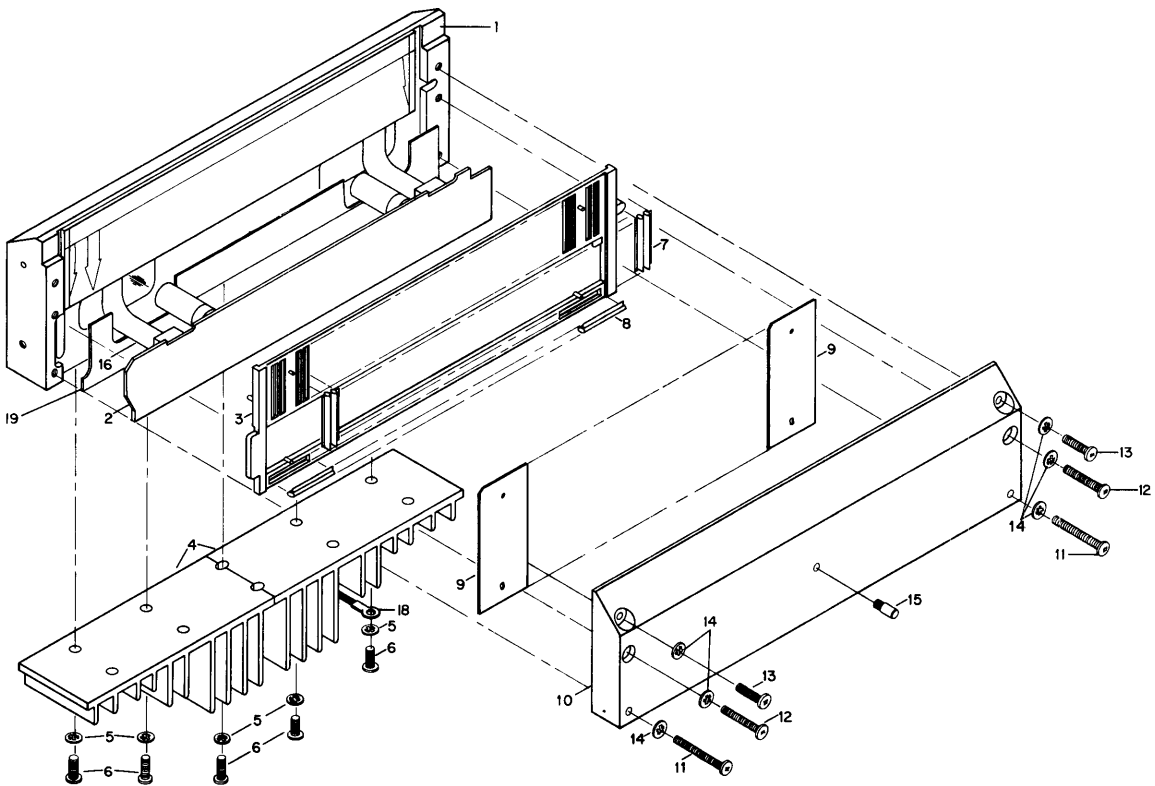

8-10 9845B/C Mainframe Replaceable Parts

Print Mechanism Parts

Assembly Level	Reference Designator	CD	HP Part No.	TQ	Description
			09845-67952		Print Mechanism Assembly (order 09845-67162)
	1		09845-67953	1	Print Head (order 09845-67163)
	2		09845-66553	1	PC Assembly
	3		5040-8239	1	Connector Frame
	4		09845-21101	2	Heat Sink
	5		2190-0011	10	#10 Washer
	6		2680-0099	5	10-32 x .375 Screw
	7		1251-4819	28	Ampliflex Connector, long
	8		1251-4820	7	Ampliflex Connector, short
	9		5061-3020	7	Hybrid Module Chip (order 09845-67161)
	10		09845-01205	1	Module Backing Plate
	11		2510-0115	2	8-32 x 1 Screw
	12		2510-0111	2	8-32 x .750 Screw
	13		2510-0107	2	8-32 x .500 Screw
	14		2190-0009	6	#8 Washer
	15		09845-24704	1	Pivot Pin
	16		8120-2514	2	Cable Assembly
	18		09845-61608	1	Ground Strap
	19		0340-0654	1	Insulator
	20		7120-7642	1	Identification Label

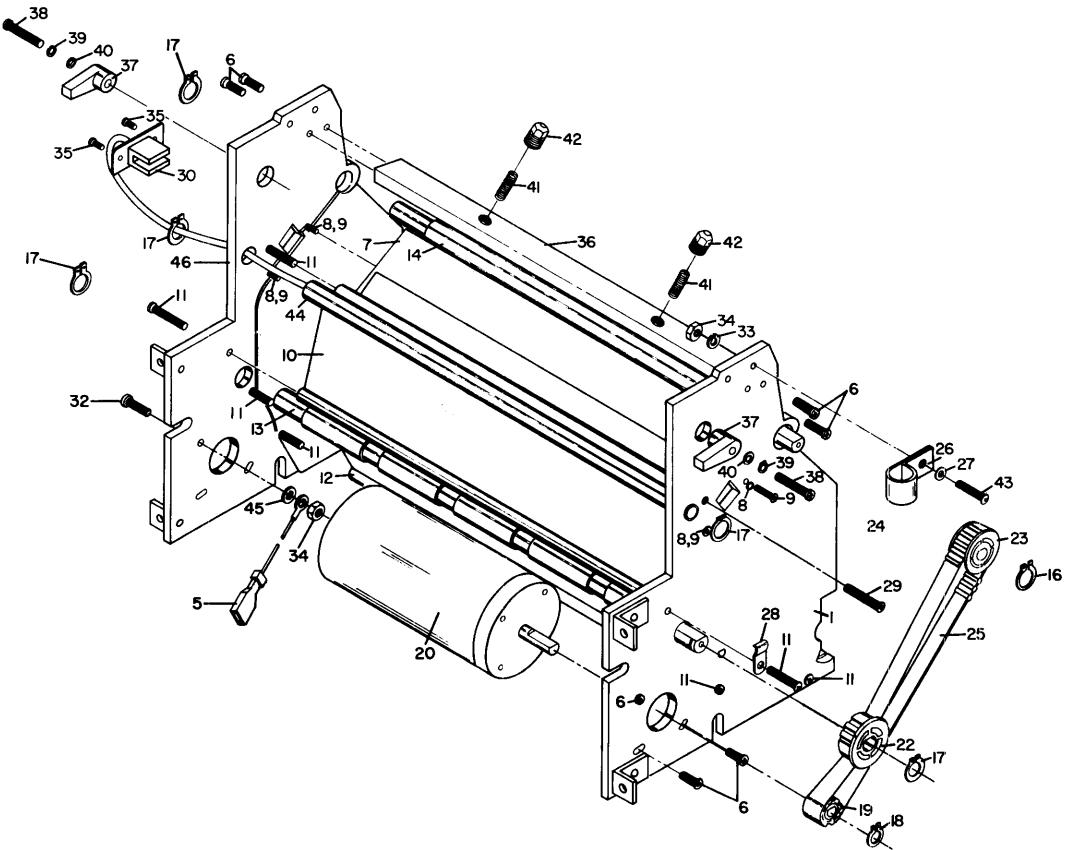

Printer Bucket Parts

8-12 9845B/C Mainframe Replaceable Parts

Printer Bucket Parts

Assembly Level	Reference Designator	CD	HP Part No.	TQ	Description
			09845-67951		Bucket Assembly
1			09845-08800	1	Printer Side Frame/Bearing Assembly (Left)
2			09845-08801	1	Printer Side Frame/Bearing Assembly (Right)
3					Not Assigned
4					Not Assigned
5			N/A	1	Safety Wire
6			2360-0359	7	6-32 x .375 Machine Screw
7			09845-27903	1	Guide
8			2190-0112	4	#2 Lock Washer
9			0520-0130	4	2-56 x .375 Machine Screw
10			09845-27902	1	Front Guide
11			0624-0209	8	6-32 x .750 Tapping Screw
12			09845-27901	1	Rear Guide
13			1530-2025	1	Roller
14			1530-2026	1	Platen
15					Not Assigned
16			0510-0028	2	.375 Retainer Ring
17			0510-0060	4	.375 Grip Retainer Ring
18			0510-0054	1	.250 Grip Retainer Ring
19					Not Assigned
20			09845-08802	1	Printer Motor/Pulley Assembly
21					Not Assigned
22			5040-8143	1	Roller Pulley
23			5060-7463	1	Platen Pulley
24					Not Assigned
25			1500-0494	1	Drive Belt
26			1400-0031	1	Cable Clamp
27			3050-0066	1	#6 Flat Washer
28			1400-0015	1	Wire Clamp
29					Not Assigned
30			09845-67168	1	Paper Sensor
31			09845-01213	1	Sensor Bracket
32			2360-0117	1	6-32 x .375 Machine Screw
33					Not Assigned
34			2420-0001	2	#6 Hex Nut
35			0624-0097	2	4-40 x .188 Tapping Screw
36			09845-21201	1	Load Bar
37			5040-8138	2	Print Head Cam
38			2680-0260	2	10-32 x .812 Machine Screw
39			2190-0034	2	#10 Lock Washer
40			3050-0257	2	#10 Flat Washer
41			1460-0636	2	Load Spring
42			09866-22301	2	Spring Holder
43			2360-0199	1	6-32 x .438 Machine Screw
44			09845-24705	1	Support Wire
45			2190-0007	1	#6 Star Washer
46					Not Assigned

8-14 9845B/C Mainframe Replaceable Parts

PRODUCT	-----FSI, SPARE PARTS-----										--PSP,TOOLS-	
	19845B	19845B	19845B	19845B	19845C	19845C	19845C	198780	19845B	19845C		
OPTION	1XX	1XX	1XX	2XX	1XX	1XX	2XX	ALL	ALL	ALL	ALL	
ALPHA	C	B	A	C	C	A	C	C	D	D	D	
PERCENT	0-80	81-93	94-99	0-80	0-80	81-99	0-80	0-80				
KIT P/N	09845	09845	09845	09845	98770	98770	09845	98780	09845	98770		
	167197	167198	167199	167200	167198	167199	167200	167197	167130	167100		
KIT PARTS:												
09845-65519			1									
-65520				1				1		1		
-65521			1									
09845-66502	1											
-66533			1									
-66544			1									
09845-67155			1									
-67161			1									
-67163			1									
-67168		1										
-67972			1									
09845-69503	1											
-69515	1											
-69516	1											
-69526	1											
-69527		1										
-69528	1											
-69542			1									
-69546								1				
-69551		1										
-69555	1											
-69561	1											
-69573	1											
-69574		1										
-69575	1											
-69577		1										
-69579	1											
-69930								1				
-69962	1											
-69980	1											
-69981								1				
09845-91030										1		
-91031								1		1		1
09845-92041										1		1
-92042										1		
09845-93005										1		1
98440-67901										1		
98770-61601									1			
-61604						1						

	-----FSI, SPARE PARTS-----										-PSP, TOOLS-		
PRODUCT	19845B	19845B	19845B	19845B	19845C	19845C	19845C	198780	19845B	19845C			
OPTION	1XX	1XX	1XX	2XX	1XX	1XX	2XX	ALL	ALL	ALL			
ALPHA	C	B	A	C	C	A	C	C	D	D			
PERCENT	0-80	181-93	194-99	0-80	0-80	181-99	0-80	0-80					
KIT P/N	109845	109845	109845	109845	198770	198770	109845	198780	109845	198770			
	167197	167198	167199	167200	167198	167199	167200	167197	167130	167100			
KIT PARTS:													
98770-61605						1		1					
-61606								1					
-61607													
98770-65501								1					
98770-66502					1								
-66503					1								
-66527													1
98770-67901								1					
98770-69504					1								
-69505						1							
-69506					1								
-69511					1								
-69532					1								
-69534					1								
-69971							1		1				
-69980					1								
98770-90030													1
98775-69504					1								
-69971					1								
98780-26505													
98780-61603									1				
-61604									1				
98780-65501									1				
98780-66511									1				
-66513									1				
98780-67971									1				
98780-69512									1				
-69521									1				
-69531									1				
-69551									1				
98780-90030									0				

9845B/C Mainframe Diagrams

Chapter 9

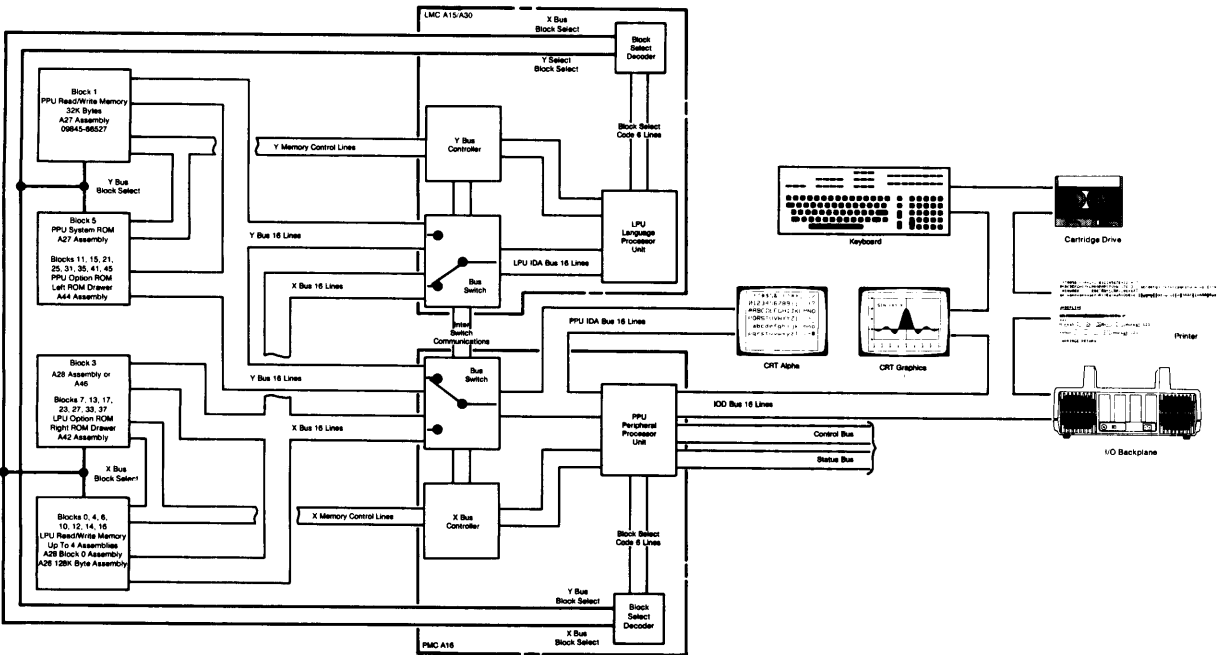

Processor/Memory Control

Memory Map

9845B/C Memory Architecture

- Each address is a 16 bit word (2 bytes).
- Blocks have 32k addresses, or 64k bytes.
- Some blocks don't use all 32k addresses.
- Even blocks (and 1) are RWM.
- Odd blocks (except 1) are ROM.

Here's how this memory map is laid out;

Down the left column:

- Block numbers (octal) and the assembly the memory is in.
- If the memory is standard, an S; if optional, an O.

Across the top:

- Addresses (octal) is 10k/20k ranges across the top.

Data in the map:

- The information in that block/address range of memory. If ROM, it's processor, use and option ROM product number. (N) Numbers in parentheses refer to notes at the end of the map. Empty areas either don't exist or are not presently used.

A complete list of system and option ROMs, with revisions and part numbers is available by listing on the printer, the 9845B/C System Exerciser Tape #2, the ROMREV file starting with line 5190.

Notes (shown in parentheses in memory map)

1. Addresses 0-37 in each block are common processor addresses. RWM and ROM use addresses 000040-177777.
2. This location is ROM for CRT graphics. See parts list for details.
3. More CRT ROM, the parts list shows specifics.
4. These are the keyboard language ROMs, six sets exist for six languages. Refer to parts list for specifics.
5. Two optional graphics ROMs are available,
98411A, for the standard CRT, addresses 030000-047777.
98411B, for enhanced and/or color CRT, addresses 030000-067777.

Special Note on Block 0 RWM Allocations:

- Block 0 contains the following map at execution time,
If no A26 optional RWM assemblies are installed,
Address 177777 Block Descriptor
System RWM
LPU System RWM
Option ROM RWM
Binary Programs Area
Execution Stack
Buffer Space
Program Segments
Value Area
COM System Common
ICOM Assembly Common

Address 000040 CCOM Datacomm Common

If one or more A26 optional RWM assemblies are installed,
Block 0 contains

Address 177777 Block Descriptor
LPU System RWM (approximately 9k bytes)
Option ROM RWM
Binary Programs Stack
Execution Stack

Address 000040 Buffer Space

Highest A26 Block (6, 12, or 16) contains

Address 177777 Block Descriptor
Program Segments
Value Area

COM System Common
ICOM Assembly Common
Address 000040 CCOM Datacomm Common

Mainframe Memory Map

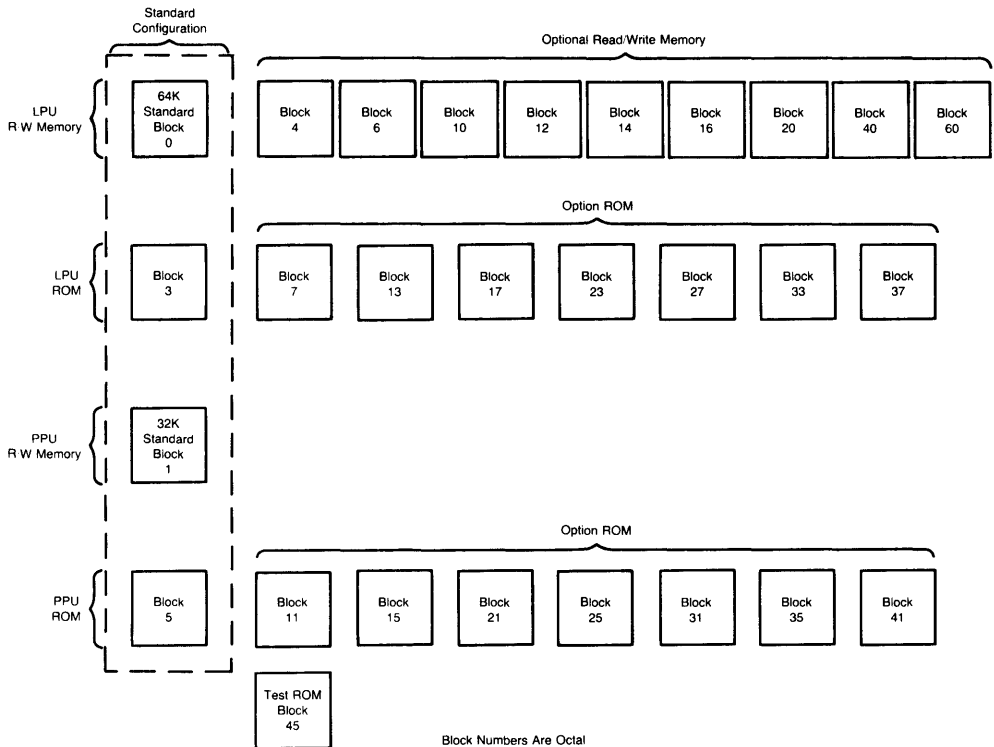

Opt. 1XX Power Supply Block Diagram, A80

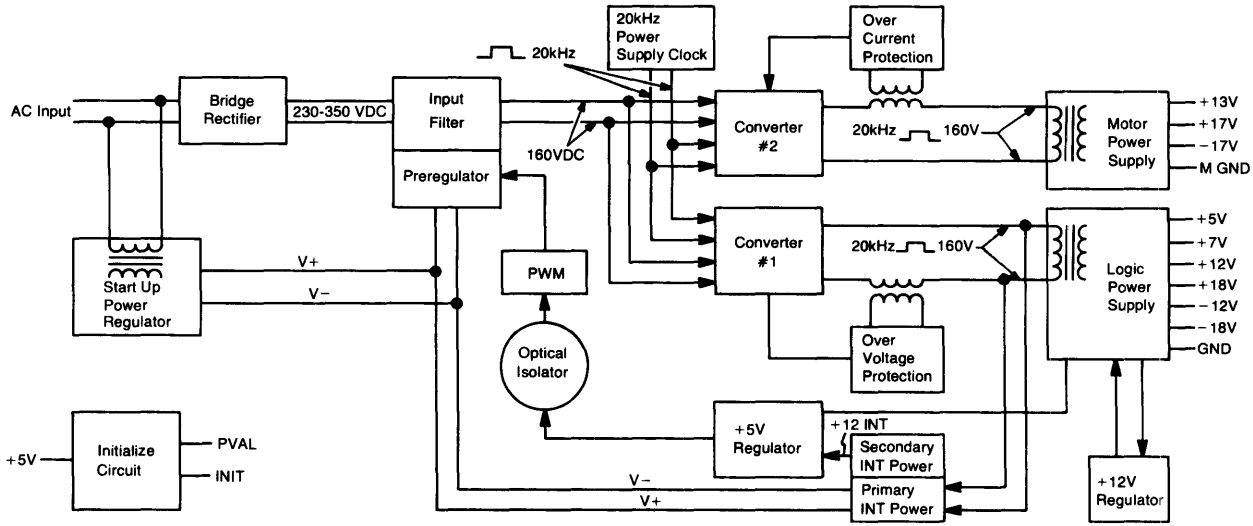

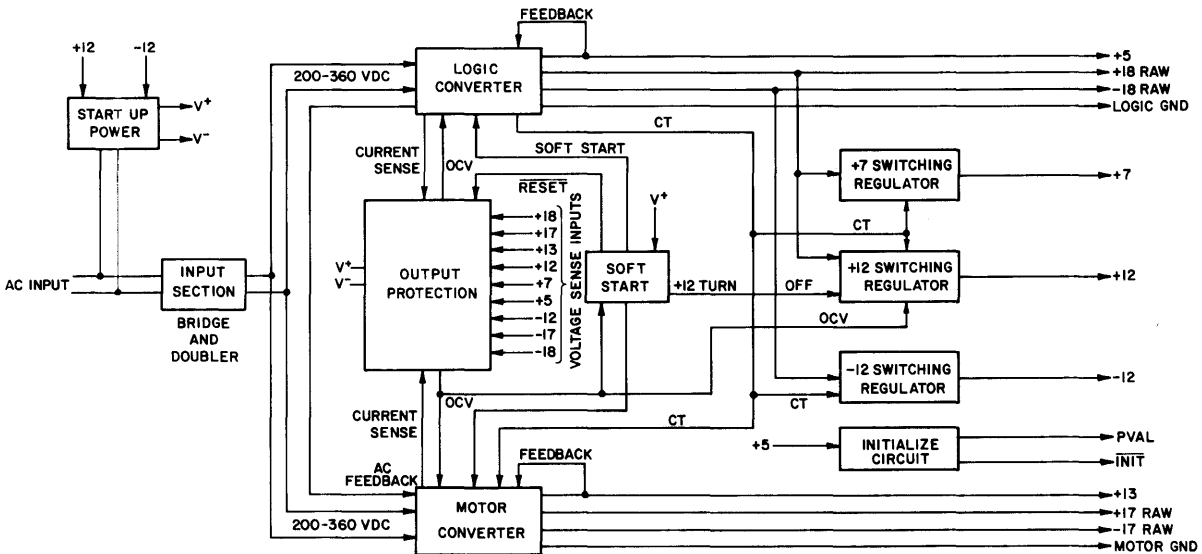

Power Supply Block Diagram, A81

Note

Voltages must be measured with CRT Installed.

9845B/C Opt. 1XX

Mainframe A80 Power Supply Specifications

Voltage	Voltage Tolerance	Maximum Current	Used By
-18V	±1V	.7 amps	CRT
-17V	±1V	.9 amps	Cartridge drive printer motor
-12V	±5%	.85 amps	Processors, external I/O, ROM, RAM, printer, CRT, keyboard
+ 5V	±2%	15 amps	Processors, external I/O, ROM, RAM, tape transport printer CRT, keyboard
+ 7V	±5%	1.3 amps	Processors, ROM, printer
+12V	±3%	5.5 amps	Processors, external I/O, ROM, RAM, cartridge drive printer, CRT
+13V	±1V	3.7 amps	Printhead, printer motor
+17V	±1V	.9 amps	Cartridge drive, printer motor
+18V	±1V	1.1 amps	CRT

9845B/C Opt. 2XX

Mainframe A81 Power Supply Specifications

Voltage	Voltage Tolerance	Maximum Current	Used By
-18V	+ .9V -5V	.8 amp	CRT
-17V	±2V	1.5 amp	Cartridge drive, printer motor
-12V	±.6V	1.0 amp	Processors, external I/O, ROM, RAM, CRT printer, keyboard
+7V	±.3V	1.5 amp	Processors, ROM, printer
+12V	±.6V	6.8 amp	Processors, external I/O ROM, RAM, CRT cartridge drive, printer
+ 5V	+ .35 - .05	30 amp	Logic
+13V	±1V	4.9 amp	Printhead, printer motor
+17V	±2V	1.5 amp	Cartridge drive, printer motor
+18V	-.9V +5V	1.8 amp	CRT

Processor Section

The Processor / Memory Control section consists of:

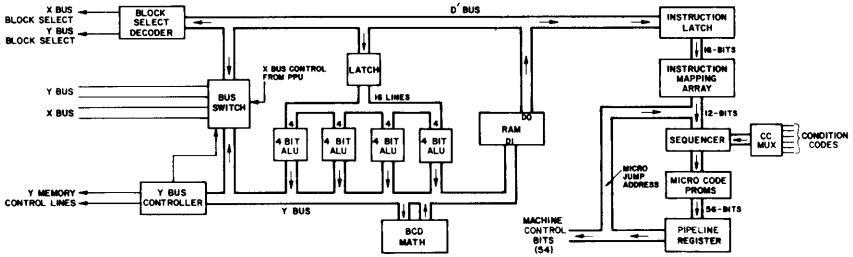
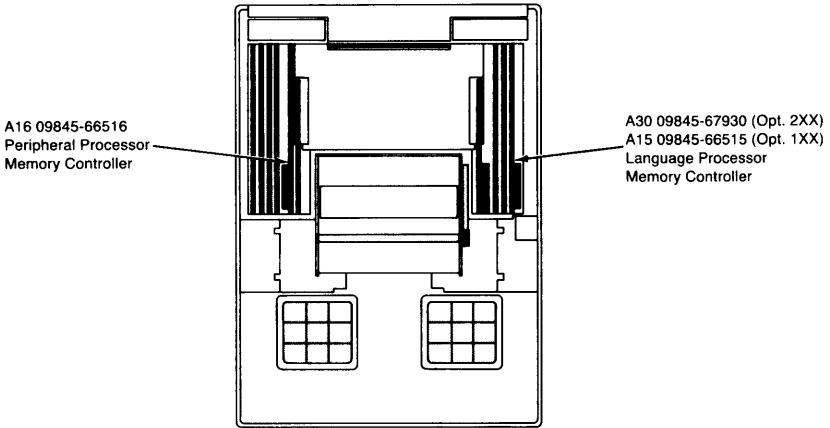

Fast Language Processor Block Diagram, A30

Memory Section

The read/write memory and read-only memory assemblies that make up the memory section are:

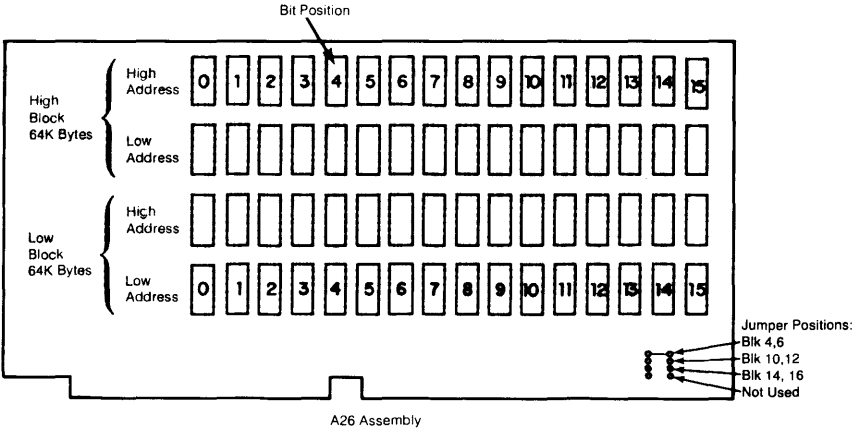
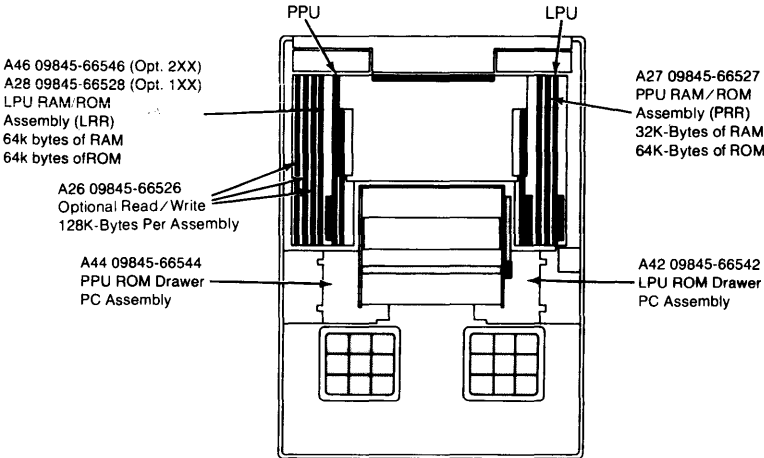

9-10 9845B/C Mainframe Diagrams

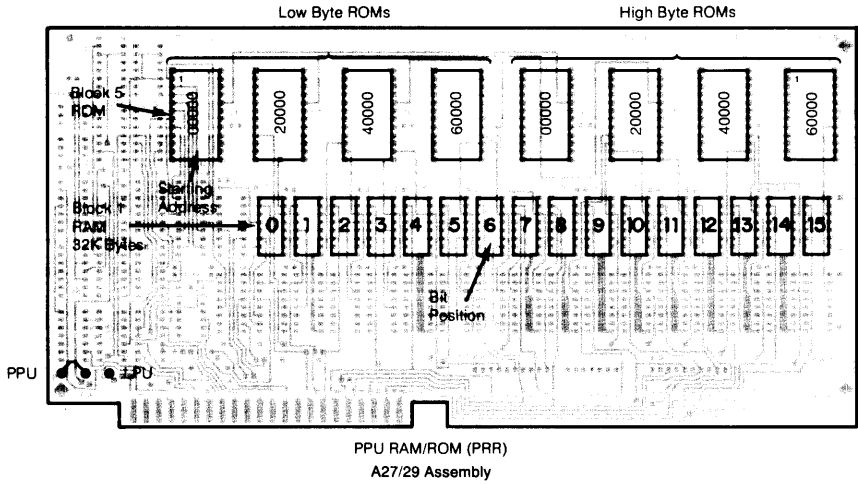

1 These ROMs are different when A27 is used with the 98780A Enhanced Graphics CRT

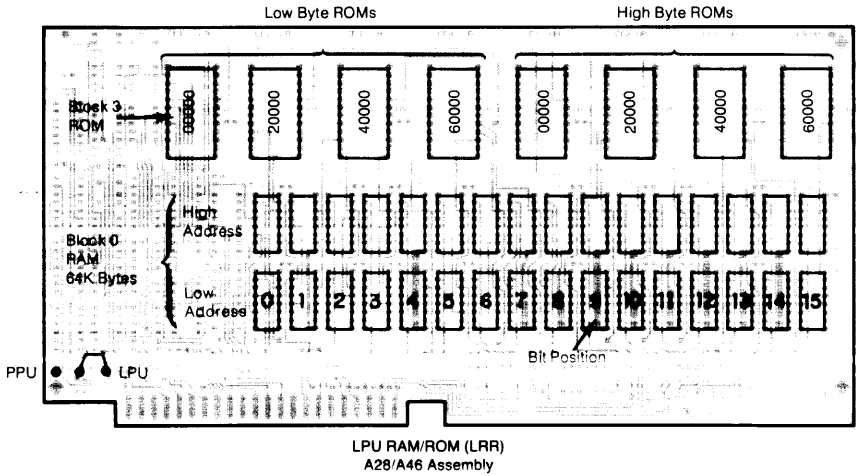

Cartridge Drive Section

The cartridge drive section contains the following assemblies:

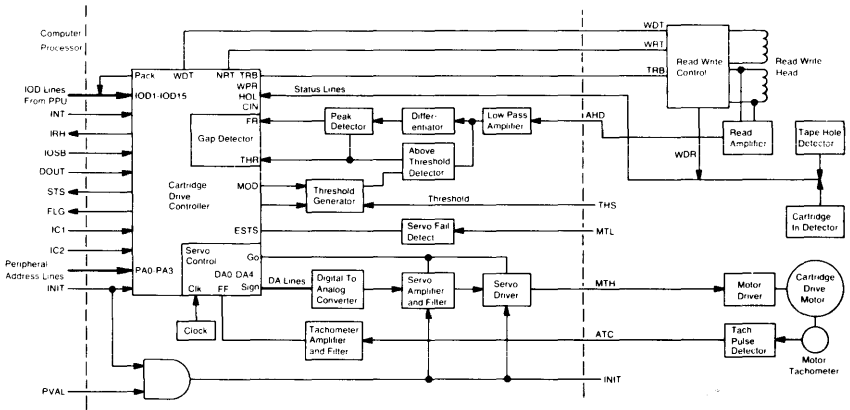
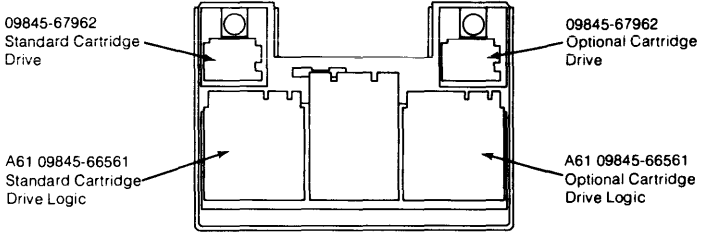

Tape Cartridge Block Diagram

Keyboard Section

The keyboard section is made up of the following assemblies, all of which are attached to the keyboard bezel.

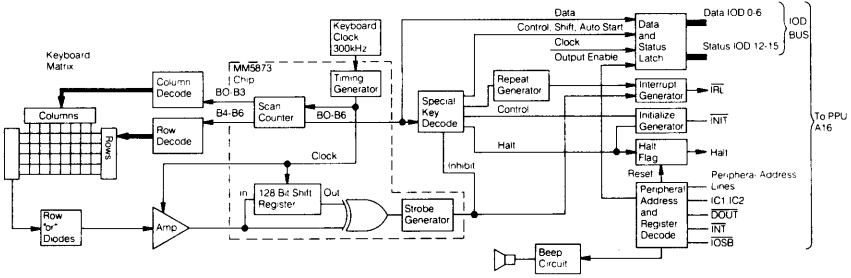
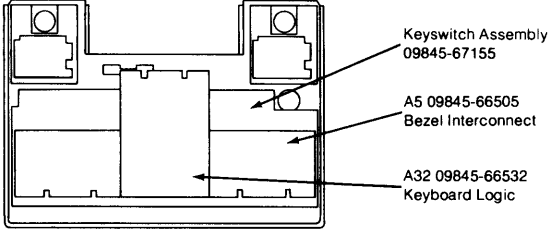

Keyboard Block Diagram

Printer Section

The printer section contains the following assemblies:

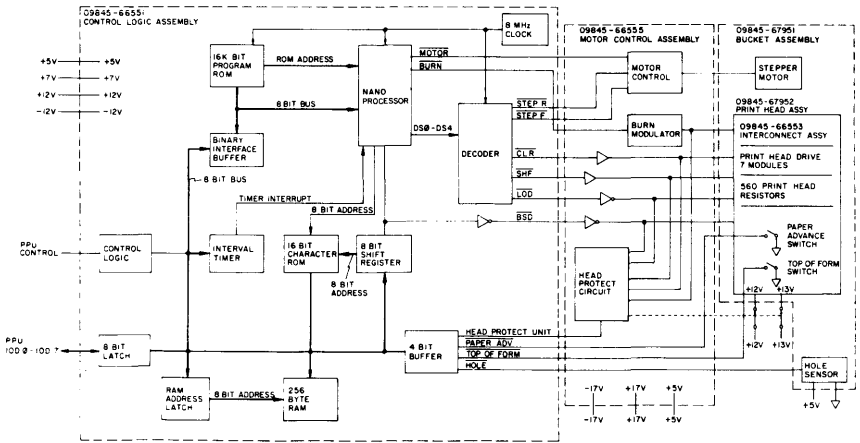
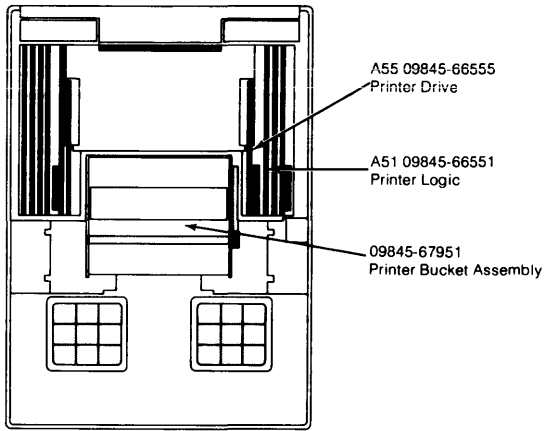

Printer Block Diagram

All key cap part numbers are prefixed by 0371-

Key Cap Part Numbers

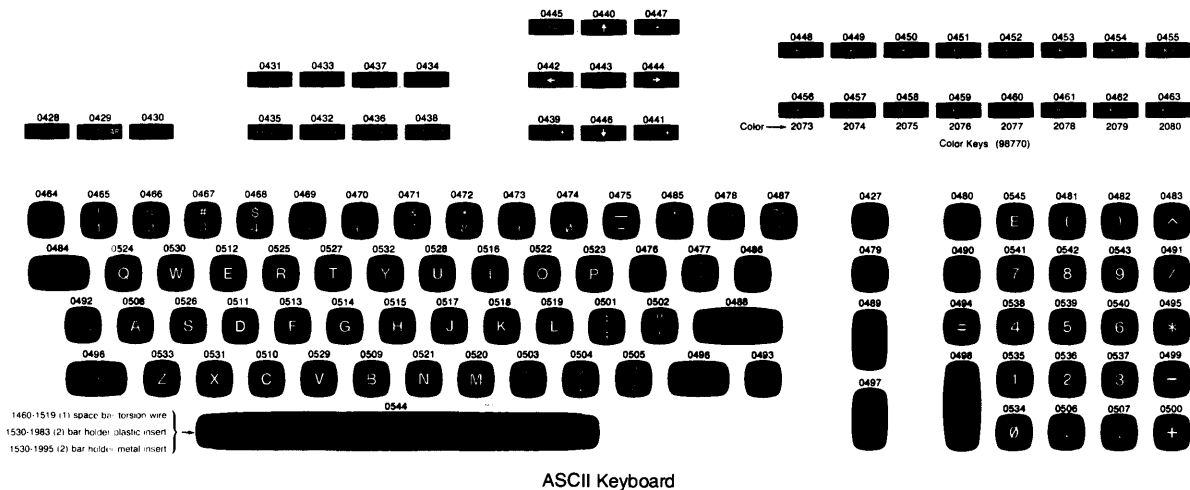

Use these drawings for key cap part numbers and correct key cap locations. Part numbers for all the ASCII keyboard key caps are given. For the other language keyboards, the part numbers for the unique key caps (key caps different from the ASCII keyboard) are given. If no key cap number appears above a particular key cap, refer to the same key on the ASCII keyboard for the part number. The actual position of the key cap on the keyboard (compared to the ASCII keyboard) will vary according to the language.

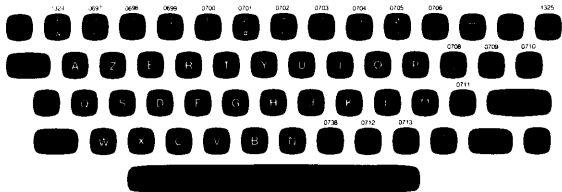

French Keyboard

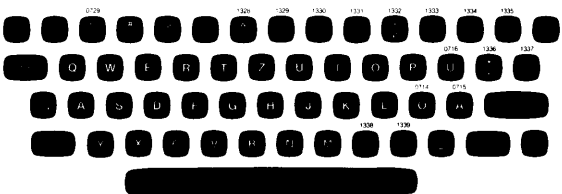
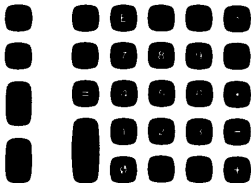

German Keyboard

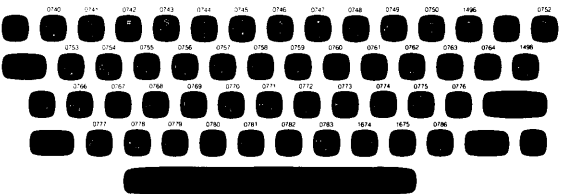
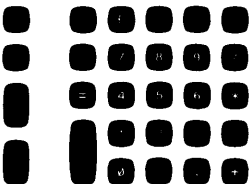

Katakana Keyboard

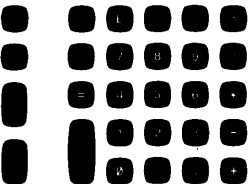

9-16 9845B/C Mainframe Diagrams

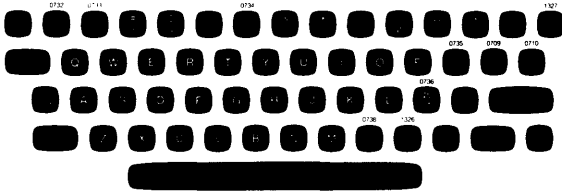

Spanish Keyboard

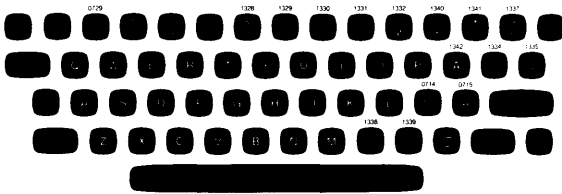
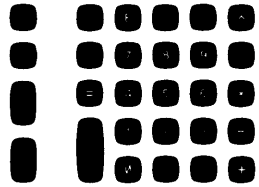

Swedish-Finnish Keyboard

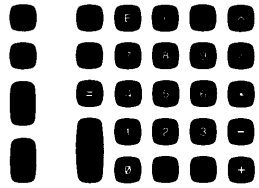

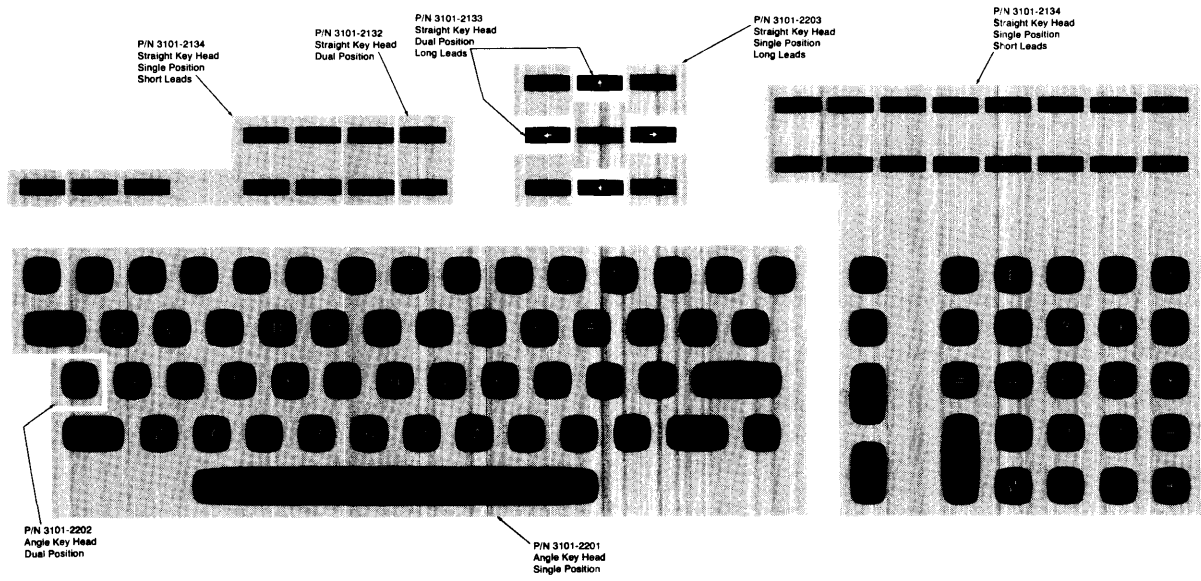

9-18 9845B/C Mainframe Diagrams

9845B/C Mainframe Reference

Chapter

10

9845B/C Manual References

The following table gives some manual part numbers that relate to the 9845B/C desktop computer family. Model numbers of products are listed sequentially on the left and manual titles are across the top.

PRODUCT NUMBER	NAME	SERVICE MANUAL	OPERATING & PROGRAMMING	INSTALLATION NOTE	EXERCISER MANUAL
9845B/C	Mainframe	09845-91030	09845-93000	09845-93005	09845-93005
98401A	150 Upgrade	09845-91030	09845-93000	98401-90000	09845-93005
98402A	100 Upgrade	09845-91030	09845-93000	98401-90000	09845-93005
98403A*	LPU Upgrade	09845-92030	09845-93000	98403-90000	09845-93005
98404A#	CRT Upgrade	98780-90000 98770-90030	09845-93000	98404-90000	09845-93005
98405A	200 Upgrade	(Not a separate product, consists of 98403A and 98404A)			
98750A	Std. CRT	09845-91030	09845-93000	09845-93005	09845-93005
98770A	Color CRT	98770-90030	09845-92051	98771-90000	09845-93005
98771A	C Upgrade	98770-90030	09845-92051	98771-90000	09845-93005
98775A	Light Pen	98770-90030 98780-90030	09845-92051	98771-90000	09845-93005
98776A	RGB Interface	98776-90000	98776-90000	98776-90000	98776-90000
98777A	Camera Atch.	98777-90000	98777-90000	98777-90000	98777-90000
98780A	Enhanced CRT	98780-90000	09845-93000	98404-90000	09845-93005

* NOTE: The fast LPU processor upgrade service manual is Chapter 5 of the 9845B Service Manual, available as a supplement, 09845-92030. This supplement identifies itself as the "Model 200 Mainframe Service Manual Supplement". But it does not contain any data on the 98780A Enhanced Graphics CRT or the mainframe changes to support it.

NOTE: The enhanced graphics upgrade is available only if the 98403A fast processor upgrade is installed. Users wanting to upgrade their 9845 Opt. 1XX to have the 98780A CRT must buy the 98405A combined CRT-LPU upgrade. This is because the 98780A CRT must have the improved power supply (AB1) installed.

Upgrade information is shown under Factory/Field Installed Options, page XXX. Additional information on manuals is shown in the 9845 Price Sheet, 5953-4572.

Error Messages

Mainframe Errors

- 1 Missing ROM or configuration error. Also, check to see if all option ROMs are installed properly.
- 2 Memory overflow; subprogram larger than block of memory. Also check to see if your arrays are too large to fit in memory.
- 3 Line not found or not in current program segment. Check the spelling of line labels and line identifiers.
- 4 Improper return. Branched into the middle of a subroutine.
- 5 Abnormal program termination; no END or STOP statement.
- 6 Improper FOR/NEXT matching.
- 7 Undefined function or subroutine. Check spellings.
- 8 Improper parameter matching. Check the parameter lists in SUB and CALL, and DEF FN and FN statements to see if they match in number and type.
- 9 Improper number of parameters. Check the number of arguments used in an FN or CALL reference.
- 10 String value required.
- 11 Numeric value required.
- 12 Attempt to redeclare variable. Once a variable name has been declared in a DIM, COM, REAL, SHORT or INTEGER statement, it can't be redeclared in that program segment.
- 13 Array dimensions not specified. You must dimension the array, either explicitly or implicitly.
- 14 Multiple OPTION BASE statements or OPTION BASE statement preceded by variable declarative statements.
- 15 Invalid bounds on array dimension or string length in DIM, COM, REAL, SHORT or INTEGER statement. Strings can't be longer than 32 767 characters. The range of array subscripts is -32 767 through 32 767.
- 16 Dimensions are improper or inconsistent; more than 32 767 elements in an array. Check for wrong number of subscripts in an array reference. Check any matrix multiplication for proper sizes.
- 17 Subscript out of range.
- 18 Substring out of range or string too long. Check substring specifiers against length of string.
- 19 Improper value. Check numbers being entered, especially their exponents.
- 20 Integer precision overflow. The range is -32 768 through 32 767.
- 21 Short precision overflow. Short-precision numbers have six significant digits and an exponent in the range -63 through 63.
- 22 Real precision overflow. Full-precision numbers have twelve significant digits and an exponent in the range -99 through 99.
- 23 Intermediate result overflow.
- 24 TAN ($n \cdot \pi/2$), when n is odd.

- 25 Magnitude of argument of ASN or ACS is greater than 1.
- 26 Zero to negative power.
- 27 Negative base to non-integer power.
- 28 LOG or LGT of negative number.
- 29 LOG or LGT of zero.
- 30 SQR of negative number.
- 31 Division by zero; or $X \text{ MOD } Y$ with $Y = 0$.
- 32 String does not represent valid number or string response when numeric data required. Check any use of VAL function and its argument. Check for correct spelling of variable name.
- 33 Improper argument for NUM, CHR\$, or RPT\$ function.
- 34 Referenced line is not IMAGE statement. Check the line identifier in the PRINT USING statement.
- 35 Improper format string.
- 36 Out of DATA. Make sure READ and DATA statements correspond. Use RESTORE if appropriate.
- 37 EDIT string longer than 160 characters. Try using a substring.
- 38 I/O function not allowed. TYP and other I/O functions aren't allowed in any I/O statement like DISP or PRINT. Place the value into a variable.
- 39 Function subprogram not allowed. An FN reference isn't allowed in any I/O statement, or in redim subscripts. Place the value into a variable.
- 40 Improper replace, delete or REN command. SUB and DEF FN can only be replaced by another SUB or DEF FN. They can only be deleted if the rest of the corresponding subprogram is deleted. A renumbering may cause out-of-range line numbers if completed, so an error occurs; check increment value.
- 41 First line number greater than second.
- 42 Attempt to replace or delete a busy line or subprogram. Typically, this is caused by trying to delete an input statement that is still requesting values.
- 43 Matrix not square. The dimensions of an identity matrix or of one used to find an inverse or determinant must be the same size.
- 44 Illegal operand in matrix transpose or matrix multiply. The result matrix can't be one of the operands.
- 45 Nested keyboard entry statements.
- 46 No binary in memory for STORE BIN or no program in memory for SAVE. Check line numbers in SAVE against program in memory.
- 47 Subprogram COM declaration is not consistent with main program. Check number, type and dimensions of variables.
- 48 Recursion in single-line DEF FN function. Only subprograms can be called recursively.
- 49 Line specified in ON declaration not found.
- 50 File number less than 1 or greater than 10.
- 51 File not currently assigned. Execute an ASSIGN statement for the file, or check the accuracy of the file number used.
- 52 Improper mass storage unit specifier. Check the values of the select code, unit code and controller address.

- 53 Improper file name. A file name can have 1-6 characters and can't contain a colon, quote mark, NULL or CHR\$(255).
- 54 Duplicate file name. Choose another name or PURGE the old one.
- 55 Directory overflow. There is a maximum number of files that a mass storage medium can hold. A file will have to be removed to add another.
- 56 File name is undefined. Check the spelling.
- 57 Mass Storage ROM is missing. Check to see that the ROM is installed properly.
- 58 Improper file type. Use LOAD for PROG files, ASSIGN and GET on DATA files and LOADKEY for KEYS files.
- 59 Physical or logical end-of-file found. Attempting to READ# or PRINT# past the end of the file. Compare the data list to the file size.
- 60 Physical or logical end-of-record found in random mode. Compare the data list to the record size.
- 61 Defined record size is too small for data item. You can either PURGE and RE-CREATE the file with longer records or regroup the data being recorded.
- 62 File is protected or wrong protect code specified. Check to see that the protect code is included and spelled properly.
- 63 The number of physical records is greater than 32 767. That's the limit; use something smaller.
- 64 Medium overflow (out of user storage space). A file can't be set up because there isn't enough space. Use another medium or purge unwanted files.
- 65 Incorrect data type. You can't use GET on a DATA file that doesn't contain a program. Use TYP to find out what kind of data the computer is trying to be read.
- 66 Excessive rejected tracks during a mass storage initialization. The medium can't be initialized. If the medium is a flexible disk, use a different one. If the medium is a hard disc, call your HP Sales and Service Office for assistance, to determine whether there has been a hardware failure.
- 67 Mass storage parameter less than or equal to 0. Check values of variables. Record numbers, record lengths and number of defined records must be positive numbers.
- 68 Invalid line number in GET or LINK operation. Check line numbers. May be trying to LINK to file that doesn't contain a program.
- 69 Format switch on the disc off. Turn it on.
- 70 Not a disc interface. Check mass storage unit specifier.
- 71 Disc interface power off. Turn it on.
- 72 Incorrect controller address, controller power off, or disc time out. Check mass storage unit specifier; make sure controller is on.
- 73 Incorrect device type in mass storage unit specifier.
- 74 Drive missing or power off.
- 75 Disc system error, type I¹.
- 76 Incorrect unit code in mass storage unit specifier.
- 77 Disc system error, type II¹.

¹ See the Mass Storage Techniques Manual.

- 78 – 79 Reserved for future use.
- 80 Cartridge out or door open. Also check to see if interface is connected properly.
- 81 Mass storage device failure. Possible power failure.
- 82 Mass storage device not present. Check mass storage unit specifier.
- 83 Write protected. Check the write-protection device on the medium or drive.
- 84 Record not found. There is a bad spot on the medium.
- 85 Mass storage medium is not initialized.
- 86 Not a compatible tape cartridge.
- 87 Record address error; information can't be read. Hardware failure. Check for a dirty read head.
- 88 Read data error. Hardware failure. Check for a dirty read head.
- 89 Check read error.
- 90 Mass storage system error.
- 91 – 99 Reserved for future use.
- 100 Item in print using list is string but image specifier is numeric.
- 101 Item in print using list is numeric but image specifier is string.
- 102 Numeric field specifier wider than printer width.
- 103 Item in print using list has no corresponding image specifier.
- 104 ON KBD or TOPEN not allowed in subprogram.
- 105 – 109 Reserved for future use.
- 110 Plotter type specification not recognized. Check spelling of "GRAPHICS", "9872A" or "INCREMENTAL".
- 111 Plotter has not been specified. Check select codes.
- 112 No graphics hardware installed in the System 45B.
- 113 LIMIT specifications out of range.
- 114 98036 card improperly configured.
- 115 TDISP not allowed unless peripheral keyboard active.
- 116 TOPEN is active on another select code.
- 117 – 149 Reserved for future use.
- 150 Improper select code.
- 151 A negative select code was specified that does not match present bus addressing.
- 152 Parity error.
- 153 Either insufficient input data to satisfy enter list, attempt to ENTER from source into source or enter count exhausted without linefeed.
- 154 Integer overflow, or ENTER count greater than 32 767 bytes or 16 383 words.
- 155 Invalid interface register number. (Can only specify 4-7.)
- 156 Improper expression type in READIO, WRITEIO, or STATUS list.
- 157 No linefeed was found to satisfy / ENTER image specifier, or no linefeed record delimiter was found in 512 characters of input.

10-6 9845B/C Mainframe References

- 158 Improper image specifier or nesting image specifiers more than 4 levels deep.
- 159 Numeric data was not received for numeric enter list item.
- 160 Repetition of input character more than 32 768 times.
- 161 Attempted to create CONVERT table or EOL sequence for source or destination variable which is locally defined in a subprogram.
- 162 Attempted to delete a nonexistent CONVERT table or EOL sequence.
- 163 I/O error, such as interface card not present, device timeout, interface or peripheral failure (Interface FLAG line=0.), stop key pressed or improper interface card type.
- 164 Transfer type specified is incorrect type for interface card.
- 165 A FHS or DMA transfer with no format specifies a count that exceeds the size of the variable, or an image specifier indicates more characters than will fit in the specified variable.
- 166 A NOFORMAT FHS or DMA type transfer does not start on an odd numbered character position, such as A\$[3].
- 167 Interface status error, TRL Character or an EOI was received on an HP-IB Interface before ENTER list or image specification was satisfied.
- 168 – 183 Reserved for future use.
- 184 Improper argument for OCTAL or DECIMAL function or assembled location.
- 185 Break Table overflow.
- 186 Undefined BASIC label or subprogram name used in IBREAK statement.
- 187 Attempt to write into protected memory; or, attempt to execute instruction not in ICOM region.
- 188 Label used in an assembled location not found.
- 189 Doubly-defined entry point or routine.
- 190 Missing ICOM statement.
- 191 Module not found.
- 192 Errors in assembly.
- 193 Attempt to move or delete module containing an active interrupt service routine.
- 194 IDUMP specification too large. Resulting dump would be more than 32 768 elements.
- 195 Routine not found.
- 196 Unsatisfied externals.
- 197 Missing COM statement.
- 198 BASIC's common area does not correspond to assembly module requirements.
- 199 Insufficient number of BASIC COM items.
- 200 – 206 Reserved for future use.
- 207 Binaries not allowed in LOAD SUB file. Do LOAD, SAVE, SCRATCH A, GET and STORE on the file to get rid of binaries. However, the loaded program may not run after the binaries are removed.
- 208 Volume not mounted. Mount it and execute a VOLUME DEVICES ARE statement.

- 209 Operation not allowed on tape. Only the BKUP file used in DBBACKUP and DBRECOVER is allowed on tape.
- 210 Bad status array. It must be defined as integer precision with ≥ 10 elements. Check spelling and current size.
- 211 Improper data base specified or data base not open. Improper name, or performing data base operation with invalid name.
- 212 Data set not found. Check set name or number and make sure it is on the volume specified in the schema.
- 213 Reserved for future use.
- 214 Data base requires creation. Perform a DBCREATE.
- 215 – 217 Reserved for future use.
- 218 Volume name not part of data base. Check spelling.
- 219 Out of available memory for a DBOPEN, DBBACKUP or DBRECOVER. Out of read/write memory if executed from main program. Out of special area if executed from subprogram, so perform the DBOPEN in the main program.
- 220 Improper or illegal use of maintenance word. Check spelling and leading or trailing blanks.
- 221 Data set not created.
- 222 Reserved for future use.
- 223 Improper backup file. In DBRECOVER, backup file has incorrect information in header or no primary DBBACKUP/RECOVER currently in progress (for secondary operation).
- 224 Incomplete backup file. More than one volume in backup; probably mounted in the wrong order. Start the recovery over.
- 225 Improper utility version number in root file. Rerun Schema Processor to generate new root file.
- 226 Corrupt data base – must purge and redefine. Purge root file and run Schema Processor.
- 227 Corrupt data base – all sets require erasure.
- 228 Data sets cannot be re-created without root file.
- 229 Operation not allowed while DBOPEN current. Perform a DBCLOSE mode 1.
- 230 Improper set list in DBBACKUP, DBCREATE, DBERASE, DBPURGE or duplicate sets in the set list.
- 231 – 232 Reserved for future use.
- 233 Required data set root file not mounted. Mount it and perform a VOLUME DEVICES ARE.
- 234 Referenced line not a PACKFMT statement. Make sure line identifier is correct and that it references a PACKFMT statement.
- 235 Reserved for future use.
- 236 Insufficient length in a PACK statement, or insufficient current length in an UNPACK. Insufficient length in a DBBACKUP or DBRECOVER statement.
- 237 List length $> 32\,767$ in PACK or UNPACK. Array in PACKFMT too large. Make sure it is the correct variable; redimension if necessary.
- 238 Numeric conversion error. Improper real number found. Check PACKFMT to make sure a REAL or SHORT variable, not INTEGER is being unpacked.

10-8 9845B/C Mainframe References

- 239 UNPACK requires a source string of greater length.
- 240 – 299 Reserved for future use.
- 300 CCOM area not allocated
- 301 Not allowed when channel is active
- 302 CMODEL statement required
- 303 Not allowed when trace is active
- 304 Too many characters in CWRITE
- 305 New CCOM size not allowed when channel is active
- 306 98046 card failure
- 307 Insufficient CCOM allocation
- 308 Illegal character in CWRITE of non-TRANSPARENT data
- 309 Not allowed for this CMODEL
- 310 CCONNECT statement required
- 311 Not allowed while Data Comm is suspended
- 312 Improper CSTATUS array
- 313 – 329 Reserved for future use.
- 330 Lexical table size exceeds array size.
- 331 Improper pointer array¹.
- 332 Non-existent dimension specified in MAT REORDER.
- 333 Pointer array contains out-of-range subscript value.
- 334 Pointer array length does not equal number of records.
- 335 Pointer array is not one-dimensional.
- 336 Number of records (plus twice the number of secondary keys plus twice the number of substrings) exceeds 16 383.
- 337 Subscript extends beyond dimensioned maximum length.
- 338 Subscript out-of-range in key specifier.
- 339 Starting location is an out-of-range subscript value.
- 340 Lexical table is too small to include all characters.
- 341 Main lexical table length plus mode section length does not equal specified table length.
- 342 Array is not one-dimensional or is not integer.
- 343 Lexical mode section pointer out-of-range.
- 344 Lexical table length exceeds 16 383.

¹ This error occurs when data is lost in the process of reordering the array. If this error does not occur, it does not necessarily imply that the pointer array contains a permutation.

System Error octal number; octal number

This error indicates a malfunction in the machine's firmware system. Contact your Sales and Service Office.

I/O Device Errors

Two error messages can occur when attempting to direct an operation to an I/O device that is not ready for use. A printer which is out of paper or no device at a specified select code are examples. The first message that appears is –

```
I/O ERROR ON SELECT CODE select code
```

If the condition is not corrected, the machine beeps intermittently and the following message replaces the first –

```
I/O TIMEOUT ON SELECT CODE select code
```

The I/O device can be made usable by correcting the error (loading paper, or changing the select code, for example), then executing the READY# command –

```
READY# select code
```

This command readies the I/O device and the operation which was attempted is attempted again. The select code must be specified by an integer.

If you get an I/O error on select code 0 and the printer is not out of paper, call your Sales and Service Office.

In some cases, such as an interface which is not connected, READY# for that select code may not solve the I/O error. In this case, STOP should be pressed to regain control of the computer. Be sure to turn the power off before inserting an interface. After the problem is remedied, the operation or program can be tried again.

If you get an I/O error and you have an ON KBD statement in effect, you must press STOP to gain control of the computer. Otherwise, the READY# command will be trapped by ON KBD.

CSTATUS Element 0 Errors

10	Timeout before connection
11	Clear to Send line false or missing clock
100	Channel MEMLIMIT overflow
101	Illegal protocol from remote
102	Input buffer overflow
103	Internal buffer overflow
104	Autodisconnect forced
105	RETRIES count exceeded
106	NOACTIVITY timeout
200	98046 buffer overflow

Assembly-Time Errors

DD	Doubly-defined label
EN	END instruction missing; or module name does not match.
EX	Expression evaluation error.
LT	Literal pools full or out of range.
MO	ICOM region overflow.
RN	Operand out of range.
SQ	Argument declaration pseudo-instruction out of sequence.
TP	Incorrect type of operand used.
UN	Undefined symbol.
900 – 999	Reserved for user.

IMAGE Status Errors

The following are possible values and meanings of the condition word (first element of the status array). After an error, the status array is as follows –

Element	Description
1	Condition word is non-zero
2-4	No change
5	DBOPEN mode
6	Statement identification number
7	Program line number
8	0
9	Value of the mode parameter
10	Integer-for system use only

Each statement has an identification number.

Number	Statement
401	DBOPEN
402	DBINFO
403	DBCLOSE
404	DBFIND
405	DBGET
406	DBUPDATE
407	DBPUT
408	DBDELETE

Condition

Word Value Error Description

0	Successful execution – no error
-1	Improper data base name; already have read/write access to the data base
-10	You may not open additional data bases; five are already opened
-11	Bad data base name or preceding blanks missing. Don't change the first two characters. Data base may not be open.
-14	DBPUT, DBDELETE and DBUPDATE not allowed in DBOPEN mode 8

- 21 Bad password – grants access to nothing or not to that set. Check spelling. Data item, data set, or volume nonexistent or inaccessible. Check spelling and DBOPEN password. Volume references must be numeric for DBINFO.
- 22 Detail data set required
- 23 You lack write access to this data set
- 24 DBPUT or DBUPDATE not allowed on Automatic Master. Check correctness of set reference.
- 31 Improper mode in data base statement. DBGET mode 5 bad – specified data set lacks chains
- 52 Item specified is not an accessible key item in the specified set. Bad @ parameter — must be "@i" or "@ " or "@".
- 74 Root file name in disc directory and name in root file are different. Make sure root file not moved or renamed.
- 91 Root file version not compatible with current IMAGE/45 statements. Incorrect version of Schema Processor used.
- 92 Data base requires creation
- 94 Data or structure information lost. Data base must be erased or redefined.
- 95 Cannot DBOPEN while a DBBACKUP or DBRECOVER is going on.
- 11 End of file on serial DBGET: no entries following the current record.
- 12 Negative record number on directed DBGET. Check record number and spelling.
- 13 Record number greater than capacity on directed DBGET. Check record number and spelling.
- 15 End of chain encountered
- 16 The data set is full
- 17 No current record or the current record is empty; make sure that a current record is defined for this set. There is no chain for the key item value. There is no entry with the specified key value
- 18 Broken chain. Must UNLOAD the data base.
- 41 DBUPDATE will not alter a key item. Make sure correct key item values are in the correct places in the buffer string.
- 43 Duplicate key item value in master not allowed.
- 44 Can't delete a Master entry with non-empty detail chains
- 50 Buffer string is too small for requested data. Redimension if necessary.
- 53 Argument parameter type incompatible with key field type (DBGET, mode 7 or DBFIND) or current length of string argument is less than the string length of the key item value.
- 80 Data set's volume is not on line; or set not created.
- 94 Corrupt data base successfully opened in mode 8
- 1xx There is no chain head for path xx
- 3xx The automatic master for path xx is full
- 4xx The master data set for path xx is not on-line (Applies to DBPUT and DBDELETE for detail data sets)
- 500 Root file volume isn't mounted.
- 5xx Needed volume on-line: created data set xx isn't there

ASCII Character Codes

ASCII Char	EQUIVALENT FORMS				ASCII Char	EQUIVALENT FORMS				ASCII Char	EQUIVALENT FORMS				ASCII Char	EQUIVALENT FORMS			
	Binary	Oct	Hex	Dec		Binary	Oct	Hex	Dec		Binary	Oct	Hex	Dec		Binary	Oct	Hex	Dec
NULL	00000000	000	00	0	space	00100000	040	20	32	@	01000000	100	40	64	`	01100000	140	60	96
SOH	00000001	001	01	1	'	00100001	041	21	33	A	01000001	101	41	65	a	01100001	141	61	97
STX	00000010	002	02	2	''	00100010	042	22	34	B	01000010	102	42	66	b	01100010	142	62	98
ETX	00000011	003	03	3	#	00100011	043	23	35	C	01000011	103	43	67	c	01100011	143	63	99
EOT	00000100	004	04	4	\$	00100100	044	24	36	D	01000100	104	44	68	d	01100100	144	64	100
ENQ	00000101	005	05	5	%	00100101	045	25	37	E	01000101	105	45	69	e	01100101	145	65	101
ACK	00000110	006	06	6	&	00100110	046	26	38	F	01000110	106	46	70	f	01100110	146	66	102
BELL	00000111	007	07	7	'	00100111	047	27	39	G	01000111	107	47	71	g	01100111	147	67	103
BS	00001000	010	08	8	(00101000	050	28	40	H	01001000	110	48	72	h	01101000	150	68	104
HT	00001001	011	09	9)	00101001	051	29	41	I	01001001	111	49	73	i	01101001	151	69	105
LF	00001010	012	0A	10	*	00101010	052	2A	42	J	01001010	112	4A	74	j	01101010	152	6A	106
VT	00001011	013	0B	11	+	00101011	053	2B	43	K	01001011	113	4B	75	k	01101011	153	6B	107
FF	00001100	014	0C	12	,	00101100	054	2C	44	L	01001100	114	4C	76	l	01101100	154	6C	108
CR	00001101	015	0D	13	-	00101101	055	2D	45	M	01001101	115	4D	77	m	01101101	155	6D	109
SO	00001110	016	0E	14	.	00101110	056	2E	46	N	01001110	116	4E	78	n	01101110	156	6E	110
SI	00001111	017	0F	15	/	00101111	057	2F	47	O	01001111	117	4F	79	o	01101111	157	6F	111
DLE	00010000	020	10	16	0	00110000	060	30	48	P	01010000	120	50	80	p	01110000	160	70	112
DC1	00010001	021	11	17	1	00110001	061	31	49	Q	01010001	121	51	81	q	01110001	161	71	113
DC2	00010010	022	12	18	2	00110010	062	32	50	R	01010010	122	52	82	r	01110010	162	72	114
DC3	00010011	023	13	19	3	00110011	063	33	51	S	01010011	123	53	83	s	01110011	163	73	115
DC4	00010100	024	14	20	4	00110100	064	34	52	T	01010100	124	54	84	t	01110100	164	74	116
NAK	00010101	025	15	21	5	00110101	065	35	53	U	01010101	125	55	85	u	01110101	165	75	117
SYNC	00010110	026	16	22	6	00110110	066	36	54	V	01010110	126	56	86	v	01110110	166	76	118
ETB	00010111	027	17	23	7	00110111	067	37	55	W	01010111	127	57	87	w	01110111	167	77	119
CAN	00011000	030	18	24	8	00111000	070	38	56	X	01011000	130	58	88	x	01111000	170	78	120
EM	00011001	031	19	25	9	00111001	071	39	57	Y	01011001	131	59	89	y	01111001	171	79	121
SUB	00011010	032	1A	26	:	00111010	072	3A	58	Z	01011010	132	5A	90	z	01111010	172	7A	122
ESC	00011011	033	1B	27	;	00111011	073	3B	59	[01011011	133	5B	91	[01111011	173	7B	123
FS	00011100	034	1C	28	<	00111100	074	3C	60	\	01011100	134	5C	92	\	01111100	174	7C	124
GS	00011101	035	1D	29	=	00111101	075	3D	61]	01011101	135	5D	93]	01111101	175	7D	125
RS	00011110	036	1E	30	>	00111110	076	3E	62	^	01011110	136	5E	94	^	01111110	176	7E	126
US	00011111	037	1F	31	?	00111111	077	3F	63	_	01011111	137	5F	95	_	01111111	177	7F	127

9845B/C Mainframe Service Notes

Chapter

11

Service Notes will be published in **Support Update**. They are printed in reduced size for placing in this binder. Remove them from the **Support Update**, punch them and place them behind this page.

How to Punch the Service Notes

A problem arises in that six-hole punches are not widely available. The Service Notes may either be punched with a hand punch, or a three-hole punch may be adjusted to punch the Handbook pattern.

To modify a three-hole punch to punch the Handbook hole pattern, follow these directions:

1. Most punches have an inch scale to position the individual punches. This scale has zero in the middle, and increases to the left and right. Move the individual punches to the $1\frac{7}{8}$, $2\frac{5}{8}$ and $3\frac{3}{8}$ positions. The punches can be on either the left or the right (or any combination) as long as each number has a punch on it.
2. Center the page to be punched on the scale. That is, put the left edge on the same number on the left scale as the right edge is on the right scale. For an $8\frac{1}{2}$ inch page this will be $4\frac{1}{4}$.
3. Punch the page, then turn it over, center it and punch it a second time.

Service Notes (continued)