

## Installation Manual *for the Model 16 Computer*



# Installation Manual

*for the Model 16 Computer*

Manual Part No. 09816-90000

© Copyright Hewlett-Packard Company, 1982

This document refers to proprietary computer software which is protected by copyright. All rights are reserved. Copying or other reproduction of this program except for archival purposes is prohibited without the prior written consent of Hewlett-Packard Company.

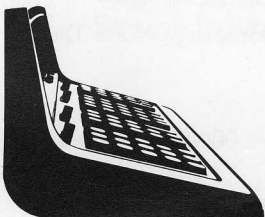

Hewlett-Packard Desktop Computer Division  
3404 East Harmony Road, Fort Collins, Colorado 80525

## Printing History

New editions of this manual will incorporate all material updated since the previous edition. Update packages may be issued between editions and contain replacement and additional pages to be merged into the manual by the user. Each updated page will be indicated by a revision date at the bottom of the page. A vertical bar in the margin indicates the changes on each page. Note that pages which are rearranged due to changes on a previous page are not considered revised.

The manual printing date and part number indicate its current edition. The printing date changes when a new edition is printed. (Minor corrections and updates which are incorporated at reprint do not cause the date to change.) The manual part number changes when extensive technical changes are incorporated.

September 1982...First Edition

### FEDERAL COMMUNICATIONS COMMISSION RADIO FREQUENCY INTERFERENCE STATEMENT (U.S.A. ONLY)

The Federal Communications Commission (in Subpart J of Part 15, Docket 20780) has specified that the following notice be brought to the attention of the users of this product.

The HP Model 16 Computer generates and uses radio frequency energy and if not installed and used properly, that is, in strict accordance with the manufacturer's instructions, may cause interference to radio and television reception. It has been type tested and found to comply with the limits for a Class B computing device in accordance with the specifications in Subpart J of Part 15 of FCC Rules, which are designed to provide reasonable protection against such interference in a residential installation. However, there is no guarantee that interference will not occur in a particular installation. If this equipment does cause interference to radio or television reception, which can be determined by turning the equipment off and on, the user is encouraged to try to correct the interference by one or more of the following measures:

- reorient the receiving antenna
- relocate the computer with respect to the receiver
- move the computer away from the receiver
- plug the computer into a different outlet so that computer and receiver are on different branch circuits.

If necessary, the user should consult the dealer or an experienced radio/television technician for additional suggestions. The user may find the following booklet prepared by the Federal Communications Commission helpful:

*How to Identify and Resolve Radio-TV Interference Problems*

This booklet is available from the U.S. Government Printing Office, Washington, D.C. 20402, Stock No. 004-000-00345-4.

# Table of Contents

## Chapter 1: Unpacking and Set Up

Introduction .....	1
Unpacking Your Computer.....	1
The Computer Components.....	2
Setting Up Your Computer.....	4
1. Position the Computer .....	4
2. Attach the Keyboard .....	4
3. Check the Line Voltage Switch .....	4
4. Check the Fuse .....	4
5. Set the Switches.....	5
Setting the RAM Starting Address .....	6
Setting Datacomm Line Control Switches .....	6
Third Set of Switches .....	6
6. Connect the Power Cord .....	8
7. Turn the Computer On.....	9
8. Insert Additional Read/Write Memory.....	10
9. Install an Interface Card .....	12
10. Install ROMs.....	12
11. Connect Peripheral Devices.....	12
12. Attach the Pascal Key Label.....	12

## Chapter 2: Loading an Operating System

Introduction .....	13
Default Procedure .....	14
If No Operating Systems Are Connected .....	16
If There's Not Enough Memory.....	16
Overriding the Default Selection .....	17
Choosing A System Without the Menu.....	18
Special Keys.....	19
The CTRL-C Key .....	19
The ENTER Key .....	19
The RESET Key .....	20
Loading Using a Remote Terminal .....	20

## Chapter 3: Self-Test and Repair

Introduction .....	21
Self-Test Messages .....	22
Status Messages.....	22
Error Messages .....	22
Self-Test Looping .....	24
Configuration Errors .....	24
Service Information.....	25

**Appendix A: Datacomm Specifications**

Introduction .....	A-1
Mechanical Characteristics .....	A-1
Electrical Characteristics .....	A-2
Pin Functions .....	A-4

**Appendix B: LED Status and Error Codes**

Status Codes .....	B-1
Error Codes .....	B-2

# Chapter 1

## Unpacking and Set Up

### Introduction

Your Model 16 Computer is a flexible, powerful, and easy-to-operate machine. It supports a number of programming languages and operating systems, and has the capacity to link up to diverse peripheral devices. It is small enough to fit on your desk, thus living up to the name "Desktop Computer". Also, its movable keyboard allows you to choose a comfortable working position.

This manual describes how to configure a Model 16 for your particular application. This includes setting switches, inserting memory boards and interface cards, interpreting the results of the computer's self-test, and loading an operating system or programming language. Once you've loaded an operating system or programming language, refer to the Getting Started information supplied with the operating system or language for further instructions.

The Model 16 is a member of the HP Series 200 family of Personal Technical computers. We also refer to the Model 16 as the HP 9816 Computer. Other Series 200 computers include the Model 26 (HP 9826) and the Model 36 (HP 9836). All Series 200 computers use the same operating systems and programming languages, allowing you to develop programs on one machine and run them on other computers in the series. The manuals supplied with your programming language, operating system or applications program explain any operational differences between Series 200 computers.

### Unpacking the Computer

Your HP computer was thoroughly tested and inspected before being shipped to you. All equipment should be in good working order. After removing the computer from its carton, carefully check it and the accessories for any damage caused by transit. You should also check the accessories against the packing list supplied. Notify your HP sales office if any damage is found. Also file a claim with the carrier. If any items are missing, use the enclosed reply card to order the item(s) directly from the factory. Be sure to save the shipping carton in case the computer needs to be returned for repair.

## 2 Unpacking and Set Up

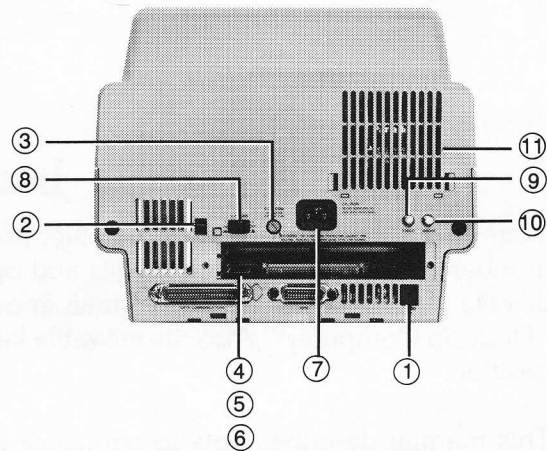
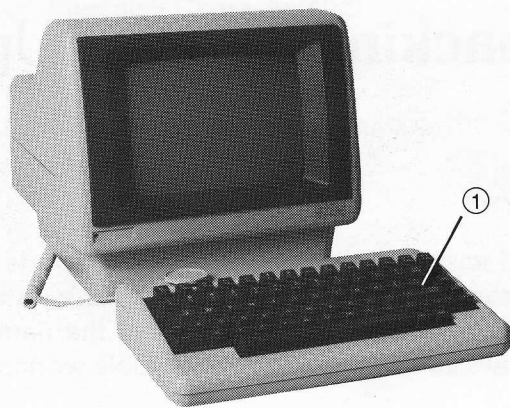

### (1) Keyboard and Connector

The computer keyboard comes as a separate component that plugs into the back of the CRT unit. Most key functions are defined when the operating system is loaded.

### (2) Voltage Switch

The computer is designed to run at either 90-125 Vac or 198-250 Vac. The line frequency can be set to either 50 Hz or 60 Hz.

### (3) The Fuse

You must have the correct fuse inserted for the computer to run.

### (4) The CPU Board

This is the brains of the computer. It performs all mathematical operations and regulates the activities of all internal and external devices. The CPU board also contains RAM (Read/Write Random Access Memory) and the Boot ROM (Read-Only Memory). The Boot ROM is discussed in Chapter 2 of this manual.

### (5) Switches

There are three sets of switches on the CPU board. They are used to specify the starting address of RAM and various parameters for the datacomm and HP-IB interfaces.

### (6) Self-Test Status Lights

The self-test status lights to the right of the switches are used by the computer to report self-test errors and status. These topics are discussed in Chapter 3 of this manual.

### (7) Power Socket

The three-pronged power socket is especially designed for an HP power cord. The power cord should be in the same carton that the computer came in.

### (8) Power Switch

This is the switch you should use to turn power ON and OFF. Never unplug or plug in the computer with the power switch turned ON.

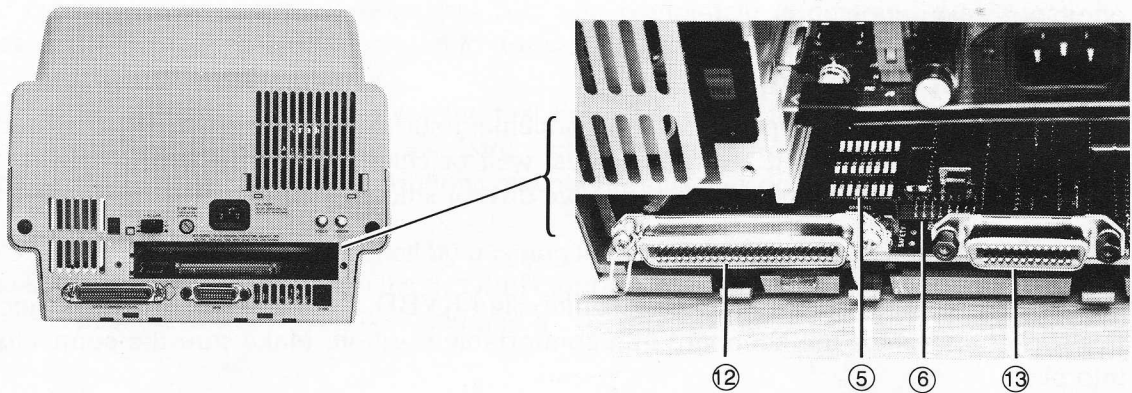

### (9) Focus Knob

The focus knob enables you to put the CRT into better focus. For best results, focus the screen with brightness turned all the way up. After the screen is focused, turn the brightness down to the desired level.

### (10) Brightness Knob

Turning the brightness knob clockwise increases the screen's brightness; turning it counter-clockwise decreases the brightness.

### (11) The Fan

The computer has a small built-in fan to keep the machine cool. The fan should always be running when the computer is ON. If the fan ever goes OFF while the computer is powered on, switch the computer OFF and contact your HP Service Representative.

### (12) Data Communications Interface

The built-in datacomm interface enables you to transfer data asynchronously. This allows you to communicate with other computers using a wide variety of interconnections. We sometimes refer to the datacomm interface as an RS-232 interface since it conforms to RS-232C electrical specifications. The computer's self-test recognizes the interface as an HP 98626A plug-in card. There are a number of switches on the CPU board that control BAUD rate, parity, stop bits and bits per character.

### (13) HP-IB Interface

HP-IB stands for Hewlett Packard Interface Bus. This interface is an industry standard for communicating with external instruments and devices. A single HP-IB bus can support up to 14 devices ranging from logic analyzers to printers and plotters. There is a switch that specifies whether or not your computer is a system controller. For information about how to access devices on your HP-IB interface, see the appropriate programming language or operating system manuals.



## Setting Up Your Computer

Follow these instructions to install and power-up your computer for the first time. If the computer doesn't power up as expected, refer to Chapter 3. Steps 1 thru 7 should be followed for all Model 16 computers. Steps 8 thru 11 are optional; they may or may not be relevant depending on your configuration.

### 1. Position the Computer

Place your Model 16 computer on any convenient surface. Be sure that there are at least 2 inches of space between it and the nearest wall or ceiling for ventilation purposes. Do not operate the computer in areas with excessive dust or smoke.

### 2. Attach the Keyboard

On the back of your computer is a socket labelled **KYBD**. Insert the keyboard connector into this socket and place the keyboard in a comfortable position. Make sure the connector snaps into place.

### 3. Check the Line Voltage Switches

The computer can be set to operate at either 115 Vac or 230 Vac. The red switch on the back of the computer was set at the factory to the line voltage of your area. Check it to make sure it is correct. The switch can be changed with a screwdriver or pen.

---

#### CAUTION

THE COMPUTER CAN BE DAMAGED IF SET FOR 115 VAC AND PLUGGED INTO A VOLTAGE HIGHER THAN 127 VAC.

---

### 4. Check the Fuse

Four fuses are sent with the Model 16 Computer. Two of them are 2 amp fuses used for 115 Vac. The other two are 1.5 amp fuses for 230 Vac. Select the appropriate fuse for your line-voltage and insert it in the fuse holder. To remove the fuse holder from the computer, turn it counter-clockwise while pressing in. To insert it, turn it clockwise while pressing in.

---

#### WARNING

TO AVOID THE POSSIBILITY OF SERIOUS INJURY, DISCONNECT THE POWER CORD BEFORE REMOVING OR INSTALLING A FUSE.

---

#### Line Fuses

Line Voltage	Fuse Needed	HP Part Number
90-125	2 A (normal blow)	2110-0002
196-250	1.5 A (normal blow)	2110-0043

## 5. Check the Switches

There are three sets of switches located on the CPU board. These are used to set the starting address of RAM and to set various parameters for the built-in datacomm and HP-IB interfaces. They are already set to default values which should be suitable for your application. If you do need to change some of them, make sure that you completely understand their functions. Switches set to the wrong values can lead to unpredictable results or failure.

If you're powering-up the computer for the first time, just check to make sure that all of the switches are set to their default positions. Later, when you're more familiar with the machine, you can return to this section for descriptions of what the switches do and how to change them.

Switches can be set with a pen or pencil by pushing in the front or rear half. When the front half of the switch is pushed down, the switch is OPEN and a "1" is registered. When the rear half of the switch is pushed down, the bit is closed and a "0" is registered.

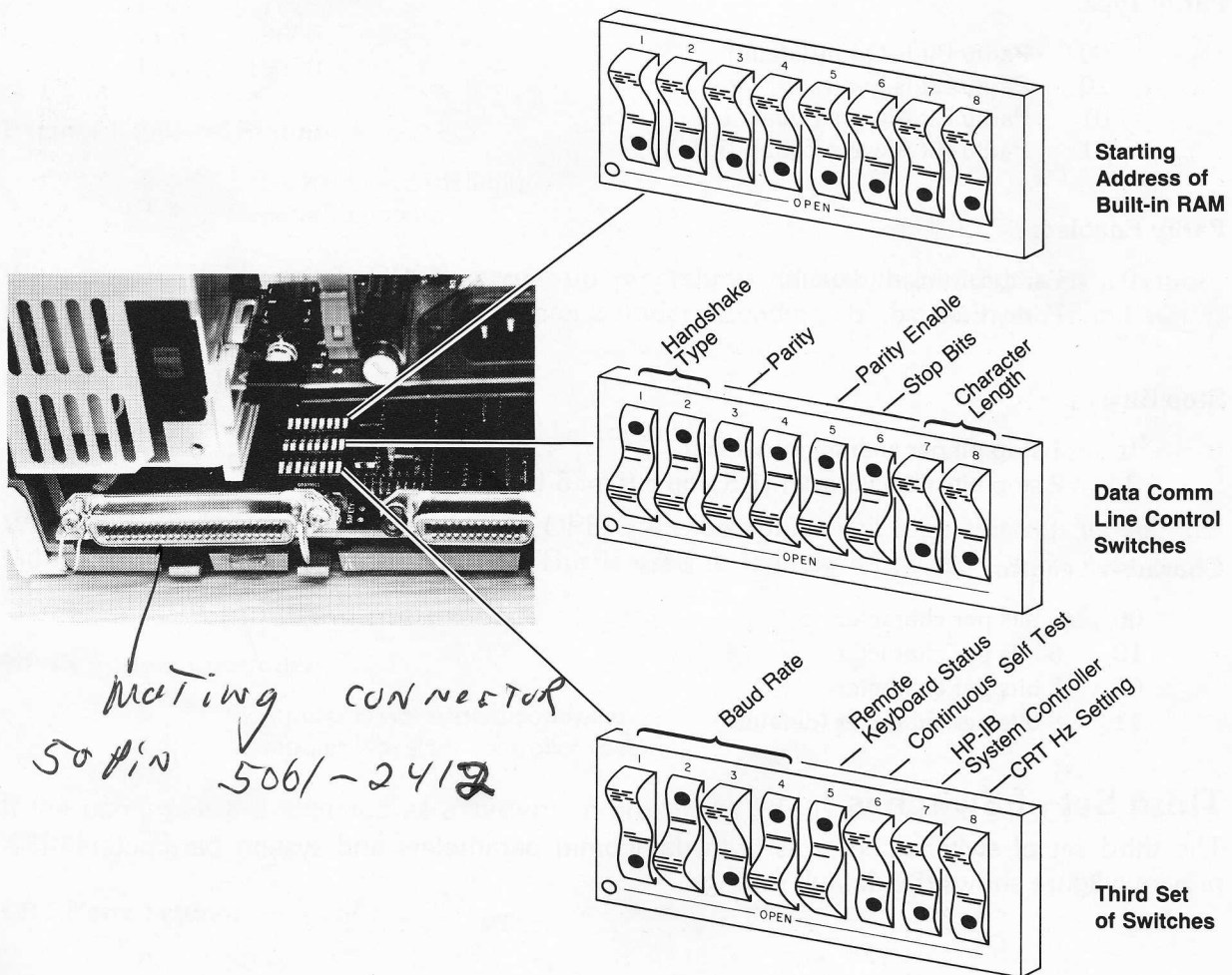

Default Switch Positions on the Process Board

## Setting the RAM Starting Address

The default address for internal RAM is shown in the previous figure. There is only one situation where you would need to change this default address. The Model 16 comes in two models: the Model 16A has 128K of internal RAM and the Model 16S has 256K of internal RAM. If you have a 128K model and you want to insert additional memory boards, you will need to change the starting address of internal RAM. For now, leave the switches all OPEN. We explain how to change them, if necessary, in Step 8.

## Setting Datacomm Line Control Switches

The second set of switches controls a number of parameters for the built-in datacomm interface. The default settings are shown in the previous figure.

### Handshake Type:

All values are non-operational; reserved for future use.

### Parity Type:

00	Parity Bit Is Odd (default)
10	Parity Bit Is Even
01	Parity Bit Always Equals 1
11	Parity Bit Always Equals 0

### Parity Enabled:

0	Parity Disabled (default)
1	Parity Enabled

### Stop Bits:

0	1 stop bit per character (default)
1	2 stop bits per character (1.5 stop bits for 5-bit characters)

### Character Length:

00	5 bits per character
10	6 bits per character
01	7 bits per character
11	8 bits per character (default)

## Third Set of Switches

The third set of switches controls both datacomm parameters and system parameters. The previous figure shows the default settings.

**BAUD Rate:****Switches:1234**

0000	50
0001	75
0010	110
0011	134.5
0100	150
0101	200
0110	300
0111	600
1000	1200
1001	1800
1010	2400 (default)
1011	3600
1100	4800
1101	7200
1110	9600
1111	19200

**Remote Keyboard Status:**

0	Local Keyboard (default)
1	Remote Keyboard

With the REMOTE switch OPEN, power-up procedures can be monitored from a remote terminal. This is described further in Chapter 2 under "Loading Using a Remote Terminal".

**Continuous Self-Test:**

0	Continuous Self-Test Disabled (default)
1	Continuous Self-Test Enabled

When the continuous self-test switch is OPEN, the computer will loop through its self-test indefinitely or until a fatal error occurs. This is used to identify hardware failures that occur intermittently.

**HP-IB System Controller:**

0	Computer is not system controller
1	Computer is system controller (default)

If the computer is designated as a system controller, its HP-IB address is 21. Otherwise, its address is 20.

**CRT Hertz Setting:**

0	50 Hz
1	60 Hz (default)

## 6. Connect the Power Cord

A power cord was selected and packed with your computer when it was shipped from the factory. Each cord has a ground connector to protect the user from electrical shock. Check to make sure you have the correct cord for your power outlet. The available cords are shown below.

---

### WARNING

IF A REPLACEMENT POWER CORD IS NEEDED, IT MUST HAVE THE SAME POLARITY AS THE ORIGINAL. OTHERWISE, A SAFETY HAZARD FROM ELECTRICAL SHOCK OR EQUIPMENT DAMAGE MAY RESULT.

---

After connecting the power cord to the back panel, plug in the other end to a power outlet. Be sure the power switch is OFF (out) when you plug it in.

U.K.  
8120-1351

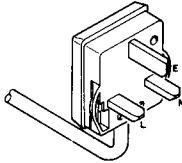

Australia  
8120-1369

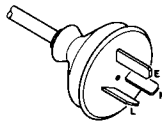

Europe Grounded  
8120-1689

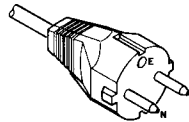

Denmark  
8120-2956

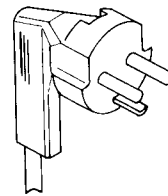

U.S. Grounded  
8120-1378<sup>1</sup>

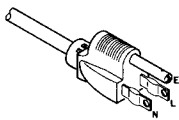

U.S. Grounded  
8120-0698<sup>2</sup>

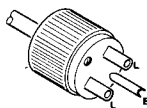

Swiss  
8120-2104

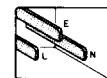
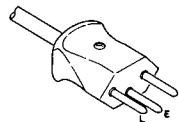

Computer  
Power-Input  
Socket

### Available Power Cords

## 7. Turn the Computer On

Now you're ready to power-up the computer. Press in the black button labeled "AC LINE" on the back of the CRT. You should immediately hear the fan running. It will take a moment for the screen to come on. When it does, you should see the display similar to the one shown below.

---

### Note

With brightness turned all the way down, nothing will appear on the CRT. If you're not getting any response to a power-up or to keyboard entries, check to make sure that the brightness is turned up.

---

```

9816
Copyright 1982,
Hewlett-Packard Company.
All Rights Reserved.

```

```

BOOTROM 3.0
Keyboard
Graphics
HP-IB
HP98626 at 9
261984 Bytes

```

Not displayed with  
BOOTROM 3.0L

```

SEARCHING FOR A SYSTEM (ENTER To Pause)
RESET To Power-Up

```

The list of components tells you that each has passed the computer's self-test. If you get a failure message, consult Chapter 3 for further instructions. Note that the datacomm interface is called an HP 98626 and is set to select code 9. Also, the bottom line tells you how much memory you have. In the example above, the computer has 256K bytes of internal RAM. If you have a 128K-byte model, this line will be closer to:

```
130912 Bytes
```

So far, you haven't loaded an operating system or attached any peripheral devices. As you add these elements to your system, the power-up display messages will change.

## 8. Insert Additional Read/Write Memory

---

### CAUTION

THE COMPUTER MUST BE SWITCHED OFF BEFORE ANY MEMORY BOARDS ARE INSTALLED. PLUGGING IN OR UNPLUGGING BOARDS WITH THE POWER ON CAN DAMAGE THE BOARD AND THE COMPUTER.

---

The computer's program and data-storage memory can be expanded by installing additional read/write memory boards (RAM). Each memory board can be plugged into either of the two slots at the back of the computer. Interface cards, however, can only be installed in the bottom slot. If you plan to install both an interface card and a memory board, you should insert the memory board in the top slot.

Before inserting a memory board, note the amount of available read/write memory displayed during step 7. Now switch the computer OFF and remove the memory board from its anti-static plastic package.

---

### CAUTION

STATIC DISCHARGE CAN DESTROY COMPONENTS ON A MEMORY BOARD. HANDLE THE BOARD BY USING ITS ANTI-STATIC ENVELOPE. DO NOT TOUCH THE ELECTRICAL TRACES OR SET THE BOARD ON ANY STATICALLY CHARGED SURFACE (E.G., A CLOTH).

---

The starting addresses of memory boards and of internal RAM are set by switches. There are eight internal RAM switches which allow you to address internal RAM by decrements of 64K. The 256K memory boards, however, have only six switches, so you can only address memory by 256K blocks. All memory, including internal RAM must be contiguous. Given these restrictions, there are a limited number of addressing possibilities. The starting addresses of all possible combinations are shown next.

Note that on machines with 256K internal RAM, the starting address of internal RAM is not altered, regardless of how many memory boards are inserted. On machines with 128K internal memory, however, the internal RAM must be below the memory boards so the address must be changed.

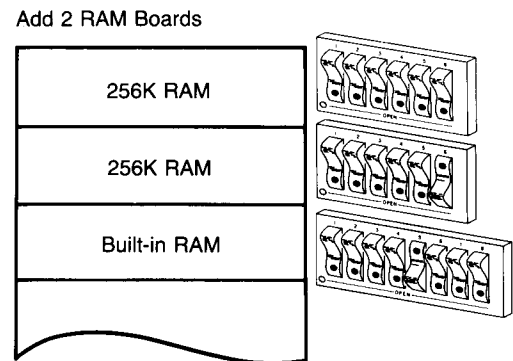
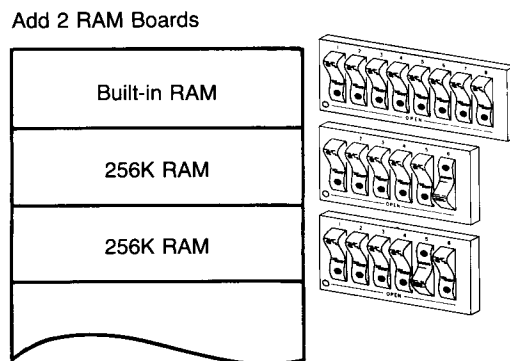
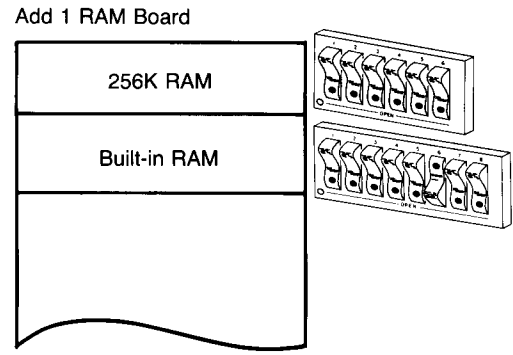
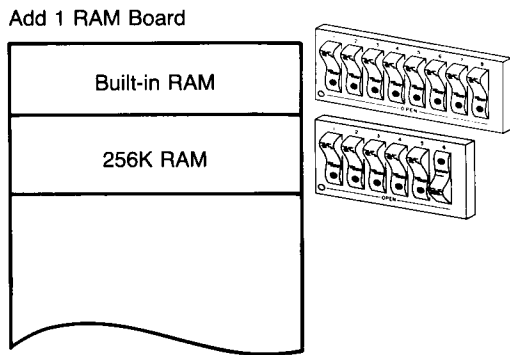
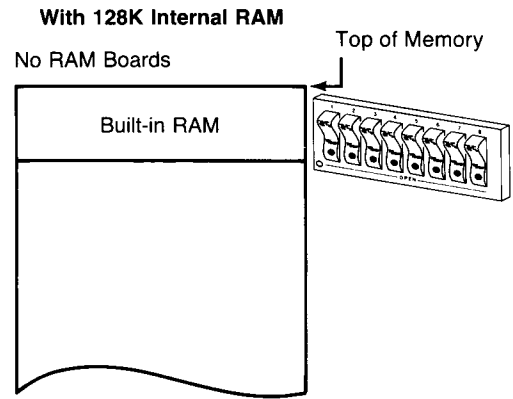
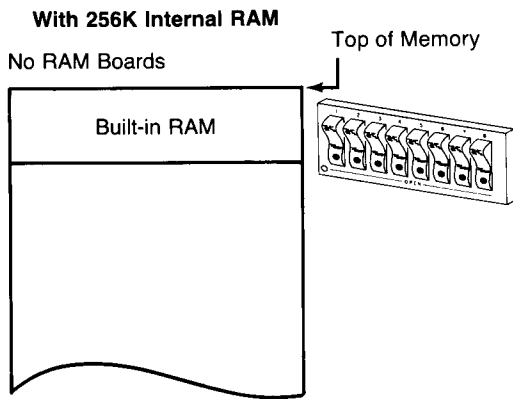

**Switch Settings for Typical Memory Configurations**

To install the board, insert it in one of the accessory slots. There are two plastic levers on either side of the board. The yellow lever should be on the left and the red lever on the right. When the board is properly inserted, both levers should be flush with the back of the computer.

After installing each memory board, switch the computer on and verify the new amount of memory. If the available memory does not increase about 265K bytes with each added memory board, switch the computer off and make sure that the board is properly seated in the accessory slot. Also check the setting of the address switches. If they're not set to the properly, the computer cannot access the memory board.

If the computer still doesn't indicate an increase in available memory, or the computer does not power-up correctly when an additional memory board is installed, switch the computer OFF, remove the board and replace it in its anti-static envelope. Then contact your HP Service Representative for details on replacing the board or repairing the computer.



## 9. Install an Interface Card

---

### CAUTION

THE COMPUTER MUST BE SWITCHED OFF BEFORE ANY INTERFACE CARDS ARE INSTALLED. PLUGGING IN OR UNPLUGGING CARDS WITH THE POWER ON CAN DAMAGE THE BOARD AND THE COMPUTER.

---

The computer can hold one interface card which slides into the bottom slot. See the manual provided with your interface for instructions on configuring the card.

If you are going to use a BASIC system, be sure that the select code you choose is above 7 since select codes 1 thru 7 are reserved. HPL reserves select codes 0, 7 and 16 thru 31. Also do not set the interface to select code 9 since this is reserved for the built-in datacomm interface. Once you've inserted the card, turn the machine ON. The computer should list the interface and its select code during the self-test.

## 10. Install a Language ROM Board

HP offers many of its operating systems and programming languages on both soft media (discs) and hard media such as Read/Only Memory (ROMs). ROMs are installed exactly like RAM boards except that there are no address switches to set. They can be inserted in either accessory slot. For instructions on loading an operating system from ROM, see Chapter 2.

## 11. Connect Peripheral Devices

Most peripheral devices such as disc drives and printers can be attached via the built-in HP-IB Interface. Be sure that no two devices have the same primary address. Some devices require a special interface and cable. Make sure that the interface is properly inserted and that you have the right cable.

## 12. Attach the Pascal Key Label

A small sticker that looks like this is packaged in your accessory kit:

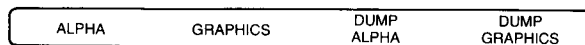

This is for use with the Pascal operating system. If you plan to run Pascal on your Model 16 Computer, place the sticker on the keyboard case with the word ALPHA directly over the **RCL** key and the words DUMP GRAPHICS over the **CLR LN** key. If you will not be using Pascal with the Model 16, just leave the sticker in the accessory package.

# Chapter 2

## Loading an Operating System

### Introduction

The Model 16 Computer has a built-in Boot ROM which enables you to load an operating system from a plug-in ROM card or external disc drive. By “operating system”, we mean any HP Series 200 programming language (i. e., BASIC, Pascal, or HPL), a mass storage system like Shared Resource Management, HP application programs like Visicalc<sup>1</sup>, and any other system software that conforms to HP’s operating system format.

As soon as the computer has completed its self-test, it passes control to the Boot ROM. The Boot ROM starts by polling all ROMs and mass storage devices connected to the computer. It loads the first operating system found. The order in which it polls media is explicitly defined by a list of priorities which we discuss later. Once the computer begins loading an operating system, it blocks all input from the keyboard so that the loading process cannot be interrupted.

In this chapter, we describe how the Boot ROM selects a default operating system and how you can override the default procedure if you want to load a system other than the Boot ROM’s first choice.

<sup>1</sup> VisiCalc is a registered trademark of VisiCorp.

## Default Procedure

This section describes what the Boot ROM does if you simply power-up the machine and leave it to its own resources.

The first thing the Boot ROM does is to find out if there are any operating systems connected to the machine. The operating systems can be on any of several media, including ROMs, flexible discs and hard discs. As soon as the Boot ROM finds a system, it displays it on the right side of the screen (see the next figure) and begins loading it. A displayed message informs you that the system is being booted.

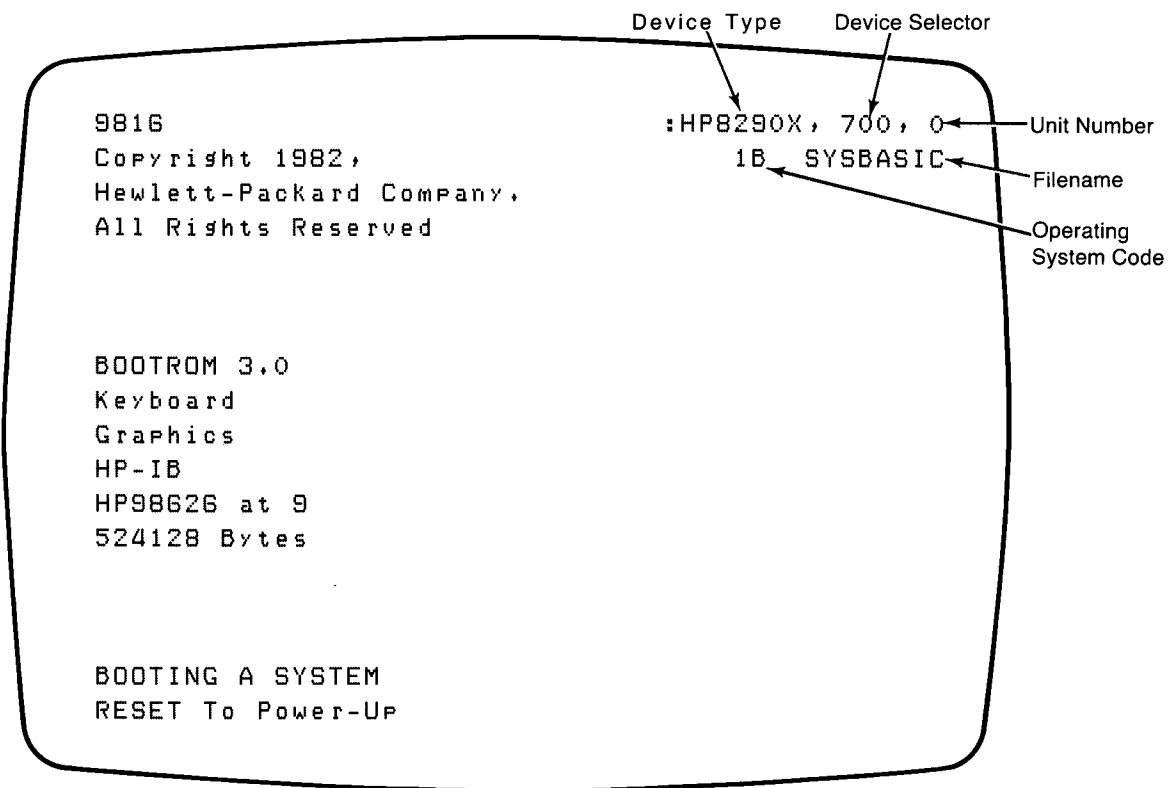

Typical Power-up Display

The order in which the Boot ROM scans media determines which operating system it loads when more than one is present. The list below shows the priorities used by the Boot ROM.

### BOOTROM3.0 System Searching Priority<sup>1</sup>

Priority	Media
1	External disc at select code 0 thru 31 on Unit 0, Volume 0.
2	Shared Resource Management disc at select code 21, on Volume 8.
3	ROM Board.
4	Other external discs at select codes 0 thru 31 (not unit 0, volume 0).
5	Other Shared Resource Management discs at select codes 0 thru 31 (not select code 21, volume 8).

Within each of the above categories, there are additional rules for the order in which media are scanned. External devices are searched in order of select code. For example, a system at select code 10 would be found before a system at select code 11. Also, multiple units at the same select code are searched before moving on to the next select code. So, a system at select code 7, primary address 1, unit 0 would be found before a system at select code 7, primary address 1, unit 1. Both systems would be found before a system at select code 7 and primary address 2.

When the Boot ROM finds an SRM system at a select code, it searches volume 8 first, then volume 7, and finally volumes 9 thru 31.

Suppose you have the configuration illustrated below.

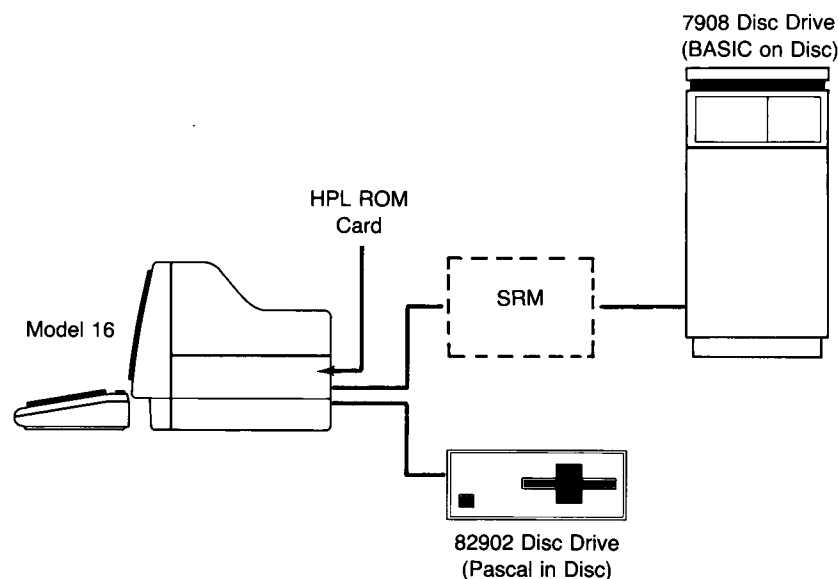

### Model 16 Computer Connected to Three Available Operating Systems

<sup>1</sup> When BOOTROM3.0L is present, an operating system can be loaded only from supported HP 8290X drives and ROM boards. The Boot ROM's name is displayed during the power-up procedure, as shown on the previous page.

There are three operating systems to choose from: the plug-in HPL ROM, BASIC on a 7908 Shared Resource Management disc, and the Pascal System in the 82902 Disc Drive. The one selected by the Boot ROM depends entirely on what addresses the two disc drives are set to. The table below shows which system is loaded for several different addressing combinations.

System Loaded	Source	Device	Mass Storage Addresses		
			Select Code	Unit Number	Volume Number
HPL	ROM	82902	10	1	0
		7908	21	0	0
BASIC	SRM	82902	10	1	0
		7908	21	0	8
Pascal	5" Disc	82902	10	0	0
		7908	21	0	2

As you can see, by changing the addresses of the mass storage devices, you have control over which operating system the Boot ROM finds first.

### If No Operating Systems Are Connected

BOOTROM3.0 will keep cycling through its polling routine until it finds an operating system it can load. It can only poll devices that are turned on, and it will not poll the same device twice. There are two important consequences of this procedure. First, if a disc drive is on, but does not have an operating system disc in it when you power-up the Model 16, you cannot subsequently insert the disc and expect the Boot ROM to find it. The problem is easily resolved by inserting the disc and pressing **RST** (SHIFT PSE). The second consequence is that the Boot ROM will poll a device as soon as it powers-up, even if it was off when the computer was turned on. This means that you can turn a disc drive on while the Boot ROM is searching for a system. As soon as the disc drive is "on line", the Boot ROM will poll it.

BOOTROM3.0L makes one pass to search for a system to load. If one is not found, this message is displayed:

SYSTEM NOT FOUND

### If There's Not Enough Memory

Every operating system takes up a certain amount of memory. If you don't have enough memory in your machine, the system will display the message:

NOT ENOUGH MEMORY

To solve the problem, turn the computer OFF and insert a memory board. Then turn the computer ON again. This time it should load the system. If you get the same message again, make sure that the memory board(s) address switches are set properly (see Chapter 1).

## Overriding the Default Selection

The following discussion applies only to Model 16 Computers with BOOTROM3.0. Model 16s with BOOTROM3.0L do not allow you to interrupt the Boot ROM or self-test. To find out which model you have, see Step 7 of "Setting Up Your Computer" in Chapter 1.

You may want to load a system that isn't the Boot ROM's first choice. To do this, merely type a space, number, or character (A thru Z, or a thru z) at any time during power-up before the Boot ROM chooses a system. The amount of time you have depends on how much memory the computer has to test. At the very least you will have a couple of seconds to interrupt the Boot ROM's default procedure.

Pressing an interrupt key will not have an immediate effect, so don't worry if the computer doesn't seem to respond. First the computer will perform its self-test as usual. After the self-test is complete, the computer goes ahead and polls all connected media. Instead of loading the first operating system it finds, though, it displays a menu of all operating systems connected to your computer (see example below).

```

9816                               :REMOTE, 21, 0, 8
Copyright 1982,                     1B SYSTEM_BAS
Hewlett-Packard Company.           :ROM
All Rights Reserved.                B B
                                     H H

BOOTROM 3.0                          :HP9895, 801, 2
Keyboard                             2B SYSTEM_BAS
Graphics                             :HP7908, 803, 1
HP-IB                                 1b SYSbOwn
HP98626 at 9                          :REMOTE, 20, 0, 8
524128 Bytes                          1F SYSTEM_FORTH
                                     1P SYSPASCAL

```

```

SEARCHING FOR A SYSTEM (ENTER To Pause)
RESET To Power-UP

```

The systems are listed in the same order they were found. For example, the first system in the list is the one that would have been loaded by the default procedure.

Beneath each device selector is a code followed by the name of the system file. This is the code you enter to load a particular system. All systems except ROMs have a code consisting of 1 or 2 digits followed by a letter. The codes for ROMs are all single letters. To choose a system, simply type in its code. You need not press the **(ENTER)** key. Your entry is displayed in the lower right corner of the CRT. If the code is valid, the Boot ROM will load the system. The message:

```
BOOTING A SYSTEM
```

is displayed to inform you that that the boot process is in progress.

### **Choosing A System Without the Menu**

If you already know what code you want before the computer even displays a menu, you can go ahead and enter it while the computer is performing its self-test. The characters you type act as both the interrupt keys and as the entry code for the operating system. For example, in the above example, you could type 1P right after you switch the power ON and the system would load SYSPASCAL. This makes it possible to choose an operating system without ever seeing the CRT.

---

#### **Note**

If you are going to interrupt the Boot ROM and wish to see the menu, we suggest that you press the space bar until the display shown on the next page appears. Typing a letter may accidentally direct the system to load a ROM.

---

## Special Keys

There are several keys that have special functions while the self-test and Boot ROM are in control. As soon as an operating system is loaded, however, these keys lose their special functions. On computers without BOOTROM3.0, only the **RST** key has a special function.

### The CTRL-C Key

Pressing the **CTRL** and **C** at the same time interrupts the self-test or Boot ROM and allows you to specify either 50 or 60 Hz for the CRT. This permits you to override the Hertz switch setting (described in Chapter 1). The display you get is shown below.

9816	KEY	ACTION
Copyright 1982	T	Extended Self-Test
Hewlett-Packard Company.	5	50 Hz CRT
All Rights Reserved.	6	60 Hz CRT
BOOTROM X.G		
Keyboard		
Graphics		
HP-IB		
HP98626 at 9		
524128 Bytes		

CONFIGURE MODE  
RESET To Power-UP

The system waits 5 minutes for you to make a selection. After 5 minutes, it automatically RESETs. Type **5** for 50 Hz or **6** for 60 Hz. Typing **T** for the extended self-test is redundant since the Model 16 automatically performs the extended self-test anyway. After you enter your selection, the computer runs through its self-test again.

### The ENTER Key

The **ENTER** key performs a number of functions during the power-up sequence. As the computer proceeds from its self-test to the booting process, the operation of the **ENTER** key changes. Its particular function at any point during power-up is always displayed on the second line from the bottom on the CRT. The **ENTER** key's functions during the self-test are described in Chapter 3. This section discusses the functions of **ENTER** while the Boot ROM is searching for an operating system. While the Boot ROM is scanning media, it displays the message:

SEARCHING FOR A SYSTEM (ENTER To Pause)



If you press **ENTER**, the system will stop scanning devices and display the message:

```
SEARCHING PAUSED (ENTER To Continue)
```

Pressing **ENTER** again will cause the system to resume its scan. The **ENTER** key is particularly useful if there are more systems than the screen can display at one time. It allows you to freeze the display before the systems at the top are scrolled off the CRT.

### The RST Key

Pressing **RST** serves the same purpose as turning the machine OFF and then ON again. It aborts the Boot ROM (or self-test) and starts all over again. You can press **RST** at any point during power-up before the Boot ROM starts executing a loaded system. Once the loading process ends, the keyboard is turned off. After a system is started, RST and all other keys, are re-defined to function for the operating system that was loaded.

## Loading using a Remote Terminal

You can control loading an operating system from a remote terminal only if BOOTROM3.0 is present.

When the computer performs its self-test, it specifically looks for an HP 98626 interface with the REMOTE switch turned ON. This could be either the built-in datacomm interface or a plug-in HP 98626 interface card. If it finds an interface with the REMOTE switch set, it displays the message:

```
Remote Interface at 9
```

In this case, the interface's select code is 9. This is the last message that will be displayed on your Model 16 CRT until an operating system is loaded. All self-test and Boot ROM messages will be displayed on the remote CRT if it is properly connected. Both keyboards (the one attached to your computer and the one attached to the remote terminal) will function identically.

In order to have messages displayed on the remote terminal, it must be configured correctly and handle HP standard escape sequences. See the terminal's manual for details.

# Chapter 3

## Self-Test and Repair

### Introduction

Whenever you power-up or press **RST** (SHIFT PSE), your computer conducts a self-test to make sure that all of its hardware components are working properly. This includes RAM and ROM, the CRT, the built-in HP-IB and datacomm interfaces, and any other interface present. As the self-test proceeds from one component to another, it displays messages on the CRT to report its status. In addition, the status is indicated on the self-test status lights on the CPU board. Most errors are reported on the CRT. There are a few, however, that are only reported on the status lights.

In this chapter, we describe how to interpret error messages. Very few errors are fatal. This means that after reporting any failures, the system will usually go ahead and try to boot an operating system. It is up to you to decide whether the error is serious enough to warrant aborting operation. This chapter should help you determine the seriousness and relevance of the more common self-test errors.

## Self-Test Messages

Although fairly extensive, the self-test takes only a couple of seconds to run. So even though it may appear that the computer is merely displaying a string of messages, it is actually performing tests in between each message. There are two types of messages you can receive: status messages and error messages.

### Status Messages

Status messages tell you that the computer has just completed the test of a particular component and that the component is OK. These messages are usually nothing more than the component's name. For example, if the built-in HP-IB Interface passes its test, the computer will simply display:

```
HP-IB
```

For interface cards, the system will display the name of the interface and its select code. For instance:

```
HP98629A at 20
```

While the computer is testing RAM, it displays the message:

```
TESTING MEMORY
```

on the bottom of the screen.

### Error Messages

If a component fails its test, the system displays any of several messages depending on the cause of the failure. Some failures occur because the computer can't find a component that it expects to be present. In this case, it will report that the part is missing. For example, it might display the message:

```
Keyboard Missing
```

In this case, the computer isn't referring to the actual keyboard, but to the keyboard processor. The message indicates that for one reason or another, the system cannot find the keyboard processor. You might also receive the message:

```
Keyboard Failed
```

This means that the system has found the keyboard processor but that it is malfunctioning.

After displaying an error message on the CRT, the computer proceeds to the next component on the self-test agenda. After testing all components, the computer either begins searching for an operating system to load or else beeps and displays the following message:

```
WAITING 1 MINUTE (ENTER To Abort Wait)
```

This message signifies that the system has found at least one error and is pausing 1 minute. This gives the CRT a chance to warm up and gives you time to read the error message(s). The seven least-significant bits starting with bit 6 are sounded off. A low-tone beep represents a 0 and a high-tone beep signifies a 1. Each beep lasts 1 second. These beeps correspond to the self-test status lights, a 1 signifying an ON light and a 0 an OFF light. Appendix B describes what each error code stands for.

After the 1 minute delay, the Boot ROM takes control and searches for a system to load. If you want to abort the 1 minute delay and the beeps, you can press **ENTER**. Pressing **ENTER** causes the computer to immediately begin searching for an operating system. It also interrupts the Boot ROM's default system loading routine. This means that you have to specify which operating system you want loaded (see Chapter 3 for details).

### Multiple Errors

If more than one failure is detected, the computer reports the highest priority error on the status lights. This is also the error that is sounded off with beeps. Errors are listed in order of priority in Appendix B.

### Boot ROM Errors

If the self-test locates a failure in the Boot ROM, it displays the message:

```
CONTINUE AT OWN RISK (ENTER To Continue)
```

The computer will not begin searching for a system until you press **ENTER**. Errors that occur in the Boot ROM can be either trivial or very serious. If, after receiving this message, you decide to continue, we suggest that you make sure you have a spare copy of any files that the Boot ROM might access.

## Self-Test Looping

The sixth bit on the third set of switches controls self-test looping. The default is for this bit to be OFF so that the self-test executes only once with each power-up or **RST**. With the bit ON, the self-test will loop indefinitely. There are only four types of failures that will abort the looping:

- A CPU Register failure. The CRT will be blank and an \$81 hex. (10000001) will be registered on the status lights.
- A memory failure in the top 16K bytes of RAM. The message,
 

```
RAM FAILED ABOVE FFC000
```

 is displayed and the status lights register \$84 hex. (10000100).
- Memory missing at top of memory. The message:
 

```
RAM GONE ABOVE FFC000
```

 indicates either the memory address switches are set incorrectly or the memory has failed. The status lights display \$44 hex (01000100).
- Boot ROM failure. The message,
 

```
CONTINUE AT OWN RISK (ENTER To Continue)
```

 is displayed and the status lights show \$83 hex. (10000101). Pressing **ENTER** causes the self-test to continue looping.

## Configuration Errors

In this section, we try to anticipate some errors you might receive that indicate a hardware mis-configuration rather than a failure. If you still receive the error after making the recommended adjustment, it means that there is a real problem and that you should contact your HP Service Representative.

HP-IB Failed

You could receive this message if more than half the devices connected on the HP-IB Interface are turned OFF. To correct the problem, either turn the devices ON or disconnect them from the HP-IB.

HP98626 at 9 Missing

Usually this error indicates that another interface is at select code 9. This select code is reserved for the built-in datacomm interface. To correct the problem, set the select code of the interfering interface to another value.

RAM GONE ABOVE FFC000

This error indicates that the computer couldn't find RAM. In most cases, this is because the starting address switches are set to the wrong value. Make sure that the switches are set to the proper values. See Step 7 of "Setting Up Your Computer" in Chapter 1 for more information.

## Service Information

### Standard Bench Service

Standard bench service for this product is provided for under your warranty. It calls for the return of the unit(s), shipping prepaid, to one of the Hewlett-Packard Field Repair Centers (listed later). The repair is done on a fixed charge basis if the unit is out of warranty or free of charge if the unit is in warranty.

### Turn-around Time

Hewlett-Packard will normally repair and reship within three (3) working days of receipt of the unit. Plan additional time for in-transit. This is an average time and may vary depending on workload.

### Shipping Charges

Whether the unit is under warranty or not, it is your responsibility to pay shipping charges for delivery to the repair center. Hewlett-Packard will pay the shipping charges for delivery back to you.

### Servicing Guidelines

If, after following maintenance procedures outlined in the user's manual, you determine that repair is required, you can help assure efficient servicing by following these guidelines:

1. Please indicate configuration of the system as it was at the time of the malfunction, i.e., plug-in module, tape cartridges or peripherals in use at the time or include them with the unit if they are required to duplicate the failure.
2. Write a brief description of the malfunction symptoms for service personnel.
3. Save printouts or any other materials that illustrate the problem area.
4. Provide a sales invoice or other proof-of-purchase date to establish warranty coverage period.

### General Shipping Instructions

Should you ever need to ship a unit yourself, be sure it is packed in a protective package. We recommend that you save the original shipping container for this purpose. In-transit damage is not covered by the warranty. Hewlett-Packard also suggests that you always insure shipments.

### Field Repair Centers

#### CANADA

Hewlett-Packard Co.  
6877 Goreway Drive  
Mississauga, Ontario  
Canada, L4V1M8  
Phone: (416) 678-2530

#### ICON LOCATIONS

Buenos Aires, Argentina  
Victoria, Australia  
Wellington, New Zealand  
Tepepan, Xochimilco, Mexico  
Caracas, Venezuela  
Sandton, Transvaal, South Africa  
Singapore  
Tokyo, Japan

#### UNITED STATES

##### California

Hewlett-Packard Co.  
5400 W. Rosecrans Avenue  
Lawndale, California 90260  
Phone: (213) 970-7500

Hewlett-Packard Co.  
3003 Scott Boulevard  
Santa Clara, California 95050  
Phone: (408) 988-7000

##### New Jersey

Hewlett-Packard Co.  
W120 Century Road  
Paramus, New Jersey 07652

##### Georgia

Hewlett-Packard Co.  
450 Interstate N. Parkway  
Atlanta, Georgia 30339  
Phone: (404) 955-1500

##### Illinois

Hewlett-Packard Co.  
5201 Tollview Drive  
Rolling Meadows, Illinois 60008  
Phone: (321) 255-9800

##### Texas

Hewlett-Packard Co.  
930 E. Campbell Road  
Richardson, Texas 75080

#### EUROPEAN LOCATIONS

Frankfurt, Germany  
Orsay, France  
Winnersh, United Kingdom  
Zurich, Switzerland  
Milan, Italy  
Brussels, Belgium  
Amsterdam, Holland  
Stockholm, Sweden  
Oslo, Norway  
Copenhagen, Denmark  
Madrid, Spain  
Vienna, Austria  
Helsinki, Finland

## **Extended Maintenance Agreements**

**Bench Maintenance Agreement** - You may purchase a bench maintenance agreement which provides a low-cost service program. This is available at the HP Field Repair Centers listed above.

**On-site Maintenance Agreement** - On-site maintenance agreements for your unit(s) can be purchased directly from Hewlett-Packard. Response is next-day to service requests within 100 miles of a Hewlett-Packard on-site Service Responsible Office. In addition, per-call on-site service is available at a standard repair price plus the appropriate travel zone charge.

For further information regarding service or maintenance agreements, contact your authorized dealer or local HP sales office.

# Appendix A

## Datacomm Interface

The built-in datacomm interface is electrically compatible with RS-232C electrical standards, but does not implement all of the pin functions defined by EIA Standard RS-232C.

### Interconnection to RS-232C Devices

Two cables are available for the built-in datacomm interface: The DTE (Data Terminal Equipment) cable has a male 25-pin EIA connector, and is used when the interface must exhibit DTE behavior. The DCE (Data Communication Equipment) cable is configured so that the datacomm interface simulates a modem, and is intended for use when the computer is connected back-to-back in a direct connection to another computer or terminal that has a male DTE cable attached to it. Cables are 4.9 metres (16 feet) long, and stocked under HP part numbers 5061-4215 (DTE male connector) and 5061-4216 (DCE female connector).

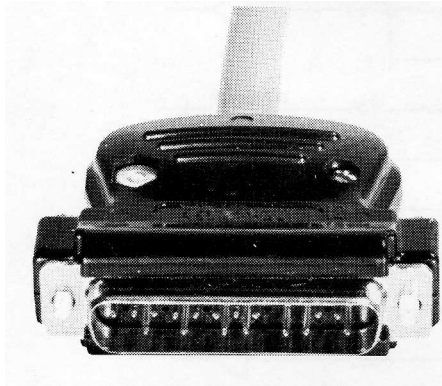

**DTE Cable with Male Connector  
(5062-4215)**

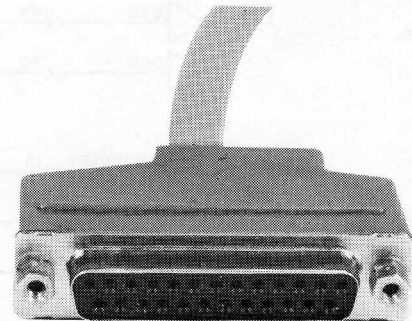

**DCE Cable with Female Connector  
(5061-4216)**

### Modem Connections

To connect to an RS-232C modem, plug the 50-pin connector of the DTE cable into the rear panel datacomm interface connector on the computer, plug the male RS-232 connector into the modem connector, then secure the connector fasteners.

### Connecting to Other Computers

For back-to-back connections with other cables, use the DCE cable to plug directly into a DTE-configured male connector. Connect the 50-pin connector to the datacomm interface.



### DCE Cable Cross-wiring

In the DCE cable, modem handshake lines are cross-wired so that the DCE datacomm interface drivers provide signals that simulate certain modem driver lines to the DTE interface. For example, certain preliminary activities between the modem and interface cannot be initiated until DCD is active. Modems provide a DCD driver which is not present on the interface. To activate the DCD input, the RTS output on the other interface is used. The RTS output is also fed back to the CTS input so the card, in effect, gives itself permission to send. The following drivers and receivers are cross-wired by the two cables as shown in the back-to-back connection schematic which follows:

- Data Out is connected to Data In on the other interface.
- RTS driver is connected to CTS on the same interface and DCD on the other interface.
- Secondary RTS drives Secondary CTS on the other interface.
- DTR drives RI and DSR on the other interface.
- Other lines are not used, except grounds and commons.

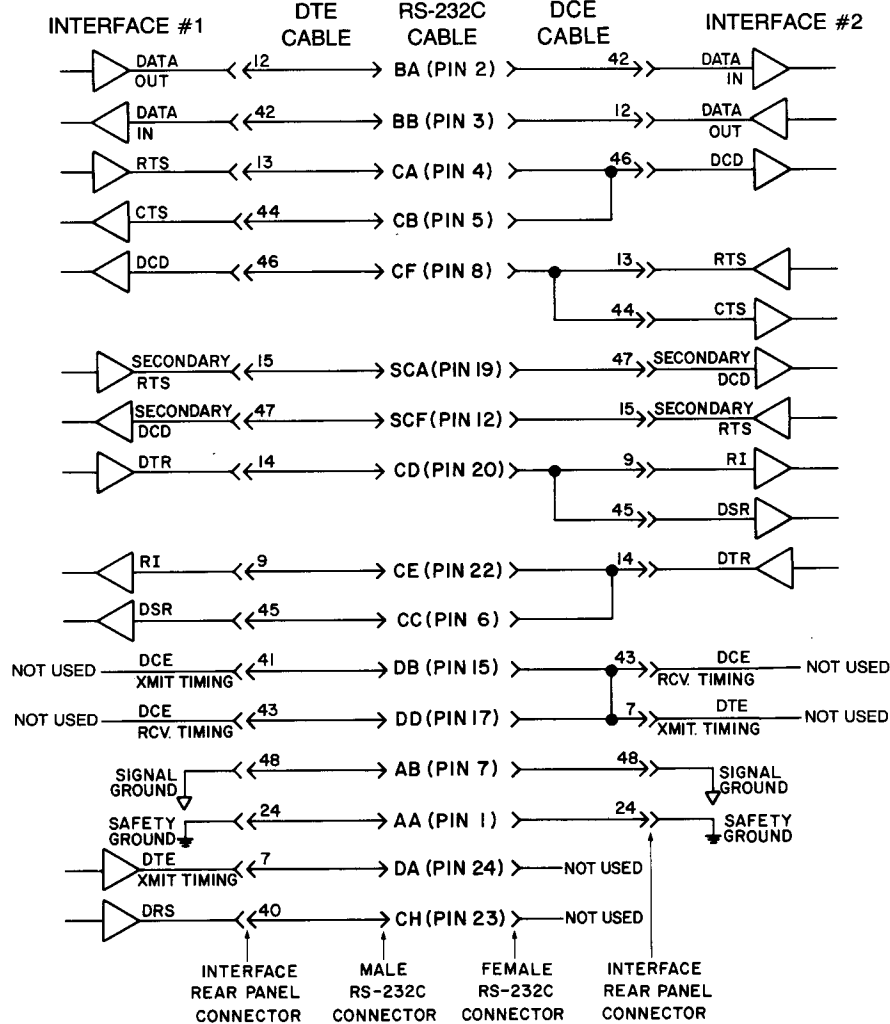

DTE/DCE Interface Cable Interconnection

Refer to the programming techniques manuals for your computer for more information about how to program the various drivers to meet your specific application needs.

### **Connecting to Printers and Other RS-232C Devices**

You cannot connect a DTE cable directly to a DTE printer or other RS-232C-compatible DTE peripheral. Wiring connections are such that no communication can take place. Use, instead, the DCE cable and an appropriate adapter cable to convert the DCE cable pin-out to the peripheral's DTE pin-out. Since most DTE peripherals have a female RS-232C chassis connector, the adapter cable is usually equipped with male connectors on both ends.

The peripheral must provide the appropriate handshaking signals such as Data Carrier Detect, Data Set Ready, Clear to Send, and Ring Indicator. A schematic of both cables is shown in this section in a back-to-back direct connection between two interfaces. Armed with this information and the pin configuration of the peripheral, you should be able to determine what adapter cabling is needed to connect the DCE cable to your DTE peripheral.

If your peripheral is wired as DCE, you should be able to connect directly to the peripheral with a DTE cable unless the peripheral requires signals not provided by the serial interface (such as DTE transmit timing).

If you encounter difficulty, contact your HP Sales and Service Office for assistance in selecting a suitable adapter cable for HP RS-232C peripherals.

## Electrical Characteristics

Here is a brief summary of interface electrical specifications for the RS-232C interface signals:

- Open circuit input voltage must not exceed  $\pm 25$  volts.
- Open circuit driver output impedance with power off  $> 300\Omega$ .
- Total combined load + line capacitance for a given driver  $< 2500$  pF.
- Driver output voltage slew rate  $< 30V/\mu s$ .
- Receiver input voltage with line disconnected  $< \pm 2V$ .
- Driver output voltage between 5 and 15 volts when load resistance is between  $3000\Omega$  and  $7000\Omega$ .
- Receiver identifies logic 1 (mark) when input voltage is more negative than  $-3V$ ; logic 0 (space) when greater than  $+3V$ .
- Driver output between 5 and 15 volts; negative for logic 1 (mark), positive for logic 0 (space).
- The signal voltage range between  $\pm 3V$  is defined as the transition region. Signals entering this region must meet certain requirements:
  - Signals entering must proceed to the opposite valid signal state.
  - While in the region, the direction of voltage change must not reverse.
  - Time in transition through region less than 1 ms.
  - Time in transition across the region less than 1 ms or 4% of the nominal signal period, whichever is less.

The following table shows datacomm rear panel pinouts and their interconnection to RS-232C connector pins for DTE and DCE configurations:

### Datacomm Interface Connector Pin Assignments

(unlabeled pins are not used.)

Function	Interface Pin No	Interface Pin No	Function
Optional Driver OCD4	1	26	Optional Driver OCD3
	2	27	
	3	28	
	4	29	
	5	30	
	6	31	Optional Receiver OCR3
	7	32	Signal Ground
	8	33	
Ring Indicator (OCR1)	9	34	
Modem/Adapter Power: +12V <sup>1</sup>	10	35	Modem/Adapter Power: +5V <sup>1</sup>
Modem/Adapter Power: -12V <sup>1</sup>	11	36	Connected to pin 35
Transmit Data (TxD)	12	37	Signal Ground
Request to Send	13	38	Signal Ground
Data Terminal Ready	14	39	Signal Ground
Secondary RTS (OCD2)	15	40	Data Rate Select (OCD1)
	16	41	
	17	42	Receive Data (RxD)
Signal Ground	18	43	
	19	44	Clear to Send
	20	45	Data Set Ready
	21	46	Data Carrier Detect
	22	47	Secondary DCD (OCR2)
	23	48	Signal Ground
Earth (Safety) Ground	24	49	
	25	50	

<sup>1</sup> Power connections are provided for use with HP 13265A Modem and HP 13266A Current Loop Adapter. Do not use for other purposes.

## Pin Functions

This table lists RS-232C functions by connector pin number. The functions implemented on the built-in datacomm interface are shown by an asterisk.

Pin 1	*Protective Ground, Electrical equipment frame and ac power ground.
Pin 2	*Transmitted Data. Data originated by the terminal to be transmitted via the sending modem.
Pin 3	*Received Data. Data from the receiving modem in response to analog signals transmitted from the sending modem.
Pin 4	*Request to Send. Indicates to the sending modem that the terminal is ready to transmit data.
Pin 5	*Clear to Send. Indicates to the terminal that its modem is ready to transmit data.
Pin 6	*Data Set Ready. Indicates to the terminal that its modem is not in a test mode and that modem power is ON.
Pin 7	*Signal Ground. Establishes common reference between the modem and the terminal.
Pin 8	*Received Line Signal Detector. Indicates to the terminal that its modem is receiving carrier signals from the sending modem.
Pin 9	Reserved for test.
Pin 10	Reserved for test.
Pin 11	Unassigned.
Pin 12	*Secondary Received Line Signal Detector. Indicates to the terminal that its modem is receiving secondary carrier signals from the sending modem.
Pin 13	Secondary Clear to Send. Indicates to the terminal that its modem is ready to transmit signals via the secondary channel.
Pin 14	Secondary Transmitted Data. Data from the terminal to be transmitted by the sending modem's channel.
Pin 15	Transmitted Signal Element Timing. Signal from the modem to the transmitting terminal to provide signal element timing information.
Pin 16	Secondary Received Data. Data from the secondary channel of the modem in response to analog signals transmitted from the sending modem.
Pin 17	Receiver Signal Element Timing. Signal to the receiving terminal to provide signal element timing information.
Pin 18	Unassigned.
Pin 19	*Secondary Request to Send. Indicates to the modem that the sending terminal is ready to transmit data via the secondary channel.
Pin 20	*Data Terminal Ready. Indicates to the modem that the associated terminal is ready to receive and transmit data.
Pin 21	Signal Quality Detector. Signal from the modem telling whether a defined error rate in the received data has been exceeded.
Pin 22	*Ring Indicator. Signal from the modem indicating that a ringing signal is being received over the line.
Pin 23	*Data Signal Rate Selector. Selects one of two signaling rates in modems having two rates.
Pin 24	Transmit Signal Element Timing. Transmit clock provided by the terminal.
Pin 25	Unassigned.

# Appendix B

## Self-Test Status and Error Codes

### Status Codes

Running the computer self-test is described in Chapter 3. These codes are registered on the self-test status lights. A 1 indicates that the light is ON; a 0 that the light is OFF.

1111 1111	}	Light test; 1/8 second per code.
0111 1111		
0011 1111		
0001 1111		
0000 1111		
0000 0111		
0000 0011		
0000 0001		
0000 0100	Testing top of RAM memory	
0000 0111	Starting computer self-test	
0001 1110	Testing CRT (alphanumerics only)	
0001 0010	Testing keyboard	
0000 0011	Testing Boot ROM	
0001 1111	Testing graphics	
0001 0100	Testing internal HP-IB Interface	
0001 1000	Testing DMA card	
0010 0000	Testing I/O card at select code 0	
0010 0001	Testing I/O card at select code 1	
⋮	⋮	
0011 1111	Testing I/O card at select code 31	
0000 1101	Testing ROM systems	
0000 1001	Testing remainder of RAM	

## Error Codes

The following error codes are listed in order of priority.

1111 1111	Status lights never accessed
0111 1111	Status light failure
1000 0001	CPU Register failure
1000 0011	Boot Rom failed
1000 0100	Failure in top of RAM
1000 1001	Failure in RAM
1000 1010	Insufficient RAM
1000 1101	ROM system failure
1001 0010	Keyboard failure
0101 0010	Keyboard missing
1001 0100	Internal HP-IB failure
0101 0100	Internal HP-IB missing
1001 1000	DMA card failure
0101 1000	DMA card missing
1010 0000	I/O card at select code 0 failure
0110 0000	I/O card at select code 0 missing
1010 0001	I/O card at select code 1 failure
0110 0001	I/O card at select code 1 missing
⋮	⋮
1010 1001	I/O card at select code 9 failure (built-in 98626 card)
0110 1001	I/O card at select code 9 missing (built-in 98626 card)
⋮	⋮
1011 1111	I/O card at select code 31 failure
0111 1111	I/O card at select code 31 missing
1001 1110	CRT alpha failure
0101 1110	CRT alpha missing
1001 1111	Graphics failure
0101 1111	Graphics missing
0000 0000	No failure



HEWLETT  
PACKARD

Part No. 09816-90000  
E0982  
Microfiche No. 09816-99000

09816-90001

Binder 9282-1023

Printed in U.S.A.  
First Edition, Sept. 1982