

**SEGA**  
PINBALL, INC.

MARY SHELLEY'S  
**FRANKENSTEIN**



**Joe Blackwell**  
Technical Support Manager

**Eric Winston**  
Technical Support Engineer

**Ted Kilpin**  
Technical Support Engineer

**Jay Alfer**  
Tech. Documentation Admin.

Sega Pinball, Inc.  
Copyright © 1994, All Rights Reserved.

780-5036-00

## CPU JUMPER TABLE

Game	CPU* Ver.	ROM Position	Jumpers		Game	CPU* Ver.	ROM Position	Jumpers	
			Installed	Removed				Installed	Removed
01. Laser War	1	5C	J4, J6a, J7a	J5, J6, J7b	14. Star Trek	3	5C	J5	J4
	2	5B, 5C	J4, J6a, J7a	J5, J6b, J7b	15. Hook	3	5C	J5	J4
02. Secret Service	2	5B, 5C	J4	J5	16. Lethal Weapon 3	3	5C	J5	J4
03. Torpedo Alley	2	5B, 5C	J4	J5	17. Star Wars	3	5C	J5	J4
04. Time Machine	2	5B, 5C	J4	J5	18. Rocky & Bullwinkle & Friends	3	5C	J5	J4
05. Playboy	2	5B, 5C	J4	J5	19. Jurassic Park	3	5C	J5	J4
06. ABC Monday Night Football	2	5B, 5C	J4	J5	20. Last Action Hero	3	5C	J5	J4
07. Robocop	2	5B, 5C	J4	J5	21. Tales from the Crypt	3	5C	J5	J4
08. Phantom of the Opera	2	5B, 5C	J4	J5	22. The Who's Tommy	3	5C	J5	J4
09. Back to the Future	3	5B, 5C	J4	J5	23. WWF Royal Rumble	3	5C	J5	J4
10. The Simpsons	3	5B, 5C	J4	J5	24. Guns N' Roses	3	5C	J5	J4
11. Checkpoint	3	5B, 5C	J4	J5	25. Maverick	3	5C	J5	J4
12. Teenage Mutant Ninja Turtles	3	5B, 5C	J4	J5	26. Mary Shelley's Frankenstein	3	5C	J5	J4
13. Batman	3	5B, 5C	J4	J5					

**Bd. Combinations with ROM at Location 5C (Game 1, ver1) Installed J1b, J3, J4, J6a, J7a & J8 Removed J1a, J2, J5, J6 & J7b**

**Bd. Combinations w/ ROM at Locations 5B, 5C (Game 1, ver2) Installed J1b, J3, J4, J5a, J6a, J7b & J8 Removed J1a, J2, J5, J5b, J6b, & J7a**

**Bd. Combinations w/ ROM at Loc. 5B, 5C (Games 2-13, Ver2/3) Installed J1b, J3, J4, J5b, J6b, J7b & J8 Removed J1a, J2, J5, J5a, J6a & J7a**

**Bd. Combinations with ROM at Loc. 5C (Games 14-25, Ver3) Installed J1b, J3, J5, J5b, J6b, J7b & J8 Removed J1a, J2, J4, J5a, J6a & J7a**

\* Version 1 has a 2K RAM which is a 24-pin IC in Position 5D. Version 2/3 have a 8K RAM which is a 28-PIN IC in Position 5D.

### Board Compatibility (Reflexive & Non-Reflexive) of CPU Boards

Version 1 and 2—**Reflexive**—Solenoid Drive Transistor is enabled directly by a *switch closure* on the solenoid assembly.  
Version 3—**Non-Reflexive**—Solenoid Drive Transistor is enabled by the CPU after reading a *switch closure* in the Switch Matrix. All CPU Boards are *backwards compatible* (e.g. Jurassic Park / Ver. 3 to Time Machine / Ver. 2). Swapping a Version 2 Board to a Version 3 is not possible due to the special solenoids section (i.e. Slingshots, Turbo Bumpers, etc.) changing from **Reflexive** to **Non-Reflexive** on Version 3 Boards.

### Power-Up CPU Self Tests

Upon power-up, the CPU Board performs a series of self tests of major components. Turn the game on while observing the LEDs on the CPU Board. Tests of the PIAs, RAM, and EPROMs are performed automatically and results of the tests are indicated by the PIA LED.

With all tests passed, the LEDs illuminate in the following sequence at power turn-on. The PIA and +5v LEDs illuminate immediately. Approximately 1/2-second later, the PIA LED goes out and the Blanking LED illuminates; the +5v and Blanking LEDs remain illuminated until the game is turned off. Test failures are indicated with the PIA LED:

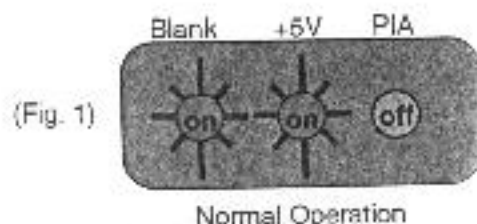

PIA LED	SUSPECT COMPONENT
Stays On	One of the 6821 PIAs
Flashes 1 Time	6264 RAM at location D5
Flashes 2 Times	EPROM at location C5

**DISPLAY READS "OPEN THE DOOR"** – This indicates a faulty memory condition in RAM. Opening the Coin Door will initiate a Factory Restore, by opening the Memory Protect Switch. Check battery voltage at CMOS RAM with power off.

### QUICK REFERENCE FUSE CHART

PPB BOARD		POWER SUPPLY BOARD	
F1	5A Slo-Blo G.I. 6.3vAC	F1	7A Slo-Blo +5vDC Regulator Input (9vAC)
F2	5A Slo-Blo G.I. 6.3vAC	F2	7A Slo-Blo +5vDC Regulator Input (9vAC)
F3	5A Slo-Blo G.I. 6.3vAC	F3	Not Used
F4	5A Slo-Blo G.I. 6.3vAC	F4	8A Slo-Blo Switched Illumination Buss (18vDC)
F5	5A Slo-Blo Flipper Power & 50v coils	F5	4A Slo-Blo Solenoid (32vDC)...
F6	5A Slo-Blo Flash Lamps (32vDC) Right		Bumpers, Slingshots, etc.
F7	3A Slo-Blo Flipper Power & 32v coils Left	F6	5A Slo-Blo Solenoid Buss (32vDC)
F8	4A Slo-Blo 50v coils		
F9	5A Slo-Blo 50v coils		



MARYSHELLEY'S  
**FRANKENSTEIN**  
 Table of Contents

<b>GAME SPECIFICATIONS</b> .....	<b>1</b>
Power Requirements .....	1
PROM Summary .....	1
Transportation .....	1
Overall Dimensions .....	1
Game Assembly Procedures .....	2
Leg Leveler Adjustment & Easy Access Service System .....	3
Backbox Layout, Fuse & Relay Locations .....	4
<b>GAME OPERATION &amp; FEATURES</b> .....	<b>5</b>
Standard Features .....	5
Extra Ball (EB) Buyin Feature .....	5
Manual Percentaging .....	5
Playfield Overview and Game Rules .....	6
<b>AUDIT FUNCTIONS</b> .....	<b>13</b>
General .....	13
Audits - 'Quick Look' Functions (Au. 1 - Au. 12) .....	13
Audit Table (Au. 1 - Au. 67) .....	14
Audits - Expanded Generic Functions (Au. 13 - Au. 46) .....	15
Audits - Expanded Game Specific Functions (Au. 47 - Au. 67) .....	16
<b>GAME ADJUSTMENTS</b> .....	<b>19</b>
General .....	19
Replay and Generic Features .....	19
Adjustments - Replays (Adj. 1 - 6) .....	19
Game Adjustment Table (Adj. 1 - 60, 99) .....	20
Game Difficulty Adjustment (Adj. 7) .....	21
Novelty / 5-Ball / Add-A-Ball Settings .....	21
Tournament Mode Settings (Adj. 43) .....	21
Game Pricing Adjustment (Adj. 8) .....	22
Custom Pricing Table .....	22
Standard Pricing Table .....	23
Additional Generic Features (9-47, 55, 57-62, 99) .....	24
Game Specific Features (48-52, 56) .....	26
<b>GAME DIAGNOSTICS</b> .....	<b>27</b>
Entering Diagnostics .....	27
Service Credits .....	27
Tech Alert .....	27
Easy Trough Clear .....	28
Burn-In Minutes .....	28
Sound Tests .....	28
Speaker Phase Testing .....	28
Digital Display Test .....	29
Dot Matrix Display Test .....	29
Creature Head Motion Test .....	29
Laser Kick Test .....	29
Switch Tests & Switch Matrix Chart .....	30
Switch Matrix Locations, Descriptions & Switch Part Numbers .....	31
Lamp Tests & Lamp Matrix Chart .....	32
Lamp Matrix Locations & Descriptions .....	33
Lamp Tests Continued, Flash Lamp / Coil Tests .....	34
Playfield Coils / Backbox & Playfield Flash Lamp Locations .....	34, 35
Switch, CPU Controlled Auxillary & Constant Power Chart .....	36
Coil Chart Wiring Schematic .....	37

*Continued on the next page.*

<b>PARTS IDENTIFICATION (PINK SECTION) Page Guide</b> .....	<b>39</b>
Backbox Parts .....	40
Cabinet Parts .....	41
Playfield - Major Assemblies .....	42
Playfield - Ramps & Rails .....	43
Playfield - Butyrate .....	44
Playfield - Parts .....	45
Playfield - Rubber Parts .....	46
Playfield - Posts (Illustrations Shown Actual Size) .....	47
Playfield - Lamps with Sockets (Illustrations Shown Actual Size) .....	48, 49
Playfield - Lamp Boards .....	50
<b>UNIQUE PARTS IDENTIFICATION (BLUE SECTION) Page Guide</b> .....	<b>51</b>
Up / Down Lever Assembly (500-5918-00) .....	52
6-Ball Switch Assembly (500-5683-00) .....	53
Lock Ball Assembly (for 6-Ball Switch Ass'y) (500-5684-01) .....	53
Deflector (for 6-Ball Switch Ass'y) (535-6606-01) .....	53
Flipper Assembly, Lower: Right (500-5832-01), Left (500-5832-02) .....	54
Flipper Assembly, Upper: Right Only (500-5694-01) .....	55
Slingshot (Strong-Leg Bull) Assemblies (500-5849-00) .....	56
Knocker Assembly (500-5081-00) .....	56
Turbo Bumper Assemblies (500-5227-02) .....	57
Ball Kicker (Auto Launch) Assembly (500-5477-01) .....	58
Laser Kick Assembly (500-5838-00) .....	58
Vertical Up-Kicker (VUK) (500-5839-00) .....	59
Ball Eject Assembly (500-5664-01) .....	59
Power Scoop Assemblies (500-5809-00) .....	60
Kick Big Assemblies (500-5862-00) .....	60
Diverter Assembly (500-5654-00) .....	61
Diverter Plunger & Crank Arm Assembly (515-5453-00) .....	61
Frankenstein Assembly (500-5887-00) .....	62
Frankenstein Main Plate Assembly (515-6153-00) .....	63
Upper Level Plastic Ramp Assembly (500-5905-00) .....	64
Lower Level Plastic Ramp Assembly (500-5923-00) .....	65
Stand-Up Targets, 1" x 1½" (500-5321-08), 1" Sq. (500-5232-08), Narrow (500-5657-08) .....	66
<b>SCHEMATICS / TROUBLESHOOTING (YELLOW SECTION) Page Guide</b> .....	<b>67</b>
Power Wiring Diagram .....	69
Cabinet Wiring Diagram .....	70
Backbox Wiring Diagram .....	71
Playfield Coil / Flashlamp Wiring Diagram .....	72
Playfield Special Coil Diagram .....	73
Playfield Switch Wiring Diagram .....	74
Playfield Lamp Wiring Diagram .....	75
CPU Board Assembly Diagram .....	76
CPU Board Logic Diagram (Sheets 1-4) .....	77-80
Power Supply Board Schematic & Component Layout .....	81
Sound Board Schematic (520-5077-00) .....	82
Display Controller Board Schematic (Page 1 of 2) .....	83
Display Controller Board Schematic (Page 2 of 2) .....	84
Display Controller Board Component Layout .....	85
Display Driver, Dwg. 1 (Cherry), Dwg. 2 (Babcock), Dwg. 3 (Dale) .....	86-88
Solid State 3-Flipper Theory of Operation & Circuit Troubleshooting Flowchart .....	89
Solid State 3-Flipper Board Diagram .....	90
Solid State 3-Flipper Wiring Diagram .....	91
PPB Diagram .....	92
Creature Head Motion Servo Board — Theory of Operation & Schematic .....	93



# GAME SPECIFICATIONS

## POWER REQUIREMENTS

This game is provided with a 3-prong plug and **must be connected to a properly grounded outlet to reduce shock hazard** and insure proper game operation. Refer to AC Power Wiring Diagram for transformer connections required for normal, high, and low line conditions.

Normal Line:	109 to 129 -Volts AC (211 to 225 -Volts AC)
High Line:	(226 to 235 -Volts AC)-- European, International
Low Line:	95 to 108 -Volts AC (200 to 210 -Volts AC)

## PROM SUMMARY

CPU Board:	Location C5
Sound Board:	Locations U17 (Voice ROM 1), U21 (Voice ROM 2), U36 (Voice ROM3) and U7 (Sound ROM)
Display Controller Board:	Location U1 (ROM 0) and U4 (ROM3)

## TRANSPORTATION

To reduce the possibility of damage, observe the following precautions whenever transporting the game. Lower the backbox and secure it to the cabinet. Remove the legs and secure the game within the transporting vehicle.

## OVERALL DIMENSIONS

Shipping Crate Dimensions	
Height	55-1/2"
Width	30-1/2"
Length	31"
Approx. Wt.	250 lbs.

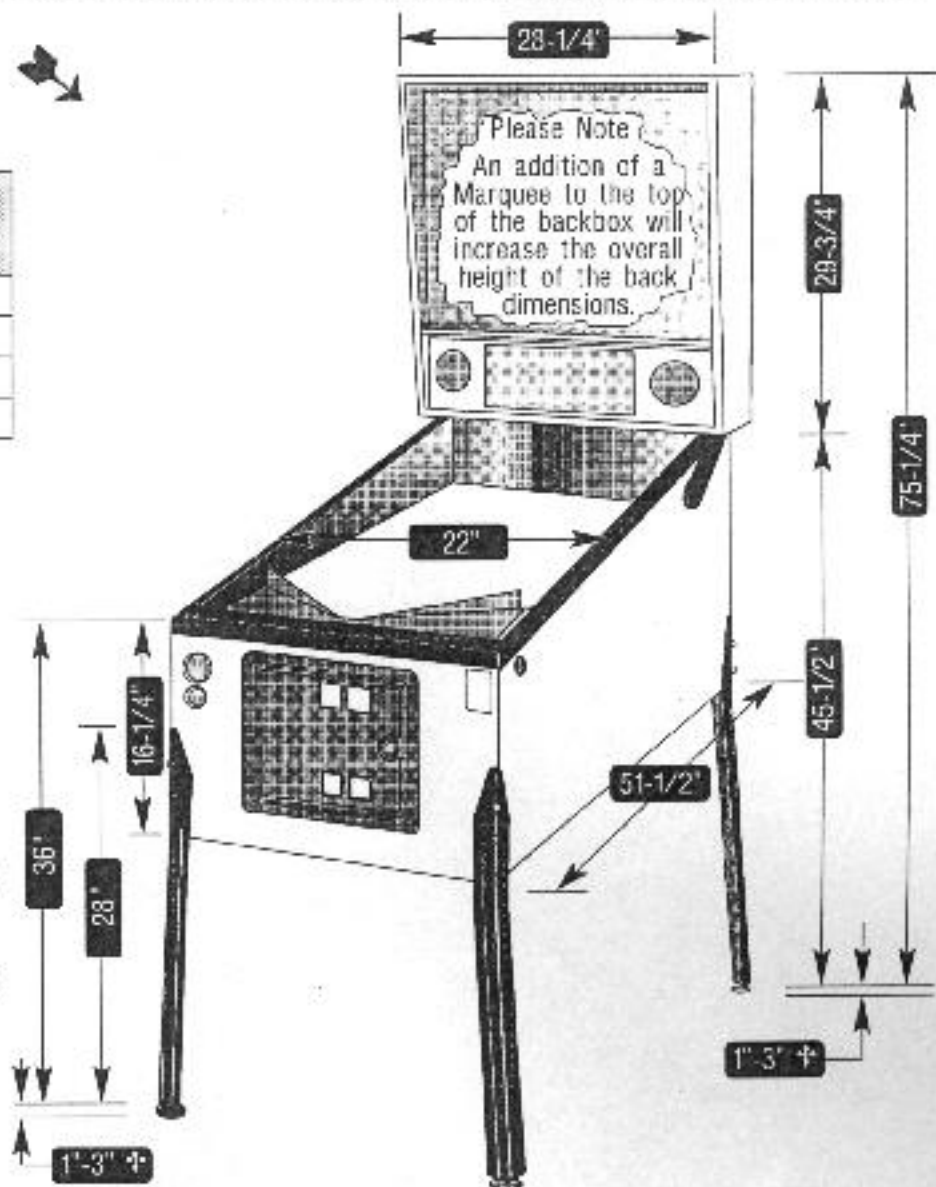

† Note: The Leg Levellers can add up to 2 inches to the overall height of the front and back dimensions.

## Game Assembly Procedures

---

(Refer to the Illustrations on pages 3 & 4)

1. Open the top of the carton and lay it on its side with the bottom of the cabinet down. Using the plastic banding strip as a handle, slide the game out of the carton.
  2. Remove all packing material. Cabinet legs are located on top of the front moulding above the coin door and the assembly parts package is in the cashbox. There should be four leg levelers, eight leg bolts, six pinballs and a large Allen Wrench, used for securing the backbox, is inserted & taped to the rear of cabinet.
  3. Leg Levelers should be attached. If not, attach Leg Levelers from the parts package to each leg, make sure that each leveler is threaded through a hex nut before threading it into the leg. See Illustration "Leg Leveler Adjustment" on the next page.
  4. Support rear of cabinet and attach rear legs using two leg bolts for each leg.
  5. Support front of cabinet and attach front legs using two leg bolts for each leg.
  6. While assuring that no cables are being pinched, carefully raise the backbox and secure it in its upright position with the Allen Wrench in the hole in the back of the cabinet and rotating the wrench 270° (¾ turn).
  7. Remove the backbox keys from the playfield glass, unlock and carefully remove the backglass. Set the backglass aside.
  8. Check all connectors in the backbox for loose wire terminations. Reseat any loose wire by pushing in on the terminal. Push on all connectors plugged into the CPU Board, Sound Board, Power Supply Board, and Display Board to check that they are properly seated.
  9. Check that the fuses on the Power Supply Board, PPB Board and Back Panel are seated properly.
  10. Carefully remove the playfield glass and set it aside.
  11. Remove all shipping tie downs.
  12. Raise the playfield and support it, by lifting the Stay Arm on the Right Side of the Cabinet and locking it into the slotted bracket on the playfield. (Use the instruction sheet provided in the game to see alternative methods of accessing the playfield bottom.)
  13. Check all cabinet cables and playfield Lamp Boards connector terminations.
  14. Remove the Plumb Bob tilt from the parts package and install on the pendulum wire on the inside left of the cabinet. (See Cabinet Parts Illustration.)
  15. Lower the playfield and ensure game is level side-to-side by adjusting Leg Levelers, if required.
  16. The game pitch should be at a 6.5° pitch. Depending on the condition of the floor, adjust as required.
- THE PLAYFIELD INCLINE AFFECTS DIFFICULTY OF PLAY. USE THE RECOMMENDED INCLINE; GAME DIFFICULTY IS BEST VARIED USING GAME ADJUSTMENTS.**
17. Check the plumb tilt and adjust as required.
  18. If desired, perform any self tests at this time. With the insert door closed, carefully reinstall and lock the backglass.
  19. Place the six pinballs on the playfield near the outhole and carefully reinstall the playfield glass.
  20. If desired, make game pricing and Add-A-Ball, Novelty, or 5-Ball Play adjustments at this time.



## LEG LEVELER ADJUSTMENT

*This cabinet is designed to automatically have a 6.5° pitch without any Leg Leveler adjustment!*

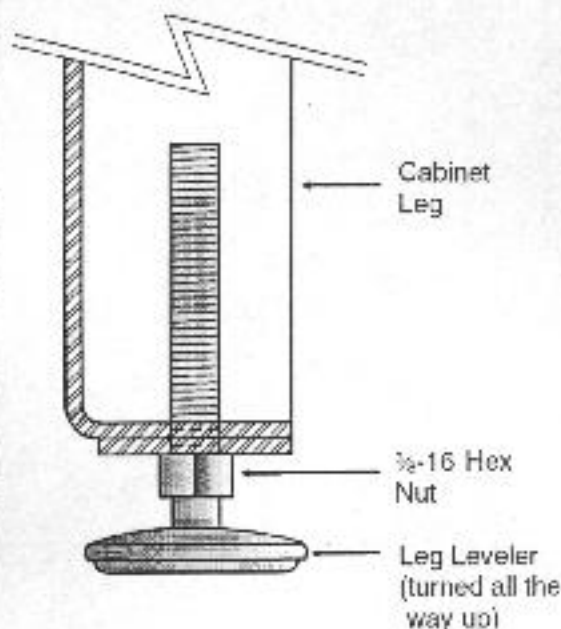

### STEP 1

Assemble all (4) legs and levelers as shown in the diagram. Be sure the leveler is turned all the way in.

### STEP 2

Attach leg assemblies to cabinet with leg bolts provided.

**YOUR PLAYFIELD PITCH IS NOW AT 6.5° AS REQUIRED FOR PROPER GAME PLAY!** See Step 3.

### STEP 3

Verify 6.5° pitch. Minor adjustment(s) may be necessary depending on the location floor being level.

*For custom adjustment greater than 6.5° can be achieved by turning out the leg leveler, however, it is not recommended.*

## EASY ACCESS SERVICE SYSTEM

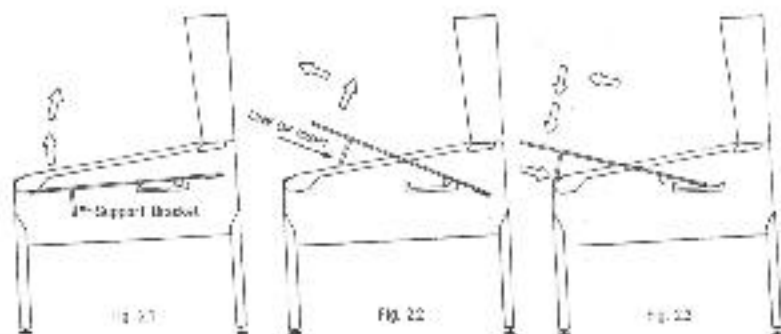

This position is useful to service:

Trough Switches, Connectors at back of cabinet, Cleaning the Playfield, etc.

### SERVICE POSTION 1

Lift the playfield *using the left and right ball guides* upward (Fig. 2.1) until the playfield support brackets can be seen to clear cabinet front (Fig. 2.2). At this time, pull playfield toward the front of the cabinet, checking that the mechanical components clear the cabinet front (Fig. 2.3). Then rest the playfield on the support brackets at the front channel of cabinet. **Reverse procedure when service is complete.**

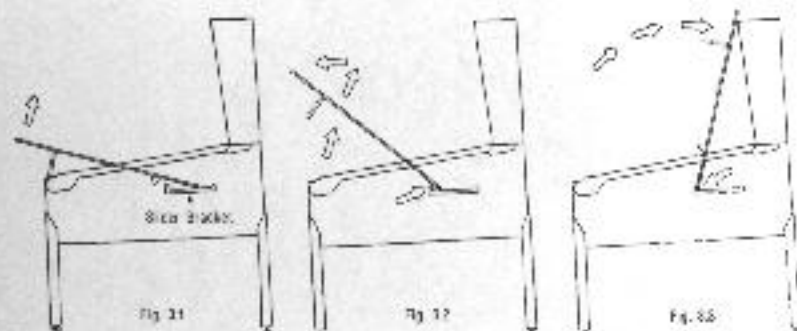

This position is useful to service:

All Playfield Bottom Components, Cabinet Components, etc.

### SERVICE POSTION 2

With the playfield at rest (Fig. 3.1), hold sides of playfield and pull toward the front of the cabinet (approximately 6-8"), until resistance is felt from the slider brackets located on either side of the cabinet (Fig. 3.2). At this time, swivel playfield toward the backbox, then rest on top edge of the backbox. **Reverse procedure when service is complete.**

## BACKBOX LAYOUT, FUSE & RELAY LOCATIONS

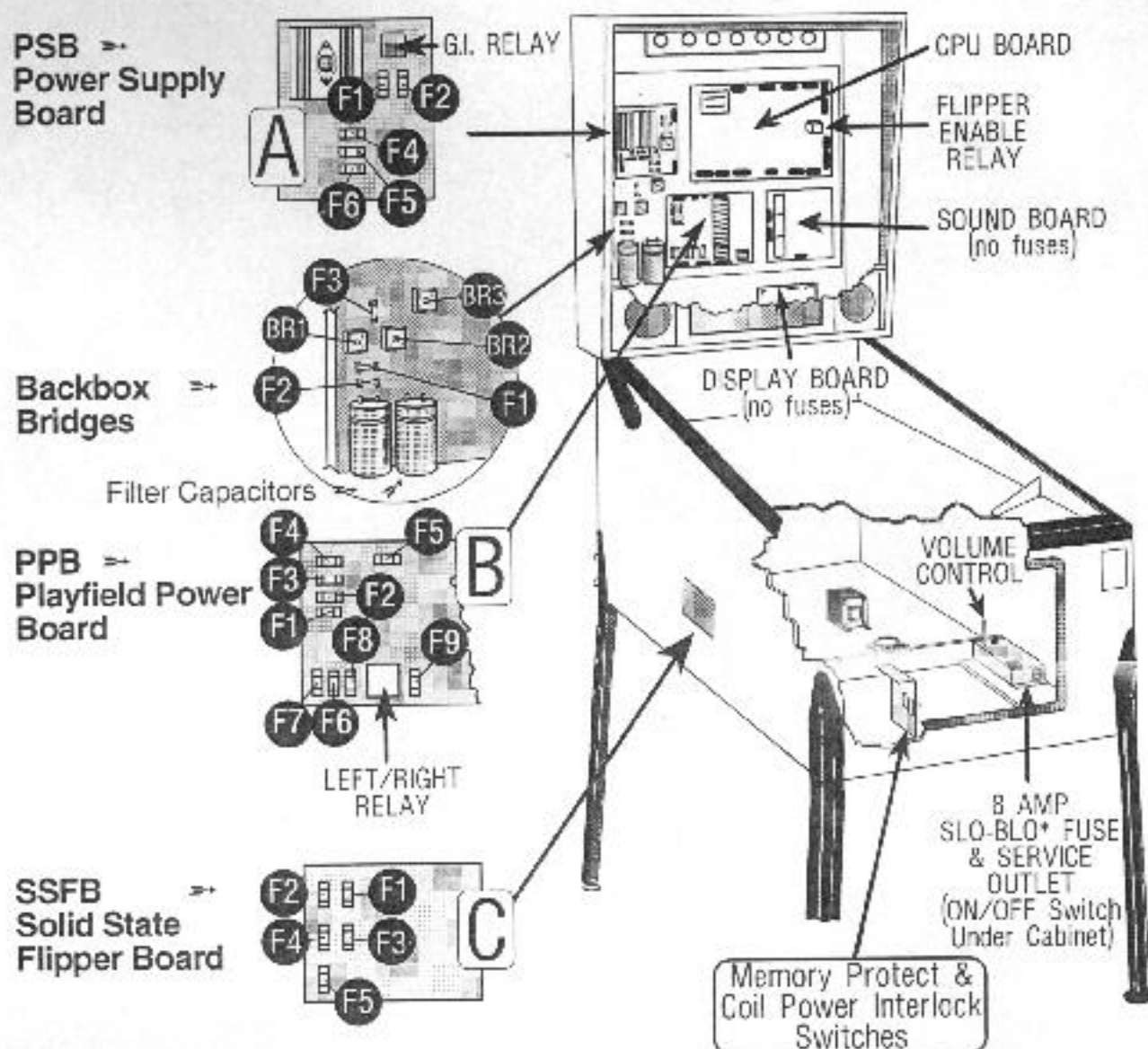

Note: Backbox Part Numbers on Page 38.

Service Switches are located on the Coin Door.

A: In the Backbox	B: In the Backbox	C: In the Cabinet	In the Backbox
<b>Power Supply Board PSB</b>	<b>Playfield Power Board PPB</b>	<b>Solid State 3-Flipper Bd. SSFB</b>	<b>Backbox Bridges Mounted in Backbox</b>
F1 7A Slo-Blo -5VDC Regulator Input (9vAC)	F1 G.I. 5A Slo-Blo Playfield	F1 3A 250v Slo-Blo 50v DC Output (All Fuses) Lower Right Flipper	F1 8A Slo-Blo 32v DC BR2 Coils/Flashers
F2 7A Slo-Blo -5VDC Regulator Input (9vAC)	F2 G.I. 5A Slo-Blo Backbox Dr./Spkr. Panel	F2 3A 250v Slo-Blo 9v AC Holding	F2 8A Slo-Blo 18v DC BR1 Lamps
F3 Not Used	F3 G.I. 5A Slo-Blo Playfield & Coin Door	F3 3A 250v Slo-Blo 50v DC Output Left Flipper	F3 8A Slo-Blo 18v DC BR3 Display
F4 8A Slo-Blo Switched Illum/In Buss (18vDC)	F4 G.I. 5A Slo-Blo Backbox Door	F4 3A 250v Slo-Blo 9v AC Holding	<b>Cabinet Fuses</b>
F5 4A Slo-Blo Solenoid (32vDC) Bumpers, Slingshots, etc.	F5 50v 5A Flippers (All 50v Coils)	F5 3A 250v Slo-Blo 50v DC Output Upper Right Flipper	Main Fuse Line: 8A Slo-Blo 250v International 2X 4A Slo-Blo 250v
F6 5A Slo-Blo Solenoid Buss (34vDC) L/R Relay Coils/Flash	F6 32v Flash Lamps 3A Slo-Blo/Right		
	F7 32v 3A Coils/Flash Right/Left		
	F8 50v 4A / 50v Coils		
	F9 50v 5A Laser Kick		



# GAME OPERATION & FEATURES

## Standard Features

Insert coin(s), the game generates a sound ("SEGA!") for the first credit & for each subsequent coin(s) and the display indicates the number of credit(s) posted. Depress the Start Button and a start-up sound is produced, the posted credit(s) are reduced by one. The display now indicates the player or # of players selected from the total depressions of the credit button. The display indicates the ball in play, and a ball is served to the shooter lane. Additional players may be added by pressing the Start Button before the end of ball 1. At game start, an introduction is shown followed by Skill Shot Graphics. Depressing the Start Button after ball 1 of any player will start a new game (if credits are available) only if button is depressed for 2-3 seconds. This delay is to avoid accidental 're-starts' of a game. (Note: Any 1/2 credit remaining during game play after the end of ball 1, or power down, will be eliminated.)

The second closure (adjustable) or prolonged closure of the plumb bob tilt switch tilts the ball in play. Closure of the slam tilt switch on the coin door ends the current game(s).

At the end of each ball, earned bonuses are collected. If the player enabled the EB Buy-In Feature\*, the player now has the option of purchasing an extra ball to continue game play (See Extra Ball (EB) Buy-In Feature below). Otherwise, the system produces a random 2-digit number (a multiple of 10; 00 to 90) for a Match feature (adjustable). Matching the last two digits of a player score with this number awards a credit. Some geographical areas do not allow the award of a free game, this can be adjusted with Adj. 4, Replay Award. Players exceeding high score levels receive free credits (adjustable) and are able to enter their initials with the new High Score achieved. To enter your initials, use the left & right flipper buttons to choose letter or character as seen on the Visual Display. Hitting the Start Button locks the letter or character in. Proceed with the 2nd & 3rd letter. The game then proceeds into the game-over mode and then to the attract mode. A custom message (adjustable) can be displayed during the attract mode.

## \*Extra Ball (EB) Buyin Feature

An option to add an extra ball(s) after the game is finished. TO ACTIVATE THE **EXTRA BALL BUY-IN FEATURE**, THE PLAYER MUST PRESS THE EB BUY-IN BUTTON DURING THE COURSE OF THE GAME. At the end of normal game play, the same player may choose to continue the game at the same score and features active by pressing the EXTRA BALL BUTTON prior to the expiration of the 'countdown timer.' Pressing the START BUTTON or BOTH FLIPPERS SIMULTANEOUSLY cancels this feature. If the player does not have any credits, the player will get 'more time' to add credit. The number of extra balls which can be added to a game can be adjusted with Adj. 38, Extra Ball Buyin Count. Default is 1. Set to 1, will allow only 1 extra ball to be purchased per game. Set to **UNLIMITED**, after the end of the game the countdown will appear after the end of each ball for the option of purchasing another extra ball. Set to 0, will make this feature unavailable.

## Manual Percentaging

This game is equipped with Manual Percentage Adjustment. As previously with our games, you can either set operator adjustments for a replay percent or you can set a fixed replay score.

If you set operator adjustments for a particular replay percent, the game will compute a recommended score to keep the game at that replay percentage. If a change is recommended and the game coin door is opened, the display will indicate a recommended replay score to beat and make a sound to alert the operator. By pressing the start button, the score to beat will be changed to the recommended level. If you close the coin door or go into Audit or Adjustment Mode, no score change will be made.

You may choose to ignore the recommended change; for example, you may not think last week's players were the usual crowd. Just close the door and the message will disappear without altering the existing level. Or you may choose to make a different score to beat adjustment; this is done by utilizing Adj. 02, Starting Replay Score.

## Playfield Overview and Game Rules (See the following pages)

The following pages describe the Game Rules. On the next page is a playfield overview to show the locations of of the featured items. Your game includes an instruction card. The instruction card on the next page may be photo-copied as a temporary replacement if required. Please note, rules and featured items may be subject to change through production.

## Playfield Overview & Game Rules

# MARY SHELLEY'S FRANKENSTEIN

TRAP DOORS TO LEFT (LONG TROUGH) & RIGHT (SHORT TROUGH) CREATURE HANDS

LARGE RAMP EXIT GATE

UPPER LEVEL RAMP WITH TRAP DOORS TO CREATURE

1-WAY GATE TO BALL EJECT

BALL EJECT

TURBO BUMPER

ENTRANCE TO UPPER SCOOP (WITH KICK-BIG)

TURBO BUMPERS

SQUARE STAND-UP TARGET

ENTRANCE TO LOWER SCOOP (WITH KICK-BIG)

RECTANGLE STAND-UP TARGETS

RAMP EXIT HOLE TO LEFT RETURN LANE

SLINGSHOTS

LEFT RETURN LANE

LOWER FLIPPERS

LEFT OUTLANE

KICK BACK (UNDER ARCH)

3-BALL TROUGH (UNDER METAL ARCH)

START & EXTRA BALL BUYIN BUTTONS (ON FRONT OF CABINET)

DIVERTER ASSEMBLY (UNDER THE RAMPS)

FRANKENSTEIN'S CREATURE; (WHICH CAN HOLD 1 BALL IN EACH HAND TO THROW)

VERTICAL UP-KICKER (VUK)

LARGE RAMP

RAMP ENTRANCE GATE

SPINNER

NARROW STAND-UP TARGET

SQUARE STAND-UP TARGET

UPPER FLIPPER

RECTANGLE STAND-UP TARGET

WIRE RAMP FROM UPPER LEVEL RAMP TO RIGHT RETURN LANE

1-WAY SHOOTER LANE GATE

ADJUSTABLE POST TO SHORTEN OR WIDEN RIGHT OUTLANE ENTRANCE (UNDER BUTYRATE)

SHOOTER LANE

RIGHT RETURN LANE

RIGHT OUTLANE

BALL AUTO LAUNCH (UNDER BUTYRATE) CONNECTS WITH:

LEVER ASSEMBLY ("THE SWITCH")

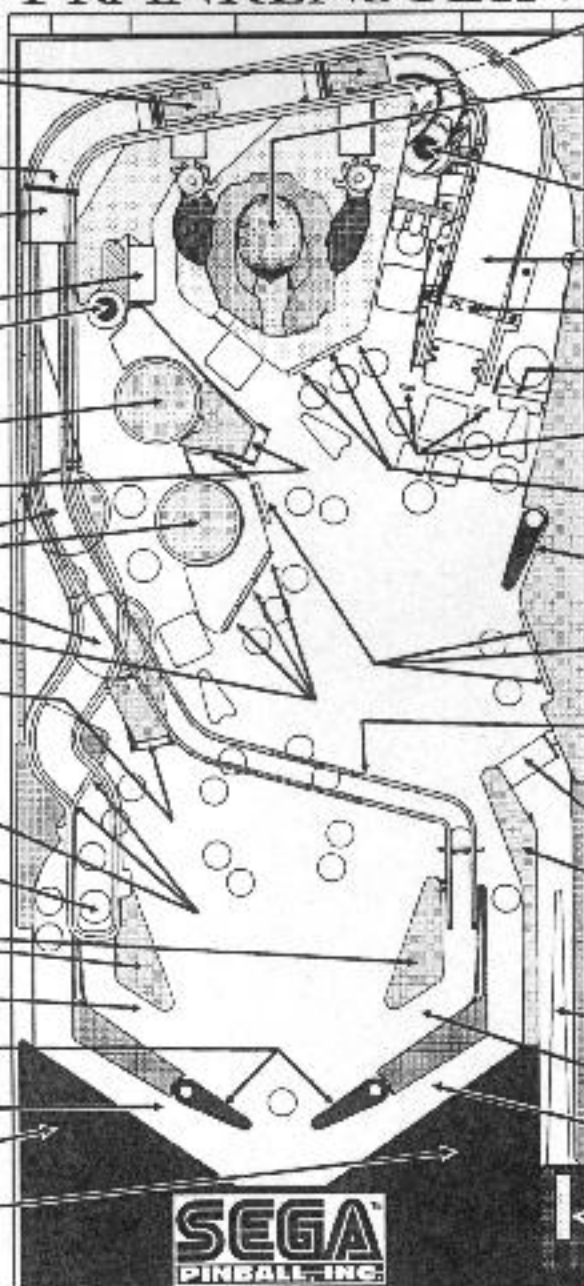

Cut & Copy



### MARY SHELLEY'S FRANKENSTEIN

**Skill Shot** → Throw *The Switch* to collect value highlighted in display.

**Frankenstein** → Complete **FRANKENSTEIN** Targets to start flashing feature. Shoot *Change Scene* to advance feature; **North Pole**, **Sarcophagus** and **Ice Cave** spot target(s).

**Multiball** → Shoot ramp to light lock, then lock ball at the **North Pole** (*Vertical Up-Kicker*) for 2-BALL PLAY. Relock balls at the **North Pole** for 3- to 6-BALL PLAY, then shoot for **JACKPOTS**.

**Geneva** → Shoot **GENEVA** (*Lower Scoop*) when lit to collect *Geneva Letter*. Complete for *Geneva Multiball*. Relight by shooting the *Left Orbit* or *Right Inlane*.

**Alive!** → Ball drains in *Left Outlane* will return to play when lit. Relight *Alive* (*Kick-Back*) by shooting the *Ice Cave*.

**Sarcophagus** → Shoot the *Sarcophagus* (*Upper Scoop*) when lit for accumulated value. Light by shooting the *Left Orbit*.

**Ice Cave** → Shoot the *Ice Cave* (*Ball Eject*) for award during 1-BALL PLAY.

**Hint** → Pressing the *Extra Ball Buyin Button* during the course of a game activates the *Extra Ball Buyin Feature* at the end of game play!

The Switch →

© 1994 SEGA PINBALL, INC. 766-6070-00



MBBY  
 (MPS)  
 BINS  
 URE:  
 LL IN  
 ROW)  
 VUK)  
 AMP  
 ATE  
 NER  
 UP  
 GET  
 UP  
 GET  
 PER  
 UP  
 GET  
 ER  
 HT  
 NC  
 TE  
 CO  
 EN  
 DE  
 in  
 in  
 TE  
 H  
 CO  
 R:  
 Y  
 Y

## Game Rules for

# MARY SHELLEY'S FRANKENSTEIN



## Skill Shot

Throw **The Switch** to score the shifting value indicated in the display.



## Ice Cave

Shoot the **Ice Cave** (*Ball Eject*) during 1-Ball Play for a random award. The **Ice Cave**

also spots 2 letters of **FRANKENSTEIN**. When **Alive** (*Kickback Feature*) is not lit, the **Ice Cave** relights it.



## Pop Bumpers

**Pop Bumpers** start at 250K per hit. The last **Pop Bumper** to be hit will flash. **Pop**

**Bumper** values are increased by the *Left Inlane to Spinner Shot*, adding 50K per spin to the flashing **Pop Bumper**. Bumpers can also be increased via the **Ice Cave** awards.



## Sarcophagus

The **Sarcophagus** (*Upper Scoop*) starts each ball with a base value of 5M. When the

*Scoop* is unlit, each shot increases this value by 5M. The *Left Orbit* lights the *Scoop* for collection. Making the *Left Orbit* to *Scoop* Combo gives double the value. The **Sarcophagus** also spots 1 **FRANKENSTEIN** Letter: 2 when lit, 1 if not lit.



## North Pole

During 1-Ball Play, the **North Pole** (*Vertical Up-Kicker* or *VUK*) spots 1 **FRANKEN-**

**STEIN** Letter, or 2 letters on an *Inlane* to *VUK* Combo. **Extra Ball** is also collected at the **North Pole** when lit. The **North Pole** is also used to lock balls and start **Multiball**.

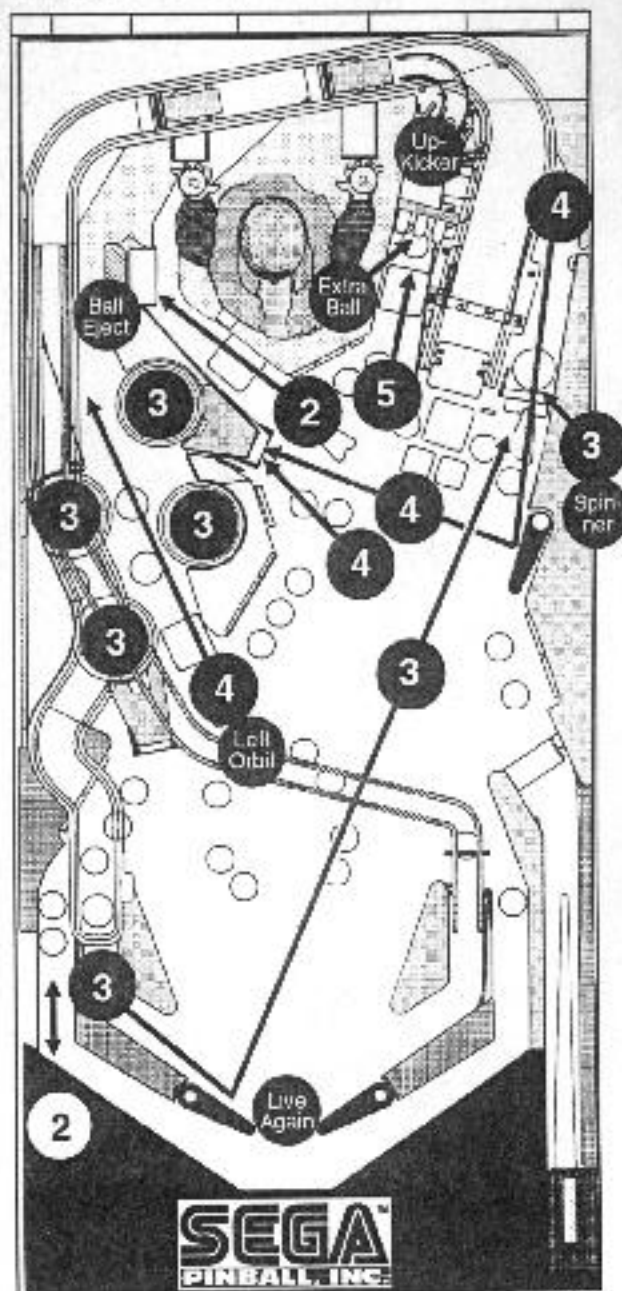



## Ingolstadt

During **1-Ball Play**, the **Ingolstadt Spinner** scores 100K per spin. An **Inlane** to

**Spinner Combo Shot** adds 50K per spin to whichever **Pop Bumper** is flashing and scores 200K per spin. The **Ice Cave** may award "spinner at max" — 300K per spin.



## Geneva

Shooting **Geneva (Lower Scoop)** when lit adds a Letter to **GENEVA**. The **Scoop**

starts each ball lit, and after collection may be subsequently lit by shooting the **Left Orbit** (or by the **Right Inlane** for a short time). Completing **GENEVA** starts **Geneva Multiball**.



## Alive

The **Left Outlane** provides the **Alive** feature (**Kick-Back**).

When lit, if ball drains down the **Left Outlane** the ball will be "kicked-back" into play. Relight **Alive** by shooting the **Ice Cave**.



## Double Bonus

When lit, the **Right Outlane** doubles the player's end-of-ball bonus.



## Extra Ball

An **Extra Ball** is collected at the **VUK** whenever it is lit during game play.

# Game Rules for MARY SHELLEY'S FRANKENSTEIN

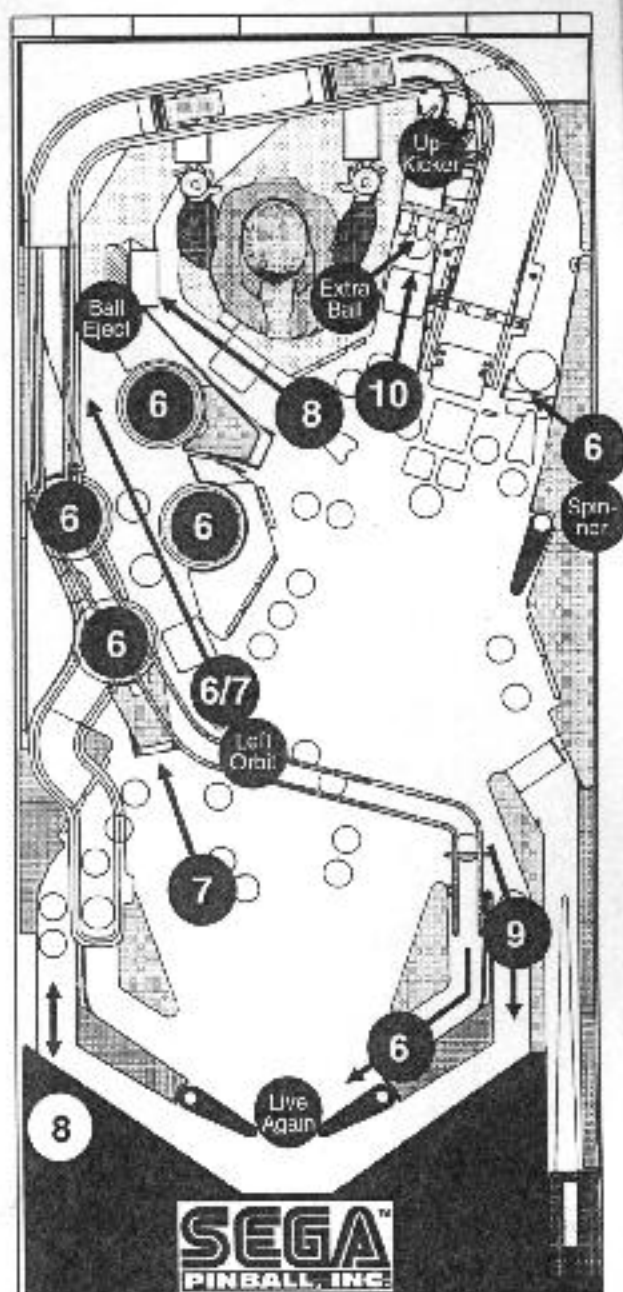



## Frankenstein Features:

One of the following eight Features (Frankenstein Millions, Stoning, Creature Feature, Lynch Justine, North Pole, Lite Extra Ball, Voltage Mode & Graveyard) are started whenever a player completes the **FRANKENSTEIN TARGETS** on the playfield. The player may be spotted letters as detailed above. After completing all eight features, a **6-Ball Multiball** feature will be available. Shooting the **CHANGE SCENE TARGET** changes the next feature.



### Frankenstein Millions

**Frankenstein Targets** are flashing to score million values - 6M per target for the first 6, 8M per target for the next 3, and 10M per target thereafter. This is a timed round that lasts 30 seconds.



### Stoning

A fast-scoring round that last 30 seconds. Switch values start at 250K and increase based on the number of *switch closures* made.



### Creature Feature

*Ramp Shots* score millions - try to make 8 shots to spell **CREATURE** before the timer expires for a bonus. Inlane to Ramp shot may give 2 letters...



### Lynch Justine

Shoot the *Left Orbit* for successive *Hurry-Up Values*. — 3 shots to complete...

## Game Rules for MARY SHELLEY'S FRANKENSTEIN

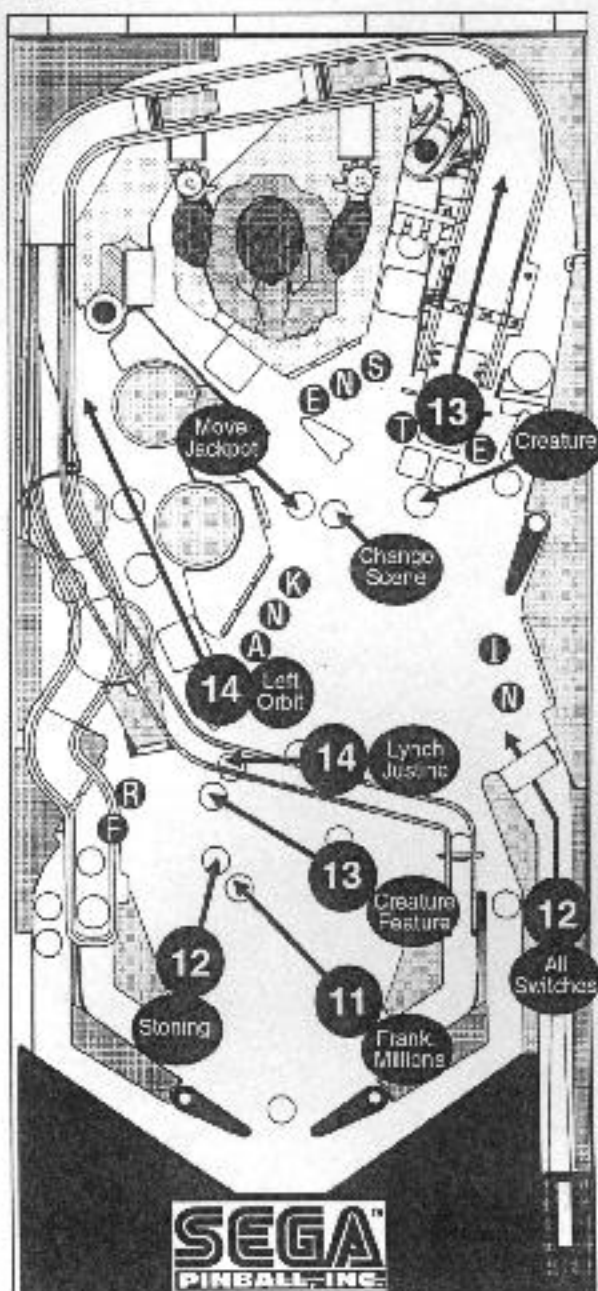

## Frankenstein Features Continued:



### North Pole

Shoot the **North Pole** (Up-Kicker) for countdown value.



### Lite Extra Ball

Lights **Extra Ball** at the **North Pole** for **LIVE AGAIN**.



### Voltage Mode

One of the four **Jackpots** is lit — shoot it before the **Voltmeter** indicates low power. If successful, another **Jackpot** is lit which must be shot before the **meter** indicates an overload. All four **Jackpots** will be lit.



### Graveyard

Various holes (Up-Kicker, Eject or Scoops) are lit to collect **Body Parts**. Collect 2

**Legs**, 2 **Arms**, a **Torso**, and a **Brain** for Score and Completion Bonus.

**COMPLETE ALL MODES FOR SECRET CREATION 3-6 BALL FEATURE WITH BIG MONSTER POINTS!**

## Game Rules for MARY, SHELLEY'S FRANKENSTEIN

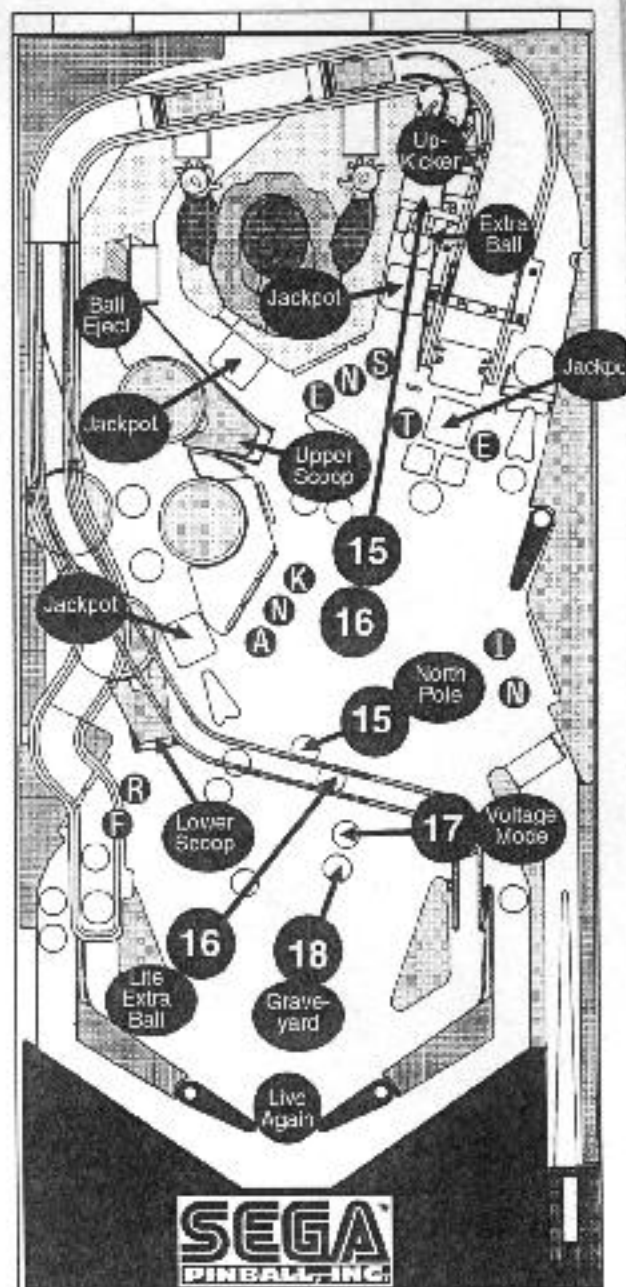



## Multiball Features:

Game Rules for

MARY SHELLEY'S

# FRANKENSTEIN



### Multi-Ball Ready

Shoot the Ramp to light Lock. Lock ball at the **North Pole (VUK)** for 2-Ball Play. Re-lock balls at the **North Pole** and after locking 1st ball, a timer starts with a countdown value of 59M. Shoot the **North Pole** again before timer expires to start **3-6 Ball Multiball**. The player's timing is important. A successful shot into the VUK very quickly will start 6-Ball Multiball; the longer it takes the player to shoot the VUK will determine if 3-5 Ball Multiball will be initiated.



### Multiball Jackpots

At the beginning of **Multiball**, two **Jackpots** are lit. These **Jackpots** may be shifted to a new location by hitting the **MOVE JACKPOT TARGET**. During **Multiball**, the **Spinner** increases the **Jackpot Value** by 1M per spin.

During this period **FRANKENSTEIN** Letters are being scored as well as **Jackpots** — completing the two **Jackpots** and all the letters lights **CREATURE JACKPOT** at the **Ramp**. Also, completing the two **Jackpots** adds one more ball into play.

Scoring **CREATURE JACKPOT** lights the **Sarcophagus (Upper Scoop)** for 50M. Shooting the **Sarcophagus** lights a roving **SUPER JACKPOT**. Once the **SUPER JACKPOT** is scored, the **Multiball Sequence** recycles, only with four **Jackpots** lit instead of two.

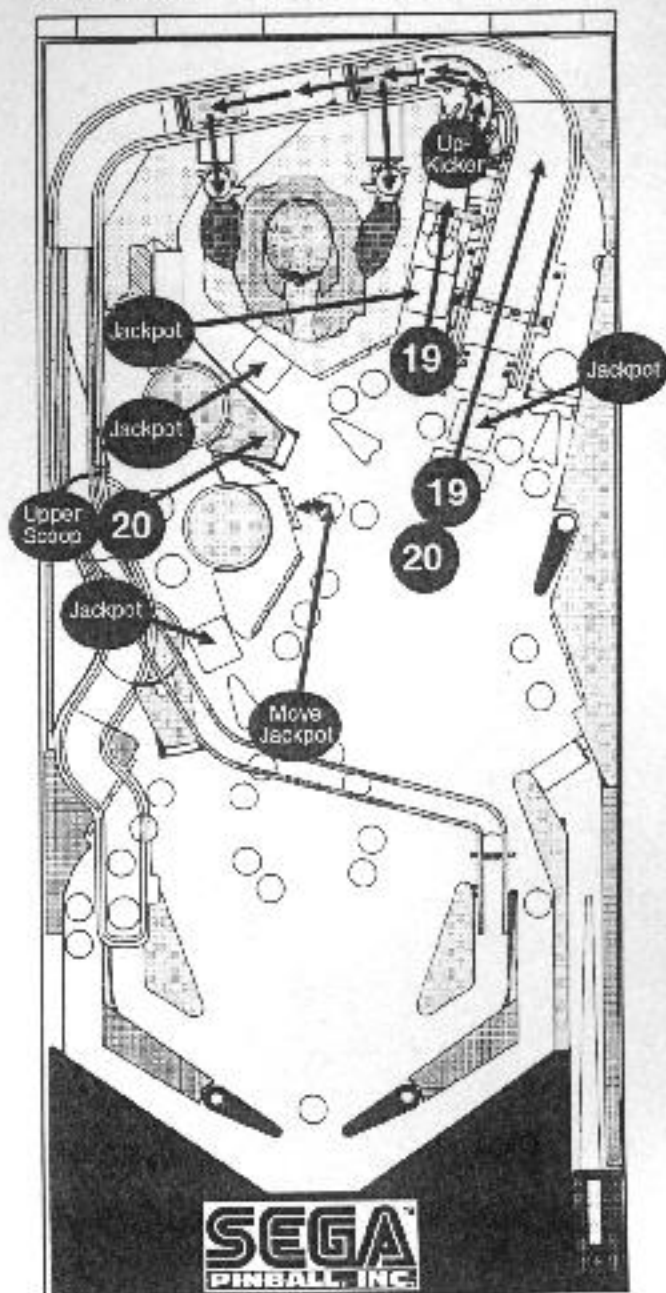



# AUDIT FUNCTIONS

## General

There are 67 audit functions provided for accounting purposes and for evaluation of game difficulty adjustments. Audit functions are split into two groups. There are 12 most-used audits (1 through 12) in a 'quick look' group and 55 less-used audits (13 through 67), in an 'Expanded' Group. The various auditing functions are summarized in the **GAME AUDIT TABLE** and, when accessed, are shown on the Dot Matrix Display. The *Audit Number* is shown in the top of the display, the *Description* is shown next and the *Audit Total* in the display. Access and control is provided from switches located on the inside of the coin door.

To access audit functions, open the coin door and make sure that the **FORWARD/REVERSE** switch is in the **FORWARD** (up) position. Depress the **STEP** switch and the display indicates **AUDITS & ADJUSTMENTS**. This indicates access to audit functions.

With the **FORWARD/REVERSE** push-button switch still in the **FORWARD** (up) position, depressing the **STEP** push-button switch advances through the audit functions one at a time. To review lower-numbered functions, set the forward/reverse push-button switch to the **REVERSE** (down) position and operate the **STEP** push-button switch.

To access expanded audits, operate the step push-button until **AUDIT 12, Expand Audits** is displayed. Set the choice to **YES** as indicated in the lower display by depressing the Game Start push-button and then depress the step push-button. The request is installed and Audit 13 is displayed. When you exit audits and adjustments, the Audit 12 setting is returned to off for the next time that a review of audits are required.

Audit totals (except for Audits 1, 5-11) may be reset to zero using Game Adjustment **ADJUSTMENT 10, Reset Game Audits**. Game adjustments (1 to 12 and 13 to 62) begin after the last audit function (12 or 67). Once audits functions have been recorded, and if no adjustments are required, you may return the game to the attract mode. If adjustments are required, continue pressing the **STEP** button until the game adjustments are reached. See Game Adjustments for details.

## Audits - 'Quick Look' Functions (Au. 1 - 12)

Au. #	Audit Name	Audit Definition
Au. 1	<b>Total Paid Credits</b>	The total number of paid credits is displayed.
Au. 2	<b>Free Game Percentage</b>	The Total Free Plays (Audit 25) divided by Total Plays (Audit 26).
Au. 3	<b>Average Ball Time</b>	(In Seconds) The Total Play Time divided by Total Balls Played (Audit 13).
Au. 4	<b>Average Game Time</b>	The Average Game Time expressed in minutes and seconds.
Au. 5	<b>Coins Thru Left Slot</b>	The total amount of coins registered through the left slot.
Au. 6	<b>Coins Thru Right Slot</b>	The total amount of coins registered through the right slot.
Au. 7	<b>Coins Thru Center Slot</b>	The total amount of coins registered through the center slot.
Au. 8	<b>Coins Thru 4th Slot</b>	The total amount of coins registered through the fourth slot.
Au. 9	<b>Total Coins</b>	The total number of coins dropped through all four coin slots.
Au. 10	<b>Total Earnings</b>	The total cash value accumulated since the last Factory Restore occurred.
Au. 11	<b>Meter Clicks</b>	Provides the total number of money clicks accumulated, based on the country's lowest coin denomination used for the game credit.
Au. 12	<b>Expand Audits?</b>	(On/Off) This audit permits operator to proceed into expanded audits.



MARY SHELLEY'S  
FRANKENSTEIN

Game Audit Table

Item/Description		Item/Description	
1	TOTAL PAID CREDITS	35	PROPRIETARY
2	FREE GAME PERCENTAGE	36	PROPRIETARY
3	AVERAGE BALL TIME	37	PROPRIETARY
4	AVERAGE GAME TIME	38	TOTAL BUYIN GAMES
5	COINS THRU LEFT SLOT	39	TOTAL EXTRA BALL BUYINS
6	COINS THRU RIGHT SLOT	40	EXTRA BALL BUYIN REPLAYS
7	COINS THRU CENTER SLOT	41	EXTRA BALL BUYIN HSTD
8	COINS THRU 4TH SLOT	42	LEFT DRAINS
9	TOTAL COINS	43	CENTER DRAINS
10	TOTAL EARNINGS	44	RIGHT DRAINS
11	METER CLICKS	45	SLAM TILTS
12	EXPAND AUDITS?	46	BALLS SAVED
13	TOTAL BALLS PLAYED	47	RAMP SHOTS
14	TOTAL EXTRA BALLS	48	MISSED RAMP SHOTS
15	EXTRA BALL PERCENT	49	VUK SHOTS
16	REPLAY 1 AWARDS	50	CENTER SCOOP SHOTS
17	REPLAY 2+ AWARDS	51	EJECT SHOTS
18	TOTAL REPLAYS	52	LOWER SCOOP SHOTS
19	REPLAY PERCENT	53	RIGHT ORBITS
20	TOTAL SPECIALS	54	LEFT ORBITS
21	SPECIAL PERCENT	55	FRANKENSTEIN COMPLETED
22	TOTAL MATCHES	56	CREATION SCENES STARTED
23	HIGH SCORE AWARDS	57	2-BALL MULTIBALL READY
24	HIGH SCORE PERCENT	58	2-BALL MULTIBALL STARTED
25	TOTAL FREE PLAYS	59	BALLS LOCKED
26	TOTAL PLAYS	60	1ST MULTIBALL STARTED
27	0.0M TO 99.9M	61	MULTIBALL RESTARTS
28	100.0M TO 199.9M	62	2ND+ MULTIBALL STARTED
29	200.0M TO 299.9M	63	JACKPOTS SCORED
30	300.0M TO 499.9M	64	CREATURE JACKPOTS SCORED
31	500.0M TO 999.9M	65	SUPER JACKPOTS SCORED
32	1.0B+ SCORES	66	GENEVA MULTIBALL STARTED
33	AVERAGE SCORES	67	GENEVA MULTIBALL JACKPOTS
34	SERVICE CREDITS		

Au.#  
Au. 13  
Au. 14  
Au. 15  
Au. 16  
Au. 17  
Au. 18  
Au. 19  
Au. 20  
Au. 21  
Au. 22  
Au. 23  
Au. 24  
Au. 25  
Au. 26  
Au. 27  
Au. 28  
Au. 29  
Au. 30  
Au. 31  
Au. 32  
Au. 33  
Au. 34

## Audits - 'Expanded' Generic Functions (Au. 13 - 38)

Au.#	Audit Name	Audit Definition
Au. 13	<b>Total Balls Played</b>	The total of regular and extra balls.
Au. 14	<b>Total Extra Balls</b>	The total number of extra balls awarded.
Au. 15	<b>Extra Balls Percent</b>	The Total Extra Balls (Au.14) divided by Total Plays (Au. 26).
Au. 16	<b>Replay 1 Awards</b>	The total awards (credit, extra ball, or audit) for level 1.
Au. 17	<b>Replay 2+ Awards</b>	The total awards (credit, extra ball, or audit) for level(s) 2 or higher.
Au. 18	<b>Total Replays</b>	The total awards (credits, extra balls, or audit only) for exceeding replay score levels.
Au. 19	<b>Replay Percent</b>	The Replay Total awards for exceeding replay score levels. Total Replays (Au. 18) divided by Total Plays (Au. 26).
Au.20	<b>Total Specials</b>	The total awards (credits, extra balls, or scores) for making specials.
Au. 21	<b>Special Percent</b>	The Total Specials (Au. 20) divided by Total Plays (Au. 26).
Au. 22	<b>Total Matches</b>	The total credits awarded for matching the last two digits of the score with the system-generated Match Number at the end of the game. Percentage of match credits will be adjustable from 0% to 10%, by Adj. 13 (Match Percentage), if enabled.
Au. 23	<b>High Score Awards</b>	The total credits awarded for exceeding the High-Score-To-Date scores.
Au. 24	<b>High Score Percent</b>	The High Score Awards (Au. 23) divided by Total Plays (Au. 26).
Au. 25	<b>Total Free Plays</b>	The total free credits for replays, High-Score-To-Date, Specials, and Match.
Au. 26	<b>Total Plays</b>	The sum of Total Paid Credits (Au.1) and Total Free Plays (Au. 25). Note that free credits are not recorded in the Audit until they are actually used.
Au. 27	<b>0.0M to 99.9M</b>	Provides the total number of games the Player's final score was between 0 and 99,999,990 points.
Au. 28	<b>100.0M to 199.9M</b>	Provides the total number of games the Player's final score was between 100,000,000 and 199,999,990 points.
Au. 29	<b>200.0M to 299.9M</b>	Provides the total number of games the Player's final score was between 200,000,000 and 299,999,990 points.
Au. 30	<b>300.0M to 499.9M</b>	Provides the total number of games the Player's final score was between 300,000,000 and 499,999,990 points.
Au. 31	<b>500.0M to 999.9M</b>	Provides the total number of games the Player's final score was between 500,000,000 and 999,999,990 points.
Au. 32	<b>1.0B+ Scores</b>	Provides the total number of games the Player's final score was over 1,000,000,000 points.
Au. 33	<b>Average Scores</b>	Provides the Average Score by adding the Final Score of each game to a table and dividing this sum by the Total Plays (Au. 26).
Au. 34	<b>Service Credits</b>	Provides the total number of Service credits added to the game. See <i>Game Diagnostics</i> on page 29 for instructions regarding entry of Service Credits.
Au. 35, 36, 37	<b>Proprietary</b>	Provides information to the game designer to aid in design development (not for consumer use).
Au. 38	<b>Total Buyin Games</b>	Provides the number of times a player utilized the Buyin Feature.

### Audits - 'Expanded' Generic Functions (Au. 39 - 46)

Au.#	Audit Name	Audit Definition	Au.#
Au. 39	<b>Total Extra Ball Buys</b>	Provides the total number of times the Extra Ball Buyin Feature was used.	Au. 63
Au. 40	<b>Extra Ball Buyin Replays</b>	Provides the total number of replay awards that resulted from the use of the Total Extra Ball Buys (Au. 39) Feature.	Au. 64
Au. 41	<b>Extra Ball Buyin HSTD</b>	Provides the total number of times in which use of the Extra Ball Buyin Feature resulted from beating the High-Score-To-Date (HSTD).	Au. 65
Au. 42	<b>Left Drains</b>	Provides the number of times the ball drained out the left drain.	Au. 66
Au. 43	<b>Center Drains</b>	Provides the number of times the ball drained out the center drain.	Au. 67
Au. 44	<b>Right Drains</b>	Provides the number of times the ball drained out the right drain.	
Au. 45	<b>Slam Tilts</b>	Provides the number of times the Slam Tilt switch was activated.	
Au. 46	<b>Total Balls Saved</b>	Provides the total number of times the Total Balls Saved Feature was used. This feature is enabled at the start of each ball and is disabled as soon as the ball makes contact with 5 game switches or allocated time expired.	

### Audits - 'Expanded' Game Specific Functions (Au. 47 - 62)

Au.#	Audit Name	Audit Definition
Au. 47	<b>Total Ramp Shots</b>	Provides the total number of times the Right Ramp was scored.
Au. 48	<b>Missed Ramp Shots</b>	Provides the total number of times the Right Ramp was missed.
Au. 49	<b>VUK Shots</b>	Provides the total number of times the VUK was scored.
Au. 50	<b>Center Scoop Shots</b>	Provides the total number of times the Center (Upper) Scoop (Sarcaphogus) was scored.
Au. 51	<b>Eject Shots</b>	Provides the total number of times the Ball Eject was scored.
Au. 52	<b>Lower Scoop Shots</b>	Provides the total number of times the Lower Scoop (Geneva) was scored.
Au. 53	<b>Right Orbits</b>	Provides the total number of times the Right Orbit was scored.
Au. 54	<b>Left Orbits</b>	Provides the total number of times the Left Orbit was scored.
Au. 55	<b>Frankenstein Completed</b>	Provides the total number of times the total letters of F R A N K E N - S T E I N were completed.
Au. 56	<b>Creation Scene Started</b>	Provides the total number of times the Creation Scene Feature was started.
Au. 57	<b>2-Ball Multiball Ready</b>	Provides the total number of times 2-Ball Multiball Feature was ready.
Au. 58	<b>2-Ball Multiball Started</b>	Provides the total number of times 2-Ball Multiball Feature was started.
Au. 59	<b>Ball Locked</b>	Provides the total number of times balls were locked in Creature's hands.
Au. 60	<b>1st Multiball Started</b>	Provides the total number of times the 1st Multiball Feature was started.
Au. 61	<b>Multiball Restarts</b>	Provides the total number of times the Multiball Feature was restarted.
Au. 62	<b>2nd+Ball Started</b>	Provides the total number of times 2+ Multiball was started.



## Audits - 'Expanded' Game Specific Functions (Au. 63 - 67)

Au.#	Audit Name	Audit Definition
Au. 63	<b>Jackpots Scored</b>	Provides the total number of times the Jackpots were scored.
Au. 64	<b>Creature Jackpots Scored</b>	Provides the total number of times the Creature Jackpots were scored.
Au. 65	<b>Super Jackpots Scored</b>	Provides the total number of times the Super Jackpots were scored.
Au. 66	<b>Geneva Multiball Started</b>	Provides the total number of times Geneva Multiball was started via the lower scoop by spelling G E N E V A.
Au. 67	<b>Geneva Multiball Jackpots</b>	Provides the total number of times Geneva Multiball Jackpots were scored.

# Audit Notes

## General

There are 60 score levels accessed, a Description switches loc

Game adjust

## REVERSE

at the top of the display. (up) position is shown in

With the FC through the lower-numbered value setting det the value i

## REQUES

## Replay

Replays 1 Four leve With the 1 computer player da This new closed o

## Adj.#

Adj. 1

Adj. 2

Adj. 3

Adj. .

Adj.

Adj.

# GAME ADJUSTMENTS

## General

There are 62 adjustable functions provided to vary difficulty of play and to periodically reset audits and the high score levels. The various game adjustments are summarized in the **Game Adjustments Table** and, when accessed, are shown on the player score display. The *Adjustment Number* is shown in the top of the display, the *Description* is shown next, and the setting, in the bottom of the display. Access and control is provided from switches located on the inside of the coin door.

Game adjustments are accessed from the audit mode. With the audits displaying **AUDIT 1** and the **FORWARD/REVERSE** switch in the **REVERSE** (down) position, depress the **STEP** switch and **ADJUSTMENT 99** is shown at the top of the display, *Factory Restore* is shown in the middle of the display, and **NO** is shown in the bottom of the display. With the audits displaying **AUDIT 10** or **99** and the **FORWARD/REVERSE** switch in the **FORWARD** (up) position, depress the **STEP** switch and **ADJUSTMENT 1** is shown in the top of the display, *Replay/Manual* is shown in the middle of the display, and the setting is shown in the bottom of the display.

With the **FORWARD/REVERSE** switch in the **FORWARD** (up) position, depressing the **STEP** switch advances through the game adjustments one at a time. With it in the **REVERSE** (down) position, the **STEP** switch selects lower-numbered adjustments. To rapidly scroll through adjustments, hold the **STEP** switch depressed. Adjustment values are changed by operating the **GAME START** push-button. The **FORWARD/REVERSE** switch setting determines whether the values are increased or decreased. (With the **FORWARD/REVERSE** switch up, the value increases, with it down, the value decreases). When the **STEP** switch is depressed the display indicates **REQUEST INSTALLED**.

## Replay And Generic Features

Replays may be adjusted either for fixed levels or for a system-adjusted manual percentage of replay awards. Four levels may be selected. Adjustments allow awarding of a credit or an extra ball as each level is exceeded. With the manual percentage feature, if the actual replay percentage is higher or lower than that desired, the game computes new recommended manual percentage score(s). When the coin door is subsequently opened the player displays indicate the recommended level and a sound is made to alert the operator of a potential change. This new level is entered into adjustments simply by pressing the game start push-button. (If the coin door is closed or you enter audits/adjustments or diagnostics, the replay level is not changed.)

### Adjustments - 'Replays' (Adj. 1 - 6)

Adj.#	Adjustment Name	Adjustment Definition
Adj. 1	Replays: Fixed/Manual	Adjust for percentage of awards for Replay Levels (1% through 50%). Proceed to Adj. 2 & 3 for Starting Replay Levels. Lower the automatic value to 0% and the display will indicate Fixed. Proceed to Adj. 2 & 3 for Fixed Replay Levels.
Adj. 2	Starting Replay Score	Adjust the Starting Replay 1 setting to between 100M and 9.99M.
Adj. 3	Replay Levels	Adjust the number of replay levels to be active (1 to 4). Any additional starting replay levels are automatically set to values higher than Replay 1. Adjust Replay 1 level to between 100M and 9.99M. (Same as Start Replay). If Adj. 3 is set for 2, 3, or 4, adjust Replay 2, 3, or 4 (respectively) level to between 100M & 9.99M.
Adj. 4	Replay Award	Set for replays to award: <b>CREDIT, EXTRA BALL, NONE</b> or <b>SPECIAL</b> (When score threshold is achieved, a Playfield Special is lit.)
Adj. 5	Free Game Limit	Adjust the max. # of free games that may be accumulated per game; <b>0 - 9</b> .
Adj. 6	Extra Ball Limit	Adjust the max. # of extra balls that may be accumulated per game; <b>1- 9</b> or <b>OFF</b> .



# MARY SHELLEY'S FRANKENSTEIN

## Game Adjustment Table

Adj. N°	Description	Factory Setting	Adj. N°	Description	Factory Setting
1	REPLAYS: FIXED/MANUAL	10%	33	FLASH LAMP POWER	Normal
2	STARTING REPLAY SCORE	900M	34	COIL PULSE POWER	Normal
3	REPLAY LEVELS †	1	35	GUARANTEED GAME TIME	0:00
4	REPLAY AWARD	Credit	36	NEXT GAME PROMOTION	Off
5	FREE GAME LIMIT	5	37	BUYIN TYPE	XBa
6	EXTRA BALL LIMIT	3	38	EXTRA BALL BUYIN COUNT	1
7	GAME DIFFICULTY †	Mod.	39	GAME RESTART	Yes
8	GAME PRICING †	USA 7	40	EXTRA BALL PERCENTAGE	25%
9	RESET COIN AUDITS	No	41	BACKGROUND MUSIC VOLUME	100%
10	RESET GAME AUDITS	No	42	BILL VALIDATOR	No
11	RESTORE HIGH SCORES	No	43	TOURNAMENT MODE	Off
12	EXPAND ADJUSTMENTS?	No	44	EXTERNAL REPLAY KNOCKER	Off
13	MATCH PERCENTAGE	09%	45	SPECIAL MEMORY	Yes
14	BALLS PER GAME	3	46	LASER KICK PRESENT	Yes
15	TILT WARNINGS	1	47	LASER KICK CRITERION	Mod.
16	REPLAY BOOST	Yes	48	GORE ALLOWED	Yes
17	CREDIT LIMIT	30	49	EASY MULTIBALL START	YES
18	ALLOW HIGH SCORES	Yes	50	MULTIBALL RESTART	Easy
19	AWARD FOR HIGH SCORE #1	3	51	ENABLE CREATURE THROW	Yes
20	AWARD FOR HIGH SCORE #2	1	52	CREATURE THROW PULSE	Normal
21	AWARD FOR HIGH SCORE #3	1	53	MULTIBALL DIFFICULTY	Mod.
22	AWARD FOR HIGH SCORE #4	0	54	EXTRA BALL MEMORY	Yes
23	DEFAULT HIGH SCORE #1	2.4M	55	RAMP MEMORY	Yes
24	DEFAULT HIGH SCORE #2	2.1M	56	EASY 2-BALL START	No
25	DEFAULT HIGH SCORE #3	1.95M	57	SOFTWARE METER	00
26	DEFAULT HIGH SCORE #4	1.8M	58	LOCATION ID	0
27	DEFAULT HIGH SCORE #5	1.65M	59	GAME ID	0
28	DEFAULT HIGH SCORE #6	1.5M	60	RESET PRINTER?	No
29	HSTD RESET COUNT	700	61	PRINTER INTERFACE	Press Start To Print
30	FREE PLAY	No	62	A.L.I.S.O.N. INTERFACE	See Adj. Definition
31	CUSTOM MESSAGE	Enable			
32	ATTRACT MODE MUSIC	On	99	Factory Restore	No

† Some settings result in Drop-Down Tables.  
Review the following pages which define all of  
the above adjustments.

## Game Difficulty (Adj. 7)

Adj.#	Adjustment Name	Adjustment Definition
-------	-----------------	-----------------------

Adj. 7 **Game Difficulty** Any one of five INSTALL settings for this adjustment may be activated to automatically select settings for multiple adjustments affecting game difficulty. Use the Start button to choose the difficulty level you require and press the step button to activate the setting. After activation, the individual adjustments may be readjusted if desired. Refer to Install Adjustment Table for details.

Set to **EXTRA EASY, EASY, FACTORY, HARD** or **EXTRA HARD**.  
 (Note: Additional game features are not adjustable in by the Expanded Adjustments may also change using this setting.)

	Install Adjustments	Adj. 7 Extra Easy	Adj. 7 Easy	Adj. 7 Moderate	Adj. 7 Hard	Adj. 7 Extra Hard
	(49) Multiball Restart	EXTRA EASY	EASY	EASY	HARD	EXTRA HARD
	(51) Multiball Difficulty	EXTRA EASY	EASY	MODERATE	HARD	EXTRA HARD
	(52) Extra Ball Memory	YES	YES	YES	YES	NO
	(53) Ramp Memory	YES	YES	YES	NO	NO

### NOVELTY / 5-BALL / ADD-A-BALL SETTINGS

The following three combinations are recommended for situations where local laws restrict certain game features regarding the use of replays or the number of balls per game:

#### Novelty Play Rules - Set to establish recommended settings for no free play or extra balls:

Adj.	Adj. Name	Setting	Adj.	Adj. Name	Setting
1	Replays: Fixed/Manual	Fixed	6	Extra Ball Limit	00
3	Replay Levels	None	13	Match Percentage	Off
4	Replay Award	None	19	Award for High Score #1	03
5	Free Game Limit	00	20	Award for High Score #2	01

#### 5-Ball Play Rules - Set to establish recommended settings for 5-ball play:

Adj.	Adj. Name	Setting	Adj.	Adj. Name	Setting
1	Replays: Fixed/Manual	07%	6	Extra Ball Limit	03
2	Starting Replay Score	1,500,000.000	13	Match Percentage	04
3	Replay Levels	01	14	Balls Per Game	05
4	Replay Award	Credit	19	Award for High Score #1	03
5	Free Game Limit	05	20	Award for High Score #2	01

#### Add-A-Ball Settings-To disable awarding of credits and provide awards with an extra ball:

Adj.	Adj. Name	Setting	Adj.	Adj. Name	Setting
4	Replay Award	Extra Ball	18	Allow High Scores	No
5	Free Game Limit	00	19-22	Award for High Score #1 - #4	00
13	Match Percentage	Off			

### TOURNAMENT MODE SETTINGS

Adj. 43, Tournament Mode determines the default conditions to quickly prepare a game for tournament play. When this setting is changed all audits will be reset and all adjustments will be initiated to the particular style selected. The game will then return to game over attract mode, as if a Factory Restore had been performed. **NONE** - Same as a Factory Reset conditions. **IFPA**-Straight 50c play, no replay, no Extra Ball, no High Scores, 2 Tilt Warnings and No Match. **PINBALL EXPO-PAPA**- Same as IFPA settings except Free Play is enabled. **HOME**-Sets game for Free Play, extra ball play, no replay, 10% Match & Extra Ball percent 30%.

## Game Pricing (Adj. 8)

There are two methods available for coin switch programming; Standard and Custom. Standard pricing uses a single adjustment (Adj. 8) to select a pricing scheme shown in the **Custom & Standard Pricing Tables**. Custom pricing is used to select additional pricing schemes defined by a Drop Down Menu.

With Adj. 8 set to **CUSTOM** operating the step button again initiates a drop down menu representing coin switch pulses for the left, right, center and fourth coin slots. The prescribed number of pulses are required for a credit. For example, if *Left Coin Pulses*, was set to 02 and *Coin Switch Pulses Required for 1 Credit*, to 01 and a coin is inserted in the left slot would produce two credits. Further, if *Left Coin Pulses*, was set to 01 and *Coin Switch Pulses Required for 1 Credit*, to 02, two coins in the left slot would be required for one credit.

*Coin Switch Pulses Required for Bonus Credit* may be set to post bonus credits when a minimum amount of coins are inserted at one time. For example, if *Left Coin Pulses* was set to 01, *Coin Switch Pulses Required for 1 Credit* to 01 and *Coin Switch Pulses Required for Bonus Credit* to 04, one credit would be posted for each of the first three coins in the left slot and two credits for the fourth coin.

**Standard/Custom Pricing** - Set for the desired pricing scheme from the Standard Pricing Table as indicated in the dot matrix display. For Custom Pricing, set to **CUSTOM**. When set to CUSTOM, the following adjustments are utilized to tailor each individual coin chute.

**Left Coin Switch Pulses** - Set the number of pulses registered for closure of the left coin switch; 00 to 99.

**Right Coin Switch Pulses** - Set the number of pulses registered for closure of the right coin switch; 00 to 99.

**Center Coin Switch Pulses** - Set the number of pulses registered for closure of the center coin switch; 00 to 99.

**4th Coin Switch Pulses** - Set the number of pulses registered for closure of the fourth coin switch; 00 to 99.

**Coin Switch Pulses Required for 1 Credit** - Set the number of coin switch pulses required to post one credit; 00 to 99.

**Coin Switch Pulses Required for Bonus Credit** - Set the number of coin switch pulses required to award the 1st bonus credit(s); 00 to 99.

**Coin Switch Pulses Required for 2nd Bonus Credit** - Set the number of coin switch pulses required to award the 2nd bonus credit; 00 to 99.

**Credits awarded for 1st Bonus** - Set the number of credits awarded for achieving the first Bonus level; 00 to 99.

### CUSTOM PRICING TABLE

Coin Mechs				Adjustments									
Left	Right	Center	4th	Plays/Coins		Left Pulses	Right Pulses	Mid Pulses	4th Pulses	Pulses /Credit	Pulses /Bonus	Pulses /2nd BONUS	Credits /1st BONUS
25c	25c	\$1.00	N/U	1/25c 3/50c	01	01	04	00	01	02	00	01	
				1/25c 5/\$1.00	01	01	04	00	01	04	00	01	
				1/25c 6/\$1.00	05	05	20	00	04	20	00	01	
5SCH	10SCH	10SCH	N/U	1/10 S	01	02	02	00	02	00	00	00	
				1/10 S 4/30 S	04	08	08	00	06	00	00	00	
10p	£1	50p	20p	1/30p 2/50p	01	15	06	02	03	00	00	00	
				5/£1	01	15	05	02	05	00	00	00	
				1/50p 3/£1	01	12	05	02	03	00	00	00	
				1/30p 4/£1									
20c	\$1.00	N/U	N/U	1/60c 2/\$1.00	01	05	00	00	03	05	00	01	



## Standard Pricing Table

Adj. 8 Standard Pricing Select	Coin Mechanisms				Pricing Scheme Explained			
	Left 1st	Center 2nd	Right 3rd	Right 4th	Number of "Plays" for Price Amount Shown			
USA 1	25c	\$1	25c		1/25c			
USA 2	25c	\$1	25c		1/50c	2/75c	3/\$1	
USA 3	25c	\$1	25c		1/50c			
USA 4	25c		25c		1/50c			
USA 5	25c	\$1	25c		1/50c	5/\$2		
USA 6	25c	\$1	25c		1/50c	2*4X25c*	3/\$1 (bill)	Used to promote Bill Validator
USA 7 *	25c	\$1	25c		1/50c	4/\$1.50	6/\$2	
Austria	5S	10S	10S		1/10S	2/15S	3/20S	
Australia	20c	\$A 1	\$A 2		1/\$A 1	3/\$A 2		
Australia 2	20c	\$1	\$2		1/\$1	2/\$2		
Belgium	5 BF	20 BF	50 BF		1/20 BF	3/50 BF		
Canada	25c	25c	Can\$ 1		1/50c	2/75c	3/Can\$ 1	
Denmark 1	1DKr	5 DKr	10 DKr	20 DKr	1/3 DKr	2/5 DKr		
Denmark 2	1DKr	5 DKr	10 DKr	20 DKr	1/2 DKr	3/5 DKr	7/10 DKr	
Finland	1Fmk	5Fmk			1/3Fmk	2/5Fmk		
France 1 *	1 Fr	5 Fr	10 Fr	20 Fr	1/3 Fr	2/5 Fr	5/10 Fr	11/20 Fr
France 2	1 Fr	5 Fr	10 Fr	20 Fr	1/5 Fr	3/10 Fr	7/20 Fr	
France 3	1 Fr	5 Fr	10 Fr	20 Fr	1/3 Fr	2/5 Fr	4/10 Fr	9/20 Fr
Germany 1	1DM	2DM	5DM		1/1 DM	5/5DM		
Germany 2	1DM	2DM	5DM		1/1DM	6/5DM		
Germany 3 * †	1DM	2DM	5DM		1/2DM	2/3DM	3/4DM6	6/6DM
Greece	50Dr		100Dr		1/50Dr	3/100Dr		
Holland (See Netherlands 2)								
Hungary	10 Ft	10 Ft	20 Ft		1/20 Ft	3/40 Ft		
Italy 1	500 Lit		500 Lit		1/500 Lit			
Italy 2	500 Lit		500 Lit		1/1000 Lit	3/2000 Lit		
Japan			100¥		1/100¥	3/200¥		
Korea	100Won		100Won		1/100Won			
Netherlands 1	1 Fls.	1 Fls.	2.5 Fls.		1/1Fls.	3/2.5 Fls.		
Netherlands 2 *	1 Fls.	2.5 Fls.	5 Fls.		1/1Fls.	3/2.5 Fls.	6/5 Fls.	
New Zealand 1	SNZ 1		SNZ 2		1/SNZ 1	2/SNZ 2		
New Zealand 2	SNZ 1		SNZ 2		1/SNZ 1	3/SNZ 2		
Norway 1 †	5 NKr	10 NKr	20 NKr		1/5 NKr	2/10 NKr	4/20 NKr	
Norway 2 †	5 NKr	10 NKr	20 NKr		1/10 NKr	3/20 NKr		
Spain	100Pts		500Pts		1/100Pts	6/500Pts		
Sweden	1 SKr	5 SKr	10 SKr		1/10 SKr	2/15 SKr	3/20 SKr	
Switzerland 1 *	1 SwF	2 SwF	5 SwF		1/1 SwF	6/5 SwF		
Switzerland 2	1 SwF	2 SwF	5 SwF		1/1 SwF	3/2 SwF	9/5 SwF	
UK 1	10p	50p	1£	20p	1/50p	3/1£		
UK 2	10p	50p	1£	20p	1/40p	3/1£		
UK 3 *	10p	50p	1£	20p	1/50p			
Yugoslavia	5 Din		5 Din		1/5 Din			

\* Default Factory Setting. † New Settings.

## Additional Generic Features (Adj. 9 - 30)

Adj.#	Adjustment Name	Adjustment Definition
Adj. 9	<b>Reset Coin Audits</b>	When enabled (set to <b>YES</b> ) all coin / paid credit totals will be reset to zero when <b>STEP</b> is depressed.
Adj. 10	<b>Reset Game Audit</b>	When enabled (set to <b>YES</b> ) all audit totals except for Au. 1, Total Paid Credits, Au. 5-8, Coins thru ... Slot, Au. 9, Total Coins, Au. 10, Total Earnings, & Au. 11, Meter Clicks, will be reset to zero when <b>STEP</b> is depressed.
Adj. 11	<b>Restore High Scores</b>	When enabled (set to <b>YES</b> ) the High Score Levels and associated initials will be restored to backup settings when <b>STEP</b> is depressed.
Adj. 12	<b>Expand Adjustments?</b>	When set to <b>NO</b> , depressing the <b>STEP</b> push-button advances directly to Adj. 99, <b>FACTORY RESTORE</b> . When set to <b>YES</b> , depressing the <b>STEP</b> push-button sequences through the expanded adjustments. When exiting from expanded adjustments, this function is reset to <b>OFF</b> for the next time that adjustments are required.
Adj. 13	<b>Match Percentage</b>	Set Match percent from <b>00%</b> to <b>10%</b> or <b>OFF</b> . At <b>00%</b> the match display occurs at the end of the game but never awards a credit.
Adj. 14	<b>Balls Per Game</b>	Adjust the number of balls per game; <b>2</b> to <b>5</b> .
Adj. 15	<b>Tilt Warnings</b>	Adjust the number of plumb bob tilt switch closures before the ball in play is tilted; <b>1</b> , <b>2</b> , <b>3</b> or <b>OFF</b> .
Adj. 16	<b>Replay Boost</b>	Set to <b>YES</b> or <b>NO</b> . When set to <b>YES</b> , exceeding a replay will set a temporary replay level for each time a replay level is surpassed. This new level will equal the previous replay level (when the replay was awarded) plus 50 Million for each following game, until the replays have all been played. At this time the previous level is resumed.
Adj. 17	<b>Credit Limit</b>	Adjust the maximum number of credits that may be posted; <b>4</b> to <b>50</b> .
<p>Note: There are four of the six high score levels with associated player initials that are displayed during the attract mode. This provides a high-score-to-date feature. When players exceed these levels, the player initials may be entered to replace the previous ones. These levels may be adjusted to award credits and to be reset to backup values after a selected number of games.</p>		
Adj. 18	<b>Allow High Scores</b>	Set to enable or disable the four high score levels; <b>00</b> .
Adj. 19	<b>Award for High Score #1</b>	Adjust the number of awards ( <b>0</b> to <b>4</b> ) awarded for exceeding level 1 (the highest of the four levels).
Adj. 20	<b>Award for High Score #2</b>	Adjust the number of awards ( <b>0</b> to <b>3</b> ) awarded for exceeding level 2.
Adj. 21	<b>Award for High Score #3</b>	Adjust the number of awards ( <b>0</b> to <b>2</b> ) awarded for exceeding level 3.
Adj. 22	<b>Award for High Score #4</b>	Adjust the number of awards ( <b>0</b> to <b>1</b> ) awarded for exceeding level 4.
Adj. 23 - 28	<b>Default High Score #1 - #6</b>	Adjust the score level to which the world record, (level 1) (the highest of the four levels) may be altered. This adjustment is not affected by Adj. 29, <i>Reset High Score To Date</i> . Adjust the backup score to which levels 2 - 6 may be reset, respectively.
Adj. 29	<b>HSTD Reset Count</b>	<b>HSTD (High Score To Date)</b> . Adjust the number of games between automatic resets of high score levels to backup settings and ball time averager adjustments; <b>100</b> to <b>900</b> or <b>OFF</b> (no reset or adjustment).
Adj. 30	<b>Free Play</b>	When set to <b>YES</b> , no coins are required for games.



## Additional Generic Features (Adj. 31 - 42)

Adj.#	Adjustment Name	Adjustment Definition
Adj. 31	<b>Custom Message</b>	When desired, this function is used to establish a custom message periodically displayed during the attract mode. Set the feature to <b>CHANGE</b> using the Credit button and depress <b>STEP</b> . The letter A is indicated in the first position in the display. Vary the letter by operating the left and right flippers. With the desired letter indicated, depress the <b>CREDIT</b> button to lock in the letter and advance to the next character. Repeat this procedure until the desired message is completed in the display. Press the <b>STEP</b> push-button switch to advance to Attract Mode Music (Adj. 32).
Adj. 32	<b>Attract Mode Music</b>	Set to <b>ON</b> or <b>OFF</b> . When set to <b>ON</b> , Attraction Music is played between games.
Adj. 33	<b>Flash Lamp Power</b>	Set to <b>NORMAL</b> , <b>DIM</b> or <b>OFF</b> . When set to <b>NORMAL</b> the Flash Lamps are active, when <b>DIM</b> the Flash Lamps impulse power is reduced by 25% and when <b>OFF</b> the Flash Lamps do not flash.
Adj. 34	<b>Coil Pulse Power</b>	Set to <b>NORMAL</b> , <b>HARD</b> or <b>SOFT</b> . When <b>HARD</b> the coil pulse power is increased by 12.5% of the normal pulse rate. When set to <b>SOFT</b> the coil pulse power is reduced by 12.5% of the normal pulse rate. These adjustments are provided to compensate for Low Line or High Line voltage conditions where the solenoids appear to kicking too weak or too hard.
Adj. 35	<b>Guaranteed Game Time</b>	Default is 0:00. Set between 0:00 - 8:59 for minimum game time. If the last ball in play drains prior to what the game time is set for, another ball will be served into the shooter lane and normal play will continue. Subsequent balls will continue to do be served into the shooter lane if the last ball still drains prior to and up until minimum game time is satisfied.
Adj. 36	<b>Next Game Promotion</b>	Set to <b>ON</b> or <b>OFF</b> . When set to <b>ON</b> , the game, in attract mode will randomly display a short promotion for our next game. When set to <b>OFF</b> , the game in attract mode will not generate any sounds or graphics referring to the next game.
Adj. 37	<b>Buyin Type</b>	Set to <b>Extra-Ball Buyin</b> . When set to <b>EB Buyin</b> , the game is set to Extra Ball Buyin. When set to <b>Feature Buyin</b> , the game is set to Game Buyin. Set to <b>OFF</b> to make Buyin Type inoperative.
Adj. 38	<b>Extra Ball Buyin Count</b>	1, 0 or <b>UNLIMITED</b> . Default is 1. Allows the operator to adjust the number of Extra Ball (EB) Buyins allowed after normal game play. See page 5 Extra Ball (EB) Buyin Feature.
Adj. 39	<b>Game Restart</b>	Set to <b>YES</b> or <b>NO</b> . When set to <b>YES</b> , a new game may be started during any ball after the first ball is completed. (Note-Pressing start during the first ball will add additional players.) When set to <b>NO</b> , the game disables the start button after the first ball until the final ball is in play.
Adj. 40	<b>Extra Ball Percentage</b>	Set from 0 to 50. Allows the operator to adjust how frequently the Extra Ball feature is made available to the player.
Adj. 41	<b>Background Music Volume</b>	Set to 0, 25, 50, 75 or 100 percent. Allows the operator to adjust the background music volume independently from the normal game sounds.
Adj. 42	<b>Bill Validator</b>	Set to <b>YES</b> or <b>NO</b> . When set to <b>YES</b> , the display, in game attract mode, will show an 'Insert Bill Animation'. When set to <b>NO</b> , the display, in game attract mode will show 'Insert Coin Animation'.



# Add'l Generic (Adj. 43-47/50/ 57-99) & Game Specific Features (Adj. 48-52/58)

Adj.#	Adjustment Name	Adjustment Definition
Adj. 43	Tournament Mode	Set to <b>NONE</b> , <b>PINBALL EXPO</b> , <b>IFPA-PAPA</b> or <b>HOME</b> . See page 20
Adj. 44	External Replay Kicker	Set to <b>ON</b> or <b>OFF</b> . When set to <b>ON</b> , the operator can enable the kicker in the cabinet to drive an external device without the game giving a replay.
Adj. 45	Special Memory	Set to <b>YES</b> or <b>NO</b> . When set to <b>YES</b> , the lit 'Special' light will be retained in memory from ball to ball for the same player. When set to <b>NO</b> , the lit 'Special' light will go out at the end of each ball.
Adj. 46	Laser Kick Present	Set to <b>YES</b> . When set to <b>YES</b> , the game equipped with a Laser Kick Coil will work as usual. Set to <b>NO</b> , the game (if not equipped) or if desired, "Virtual Kick-Back" can be set, whereas if the ball drains through the left outlane and if <b>'ALIVE'</b> is lit, the ball will be returned to the Shooter Lane and automatically kicked into play.
Adj. 47	Laser Kick Criterion	Set to <b>MODERATE</b> , <b>HARD</b> or <b>EXHARD</b> . Default is <b>MODERATE</b> . When set to <b>MODERATE</b> , the Laser Kick is <b>ON</b> at the beginning of each new ball. Set to <b>HARD</b> , the Laser Kick (whether in active mode or not) carries over from the last ball in play. Set to <b>EXHARD</b> , the Laser Kick is <b>OFF</b> at the beginning of each ball.
Adj. 48	Gore Allowed	Set to <b>YES</b> . Set to <b>YES</b> = <b>Rated R</b> . Set to <b>NO</b> = <b>Rated G</b> .
Adj. 49	Easy Multiball Start	Set to <b>YES</b> . When set to <b>YES</b> this will lite both Scoops & Ramp for Multiball for 1st Multiball only. Set to <b>NO</b> , shoot Ramp to lite Multiball and shoot VUK to start.
Adj. 50	Multiball Restart	Set to <b>EXEASY</b> , <b>EASY</b> , <b>MODERATE</b> , <b>HARD</b> or <b>EXHARD</b> . Default is <b>EASY</b> . Determines how Multiball can restart.
Adj. 51	Enable Creature Throw	Set to <b>YES</b> or <b>NO</b> . When set to <b>NO</b> , the Creature's Arms & the Trap Doors are disabled. Use this adjustment if awaiting repair/parts.
Adj. 52	Creature Throw Pulse	Set to <b>SOFT</b> , <b>NORMAL</b> , or <b>HARD</b> . Default is <b>NORMAL</b> . Adjustment is needed <i>only</i> if Creature is throwing balls to hard or to weak.
Adj. 53	Multiball Difficulty	Determines how Multiball Difficulty is achieved.
Adj. 54	Extra Ball Memory	Set to <b>YES</b> or <b>NO</b> . When set to <b>YES</b> , the lit 'Extra Ball' light will be retained in memory from ball to ball for the same player. When set to <b>NO</b> , the lit 'Extra Ball' light will go out at the end of each ball.
Adj. 55	Ramp Memory	Set to <b>YES</b> or <b>NO</b> . When set to <b>YES</b> , the 'Completed Number of Ramps' will be retained in memory from ball to ball for the same player to achieve set awards. When set to <b>NO</b> , the 'Completed Number of Ramps' will be reset at the end of each ball.
Adj. 56	Easy 2-Ball Start	Set to <b>YES</b> or <b>NO</b> . When set to <b>NO</b> , VUK must be shot to start. Set to <b>YES</b> , a right orbit shot will start 2-Ball M-Ball on 1st M-Ball only.
Adj. 57	Software Meter	Provides the operator with the total number of Meter Clicks.
Adj. 58	Location ID	0 to 9999. Allows the operator to assign a location or game identification (respectively) number to the audit print-out sheet. (Will not be affected by Factory Restore.)
Adj. 59	& Game ID	
Adj. 60	Reset Printer?	Provides the operator with the ability to reset the printer option.
Adj. 61	Printer Interface	Allows the operator to print by pressing the Start Button.
Adj. 62	A.L.I.S.O.N. Interface	Allows the operator to down load to a lap top and process the information. Special equipment is needed. This will replace Adj. 59.
Adj. 99	Factory Restore	Allows the operator to reset all adjustments to the factory settings.

Please note the Coin De CMOS RAM

The Data E feature may inside the c tests may t

During gam is not made not, the co Tech Alert bad coil cc

Wiring to color-code test, identi making th (WHT-YE

Color Ab

0	BU
1	BR
2	RE

Additional

X
LT
RT
BOT
MID
CT

Enter

With th push-b will sho and the

Serv

With tr option any cc pushb these initial

Tec

The c open

# GAME DIAGNOSTICS

Please note: If the Display Reads "OPEN THE DOOR," this indicates a faulty memory condition in RAM. Opening the Coin Door will initiate a Factory Restore, by opening the Memory Protect Switch. Check battery voltage at CMOS RAM with power off.

The Data East Pinball system provides tests for sounds, digital displays, lamps, switches, and solenoids. Each feature may be tested manually or automatically using the **STEP** and **FORWARD/REVERSE** push-button switches inside the coin door and the white "Clear Ticket" button located next to the Diagnostic Switches. The automatic tests may be used for a quick verification of automatic test functions and the manual tests, for troubleshooting.

During game play, activation of switches and operation of coils with associated switches are monitored. If a switch is not made for 50 games it is considered faulty. When operation of a coil should close or open a switch and does not, the coil is considered faulty. In Game Over Attract Mode, faulty switches and coils (if any) are reported (See Tech Alert description below). Note that reporting of an unused switch does not constitute a problem and that a bad coil could mean that the associated switch requires adjustment.

Wiring to switches, solenoids and controlled lamps uses color-coded wires that basically follows a resistor color-code scheme for the eight rows and eight columns. During the switch tests and during the discrete lamp test, identification of the color of the row and column wires are indicated in the Dot Matrix Display. For example, making the right coin switch during the Switch Test results in the switch functional name (RIGHT COIN), the row (WHT-YEL) and column (GRN-BRN) wire color codes, and the switch number are shown in the display.

## Color Abbreviations Used:

0	BLK = BLACK	3	ORN = ORANGE	6	BLU = BLUE	9	WHT = WHITE
1	BRN = BROWN	4	YEL = YELLOW	7	VIO = VIOLET		
2	RED = RED	5	GRN = GREEN	8	GRY = GREY		

## Additional Abbreviations/Acronyms Used:

X	"Times" (Multiplier)	P/F	Playfield	D.T.	Drop Target(s)
LT	Left	S-U	StandUp (Targets)	PPB	Playfield Power Board
RT	Right	Au.	Audit(s)	SSFB	Solid State Flipper Board
BOT	Bottom	Adj.	Adjustments	PSB	Power Supply Board
MID	Middle	G.I.	General Illumination	SMB	Shaker Motor Board
CT	Center	R/O	Rollover (Switches)	N.C.	"Normally Closed"

## Entering Diagnostics

With the game in the game-over mode, open the coin door and make sure that the **FORWARD/REVERSE** push-button switch is set to **REVERSE** (down) and depress the **STEP** push-button switch. The Player displays will show the toll-free Customer Service number 1-800-KICKERS, that is 1-800-542-5377 (U.S. including Illinois) and the toll number (708) 345-7700 (Outside the United States). This indicates entry into game diagnostics.

## Service Credits

With the phone number displayed depress the **STEP** push-button switch. The game now gives the technician the option of adding 1 to 5 service credits. These credits allow the technician to test-play the game without adding any counts to the coin audits (Au. 01 & Au. 05 - 08). When the message appears, press and hold the Game Start pushbutton until the desired number of credits are shown on the display. Then press the step button again to add these credits to the game and enter Tech Alert. If no Service Credits are desired, press the step button with the initial message displayed.

## Tech Alert

The display will now indicate if there are any faulty switches (i.e., switches that are normally closed but remain open or open switches that have not been closed (activated) in 50 games.

## Easy Trough Clear

Pressing the step button again displays the **EASY TROUGH CLEAR** message and instructs the technician to operate either flipper button to easily remove the balls from the trough. This is provided to allow the technician a simple method of removing the balls from the trough prior to entering the Active Switch Test, thereby reducing the number of switches closed. Also, to test functionality of trough, ensure proper trough operation.

## Burn-In Minutes

Pressing the step button while in Tech Alert mode will step game into Burn-in Mode (factory use). At this stage, pressing the game start button will cause the game to exercise all CPU I/O Functions. This is provided to constantly exercise sounds, solenoids, etc...

To stop the test press the start button again. Cumulative Burn-In minutes will be displayed. To reset Burn-in minutes to 00, you must perform an Audit Reset (Adj. 10) or a Factory Restore (Adj. 99).

## Sound Tests

The Data East Pinball sound system produces true digital stereo sound on left and right speakers and mono on a center speaker. During Sound tests, the display shows the sound board circuit under test and the corresponding sounds are selected by operating the left and right flipper buttons to choose the circuit to be tested. Now press the start button to initiate the sound. Refer to the Sound Test Chart for the sound circuits displayed and the sound produced.

The sound functions allow verification that all channels are functioning properly and that the speaker connections are correct. Speaker Phase Testing Procedures follow for checking speaker connections.

Sound Test Chart

Auto/Manual Tests	Sounds Produced	Auto/Manual Tests	Sounds Produced
Left Speaker	LEFT SINE	Voice Rom2 (Loc U21)	SPEECH PATTERN 2
Both L1 & R1 Speakers	CENTER SINE	Voice Rom3 (Loc U36)	SPEECH PATTERN 3
Right Speaker	RIGHT SINE	Music Test (Sound Rom, Loc U7)	LEVEL 1-3 MUSIC
Voice Rom1 (Loc U17)	SPEECH PATTERN 1		

## Speaker Phase Testing

Connections to each of the three speakers are polarized and each must be connected appropriately for the best quality sound. If one speaker has the positive and negative connections reversed with respect to the other two, bass frequencies will not be produced properly and the overall sound quality will be poor.

To test for proper speaker phasing, use the sound test to cycle through the Left, Center, and Right Sine functions. If the Center Sine produces more volume and bass than the Left and Right Sines, the speakers are connected properly. If it produces the same or less, one speaker is connected improperly. To isolate and correct reversed speaker connections, one of two methods may be used.

1. Check each speaker for polarity markings. If the speakers have polarity markings, verify that the single-color wire (BLK, YEL or RED) is connected to the negative (-) terminal.
2. Disconnect the speaker output connector from the Sound Board and connect a 1.5-volt battery across each speaker pair one at a time while observing the speakers. Make sure the positive battery terminal is connected to the positive lead (CN1- Pin 1, 3 or 6) each time. As the connection is made, check speaker cone movement; proper connections are indicated by outward movement.

Dot Mat

The display Board. The displaying t

The board Data, Rese Busy Sign Controller

The Driver Display Dr

Dot Ma

To enter D will immer column h illuminate the next r the dots i display w row, until pass. Th the unit c is also di the next t the STEI

Creat

To enter The CPU Controll

Lase

This tes enterin; kicks to the swir be per



## Dot Matrix Display

The display utilizes a Micro-Processor Control Board mounted in piggyback fashion to the Dot Matrix Display Driver Board. The purpose behind this board is to provide more information (192 X 64 Dots) to the operator as well as displaying graphics to the player.

The board is controlled by a 68000 Microprocessor and its personality ROMs (Unique to the Game). It receives Data, Reset & Clock Information from the CPU Board via the ribbon cable and sends back multiple Status and Busy Signals to the CPU. This is to insure synchronized communication between the CPU and the Display Controller Board.

The Drivers for the rows and columns are provided on 5 surface mounted integrated circuits on the Dot Matrix Display Driver Board.

## Dot Matrix Display Test

To enter Dot Matrix Display Test, operate the STEP push-button switch after the Speaker Phase Test. The display will immediately illuminate one vertical column of dots, turning it off and illuminating the next column, until each column has been individually lit, while the other columns are off. It will make one pass. The display will then illuminate the top horizontal row of dots, and test by lighting the row of the display, then turning it off and illuminating the next row, until each row has been individually lit, while the other rows are off. The test will then illuminate all the dots in the display, except for one column. It will cycle this blank column from left to right for one pass. The display will then again illuminate all the dots except for the top row, and then turning it on and blanking the next row, until each row has been individually blanked, while the other rows are on. It will cycle this blank row for one pass. The next test begins with every other dot lit, in both the rows and columns. These dots then go out, and the unlit dots light, resulting in an alternating checkerboard pattern for approximately 4 seconds. An intensity test is also displayed at 30%, 70% & 100% brightness. The test will repeat these cycles indefinitely until advanced to the next test or until the power is removed. (Please Note: These tests may be interrupted at any time by operating the STEP push-button switch to advance to the next test.)

## Creature Head Motion Test

To enter this test, operate the STEP push-button switch after above test. To initiate test, press the Start Button. The CPU sends instructions to the Servo Controller Board which triggers pre-recorded routines stored in the Micro-Controller on the Servo Board. The Head Motion should be the same as it is in game play.

## Laser Kick Test

This test is provided to insure proper interaction between certain switches and their associated solenoids without entering game play. For example, by rolling the ball over the left outlane switch, the Laser Kick should fire. If it kicks too early or too late, the switch actuator should be adjusted to compensate for this error. If it fails to fire, use the switch test or coil test to help determine the cause of the failure. (Note: During this function, similar tests may be performed on the Vertical Up Kickers or Ejects in the game.)

## SWITCH TESTS

Switches are configured in an 8 x 8 matrix of columns (switch drives) and rows (switch returns) with up to 64 switches possible. The switch tests include three parts; switch test, active switches, and bad switches. Column and Row wire colors are indicated in each test using corresponding resistor color code numbers.

### Switch Test

To initiate, push the STEP push-button switch, until the display indicates **SWITCH TEST**. Close each switch, observe the display. The display will indicate the switch name, column wire colors, row wire colors and the switch number. When a switch is released, the name and number disappear until another switch is closed or the test is exited.

### Active Switches

Push the STEP push-button switch from the Switch Test. The display will indicate **ACTIVE SWITCHES**. If any switches are stuck closed (or made from the presence of a ball), the display sequences through switch names and indicates the row and column wire colors, and the switch numbers are indicated in the display. This cycle continues until all switches are cleared or until the STEP push-button switch is depressed.

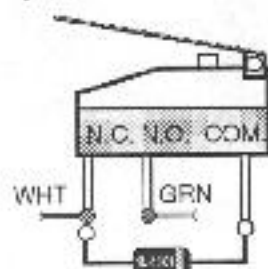
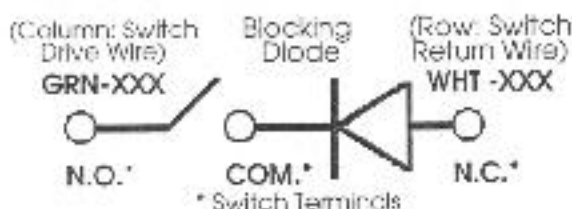

### SWITCH MATRIX CHART

Column (Drive)	1 Q55	2 Q54	3 Q53	4 Q52	5 Q51	6 Q50	7 Q49	8 Q48
Row (Return)	GRN-BRN CN8-1	GRN-RED CN8-2	GRN-ORN CN8-3	GRN-YEL CN8-4	GRN-BLK CN8-5	GRN-BLU CN8-7	GRN-VIO CN8-8	GRN-GRY CN8-9
1 WHT-BRN CN10-9	Plumb lit 1	#1 (Left) Ball Trough 9	Bottom 2-Bank S-U Left "P" 17	Mid. 1-Bank S-U "Move Jackpot" 25	Left Orbit Rollover Bottom 33	Top Turbo Bumper 41	Not Used 49	Not Used 57
2 WHT-RED CN10-8	4th Coin 2	#2 Ball Trough 10	Bottom 2-Bank S-U Right "R" 18	Ramp 1-Bank S-U Left "T" 26	Left Orbit Rollover Top 34	Mid. Left Turbo Bumper 42	Not Used 50	Not Used 58
3 WHT-ORN CN10-7	Credit Button 3	#3 Ball Trough 11	Middle 3-Bank S-U Bot. "A" 19	Ramp 1-Bank S-U Right "E" 27	Right Orbit Rollover Top 35	Mid. Right Turbo Bumper 43	Not Used 51	Not Used 59
4 WHT-YEL CN10-6	Right Coin 4	#4 Ball Trough 12	Middle 3-Bank S-U Mid. "N" 20	Right 2-Bank S-U Top "I" 28	Right Orbit Rollover Bottom 36	Bottom Turbo Bumper 44	Not Used 52	Not Used 60
5 WHT-GRN CN10-5	Center Coin 5	#5 Ball Trough 13	Middle 3-Bank S-U Top "K" 21	Right 2-Bank S-U Bot. "N" 29	Left Outlane Rollover 37	Ramp Entrance Gate 45	"North Pole" VUK 53	Not Used 61
6 WHT-BLU CN10-3	Left Coin 6	#6 Ball Trough 14	Top 3-Bank S-U Left "E" 22	Not Used 30	Left Return Lane Rollover 38	Ramp Exit Gate 46	"Ingolstadt" Rt. Orbit Spinner 54	"The Switch" Lever 62
7 WHT-VIO CN10-2	Slam lit 7	#7 (Right) Ball Trough 15	Top 3-Bank S-U Mid. "N" 23	Sarcophagus Upper Scoop 31	Rt. Return Lane Rollover 39	Left Slingshot 47	"Ice Cave" above Ball Eject 55	Left Flipper Lower 63
8 WHT-GRY CN10-1	Extra Ball Button 8	Shooter Lane 16	Top 3-Bank S-U Right "S" 24	Geneva Lower Scoop 32	Right Outlane Rollover 40	Right Slingshot 48	Mini-Orbit Rollover By Eject 56	Right Flipper Upr./Lwt. 64

Switch M

1*	Plumb I
2*	4th Coin
3*	Credit B
4*	Right C
5*	Center C
6*	Left C
7*	Slam T
8*	Extra B
9	#1 Left
10	#2 Ball
11	#3 Ball
12	#4 Ball



\* Lo  
+ Sp

## Switch Matrix Locations, Descriptions & Switch Part Numbers†

Switch Matrix No. & Description	Part No.
1* Plumb Tilt (See Item 17, Cabinet Parts, Page 41)	---
2* 4th Coin (On Coin Door)	---
3* Credit Button (Left of Coin Door)	500-5097-02
4* Right Coin (On Coin Door)	180-5024-00
5* Center Coin (On Coin Door)	180-5024-00
6* Left Coin (On Coin Door)	180-5024-00
7* Slam Tilt	180-5022-00
8* Extra Ball Button (Under BS)	180-5073-00
9 #1 (Left) Ball Trough	180-5119-00
10 #2 Ball Trough	180-5119-00
11 #3 Ball Trough	180-5119-00
12 #4 Ball Trough	180-5119-00

Switch Matrix No. & Description	Part No.
13 #5 Ball Trough	180-5119-00
14 #6 Ball Trough	180-5119-00
15 #7 (Right) Ball Trough	180-5118-00
16 Shooter Lane	180-5100-01
17 Bottom 2-Bank Stand-Up Left "F"	515-5027-08
18 Bottom 2-Bank Stand-Up Right "H"	515-5027-08
19 Middle 3-Bank Stand-Up Bottom "A"	515-5162-08
20 Middle 3-Bank Stand-Up Middle "N"	515-5162-08
21 Middle 3-Bank Stand-Up Top "K"	515-5162-08
22 Top 3-Bank Stand-Up Left "E"	515-5162-08
23 Top 3-Bank Stand-Up Middle "N"	515-5162-08
24 Top 3-Bank Stand-Up Top "S"	515-5162-08
25 Middle 1-Bank S-U "Move Jackpot"	515-5027-08
26 Ramp 1-bank Stand-Up Left "T"	515-5967-08
27 Ramp 1-bank Stand-Up Right "E"	515-5967-08
28 Right 2-Bank Stand-Up Top "I"	515-5027-08
29 Right 2-Bank Stand-Up Bottom "N"	515-5027-08
30 Not Used	---
31 Sarcophagus Upper Scoop	180-5057-00
32 Geneva Lower Scoop	180-5057-00
33 Left Orbit Rollover Bottom	500-5706-00
34 Left Orbit Rollover Top	500-5706-00
35 Right Orbit Rollover Top	500-5707-00
36 Right Orbit Rollover Bottom	500-5707-00
37 Left Outlane Rollover	500-5707-00
38 Left Return Rollover	500-5707-00
39 Right Return Rollover	500-5707-00
40 Right Outlane Rollover	500-5706-00
41 Top Turbo Bumper	180-5015-01
42 Middle Left Turbo Bumper	180-5015-01
43 Middle Right Turbo Bumper	180-5015-01
44 Bottom Turbo Bumper	180-5015-01
45 Ramp Entrance Gate	180-5090-00
46 Ramp Exit Gate	180-5087-00
47 Left Slingshot	180-5054-00
48 Right Slingshot	180-5054-00
49 Not Used	---
50 Not Used	---
51 Not Used	---
52 Not Used	---
53 "North Pole" VUK	180-5116-00
54 "Ingotated" Right Orbit Spinner	180-5010-04
55 "Ice Cave" above Ball Eject	180-5027-01
56 Mini-Orbit Rollover by Eject	500-5706-00
57 Not Used	---
58 Not Used	---
59 Not Used	---
60 Not Used	---
61 Not Used	---
62 "The Switch" Lever	180-5111-00
63* Lower Left Flipper Cabinet via Q7 (Transistor) on SSFB	180-5124-01
64* Lower & Upper Right Flipper Cabinet via Q5 (Transistor) on SSFB	180-5124-01

with up to  
tches. Colu

each switch a  
and the swit  
d or the test

CHES. If a  
switch name  
y. This cyc

8 Q4  
GRN-GRY  
CN8-9

Not Used

Not Used

Not Used

Not Used

Not Used

Not Used

\*The  
Switch\*  
Lever

Left  
Flipper  
Lower

Right  
Flipper  
Lwr.

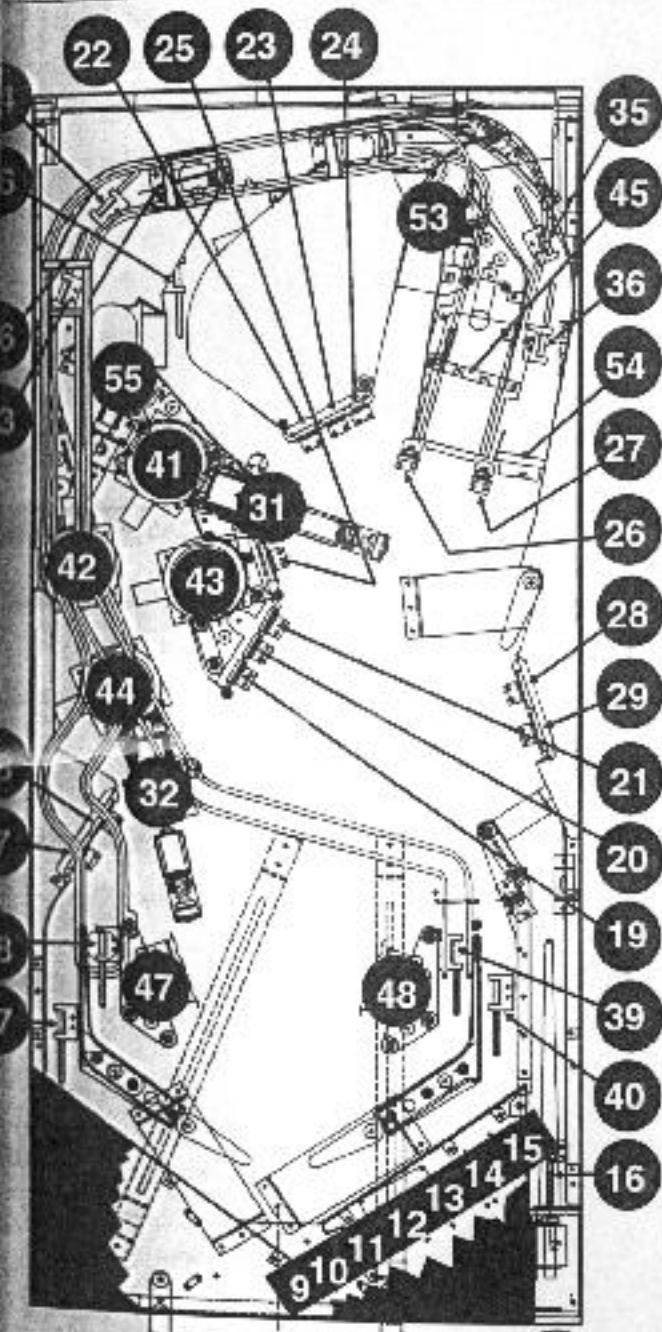

\* Location - In Cabinet  
† Specify Game No (36) & decal description if applicable.



## LAMP TESTS

Controlled lamps are configured in an 8 x 8 matrix of columns (lamp drives) and rows (lamp returns) with up to 64 lamps possible. The lamp tests include four parts, all lamps, lamp return (row), lamp drive (column), and discrete (individual) lamps. Row and column wire colors are indicated in the discrete lamp test using corresponding resistor color code numbers.

### All Lamps

From the Active Switch test, operate the STEP push-button switch. The dot matrix display will indicate ALL LAMP and all controlled lamps will light.

### Lamp Returns (Row)

From the ALL LAMPS test, depress the STEP push-button switch. The display indicates LAMP RETURNS, wire color and the LAMP RETURN driver transistor. All controlled lamps in row 1 should be lit. Operating the Game Start push-button switch cycles through each of the rows separately.

### Lamp Drives (Column)

From the LAMP RETURNS test, depress the STEP push-button switch. The display will indicate LAMP COLUMN, wire color and the LAMP DRIVES driver transistor. All controlled lamps in column 1 should be lit. Operating the Game Start push-button switch cycles through each of the columns separately.

Lamp Test Continued of page 34

## LAMP MATRIX CHART

Column 18V Row GND	1 Q71 YEL-BRN CN7-1	2 Q70 YEL-RED CN7-2	3 Q69 YEL-ORN CN7-3	4 Q68 YEL-BLK CN7-4	5 Q67 YEL-GRN CN7-6	6 Q66 YEL-BLU CN7-7	7 Q65 YEL-VIO CN7-8	8 Q64 YEL-GRY CN7-9
1 Q72 RED-BRN CN6-1	F 01	T 09	Franken- stein Mil- lions Mode 17	Ramp Jackpot 25	Left Out- lane Alive Kick Back 33	Move Jackpot 41	Not Used 49	Not Used 57
2 Q73 RED-BLK CN6-2	R 02	E 10	Storing Mode 18	North Pole VUK Jackpot 26	Left Outlane Special 34	Change Scene 42	Not Used 50	Not Used 58
3 Q74 RED-ORN CN6-3	A 03	I 11	Creature Feature Mode 19	Ice Cave Ball Floor Jackpot 27	Left Return Lane Life Ingolstadt 35	Ingolstadt Spinner Mode 43	Not Used 51	Not Used 59
4 Q75 RED-YEL CN6-5	N 04	N 12	Lynch Justine Mode 20	Left Orbit Jackpot 28	Rt. Return Lane Life Geneva 36	Jackpot Grows 44	Not Used 52	Not Used 60
5 Q76 RED-GRN CN6-6	K 05	Top Turbo Bumper 13	North Pole Mode 21	Geneva Lower Scoop 29	Rt. Outlane Double Bonus 37	Justine Mode 45	Not Used 53	Not Used 61
6 Q77 RED-BLU CN6-7	E 06	Mid. Left Turbo Bumper 14	Life Extra Ball Mode 22	Sarcopha- gus Upper Scoop 30	Ice Cave Mode 38	Extra Ball 46	Not Used 54	Not Used 62
7 Q78 RED-VIO CN6-8	N 07	Mid. Right Turbo Bumper 15	Voltage Mode 23	VUK Entrance Left 31	Life Lock 1 39	Creature Mode 47	Live Again 55	Extra-Ball Button 63
8 Q79 RED-GRY CN6-9	S 08	Bottom Turbo Bumper 16	Graveyard Mode 24	VUK Entrance Right 32	Life Lock 2 40	Shooter Lane 48	VUK Entrance Middle 56	Start Button 64

Lamp No.	Color
01	F
02	R
03	A
04	N
05	K
06	E
07	N
08	S
09	T
10	E
11	I
12	N
13	T
14	M
15	M
16	B
17	E
18	S
19	C
20	L
21	N

Please  
General  
Lamps  
For Bulb Ty  
see pa

- 3
- 33
- 45
- 19
- 18
- 17

## Lamp Matrix Location and Descriptions

Lamp Matrix No. & Description	Lamp Matrix No. & Description	Lamp Matrix No. & Description
01 F of: FRANKENSTEIN	22 Lite Extra Ball Mode	43 Ingolstadt Spinner Mode
02 B of: FRANKENSTEIN	23 Voltage Mode	44 Jackpot Grows
03 A of: FRANKENSTEIN	24 Graveyard Mode	45 Justine Mode
04 N of: FRANKENSTEIN	25 Ramp Jackpot	46 Extra Ball
05 K of: FRANKENSTEIN	26 North Pole VUK Jackpot	47 Creature Mode
06 E of: FRANKENSTEIN	27 Ice Cave Ball Elect Jackpot	48 Shooter Lane
07 N of: FRANKENSTEIN	28 Left Orbit Jackpot	49 Not Used In This Game
08 S of: FRANKENSTEIN	29 Geneva Lower Scoop	50 Not Used In This Game
09 T of: FRANKENSTEIN	30 Sarcophagus Upper Scoop	51 Not Used In This Game
10 E of: FRANKENSTEIN	31 VUK Entrance Left	52 Not Used In This Game
11 I of: FRANKENSTEIN	32 VUK Entrance Right	53 Not Used In This Game
12 N of: FRANKENSTEIN	33 Left Outlane Alive Kick-Back	54 Not Used In This Game
13 Top Turbo Bumper	34 Left Outlane Special	55 Live Again (Shoot Again)
14 Middle Left Turbo Bumper	35 Lt. Return Lane Lite Ingolstadt	56 VUK Entrance Middle
15 Middle Right Turbo Bumper	36 Rt. Return Lane Lite Geneva	57 Not Used In This Game
16 Bottom Turbo Bumper	37 Right Outlane Double Bonus	58 Not Used In This Game
17 Frankenstein Millions	38 Ice Cave Mode	59 Not Used In This Game
18 Stoning Mode	39 Lite Lock 1	60 Not Used In This Game
19 Creature Feature Mode	40 Lite Lock 2	61 Not Used In This Game
20 Lynch Justine Mode	41 Move Jackpot	62 Not Used In This Game
21 North Pole Mode	42 Change Scene	63 Extra-Ball Button (Buy-a-Ball)
		64 Start Button

Please Note:  
General Illumination (G.I.)  
Lamps are not shown.  
For Bulb Types & Sockets,  
see pages 46 & 47

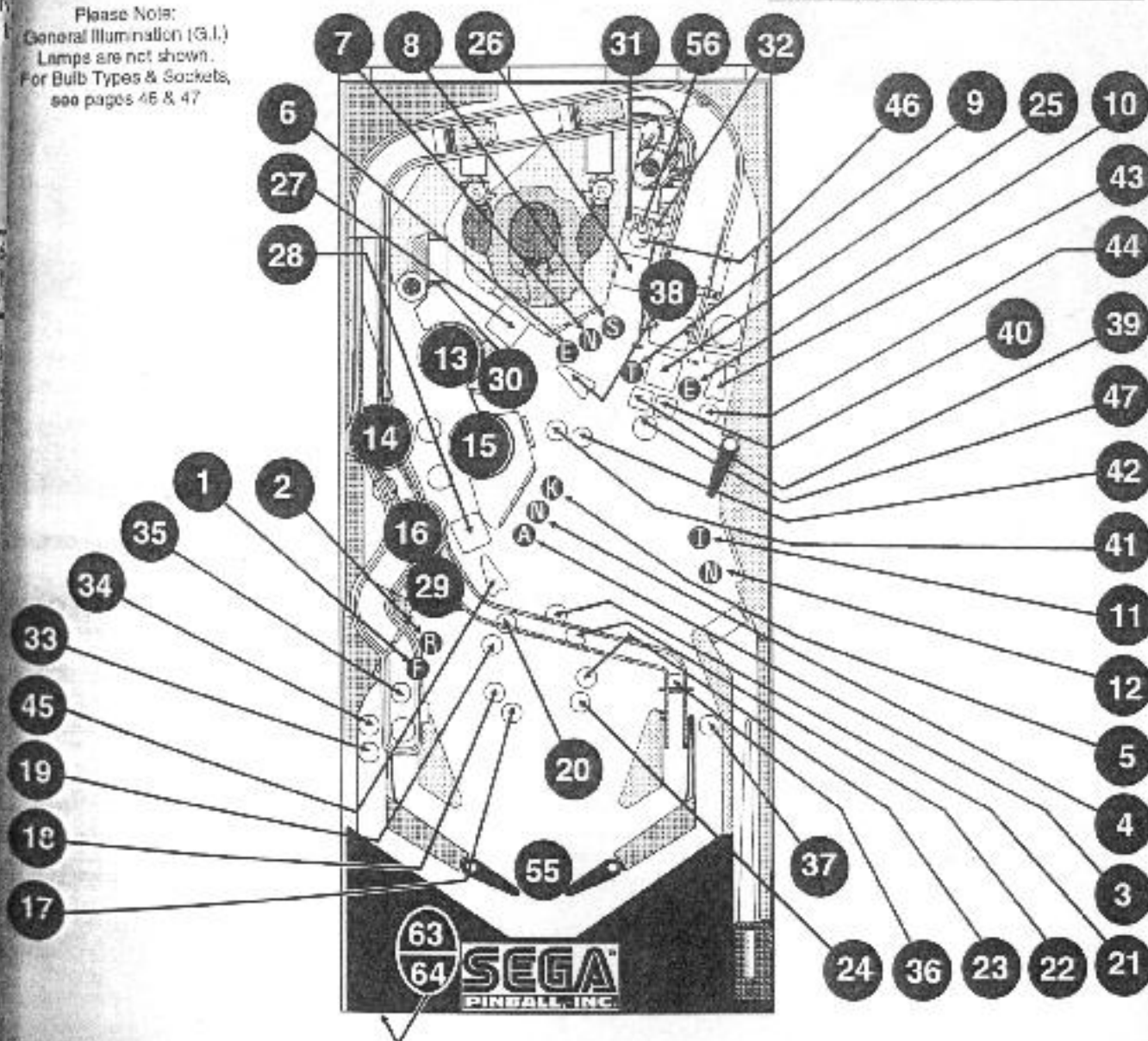

## LAMP TESTS CONTINUED

### Single Lamp

From the LAMP DRIVES test, depress the STEP push-button switch. The display will indicate the lamp name. The display indicates the row and column wire colors and the lamp matrix number. Lamp 01 should light. With FORWARD/REVERSE push-button switch in the FORWARD (up) position, operating the Game Start push-button switch selects higher-numbered lamps; with it in the REVERSE (down) position, Game Start selects lower-numbered lamps.

### FLASH LAMP / COIL TESTS

Twenty-Two regular (pulsed under microprocessor control) coil drivers are provided to switch ground to coils. The Left/Right Relay is used in conjunction with drives 1 through 8 to switch +32 volts between coils or flash lamps; these sets are termed "left" and "right". This relay is located on the PPB board which provides isolation diodes and current limiting resistors. This effectively provides 29 regular coils.

### Flash Lamp

From the Single Lamp test, depress the STEP push-button switch. All Flash lamps will fire randomly. This allows the Technician to easily spot any burned out bulbs and replace them without stepping through the tests below.

### Automatic Test

From the Flash Lamps test, depress the STEP push-button switch. The dot matrix display will indicate ALL COILS. The test pulses each regular solenoid or flash lamp sequentially with the coil/flash lamp names and the wire colors indicated in the display.

### Select Coil

From the Coil Test, depress the STEP push-button switch. The display will indicate SELECT COIL and then the name of 1st drive and the wire colors. Operate either Flipper push-button switch to select the coil or flash lamp to be tested. With the desired drive number indicated in the display, depress the START push-button switch cause it to be pulsed repeatedly.

### Return To Game Over

From the Select Coil test, depress the STEP push-button switch once. The game returns to the game-over mode.

### PLAYFIELD COILS / BACKBOX & PLAYFIELD FLASH LAMP LOCATIONS

The remaining pages of this section will identify the coils and flash lamp locations on the playfield and back box. The next page illustrates this with a mini-table naming each one. The last two pages of this section describe in detail both coils & flash lamps in the "Switched, CPU Controlled Auxillary & Constant Power Solenoids" Table and the "Flipper Solenoids" Table. The next page is the Coil Chart Schematic. For more information see the "Schematics / Troubleshooting" Yellow Section at the end of this manual.



1L	
1R	
2L	Ba
2R	
3L	
3R	
4L	B
4R	F
5L	T
5R	
6L	
6R	F
7L	
7R	
8L	



## Coil Locations

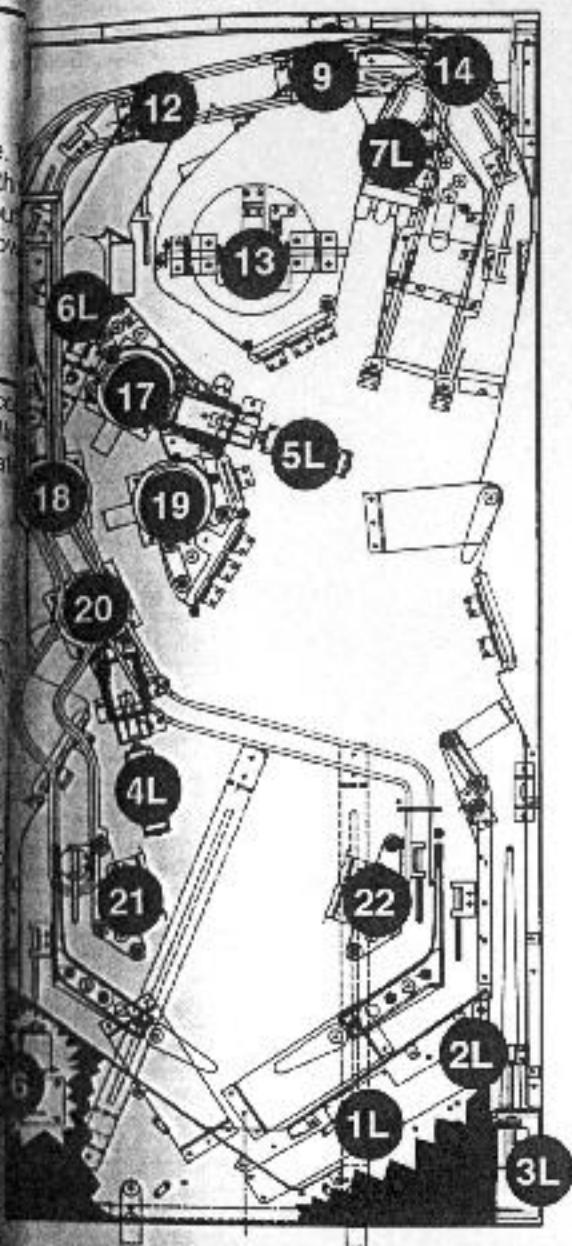

## Flash Lamp Locations

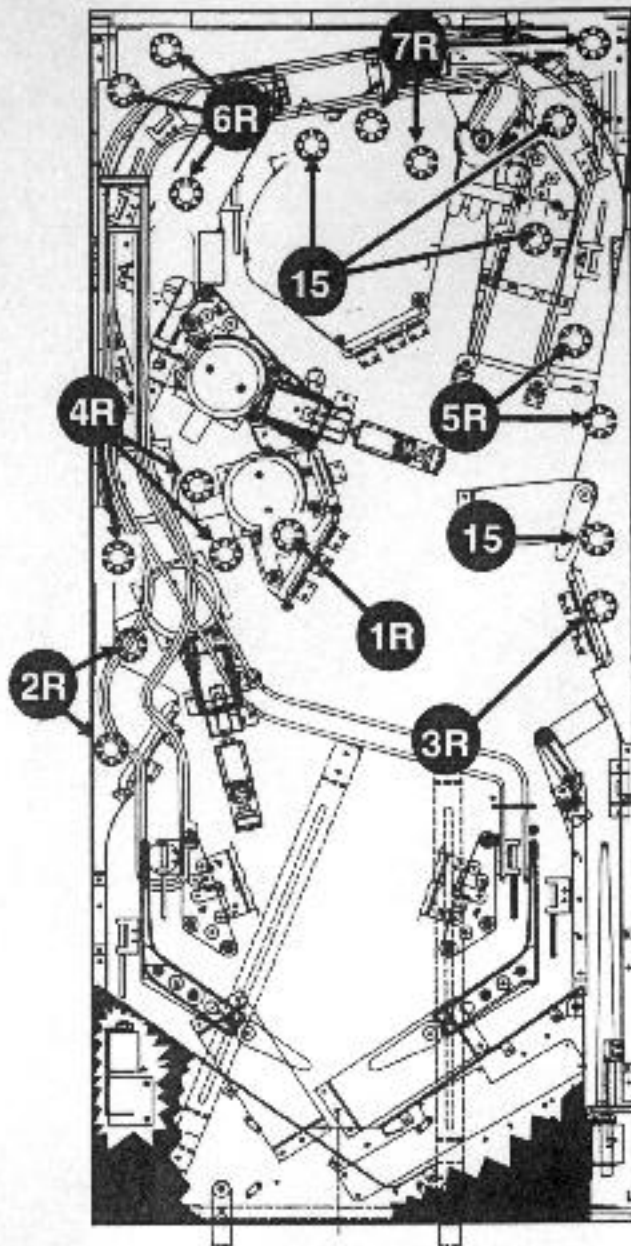

1L	6-Ball Ass'y Lockout	8R	Not Used
1R	Flash above 'A-N-K'	09	Ramp Trap Door Right
2L	Ball Eject to Shooter Lane	10	Left/Right (A/B) Relay
2R	Flashes above 'F-R'	11	G.I. Relay
3L	Auto Launch 50v	12	Ramp Trap Door Left
3R	Flash above 'I-N'	13	Monster Arms
4L	Bot. Scoop Kick-Big 50v	14	Right Orbit Ball Diverter
4R	Flashes by Pop Bumpers	15	Flashes around VUK
5L	Top Scoop Kick-Big 50v	16	Laser Kick 50v
5R	Flashes by Spinner	17	Top Turbo Bumper
6L	Playfield Ball Eject	18	Mid. Left Turbo Bumper
6R	Flashes Upper Left Corner	19	Mid. Right
7L	VUK 50v	20	Bottom Turbo Bumper
7R	Flashes around VUK	21	Left Slingshot
8L	Knocker 32v	22	Right Slingshot

Note: Shaded areas not shown on Diagrams.  
G.I. = General Illumination Lamps

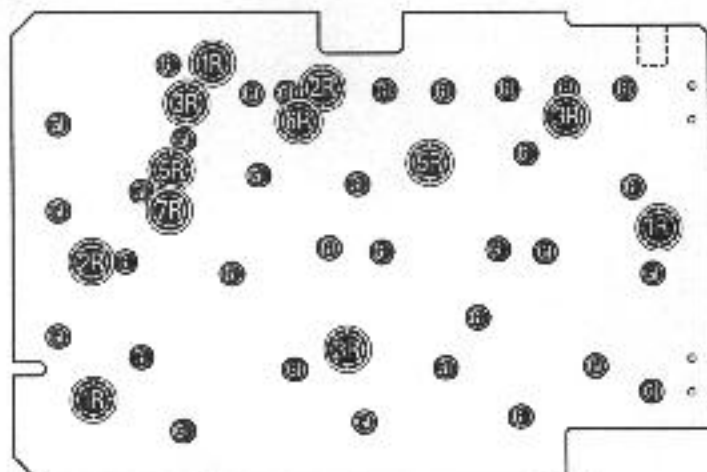

Backbox (Insert) Flash Lamps & G.I.s

### Switched, CPU Controlled Auxiliary & Constant Power Solenoids

Coil No.	Coil or Flashlamp Description	Drive Transistor (D.T.)	On Which Board?	D.T. Control Line	D.T. Core of Line Connect	Power Line	Power Line Connection	Power Description	Coil or Flash Lamp
1L	Coil: 8-Ball Assembly Lookout	Q46	CPU	VIO-BRN	PPB J2-1	BRN	PPB J6-1, 2	32v L	25-1248
1R	Flashlamp: X1 P/F, Insert X3 Flashes above "A-N-K"			BLK-BRN	PPB J9-1	ORN	PPB J6-4, 5	32v R	Bulb #88
2L	Coil: Trough Up-Kicker (TRUK)	Q45	CPU	VIO-RED	PPB J2-2	BRN	PPB J6-1, 2	32v L	23-800
2R	Flashlamp: X2 P/F, Insert X2 Flashes above "F-R"			BLK-RED	PPB J9-2	ORN	PPB J6-4, 5	32v R	Bulb #88
3L	Coil: Auto Launch 50v	Q44/Q5	CPU/PPB	VIO-ORN	PPB J8-2	YEL/VIO	PPB J7-8	50v L	24-940
3R	Flashlamp: X1 P/F, Insert X3 Flashes above "I-N"	Q44	CPU	BLK-ORN	PPB J9-5	ORN	PPB J6-4, 5	32v R	Bulb #88
4L	Coil: Bottom Scoop Kick-Big	Q43	CPU	VIO-YEL	PPB J2-4	BRN	PPB J6-1, 2	32v L	23-800
4R	Flashlamp: X4 P/F, Insert X6 Flashes by Pop Bumpers			BLK-YEL	PPB J8-4	ORN	PPB J6-4, 5	32v R	Bulb #88
5L	Coil: Top Scoop Kick-Big	Q42/Q2	CPU	VIO-GRN	PPB J2-5	YEL/VIO	PPB J7-8	50v L	23-800
5R	Flashlamp: X2 P/F, Insert X2 Flashes by Spinner	Q42	CPU/PPB	BLK-GRN	PPB J9-5	ORN	PPB J6-4, 5	32v R	Bulb #88
6L	Coil: Playfield Ball Eject	Q41	PPB	VIO-BLU	PPB J2-8	BRN	PPB J6-1, 2	32v L	24-940
6R	Flashlamp: X3 P/F, Insert X1 Flashes Upper Left Corner		CPU	BLK-BLU	PPB J9-6	ORN	PPB J6-4, 5	32v R	Bulb #88
7L	Coil: VUK 50v	Q40/Q4	CPU	VIO-BLK	PPB J8-4	YEL/VIO	PPB J7-8, 2	50v L	24-940
7R	Flashlamp: X3 P/F, Insert X1 Flashes around VUK			BLK-VIO	PPB J9-7	ORN	PPB J6-4, 5	32v R	Bulb #88
8L	Coil: Knocker 32v (In Cabinet)	Q39	CPU	VIO-GRY	PPB J2-9	BRN	PPB J6-1, 2	32v L	23-800
8R	Flashlamp: X0 P/F, Insert X0 Not Used In This Game.			---	---	---	---	---	---
09	Coil: Ramp Trap Door Right	Q30	CPU	BRN-BLK	CPU CN 12-1	RED	PS CN 3-6, 7	32v	20-1050
10	Coil: Located on PPB in Backbox Left & Right Relay	Q29	CPU	BLK-RED	CPU CN 12-2	RED	PS CN 6-7	32v	24v DC 10A DPDT
11	Coil: Located on Power Supply Bd. G.I. Relay	Q28	CPU	BRN-ORN	CPU CN 12-4	RED	PS CN 3-6, 7	32v	24v DC 10A DPDT
12	Coil: Ramp Trap Door Left	Q27	CPU	BRN-YEL	CPU CN 12-5	RED	PS CN 3-6, 7	32v	28-1050
13	Coil: Monster Arms	Q26	CPU	BRN-GRN	CPU CN 12-6	RED	PS CN 3-6, 7	32v	23-800
14	Coil: Right Orbit Ball Diverter	Q25	CPU	BRN-BLU	CPU CN 12-7	RED	PS CN 3-6, 7	32v	27-1400
15	Flashlamp: X4 P/F, Insert X0 Flashes around VUK	Q24	CPU	BRN-VIO	CPU CN 12-8	RED	PS CN 3-6, 7	32v	27-1500
16	Coil: Laser Kick 50v	Q23/Q1	CPU/PPB	BRN-GRY	PPB J8-12	VIO-YEL	PPB J7-8	50v	23-800
17	Coil: Top Turbo Bumper	Q11	CPU	BLU-BRN	CPU CN 19-7	RED	PS CN 3-6	32v	23-700
18	Coil: Middle Left Turbo Bumper	Q9	CPU	BLU-RED	CPU CN 19-4	RED	PS CN 3-6	32v	23-700
19	Coil: Middle Right Turbo Bumper	Q8	CPU	BLU-ORN	CPU CN 19-3	RED	PS CN 3-6	32v	23-700
20	Coil: Bottom Turbo Bumper	Q10	CPU	BLU-YEL	CPU CN 19-6	RED	PS CN 6-6, 7	32v	23-800
21	Coil: Left Slingshot	Q12	CPU	BLU-GRN	CPU CN 19-8	RED	PS CN 6-6, 7	32v	23-800
22	Coil: Right Slingshot	Q13	CPU	BLU-BLK	CPU CN 19-9	RED	PS CN 6-6, 7	32v	23-800

### Flipper Solenoids

SSFB No.	Flipper Coil	Cabinet Switch	Switch Relay	Switch Bounce	E.O.S.	RVB	Flipper 50vDC Power	Flipper 5vDC Hold	Flipper Coil Output
SSFB 1	Lwr. RL Flipper 23-1100 BLU/YEL ORN/VIO	BLU-VIO SSFB CN1-7	GRN-GRY CPU CN6-2 TO SSFB CN1-4	WHT-GRY CPU CN10-1 TO SSFB CN1-9	BRN-VIO RT. EOS SW. TO CN1-1	BLK CPU CN5 TO CN1-6	BLK-WHT PPB J7-1, -5 to SSFB CN2-8, -9	GRY-GRN-GRY PS CN1-11, -11, 10 SSFB CN2-7, -8	50v Q2, Q3, 1 50V CN2-7, 8
SSFB 1	Lwr. Lt. Flipper 23-1100 GRY/YEL ORN/GRY	BLU-GRY SSFB CN1-11	GRN-GRY CPU CN6-3 TO SSFB CN1-4	WHT-VIO CPU CN13-2 TO SSFB CN1-6	BRN-GRY LT. EOS SW. TO CN1-9	BLK CPU CN5 TO CN1-6	BLK-WHT PPB J7-1, -5 to SSFB CN2-8, -9	GRY-GRN-GRY PS CN1-10, -11, 10 SSFB CN2-7, -8	50v Q10, Q8, 1 50V CN2-4, 6
SSFB 1	Upr. Rt. Flipper 23-1100 BLU/YEL ORN/GRY	GRY-VIO SSFB CN1-12	GRN-GRY CPU CN6-3 TO SSFB CN1-4	WHT-GRY CPU CN10-2 TO SSFB CN1-10	Not Used	BLK CPU CN5 TO CN1-6	BLK-WHT PPB J7-1, -5 to SSFB CN2-8, -9	GRY-GRN-GRY PS CN1-10, -11, 10 SSFB CN2-7, -8	50v Q15, 1 50V CN2-1, 2







# PARTS IDENTIFICATION (PINK SECTION) Page Guide

Page 42  
Playfield:  
Major Assemblies

Page 43  
Playfield:  
Ramps and Rails

Page 44  
Playfield:  
Butyrate

Page 45  
Playfield:  
Parts

Page 46  
Playfield:  
Rubber Parts

Page 47  
Playfield:  
Posts

Page 40  
Backbox  
Parts

Pages 48 & 49  
Backbox  
Lamps & Sockets

Page 41  
Cabinet  
Parts

Pages 48 - 50  
Under Playfield:  
Lamps, Sockets  
& Lamp Boards

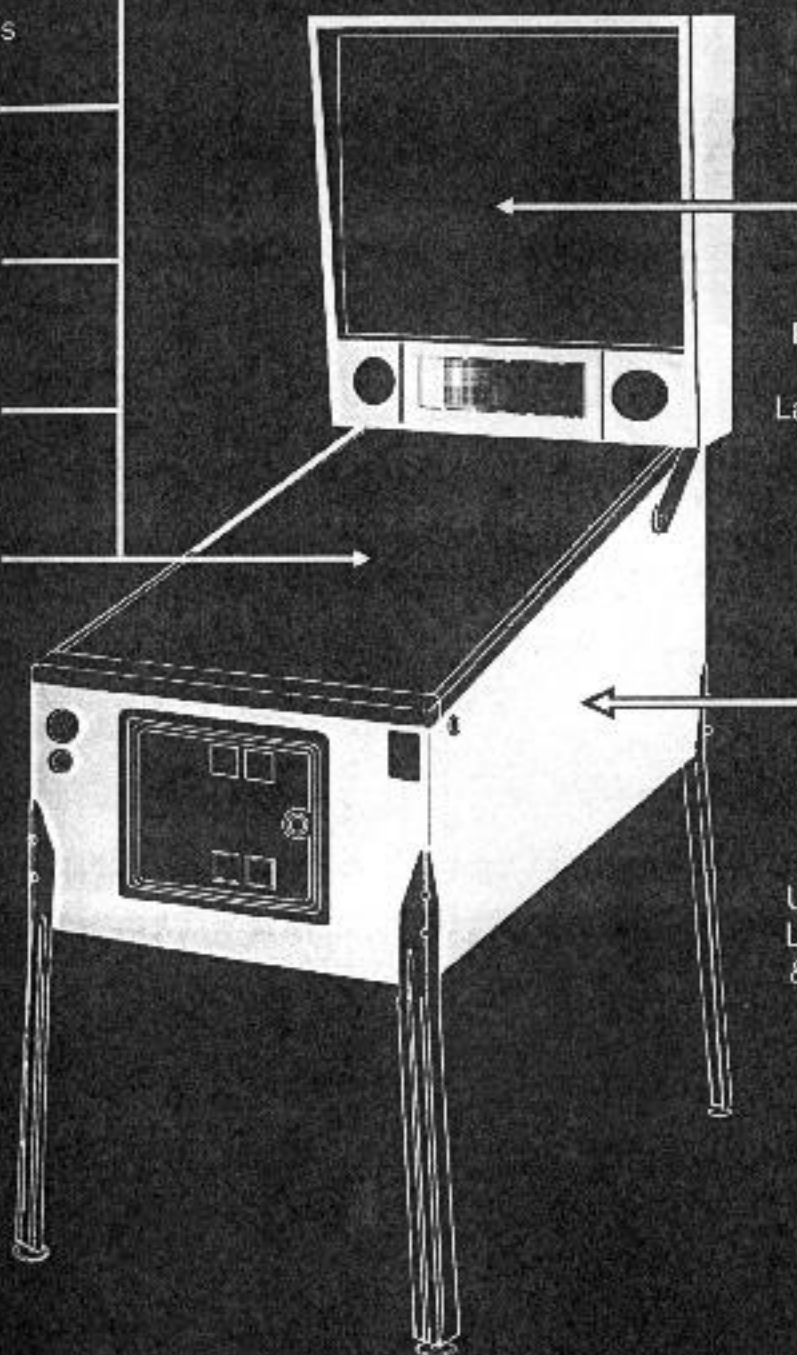

## BACKBOX - PARTS

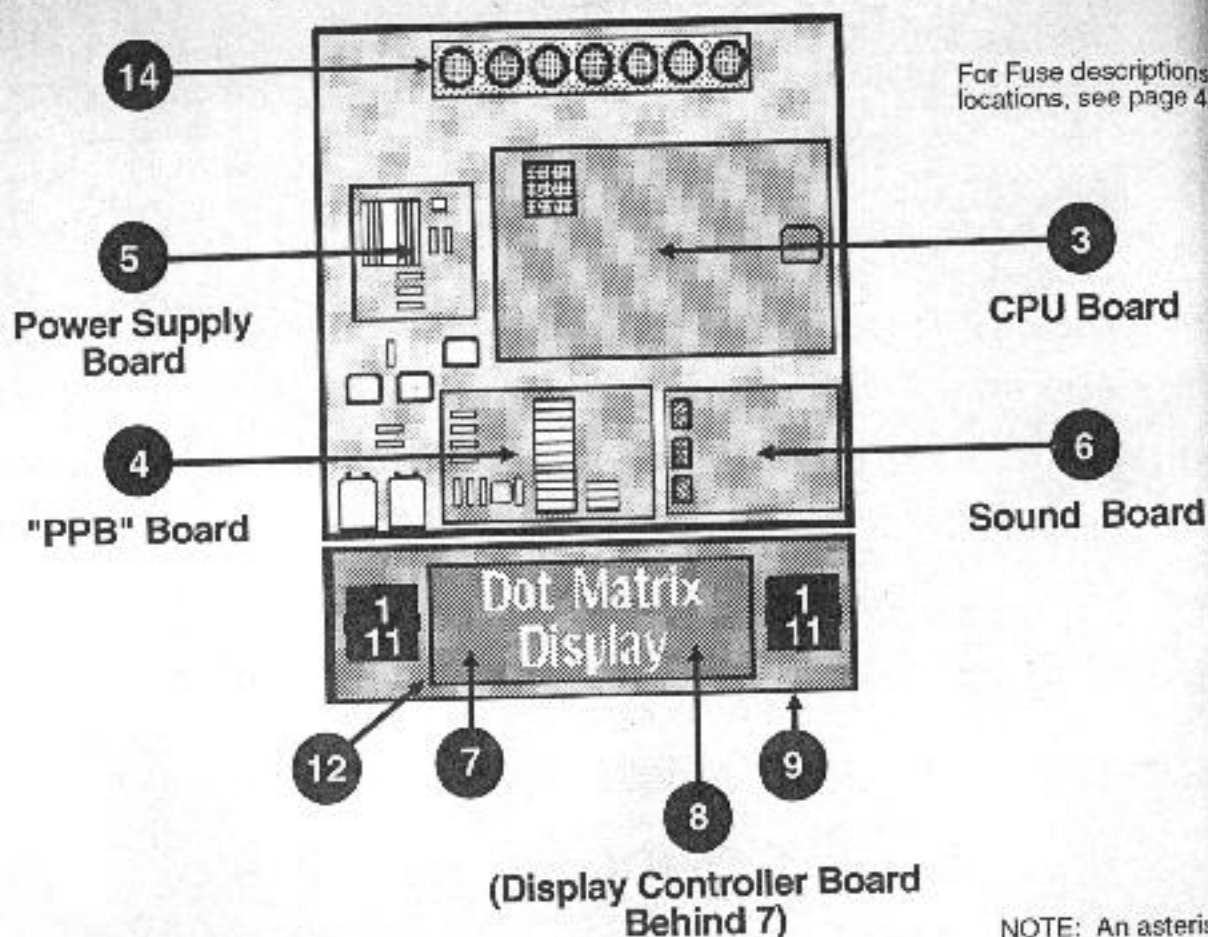

NOTE: An asterisk (\*) (shaded items) indicates item is not noted in this illustration.

Item	Description	Part No.	Item	Description	Part No.
1	Speakers 4X4 Quem 89-9572 ( X2)	031-5004-00	15 *	Static Shield *	535-6227-00
2 *	Back Box Lock	355-5008-00	16 *	Backglass Clear 26 7/8" X 18 3/4" *	660-5018-00
3	CPU Bd. Non-Reflexive †	520-5003-04	17 †	26 7/16" Plastic Extrusion *	545-5018-08
4	PPB Board Ass'y Rev. C	520-5021-05	18 *	18 3/4" Plastic Extn. (Qty. 2) *	545-5018-00
5	Power Supply	520-5047-03	19 *	Glass Channel 26-7/16" *	545-5021-02
6	Sound Board 3X 4MB †	520-5077-03	20 *	MSF Lights Insert Assembly *	505-6003-36
7	New Large Dot Matrix Display Board 192 X 64! ††	520-5075-00	21 *	Ribbon Cable, 14-Pin * Display to Display	602-5005-14
8	Display Controller Bd. †	520-5092-01	22 *	Ribbon Cable, 20-Pin * CPU to Sound Board	602-5005-20
9	Speaker Panel Assembly	600-5915-00	23 *	Ribbon Cable, 26-Pin * CPU to Display	602-5005-26
10 *	MSF Backglass Artwork *	830-5236-00	24 *	Insert Door Slide Latch	535-5001-00
11	Mary Shelley's Frankenstein Speaker Grill w/Artwork	830-5637-00			
12	Max. Speaker Flexi w/ Artwork	830-5636-00			
13	Item Number Not Used	-----			
14	7 Vent Hole Grill 2 1/2" X 18"	545-5072-02			

† When ordering PC Boards with ROMS, please specify the Game.  
 †† Indicate Manufacturer.



## CABINET - PARTS

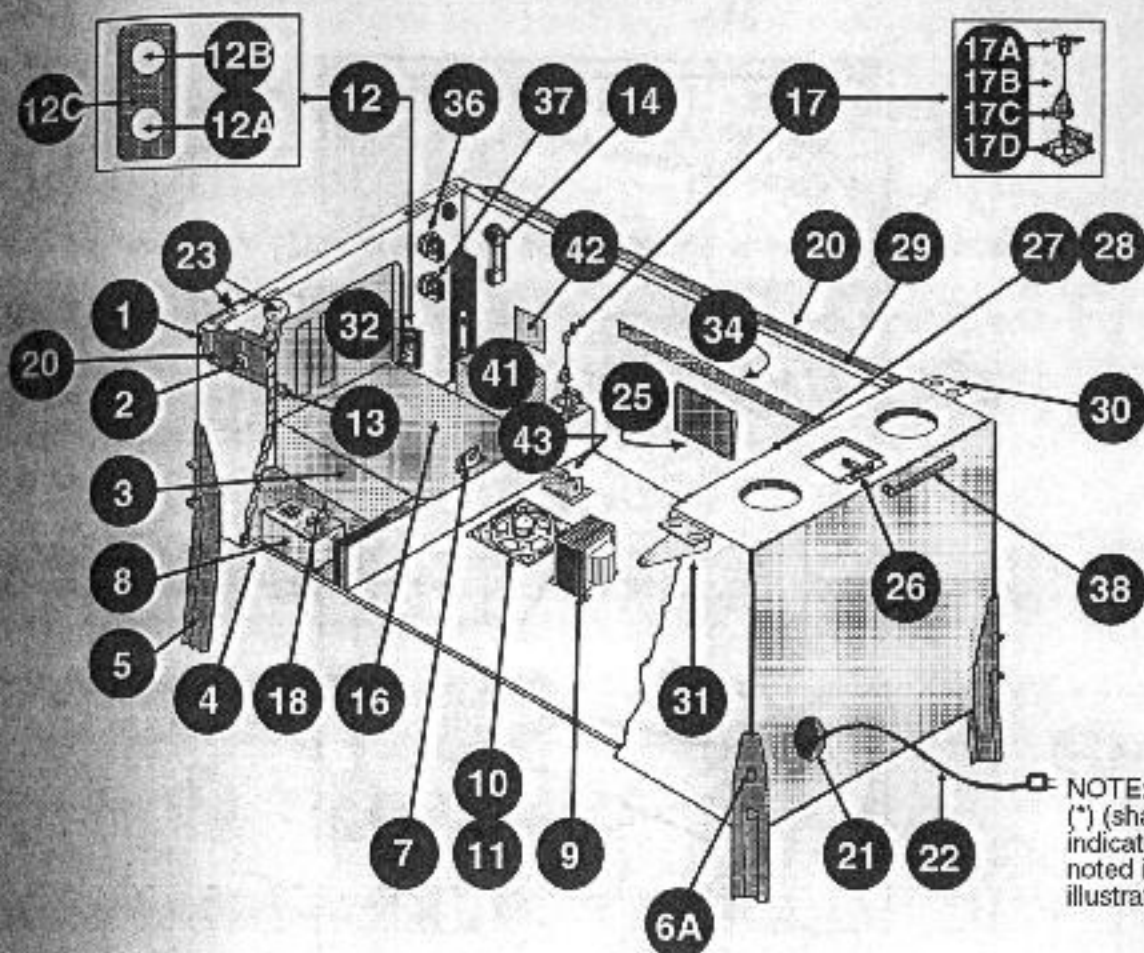

NOTE: An asterisk (\*) (shaded items) indicates item is not noted in this illustration.

Item	Description	Part No.	Item	Description	Part No.
1	Up/Down Lever Assembly (see page 52)	500-5918-00	19 *	Playfield Glass (T.P.) 21" x 45" *	660-5001-00
2	Flipper Button Red Assy (Solid) (Qty. 2)	500-5026-32	20	Side Armor - Left & Right	535-6831-00
3	Cash Box Plastic Bottom	545-5090-00	21	Recessed Cup for Line Cord	545-5122-00
4	Power Sw. DPST Toggle (Under Cab.)	180-5001-00	22	Line Cord 10' ROJ 3" Maximum	034-5000-10
5	Leg (Black) (Qty. 4)	535-5020-50	23 *	Front Molding Lockdown Assy*	500-5020-01
6A	Leg Bolt (BLK) 3/8-16 x 2-1/2 Hex Hd. (Qty. 8)	231-5000-01	24 *	Front Molding - Black *	500-5757-01
6B	Leg Leveler 3/8-16 x 2-1/2 (Qty. 4) *	500-5017-00	25	Solid State 3-Flipper Board (SSFB)	520-5076-00
7	Cash Box Lock Bracket	535-5215-00	26	#1 Roto Lock Male (Female -02) *	355-5006-01
8	Service Outlet	180-5008-01	27	Rear Plastic Ext. P/F Glass 20-1/2"	545-5038-00
9	Transformer	010-5008-00	28	Mounting Fm. Rubber for Ext.	626-5001-00
10	Speaker-Round - 6"	031-5005-00	29	Plastic Channel Left & Right	545-5017-00
11	Speaker Grill 7 X 7	535-6830-00	30	Backbox Hinge Left	515-5987-00
12	Dual Switch Assy (Includes 12A-12C)	500-5808-00	31	Backbox Hinge Right	515-5987-01
12A	Memory Protect Switch	180-5000-00	32	Coin Door (w/Validator) USA	500-5018-17
12B	Interlock Switch	180-5136-00	33 *	Slide & Pivot Support Bracket Right*	535-5989-00
12C	Bracket	535-6958-00		Slide & Pivot Support Bracket Left	535-5990-00
13	Service Switch Set (Step Up / Down) Located on the Coin Door By Lock	180-5012-00	34 *	Edge Slide Bracket *	535-5988-00
14	Flipper Switch, Left	180-5122-01		Playfield Support Slide Rev. A *	535-6862-00
15 *	Flipper Switch, Right (Top/Bottom)	180-5048-00	35 *	Playfield Support Bar* (Stay Arm)	535-5019-00
16	Cash Box Cover (Validator)	535-5013-03	36	Start Button Switch Assy (Frankenstein)	500-5728-36
17	Plumb Bob Tilt Assy (Incl. 17A-17D)	500-5023-00	37	Extra Ball Switch Assy (Orange)	500-5779-07
17A	Hanger Bracket (tilt)	535-5021-00	38	5/16" Hex Key Allen Wrench	777-0001-00
17B	Hanger Wire (Rt) (Attach to *17A*)	535-5319-00	39 *	Backbox/Cabinet Matrix/Fuse Info *	620-6104-03
17C	Plumb Bob (Lft) (Attach to *17B*)	535-5029-00	40 *	3-Flipper Board Cover *	545-5165-02
17D	Contact Bracket (tilt)	535-5220-00	41 *	Shaker Motor (Not Used This Name)	515-5893-00
18	Volume Control Single 10K Pot	123-5000-02	42 *	Shaker Motor P.C. Board (Not Used)	520-5065-00
			43	Knocker Assembly (see page 56)	500-5081-00

## PLAYFIELD - MAJOR ASSEMBLIES †

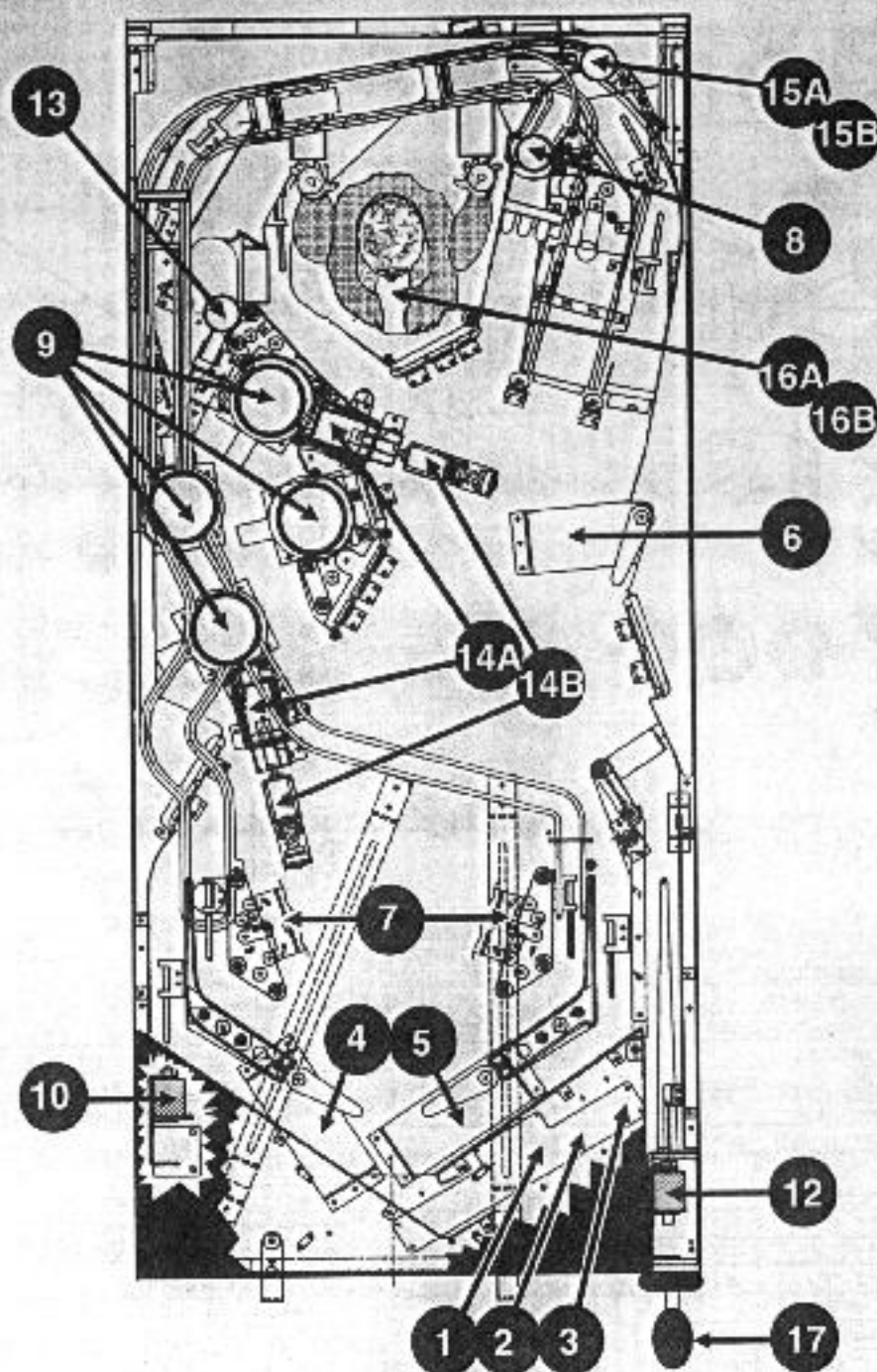

Item	Description	Part No.	Item	Description	Part No.
1	6-Ball Sw. Asm. (Under P/F)	500-5663-03	11	Knocker Assembly (In Cabinet)	500-5081-00
2	Lock Ball Asm. (Under Arch)	500-5664-01	12	Ball Kicker (Auto Launch) Asm.	500-5477-01
3	Deflector for 4-Ball Asm.	535-6606-01	13	Ball Eject Assembly	500-5664-01
4	Flipper Asm., Lower Right	500-5832-01	14A	Power Scoop Asm. (Qty. 2)	500-5809-00
5	Flipper Asm., Lower Left	500-5832-02	14B	Kick-Big Assemblies (Qty. 2)	500-5862-00
6	Flipper Asm., Upper Right	500-5894-01	15A	Diverter Assembly	500-5654-00
7	Slingshot Assemblies (Qty. 2)	500-5849-00	15B	Diverter Plunger & Crank Arm	515-5453-00
8	Vertical Up-Kicker Asm. (VUK)	500-5839-00	16A	Frankenstein Assembly	500-5887-00
9	Turbo Bumper Asm. (Qty. 4)	500-5227-02	16B	Man Plate Asm. (Under 16A)	515-6153-00
10	Laser Kick Back Assembly	500-5838-00	17	Up/Down Lever Assembly	500-5918-00

† See Unique Parts for Major Assembly Breakdowns.



# PLAYFIELD - RAMPS † AND RAILS

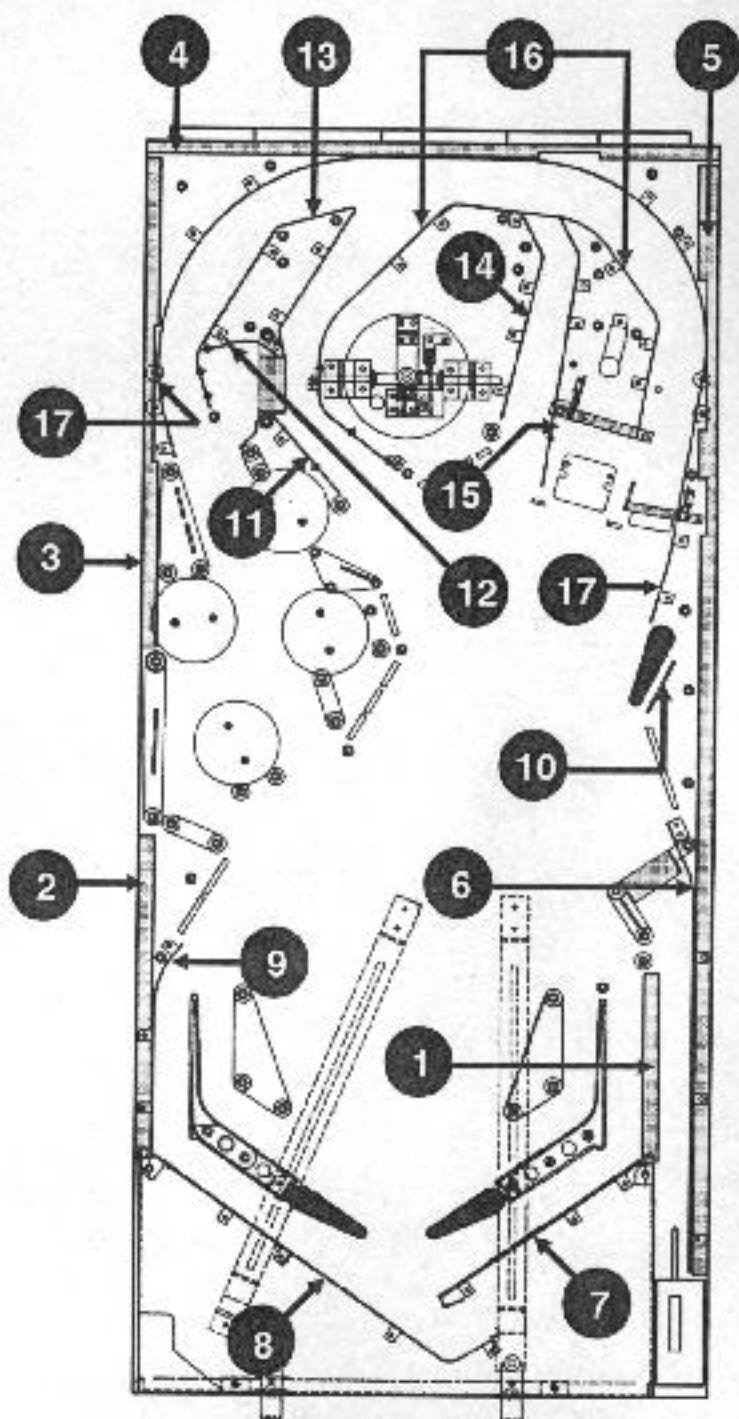
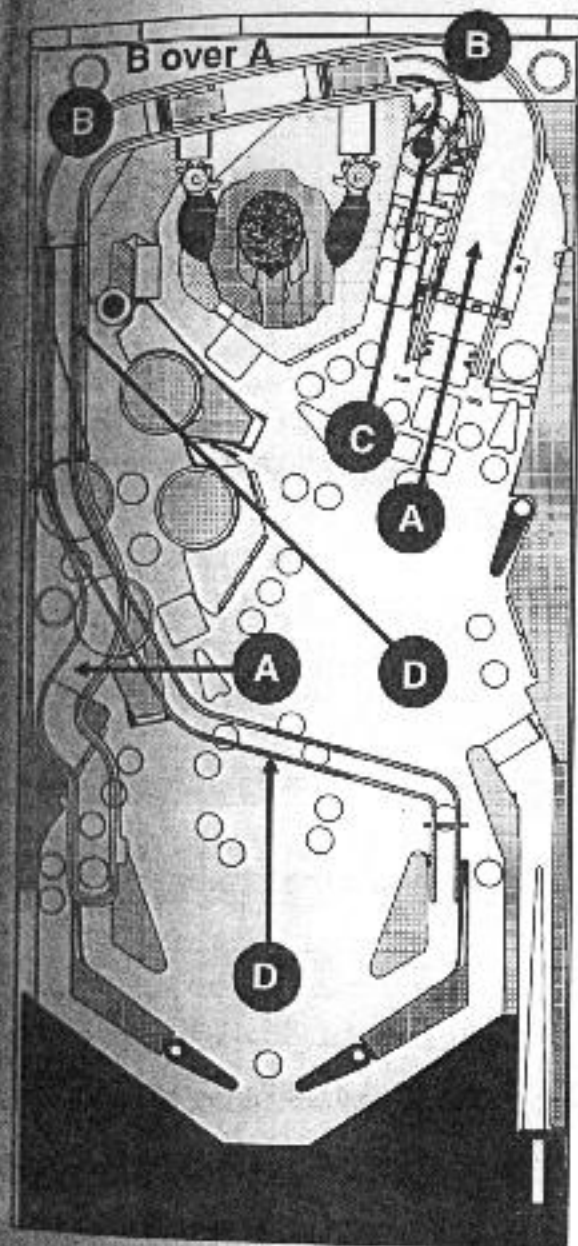

Item	Desc.: Ramps	Part No.	Item	Desc.: Rails	Part No.
A †	Main Ramp Assembly	500-5923-00	7	Flat Rail - Arch/Right Outlane	515-6043-00
B †	Upper Small Ramp	500-5905-00	8	Flat Rail - Arch/Left Outlane	515-6042-00
C	VUK Wire Ramp to Upper Small Ramp	535-7139-00	9	Flat Rail - Left Outlane	535-7150-00
D	Wire Ramp from Upr. Ramp to Outlane	535-7207-00	10	Flat Rail - Behind Upper Flipper	535-7263-00
			11	Flat Rail - Over Top Pop to Eject	515-6189-00
			12	Flat Rail - Small Back of Eject	515-6193-00
			13	Flat Rail - Left Orbit Right Side	515-6191-00
			14	Flat Rail - To VUK Left Side	535-7148-00
			15	Flat Rail - To VUK Right Side	515-6190-00
			16	Flat Rail - Rt. Orbit Lt./Creature	515-6182-00
			17	Flat Rail - Full Outside Orbit	535-7147-00
				† See Unique Parts for Ramp Breakdowns.	



## PLAYFIELD - BUTYRATE

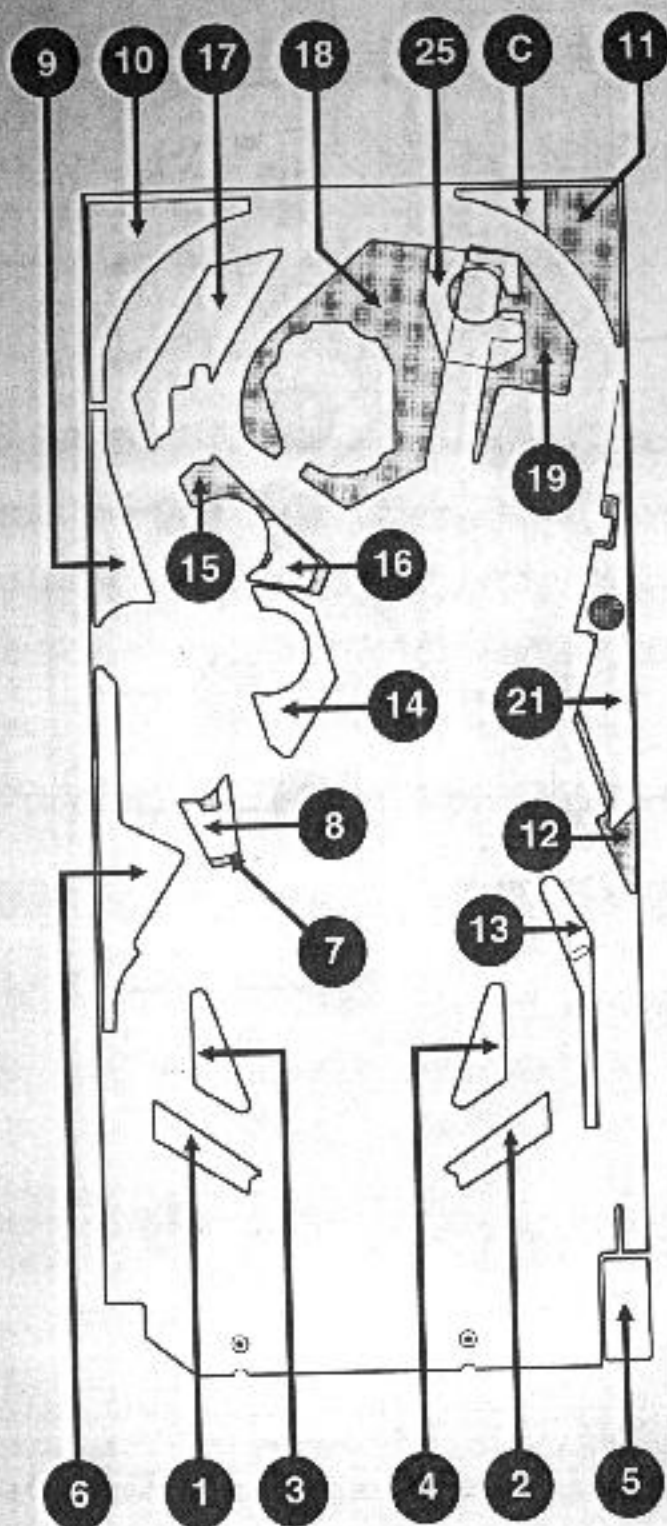

Shaded items indicate butyrate piece is lower than the unshaded item next to it.

Item	Desc.: Screened Butyrate	Part No.
XX	Butyrate Pieces Screened (1-25)	830-5473-XX
For entire sheet, order with the Part No. ending in -XX		
To order individual replacement Screened Butyrate, replace -XX with the correct 2-number ending.		
1	Over Ball Guide Left	830-5473-01
2	Over Ball Guide Right	830-5473-02
3	Over Slingshot Left	830-5473-03
4	Over Slingshot Right	830-5473-04
5	Over Auto Launch / Shooter Lane	830-5473-05
Note: Item 5 has a riveted Bulb & Wedge Socket.		
To order with bulb / socket use Part No.: 515-6196-0		
6	Left Playfield below Pop Bumpers	830-5473-06
7	Lower Scoop Lower Level	830-5473-07
8	Lower Scoop Upper Level	830-5473-08
Note: Item 8 has a riveted Bulb & Wedge Socket.		
To order with bulb / socket use Part No.: 515-6214-0		
9	Left Playfield next to Pop Bumpers	830-5473-09
10	Upper Left Corner	830-5473-10
11	Upper Right Corner Lower Level	830-5473-11
12	Right Playfield Lower Level	830-5473-12
13	Shooter Lane Lt. Side / Rt. Outlane Rt.	830-5473-13
14	Around Middle Right Pop Bumper	830-5473-14
15	Upper Scoop and Top Pop Lower Level	830-5473-15
16	Upper Scoop Upper Level	830-5473-16
Note: Item 16 has a riveted Bulb & Wedge Socket.		
To order with bulb / socket use Part No.: 515-6215-0		
17	Upper Left Orbit Right Side	830-5473-17
18	Around Monster & to VUK Left Side	830-5473-18
19	Under Big Ramp Right Orbit Left Side	830-5473-19
20 *	Key Chain *	830-5473-20
21	Right Playfield Upper Level	830-5473-21
Note: Item 21 has a Bulb, Socket & Red Mini-Mars.		
To order with bulb / socket use Part No.: 515-6209-0		
22 *	Backpanel *	830-5473-22
23	Number Not Used	-----
24	Number Not Used	-----
25	Around VUK	830-5473-25
Note: Item 25 has 3 riveted Bulb & Wedge Sockets.		
To order with bulb / socket use Part No.: 515-6217-0		

Item	Desc.: Clear Butyrate	Part No.
XX	Butyrate Pieces Clear (1-5)	830-5474-XX
For entire sheet, order with the Part No. ending in -XX		
To order individual replacement Clear Butyrate, replace -XX with the correct 2-number ending.		
A *	Long Piece to protect Pop Bumpers *	830-5474-01
B *	Back Cabinet / Playfield *	830-5474-02
C	Upper Right Corner Upper Level	830-5474-03
D *	Small Round Piece over Lower Pop *	830-5474-04
E *	On the Ramp Right Side *	830-5474-05

\* - An asterisk indicates item is not noted in the illustration

## PLAYFIELD - PARTS

Part No.	Desc.	Gen.	Parts atop P/F	Part No.
830-5473-XX	Bottom Arch Assembly (Metal)			500-5911-00
ending in -X	Bottom Arch (Plain)			535-7157-00
ed Butyrate	1-1/16" Steel Balls (6 Total)			260-5000-00
er ending	Pop Bumper Cap (Red)			550-5057-02
330-5473-01	Pop Bumper Cap (Green)			550-5057-04
330-5473-02	Pop Bumper Cap (Blue)			550-5057-05
330-5473-03	Pop Bumper Cap (Yellow)			550-5057-06
330-5473-04	Flipper & Shaft Ass'y White Right X2 with Sonic The Hedgehog™ Logo			515-5133-01-03
330-5473-05	Flipper & Shaft Ass'y White X1 with Sonic The Hedgehog™ Logo			515-5133-01-04
ge Socket	1-Way Gate X2 (Shooter Lane/Eject)			500-5919-00
515-6196-01	Spinner			500-5658-00
30-5473-06	Spot-Lite Assembly X2 (Ramp/Lt. P/F)			500-5818-00
30-5473-07	Spot-Lite Reflector Only X2			515-5026-11
30-5473-08	Rubber Lite Cover - Red X2			545-5014-02
ge Socket	Rubber Lite Cover - Green X2			545-5014-04
515-6214-01	Rubber Lite Cover - Yellow X3			545-5014-06
30-5473-09	Mini-Mars Lite Covers - Red X4			550-5031-02

Part No.	Desc.	Gen.	Parts under P/F	Part No.
0-5473-11	Playfield Hanging Brackets X2			535-5216-03
0-5473-13	Playfield "Slide-N-Rest" Brackets X2			535-8862-01
0-5473-14	Stay Arm Holder			535-5747-00
0-5473-15	For Other Playfield Moving Devices See Cabinet Parts			
0-5473-16	Pivot Pin Bracket Assembly X2			500-5329-00
ge Socket	Both include Pivot Bracket Screws X4			237-5907-00
5-6215-01	and T-Nuts X4			240-5101-00

Part No.	Desc.	Gen.	Mylar	Part No.
0-5473-17	Mylar Pieces (Clear Pre-Scored)			820-5847-00
0-5473-18	Pop Bumper Area			820-5848-00
0-5473-19	Mylar Pad (Clear : 1' Sq.) X3			820-5815-00
0-5473-21	Front of Slingshot Clear Mylar			820-5821-00

Part No.	Desc.	Gen.	Decals	Part No.
0-5473-22	Decal Sheet (Complete)			820-6119-XX
0-5473-23	01 Arch Left, -02 Arch Right, -03 Arch Center, -04 Arch Raise Left,			
0-5473-24	05 Arch Raise Right, -06 Spinner Front, -07 Spinner Back,			
0-5473-25	08 Ramp Exit Left, -09 & -11 Trap Doors, -12 thru -15 Posts			
0-5473-26	16 Decal Ramp Entrance			820-6121-00

Part No.	Desc.	Gen.	Ball Guides (G)	Part No.
0-5473-27	Ball Guide Upper Right Return			550-5043-01
0-5473-28	Ball Guide Lower Right Return			550-5037-01
0-5473-29	Ball Guide Upper Left Return			550-5038-01
0-5473-30	Ball Guide Lower Left Return			550-5064-01

Part No.	Desc.	Gen.	Wire Forms (W)	Part No.
0-5473-31	Wire Form on Ball Guides X2			535-5642-00
0-5473-32	Wire Form 1" X3			535-5300-05
0-5473-33	Wire Form 2 25"			535-5300-12

Part No.	Desc.	Gen.	Other Part Numbers
0-5473-34	Back Box & Cabinet Parts		
0-5473-35	Major Assemblies, Ramps and Rails		
0-5473-36	Submits		
0-5473-37	Rubber Parts & Posts		
0-5473-38	Lamps with Sockets		
0-5473-39	Lamp Boards		

\* An asterisk indicates item is not noted in the illustration

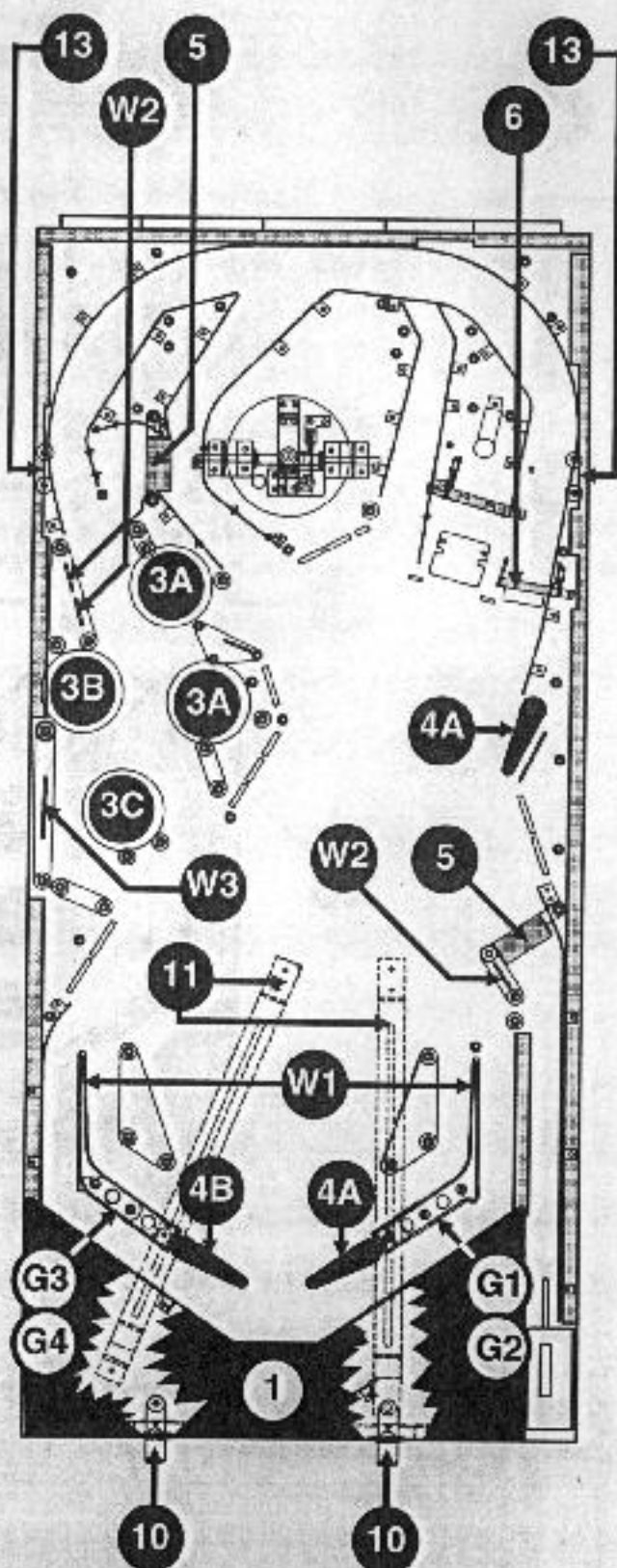

Butyrate, Light Inserts & Ramps are not shown on drawing for clarity. See Playfield - Ramps (pg. 43) & Unique Parts (pgs. 64-65) for other Top Parts on the ramps.



## PLAYFIELD - RUBBER PARTS †

**A**  
Item A is located on the Knacker, Auto Launch, VUK, Laser Kick Back and both Kick-Bigs.

**B**  
Item B is located on the Diverter Plunger.

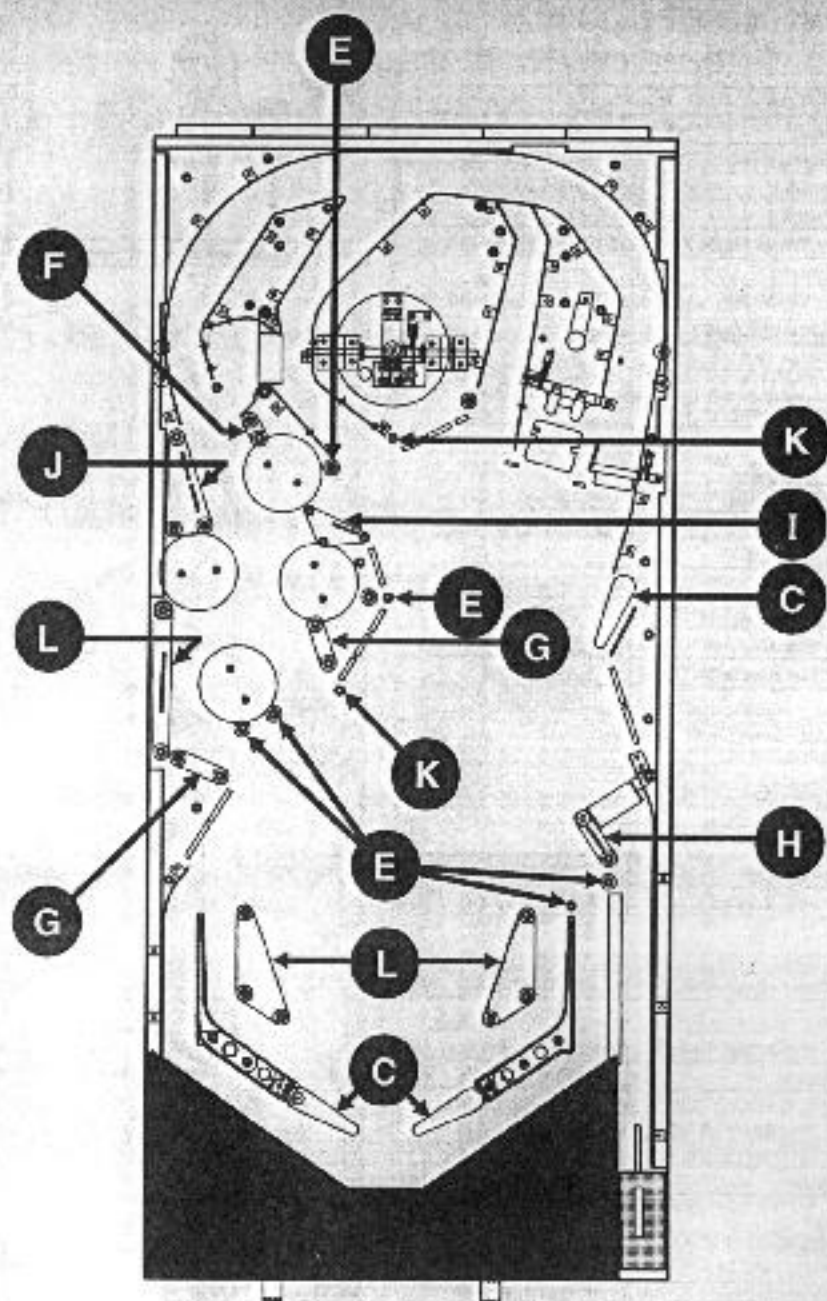

*Please note, the size and/or quantities may change as production continues*

Item	Description	Qty.	Part No.	Item	Description	Qty.	Part No.
A	Rubber Bumper	6	545-5105-00	H	1-1/4" I.D. Black Rubber Ring	1	545-5348-01
—	Post Rubber (Sleeve Short)	0	545-5151-00	I	1-1/2" I.D. Black Rubber Ring	1	545-5348-02
B	Flipper Bushing (Small)	1	545-5192-00	J	2" I.D. Black Rubber Ring	1	545-5348-03
C	Flipper Rubber Rings	3	545-5277-00	—	2-1/2" I.D. Black Rubber Ring	0	545-5348-04
D	Post Rubber (Sleeve Tall)	1	545-5308-00	K	3/8" O.D. Black Rubber Ring	2	545-5348-05
—	5/16" I.D. Black Rubber Ring	0	545-5348-02	L	2-3/4" I.D. Black Rubber Ring	3	545-5348-06
E	3/16" I.D. Black Rubber Ring	6	545-5348-01	—	Bumper Post Rubber	0	545-5009-01
F	3/4" I.D. Black Rubber Ring	1	545-5348-04	—	1-3/4" I.D. Black Rubber Ring	0	545-5348-07
G	1" I.D. Black Rubber Ring	2	545-5348-05				

† Items with a Zero Qty. are not used in this game.



## Playfield - Posts †

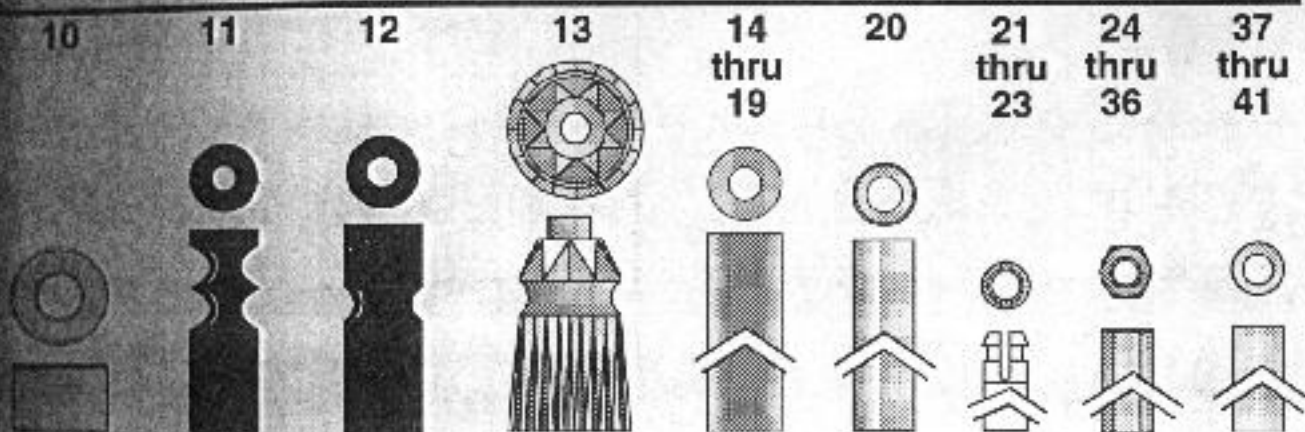
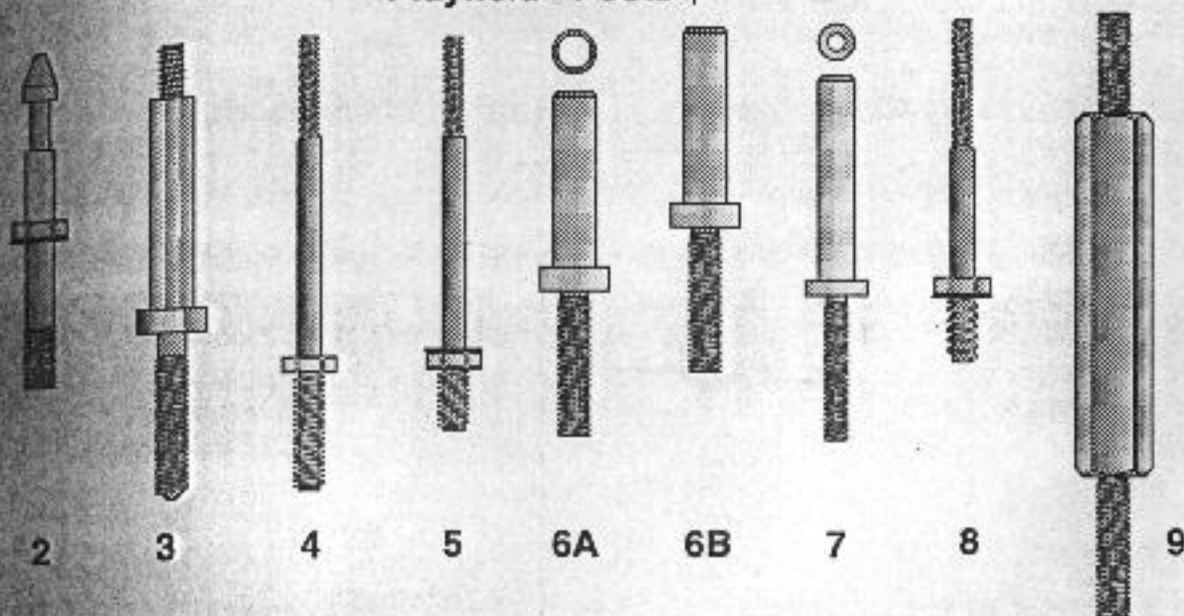

*Please Note, the size and/or quantities may change as production continues.*

Part No.  
545-5340  
545-5341  
545-5342  
545-5343  
545-5344  
545-5345  
545-5346  
545-5347  
545-5348  
545-5349  
545-5350  
game.

Item	Description	Qty.	Part N <sup>o</sup>	Item	Description	Qty.	Part N <sup>o</sup>
1	Mini-Post-Wood Threaded	3	530-5004-00	21	Spacer 3/8" Plastic Stl. Fltn. 8933-4-01	24	254-5007-01
2	Mini-Post-Machine Threaded	3	530-5005-00	22	Spacer 1/4" Plastic Stl. Fltn. 8933-4-01	4	254-5007-02
3	Bumper Post-Machine Threaded	0	530-5007-00	23	Spacer 3/4" Plastic Stl. Fltn. 8933-4-01	0	254-5007-03
4	Machine Post Screw Long	3	530-5008-00	24	Spacer 1/4" Hex Tapped 6-32	0	254-5008-00
5	Post Machine Screw	40	530-5012-02	25	Spacer 1/2" Hex Tapped 6-32	2	254-5008-03
6A	Bumper Post 6-32 Tapped	0	530-5075-00	26	Spacer 5/8" Hex Tapped 6-32	8	254-5008-02
6B	Bumper Post Untapped	1	530-5057-01	27	Spacer 3/4" Hex Tapped 6-32	6	254-5008-04
7	Bumper Post 6-32 Tapped	0	530-5127-00	28	Spacer 1" Hex Tapped 6-32	0	254-5008-06
8	Post Machine Screw	0	530-5263-01	29	Spacer 2" Hex Tapped 6-32	0	254-5008-07
9	Mini-Playfield Support	0	530-5265-00	30	Spacer 2 5/8" Hex Tapped 6-32	0	254-5008-08
10	Spacer Backbox Hinge	2	530-5099-00	31	Spacer 1 1/2" Hex Tapped 6-32	1	254-5008-09
11	Stand-Off Double Groove 1-1/16"	0	530-5102-01	32	Spacer 1 1/4" Hex Tapped 6-32	0	254-5008-11
12	Plastic Post (Black)	49	550-5059-00	33	Spacer 2 1/2" Hex Tapped 6-32	1	254-5008-16
13	Small Jewel Post (Clear)	3	550-5034-01	34	Spacer 1 7/8" Hex Tapped 6-32	0	254-5008-20
14	Spacer 1/2" Plastic (Black) 3/8"	0	254-5000-01	35	Spacer 4 5/16" Hex Tap. 6-32 Thrd.	0	254-5018-00
15	Spacer 3/4" Plastic Narrow 3/8"	0	254-5000-03	36	Spacer 6 5/16" Hex Tap. 6-32 Thrd.	0	254-5018-01
16	Spacer 1" Plastic 3/8"	0	254-5000-04	37	Spacer 1 1/2" Long X 5/16" X .144 I.D.	3	254-5014-00
17	Spacer 1 1/4" Plastic 3/8"	0	254-5000-05	38	Spacer 3/4" Long X 5/16" X .144 I.D.	0	254-5014-01
18	Spacer 1 3/4" Plastic 3/8"	0	254-5000-06	39	Spacer 1.13" Lg. X 5/16" X .144 I.D.	6	254-5014-02
19	Spacer 1 1/2" Plastic 3/8"	2	254-5000-07	40	Spacer 1/4" Long X 5/16" X .144 I.D.	4	254-5014-03
20	Spacer 1" Lg Metal 5/16" X .144 I.D.	0	254-5001-00	41	Spacer 9/16" Long X 5/16" X .144 I.D.	3	254-5014-04

Items with 0 Qty. are not used in this game. Items 14 -41 are shown "broken" to demonstrate variable sizes.

## PLAYFIELD - LAMPS WITH SOCKETS

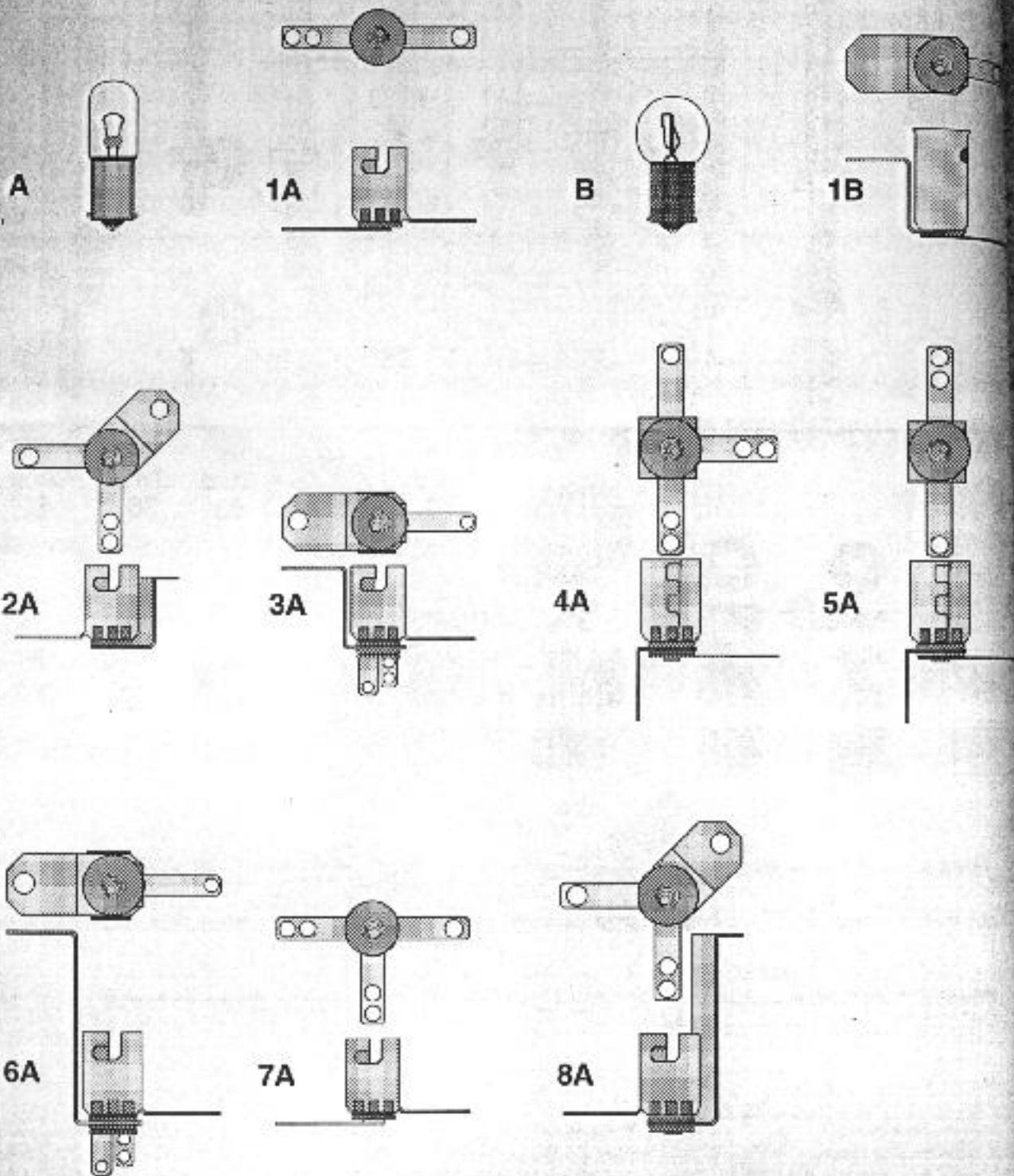

Item	Description	Qty.	Part No.	Item	Description	Qty.	Part No.
A	#44 Bulb	74	165-5000-44	6A	3-Lug Stand-Up Long Socket	9	077-5009-00
1A	2-Lug Staple Down Socket	65	077-5000-00	7A	3-Lug Staple Down Socket	0	077-5001-00
2A	2-Lug Stand-Up Short Socket	0	077-5002-00	8A	2-Lug Stand-Up Long Socket	0	077-5005-00
3A	3-Lug Stand-Up Short Socket	0	077-5008-00	B	#455 Twinkle Bulb	0	165-5000-89
4A	3-Lug Laydown Socket	0	077-5006-00	1B	1-Lug Stand-Up Long Socket	0	077-5012-00
5A	2-Lug Laydown Socket	0	077-5003-00				

1 Bulb per socket. Also note, Item B bulb normally goes with 1B but can be used in any #A Socket.



# PLAYFIELD - LAMPS WITH SOCKETS †

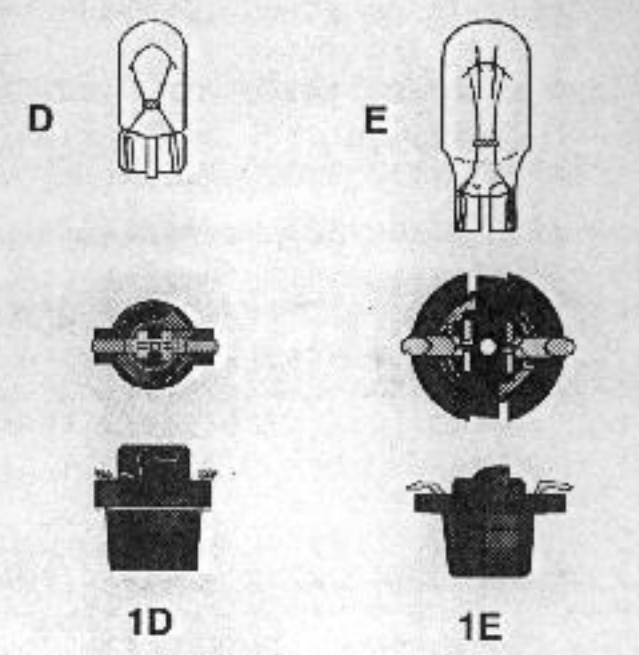
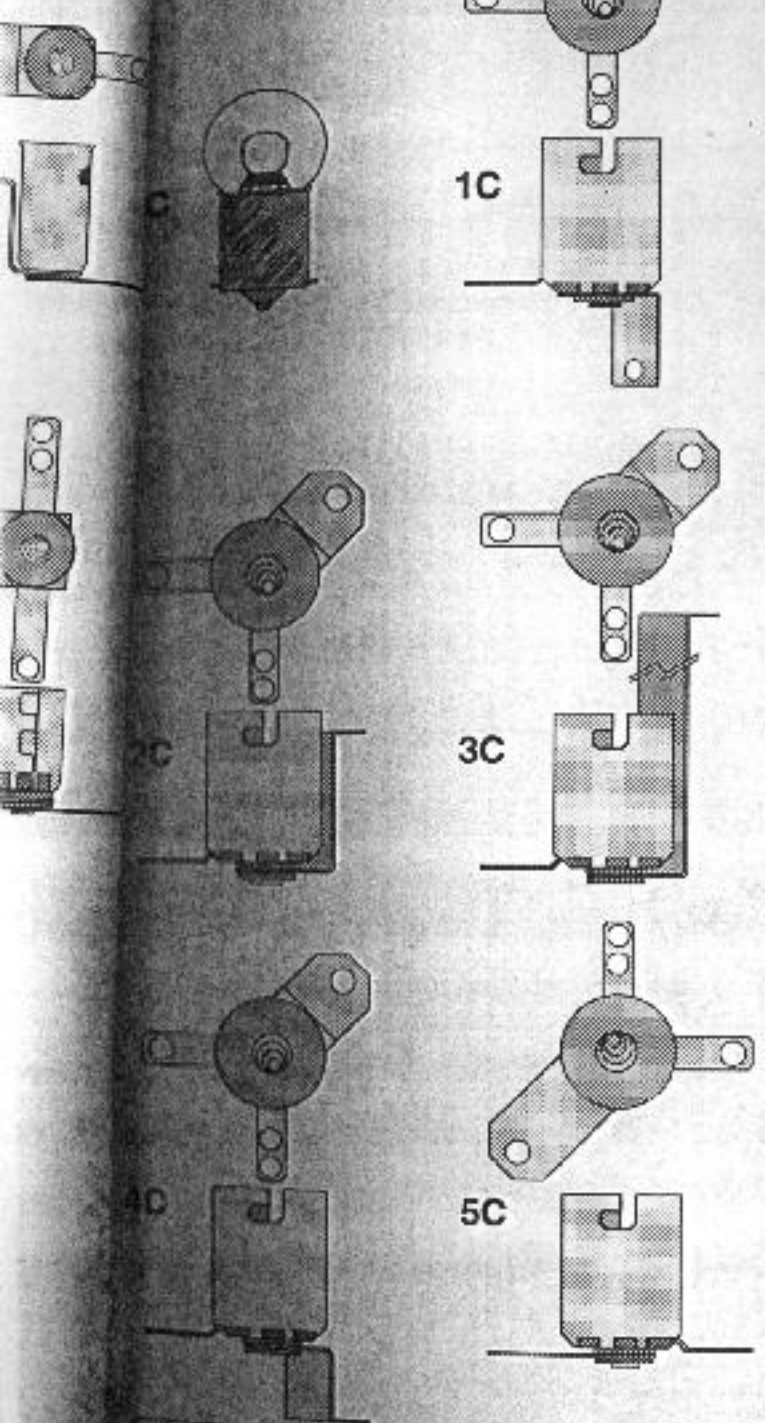

\*\* This socket normally used only on Lamp Bds.

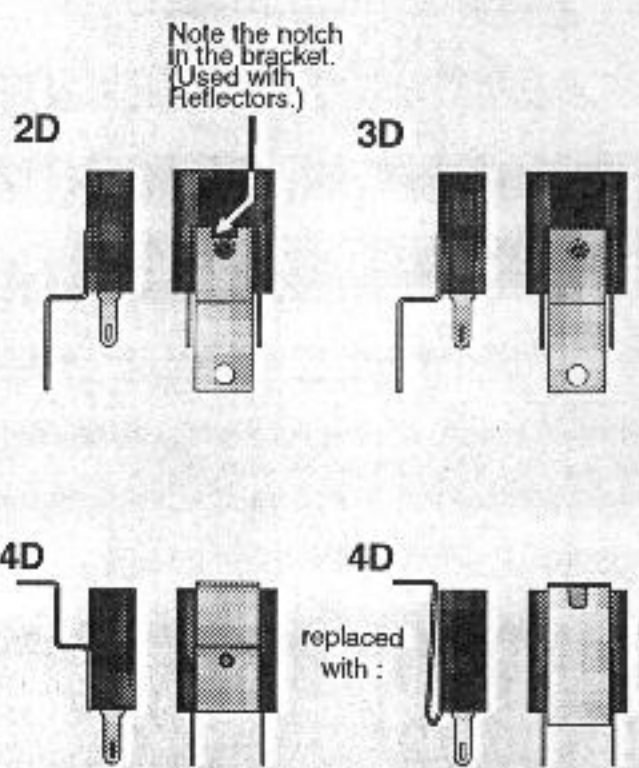

Item	Description	Qty.	Part No.
C	#36 Bulb	28	165-5000-89
1C	Laydown Standard Socket	1	077-5100-00
2C	Stand-Up, Short Socket	24	077-5101-00
3C	Stand-Up, Long Socket	4	077-5102-00
4C	Stand-Up, Socket Rev. Short	0	077-5103-00
5C	Straight Leg Socket	0	077-5107-00

Item	Description (1 bulb per socket)	Qty.	Part No.
D	#555 Wedge Base Bulb *	40	165-5002-00
1D	555 Wedge Base Socket **	28	077-5007-00
2D	Laydown Wedge Base L/R BLK	8	077-5026-01
3D	Laydown Wedge Base Black	0	077-5026-00
4D	Wedge Offset Bracket Socket 2-Styles	0	077-5029-00
E	#906 Wedge Base Bulb	4	165-5004-00
1E	906 Wedge Base Socket	0	077-5016-00

Note: - 4 extra #555 Bulb located 1 per Pop Bumper.  
 Note: - #906 Bulbs used horizontal on the Lamp Boards (see next pg.)

† Items with a Zero Qty. not used in this game.



# PLAYFIELD - LAMP BOARDS

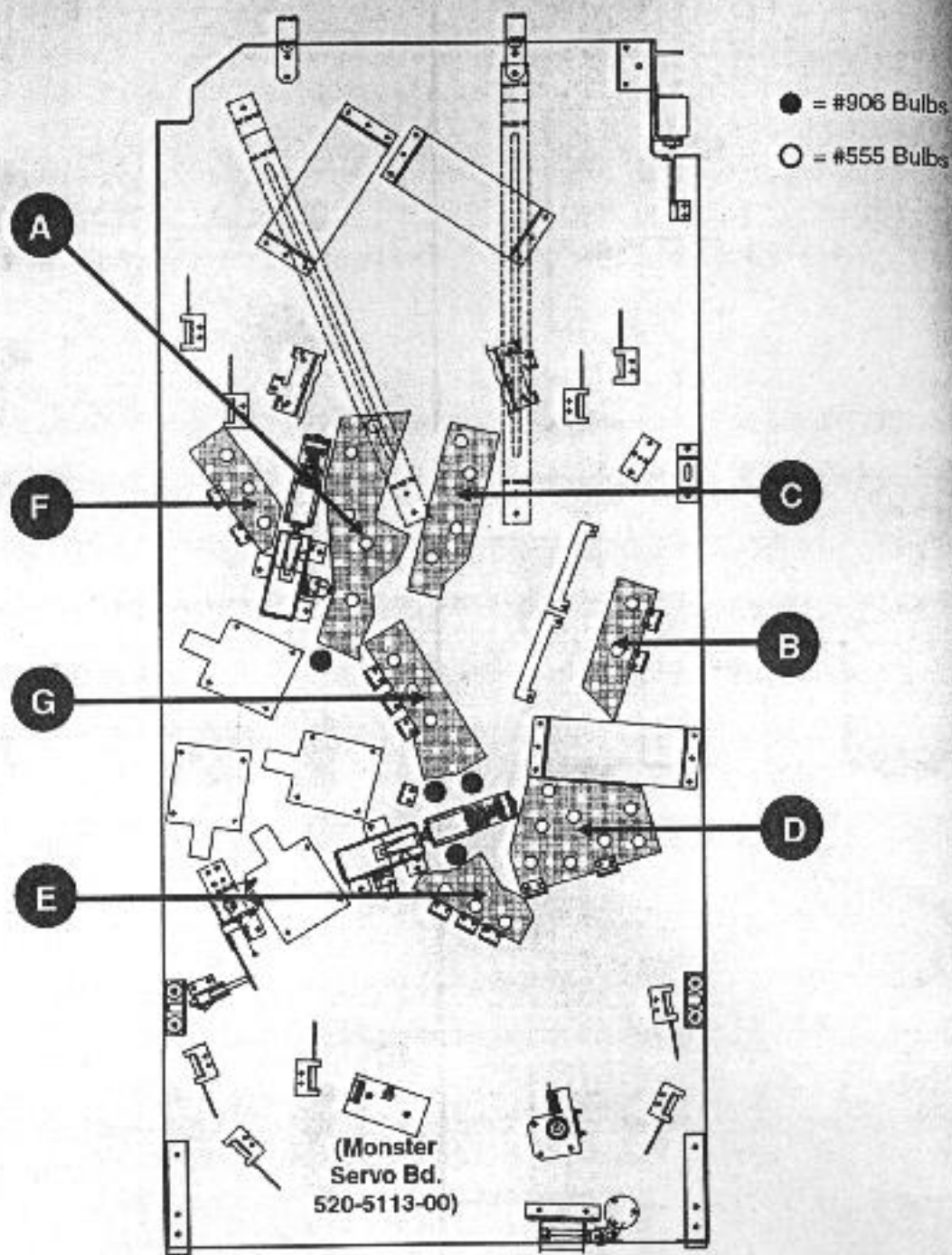

UNDER PLAYFIELD: BOTTOM VIEW

Item	Lamp Board P.N.	Item	Lamp Board P.N.	Item	Lamp Board P.N.	Item	Lamp Board P.N.
A	520-5112-01	C	520-5112-03	E	520-5112-05	G	520-5112-07
B	520-5112-02	D	520-5112-04	F	520-5112-06		

# UNIQUE PARTS IDENTIFICATION (BLUE SECTION) Page Guide

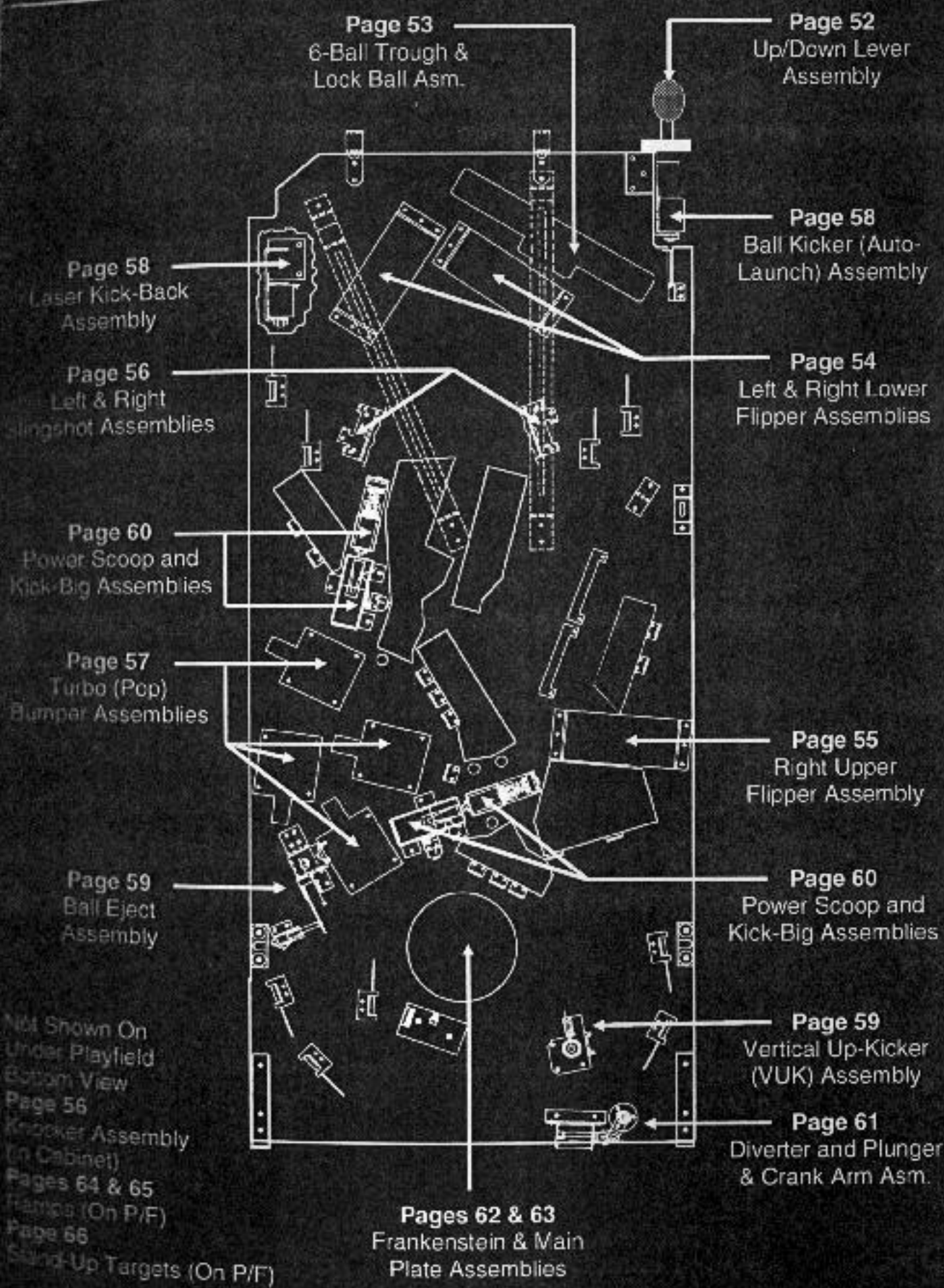

06 Bulbs

05 Bulbs

ard P.F.  
12-07



# Up / Down Lever Assembly 500-5918-00

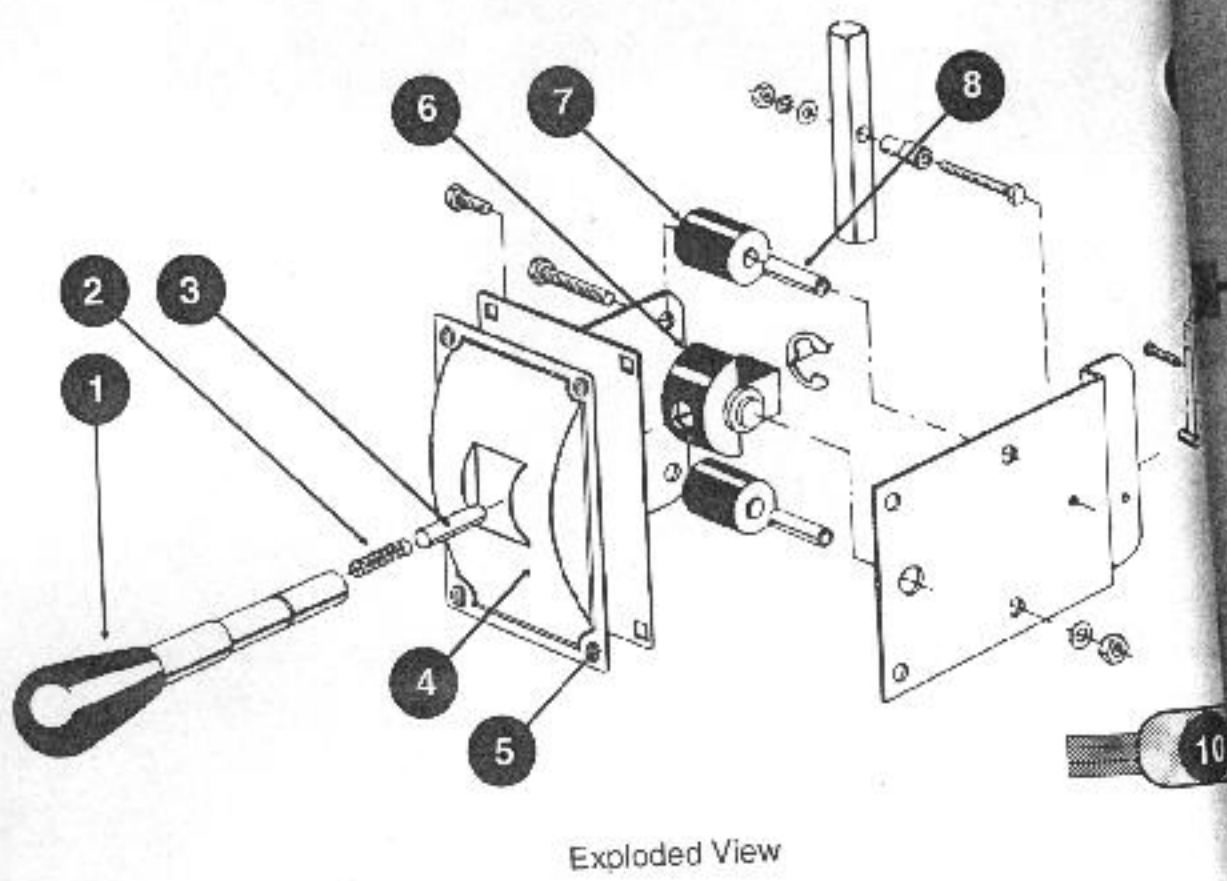
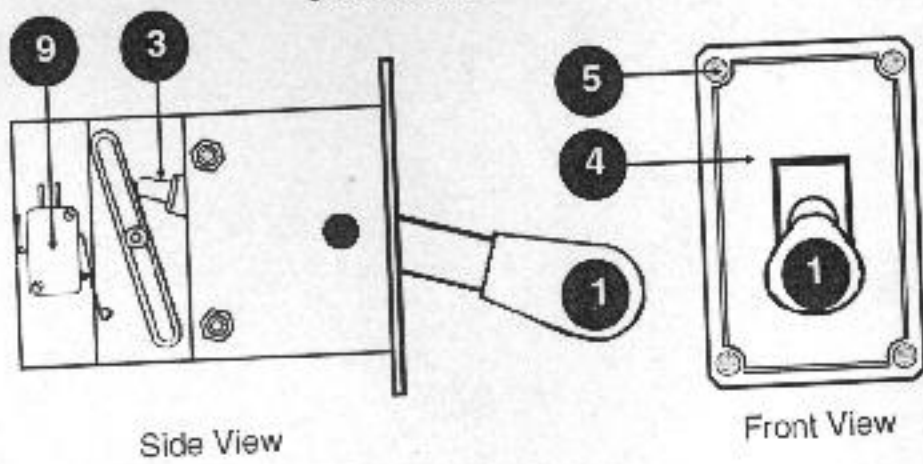

Item	Description	Part No.	Item	Description	Part No.
1	Standard Wooden Handle	515-6202-00	6	Mushroom Cam	545-5314-00
2	Spring	265-5039-00	7	Rubber Bushing (Qty. 2)	545-5239-00
3	Nylon Actuator Arm (Lever)	530-5152-00	8	Spacer (Qty. 2)	254-5016-00
4	Face Plate "Rounded Cover"	545-5593-00	9	Micro-Switch	180-5111-00
5	10-24 X 1 1/4 Carriage Bolt (Qty. 4)	231-5012-00	10	Wiring Harness	036-5350-00
	#10 Flat Washer	242-5003-00	Not a part of the above assembly (not shown):		
	#10 Lock Washer	246-5002-00	11	Installation Wrench	535-6410-00
	10-24 Hex Nut	240-5202-00			



Lock Ball Asm.  
500-5684-01

# 6-Ball Trough Assembly 500-5683-03

Deflector  
535-6606-01

Shown Smaller

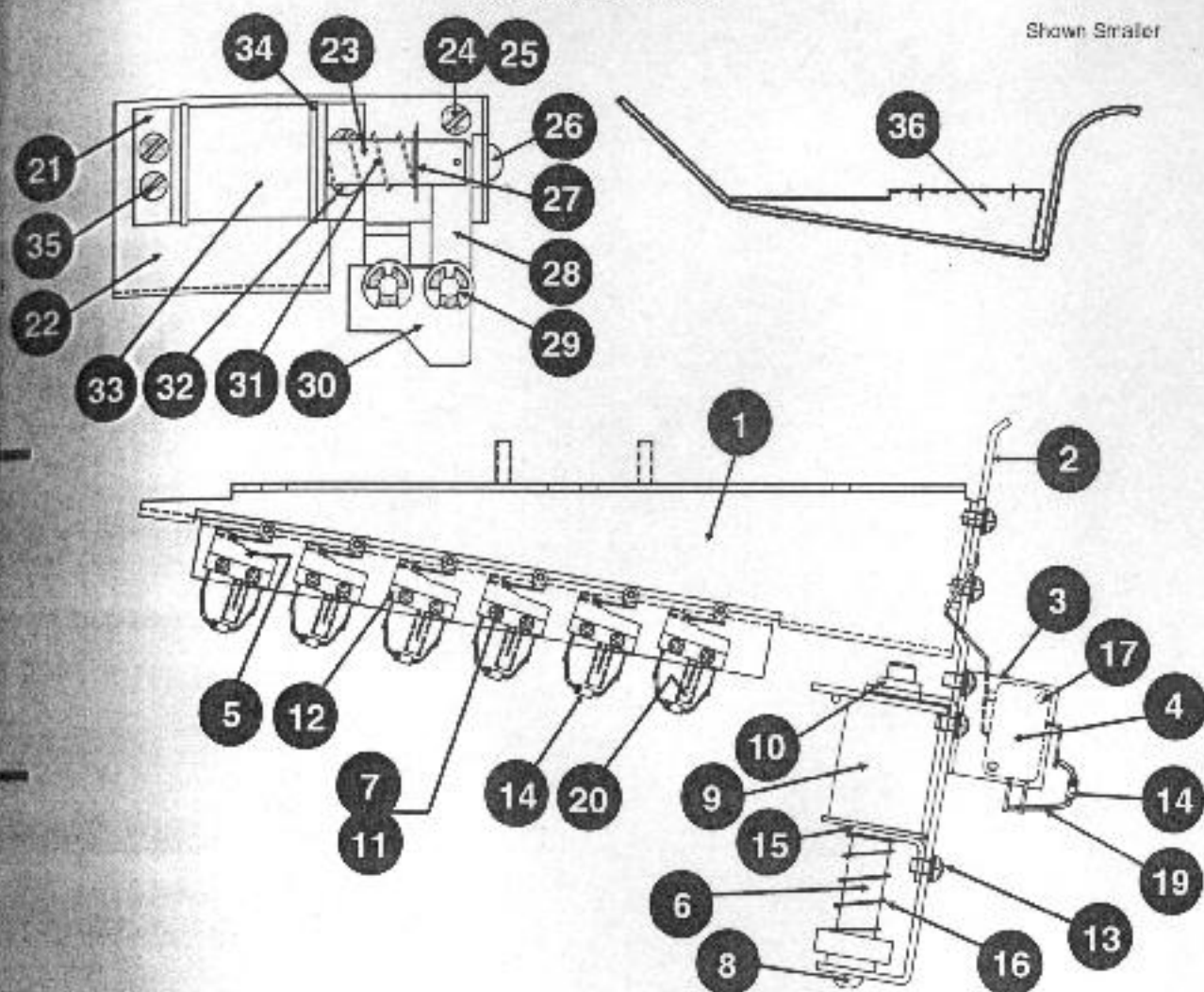

Item	Description	Part No.	Item	Description	Part No.
1	Outhole Mounting Bracket	535-8621-01	20	Insulating Tubing .17 FT.	605-5006-00
2	Coil Mounting Bracket	535-8622-01	21	Core Stop Assembly	515-5088-00
3	Switch Mounting Bracket	535-8623-00	22	Lock Ball Bracket Assembly	515-5817-01
4	Switch, Miniature	180-5118-00	23	Plunger $\phi 7/16 \times 2 \frac{1}{4}$ LG	530-5250-01
5	Switch, Subminiature (Qty. 6)	180-5119-00	24	Spacer	545-5400-00
6	Plunger Assembly	515-5000-02	25	#8-32 PPH X 1" LG	232-1104-16
7	#2-56 PPH X .5 LG (Qty. 8)	237-5806-00	26	Rubber Bumper	545-5105-00
8	Rubber Bumper	545-5105-00	27	E-Ring $\phi .44$ Shaft	270-5005-00
9	Coil, 23-800, incl. Coil Sleeve	090-5001-01	28	Link, Lock Ball	535-6649-00
10	Coil Sleeve	545-5076-00	29	E-Ring, .25 Shaft (Qty. 2)	250-0008-00
11	#2 Split LW (Qty. 8)	244-5001-00	30	Lock Ball Cam Assembly	515-5815-01
12	Switch Protector (Qty. 6)	535-8539-00	31	Spring	266-5000-00
13	#8-32 PPH/SEM X .25 LG (Qty. 8)	232-5300-00	32	Coil Retaining Bracket	535-6658-00
14	1N4001 Diode (Qty. 5)	112-5001-00	33	Coil, 25-1240, incl. Coil Sleeve	090-5034-00
15	Coil Retaining Bracket	535-5203-01	34	Coil Sleeve	545-5411-00
16	Spring	266-5020-00	35	#6-32 HWH TC X .36 LG (Qty. 4)	237-5898-00
17	#4-40 PPH X .62 LG (Qty. 2)	237-5832-00	36	Ball Deflector (Trough Entry Scope)	535-6606-01
18	Cable Asm. (Not Shown)	036-5301-04	37	Wiring Harness (Lock Ball)	036-5301-01
19	Insulating Tubing .08 FT.	605-5003-00	38	Wiring Harness (6-Ball Trough)	036-5301-00

## Flipper Assemblies, Lower 500-5832-01 (Right), 500-5832-02 (Left)

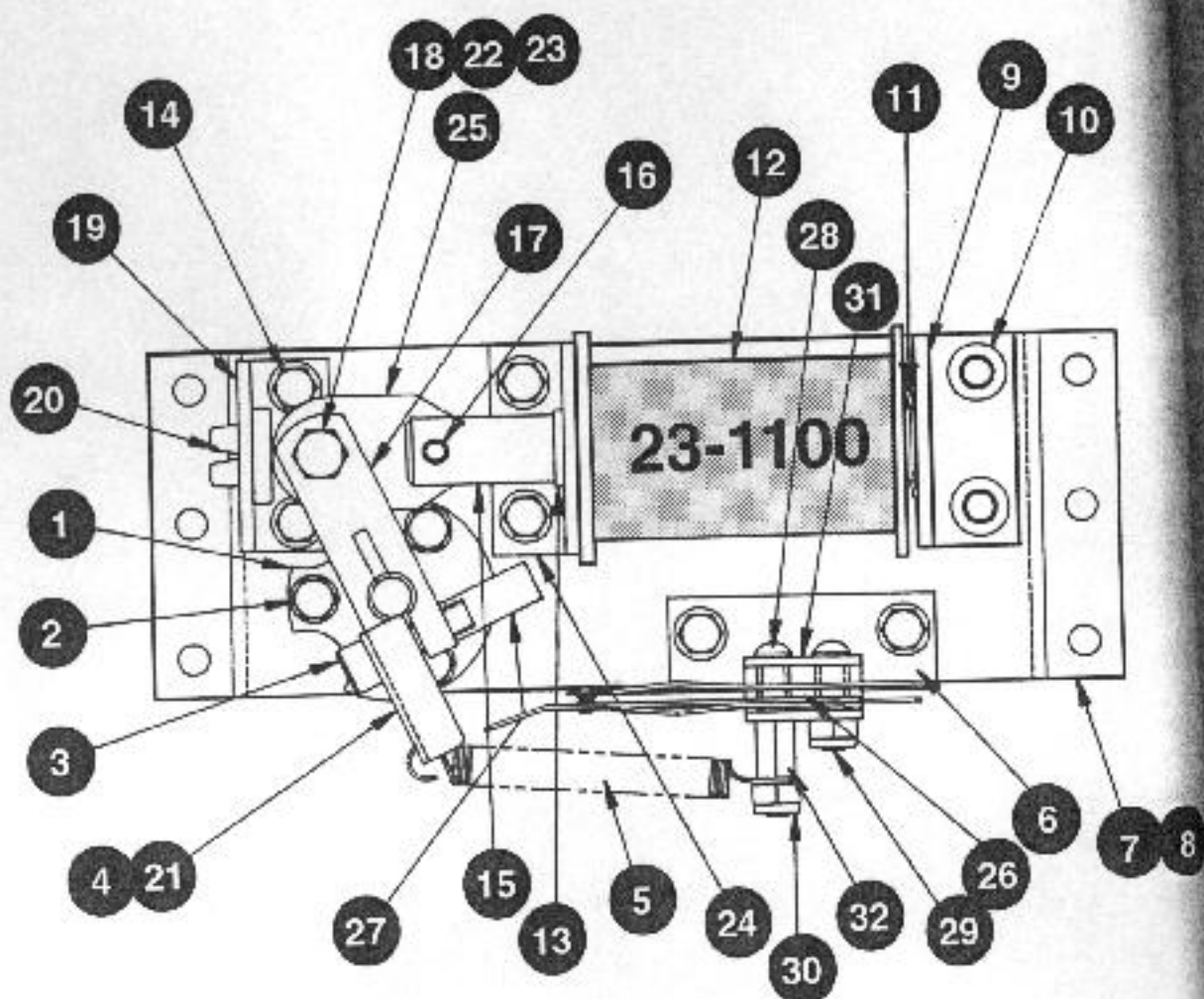

Item	Description	Part No.	Item	Description	Part No.
1	Flipper Bushing	545-5070-00	17	Pawl	530-5070-00
2	#6-32 X .36 LG HWH (Qty. 3)	237-5910-00	18	#10-32 X .75 LG Shoulder Bolt	231-5019-00
3	#10-32 SOC HD X .75 LG	237-5864-00	19	Plunger Stop Bracket	535-5279-00
4	Spring Bracket (Left)	535-6663-02	20	Nylon Stop	545-5445-00
5	Flipper Return Spring	265-5029-02	21	Spring Bracket (Right)	535-6663-01
6	Switch Mounting Bracket	535-6664-00	22	Bushing	530-5139-00
7	Flipper Base (Left)	515-5077-02	23	#10-32 Elastic Stop Nut	240-5203-00
8	Flipper Base (Right)	515-5077-01	24	Front Bracket	535-6453-00
9	Coil Stop Bracket	515-5346-00	25	Flipper Link	545-5401-00
10	1/4-20 SOC HD X .36 LG (Qty. 2)	237-5861-00	26	Power Switch	180-5124-00
11	Spring Washer	269-5002-00	27	Plastic Cap	545-5084-00
12	Coil 23-1100, incl. Coil Sleeve	090-5030-00	28	#6-32 X 1" LG PPH	237-5506-00
13	Coil Sleeve	545-5388-00	29	#6-32 X .63 LG PPH	237-5899-00
14	#8-32 X .36 LG HWH (Qty. 8)	237-5903-00	30	#8-32 Elastic Stop Nut	240-5005-00
15	Plunger and Link Assembly	515-5822-00	31	Switch Plate	535-5045-00
16	Roll Pin	251-5000-00	32	1/4 Hex Spacer (3/8" Long)	254-5008-00

## Flipper Assembly, Upper 500-5694-01 (Right)

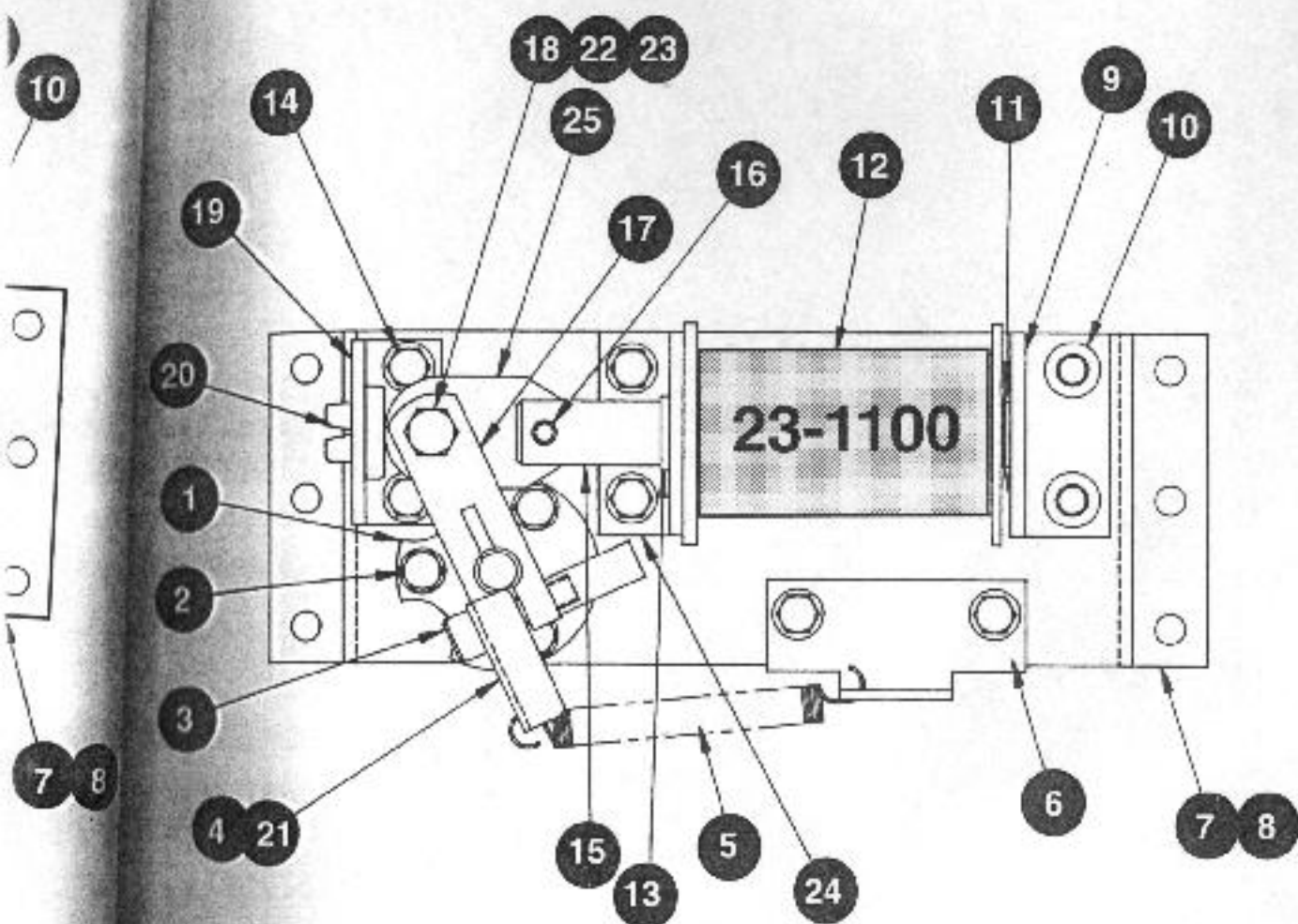

### Part No.

30-5070-00  
31-5019-00  
35-5279-00  
45-5445-00  
55-6663-00  
60-5139-00  
70-5203-00  
85-6453-00  
95-5401-00  
100-5124-00  
110-5084-00  
120-5506-00  
130-5899-00  
140-5005-00  
150-5045-00  
160-5008-00

Item	Description	Part No.	Item	Description	Part No.
1	Flipper Bushing	545-5070-00			
2	#6-32 X .38 LG HWH (Qty. 3)	234-5000-00	14	#8-32 X .38 LG HWH (Qty. 8)	234-5100-00
3	#10-32 SOC HD X .75 LG	237-5864-00	15	Plunger and Link Assembly	515-5822-00
4	Spring Bracket (Left)	535-6663-02	16	Roll Pin	251-5000-00
5	Flipper Return Spring	265-5029-02	17	Pawl	530-5070-00
6	Switch Mounting Bracket	535-6664-00	18	#10-32 X .75 LG Shoulder Bolt	231-5019-00
7	Flipper Base (Left)	515-5077-02	19	Plunger Stop Bracket	535-5279-01
8	Flipper Base (Right)	515-5077-01	20	Nylon Stop	545-5445-00
9	Coil Stop Bracket	515-5346-00	21	Spring Bracket (Right)	535-6663-01
10	1/2-20 SOC HD X .38 LG (Qty. 2)	237-5861-00	22	Bushing	530-5139-00
11	Spring Washer	269-5002-00	23	#10-32 Elastic Stop Nut	240-5208-00
12	Coil 23-1100, incl. Coil Sleeve	090-5030-00	24	Front Bracket	535-6453-00
13	Coil Sleeve	545-5388-00	25	Flipper Link	545-5401-00



## Slingshot (Strong-Leg Bull) Assemblies 500-5849-00

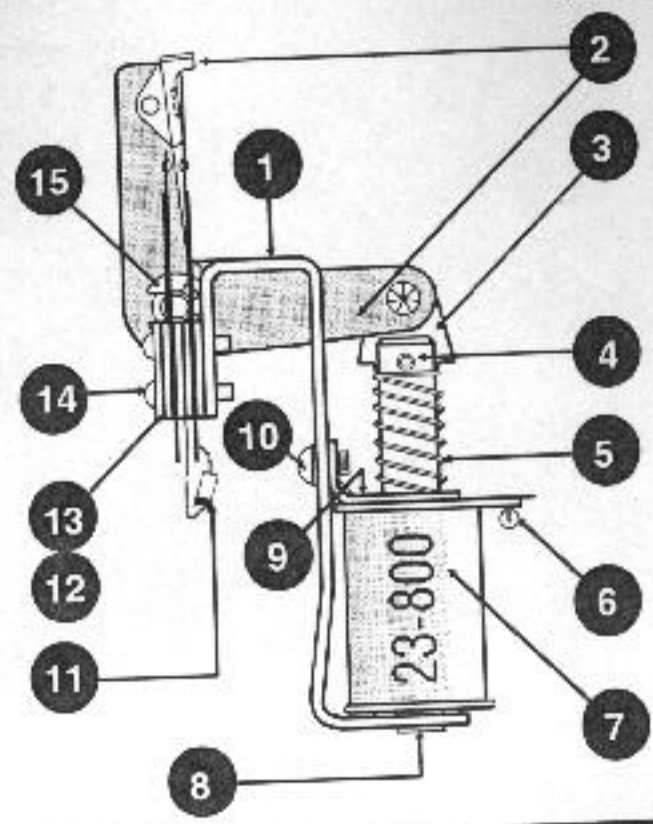

Item	Description	Part No.
1	Slingshot Bracket Assembly	515-5300-00
2	Arm & Tip Assembly	515-5300-00
3	Link	545-5076-00
4	Plunger & Link Assembly	515-5300-00
5	Comp. Spring	266-5020-00
6	Diode 1N4004	112-5003-00
7	Coil 23-800, incl. Coil Sleeve	090-5001-01
8	Coil Sleeve	545-5076-00
9	Coil Retaining Bracket	535-5203-00
10	#8-32 X 1/4" Screw (Qty. 2)	232-5300-00
11	Diode 1N4001	112-5000-00
12	Slingshot Switch (Qty. 2)	180-5050-00
13	Tension Switch Plate (Qty. 2)	535-5840-00
14	#4-40 X 1/2" Screw (Qty. 4)	237-5830-00
15	1/4" Retaining Ring (Qty. 2)	270-5000-00

## Knocker Assembly 500-5081-00

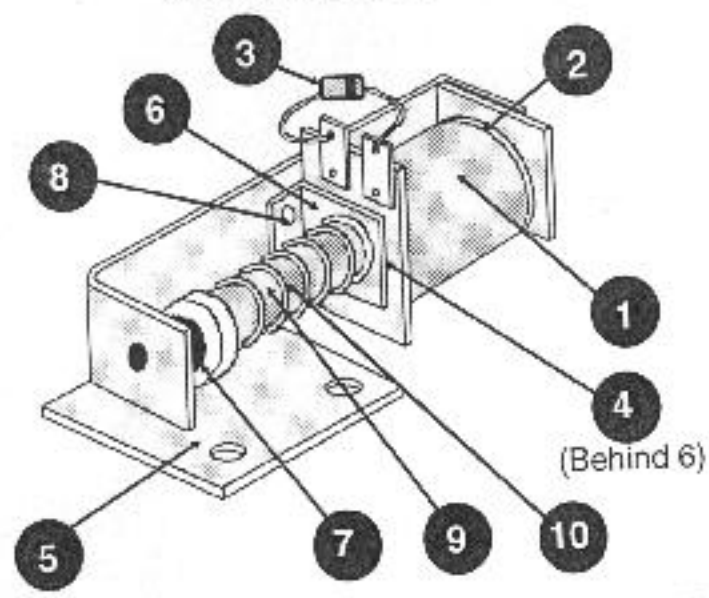

Item	Description	Part No.	Item	Description	Part No.
1	Coil 23-800, incl. Coil Sleeve	090-5001-01	6	Coil Retainer Bracket	535-5203-00
2	Coil Sleeve	545-5076-00	7	Bumper Pad	545-5105-00
3	Diode 1N4004	112-5003-00	8	#8-32 X 1/4" PH PAN SEMG (Qty. 2)	232-5300-00
4	Crescent Spring Washer	269-5002-00	9	Plunger Assembly	515-5000-00
5	Kickback/Knocker Bracket	535-5265-00	10	Spring	266-5020-00

## Turbo Bumper Assemblies 500-5227-02†

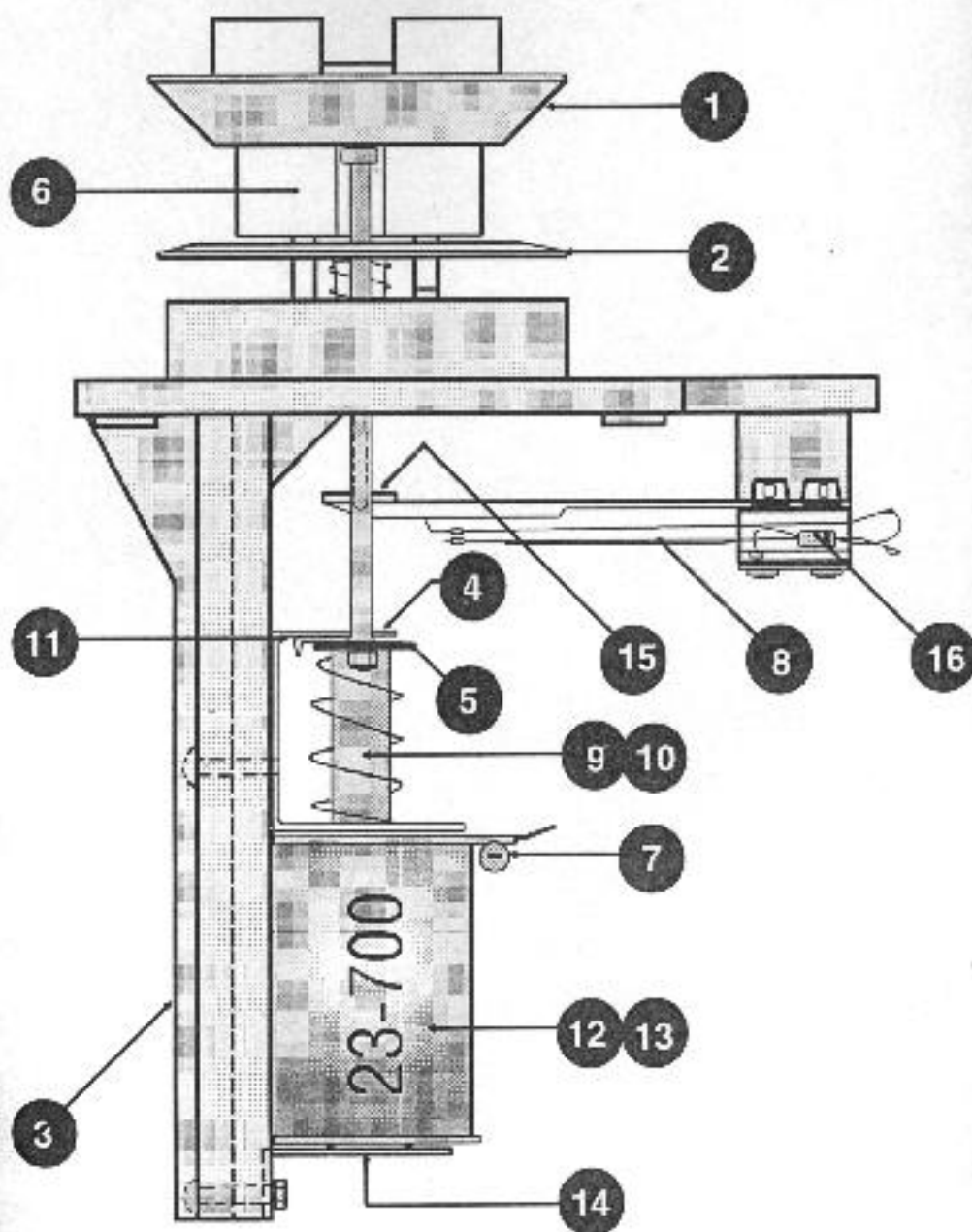

Item	Description	Part No.	Item	Description	Part No.
1	Rod & Ring Assembly	515-5085-00	9	Plunger	530-5062-00
2	Bumper Skirt	545-5098-00	10	Spring	266-5009-00
3	Bumper Housing	545-5100-00	11	Metal Yoke	535-5877-00
4	Plunger Bracket	535-5277-00	12	Coil 23-700 incl. Coil Sleeve	090-5022-02
5	Fiber Yoke	545-5120-00	13	Coil Sleeve	545-5031-00
6	Bumper Body	545-5197-00	14	Coil Stop Assembly	515-5088-00
7	Diode 1N4004	112-5003-00	15	Spoon Switch	545-5542-00
8	Switch	180-5015-01	16	Diode 1N4001	112-5001-00
† Bumper Cover(s) (not shown) not included with above assembly, it must be ordered separately.					
Note:	Bumper Cover	550-5057-XX	Replace -XX w/ color desired (This game colors are BOLD)		
Clear -01, Red -02, Amber -03, Green -04, Blue -05, Yellow -06, Orange -07, White -08, Purple -09.					

## Ball Kicker (Auto Launch) Assembly 500-5477-01

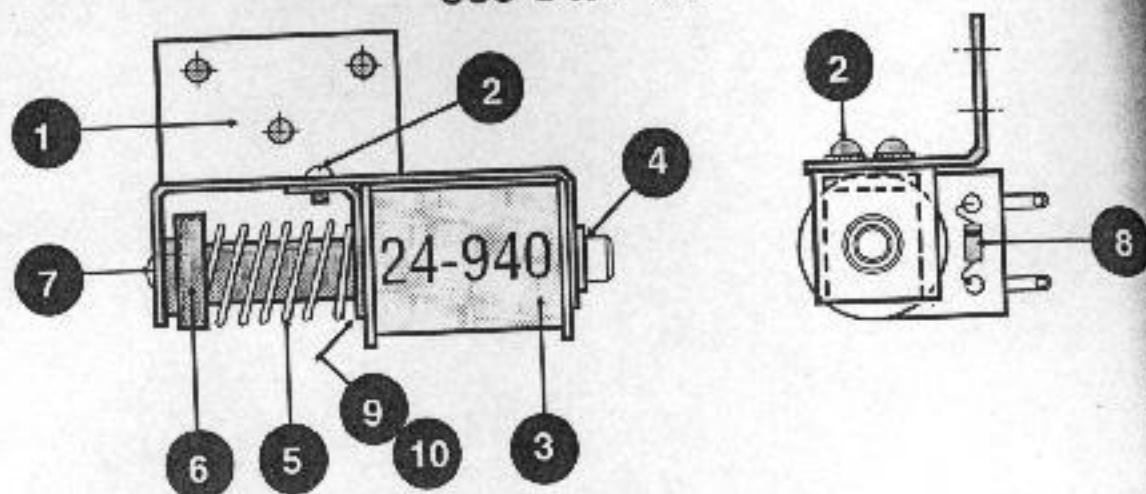

Item	Description	Part No.	Item	Description	Part No.
1	Coil Mounting Bracket	535-6385-00	6	Plunger Assembly	515-5000-00
2	8-32 X 1/4 SEMS (Qty. 2)	232-5300-04	7	Grommet (Bumper Pad)	545-5105-00
3	Coil 24-940, incl. Coil Sleeve	090-5036-01	8	Diode 1N4004	112-5003-00
4	Coil Sleeve	545-5076-00	9	Coil Retaining Bracket	535-5203-00
5	Spring	266-5020-00	10	Spring Washer	269-5002-00

## Laser Kick Back Assembly 500-5838-00

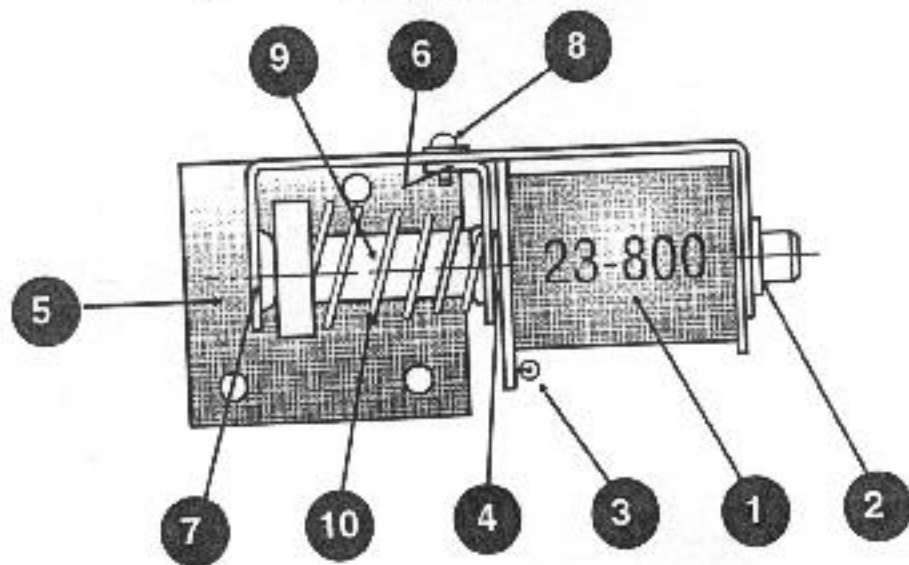

Item	Description	Part No.	Item	Description	Part No.
1	Coil 23-800, incl. Coil Sleeve	090-5001-01	6	Coil Retainer Bracket	535-5203-00
2	Coil Sleeve	545-5076-00	7	Bumper Pad	545-5105-00
3	Diode 1N4004	112-5003-00	8	#8-32 X 1/4" PH PAN SEMS (Qty. 2)	232-5300-00
4	Crescent Spring Washer	269-5002-00	9	Plunger Assembly	515-5000-00
5	Kickback/Knocker Bracket	535-5265-00	10	Spring	266-5020-00



## Vertical Up-Kicker (VUK) Assembly 500-5839-00

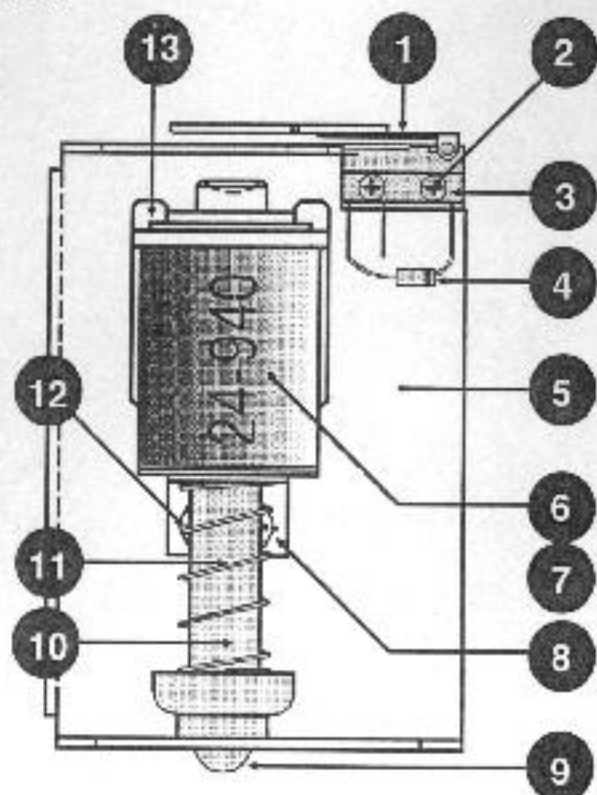

Item	Description	Part No.
1	Switch	180-5116-00
2	Screw (Qty. 2)	237-5806-00
	Washer (Qty. 2)	244-5001-00
3	Protector	535-6539-00
4	Diode 1N4001	112-5001-00
6	Bracket	535-6607-01
6	Coil 24-940, incl. Coil Sleeve	090-5036-01
7	Coil Sleeve	545-5076-00
8	Bracket	535-5203-01
9	Bumper Pad	545-5105-00
10	Spring	266-5020-00
11	Plunger	515-5941-01
12	Screw (Qty. 2)	232-5300-00
13	Insulation	545-5431-00

## Ball Eject Assembly 500-5664-01

Item	Description	Part No.
1	Eject Cam Assembly	515-5042-00
2	Coil 24-940, incl. Coil Sleeve	090-5036-01
3	Coil Sleeve	545-5031-00
4	Diode 1N4004	112-5003-00
5	Coil Retainer Bracket	535-5203-01
6	8-32 1/4 SEMS (Qty. 2)	232-5300-04
7	Plunger Spring	266-5000-00
8	Plunger & Link Assembly	515-5338-00
9	Bracket & Stop Assembly	515-5011-00
10	*E' Ring (Qty. 2)	270-5002-00
11	Fulcrum Bracket	535-6446-01
12	Fulcrum Pin	530-5207-00
13	Shim Washer (Qty. 2) (If Required)	242-5013-00
14	Ext. Spring	265-5017-00
15	Spring Plate Assembly	515-5009-00
16	Insulator	545-5431-00

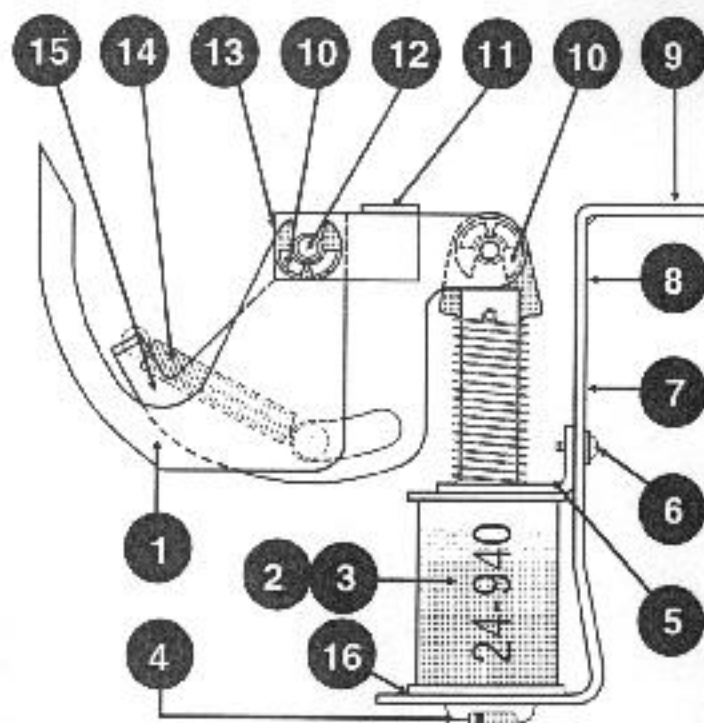

## Power Scoop Assemblies 500-5809-00

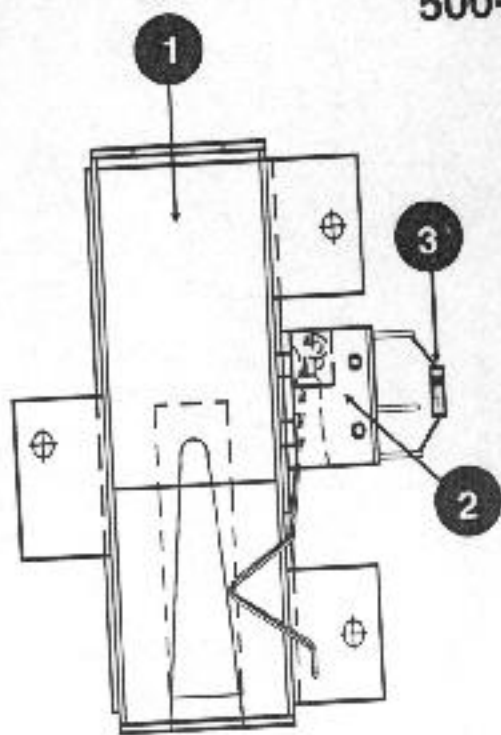

Please Note:  
The Power Scoop & Kick  
Big Assemblies (2 ea.)  
work in conjunction with  
each other but are  
separate assemblies.

Item	Description	Part No.
1	Power Scoop Weld Assembly	515-6022
2	Micro Switch	180-5051
	Switch Protect Plate	535-6530
	#2 Lockwasher (Qty. 2)	244-5001
	2-56 Hex Nut (Qty. 2)	240-5301
	Micro Bracket	535-6153
	2-56 PHMS (Qty. 2)	237-5806
3	6-32 PHMS (Qty. 2)	232-5200
	Diode 1N4004	112-5003

## Kick Big Assemblies 500-5862-00

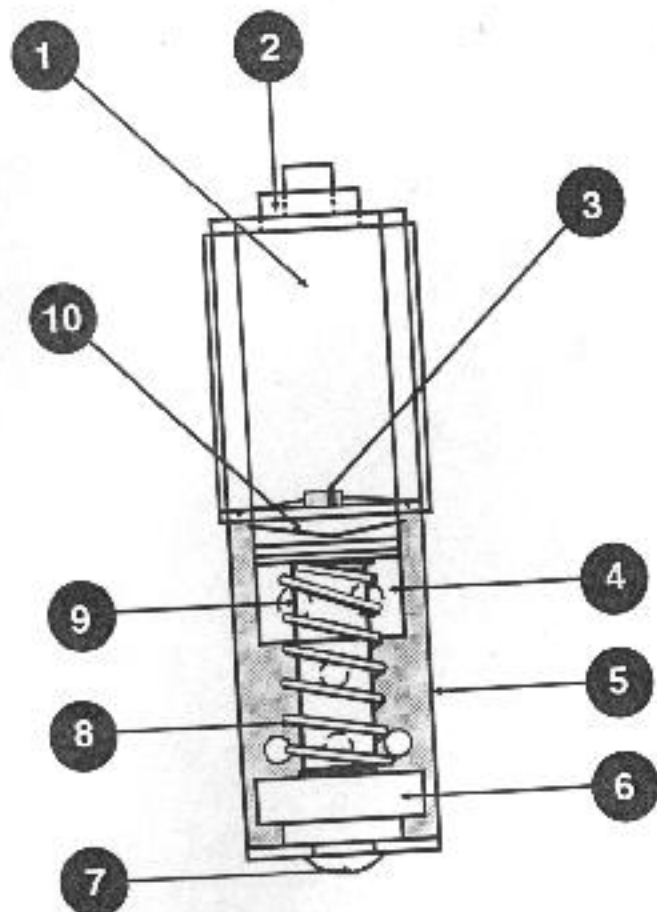

Item	Description	Part No.
1	Coil 23-800, incl. Coil Sleeve	090-5001-0
2	Coil Sleeve	545-5076-0
3	Diode 1N4004	112-5003-0
4	Bracket	535-5203-0
5	Frame	535-6730-0
6	Plunger Assembly	515-5000-0
7	Rubber Grommet	545-5105-0
8	Spring	266-5020-0
9	8-32 X 1/4 SEMS (Qty. 2)	232-5300-0
10	Spring Washer	269-5002-0

Unique Parts

## Diverter Assembly 500-5654-00

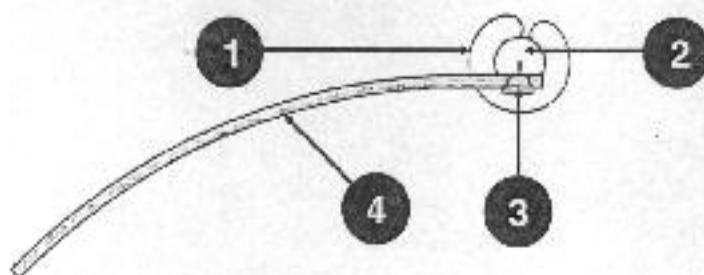

Please Note:

The Diverter Assembly & Diverter Plunger and Crank Arm Assembly work in conjunction with each other but are separate assemblies.

Item	Description	Part No.	Item	Description	Part No.
1	Retaining Ring	250-0008-00	3	6-32 X 3/8 FHMS (Qty. 4)	237-5501-00
2	Shaft	530-5235-00	4	Diverter	535-5126-00

## Diverter Plunger and Crank Arm Assembly 515-5453-00

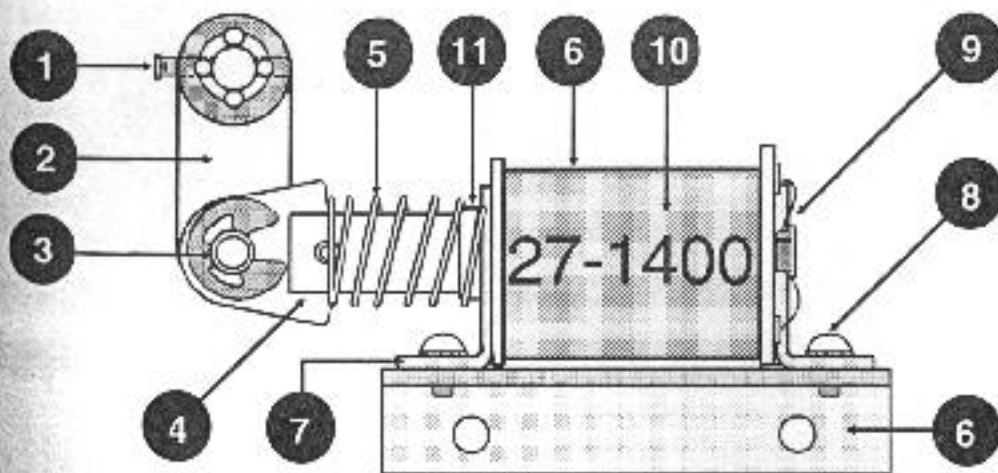

Item	Description	Part No.	Item	Description	Part No.
1	#8-32 3/8 Soc. Hd. Cap Screw	237-5897-00	7	Coil Mounting Bracket	535-6026-00
2	Crank Arm Assembly	515-5396-00	8	#6-32 X 1/4 Screw (Qty. 4)	232-5200-00
3	Retaining Ring $\phi$ 1/4 Shaft	270-5002-00	9	Coil Stop Bracket	515-5088-00
4	Plunger & Link Assembly	515-5338-00	10	Coil 27-1400, incl. Coil Sleeve	090-5015-00
5	Compression Spring	266-5000-00	11	Coil Sleeve	545-5031-00
6	Diverter Coil Assembly	515-5447-01	12	Fiche Paper (Insulator)	545-5431-00

Note: Item 6 includes items 7 thru 11.



# Frankenstein Assembly

## 500-5887-00

Top View Cut-Away showing all components. See next page for breakdowns.

Top View Cut-Away not showing Servo Motor. See next page for breakdowns.

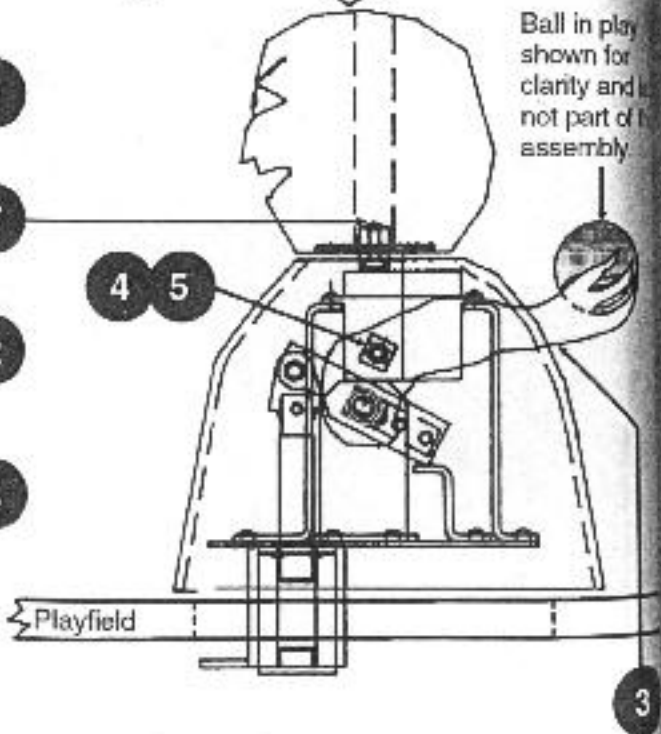
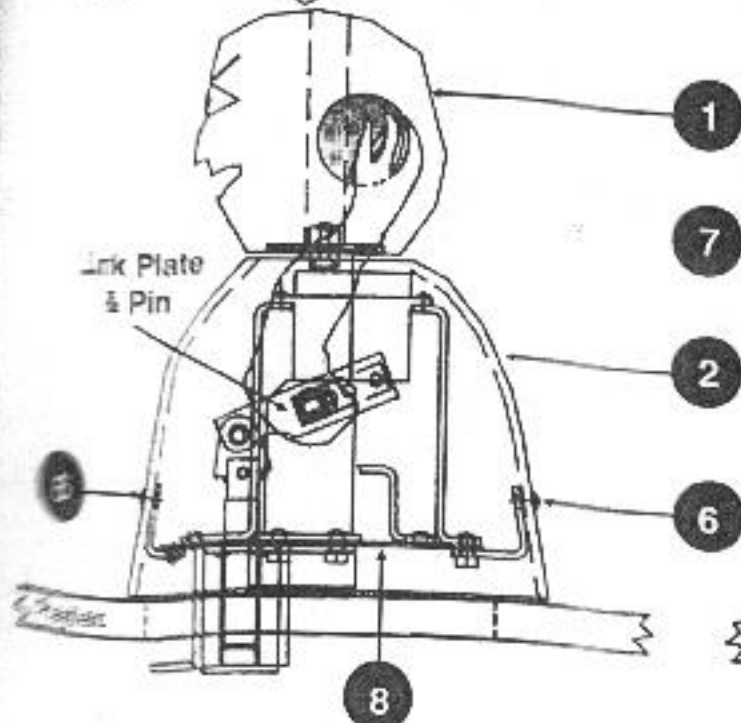
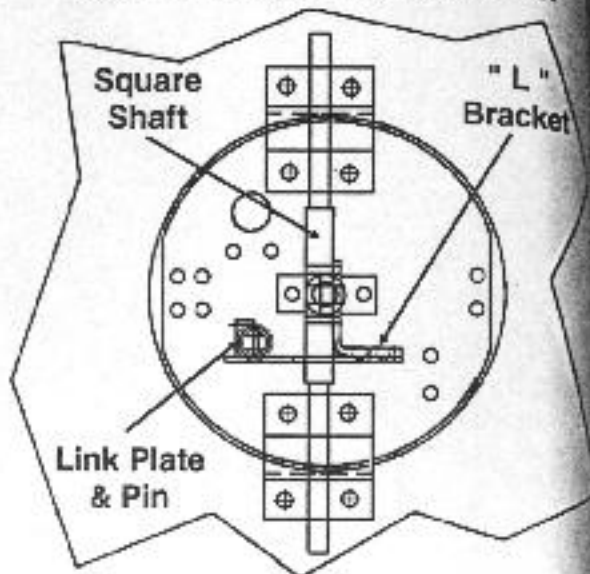
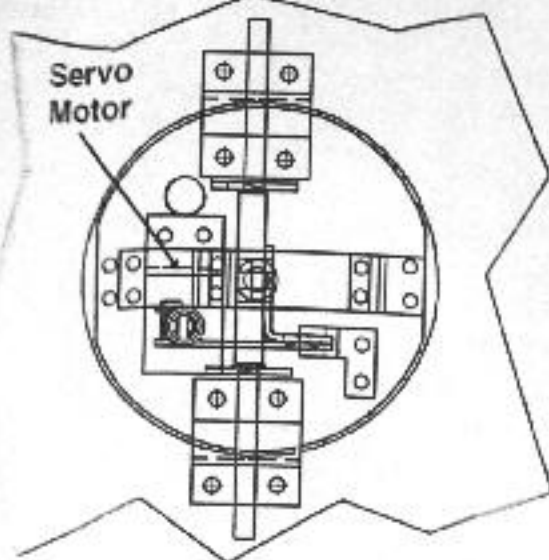

Item	Description	Part No.	Item	Description	Part No.
1	Head Assembly	515-6124-00	5	8-32 Stop Nut (Qty. 2)	240-5102-00
2	Body	515-6547-00	6	8-32 X 5/8 HWH Serated (Qty. 4)	237-5951-00
3	Arm Right (50° Travel)	515-6248-01	7	#4 Sheet Metal Screw	Supplied w/ Servo Motor
4	Arm Left (50° Travel)	515-6248-02	8	Main Plate Assembly (See breakdown of this assembly on the next page)	515-6153-00
5	Square Spacer Right	515-6199-01			
6	Square Spacer Left	515-6199-02			

*Determination of Left / Right is View from Player*

Unique Parts

Item	No Show
1	
2	
3	
4	
5	
6	
7A	
7B	
8	
9	
10	
11	
12	
13	

# Frankenstein Main Plate Assembly 515-6153-00

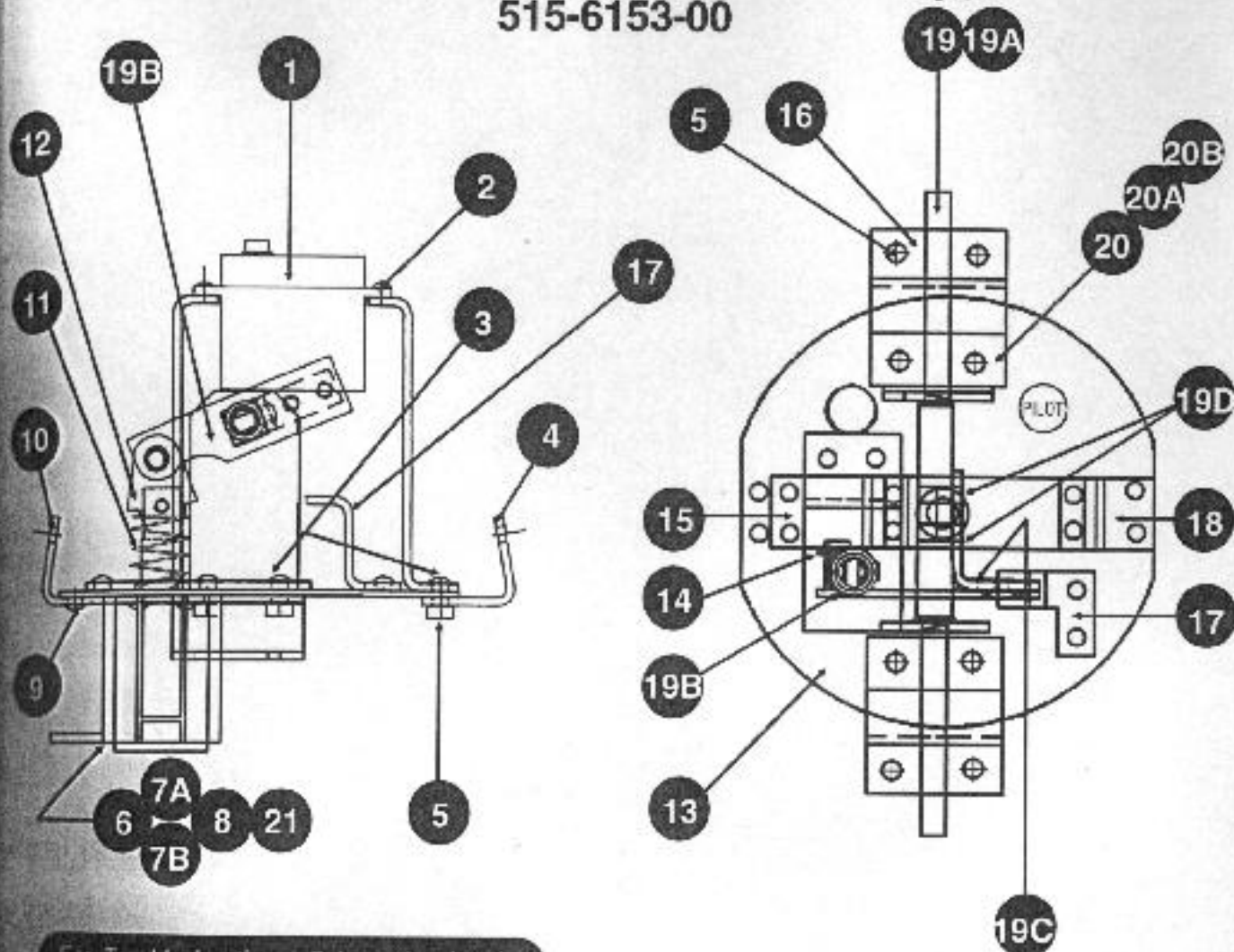

For Troubleshooting / Schematics for the Servo Motor & Board, see the end of the YELLOW SECTION, page 93.

Item	Description	Part No.	Item	Description	Part No.
1	Servo Motor (94102)	041-5032-00	14	Retaining Ring on Pin	270-5002-00
* Not Shown	Servo Motor Monster Head Board* (Not a part of this Asm.)	520-5113-00	15	Mounting Bracket Servo Front	535-7042-01
2	4-40 X 1/2 HWH Serated (Qty. 4)	237-5945-00	16	Mounting Bracket (Qty. 2)	535-7198-00
3	8-32 X 1/2 HWH Serated (Qty. 6)	237-5905-00	17	Stop Bracket	535-6137-00
4	Bracket Body Back	535-7084-00	18	Mounting Bracket Servo Rear	535-7042-00
5	8-32 Stop Nut (Qty. 4)	240-5102-00	19	Square Shaft & Bracket Ass'y.	515-6126-00
6	Coil Bracket Assembly	515-6125-00	19A	Square Shaft	530-5151-00
7A	Coil 24-940, Incl. Coil Sleeve	090-5036-00	19B	Link Plate & Pin Sub-Assembly	515-6132-00
7B	Coil Sleeve	545-5031-00	19C	"L" Bracket	535-6037-00
8	Diode 1N4004	112-5003-00	19D	8-32 X 3/16 Self Tap Serated (Qty. 4) all with Loctite	237-5903-00
9	8-32 X 3/16 HWH Serated (Qty. 6)	237-5903-00	20	Support Bracket Ass'y. (Qty. 2)	515-6133-00
10	Bracket Body Front	535-7083-00	20A	Support Bracket (Qty. 2)	535-6138-00
11	Spring (Qty. 2)	266-5011-00	20B	Nyliner (Not Shown) (Qty. 2)	545-5423-00
12	Plunger Assembly	515-5407-00	* See Lamp Board Diagram, Pg. 50, for location.		
13	Main Plate	535-7044-00	21	Large Fiche Paper (Insulator)	545-5599-00

# Upper Level Plastic Ramp Assembly 500-5905-00

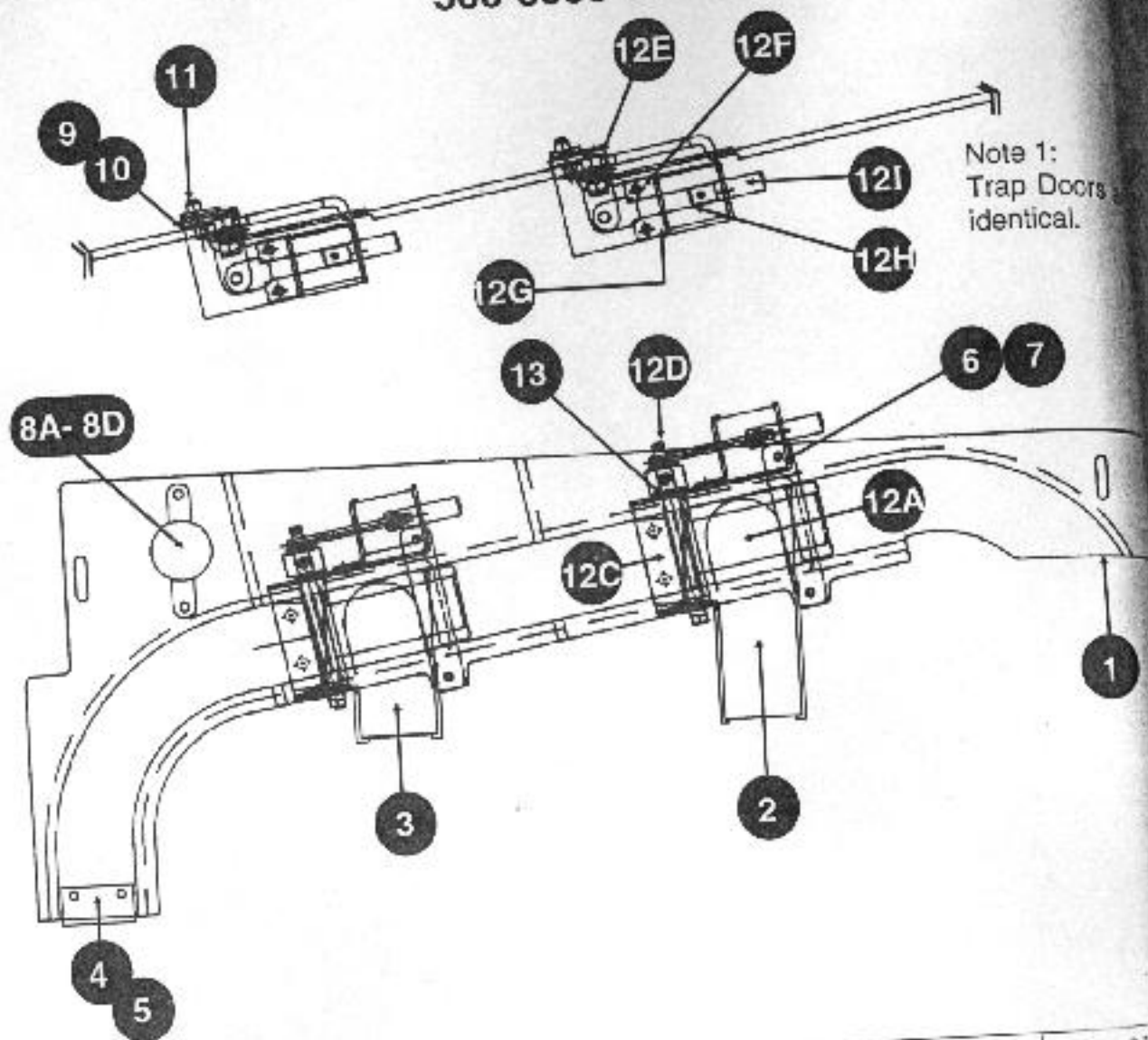

Item	Description	Part No.	Item	Description	Part No.
			12	Trap Door Assembly (Qty. 2)	500-5906-00
1	Plastic Ramp	545-5565-00		Flap & Shaft Assembly	515-6185-00
2	Mini Trough Large	535-7186-01	12A	Shaft (Trap Door Pivot), Flap (Trap Door), & Rivet	See Note 2
3	Mini Trough Small	535-7186-00			
4	Ramp Bracket	535-5291-00	12B	Retaining Ring 1/4 (Qty. 2)	270-5002-00
5	Rivet (Qty. 2)	249-5008-00	12C	Trap Door Coil Bracket	535-7129-00
6	6 x 1/2 Truss Head (Qty. 4)	237-5809-00	12D	Retaining Ring 3/16	270-5001-00
7	Door/Ramp Bracket (Qty. 2)	535-7192-00	12E	Crank Arm Assembly	515-6184-00
8A	Dome	550-5031-02	12F	6-32 x 3/16 HWHMS (Qty. 2)	232-5209-00
8B	Socket & Bulb Asm.	518-5101-00	12G	Coil Bracket	535-6784-00
8C	6-32 Stop Nut (Qty. 2)	240-5005-00		Coil, 28-1050	090-5046-00
8D	6-32 1/2 PHMS SEMS	232-5202-00	12H	Coil Sleeve (Qty. 2)	545-5500-00
9	Nut Plate (Qty. 2)	535-7189-00		Plunger Assembly	515-6057-00
10	6-32 Nylon (Qty. 4)	240-5005-00	12I	Flat Washer (Qty. 2)	242-5023-00
11	6-32 x 1/2 PHMS SEMS (Qty. 4)	237-5504-00	13		

Note 2: Item names are given for reference only and cannot be ordered. For these items, the sub-assembly must be ordered.

Unique Parts



## Lower Level Plastic Ramp Assembly 500-5923-00

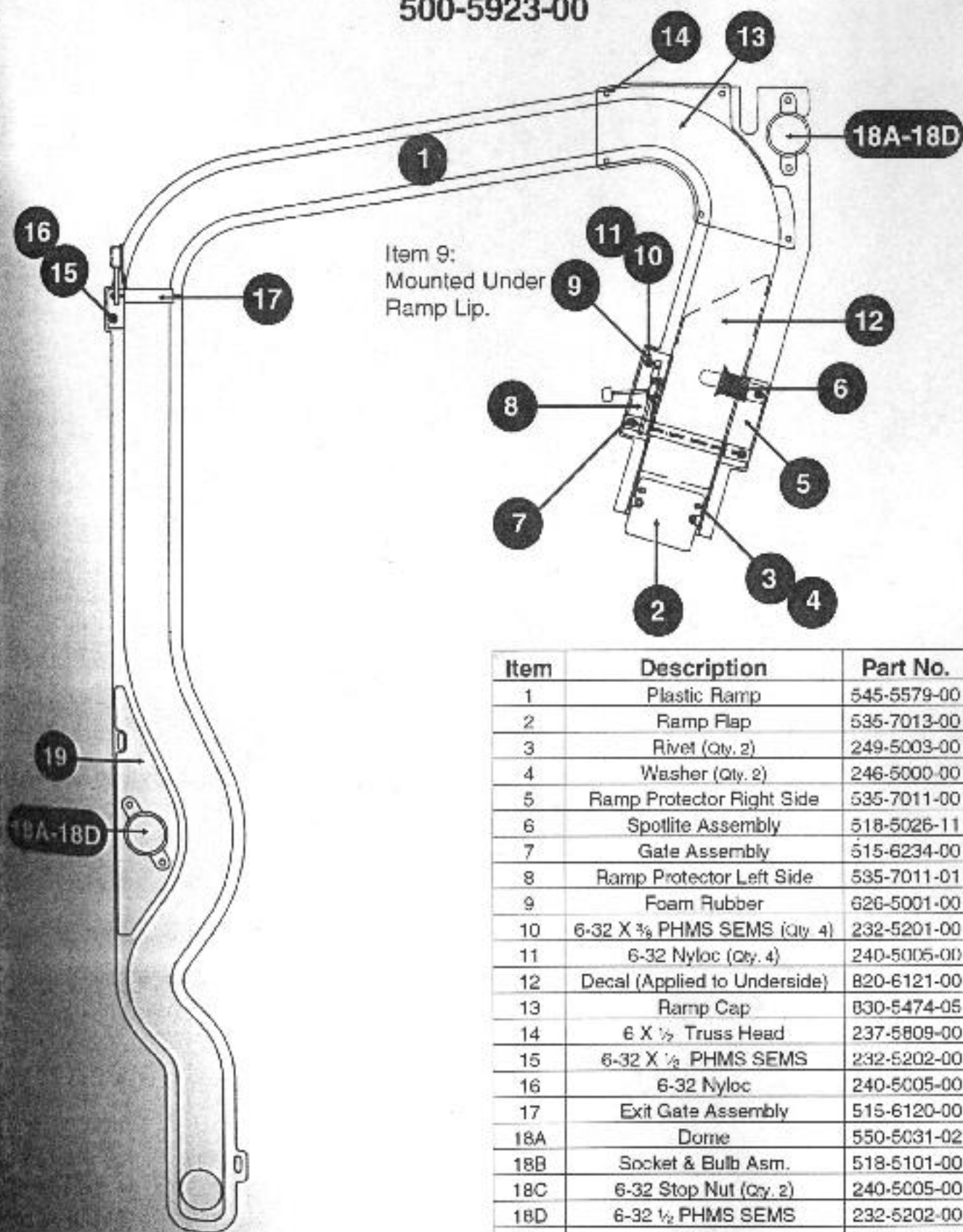

Item	Description	Part No.
1	Plastic Ramp	545-5579-00
2	Ramp Flap	535-7013-00
3	Rivet (Qty. 2)	249-5003-00
4	Washer (Qty. 2)	246-5000-00
5	Ramp Protector Right Side	535-7011-00
6	Spotlite Assembly	518-5026-11
7	Gate Assembly	515-6234-00
8	Ramp Protector Left Side	535-7011-01
9	Foam Rubber	626-5001-00
10	6-32 X 3/8 PHMS SEMS (Qty. 4)	232-5201-00
11	6-32 Nyloc (Qty. 4)	240-5005-00
12	Decal (Applied to Underside)	820-6121-00
13	Ramp Cap	830-5474-05
14	6 X 1/2 Truss Head	237-5809-00
15	6-32 X 1/2 PHMS SEMS	232-5202-00
16	6-32 Nyloc	240-5005-00
17	Exit Gate Assembly	515-6120-00
18A	Dome	550-5031-02
18B	Socket & Bulb Asm.	518-5101-00
18C	6-32 Stop Nut (Qty. 2)	240-5005-00
18D	6-32 1/2 PHMS SEMS	232-5202-00
19	Decal	820-6119-09
20 *	Back Panel Ramp Support Brackets	Right 535-7277-01 Left 535-7276-01

\* Item 20, not shown in this drawing, is attached to the Back Panel and are not part of this assembly.

# Stand-Up Target Assemblies:

500-5321-XX  
Qty.: 5  
1" X 1-1/2" Rect.  
(Front View)

500-5232-XX  
Qty.: 5  
1" Square  
(Front View)

500-5857-XX  
Qty.: 3  
Narrow Rectangle  
(Front View)

All  
(Side View)

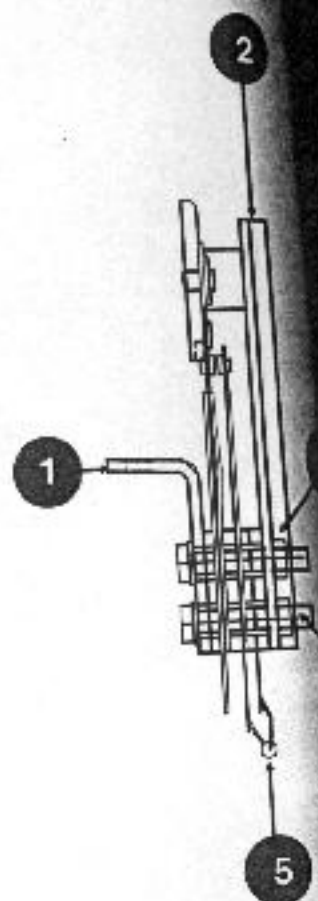
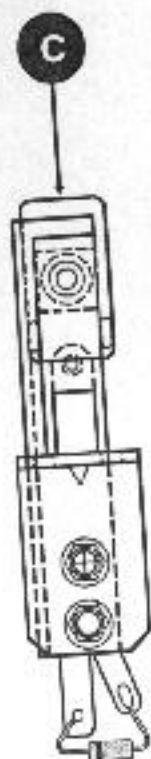
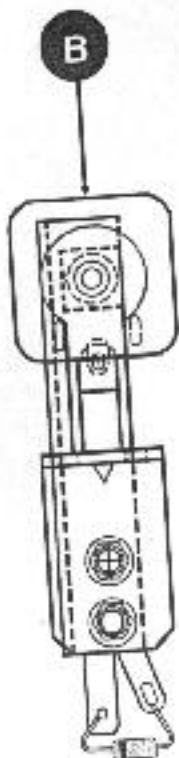
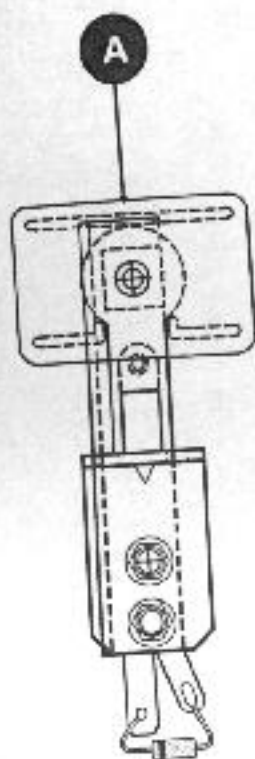

Item	Description	Part No.	Item	Description	Part No.
A	Switch & Target Assembly 1" X 1 1/2" Rectangle (Flat)	515-6027-XX	2	Back Plate (Same for all above targets)	535-5118-00
B	Switch & Target Assembly 1" Square (Flat)	515-5162-XX	3	6-32 Nyloc (Same for all above targets)	240-5010-00
C	Switch & Target Assembly Narrow Rectangle (Flat)	515-5967-XX	4	6-32 X 3/4 HWHMS (Same for all above targets)	237-5893-00
1	Mounting Bracket (Same for all above targets)	535-8896-00	5	Diode 1N4001 (Same for all above targets)	112-5001-00

**Target Color:** The "-XX" should be replaced with the following 2-digit number for the color desired. On this game all white targets are used (-08).

-01:	Clear	-04:	Green	-07:	Orange
-02:	Red	-05:	Blue	-08:	White
-03:	Amber	-06:	Yellow	-09:	Purple

Unique Parts

## **DATA EAST LIMITED WARRANTY**

---

DATA EAST INC., USA ("SELLER") WARRANTS ONLY TO THE INITIAL PURCHASER OF ITS PRODUCTS THAT THE ITEMS LISTED BELOW ARE FREE FROM DEFECTS IN MATERIAL AND WORKMANSHIP UNDER NORMAL USE AND SERVICE FOR THE WARRANTY PERIOD SPECIFIED:

### **PRINTED CIRCUIT BOARDS (GAME LOGIC) 60 DAYS**

---

NO OTHER PARTS OF SELLER'S PRODUCT ARE WARRANTED.

WARRANTY PERIODS ARE EFFECTIVE FROM THE INITIAL DATE OF SHIPMENT FROM SELLER TO ITS AUTHORIZED DISTRIBUTORS.

SELLER'S SOLE LIABILITY SHALL BE, AT ITS OPTION, TO REPAIR OR REPLACE PRODUCTS WHICH ARE RETURNED TO SELLER DURING THE WARRANTY PERIODS SPECIFIED, PROVIDED:

1. SELLER IS NOTIFIED PROMPTLY UPON DISCOVERY BY PURCHASER THAT STATED PRODUCTS ARE DEFECTIVE.
2. SUCH PRODUCTS ARE PROPERLY PACKAGED AND THEN RETURNED FREIGHT PREPAID, TO SELLER'S PLANT.

THIS WARRANTY DOES NOT APPLY TO ANY PARTS DAMAGED DURING SHIPMENT AND/OR DUE TO IMPROPER HANDLING, OR DUE TO IMPROPER INSTALLATION OR USAGE, OR ALTERATION. IN NO EVENT SHALL THE SELLER BE LIABLE FOR ANY ANTICIPATED PROFITS, LOSS OF PROFITS, LOSS OF USE, ACCIDENTAL OR CONSEQUENTIAL DAMAGES OR ANY OTHER LOSSES INCURRED BY THE CUSTOMER IN CONNECTION WITH THE PURCHASE OF A DATA EAST PRODUCT.

### **WARRANTY DISCLAIMER**

---

EXCEPT AS SPECIFICALLY PROVIDED IN A WRITTEN CONTRACT BETWEEN SELLER AND PURCHASER, THERE ARE NO OTHER WARRANTIES, EXPRESS OR IMPLIED, INCLUDING ANY IMPLIED WARRANTIES OF MERCHANTABILITY OR FITNESS FOR A PARTICULAR PURPOSE.



ALTHOUGH ALL EFFORT IS PUT INTO MAKING THIS MANUAL AND ALL OTHER DOCUMENTS RELATING TO THIS PRODUCT ACCURATE AND COMPLETE, GAMES, FEATURES, RULES, PLAYFIELD, PROGRAMMING AND OPERATION ARE SUBJECT TO CHANGE WITHOUT NOTICE. IF YOU HAVE ANY QUESTIONS OR PROBLEMS, CALL US AT 1-800-KICKERS OR (708) 345-7700. THANK YOU.



"MULTIBALL" IS A REGISTERED TRADEMARK OF WILLIAMS ELECTRONICS GAMES, INC.

### **WARNING**

---

THIS EQUIPMENT GENERATES, USES, AND CAN RADIATE RADIO FREQUENCY ENERGY, AND IF NOT INSTALLED AND USED IN ACCORDANCE WITH THE INSTRUCTIONS MANUAL, MAY CAUSE INTERFERENCE TO RADIO COMMUNICATIONS. IT HAS BEEN TESTED AND FOUND TO COMPLY WITH THE LIMITS FOR A CLASS A COMPUTING DEVICE PURSUANT TO SUBPART J OF PART 15 OF FCC RULES, WHICH ARE DESIGNED TO PROVIDE REASONABLE PROTECTION AGAINST SUCH INTERFERENCE WHEN OPERATED IN A COMMERCIAL ENVIRONMENT. OPERATION OF THIS EQUIPMENT IN A RESIDENTIAL AREA IS LIKELY TO CAUSE INTERFERENCE IN WHICH CASE THE USER AT HIS OWN EXPENSE WILL BE REQUIRED TO TAKE WHATEVER MEASURES MAY BE REQUIRED TO CORRECT THE INTERFERENCE.



# SEGA™ PINBALL, INC.

1990 Janice Avenue  
Melrose Park, IL 60160

© 1-708-345-7700  
FAX 1-708-345-7889

**Technical Support**  
Toll-Free (USA):  
**1-800-KICKERS (542-5377)**

*Need Technical Advice?  
Dial 1-800-KICKERS!*



Sega Pinball, Inc. and all related characters and indicia are  
trademarks of Sega Pinball, Inc. © 1994. All Rights Reserved.