

YAMAHA

FM SOUND GENERATOR
GENERATEUR DE SON FM
FM SOUNDGENERATOR

FB-01/U

OWNER'S MANUAL
MANUEL D'UTILISATION
BEDIENUNGSANLEITUNG

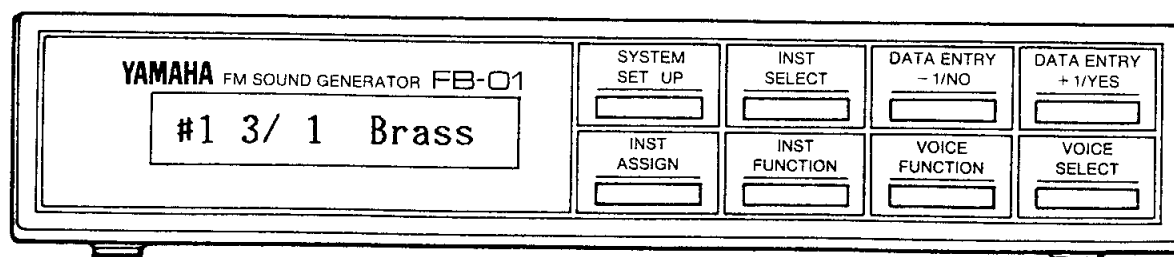

Congratulations

... on your purchase of the Yamaha FB-01 FM sound generator. The FB-01 is a 4-operator, 8-algorithm FM tone generator that can produce up to 8 notes simultaneously. The FB-01 may be set to be 8 instruments, each playing monophonically, one instrument with 8-note polyphony, or any combination in-between. Two hundred forty voice memories are provided in ROM (5 banks of 48 voices), and 96 more voice memories are provided in RAM for your own voices. The voice data is compatible with the Yamaha CX5M's SFG-05 sound synthesizer unit, and you can easily create your own sounds by using an external voice programming aid for the FB-01.

The configuration of the entire FB-01 (all settings for each instrument, MIDI channels, voice numbers, etc.) can be stored in Configuration Memory (there are 4 ROM presets and 16 RAM user memories).

The FB-01 features a comprehensive implementation of MIDI (Musical Instrument Digital Interface). It will receive system exclusive event list messages to recognize and produce microtonal intervals or non-standard temperament, as well as many system exclusive messages for loading or saving voice and configuration memories.

How to Use This Manual

This manual is organized to provide all the information necessary for correctly operating the FB-01. By starting with section 3, advanced users can quickly use the FB-01 in a MIDI system without having to review material already familiar to them. Less experienced users, and those wishing a comprehensive look at the FB-01, should begin with section 1.

FCC INFORMATION

While the following statements are provided to comply with FCC Regulations in the United States, the corrective measures listed below are applicable world-wide.

This series of Yamaha professional music equipment uses frequencies that appear in the radio frequency range and if installed in the immediate proximity of some types of audio or video devices (within three meters), interference may occur. This series of Yamaha combo equipment have been type tested and found to comply with the specifications set for a class B computing device in accordance with those specifications listed in subpart J of part 15 of the FCC rules. These rules are designed to provide a reasonable measure of protection against such interference. However, this does not guarantee that interference will not occur. If your professional music equipment should be suspected of causing interference with other electronic devices, verification can be made by turning your combo equipment off and on. If the interference continues when your equipment is off, the equipment is not the source of interference. If your equipment does appear to be the source of the interference, you should try to correct the situation by using one or more of the following measures:

Relocate either the equipment or the electronic device that is being affected by the interference. Utilize power outlets for the professional music equipment and the device being affected that are on different branch (circuit breaker or fuse) circuits, or install AC line filters.

In the case of radio or TV interference, relocate the antenna or, if the antenna lead-in is 300 ohm ribbon lead, change the lead-in to co-axial type cable.

If these corrective measures do not produce satisfactory results, please contact your authorized Yamaha professional products dealer for suggestions and/or corrective measures.

If you cannot locate a franchised Yamaha professional products dealer in your general area contact the professional products Service Department, Yamaha Music Corporation, 6600 Orangethorpe Ave., Buena Park, CA 90620, U.S.A.

If for any reason, you should need additional information relating to radio or TV interference, you may find a booklet prepared by the Federal Communications Commission helpful:

"How to Identify and Resolve Radio — TV Interference Problems". This booklet is available from the U.S. Government Printing Office, Washington D.C. 20402 — Stock No. 004-000-00345-4.

This information on safety is provided to comply with U.S.A. laws, but should be observed by users in all countries.

Operating Precautions

1. Location

Avoid locations exposed to direct sunlight or other sources of heat. Also avoid locations subject to vibration, excessive dust, cold, or moisture.

2. Cleaning

Do not attempt to clean the exterior with chemical solvents; this may damage the finish. Clean with a soft, dry cloth.

3. Service and Modifications

Do not open the FB-01 or attempt to make your own repairs or modifications to any part of the instrument. Such actions may not only result in electrical shock or damage, but will also void the product warranty. Refer all servicing to a qualified Yamaha service center.

4. Relocation

When moving the instrument be sure to unplug the AC wall plug and all other connecting cables.

5. Handling

Avoid applying excessive force to switches and slide controls, dropping, or rough handling. The FB-01 is ruggedly constructed and uses reliable solid-state circuitry, but it should be treated with the same care you would give to any other fine musical instrument.

6. Electrical Storms (lightning)

Digital circuitry, such as that used in the FB-01, is sensitive to voltage spikes and surges. Be sure to remove all connecting cables during an electrical storm.

7. Electromagnetic Fields

Digital circuitry is also sensitive to electromagnetic fields such as those produced by television sets, radio receivers, transmitters, etc. The FB-01 should be kept several feet away from any such sources to prevent possible malfunctions.

SUPPLEMENTAL MARKING INFORMATION

Yamaha Digital Musical Instrument Products will have either a label similar to the graphic shown below or a molded/stamped facsimile of the graphic on its enclosure. The explanation of these graphics appears on this page. Please observe all cautions indicated.

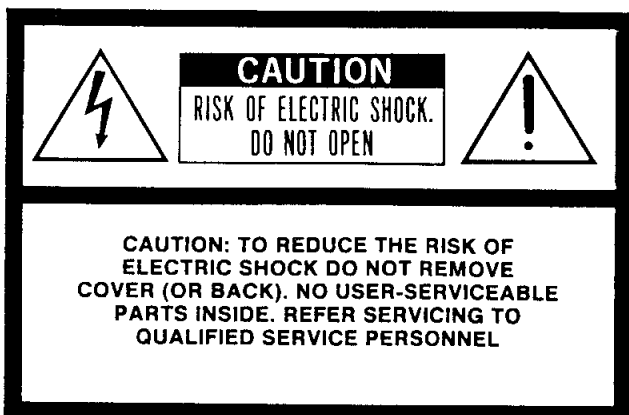

The Exclamation point within an equilateral triangle is intended to alert the user to the presence of important operating and maintenance (servicing) instructions in the literature accompanying the product.



The lightning flash with arrowhead symbol, within an equilateral triangle, is intended to alert the user to the presence of uninsulated "dangerous voltage" within the product's enclosure that may be of sufficient magnitude to constitute a risk of electric shock to persons.

TABLE OF CONTENTS

INTRODUCTION

- Congratulations
- How to Use This Manual
- Operating Precautions

SECTION 1 SETTING UP THE FB-01

- FB-01 Rear Panel View 1
- AC Power Requirements and Set Up..... 1
- MIDI Connections 1
- Audio Connections 2
- Powering Up the FB-01 4
- Memory Battery Switch 4
- FB-01 Front Panel Display 4
- Rack Mounting 4

SECTION 2 GETTING STARTED

- Listening to the FB-01 for the First Time..... 5
- How to Follow the Activity Dialog Boxes..... 5
- List of Factory Supplied Voices 7

SECTION 3 OPERATING INSTRUCTIONS

- Terms and Conventions Used in this Manual..... 8
- Color Grouping of the Front Panel Buttons 8
- Front Panel Keys..... 9
- The VOICE SELECT Key
 - Selecting Voices..... 10
 - Storing Voices to Banks 1 and 2 (RAM Banks) 10
 - Selecting a Voice Bank 12
- The VOICE FUNCTION Key
 - Pitch Bender Range..... 13
 - Portamento Time..... 13
 - POLY and MONO Modes..... 13
 - PMD-Pitch Modulation Device 14
- The INST ASSIGN and INST SELECT Keys
 - Multi-Timbre/Multi-MIDI Channel Capabilities of the FB-01..... 15
 - Instrument Select Key 16
 - MIDI Channel Set Up 16
 - Number of Notes Allocation 16
 - Lower/Upper Note Limits 17
- The INSTRUMENT FUNCTION Key
 - Setting the Output Level..... 19
 - Octave Transposition..... 19
 - Detuning an Instrument 20
 - Stereo Panning..... 20
 - LFO ON/OFF Toggle..... 21
- The SYSTEM SET UP Key
 - Configuration Memories 22
 - Combine Mode 23
 - Memory Protection 23
 - Storing a Configuration..... 24
 - System Channel Number 24
 - MIDI Bulk Data Dumps 25
 - Keycode Number Receive Mode..... 25

SECTION 4 MIDI OPERATIONS

- MIDI Codes Recognized by the FB-01 27
- MIDI Data Dumps
 - What is a MIDI Bulk Data Dump?..... 28
 - Devices Capable of Storing MIDI Bulk Data 28
 - Why use a MIDI Bulk Data Dump? 28
 - Manually Sending Configurations and Voices 28
 - Manually Receiving Configurations and Voices 28
- VOICING the FB-01 29

SECTION 5 SAMPLE APPLICATIONS

- Factory Supplied Configurations
 - Configuration Memory Number 17 30
 - Configuration Memory Number 18 31
 - Configuration Memory Number 19 32
 - Configuration Memory Number 20 33
- Sample MIDI System Set Ups
 - Application 1 - KX88 Controller with an FB-01 34
 - Application 2 - KX88 Controller with an FB-01 and a QX21 sequencer..... 35
 - Application 3 - FB-01 with a CX5M and MIDI Recorder 36
 - Application 4 - Using the FB-01 with a DX100/DX27 or DX21 37
 - Application 5 - FB-01 with a DX100 and a QX21 Sequencer 38
 - Application 6 - Two FB-01s with a KX5 and a QX21 Sequencer 39
 - Application 7 - FB-01 with a KX76 and a QX1 Sequencer 40
 - Application 8 - FB-01 with a Clavinova or PSR-70..... 41
 - Application 9 - FB-01 with any MIDI keyboard 42

SECTION 6 SPECIFICATIONS

- Hardware..... 44
- MIDI 45
 - MIDI Data Recognized (MIDI IN) 45
 - Standard MIDI Codes 45
 - System Exclusive MIDI Codes 47
 - System Exclusive Event Lists 50
 - System Exclusive Data Format Tables 51
 - Other MIDI Codes 54
 - MIDI Data Transmitted (MIDI OUT) 54
 - System Exclusive MIDI Codes 54

APPENDICES

- List of Figures..... 59
- Index..... 60

SECTION 1: Setting Up the FB-01

FB-01 Rear Panel View

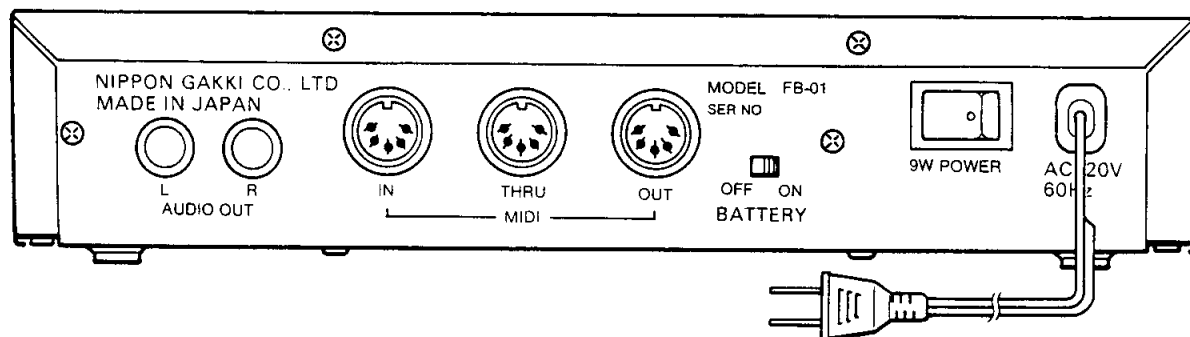

Figure 1: FB-01 Rear Panel

AC Power Requirements and Set Up

The FB-01 requires 120 (220 ~ 240) volts of AC power for proper operation. Connect the standard 2-prong plug to an AC wall socket.

MIDI Connections

These terminals are used to connect the FB-01 to other MIDI (Musical Instrument Digital Interface) compatible equipment.

MIDI IN

The MIDI IN terminal receives MIDI data from other MIDI equipment such as a synthesizer, sequencer, music computer or a master keyboard controller. The FB-01's MIDI IN terminal will always be connected to the MIDI OUT terminal of the transmitting equipment.

MIDI THRU

The MIDI THRU terminal re-transmits the data received at the MIDI IN terminal. This way, data received via the FB-01's MIDI IN terminal can be simultaneously sent to other MIDI equipment.

MIDI OUT

The MIDI OUT terminal transmits MIDI system exclusive messages from the FB-01 to other MIDI equipment. This is useful for saving voice and configuration memory.

Audio Connections

In order to hear the FB-01, you must connect the unit to some sort of amplification device. Some examples of suitable amplification devices are a stereo mixer/amplifier, a guitar type amplifier, a home stereo or a portable stereo. Here are some examples of audio connections for the FB-01.

FB-01 with a Stereo Mixer or Amplifier

Cable requirements:

Two (2) shielded audio cables with 1/4" phone plugs on one end, and with appropriate connectors on the other end for your stereo mixer/amplifier.

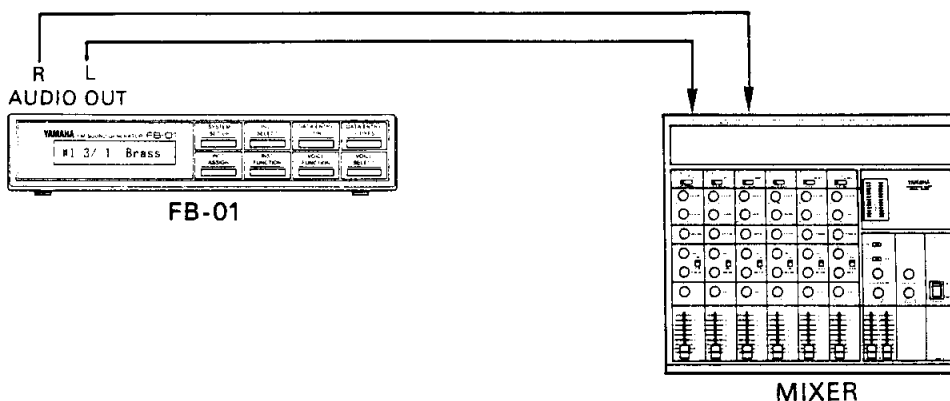

Figure 2: Connecting the FB-01 to a Stereo Mixer or Amplifier

FB-01 with a Guitar Type Amplifier

Cable requirements:

One (1) shielded audio cable with 1/4" phone plug on one end, and with appropriate connector on the other end for your amplifier.

NOTE:

Using the FB-01 in a mono environment negates all stereo effects of the FB-01.

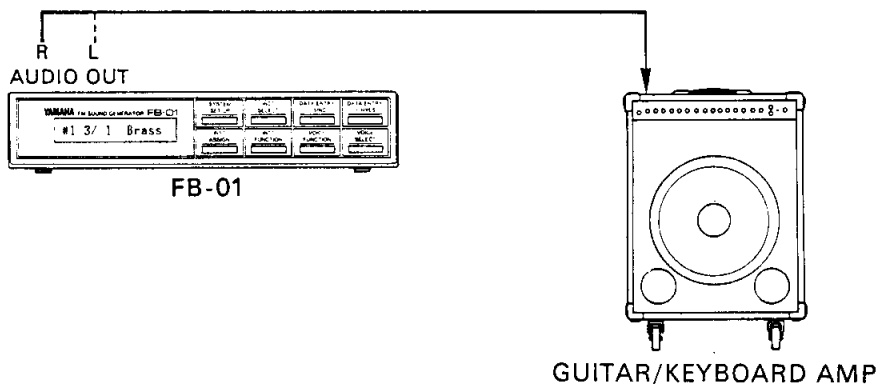

Figure 3: Connecting the FB-01 to a Guitar Type Amplifier

When using the FB-01 with a monophonic amp, two approaches can be taken. One is to use a "Y cable" for combining the L and R outputs of the FB-01 (a slight degradation of the audio signal may occur). The other is to re-program stereo pannings of all instruments to either the L or R output terminal on the FB-01. Both of these methods require only one input channel on the amplifier.

FB-01 with a Home Stereo System

Connecting the FB-01 to a home stereo system allows you to hear the FB-01 in a full-range audio environment without the additional expense of a stereo sound reinforcement system.

Cable requirements:

Two (2) shielded audio cables with 1/4" phone plugs on one end, and with appropriate connectors on the other end for connecting to your home stereo (normally RCA connectors).

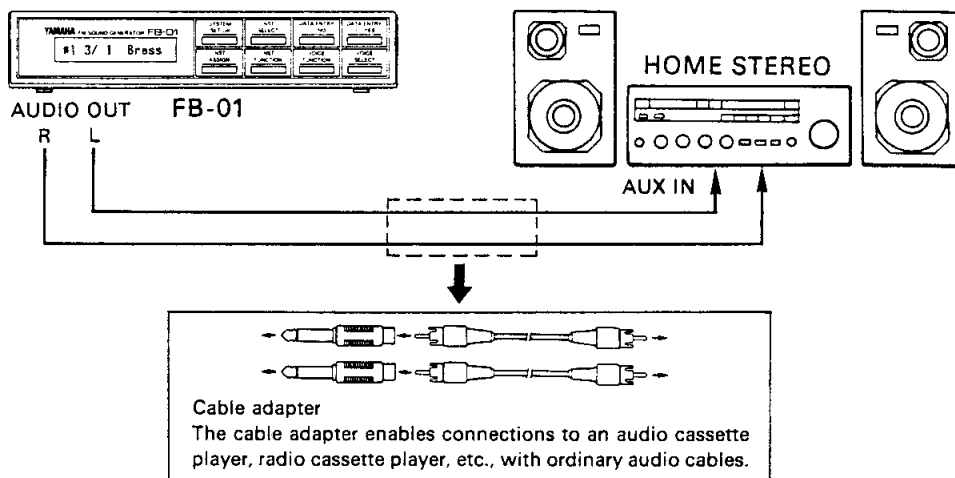

Figure 4: Connecting the FB-01 to a Home Stereo System

The choice of AUX, TAPE 1, or TAPE 2 will depend on your own stereo system's configuration and the number of available connectors.

FB-01 with a Portable Stereo System

Connecting the FB-01 to a portable stereo system allows you to hear the FB-01 in a portable audio environment.

Cable requirements:

Two (2) shielded audio cables with 1/4" phone plugs on one end, and with appropriate connectors on the other end for connecting to your portable stereo (normally RCA connectors).

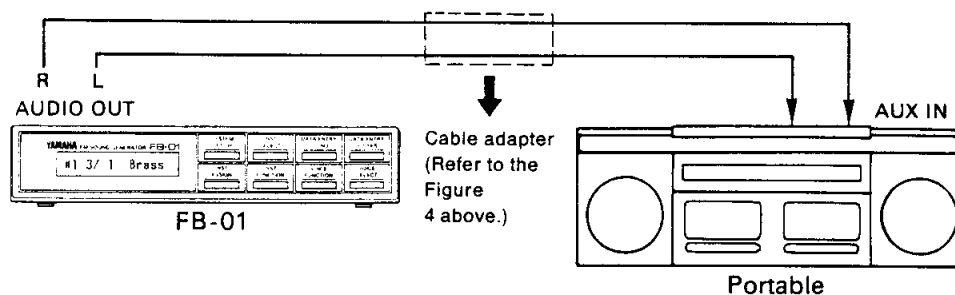

Figure 5: Connecting the FB-01 to a Portable Stereo

Powering Up the FB-01

The FB-01 power switch is located on the rear panel, next to the AC cable. Depressing the side of the switch that has the dot (●) powers the unit ON. The front panel display will read "FB-01 ready !!!" for a few seconds.

NOTE:

The FB-01 should be turned on AFTER the controlling (transmitting) device is turned on. If the controlling device is turned on after the FB-01, the FB-01 may display "MIDI/error !!!" on the front panel. This is not serious; depressing any key on the front panel will reset the display. Also note that the FB-01 will continue to sound even while the error message is displayed.

Memory Battery Switch

The FB-01 incorporates a battery-maintained memory source for keeping your custom voices and configuration setups. This battery has a life expectancy of about 5 years and will need to be replaced by your authorized Yamaha service and repair center at that time. To preserve the memory battery, a switch is included to avoid unnecessarily using the battery when it is not needed (such as during extended storage). You should now set the memory battery switch to the ON position. Carefully use a pencil or similar instrument to slide the switch to the right to activate the memory battery.

IMPORTANT!!!

For the FB-01 to store any modifications that you make to either configurations or voices, you **MUST** set this switch to the ON position.

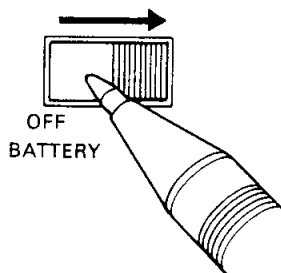

Figure 6: The FB-01 Memory Battery Switch

FB-01 Front Panel Display

The FB-01 is designed with a special display that is easily viewed from almost any angle above the unit. You should place the unit in your system so that you can easily use the front panel switches while viewing the display.

Rack Mounting (Optional)

The FB-01 can be mounted individually, or mounted in pairs by using a special rack mounting kit, available from your authorized Yamaha dealer.

SECTION 2: Getting Started

Listening to the FB-01 for the First Time

Turn the Power On

If you turned the power on in section 1, continue to the next step. Otherwise, the FB-01 power switch is located on the rear panel, next to the AC cable. Depressing the side of the switch that has the dot (●) powers the unit on. The front panel display will read "FB-01 ready !!!" for a few seconds.

NOTE:

The FB-01 should be turned on AFTER the controlling (transmitting) device is turned on. If the controlling device is turned on after the FB-01, the FB-01 may display "MIDI/error !!!" on the front panel. This is not serious; depressing any key on the front panel will reset the display. Also note that the FB-01 will continue to sound even while the error message is displayed.

How to Follow the Activity Dialog Boxes

In this owner's manual, each feature of the FB-01 will be described, then you will be given instructions on how to set up and/or use that feature. The instructions are provided in the form of an Activity Dialog Box. The box has three sections. The first falls under the **action** column. In this column you will be instructed which button to press, and for how long. The second area falls under the **display will read** column. This column shows you what the FB-01 front panel display will show when you have successfully completed the instruction given under the action column. Since the FB-01 has a great number of options available to the user, sometimes a value that is displayed in your FB-01 will differ from that which is shown in the manual. This is okay as long as the difference occurs in the area of the display that is shown as shaded in the manual. In order to correctly follow the manual, it is suggested that you use the DATA ENTRY keys to set the value equal to that shown in the manual. The third column, which is the **explanation** column, provides a brief explanation of what you have just accomplished.

Select A Configuration Memory

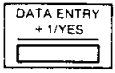
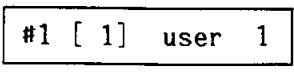
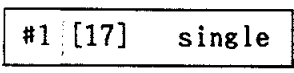

To listen to the voices of the FB-01 we will use one of the Configuration Memories that is supplied in the unit's ROM memory (a detailed description of the Configuration Memory appears later in the manual). This configuration will allow you to play up to 8 notes of the same voice.

★ To select Configuration Memory number 17, do the following:

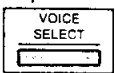
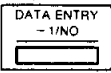
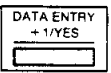

action	display will read	explanation
press  until press  until	 	selects configuration memory #1 selects configuration memory #17

Make sure that the transmitting keyboard is transmitting on MIDI channel 1.

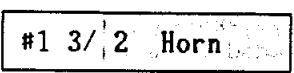
To Select Different Voices

action	display will read	explanation
press  once press  or  as desired	 	displays the currently selected voice name and number to select different voices

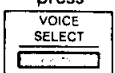
To Select a Different Bank of Voices

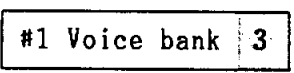
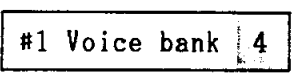
action	display will read	explanation
press  until press  or  until	 	current voice bank number is displayed new bank number is displayed

You may now select any one of the 48 voices in the new bank you have chosen in the same way as described above (press VOICE SELECT once, then use the +1 or -1 keys).

Try playing all the voices in the FB-01. Use the following voice chart as a guide. Note that banks 1 and 2 (the RAM banks) are set at the factory to be equal to bank 3.

List of Factory Supplied Voices

ROM1 (BANK3)		ROM2 (BANK4)		ROM3 (BANK5)		ROM4 (BANK6)		ROM5 (BANK7)	
01	Brass	01	UpPiano	01	Horn2	01	FnkSyn2	01	JOrgan1
02	Horn	02	Spiano	02	Horn3	02	FnkSyn3	02	JOrgan2
03	Trumpet	03	Piano2	03	Horns	03	SynOrgn	03	COrgan1
04	LoStrig	04	Piano3	04	Flugelh	04	SynFeed	04	COrgan2
05	Strings	05	Piano4	05	Trombon	05	SynHarm	05	EOrgan3
06	Piano	06	Piano5	06	Trumpt2	06	SynClar	06	EOrgan4
07	NewEP	07	PhGrand	07	Brass2	07	SynLead	07	EOrgan5
08	EGrand	08	Grand	08	Brass3	08	HuffTak	08	EOrgan6
09	Jazz Gt	09	DpGrand	09	HardBr1	09	SoHeavy	09	EOrgan7
10	EBass	10	LPiano1	10	HardBr2	10	Hollow	10	EOrgan8
11	WodBass	11	LPiano2	11	HardBr3	11	Schmooh	11	SmlPipe
12	EOrgan1	12	EGrand2	12	HardBr4	12	MonoSyn	12	MidPipe
13	EOrgan2	13	Honkey1	13	HuffBrs	13	Cheeky	13	BigPipe
14	POrgan1	14	Honkey2	14	PercBr1	14	SynBell	14	SftPipe
15	POrgan2	15	Pfbell	15	PercBr2	15	SynPluk	15	Organ
16	Flute	16	PfVibe	16	String1	16	EBass3	16	Guitar
17	Piccolo	17	NewEP2	17	String2	17	RubBass	17	Folk Gt
18	Oboe	18	NewEP3	18	String3	18	SolBass	18	PluckGt
19	Clarine	19	NewEP4	19	String4	19	PlukBas	19	BriteGt
20	Glocken	20	NewEP5	20	SoloVio	20	UprtBas	20	Fuzz Gt
21	Vibes	21	EPiano1	21	RichSt1	21	Fretles	21	Zither2
22	Xylophn	22	EPiano2	22	RichSt2	22	FlapBs	22	Lute
23	Koto	23	EPiano3	23	RichSt3	23	MonoBas	23	Banjo
24	Zither	24	EPiano4	24	RichSt4	24	SynBas1	24	SftHarp
25	Clav	25	EPiano5	25	Cello1	25	SynBas2	25	Harp2
26	Harpsic	26	HighTin	26	Cello2	26	SynBas3	26	Harp3
27	Bells	27	HardTin	27	LoStrg3	27	SynBas4	27	SftKoto
28	Harp	28	PercPf	28	LoStrg4	28	SynBas5	28	HitKoto
29	SmadSyn	29	WoodPf	29	LoStrg5	29	SynBas6	29	Sitar1
30	Harmoni	30	EPStrng	30	Orchest	30	SynBas7	30	Sitar2
31	SteelDr	31	EPBrass	31	5th Str	31	Marimb2	31	HuffSyn
32	Timpani	32	Clav2	32	Pizzic1	32	Marimb3	32	Fantasy
33	LoStrg2	33	Clav3	33	Pizzic2	33	Xyloph2	33	Synvoic
34	Horn Lo	34	Clav4	34	Flute2	34	Vibe2	34	M.Voice
35	Whistle	35	FuzzClv	35	Flute3	35	Vibe3	35	VSAR
36	zingPip	36	MuteClv	36	Flute4	36	Glockn2	36	Racing
37	Metal	37	MuteCl2	37	Pan Flt	37	TubeBe1	37	Water
38	Heavy	38	SynClv1	38	SlowFlt	38	TubeBe2	38	WildWar
39	FunkSyn	39	SynClv2	39	5th Flt	39	Bells 2	39	Ghostie
40	Voices	40	SynClv3	40	Oboe2	40	TempleG	40	Wave
41	Marimba	41	SynClv4	41	Bassoon	41	SteelDr	41	Space 1
42	EBass2	42	Harpsi2	42	Reed	42	ElectDr	42	SpChime
43	SnareDr	43	Harpsi3	43	Harmon2	43	HandDr	43	SpTalk
44	RD Cymb	44	Harpsi4	44	Harmon3	44	SynTimp	44	Winds
45	Tom Tom	45	Harpsi5	45	Harmon4	45	clock	45	Smash
46	Mars to	46	Circust	46	MonoSax	46	Heifer	46	Alarm
47	Storm	47	Celeste	47	Sax 1	47	SnareD2	47	Helicop
48	Windbel	48	Squeeze	48	Sax 2	48	SnareD3	48	SineWav

SECTION 3: Operating Instructions

Terms and Conventions Used in This Manual

Certain terms will be used throughout the manual. This is a short description of each term. A more detailed description will appear later in this section.

Definition of Terms

VOICE	a tone color — sometimes called a “patch” or “program”
BANK	a group of 48 voices
INSTRUMENT	a grouping of several notes (up to 8) of one voice
CONFIGURATION	a preset grouping of instruments

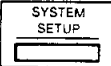

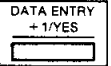



Figure 7: Definition of Terms

When using this manual, it is assumed that configuration #17 is active. This is to give all readers a common reference point when following the manual instructions.

To set the FB-01 on configuration #17, follow the instructions of page 5 “Select a Configuration Memory”.

Color Grouping of the Front Panel Buttons

The front panel of the FB-01 is organized into groups of functions, which are noted by the color code bar above each key.

Color	Keys	Purpose
Green	 	Global Menu Keys
White	 	Data Entry/Modify Keys
Blue	 	Instrument Menu Keys
Blue	 	Voice Menu Keys

Front Panel Keys

Although the front panel of the FB-01 has only eight (8) keys, many functions and parameters are available by pressing the same key several times.

FRONT PANEL KEY CHART

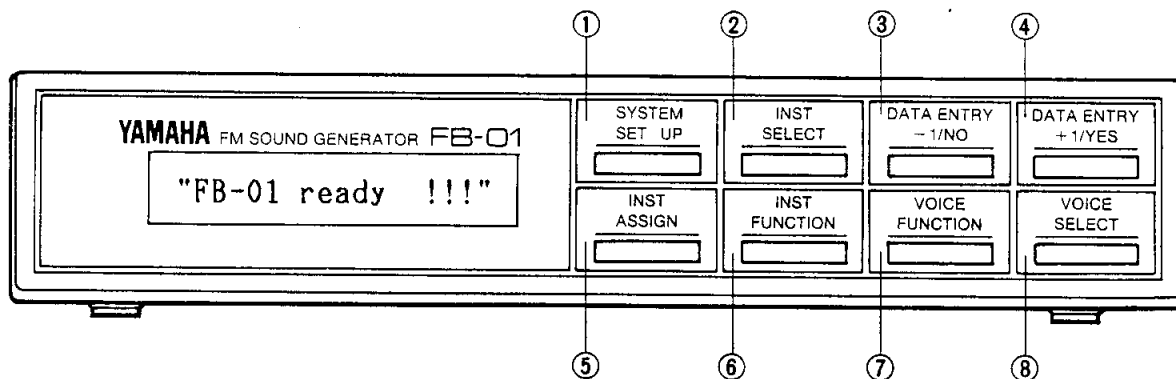

Figure 8: Front Panel Key Chart w/FB-01 Front Panel

① SYSTEM SET UP

Configuration Select

Combine ON/OFF

Memory Protect

Configuration Store

Tuning

System Channel Number

Dump

Key-code Number
Receive Mode

② INSTRUMENT SELECT

Increments Instrument
Number

③ DATA ENTRY/-1/NO

Decrements Value

④ DATA ENTRY/+1/YES

Increments Value

⑤ INST ASSIGN

MIDI Channel Number

Number of Notes

Key-code Number limit/L

Key-code Number limit/H

⑥ INST FUNCTION

Output Level

Octave Transpose

Detune

Stereo

LFO Enable

⑦ VOICE FUNCTION

Pitchbender Range

Portamento Time

Mono/Poly

Controller for PMD

⑧ VOICE SELECT

Voice Number

Voice Store

Voice Bank Number

The VOICE SELECT Key

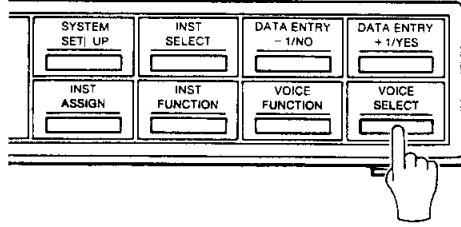
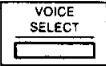
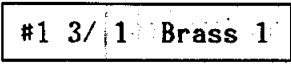
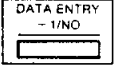
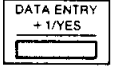
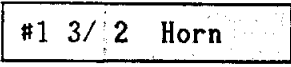

Figure 9: Voice Select Key View

Selecting Voices



To select a voice, follow these steps.

action	display will read	explanation
press 		current voice name and number is displayed
press  or  as desired		new voice name and number is displayed
NOTE: Selecting a voice less than 1 or greater than 48 causes a "wrap around" of voice number. When voice number 1 is displayed; choosing the next lower voice number causes voice number 48 to be displayed, when voice number 48 is displayed, choosing the next higher voice number will cause voice number 1 to be displayed.		

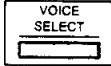
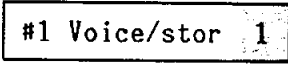

Storing Voices to Banks 1 and 2 (RAM Banks)

- Before storing a voice, make sure that MEMORY PROTECT is OFF (described in The SYSTEM SET UP Key heading, page 22).
- Select the voice you wish to store from any of the seven (7) voice banks (see "Selecting Voices" above).

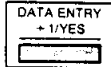
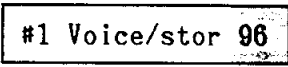
★ Select the memory number where you wish to store the voice:

action	display will read	explanation
press  until		store voice mode is selected
press  or  as desired NOTE:		until desired voice number is displayed
NOTE: You are required to press a data entry key at this point, even if the voice number displayed is the one desired. If this is the case, press [DATA -1/NO] , then [DATA +1/YES] (this will return to the currently selected voice).		

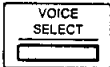
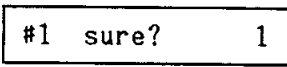
★ Verify and store the voice:

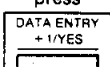
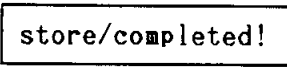
action	display will read	explanation
press 		verify store to memory #1
press 		to cancel
or press 		store successfully completed

Press a key to return to the last function selected.

NOTE:

When storing voices to the RAM banks, a different voice numbering scheme is used. The two banks of 48 voices are numbered together as voices 1 through 96. This method is only used while storing voices. Voice numbers 1 through 48 refer to Bank 1, Voices 1 through 48. Voice numbers 49 through 96 refer to Bank 2, Voices 1 through 48. Equivalent voice numbers are listed below.

RAM Voice Numbers

Store Bank A		Store Bank A		Store Bank B		Store Bank B	
1	1	25	25	49	1	73	25
2	2	26	26	50	2	74	26
3	3	27	27	51	3	75	27
4	4	28	28	52	4	76	28
5	5	29	29	53	5	77	29
6	6	30	30	54	6	78	30
7	7	31	31	55	7	79	31
8	8	32	32	56	8	80	32
9	9	33	33	57	9	81	33
10	10	34	34	58	10	82	34
11	11	35	35	59	11	83	35
12	12	36	36	60	12	84	36
13	13	37	37	61	13	85	37
14	14	38	38	62	14	86	38
15	15	39	39	63	15	87	39
16	16	40	40	64	16	88	40
17	17	41	41	65	17	89	41
18	18	42	42	66	18	90	42
19	19	43	43	67	19	91	43
20	20	44	44	68	20	92	44
21	21	45	45	69	21	93	45
22	22	46	46	70	22	94	46
23	23	47	47	71	23	95	47
24	24	48	48	72	24	96	48

Selecting a Voice Bank

To select a voice bank, follow these steps.

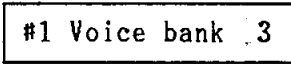
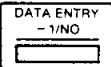
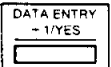
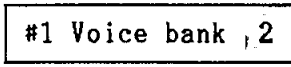
action	display will read	explanation
press  until		current bank number is displayed
press  or  as desired		new bank number is displayed

The VOICE FUNCTION Key

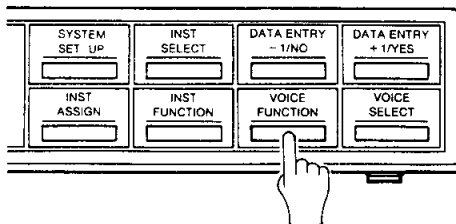
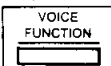
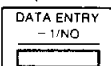
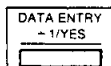
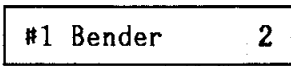
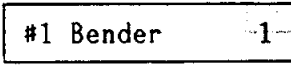

Figure 10: Voice Function Key View

Pitch Bender Range

The pitch bender range is programmable in increments of semitones (half-steps) for each voice. The effect is variable from no effect at all to a range of one full octave up or down. A value of 0 (zero) has no effect, a value of 2 has a range of 1 full step, a value of 3 has a range of a minor 3rd, and a value of 12 has a range of a full octave.

To set the pitch bender range value, follow these steps.



action	display will read	explanation
press  until press  or  as desired	 	current bender range is displayed new bender range is displayed

Portamento Time

Portamento is described as a gradual gliding movement in pitch from one note to another. The amount of time to slide from one note to the next is called portamento time.

Portamento time is programmable per voice from 0 (which has no portamento effect) up to an extreme setting of 127 (approximately 6 1/2 seconds for each octave of glide).

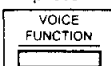
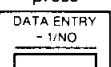
To set the portamento time value, follow these steps.

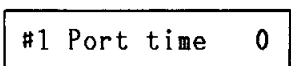
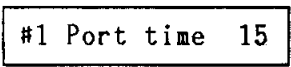
action	display will read	explanation
press  until press  or  as desired	 	current portamento time is displayed portamento effect is adjusted



Play a few low notes followed by a few high notes to hear the portamento effect.

POLY and MONO Modes

The FB-01 has two playing modes per voice, POLY (short for polyphonic) and MONO (short for monophonic). The POLY mode allows more than one note to be played at a time while MONO mode allows only 1 note at a time. The MONO mode also features the ability to mimic the musical phrasings of a wind controlled instrument, such as a clarinet or saxophone. When in MONO mode, only the first note of a musical phrase receives full attack, as long as the second through last notes of the phrase are played in a legato fashion (not releasing a key until the next key is already depressed).

The MONO mode has one additional feature. If the portamento time value is set to a value higher than 0 (zero), then the portamento effect will only be heard between notes that are played in a legato fashion. When playing staccato notes, you will not hear the portamento effect. Some Yamaha keyboard owners already know this feature as "fingered portamento".

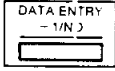
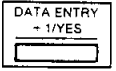
To set POLY or MONO modes, follow these steps.

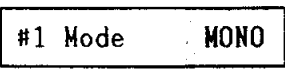
action	display will read	explanation
press  until pre-  or  as desired	 	current mode is displayed MONO mode has been selected

Play a few notes in MONO mode with the portamento time value higher than zero to hear the "fingered portamento" effect described earlier.

PMD — Pitch Modulation Device

Pitch modulation is accomplished by an LFO (Low Frequency Oscillator) to produce effects such as vibrato, growling and trills. A modulation source device is used to determine how much of the LFO effect is heard. The FB-01 gives you a choice of 4 source devices: modulation wheel, after touch, foot controller, or breath controller. A fifth option of OFF is provided if you don't want the instrument to respond to a modulation source device.

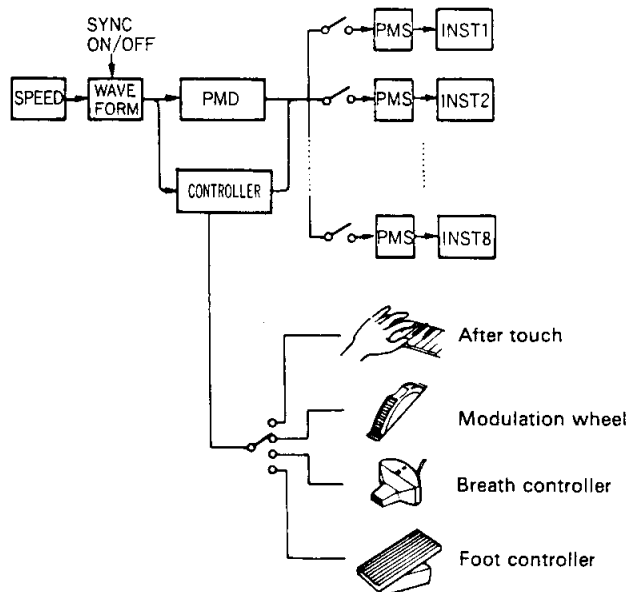
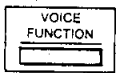
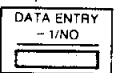
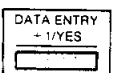



Figure 11: PMD Devices

To choose a pitch modulation device, follow these steps.

action	display will read	explanation
press  until press  or  as desired	 	current PMD parameter is displayed select a new PMD controller

The INST ASSIGN and INST SELECT Keys

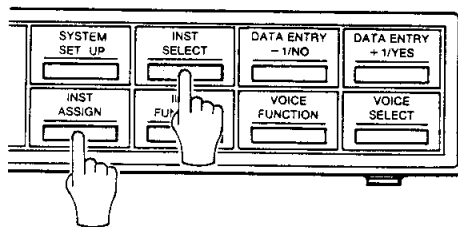

Figure 12: Inst Assign and Inst Select Key View

Multi-Timbre/Multi-MIDI Channel Capabilities of the FB-01

MIDI CHANNEL BASICS

MIDI is designed as a multi-channel means of passing information between musical instruments and devices. MIDI has 16 channels that are transmitted over a single cable. This multi-channel capability can be compared to cable TV wiring, where many different channels are broadcast simultaneously over a single cable. A television is equipped to "tune in" a single channel at a time, ignoring those channels that are not needed. Setting the MIDI channel accomplishes the same thing. For example, if we set the MIDI channel to 1, then everything on channels 2 through 16 is ignored.

MIDI CHANNELS AND MIDI ZONES

Each instrument in the FB-01 may be set to receive MIDI data on its own MIDI channel. Since you can have up to 8 instruments active at one time, it is possible to monitor 8 different MIDI channels all from the same unit. This is further enhanced by the ability to have a different voice for each instrument.

In addition to its MIDI channel assignment, each instrument can be assigned to a specific keyboard range. Only notes that are played within the specified range will be played by that instrument. The range is determined by a low note limit and a high note limit. All notes below the low note limit are ignored. Similarly, all notes above the high note limit are also ignored. The valid note range is commonly known as a MIDI zone.

To summarize, for the FB-01 to sound a note, the note must be on a MIDI channel that has an instrument assigned to it, AND the note must fall within the lower and upper note limits.

Instrument Select Key

The INSTRUMENT SELECT key is used to choose individual instruments. A selection of up to 8 instruments is possible, depending on how the FB-01's 8 notes are allocated in a configuration. In order to experiment with many instruments, select configuration memory 19 (dual); see page 23 if necessary for instructions on how to change configuration memories. In the FB-01 front panel display, the first 2 characters indicate the instrument number. The INSTRUMENT SELECT key functions incrementally. For example, if Instrument # 1 is displayed, then pressing the INSTRUMENT SELECT key will change the front panel display from "#1" to "#2".

NOTE:

Be sure to change the configuration number back to number 17 to continue with the rest of the manual.



MIDI Channel Set Up

MIDI channel numbers are 1 through 16.

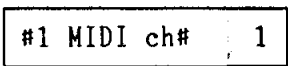
To set the MIDI channel for an instrument, follow these steps.

action	display will read	explanation
press  until		current MIDI channel is displayed

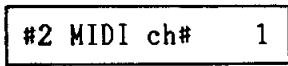
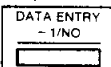

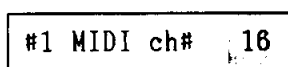
★ if you would like to change the MIDI channel of a different instrument:

action	display will read	explanation
press  until		increments instrument #
press  or  as desired		set the instrument to the desired MIDI channel

Number of Notes Allocation



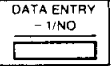
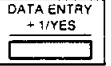
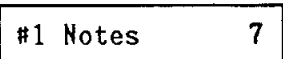

The FB-01 is capable of playing 8 notes. These may be distributed among instruments until all 8 notes have been allocated. The number of notes is variable from 0 to 8.

To allocate a specific number of notes to an instrument, follow these steps.

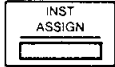

action	display will read	explanation
press  until		current number of notes is displayed
press  or  as desired		new number of notes is displayed
NOTE: Once the limit of 8 notes for the FB-01 has been reached, the DATA +1/YES key becomes inactive.		

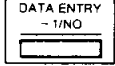
As an example of a multi-instrument configuration, assign seven (7) notes to instrument #1 and 1 note to instrument #2 using the following steps.

Set instrument #1 to play seven (7) notes.

action	display will read	explanation
press  until		current number of notes is displayed
press  once		new number of notes is displayed

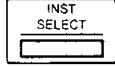
Change to instrument #2.

action	display will read	explanation
press  once		increments instrument # and shows the number of notes assigned to instrument #2

Set instrument #2 to play 1 note.

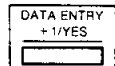
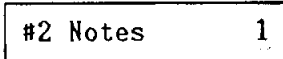
action	display will read	explanation
press  once		one note is now assigned to instrument #2

Lower/Upper Note Limits

A valid range of notes can be set for each instrument. This is sometimes called "MIDI Zoning". Lower and upper note limits can be set from C-2 to G8 (C3 = middle C).

To set the lower note limit, follow these steps.

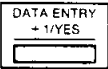
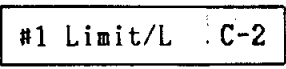
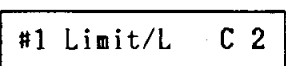

action	display will read	explanation
press  until press  as desired	 	current value is displayed new low note limit is set

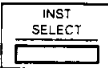
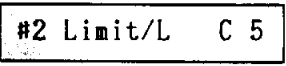
★ if you would like to change the low key limit on a different instrument:

action	display will read	explanation
press  as desired		new instrument # with its current low key limit is displayed

For example, if the low key limit is set to C2, no sound is made by the FB-01 when a note below C2 is played.

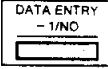
To set the upper note limit, follow these steps.

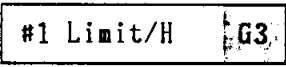
action	display will read	explanation
press  until press  until	 	current high key limit is displayed new high note limit is set

★ if you would like to change the high key limit on a different instrument:

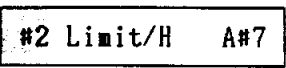
action	display will read	explanation
press  until		new instrument # with its current high key limit is displayed

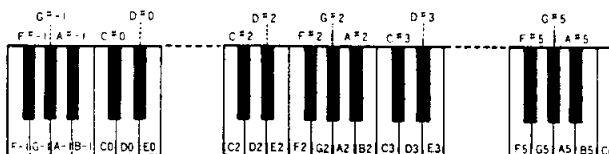

Figure 13: MIDI Note Ranges

The INSTRUMENT FUNCTION Key

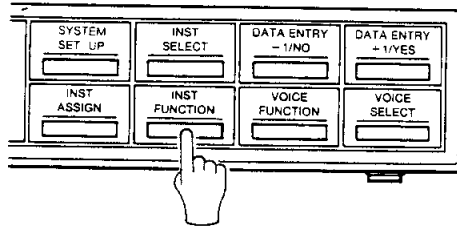

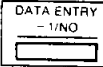

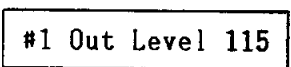

Figure 14: Instrument Function Key View

Setting the Output Level

The output level (volume) of each instrument is programmable on the FB-01. This is useful for balancing individual instrument volume levels within a Configuration Memory. The output level is variable from 0 (zero, no output) to 127 (full volume).

To set the programmable output level for an instrument, follow these steps.

action	display will read	explanation
press  until press  or  until	 	current output level is displayed new output level is displayed

★ if you would like to change the output level of a different instrument:

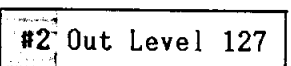
action	display will read	explanation
press  until		new instrument # is displayed

Try setting the output level at 80, then 100, then 120, etc. to hear the effect of changing the instrument volume. There are 128 different output level settings.

Octave Transposition

The FB-01 has the capability to transpose notes by as much as 2 octaves up or down in octave increments.

To set the octave value, follow these steps.

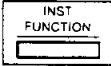
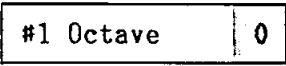
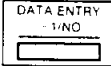
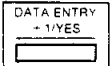
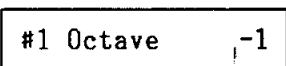
action	display will read	explanation
press  until		current octave transposition is displayed
press  or  until		new octave transposition is displayed

★ if you would like to change the octave transpose on a different instrument:

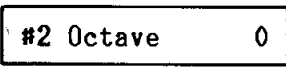
action	display will read	explanation
press  until		new instrument # is displayed

Detuning an Instrument

Detuning of instruments can be used to cause chorusing effects. The detune value is variable from -64 to +63.

To set a detune value for an instrument, follow these steps.

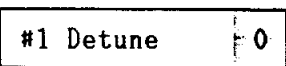
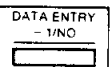
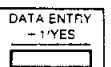
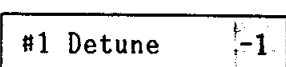
action	display will read	explanation
press  until		current detune value is displayed
press  or  until		new detuning value is displayed

★ if you would like to detune other instruments:

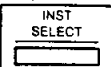
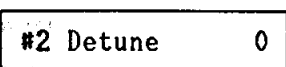

action	display will read	explanation
press  until		new instrument # is displayed

Try detuning up or down by an increment of 6 to 10 (or -6 to -10) to simulate a chorusing effect.



Stereo Panning

Panning allows you to place an instrument within a stereo field. The FB-01 allows you a choice of L(ef), R(ight) or LR(both, center) for each instrument.

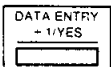
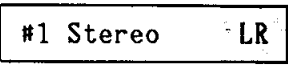
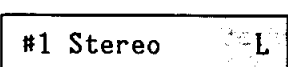
To set the PAN setting, follow these steps.

action	display will read	explanation
press  until press  or  until	 	current pan setting is displayed new pan setting is displayed



★ if you would like to change the pan setting on a different instrument:

action	display will read	explanation
press  as desired		new instrument # is displayed

LFO (Low Frequency Oscillator) ON/OFF Toggle

The LFO effect can be toggled ON or OFF for any voice which has LFO in the voice data.

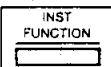
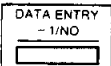
To toggle the LFO on/off, follow these steps.

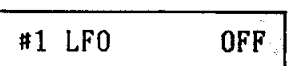
action	display will read	explanation
press  until press 	 	current LFO setting is displayed new LFO setting is displayed

★ if you would like to change the LFO toggle on a different instrument:

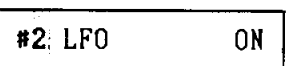
action	display will read	explanation
press  until		new instrument # is displayed

The rate and waveshape of the LFO is determined by the last voice selected in a configuration, regardless of the instrument number that the voice is assigned to. To assure the desired LFO rate and waveshape will be active in a configuration, assign the voice with the desired LFO settings last.

The SYSTEM SET UP Key

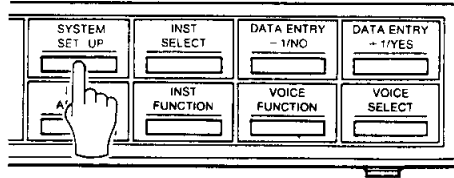

Figure 15: System Set Up Key View

Configuration Memories

The FB-01 contains twenty configuration memories. Four of these configuration memories, numbers 17 through 20, are set at the factory and cannot be modified. These four ROM Configuration Memories are quite useful as starting points for setting up your own configuration memories.

The sixteen RAM Configuration Memories are labeled as user Configuration Memories on the front panel display.

When selected, a Configuration Memory will automatically call up:



- Voice
- *Voice Functions
- Instruments
- Instrument Functions.

For example, when Configuration Memory number 17 is selected, the following items are called up automatically:

1. One instrument with 8 notes allocated to the instrument
2. MIDI channel is set to 1
3. Upper note limit is set to G-8
4. Lower note limit is set to C-2
5. Output level is set to 127 (full volume)
6. Octave select is set to 0 (no transposition)
7. No detuning
8. Instrument output on both the Left and Right channels
9. LFO is ON
- *10. Bender amount is set to 2 (full-step)
- *11. Portamento Time is 0
- *12. POLY mode is active
- *13. Pitch Modulation Device is WHEEL
14. Voice selected is bank 3, voice 1 (Brass).

* These Voice Function data parameters may be assigned new values that are stored as part of the Configuration data. These values are exactly the same as the Voice Function data values that are stored with a Voice, except that they are stored as part of a Configuration. When a Configuration is selected, the Voice Function data stored in the Configuration will override the Voice Function data that is stored with the Voice. Once a Configuration is recalled, any further Voice selections that are made would cause the Voice Function data stored with the Voice to be recalled when the Voice is selected, as long as the Combine Mode parameter is set to "ON" (see page 23). To set Voice Function data values to be stored as part of a Configuration, follow the instructions for setting Voice Function data values (see pages 12 ~ 15), then store the Configuration as described on 24.)

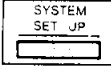
To select configuration number 17, follow these steps.

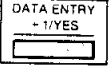
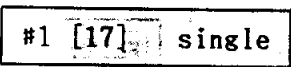
action	display will read	explanation
press  until		current configuration number and name are displayed
press  or  until		selects configuration memory #17

Combine Mode

When the combine mode is ON, all voice function data such as bender amount and portamento time are recalled when a voice is loaded. When the combine mode is OFF, the voice function data is NOT recalled with the loaded voice.

To set the combine mode value, follow these steps.

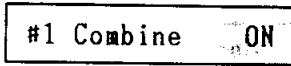
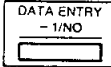
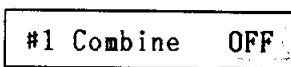
action	display will read	explanation
press  until		current value is displayed
press  until		new combine value is displayed

Memory Protection

Memory protect is used to prevent accidental storage of modifications to the FB-01's memory. If the memory protect is ON, changes to voice data, voice function data, instrument data, instrument assign data, or configuration memories CANNOT be saved (through the save voice or save configuration operations).

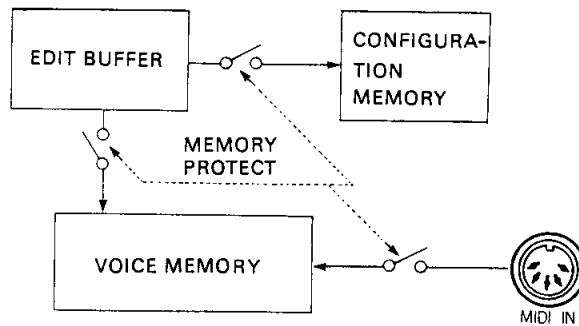

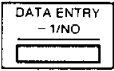
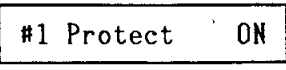
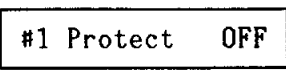

Figure 16: Memory Protection



To turn the memory protect ON or OFF, follow these steps.

action	display will read	explanation
press  until press  once	 	current status is displayed new protect status is displayed

Storing a Configuration

Sixteen (16) user configuration memory locations are available to store user configurations.

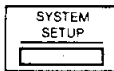
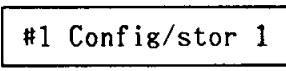
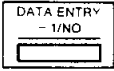
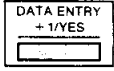
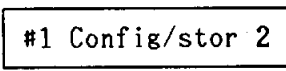
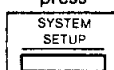
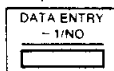
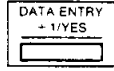
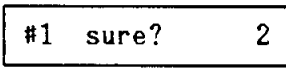
To store a configuration, follow these steps.

action	display will read	explanation
press  until		configuration store mode is selected
press  or  until		new configuration number is displayed
NOTE: You are required to press a data entry key at this point, even if the voice number displayed is the one desired. If this is the case, press DATA -1/NO , then DATA +1/YES (this will return to the currently selected voice).		
press  or press  or press 	 	verify store to configuration #2 to cancel store successfully completed

Press any key to return to the previous function.

System Channel Number

The FB-01 system channel number is used to designate which MIDI channel is used for system exclusive messages. A system exclusive message is MIDI data that is transmitted specifically for one instrument or device. A system exclusive message for the FB-01 can only be recognized by a Yamaha FB-01, or some device (such as a computer) that is instructed to recognize FB-01 system exclusive data.

In a system with more than one FB-01, each FB-01 can be set to receive system exclusive messages on a separate channel. The system channel number may be set to any of the 16 MIDI channel numbers.

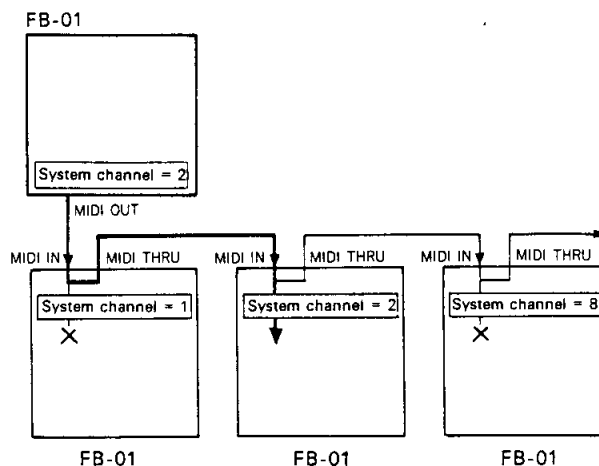

Figure 17: System Channel Number

To set the system channel number, follow these steps.

action	display will read	explanation
press <div style="border: 1px solid black; padding: 2px; display: inline-block;">SYSTEM SETUP</div> until press <div style="border: 1px solid black; padding: 2px; display: inline-block;">DATA ENTRY 1/NO</div> or <div style="border: 1px solid black; padding: 2px; display: inline-block;">DATA ENTRY +1/YES</div> as desired	<div style="border: 1px solid black; padding: 5px; display: inline-block;">#1 System ch# 1</div> <div style="border: 1px solid black; padding: 5px; display: inline-block;">#1 System ch# 16</div>	current system channel number is displayed new system channel # is displayed

MIDI Bulk Data Dumps

The SYSTEM SET UP key is used to initiate bulk dumps of voice data or configuration data. This is discussed in detail in the next section of this manual.

Keycode Number Receive Mode

The MIDI specification assigns 1 of 128 possible note values to each key on a keyboard. The FB-01 has the capability of recognizing all note values (normal operation) or just ODD or EVEN numbered note values. This feature can be quite useful when using two (2) FB-01s together in a system. By setting one FB-01 to recognize ODD key note values and the other to recognize EVEN key note values, the two FB-01s can essentially act as one unit with 16 note polyphony.

To set the key code number receive mode, follow these steps.

action	display will read	explanation
<p>press</p> <div style="border: 1px solid black; padding: 2px; width: fit-content; margin: 0 auto;"> SYSTEM SETUP <input style="width: 100%; height: 15px;" type="text"/> </div> <p>until</p>	<div style="border: 1px solid black; padding: 5px; width: fit-content; margin: 0 auto;"> #1 Receive ALL </div>	<p>current key code receive mode is displayed</p>
<p>press</p> <div style="display: flex; justify-content: space-around; align-items: center;"> <div style="border: 1px solid black; padding: 2px; width: fit-content;"> DATA ENTRY -1/NO <input style="width: 100%; height: 15px;" type="text"/> </div> or <div style="border: 1px solid black; padding: 2px; width: fit-content;"> DATA ENTRY +1/YES <input style="width: 100%; height: 15px;" type="text"/> </div> </div> <p>until</p>	<div style="border: 1px solid black; padding: 5px; width: fit-content; margin: 0 auto;"> #1 Receive EVEN </div>	<p>new key code receive mode is displayed</p>

SECTION 4: MIDI Operations

MIDI Codes Recognized by the FB-01

The FB-01 understands the following MIDI codes:

Name	Device Selection
Note Off	
Note On (or off with a velocity of 0)	
Controllers	
modulation wheel	when PMD = WHEEL
breath controller	when PMD = BREATH
foot controller	when PMD = FOOT
portamento time	
volume controller	
pan controller	
sustain pedal	
portamento pedal	
sostenuto pedal	
Program Change	
After Touch	when PMD = TOUCH
Pitch Bend	
System Exclusive	
Timing Clock	
Start	
Continue	
Stop	
Active Sensing	

NOTE:

In order to hear the effects of the modulation wheel, the breath controller, the foot controller, or after touch, the PMD (pitch modulation device) must be selected for each of the 8 instruments in the FB-01.

MIDI Data Dumps

What is a MIDI Bulk Data Dump on the FB-01?

A MIDI bulk data dump is a group of numbers that the FB-01 understands through MIDI. These numbers indicate either the contents of the configuration memory or the voice banks.

Devices Capable of Storing MIDI Bulk Data

- The Yamaha QX1 digital sequencer stores many MIDI bulk dumps on each 5.25" disk.
- The Yamaha CX5M with the TeleWord Enhancer Cartridge stores many MIDI bulk data dumps on 3.5" disk, data cartridge, or cassette tape.
- Many computers have software that allows you to load and save many MIDI bulk data dumps per disk.
- There are other devices that are capable of storing MIDI bulk data dumps directly to disk or to other storage device.

Why Use a MIDI Bulk Data Dump?

There are several reasons to use a MIDI bulk data dump:

- They are universal. You can use MIDI bulk data dumps to store your FB-01 voice data and configuration data along with any other MIDI devices that utilize MIDI bulk data dumps for data storage.
- They are versatile. Some sequencers are able to send new voices to the FB-01 without having to load all the voices separately. This gives you an unlimited number of voices to play while sequencing.
- They can be utilized by computers that show you the contents of the FB-01 in an easy to read format.

How to Manually Send Configurations and Voices from the FB-01

1. Press the **SYSTEM SET UP** button until "Dump V.BANK1" appears.
2. Use the **-1** and **+1** buttons to select the desired data you wish to send.
V.BANK1 = voice bank 1 (voices 1 ~ 48)
V.BANK2 = voice bank 2 (voices 1 ~ 48)
CONF.ME = configuration memory (configurations 1 ~ 16)
CONFIG = current configuration buffer
3. Press the **SYSTEM SET UP** button. The display will ask if you are sure.
4. Press the **+1** button if you wish to send the bulk data (or press any other button to cancel).

How to Manually Receive Configurations and Voices to the FB-01

Turn memory protection OFF:

- Press the **SYSTEM SETUP** button until "Protect ON" appears.
- Use the **-1** button to turn the memory protection OFF.

Set the system exclusive MIDI channel:

- Press the **SYSTEM SETUP** button until "System ch#" appears.
- Use the **-1** and **+1** buttons to select the desired system MIDI channel (usually channel 1).

The FB-01 is now ready to accept MIDI bulk data.

When data is received the FB-01 will display "dump/received !!." This provides verification that the FB-01 received the MIDI bulk data.

Voicing the FB-01

Creating new voices or modifying voices in the FB-01 requires a computer and software. Here are a few suggestions to help you find out about voicing the FB-01.

- Computers commonly used by musicians:
 - Yamaha CX5M
 - Apple II series and Macintosh series
 - IBM series (and compatibles)
 - Commodore series
 - Atari series

- Look for easy to use software:

Be selective when shopping for voicing software. Try out the software yourself and make sure it does everything you would like it to do. Look for easy to understand displays and easy methods of program control. Also, make sure that the manual that comes with the software is complete and easy to understand. This will definitely help you get the maximum enjoyment and power from your FB-01.

SECTION 5: Sample Applications

This section discusses the four configuration memories that are supplied by the factory in ROM as well as a few samples of how an FB-01 might be used in a MIDI system. While this is just scratching the surface of the capabilities of the FB-01, it is a good starting point.

Factory Supplied Configurations Configuration Memory Number 17

Configuration number 17 is named "single". It is used to play up to eight notes of a single instrument, controlled from MIDI channel #1.

Configuration memory number 17 is set up as follows:

CONFIGURATION NUMBER		17	NAME		single					
VOICE FUNCTION COMBINE		ON	KEY-CODE NUMBER RECEIVE MODE				ALL			
INSTRUMENT NUMBER			1	2	3	4	5	6	7	8
INST ASSIGN	MIDI CHANNEL	1	2	3	4	5	6	7	8	
	NUMBER OF NOTES	8	0	0	0	0	0	0	0	
	KEY-CODE NUMBER LIMIT/L	C-2	C-2	C-2	C-2	C-2	C-2	C-2	C-2	
	KEY-CODE NUMBER LIMIT/H	G8	G8	G8	G8	G8	G8	G8	G8	
VOICE SELECT	VOICE NUMBER	1	1	1	1	1	1	1	1	
	VOICE BANK NUMBER	3	3	3	3	3	3	3	3	
INST FUNCTION	OUTPUT LEVEL	127	127	127	127	127	127	127	127	
	OCTAVE TRANSPOSE	0	0	0	0	0	0	0	0	
	DETUNE	0	0	0	0	0	0	0	0	
	STEREO	L+R	L+R	L+R	L+R	L+R	L+R	L+R	L+R	
	LFO ENABLE	ON	ON	ON	ON	ON	ON	ON	ON	
VOICE FUNCTION	PITCHBENDER RANGE	2	2	2	2	2	2	2	2	
	PORTAMENTO TIME	0	0	0	0	0	0	0	0	
	POLY/MONO	POLY	POLY	POLY	POLY	POLY	POLY	POLY	POLY	
	INPUT CONTROLLER (PMD)	WHEEL	WHEEL	WHEEL	WHEEL	WHEEL	WHEEL	WHEEL	WHEEL	

Figure 18: Configuration Memory Number 17

Configuration Memory Number 18

Configuration number 18 is named "mono 8". It is used to play a single note of each of 8 instruments, with each instrument on a different MIDI channel.

Configuration memory number 18 is set up as follows:

CONFIGURATION NUMBER	18	NAME	mono 8							
VOICE FUNCTION COMBINE	ON	KEY-CODE NUMBER RECEIVE MODE	ALL							
INSTRUMENT NUMBER		1	2	3	4	5	6	7	8	
INST	MIDI CHANNEL	1	2	3	4	5	6	7	8	
	NUMBER OF NOTES	1	1	1	1	1	1	1	1	
ASSIGN	KEY-CODE NUMBER LIMIT/L	C-2	C-2	C-2	C-2	C-2	C-2	C-2	C-2	
	KEY-CODE NUMBER LIMIT/H	G8	G8	G8	G8	G8	G8	G8	G8	
VOICE SELECT	VOICE NUMBER	1	2	3	4	5	6	7	8	
	VOICE BANK NUMBER	3	3	3	3	3	3	3	3	
INST FUNCTION	OUTPUT LEVEL	127	127	127	127	127	127	127	127	
	OCTAVE TRANSPOSE	0	0	0	0	0	0	0	0	
	DETUNE	0	0	0	0	0	0	0	0	
	STEREO	L+R	L+R	L+R	L+R	L+R	L+R	L+R	L+R	
	LFO ENABLE	ON	ON	ON	ON	ON	ON	ON	ON	
VOICE FUNCTION	PITCHBENDER RANGE	2	4	4	7	2	5	2	2	
	PORTAMENTO TIME	0	0	0	0	0	0	0	0	
	POLY/MONO	POLY	POLY	POLY	POLY	POLY	POLY	POLY	POLY	
	INPUT CONTROLLER (PMD)	WHEEL	WHEEL	WHEEL	WHEEL	WHEEL	WHEEL	WHEEL	OFF	

Figure 19: Configuration Memory Number 18

Configuration Memory Number 19

Configuration number 19 is named "dual". It is used to play a "stacked" sound which is created by two instruments, controlled on 1 MIDI channel with the same MIDI zone. Up to 4 notes can be played at a time.

Configuration memory number 19 is set up as follows:

CONFIGURATION NUMBER		19	NAME		dual					
VOICE FUNCTION COMBINE		ON	KEY-CODE NUMBER RECEIVE MODE				ALL			
INSTRUMENT NUMBER			1	2	3	4	5	6	7	8
INST ASSIGN	MIDI CHANNEL	1	1	3	4	5	6	7	8	
	NUMBER OF NOTES	4	4	0	0	0	0	0	0	
	KEY-CODE NUMBER LIMIT/L	C-2	C-2	C-2	C-2	C-2	C-2	C-2	C-2	
	KEY-CODE NUMBER LIMIT/H	G8	G8	G8	G8	G8	G8	G8	G8	
VOICE SELECT	VOICE NUMBER	1	1	1	1	1	1	1	1	
	VOICE BANK NUMBER	3	3	3	3	3	3	3	3	
INST FUNCTION	OUTPUT LEVEL	127	127	127	127	127	127	127	127	
	OCTAVE TRANSPOSE	0	0	0	0	0	0	0	0	
	DETUNE	0	+4	0	0	0	0	0	0	
	STEREO	L+R	L+R	L+R	L+R	L+R	L+R	L+R	L+R	
	LFO ENABLE	ON	ON	ON	ON	ON	ON	ON	ON	
VOICE FUNCTION	PITCHBENDER RANGE	2	2	2	2	2	2	2	2	
	PORTAMENTO TIME	0	0	0	0	0	0	0	0	
	POLY/MONO	POLY	POLY	POLY	POLY	POLY	POLY	POLY	POLY	
	INPUT CONTROLLER (PMD)	WHEEL	WHEEL	WHEEL	WHEEL	WHEEL	WHEEL	WHEEL	WHEEL	

Figure 20: Configuration Memory Number 19

Configuration Memory Number 20

Configuration number 20 is named "split". It is used to play a single keyboard split with one instrument of four notes on the upper half of the keyboard and 4 notes of another instrument on the lower half of the keyboard.

Configuration memory number 20 is set up as follows:

CONFIGURATION NUMBER	20	NAME	split							
VOICE FUNCTION COMBINE	ON	KEY-CODE NUMBER RECEIVE MODE	ALL							
INSTRUMENT NUMBER		1	2	3	4	5	6	7	8	
MIDI CHANNEL		1	1	3	4	5	6	7	8	
INST NUMBER OF NOTES		4	4	0	0	0	0	0	0	
ASSIGN KEY-CODE NUMBER LIMIT/L		C3	C-2	C-2	C-2	C-2	C-2	C-2	C-2	
KEY-CODE NUMBER LIMIT/H		G8	B2	G8	G8	G8	G8	G8	G8	
VOICE SELECT VOICE NUMBER		1	1	1	1	1	1	1	1	
VOICE BANK NUMBER		3	3	3	3	3	3	3	3	
INST FUNCTION OUTPUT LEVEL		127	127	127	127	127	127	127	127	
OCTAVE TRANSPOSE		0	0	0	0	0	0	0	0	
DETUNE		0	0	0	0	0	0	0	0	
STEREO		L+R	L+R	L+R	L+R	L+R	L+R	L+R	L+R	
LFO ENABLE		ON	ON	ON	ON	ON	ON	ON	ON	
VOICE FUNCTION PITCHBENDER RANGE		2	2	2	2	2	2	2	2	
PORTAMENTO TIME		0	0	0	0	0	0	0	0	
POLY/MONO		POLY	POLY	POLY	POLY	POLY	POLY	POLY	POLY	
INPUT CONTROLLER (PMD)		WHEEL	WHEEL	WHEEL	WHEEL	WHEEL	WHEEL	WHEEL	WHEEL	

Figure 21: Configuration Memory Number 20

Sample MIDI System Set Ups

Application 1 — KX88 Controller with an FB-01

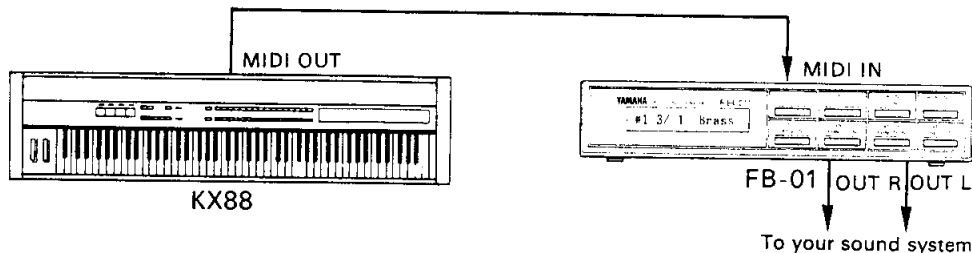

Figure 22: KX88 Controller with an FB-01

NOTE:

Another keyboard may be substituted for the KX88. Suitable substitutions include a DX7, a KX76/KX5/KX1 or any other keyboard capable of transmitting MIDI information. For the best results, a velocity sensitive/pressure sensitive keyboard is recommended.

Using the KX88 controller with the FB-01, you can play the following:

- up to 8 notes of a single voice
 - using 1 instrument, 1 MIDI channel, 8 note allocation, 1 voice
- a two voice keyboard split with definable split point and note allocation
 - using 2 instruments, 2 MIDI channels, variable # of notes, 2 voices
 - or
 - using 2 instruments with different MIDI zones, 1 MIDI channel, variable # of notes, 2 voices
- up to 8 MIDI zones with definable zones and note allocation per zone
 - using 1 or more instruments, 1 MIDI channel, variable # of notes, different or overlapping note ranges for each instrument
 - or
 - using 1 or more instruments, 2 MIDI channels, variable # of notes, different or overlapping note ranges for each instrument, and using the KX88 in "dual mode"
- a two voice stack with four notes per layer of sound
 - using 2 instruments, 2 MIDI channels, 4 notes each instrument, 2 voices
 - or
 - using 2 instruments with the same MIDI zone, 1 MIDI channel, variable # of notes (4 per instrument is recommended), 2 voices
- an eight voice layer of sound from a single note.
 - using 8 instruments, 1 MIDI channel, 1 note each instrument, 8 voices

Notes when using a DX7 or DX9 as a controller:

In order to be able to switch voice numbers through MIDI from a DX7 or a DX9 the "MIDI SYS INFO" function value should be set to "UNAVAIL".

Notes when using a DX21, DX27 or DX100 as a controller:

In order to be able to switch voice numbers through MIDI from a DX21, DX27 or DX100, function values for "MIDI CH INFO" should be set to "ON" and "MIDI SYS INFO" should be set to "OFF".

Application 2 — KX88 Controller with an FB-01 and a QX21 Sequencer

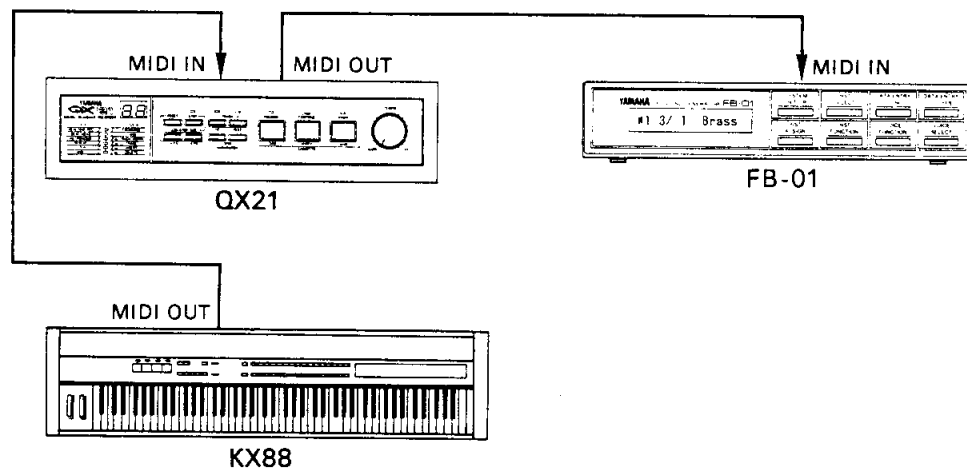

Figure 23: KX88 Controller with an FB-01 and a QX21 Sequencer

NOTE:

Other sequencers may be substituted for the QX21. Suitable substitutions include the QX1, QX7, CX5M computer with appropriate software (FM Composer or MIDI Recorder), or another MIDI sequencer.

The QX21 sequencer will record up to 16 MIDI channels of sequence data. The multiple MIDI channel capabilities of the FB-01 are well suited for use with the QX21. With one FB-01, up to 8 independent musical parts and voices may be played by the QX21. With two FB-01s, up to 16 independent musical parts and voices may be played. The number of available notes per instrument can be doubled by using the Keycode Receive Mode ODD/EVEN parameter.

When using the QX21 sequencer, you may find sequencing easier if the "RECORDING MIDI CHANNEL" (JOB A-6) is set to "ALL". You may also play instruments of the FB-01 in real-time with a sequence if the "ECHO BACK" (JOB C-4) is set to "ON". For further information on the QX21, consult your QX21 Owner's Manual.

Application 3 — Using the FB-01 with a CX5M and MIDI Recorder (with any MIDI Keyboard)

This application takes advantage of the FB-01's multi-MIDI channel capabilities while using the CX5M as a sequencer. Note that in this example, all eight of the FB-01's instruments will only play a single note. If you wish to assign some of the instruments more notes, simply assign some of the instruments zero notes and add notes to make some of the instruments polyphonic.

Connections:

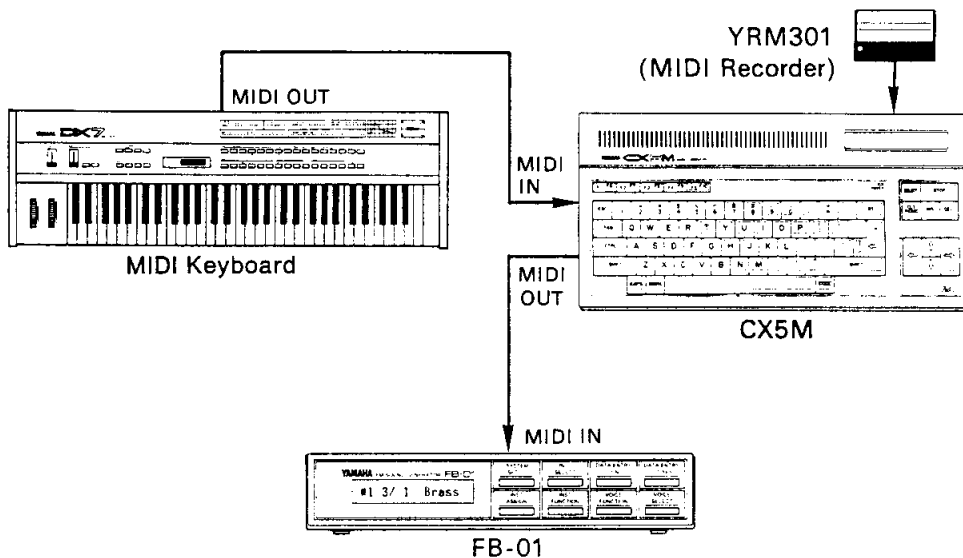

Figure 24: FB-01 with a CX5M and MIDI Recorder with any MIDI Keyboard

Set Up:

1. Turn MIDI Recorder MIDI Merge ON.
2. Call up the mono 8 configuration (18) on the FB-01 (see page 23).
3. On the MIDI keyboard, set the MIDI out channel number to 1.
4. Play/select the voice you wish to record first on the FB-01.
5. Record the track.
6. Set the MIDI out channel number to 2, and repeat steps 4 and 5.
7. Merge the two tracks that you have sequenced into a single one (be sure to consult your MIDI Recorder Owner's Manual on how to merge tracks together).
8. Repeat the above steps for MIDI channels 3 through 8, merging and saving your sequence as necessary.

Application 4 — Using the FB-01 with a DX100/DX27/DX21

This application shows how to make use of the FB-01's multi-MIDI zoning capabilities. This allows you to tell the FB-01 to assign different areas of the DX100/DX27/DX21 keyboard to play different instruments in the FB-01. Be sure you adjust the following MIDI zone areas to suit your needs.

Connections:

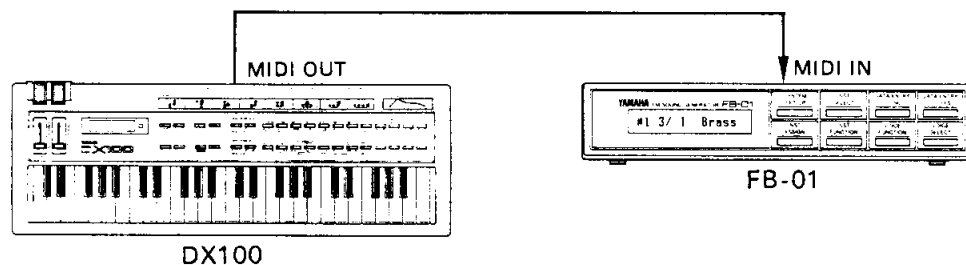

Figure 25: FB-01 with a DX100/DX27/DX21

Set Up:

1. Call up the split configuration (19) on the FB-01 (see page 23).
2. Make all 8 instruments play a single note by reducing instruments 1 and 2 to play 1 note, and distribute the remaining six notes to instruments 3 through 8.
3. Set each instrument to play the desired voice (use the VOICE SELECT button).
4. Set the zone of instrument 1 by pressing INST ASSIGN until Limit/L appears in the front panel display. Use the -1/+1 keys to adjust the note number to the desired lowest note you would like instrument 1 to play.
5. Set the upper limit of the zone of instrument 1 by pressing INST ASSIGN again (Limit/H appears in the front panel display). Use the -1/+1 keys to adjust the note number to the desired highest note you would like instrument 1 to play.
6. Repeat the above steps for all eight instruments.
7. Now you have eight independent splits you can play from your DX100/DX27/DX21 synthesizer.

Application 5 — Using the FB-01 with a DX100 and a QX21 Sequencer

This application takes advantage of the FB-01's multi-MIDI channel capabilities while using the QX21 as a sequencer. Note that in this example, all eight of the FB-01's instruments will only play a single note. If you wish to assign some of the instruments more notes, simply assign zero notes to some of the instruments and add notes to make some of the instruments polyphonic.

Connections:

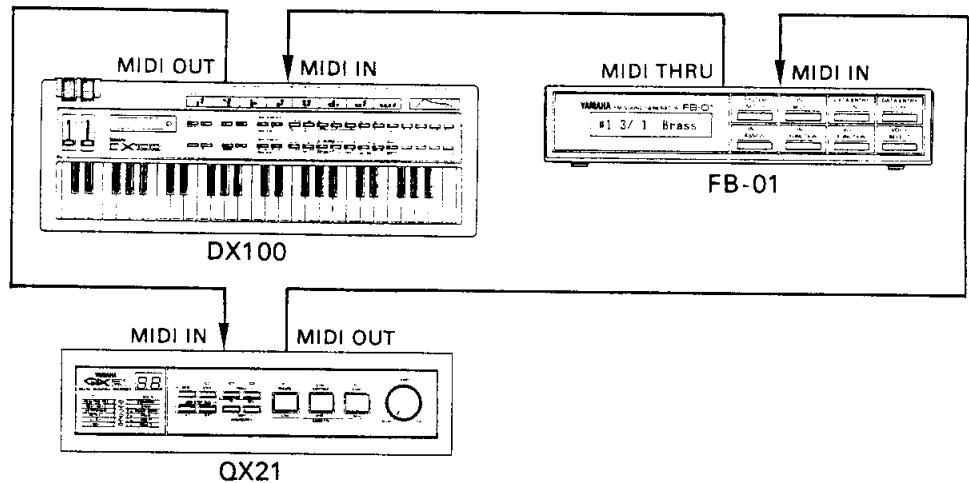

Figure 26: FB-01 with a DX100 and a QX21 Sequencer

Set Up:

1. Set the DX100 receive on MIDI channel 9 so that it can be played as a ninth track by the QX21 (the transmit channel will be changed later for each track).
2. Turn the QX21 MIDI echo back ON so that you can hear sound from the FB-01 while you record.
3. Call up the mono 8 configuration (18) on the FB-01 (see page 23).
4. On the DX100, set the MIDI out channel number to 1.
5. Play/select the voice you wish to record first on the FB-01.
6. Record the track.
7. Set the MIDI out channel number to 2, and repeat steps 4 and 5.
8. Merge the two tracks that you have sequenced into a single one (Consult your QX21 Owner's Manual if you are unsure of how to merge tracks together.).
9. Repeat the above steps for MIDI channels 3 through 8 (plus channel 9 on the DX100), merging and saving your sequence as necessary.

Application 6 — Using two FB-01s with a KX5 and a QX21 Sequencer

This application takes full advantage of the FB-01's multi-MIDI channel capabilities while using the QX21 as a sequencer. In this example, we will assign each of the 16 total FB-01 instruments to a unique MIDI channel. All 16 of the instruments will only play a single note. This example also takes advantage of the FB-01's velocity sensitivity ability. If you wish to assign some of the instruments more notes, simply assign some of the instruments zero notes and add notes to make some of the instruments polyphonic.

Connections:

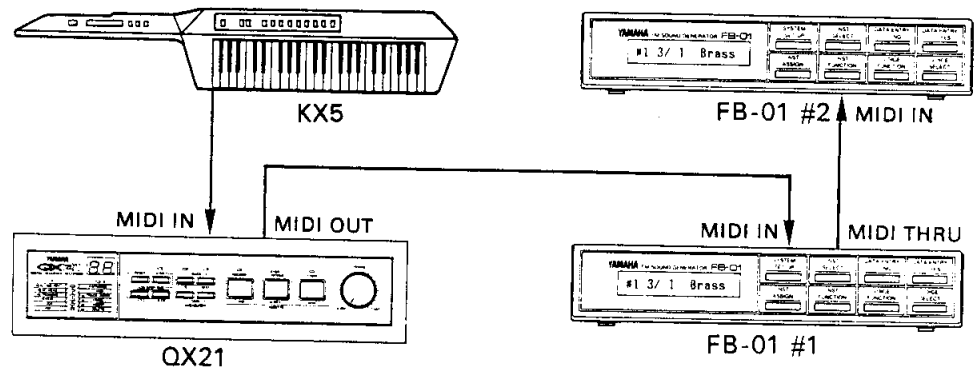

Figure 27: Two FB-01s with a KX5 Remote Controller and a QX21 Sequencer

Set Up:

1. Turn the QX21 MIDI echo back ON so that you can hear sound from the FB-01 while you record (note since the KX5 only transmits on MIDI channels 1 and 2, you will have to channelize its output in the QX21 and hear the correct MIDI channel played on sequence playback).
2. Call up the mono 8 configuration (18) on the FB-01 #1 and #2 (see page 23).
3. On the FB-01 #2, set its instruments 1 through 8 to MIDI channels 9 through 16. To do this use the INST ASSIGN button.
4. Play/select the voice you wish to record first on the FB-01.
5. Record the track (be sure to set the proper MIDI channel on the QX21 (1 through 16)).
6. Record your next track (be sure to set the proper MIDI channel on the QX21).
7. Merge the two tracks that you have sequenced into a single track (consult your QX21 Owner's Manual if you are unsure of how to use the merge function).
8. Repeat the above steps for each instrument in each FB-01.

Application 7 — Using the FB-01 with a KX76 & QX1 Sequencer

This application takes advantage of the FB-01's multi-MIDI channel capabilities while using the QX1 as a sequencer. Note that in this example, four of the FB-01's instruments will play only two notes. If you wish to assign some of the instruments more notes, simply assign some of the instruments zero notes and add notes to the other instruments.

Connections:

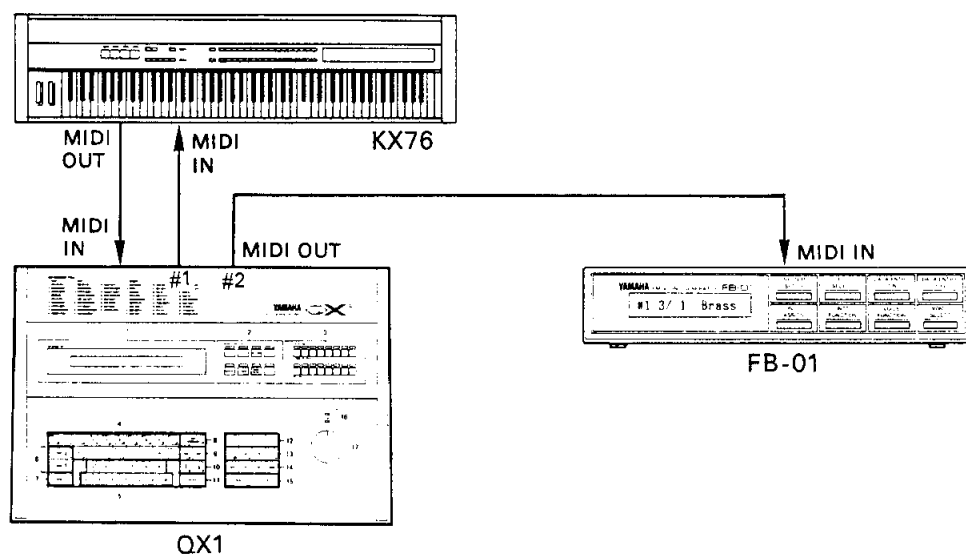

Figure 28: FB-01 with a KX76 and a QX1 Sequencer

Set Up:

1. Call up the mono 8 configuration (18) on the FB-01 (see page 23).
2. Now set the FB-01 to play four instruments with 2 notes on each. Press INST ASSIGN until Notes is displayed. Press INST SELECT until instrument #5 is shown. Press -1 to reduce the number of notes to zero. Repeat this for instruments 6 through 8.
3. Now add the notes you took away from instrument 5 through 8 to instruments 1 through 4. Press +1 to add a note, press INST SELECT to go to the next instrument.
4. Set the QX1 to send the first 4 tracks out the MIDI out connector 1 (job command 03: output assign).
5. Set the QX1 to record on MIDI channel 1 (job command 04: receive condition).
6. On the KX76, set the MIDI out channel number to 1.
7. Play/select the voice you wish to record first on the FB-01.
8. Record the track.
9. Set the MIDI out channel number to 2 and set the QX1 recording channel to 2 and repeat the above steps for each of the four tracks.

Application 8 — Using the FB-01 with a Clavinova or PSR-70

This application shows how to make use of the FB-01's multi-MIDI zoning capabilities. This allows you to tell the FB-01 to assign different areas of the Clavinova or PSR-70 keyboard to play different instruments on the FB-01. Be sure you set the following MIDI zone areas to suit your needs.

Connections:

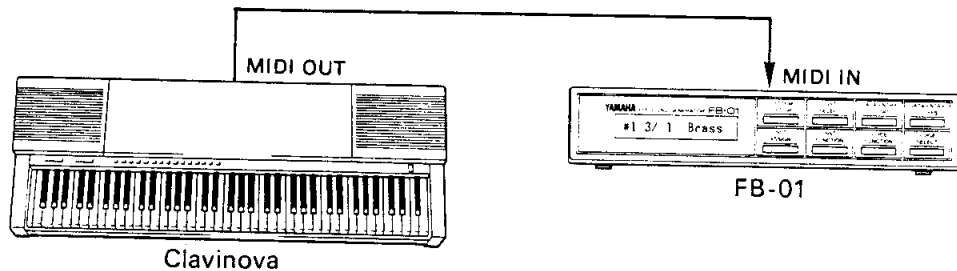

Figure 29: FB-01 with a Clavinova or PSR-70

Set Up:

1. Call up the split configuration (19) on the FB-01 (see page 23).
2. Make all 8 instruments play a single note by reducing instruments 1 and 2 to play 1 note, and assign the remaining six to instruments 3 through 8.
3. Set each instrument to play the desired voice (use the VOICE SELECT button).
4. Set the zone of instrument 1 by pressing INST SELECT until Limit/L appears in the front panel display. Use the -1/+1 keys to adjust the note number to the desired lowest note you would like instrument 1 to play.
5. Set the upper limit of the zone of instrument 1 by pressing INST SELECT again (Limit/H appears in the front panel display). Use the -1/+1 keys to adjust the note number to the desired highest note you would like instrument 1 to play.
6. Repeat the above steps for all eight instruments.
7. Set your MIDI keyboard to transmit on MIDI channel 1 if necessary.
8. Now you have eight independent splits you can play from your Clavinova or PSR-70 synthesizer.

Application 9 — Using the FB-01 with any MIDI Keyboard

This application shows how to make use of the FB-01's multi-MIDI zoning capabilities. This allows you to tell the FB-01 to assign different areas of any MIDI keyboard to play different instruments on the FB-01. Be sure you set the following MIDI zone areas to suit your needs.

Connections:

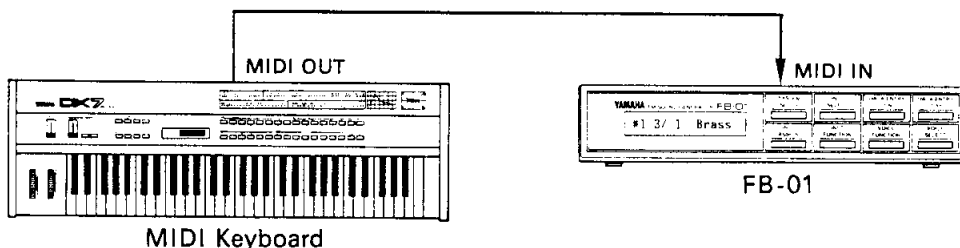

Figure 30: FB-01 with any MIDI Keyboard

Set Up:

1. Call up the split configuration (19) on the FB-01 (see page 23).
2. Make all 8 instruments play a single note by reducing instruments 1 and 2 to play 1 note, and assign the remaining six to instruments 3 through 8.
3. Set each instrument to play the desired voice (use the VOICE SELECT button).
4. Set the zone of instrument 1 by pressing INST SELECT until Limit/L appears in the front panel display. Use the -1/+1 keys to adjust the note number to the desired lowest note you would like instrument 1 to play.
5. Set the upper limit of the zone of instrument 1 by pressing INST SELECT again (Limit/H appears in the front panel display). Use the -1/+1 keys to adjust the note number to the desired highest note you would like instrument 1 to play.
6. Repeat the above steps for all eight instruments.
7. Set your MIDI keyboard to transmit on MIDI channel 1.
8. Now you have eight independent splits you can play from your MIDI keyboard.

SECTION 6:
Specifications

Hardware

Sound Generator		FM tone generator (4 operators, 8 algorithms)
Polyphony		Up to 8 notes
Voices		Maximum of 8
Internal Memory		240 ROM voices 96 RAM voices 4 ROM configurations 16 RAM configurations
Panel Switches	mode selection:	SYSTEM SET UP INST ASSIGN INST FUNCTION VOICE FUNCTION VOICE SELECT
	instrument selection:	INST SELECT
	data entry:	+1 / YES -1 / NO
Display		16 digit, light emitting
Connection Terminals	audio output: MIDI:	left, right (1/4") IN, OUT, THRU
Power Supply	U.S. & Canadian Models:	120V, 50/60 Hz
	General Models:	220 ~ 240V, 50 Hz
Power Consumption		9 watts
Dimensions		218 (w) x 48 (h) x 274 (d) mm
Weight		2.1 kg
Environmental Limits		operating temperature 0 ~ 35 (°C) operating humidity 20 ~ 80%
Accessories		MIDI cable

Note: Specifications are subject to change without notice.

MIDI

Throughout this part of the manual there are three numbering schemes used: binary, decimal, and hexadecimal.

binary looks like this	%00011111
decimal looks like this	31
hexadecimal looks like this	\$1F

All of the variables used to describe bits in certain data bytes are listed below.

- c = control number
- d = data
- e = check sum
- f = fraction
- h = high byte count
- i = instrument number (0 ~ 7)
- k = key number
- l = low byte count
- n = MIDI channel number (0 ~ 15)
- p = parameter number or program number
- s = system exclusive channel number (0 ~ 15)
- v = value
- w = general variable (defined where used)
- x = general variable (defined where used)
- y = general variable (defined where used)
- z = general variable (defined where used)

MIDI Data Recognized (MIDI IN)

This section is subdivided into three sections: Standard MIDI Codes, System Exclusive MIDI Codes, and Other MIDI Codes. Standard MIDI Codes lists all of the general MIDI codes that the FB-01 understands (note off, note on/off, control change, program change, after touch, and pitch bend). System Exclusive MIDI Codes lists all of the system exclusive MIDI events that the FB-01 recognizes (dump requests, data dumps, parameter changes, operation requests, and event lists). Other MIDI Codes lists all of the single byte, real-time codes that the FB-01 recognizes (MIDI real time clock, start, continue, stop, and active sensing).

Standard MIDI Codes

This list includes the following MIDI events: note off, note on/off, control change, program change, after touch, and pitch bend.

Note OFF

Status	%1000nnnn	n = MIDI channel number
Note Number	%0kkkkkkk	k = 0 (note C-2) ~ 127 (note G8) The actual sound range of the FB-01 is D#-1 ~ D7 (depending on transpose), but the FB-01 will automatically adjust.
Key Velocity	%0vvvvvvv	v = release velocity is ignored

Note ON/OFF

Status	%1001nnnn	n = MIDI channel number
Note Number	%0kkkkkkk	k = 0 (note C-2) ~ 127 (note G8) The actual sound range of the FB-01 is D#-1 ~ D7 (depending on transpose), but the FB-01 will automatically adjust.
Key Velocity	%0vvvvvvv	v = 0 means note OFF v = 1 ~ 127 means note ON with the velocity of v

Control Change

Status	%1011nnnn	n = MIDI channel number
Control No.	%0ccccccc	c = Controller Number
Control Value	%0vvvvvvv	v = control value

Controller #	Controller Name	Control Value
\$01	modulation wheel (pmd)	v = 0 ~ 127
\$02	breath controller (pmd)	v = 0 ~ 127
\$04	foot controller (pmd)	v = 0 ~ 127
\$05	portamento time	v = 0 ~ 127
\$07	volume controller	v = 0 ~ 127
\$0A	pan controller	v = 0, 64, 127
\$40	sustain pedal	v = 0, 127
\$41	portamento pedal	v = 0, 127
\$42	sostenuto pedal	v = 0, 127
\$7B	all notes OFF	v = 0
\$7E	mono mode ON	v = 1
\$7F	poly mode ON	v = 0

Program Change

Status	%1100nnnn	n = MIDI channel number
Program Number	%0ppppppp	p = program number

After Touch

Status	%1101nnnn	n = MIDI channel number
Pressure	%0vvvvvvv	v = pressure (PMD must be set to TOUCH)

Pitch Bend

Status	%1110nnnn	n = MIDI channel number
Value (LSB)	%0yyyyyyy	
Value (MSB)	%0xxxxxxx	x, y = pitch bend amount

System Exclusive MIDI Codes

This list includes the following MIDI system exclusive events: dump requests, data dump formats (voice banks, configurations, and instrument voice data), parameter changes, operation requests, and event lists.

Dump Requests

There are seven dump requests that the FB-01 recognizes: voice bank 0, voice bank x, current configuration buffer, configuration memory xx, all configuration memory, identification number, and instrument i voice data.

voice bank 0	\$F0 \$43 \$2s \$0C \$F7
voice bank x (x = 0 ~ 6)	\$F0 \$43 \$75 \$0s \$20 \$00 \$0x \$F7
current configuration buffer	\$F0 \$43 \$75 \$0s \$20 \$01 \$00 \$F7
configuration memory xx (xx = 0 ~ 19)	\$F0 \$43 \$75 \$0s \$20 \$02 \$xx \$F7
all configuration memory	\$F0 \$43 \$75 \$0s \$20 \$03 \$00 \$F7
identification number	\$F0 \$43 \$75 \$0s \$20 \$04 \$00 \$F7
instrument i voice data (i = 8 ~ 15)	\$F0 \$43 \$75 \$0s \$2i \$00 \$00 \$F7

* S = System Channel/number
i = Instrument number + 8

(%00101iii)

Recognized Dumps

There are seven dumps that the FB-01 recognizes: voice bank 0, voice bank x, current configuration buffer, configuration memory xx, all configuration memories, identification number, and instrument i voice data. Voice data must be sent as two byte pairs since the high bit is set on certain data bytes. Configuration data must be sent as single bytes since the high bit is never set in its data format. Their format is given in the MIDI Data Transmitted (MIDI OUT) description under Transmitted Dumps.

Parameter Changes

There are three different tables of parameters that can be changed: configuration parameter changes, voice data parameter changes, and system functions.

Parameter Table 1 (Configuration Parameters)

There are two ways to change the following table of parameters. The first way is by the MIDI channel only (all instruments on the MIDI channel will change) and the second is by the SYSTEM channel plus the instrument number.

Parameter #	Value Ranges	Name
\$00 ~ \$0F		(see instrument definition block, p.52)
\$10	0 ~ 127	LFO speed
\$11	0 ~ 127	amd
\$12	0 ~ 127	pmd
\$13	0 ~ 3	wave form
\$14	0, 1	LFO load enable
\$15	0, 1	sync (to note/on) LFO
\$16	0 ~ 3	ams
\$17	0 ~ 7	pms
\$18 ~ 3F		Reserved area

Parameter Change by MIDI Channel (Table 1)

Status	\$F0	
I.D.	\$43	
Sub-status/Ch.	%0001nnnn	n = MIDI channel number
Parameter Group	\$15	
Parameter	%000ppppp	p = \$00 ~ \$17
Data	%0ddddddd	d = data
End of Exclusive	\$F7	

Parameter Change by System Channel + Instrument Number (Table 1)

Status	\$F0	
I.D.	\$43	
Sub-status	\$75	
System Channel	%0000ssss	s = System channel number
Instrument	%00011iii	i = instrument number i = 0 ~ 7 (inst #1 ~ inst #8)
Parameter	%000ppppp	p = \$00 ~ \$17
Data	%0ddddddd	d = data
End of Exclusive	\$F7	

Parameter Table 2 (Voice Data Parameters)

Parameter No.	Values	Name
\$40 ~ \$7F		(see voice data table block, p.52) Parameter # = offset number of voice data + \$40

Parameter Change by MIDI Channel (Table 2)

Status	\$F0	
I.D.	\$43	
Sub-status/Ch.	%0001nnnn	n = MIDI channel number
Parameter Group	\$15	
Parameter	%0ppppppp	p = \$40 ~ \$7F
Data Low	%0000yyyy	
Data High	%0000xxxx	x+y = data
End of Exclusive	\$F7	

Parameter Change by System Channel + Instrument Number (Table 2)

Status	\$F0	
I.D.	\$43	
Sub-status	\$75	
Channel	%0000ssss	s = System channel number
Instrument	%00011 i i i	i = instrument number i = 0 ~ 7 (inst #1 ~ inst #8)
Parameter	%0ppppppp	p = \$40 ~ \$7F
Data Low	%0000yyyy	
Data High	%0000xxxx	x+y = * data $\left(\begin{array}{l} * \text{ data Low 4bit} \rightarrow \text{yyyy} \\ \text{Hign 4bit} \rightarrow \text{xxxx} \end{array} \right)$
End of Exclusive	\$F7	

Parameter Table 3 (System Functions)

Parameter #	Values	Name
\$08 ~ \$0D		(see configuration data block, p.51 ~ 52)
\$20	0 ~ 15	system channel number
\$21	0, 1	memory protect
\$22	0 ~ 19	configuration number
\$24	0 ~ 127	master output level

Parameter Change by MIDI channel (Table 3)

Status	\$F0	
I.D.	\$43	
Sub-status	\$75	
System message	%0000ssss	s = System channel number
	\$10	
Parameter	%0ppppppp	p = \$00 ~ \$24
Data	%0ddddddd	d = data
End of Exclusive	\$F7	

System Exclusive Event Lists

Event List

Status	\$F0
I.D.	\$43
Sub-status	\$75
	\$70

(events)
 (events)
 (events)

...
End of Exclusive	\$F7	

Event: Note OFF with Fraction

Status	%0000nnnn	n = MIDI channel number
Note Number	%0kkkkkkk	k = 0 (note C-2) ~ 127 (note G8) The actual sound range of the FB-01 is D#-1 ~ D7 (depending on transpose), but the FB-01 will automatically adjust.
Key Fraction	%0ffffff	f = 100 cent range

Event: Note ON/OFF with Fraction

Status	%0001nnnn	n = MIDI channel number
Note Number	%0kkkkkkk	k = 0 (note C-2) ~ 127 (note G8) The actual sound range of the FB-01 is D#-1 ~ D7 (depending on transpose), but the FB-01 will automatically adjust.
Key Fraction	%0ffffff	f = 100 cent range
Key Velocity	%0vvvvvvv	v = 0 means note OFF v = 1 ~ 127 means note ON with the velocity of v

Event: Note ON/OFF with Fraction and Duration

Status	%0010nnnn	n = MIDI channel number
Note Number	%0kkkkkkk	k = 0 (note C-2) ~ 127 (note G8) The actual sound range of the FB-01 is D#-1 ~ D7 (depending on transpose), but the FB-01 will automatically adjust.
Key Fraction	%0ffffff	f = 100 cent range
Key Velocity	%0vvvvvvv	v = 0 means note OFF v = 1 ~ 127 means note ON with the velocity of v
Duration Low	%0yyyyyyyy	

Duration High %0xxxxxxx x+y = duration

Event: Control Change

Status %0011nnnn n = MIDI channel number
Control No. %0ccccccc c = control number
Control Value %0vvvvvvv v = control value

Event: Program Change

Status %0100nnnn n = MIDI channel number
Program Number %0ppppppp p = program number

Event: After Touch

Status %0101nnnn n = MIDI channel number
Pressure %0vvvvvvv v = pressure (PMD must be set to TOUCH)

Event: Pitch Bend

Status %0110nnnn n = MIDI channel number
Value (LSB) %0yyyyyyy
Value (MSB) %0xxxxxxx x, y = pitch bend amount

Event: Parameter Change (Instrument) Single Byte

Status %0111nnnn n = MIDI channel number
Param. Change %00pppppp p = single byte parameter change (see p.47)
Value %0ddddddd d = parameter change data

Event: Parameter Change (Instrument) Double Byte

Status %0111nnnn n = MIDI channel number
Param. Change %00pppppp p = double byte parameter change (see p.48)
Value Low %0000yyyy
Value High %0000xxxx x x 16 + y = parameter change data

System Exclusive Data Format Tables

Configuration Data Format \$00 ~ \$9F

\$00 ~ \$07 ASCII name
\$08 %0000000x voice function combine mode (1=ON)

\$09	%0xxxxxxx	LFO speed (1 ~ 127)
\$0A	%0xxxxxxx	amd (1 ~ 127)
\$0B	%0xxxxxxx	pmd (1 ~ 127)
\$0C	%000000xx	LFO waveform (0 ~ 3)
\$0D	%000000xx	KC# reception mode (0=all, 1=even, 2=odd)
\$0E ~ \$1F		reserved
\$20 ~ \$2F		instrument #0 definition block
\$30 ~ \$3F		instrument #1 definition block
\$40 ~ \$4F		instrument #2 definition block
\$50 ~ \$5F		instrument #3 definition block
\$60 ~ \$6F		instrument #4 definition block
\$70 ~ \$7F		instrument #5 definition block
\$80 ~ \$8F		instrument #6 definition block
\$90 ~ \$9F		instrument #7 definition block

Instrument Definition Block \$00 ~ \$0F

\$00	%0000xxxx	# of notes (0 ~ 8)
\$01	%0000xxxx	midi channel (0 ~ 15)
\$02	%0xxxxxxx	KC# limit/H (0 ~ 127)
\$03	%0xxxxxxx	KC# limit/L (0 ~ 127)
\$04	%00000xxx	voice bank # (0 ~ 6)
\$05	%0xxxxxxx	voice # (0 ~ 47)
\$06	%0xxxxxxx	detune (0 ~ 127)
\$07	%00000xxx	octave transpose (0 ~ 4) 0 = -2 octaves, 4 = +2 octaves
\$08	%0xxxxxxx	output level (0 ~ 127)
\$09	%0xxxxxxx	pan (0 ~ 127) 0 = left, 64 = left+right, 127 = right
\$0A	%0000000x	LFO enable (0, 1) 0 = pms and ams are disabled 1 = use pms and ams from voice data
\$0B	%0xxxxxxx	portamento time (0 ~ 127)
\$0C	%0000xxxx	pitchbender range (0 ~ 12)
\$0D	%0000000x	mono/poly mode (0, 1) 0=poly, 1=mono
\$0E	%00000xxx	input controller assignment to pmd (0 ~ 4) 0=not assigned 1=after touch 2=modulation wheel 3=breath controller 4=foot controller
\$0F		reserved

Voice Data Format \$000 ~ \$C1F

\$000 ~ \$007	name
\$008 ~ \$01F	reserved
\$020 ~ \$05F	voice #0 data
\$060 ~ \$09F	voice #1 data
...	...

...
 ...
 \$BA0 ~ \$BDF
 \$BE0 ~ \$C1F

...
 ...
 voice #46 data
 voice #47 data

Voice Data Format \$00 ~ \$3F

\$00 ~ \$06		name
\$07	%xxxxxxxx	user's code (any number)
\$08	%xxxxxxxx	LFO speed
\$09	%yyyyyyyy	x=enable to load lfo data y=amd
\$0A	%yyyyyyyy	x=sync lfo (at note on) mode y=pmd
\$0B	%0wxyz000	w=enable operator #3 x=enable operator #2 y=enable operator #1 z=enable operator #0
\$0C	%00xxxxyy	x=feedback level y=algorithm
\$0D	%0xxx00yy	x=pms y=ams
\$0E	%0xx00000	x=LFO wave form
\$0F	%xxxxxxxx	x=transpose 2's complement, 100 cents resolution
\$10 ~ \$17		operator#0 block
\$18 ~ \$1F		operator#1 block
\$20 ~ \$27		operator#2 block
\$28 ~ \$2F		operator#3 block
\$30 ~ \$39		reserved
\$3A	%yyyyyyyy	x=voice function, poly/mono mode y=voice function, portamento time
\$3B	%0xxxxyyyy	x=voice function, input controller assignment to PMD y=voice function, pitchbender range
\$3C ~ \$3F		reserved

Operator Block

\$00	%0xxxxxxxx	TL
\$01	%yyyy0000	x=keyboard level scaling type (bit#0) y=velocity sensitivity (TL)
\$02	%xxxxyyyy	x=keyboard level scaling depth y=adjust for TL
\$03	%yyyyzzzz	x=keyboard level scaling type (bit#1 of 2 bit type indicator, see byte \$01) y=DT1 z=multiple
\$04	%xx0yyyyy	x=keyboard rate scaling depth y=AR
\$05	%xyzzzzzz	x= 0=modulator, disable/AM 1=carrier, enable/AM

\$06	%xx0yyyyy	y= velocity sensitivity (AR) z=D1R x=DT2 y=D2R
\$07	%xxxxyyyy	x=SL y=RR

Other MIDI Codes

These MIDI bytes are single byte messages that the FB-01 recognizes.

MIDI Real Time Clock

Status \$F8 clock is used for counting the duration while processing system exclusive event lists

Start

Status \$FA MIDI start (for display indicator)

Continue

Status \$FC MIDI continue (for display indicator)

Stop

Status \$FB MIDI stop (for display indicator)

Active Sensing

Status \$FE When this code is received, sensing begins. If neither status nor data is received over an interval of 300 milliseconds, the FB-01 will stop audio output and clear the key assigner.

MIDI Data Transmitted (MIDI OUT)

System Exclusive MIDI Codes

There are two main types of system exclusives that the FB-01 will transmit: data dumps and handshake data.

Transmitted Dumps

There are seven dumps that the FB-01 sends out: voice bank 0, voice bank x, current configuration buffer, configuration memory xx, all configuration memory, identification number, and instrument i voice data. Voice data must be sent to two byte pairs since the high bit is set on certain data bytes. Configuration data must be sent as single bytes since the high bit is never set in its data format. The format is as follows:

voice bank 0

\$F0
\$43
\$0s
\$0C

(49 packets)

%0000000h	h = byte count high	(number of bytes in packet)
%01111111	l = byte count low	
%0000yyyy	y = byte data low	(byte #1)
%0000xxxx	x = byte data high	
%0000yyyy	y = byte data low	(byte #2)
%0000xxxx	x = byte data high	
...		(byte #x)
%0eeeeeee	e = check sum (2's complement of sum)	

\$F7

voice bank x (x = 0 ~ 6)

\$F0
\$43
\$75
\$0s
\$00
\$00
\$0x

(49 packets)

%0000000h	h = byte count high	(number of bytes in packet)
%01111111	l = byte count low	
%0000yyyy	y = byte data low	(byte #1)
%0000xxxx	x = byte data high	
%0000yyyy	y = byte data low	(byte #2)
%0000xxxx	x = byte data high	
...		(byte #x)
%0eeeeeee	e = check sum (2's complement of sum)	

\$F7

current configuration buffer

\$F0
\$43
\$75
\$0s
\$00
\$01
\$00

(1 packet)

%0000000h	h = byte count high	(number of bytes in packet)
-----------	---------------------	-----------------------------

%01111111	l = byte count low	
%0ddddddd	d = data byte	(byte #1)
%0ddddddd	d = data byte	(byte #2)
...		(byte #x)
%0eeeeeeee	e = check sum (2's complement of sum of the data bytes)	

\$F7

configuration memory xx (xx = 0 ~ 19)

\$F0
\$43
\$75
\$0s
\$00
\$02
\$xx

(1 packet)

%0000000h	h = byte count high	(number of bytes in packet)
%01111111	l = byte count low	
%0ddddddd	d = data byte	(byte #1)
%0ddddddd	d = data byte	(byte #2)
...		(byte #x)
%0eeeeeeee	e = check sum (2's complement of sum of the data bytes)	

\$F7

all configuration memory

\$F0
\$43
\$75
\$0s
\$00
\$03
\$00

(16 packets)

%0000000h	h = byte count high	(number of bytes in packet)
%01111111	l = byte count low	
%0ddddddd	d = data byte	(byte #1)
%0ddddddd	d = data byte	(byte #2)
...		(byte #x)
%0eeeeeeee	e = check sum (2's complement of sum of the data bytes)	

\$F7

identification number

\$F0
\$43
\$75
\$0s

\$00
\$04
\$00

(1 packet)

%0000000h	h = byte count high	(number of bytes in packet)
%01111111	l = byte count low	
%0ddddddd	d = data byte	(byte #1)
%0ddddddd	d = data byte	(byte #2)
...		(byte #x)
%0eeeeeee	e = check sum (2's complement of sum of the data bytes)	

\$F7

instrument i voice data

\$F0
\$43
\$75
\$0s
%00001 i i i
\$00
\$00

(1 packet)

%0000000h	h = byte count high	(number of bytes in packet)
%01111111	l = byte count low	
%0000yyyy	y = byte data low	(byte #1)
%0000xxxx	x = byte data high	
%0000yyyy	y = byte data low	(byte #2)
%0000xxxx	x = byte data high	
...		(byte #x)
%0eeeeeee	e = check sum (2's complement of sum)	

\$F7

Handshake MIDI Codes

There are three handshake messages that the FB-01 may transmit: ACK, NAK, and cancel. ACK indicates success. NAK indicates a check sum error, a data short error, a framing error, or an overrun error. Cancel indicates a memory protection error, and invalid number error (out of range or ROM area for save).

\$F0 \$43 \$6s \$0x \$F7

x = \$02	indicates ACK
x = \$03	indicates NAK
x = \$04	indicates cancel

Function ...	Transmitted	Recognized	Remarks
Basic Default	x	1-16	memorized
Channel Changed	x	1-16	
Mode Default	x	3, 4	memorized
Messages Altered	*****	MONO (M=1), POLY 3, 4	
Note Number : True voice	x *****	0 - 127 0 - 127	
Velocity Note ON	x	o v=1-127	
Note OFF	x	x	
After Key's	x	x	PMD
Touch Ch's	x	o	
Pitch Bender	x	o	
Control Change	x	o (1)	PMD
		o (2)	PMD
		o (4)	PMD
		o (5)	portamento time
		o (7)	volume
		o (10)	PAN (L, L+R, R)
		o (64)	sustain
		o (65)	partamento
	o (66)	sostenuto	
Prog Change : True #	x *****	o 0-47	
System Exclusive	o	o	advanced message
System : Song pos	x	x	
: Song sel	x	x	
Common : Tune	x	x	
System :Clock	x	o	
Real Time :Commands	x	o	
Aux :Local ON/OFF	x	x	
:All Notes OFF	x	123, 126(M=1), 127	
Mes- :Active Sense	x	o	
sages:Reset	x	x	
Notes	FB-01 has 8 instruments.		

Mode 1 : OMNI ON, POLY Mode 2 : OMNI ON, MONO o : Yes
 Mode 3 : OMNI OFF, POLY Mode 4 : OMNI OFF, MONO x : No

List of Figures

SECTION 1: SETTING UP THE FB-01

Figure 1:	FB-01 Rear Panel	1
Figure 2:	Connecting the FB-01 to a Stereo Mixer or Amplifier.....	2
Figure 3:	Connecting the FB-01 to a Guitar Type Amplifier	2
Figure 4:	Connecting the FB-01 to a Home Stereo System	3
Figure 5:	Connecting the FB-01 to a Portable Stereo.....	3
Figure 6:	The FB-01 Memory Battery Switch	4

SECTION 3: OPERATING INSTRUCTIONS

Figure 7:	Definition of Terms	8
Figure 8:	Front Panel Key Chart w/FB-01 Front Panel.....	9
Figure 9:	Voice Select Key View.....	10
Figure 10:	Voice Function Key View.....	12
Figure 11:	PMD Devices.....	14
Figure 12:	Inst Assign and Inst Select Key View.....	15
Figure 13:	MIDI Note Ranges.....	18
Figure 14:	Instrument Function Key View	19
Figure 15:	System Set Up Key View	22
Figure 16:	Memory Protection	23
Figure 17:	System Channel Number	25

SECTION 5: SAMPLE APPLICATIONS

Figure 18:	Configuration Memory Number 17.....	30
Figure 19:	Configuration Memory Number 18.....	31
Figure 20:	Configuration Memory Number 19.....	32
Figure 21:	Configuration Memory Number 20.....	33
Figure 22:	KX88 Controller with an FB-01	34
Figure 23:	KX88 Controller with an FB-01 and a QX21 Sequencer.....	35
Figure 24:	FB-01 with a CX5M and MIDI Recorder with any MIDI Keyboard	36
Figure 25:	FB-01 with a DX100/DX27/DX21	37
Figure 26:	FB-01 with a DX100 and a QX21 Sequencer.....	38
Figure 27:	Two FB-01s with a KX5 remote Controller and a QX21 Sequencer.....	39
Figure 28:	FB-01 with a KX76 and a QX1 Sequencer.....	40
Figure 29:	FB-01 with a Clavinova or PSR-70	41
Figure 30:	FB-01 with any MIDI Keyboard	42

Index

AC Power Requirements	1	LFO ON/OFF Toggle	21
Active Sensing	54	LFO Rate and Waveform	21
Aftertouch	14	List of Factory Supplied Voices	7
Audio Connections	2	Low Note Limit	17, 18
Bank	8	Memory Battery Switch	4
Bank Selection	6	Memory Protection	23
Breath Controller	14	MIDI Channel Set up	16
Bulk Data dump devices	28	MIDI Channel Basics	15
Bulk Data dumps	25	MIDI Codes Recognized	27
Combine Mode	23	MIDI Codes, Handshake	57
Configuration	8	MIDI Connections	1
Configuration Data Format	51, 52	MIDI Data, Transmitted	54 ~ 57
Configuration Memory Select	5	MIDI Operations	27 ~ 29
Configuration Number 17 (single)	30	MIDI Zone	15
Configuration Number 18 (mono 8)	31	Modulation Wheel	14
Configuration Number 19 (dual)	32	MONO mode	13, 14
Configuration Number 20 (split)	33	Note Limit — High	15
Continue	54	Note Limit — Low	15 ~ 17
Data Entry/Modify Keys	9	Note Off	27
Data Format, Configuration Data	51, 52	Note On	27
Data Format, Instrument Definition Block	52	Number of Notes Allocation	16, 17
Data Format, Operator Block	53	Octave Transposition	19, 20
Data Format, Voice Data	53	Operator Block Data Format	53
Detuning an Instrument	20	Output Level	19
Dump Requests	47	Panning, Stereo	20, 21
Dumps Recognized	47	Parameter Change by MIDI Channel	48
Event Lists	50, 51	Parameter Change by MIDI Channel (System)	49
Factory Voices	7	Parameter Change by MIDI Channel (Voice)	48
FB-01 Rear Panel View	1	Parameter Change by MIDI Chnl + Inst Number	48
Fingered Portamento	14	Parameter Change by MIDI Chnl + Inst Number (Voice)	48
Foot Controller	14	Parameter Changes	47
Front Panel Display	4	Parameter Table	47
Front Panel Keys	9	Pitch Bender Range	13
Global Menu Keys	8	Pitch Modulation Device	14, 15
Handshake MIDI Codes	57	PMD	14, 15
Hardware Specifications	44	POLY mode	13, 14
High Note Limit	15	Portamento Time	13
Inst Assign Key	15 ~ 18	Portamento, Fingered	14
Inst Function Key	19 ~ 21	Power On Procedure	5
Inst Select Key	15	Rack Mounting	4
Instrument	8	RAM Voice Numbers	12
Instrument Definition Block Data format	52	RAM Voices	6
Instrument Detuning	20	Real Time Clock	54
Instrument Menu Keys	9	Saving a Configuration	24
Keycode Number Receive Mode	26		
KX88 Controller w/FB-01	34		
KX88 Controller w/FB-01 and QX21	35		
LFO	21		

Saving a Voice	10, 11
Specifications	43 ~ 57
Specifications, hardware	43
Standard MIDI Codes	45, 46
Start	54
Stereo Panning	20, 21
Stop	54
Storing a Configuration	24
Storing a Voice	10, 11
Sys Ex Event After Touch	51
Sys Ex Event Control Change	51
Sys Ex Event Note OFF w/Fraction	50
Sys Ex Event Note ON/OFF w/Fraction	50
Sys Ex Event Note ON/OFF w/Fraction and Duration	50
Sys Ex Event Parameter Change	51
Sys Ex Event Pitch Bend	51
Sys Ex Event Program Change	51

System Channel Number	25
System Exclusive Event Lists	50, 51
System Exclusive MIDI Codes	47
System Set Up Key	22
Terms and Conventions Used	8
Transmitted MIDI Bulk Dumps	54 ~ 57
Transposition, by octave	19
Tuning	24, 25
Voice	8
Voice Bank Selection	6
Voice Data Format	52, 53
Voice Function Key	12 ~ 15
Voice Memory Select	6, 10
Voice Menu Keys	8
Voice Select Key	10 ~ 12
Voice Storing	10, 11
Voicing the FB-01	29

SPECIAL MESSAGE SECTION

ELECTROMAGNETIC INTERFERENCE (RFI): Your Yamaha Digital Musical Instrument Product has been type tested and found to comply with all applicable regulations. However, if it is installed in the immediate proximity of other electronic devices, some form of interference may occur. For additional RFI information see FCC information section located in this manual.

IMPORTANT NOTICE: This product has been tested and approved by independent safety testing laboratories in order that you may be sure that when it is properly installed and used in its normal and customary manner, all foreseeable risks have been eliminated. **DO NOT** modify this unit or commission others to do so unless specifically authorized by Yamaha. Product performance and/or safety standards may be diminished. Claims filed under the expressed warranty may be denied if the unit is/has been modified. Implied warranties may also be affected.

SPECIFICATIONS SUBJECT TO CHANGE: The information contained in this manual is believed to be correct at the time of printing. Yamaha reserves the right to change or modify specifications at any time without notice or obligation to update existing units.

NOTICE: Service charges incurred due to a lack of knowledge relating to how a function or effect works (when the unit is operating as designed), are not covered by the manufacturer's warranty. Please study this manual carefully before requesting service.

STATIC ELECTRICITY CAUTION: Some Yamaha Digital Musical Instrument products have modules that plug into the unit to perform various functions. The contents of a plug-in module can be altered/damaged by static electricity discharges. Static electricity build-ups are more likely to occur during cold winter months (or in areas with very dry climates) when the natural humidity is low. To avoid possible damage to the plug-in module, touch any metal object (a metal desk lamp, a door knob, etc.) before handling the module. If static electricity is a problem in your area, you may want to have your carpet treated with a substance that reduces static electricity build-up. See your local carpet retailer for professional advice that relates to your specific situation.

Model _____

Serial No. _____

Purchase Date _____

This information on safety is provided to comply with U.S.A. laws, but should be observed by users in all countries.

IMPORTANT SAFETY AND INSTALLATION INSTRUCTIONS

INFORMATION RELATING TO POSSIBLE PERSONAL INJURY, ELECTRIC SHOCK AND FIRE HAZARD POSSIBILITIES HAS BEEN INCLUDED IN THIS LIST.

WARNING — When using electronic products, basic precautions should always be followed, including the following:

1. Read all Safety and Installation Instructions, Supplemental Marking and Special Message Section data, and any applicable assembly instructions BEFORE using this product.
2. Check unit weight specifications BEFORE you attempt to move this product.
3. Main power supply verification. Yamaha Digital Musical Instrument products are manufactured specifically for use with the main supply voltage used in the area where they are to be sold. The main supply voltage required by these products is printed on the name plate. For name plate location please refer to the graphic in the Special Message section. If any doubt exists please contact the nearest Yamaha Digital Musical Instrument retailer.
4. Some Yamaha Digital Musical Instrument products utilize external power supplies or adapters. Do NOT connect products of this type to any power supply or adapter other than the type described in the owners manual or as marked on the unit.
5. This product may be equipped with a plug having three prongs or a polarized line plug (one blade wider than the other). If you are unable to insert the plug into the outlet, contact an electrician to have the obsolete outlet replaced. Do NOT defeat the safety purpose of the plug. Yamaha products not having three prong or polarized line plugs incorporate construction methods and designs that do not require line plug polarization.
6. **WARNING** — Do NOT place objects on the power cord or place the unit in a position where any one could walk on, trip over, or roll anything over cords of any kind. An improper installation of this type can create the possibility of a fire hazard and/or personal injury.
7. Environment: Your Yamaha Digital Musical Instrument should be installed away from heat sources such as heat registers and/or other products that produce heat.
8. Ventilation: This product should be installed or positioned in a way that its placement or location does not interfere with proper ventilation.
9. Yamaha Digital Musical Instrument products are frequently incorporated into "Systems" which are assembled on carts, stands or in racks. Utilize only those carts, stands, or racks that have been designed for this purpose and observe all safety precautions supplied with the products. Pay special attention to cautions that relate to proper assembly, heavier units being mounted at the lower levels, load limits, moving instructions, maximum usable height and ventilation.
10. Yamaha Digital Musical Instrument products, either alone or in combination with amplification, headphones, or speakers, may be capable of producing sound levels that could cause permanent hearing loss. Do NOT operate at high volume levels or at a level that is uncomfortable. If you experience any discomfort, ringing in the ears, or suspect any hearing loss, you should consult an audiologist.
11. Do NOT use this product near water or in wet environments. For example, near a swimming pool, spa, in the rain, or in a wet basement.
12. Care should be taken so that objects do not fall, and liquids are not spilled into the enclosure.
13. Yamaha Digital Musical Instrument products should be serviced by a qualified service person when:
 - a. The power supply/power adapter cord or plug has been damaged; or
 - b. Objects have fallen, or liquid has been spilled into the products; or
 - c. The unit has been exposed to rain; or
 - d. The product does not operate, exhibits a marked change in performance; or
 - e. The product has been dropped, or the enclosure of the product has been damaged.
14. When not in use, always turn your Yamaha Digital Musical Instrument equipment "OFF". The power supply cord should be unplugged from the outlet when the equipment is to be left unused for a long period of time. NOTE: In this case, some units may lose some user programmed data. Factory programmed memories will not be affected.
15. Electromagnetic Interference (RFI). Yamaha Digital Musical Instruments utilize digital (high frequency pulse) technology that may adversely affect Radio/TV reception. Please read FCC Information (inside front cover) for additional information.
16. Do NOT attempt to service this product beyond that described in the user maintenance section of the owners manual. All other servicing should be referred to qualified service personnel.

PLEASE KEEP THIS MANUAL
FOR FUTURE REFERENCE!

YAMAHA

YAMAHA CORPORATION
P.O.Box 1, Hamamatsu, Japan

OMD-195M-1 88 04 2.2 R2 CR Printed