

**DIGITAL WAVE SYNTHESIZER
AND SEQUENCER**

MUSICIAN'S MANUAL

Version 2.0

FRONT PANE

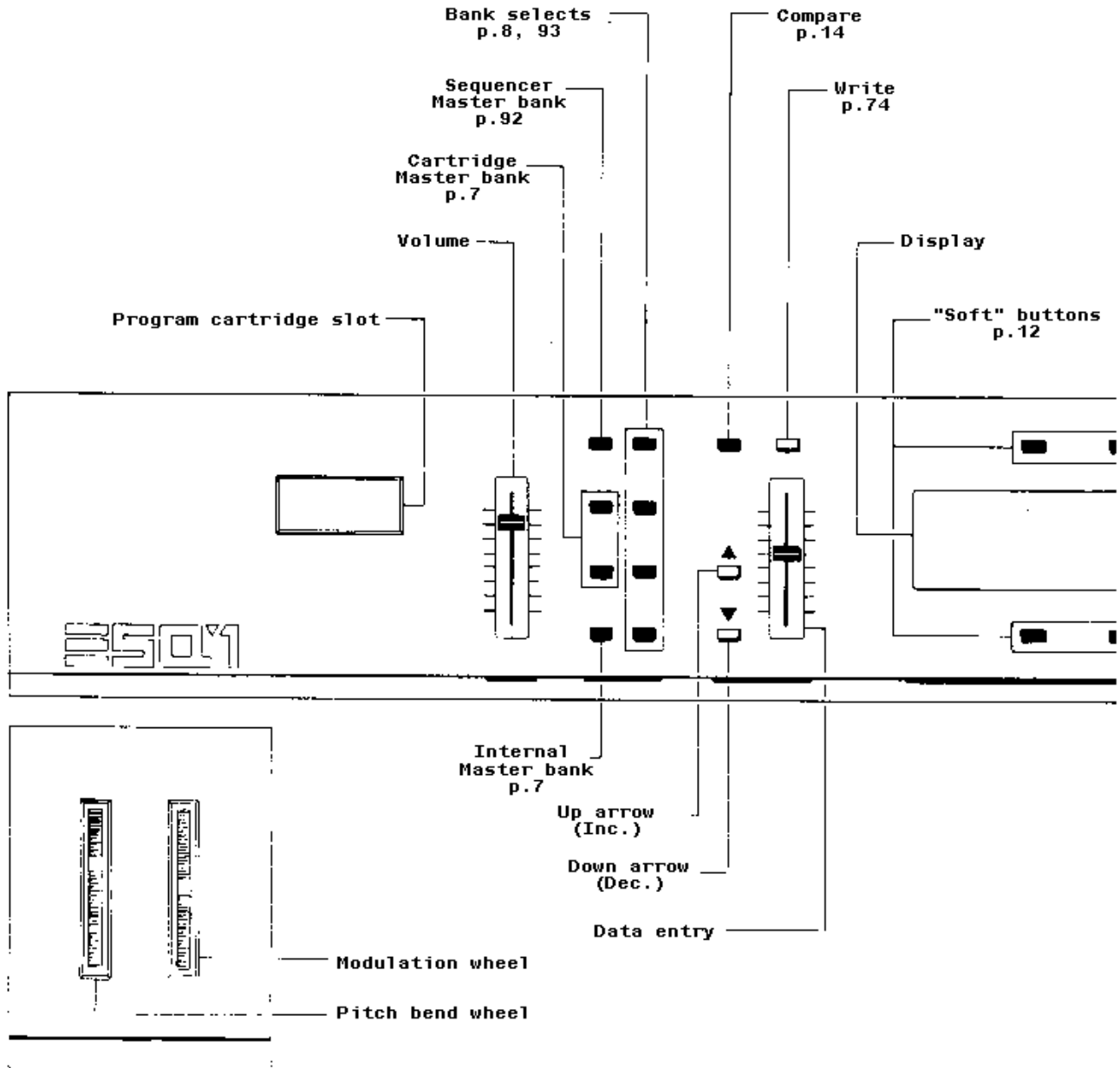

ESQ1™

DIGITAL WAVE SYNTHESIZER

L CONTROLS

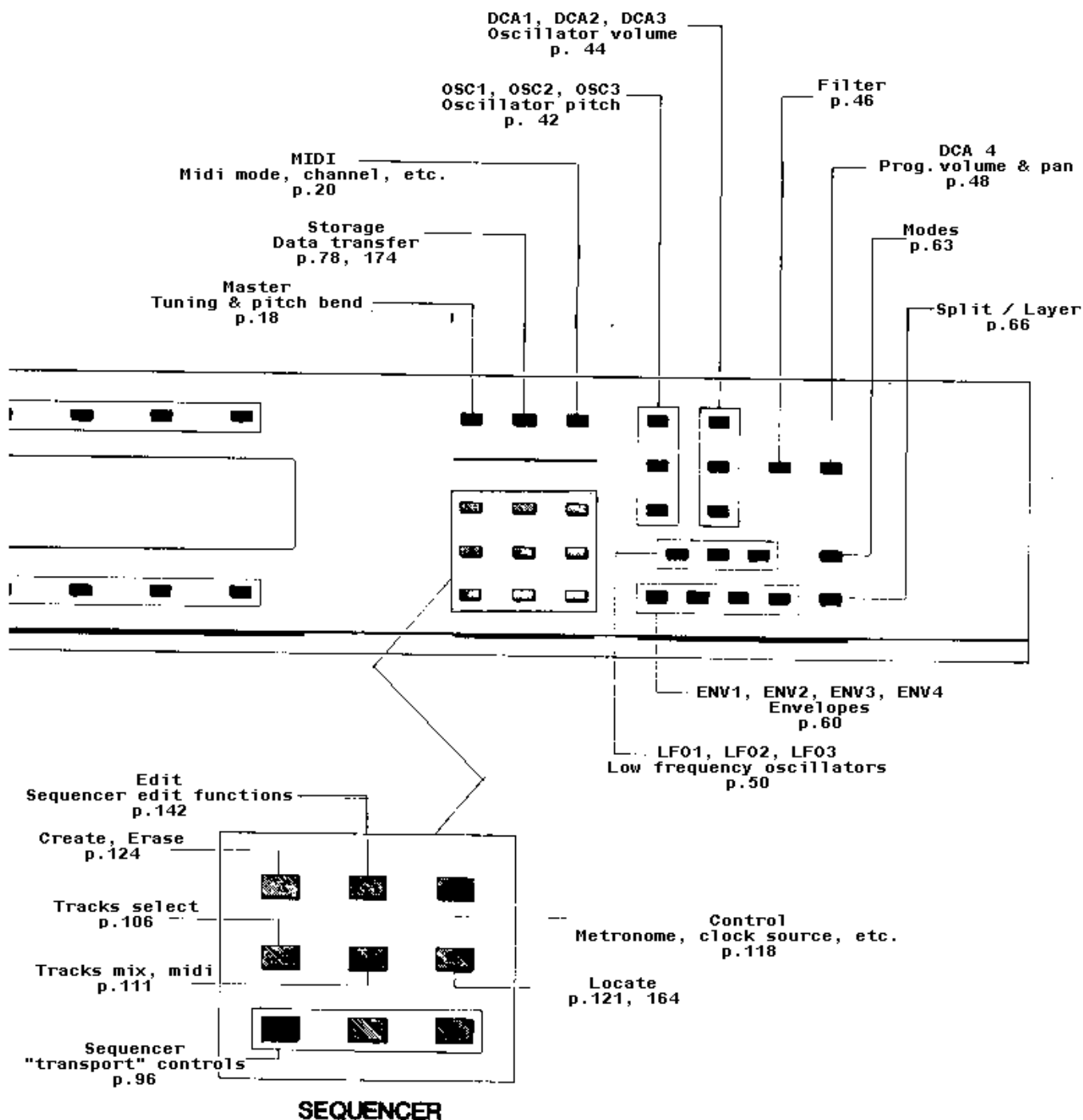

Credits:

Written, Designed,
and Illustrated by: Bill McCutcheon

Additional Illustration by: Dominic Benedict

Cover Design by: Gilligan Designs, Inc.

Copyright © 1986
ENSONIQ® Corp
263 Great Valley Parkway
Malvern, PA 19355

All Rights Reserved

This Manual is copyrighted and all rights are reserved by **ENSONIQ Corp.** This document may not, in whole or in part, be copied, photocopied, reproduced, translated or reduced to any electronic medium or machine readable form without prior written consent from **ENSONIQ Corp.** The **ESQ 1** software/firmware is copyrighted and all rights are reserved by **ENSONIQ Corp.**

Although every effort has been made to insure the accuracy of the text and illustrations in this Manual, no guarantee is made or implied in this regard.

IMPORTANT:

"This equipment generates and uses radio frequency energy and if not installed and used properly, that is, in strict accordance with the manufacturer's instructions, may cause interference to radio and television reception. It has been tested and found to comply with the limits for a Class B computing device in accordance with the specifications in Subpart J of Part 15 of FCC rules, which are designed to provide reasonable protection against such interference in a residential installation. However, there is no guarantee that interference will not occur in a particular installation. If this equipment does cause interference to radio or television reception, which can be determined by turning the equipment off and on, the user is encouraged to try to correct the interference by one or more of the following measures."

- * reorient the receiving antenna
- * relocate the instrument with respect to the receiver
- * move the instrument away from the receiver
- * plug the instrument into a different outlet so that the instrument and receiver are on different branch circuits

"If necessary, the user should consult the dealer or an experienced radio/television technician for additional suggestions. The user may find the following booklet prepared by the Federal Communications Commission helpful: 'How to Identify and Resolve Radio-TV Interference Problems.' This booklet is available from the U.S. Government printing Office, Washington, D.C. 20402 Stock No. 004-000-00345-4."

In order to fulfill warranty requirements the ESQ 1 should be serviced only by an authorized ENSONIQ Repair Station.

The ENSONIQ serial number label must appear on the outside of the Unit or the ENSONIQ warranty is void.

*ENSONIQ, ESQ 1, Mirage and MASOS are trademarks of ENSONIQ Corp.

Table of Contents

PART 1 -- THE SYNTHESIZER

SECTION 1 -- The Basic Stuff

1	INTRODUCTION
3	GETTING STARTED
3	Power
3	Amplification
3	Basic Connections
4	Rear Panel Connections
6	About the Programmer
7	GETTING AT THE SOUNDS
7	Master Banks
7	Internal Memory
7	Cartridge Memory
8	Bank Select Buttons
8	Selecting a Program -- Internal
9	Selecting a Program -- Cartridge
10	GENERAL INFO
10	Cartridge Insertion and Removal
10	Battery Maintenance
10	Available Options

SECTION 2 -- PROGRAMMING THE ESQ 1

12	ABOUT PAGE-DRIVEN PARAMETRIC PROGRAMMING
12	Parametric Programming
12	Pages
12	"Soft" Buttons
13	USING THE PROGRAMMER
13	Changing a Parameter
14	"C" -- Change/Compare
15	Edit Buffer
15	Bailing out
16	Active and Inactive Buttons
17	"GLOBAL" PAGES
18	MASTER -- Master Tuning, Velocity Sensitivity, and Bend Range
20	MIDI -- MIDI Parameters
25	WAVEFORMS
25	Digital Waveform Memory
25	What's a Waveform?
26	Synthetic Waveforms
26	Sampled and Multisampled Waveforms

26	Names
27	Selecting a Waveform
27	Check Them Out
28	The Waveforms
31	MODULATORS
31	About Modulation
31	Selecting a Modulator
32	Modulation Depth
33	Modulation Sources
36	USING MODULATORS
36	Modulating Oscillator Volume
38	Negative Modulation
38	Modulating the Filter Cutoff Frequency
39	Limits of Modulation
40	VOICE ARCHITECTURE -- AN ESQ 1 VOICE
41	PROGRAMMING PAGES
42	OSC 1-3 -- Oscillator Pitch Page
44	DCA 1-3 -- Oscillator Volume Page
46	FILT -- Filter Page
48	DCA 4 -- Final Volume Page
50	LFO 1-3 -- Low-Frequency Oscillator Page
53	Understanding The Envelopes
60	ENV 1-4 -- Envelope Page
63	MODE -- Modes Page
66	Split/Layer -- Splitting the keyboard and Layering Programs
71	PROGRAMMING CONVENTIONS

SECTION 3 -- Saving and Storage of Programs

74	WRITE Page
74	Saving a New Program to Memory
77	Copying an Existing Program to Another Location
78	STORAGE Page
78	Cartridge -- Bank Copy
79	Transferring Internal Programs to Cartridge
79	Transferring Cartridge Programs to Internal Memory
80	Tape Storage
80	A "Decent" Tape Deck
81	Tape Connections
81	Saving all Internal Programs to Tape
82	Verifying Internal Programs Saved to Tape
83	Loading all Programs from Tape
84	MIDI Transfer of Programs
84	MIDI Connections
84	Sending All Internal Programs via MIDI to Another ESQ 1
85	Sending One Program via MIDI to Another ESQ 1

PART 2 -- THE SEQUENCER

SECTION 4 -- About the Sequencer

89	OVERVIEW
89	The MIDI Connection
89	Digital Sequencing
91	THE ESQ 1 SYSTEM
92	SEQUENCES AND SONGS
92	What is a Sequence?
92	Sequencer Master Bank
93	Sequencer Banks
93	Selecting a Sequence
94	Selecting a Song
94	Playing Sequences
94	Playing Songs
95	Sequencer Expander Cartridge
96	"TRANSPORT" CONTROLS
96	Record, Stop/Cont, and Play Buttons
97	Sequencer Foot Switch
97	SEQUENCER STATES
99	UTILITY PAGES
99	KEEP FIRST TRACK
99	PLAY/KEEP Page
100	SAVE CHANGES TO OLD SEQUENCE
101	Altering a Sequence in SONG Mode

SECTION 5 -- TRACKS and Other Sequencer Pages

105	ABOUT TRACKS
105	In General
105	When Recording Tracks
106	TRACKS SELECT Page
106	Selecting a Track
107	Changing the Program on a Track
108	"Unselecting" a Track -- Straight Synth Mode
109	Track Displays
111	Mix/MIDI Page
111	Sub-pages
112	Track Status
113	Track Program Number
114	Track Mix
114	Muting a Track
115	Track MIDI Channel

117	OTHER SEQUENCER PAGES
118	CONTROL Page -- Metronome, Clock Source and Loop Switch
121	LOCATE Page -- Sequence Location and Auto-Locate Controls
124	CREATE/ERASE Page
124	Creating a New Sequence
125	Creating a New Song
126	Erasing a Sequence
127	Erasing a Song
127	Erasing All Sequencer Data

SECTION 6 --Recording a Sequence

130	SEQUENCING ON THE ESQ 1
130	Recording The First Track
131	Using the Foot Switch to Define Sequence Length
132	Recording Other Tracks
132	Recording from the Beginning of a Track
133	Overdub Mode -- "Punching In"
135	"Punching Out"
135	MIDI SEQUENCING ON THE ESQ 1
135	Basic MIDI Connections
136	Using a MIDI Thru Box
136	MIDI MODE AND CHANNEL -- Destination Instruments
137	TRACK CONFIGURATION
138	Recording the First Track
138	Other Tracks

SECTION 7 -- Sequencer EDIT Functions

142	EDIT PAGE -- Editing Tracks, Sequences, Songs and Single Events
143	EDITING A TRACK
144	TRACK EDIT Functions
144	Transpose
144	Remove Controllers
145	Quantize
147	Erase
148	Merge
149	Copy
150	STEP -- TRACK STEP EDITING
150	STEP Edit Page

153	Using the Step Edit Mode
155	EDITING A SEQUENCE
155	SEQUENCE EDIT Functions
155	Append
156	Change Length
157	Copy
158	Making a Sequence Template
159	SONG MODE
160	SONG EDIT Page
162	Making a Song
164	LOCATE -- Song LOCATE Page

SECTION 8 -- Sequencer Applications

168	Using the ESQ 1 with a Drum Machine
168	To Sync a Drum Machine to the ESQ 1
168	To Sync the ESQ 1 to a Drum Machine
168	To Sequence a Drum Machine from a Track of the ESQ 1
169	Song Position Pointers
169	MIDI Song Selects
170	Tape Sync
170	Recording a Sync Track
170	Syncing the ESQ 1 to a Recorded Sync Track
171	The ESQ 1 as a System Controller

SECTION 9 -- Storage of Sequencer Data

174	STORAGE Page
174	Tape Storage of Sequencer Data
174	Tape Connections
175	Saving all Sequencer Memory to Tape
176	Saving One Sequence to Tape
176	Verifying Sequencer Data Saved to Tape
178	Loading All Sequencer Memory from Tape
179	Loading One Sequence from Tape
180	MIDI Transfer of Sequencer Data
180	MIDI Connections
180	Sending All Sequencer Memory via MIDI to a Mirage
181	Loading Sequencer Data via MIDI from a Mirage
182	Sending All Sequencer Memory via MIDI to another ESQ 1
183	Sending One Sequence via MIDI to another ESQ 1

Appendices

Appendix 1	MIDI Program Numbers on the ESQ 1
Appendix 2	ESQ 1 MIDI Implementation Specifications
Appendix 3	ESQ 1 MIDI Parameter Number List
Appendix 4	ESQ 1 MIDI Implementation Chart
Appendix 5	Program Parameter Sheet
Appendix 6	Program Control Block Structure
Appendix 7	Track Sheet

INTRODUCTION

Your new **ESQ 1** is actually two powerful devices -- an eight voice, poly-timbral Digital Synthesizer, and a flexible eight-track MIDI Sequencer -- built into one package. Whether you plan to use the **ESQ 1** by itself, or as the master controller in your MIDI set-up, you'll find that it is a tool of enormous power and versatility for performing, recording and composing music.

The Synthesizer

With three Digital Wave Oscillators per voice, thirty-two sampled and synthetic Waveforms to choose from, and 15 routable Modulation sources, the **ESQ 1** is capable of producing a wide variety of rich, complex sounds. The five-octave, velocity sensitive keyboard can be split for different sounds on each half, layered for two sounds playing together, or even programmed for a Split/Layer mode in which two totally different pairs of sounds play on each keyboard half.

Forty Programs, or 'patches', are stored in the Internal Memory, with another eighty available on an external, plug-in Cartridge, giving you 120 sounds to select from instantly. In addition, the eighty-character fluorescent Display shows the names of ten programs at a time, making it easy to quickly scroll through all the sounds, to find the one you want. These programs can be played as is, or they can be modified to suit your taste and then renamed and stored, either in the Internal or the Cartridge Memory.

Editing of all programs, sequences, and 'global' functions (such as Tuning, Bend Range, etc.) is handled from the informative, 'Page-driven' Display which shows at a glance all the parameters associated with a selected function.

Audio outputs are provided for true stereo, as well as a mono output. Programs can be panned continuously between the left and right channels. The **ESQ 1** also has an Amplitude Modulation (AM) mode which can produce bell and ring-modulator type effects, and a Sync mode for hard sync effects.

The Sequencer

The built-in Sequencer can record and play back 2400 notes (expandable to 10,000 with the optional Sequencer Expander Cartridge). It will store 30 different Sequences, which can be combined into 10 Songs. Sequences and Songs can be saved to tape or via MIDI to diskette using an **ENSONIQ Mirage** Digital Sampling Keyboard or **Mirage** Digital Multi-Sampler. (You do have a **Mirage**, don't you?)

It is a full eight track MIDI Sequencer, capable of playing eight separate polyphonic Tracks internally, each with its own sound; or sequencing eight separate MIDI devices at once; or both. Each Track has an adjustable Output level, a MIDI channel, a Program number, and a MIDI Status (LOCAL, MIDI or BOTH).

In addition to its own internal clock, the Sequencer can sync to the clock output of another MIDI device (such as a Drum Machine or another Sequencer), or record a sync track to audio tape, and sync to that, to get the most out of any multi-track set-up.

The **ESQ 1**'s Edit functions allow you to easily modify Songs, Sequences, Tracks, or individual Events in a variety of ways. Quantization (or Auto-Correct) is available to make each performance letter-perfect. The Auto-Locate controls give you quick access to any point in a Sequence or Song, and you can "Punch in" (or out of) a Track, just like on a tape deck.

However, each time you record over any part of a Track, the **ESQ 1** gives you the chance to listen to the new Track, and the original, before you decide which one to keep. Try that on a tape deck.

Control

In short, the **ESQ 1** employs the latest computer technology to combine a state-of-the-art Digital Synthesizer with a powerful MIDI Sequencer in one manageable, easy to use instrument, to give you a whole new level of control over your music.

Getting great sounds out of the **ESQ 1** is simple -- just read the sections entitled **Getting Started** and **Getting at the Sounds**, plug it in and play. Learning to take full advantage of its tremendous power and versatility will take a bit longer, but you'll find that it's worth the trip.

GETTING STARTED

Power

Insert the Power Cable into the receptacle on the back of the **ESQ 1**, next to the On/Off switch. Plug the other end of the cable into a grounded AC outlet. (The proper voltage for your **ESQ 1** is listed on the Serial Number Label on the Rear Panel.) Turn on the **ESQ 1** and make sure the Display lights up. If not, check your connections and power source.

Amplification

Make sure your Audio system is turned off (or down) when making connections, to avoid damaging speakers or other components.

Connect the Audio Outputs of the **ESQ 1** to a mixer, instrument amplifier, stereo, or any other sound system, using 1/4 inch audio cables. If your system is stereo, connect the Left and Right Outputs to two channels of your mixer, stereo, etc. If not, use the **ESQ 1**'s Left / Mono Output only.

If you're running the **ESQ 1** through a mixer, in stereo, be sure to pan the Left input fully left, and the Right input fully right.

Basic Connections

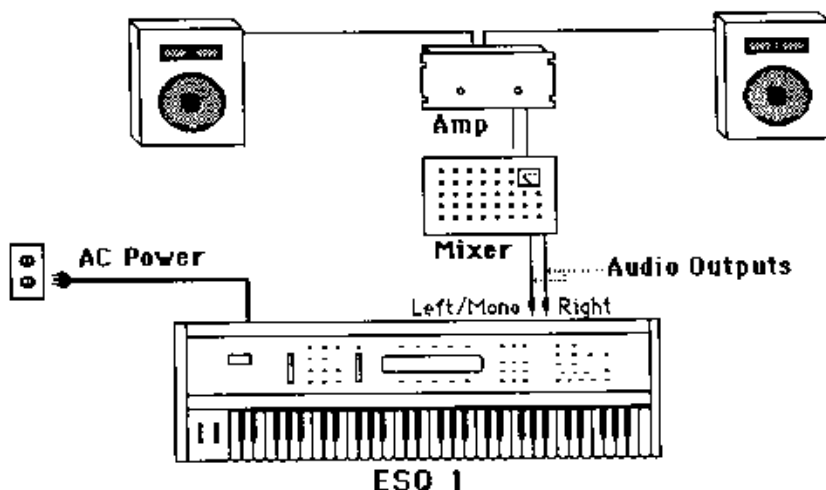

Move the **Volume Fader** of the **ESQ 1** up about half way. Switch the audio system On, and adjust the amplifier volume for normal listening levels. If you hear no sound while playing the keyboard, switch the audio system Off and check your connections.

REAR PANEL CONNECTIONS

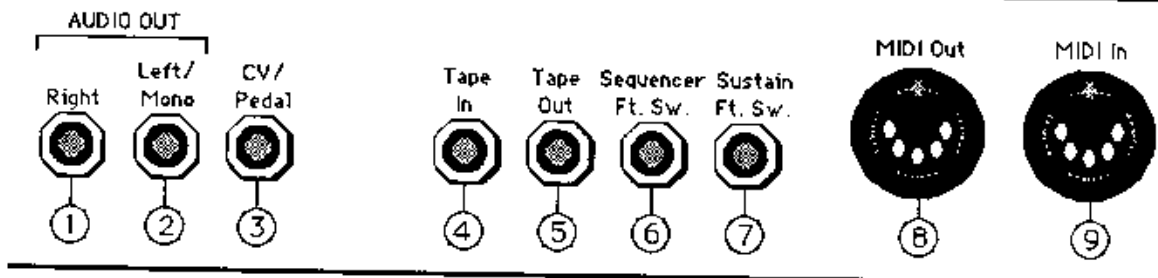

Rear Panel Connections

(Note: The order of the connectors on your unit might differ from the above diagram, but they will function exactly the same.)

AUDIO OUTPUTS:

1) **Right** -- To operate the **ESQ 1** in **Stereo**, connect this Output to a channel of your Mixer and pan that channel **Right**. If nothing is connected to this jack, both channels of the **ESQ 1**'s Output will be combined and sent out the **Left / Mono** Output.

2) **Left / Mono** -- When operating the **ESQ 1** in **Stereo**, connect this Output to a channel of your Mixer and pan that channel **Left**. To operate the **ESQ 1** in **Mono**, use this jack only. Again, if nothing has been connected to the **Right** Output jack, the **Left / Mono** jack will produce a **Mono** signal that is the sum of the two channels of the **ESQ 1**'s Output.

Specs: (Both Audio Outputs): 1 KOhm output impedance, DC coupled. Line level output into 10 KOhms or higher (one voice=1 Vp-p typical; all voices= 15 Vp-p)

3) CV / Pedal

This jack is for connecting an optional **ENSONIQ Model SW-10** Control Voltage Foot Pedal, which is assignable as a Modulator in the **Program** Section of the **ESQ 1**. The Pedal gives you a handy alternative Modulation source when, for example, you would want to use the **Mod Wheel** but both hands are busy.

Specs: 3-conductor (Tip=control voltage input, Ring=2KOhm resistor to +12 Volts, Sleeve=ground). 500 Kohm input impedance, DC coupled. Input voltage range=0 to 10 volts DC Scan rate=5mS (maximum recommended modulation input= 25 Hz). For use with an external control voltage, use a 2-conductor cable with the voltage on the tip and the sleeve grounded.

4) Tape In

This jack can be connected to the output of an audio tape recorder and used for one of three purposes:

-----> To Load and Verify **Program** or **Sequencer** Data which has been saved to Tape,

- > To read an incoming Clock Signal (or sync track) which has been recorded to tape, for the purpose of synchronizing the Sequencer to an audio tape recording, or
- > To read an incoming Clock Signal from another sequencing device (a drum machine, or other sequencer) for the purpose of synchronizing the **ESQ 1** Sequencer to that device without MIDI connections. To do this simply connect the Tape Out or Clock Out jack of the other device to the **Tape In** jack of the **ESQ 1**, and set the **ESQ 1's Clock Select for Tape Sync** (see **CONTROL** Page).

Specs: 10 Kohm input impedance, AC coupled. Triggers from 500 mVp-p up to 5 Vp-p, AC or DC coupled. 500 Hz maximum response for sync.

5) **Tape Out**

Connect this Jack to the Input of a Tape Recorder to:

- > Save **Program** or **Sequence Data** to Audio Tape, or
 - > Send out a Clock Signal (or sync track) to be recorded on audio tape so that you can synchronize the Sequencer to that track.
- Or,
- > Connect this Jack to the Tape In jack of another sequencing device, and set that device for **Tape Sync**, to sync it to the **ESQ 1's** clock without MIDI connections.

Specs: 22 Kohm output impedance, AC coupled. Drives 1 Vp-p into 10 KOhms (line level) and down to 100 mVp-p into 1 KOhm (mic level).

6) **Sequencer Foot Switch**

This jack is for an **ENSONIQ Model SW-1** Foot Switch. A Foot Switch connected here can be used to start and stop the Sequencer.

7) **Sustain Foot Switch**

This jack also takes an **ENSONIQ Model SW-1** Foot Switch. This switch acts as a **Sustain Pedal**. Holding it down will cause notes to continue to sustain after the key has been released.

*** * * * Note:** The **ENSONIQ Model SW-1** Foot Switch is wired with the contact Normally Open. Some other manufacturers' footswitches are wired this way, and will work with the **ESQ 1**. Some are wired the opposite way (Normally Closed) and will not work properly with the **ESQ 1**.

8) **MIDI Out**

This jack sends out MIDI (Musical Instrument Digital Interface) information to other instruments and computers.

9) **MIDI In**

Receives out MIDI information from other MIDI instruments or computers.

About the Programmer

Everything you do on the **ESQ 1** -- whether it's selecting a Sound, editing that Sound, adjusting the Master Tuning, or operating the Sequencer, -- is controlled from the section of the Front Panel called the **Programmer**.

The **Programmer** is made up of:

- > The 80 character fluorescent **Display**,
- > The ten grey Buttons directly above and below the Display,
- > The **Data Entry Slider** to the left of the Display,
- > The two white **Up and Down Arrow Buttons** to the left of the Data Entry Slider,
- > The **Compare** Button, and
- > The **Write** Button.

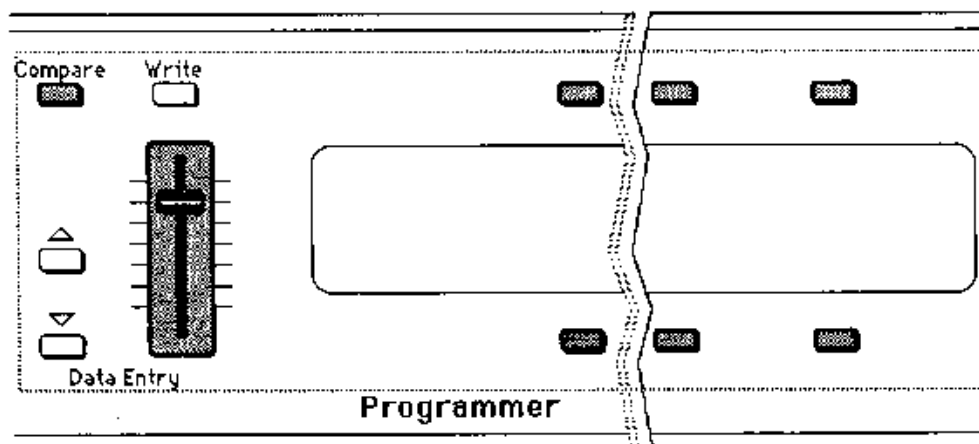

The **Programmer** is primarily used to Select and modify things -- Sounds, Program Parameters, Tuning, Sequencer Control functions, etc. -- all depending on which Front Panel Button you press. Try pressing a few of the other buttons -- **MASTER**, **OSC 1**, **DCA 1**, or **FILTER**, for example -- and watch the Display. Notice that for each button you press, the Display changes to show you information related to that function. Each of these different Display configurations is called a **Page**.

The ten Buttons above and below the Display have a new function each time you select a new Page -- that is, each time you press one of the buttons outside the **Programmer** section. Each of these ten buttons is used to select whatever is directly above or below it on the display. Whatever you select in this manner is immediately underlined, telling you that it is the current Program, Parameter, or Sequence, etc.

An in-depth description of the **Programmer** and its functions follows in the Section entitled **PROGRAMMING THE ESQ 1**.

GETTING AT THE SOUNDS

Master Banks

Each of the three **Master Banks**, (**INTERNAL**, **CART A** and **CART B**) designates a large area of memory which contains forty Programs. To play the Programs in the **Internal Memory**, press the **INTERNAL** Button.

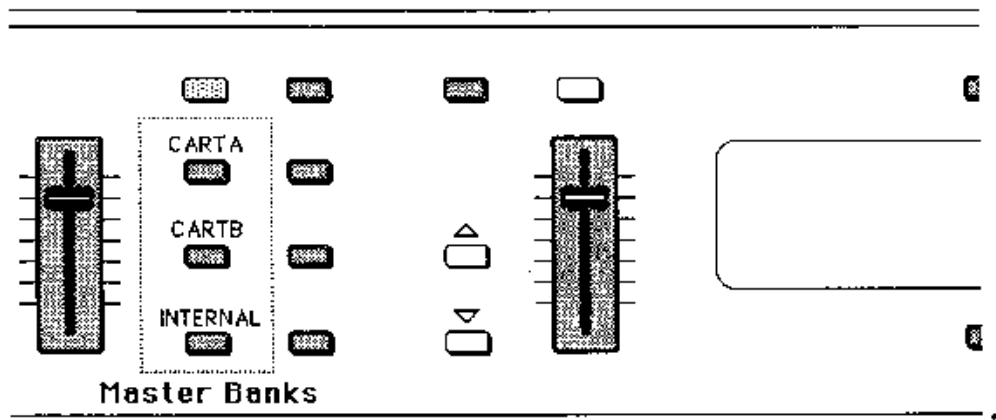

Internal Memory

The **ESQ 1** holds 40 different Sounds, or "patches" in its **Internal Memory**. We refer to these Sounds as **Programs**. **Programs** can be selected using the **Master Bank** Button labeled **INTERNAL**, the four **Bank Select** Buttons, and the ten Buttons located directly above and below the Display. The **Internal Memory** retains its data even when the power is Off.

Cartridge Memory

Before you can select the other two **Master Banks**, **CART A** and **CART B**, an **ENSONIQ E² PROM** Storage Cartridge must be inserted in the Cartridge slot. The procedures for playing, editing and saving Cartridge sounds are identical to those for Internal sounds. When a Cartridge has been inserted, all three **Master Banks** are instantly available.

The **E² PROM** Cartridge also retains its data when the power is Off, whether or not it is plugged into the **ESQ 1** Cartridge slot. When there is no Cartridge in the slot, pressing **CART A** or **CART B** will have no effect.

Bank Select Buttons

The four **Bank Select Buttons**, located to the right of the **Master Bank Buttons**, and labeled **1** through **4**, are used to call up the Programs in Memory, ten at a time, allowing you to then select the one you want to play.

Press **Bank Select Button #1**, and the Display shows you the names of the ten Programs in **Bank 1**. This is the **Program Select Page** for **Bank 1**. Press **Bank Select Button #2**, and the Display shows you the names of the ten Programs in **Bank 2**. And so on.

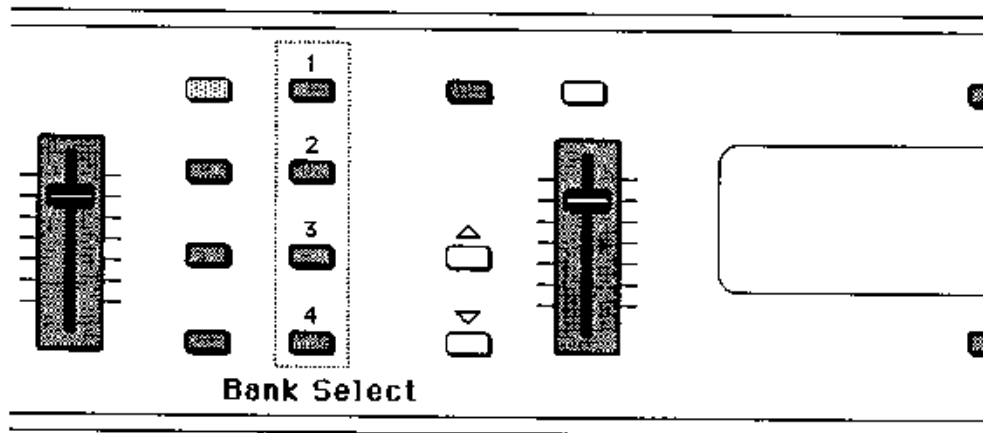

Selecting a Program -- INTERNAL

Now that you've selected one of the four Banks, you can see the names of the ten Programs in that Bank. Say you selected **Bank 1**. The Display should look like this:



Pressing the button above or below any of the ten Program names selects that Program as the current sound. Try selecting and playing a few different sounds. Notice that when you select a Program, its name is underlined.

The currently selected Program is always underlined.

Notice also that in the upper-left corner of the Display you will always find the **Page Name**, which corresponds to the name of the button (or buttons) you pressed to get to that Page. (In this case, **INT 1**, meaning **INTERNAL** Memory, Bank 1.)

Press the other three **Bank Select Buttons #2, 3 and 4** to get to the other 30 Programs in the Internal Memory, and select them in the same way. Note that displaying a new Bank or Master Bank does not affect the selected Program. A new Program can only be selected by pressing one of the ten buttons above and below the Display.

To Select an Internal Sound:

- > Press **INTERNAL**.
- > Press **Bank Select #1, 2, 3, or 4**.
- > Select a **Program** by pressing the Button above or below a Program Name.

Selecting a Program -- Cartridge

First, insert an **ENSONIQ E² PROM** Storage Cartridge in the Cartridge Slot as shown below, with the label facing towards you.

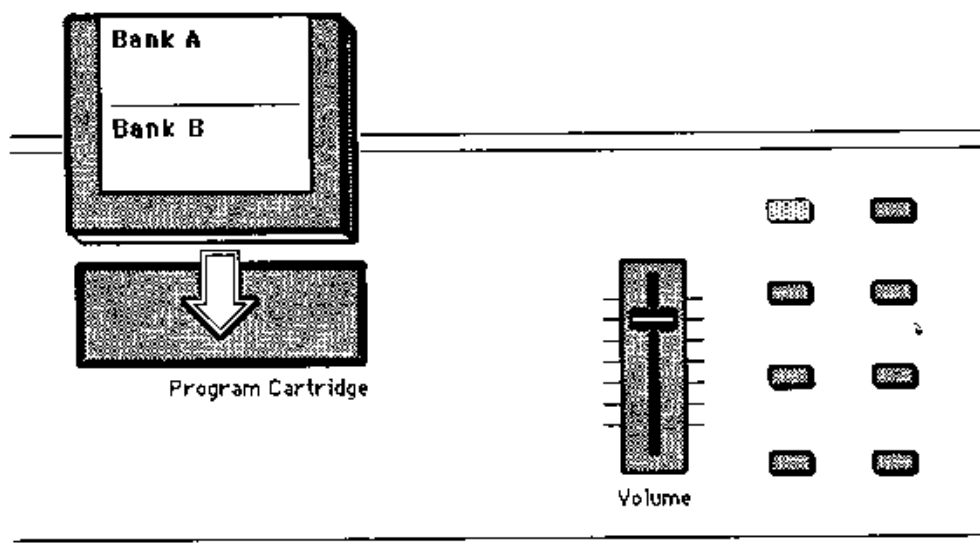

Now follow the same procedure outlined above, except that instead of pressing **INTERNAL**, first press **CART A** or **CART B**.

To Select a Cartridge Sound:

- > Press **CART A** or **CART B**.
- > Press **Bank Select #1, 2, 3, or 4**.
- > Select a **Program** by pressing the Button above or below a Program Name.

Cartridge Insertion and Removal

The **E² PROM** Cartridge can be inserted or removed at any time (except while you're Writing Programs to it), even when the **ESQ 1**'s power is On, without doing any harm to the **ESQ 1** or the Cartridge. If the Cartridge is removed while a Cartridge Program is selected, the Display instantly switches to **Internal Bank #1**, and the Cartridge Sound disappears, replaced by the first sound in **Bank 1**, which becomes the selected Program.

Battery Maintenance

The reason that the **ESQ 1** "remembers" Programs and other parameters, even when the power is OFF, is that all of its Internal **RAM** (Random Access Memory) is "Battery Backed-up". (This includes the Sequencer Memory as well as all Program and "Global" parameters.) The Battery that keeps the **ESQ 1**'s Memory intact is located inside the **ESQ 1**, and when it becomes discharged, it must be replaced by an authorized **ENSONIQ** Repair Station.

The Battery that came in your **ESQ 1** is good for up to six years of life. You will know when it needs replacing, because the **ESQ 1** will tell you so. One day you will switch the Power ON, and instead of its usual wake-up message, the Display will read:

WARNING -- BATTERY VOLTAGE IS LOW
SAVE DATA AND CONSULT OWNERS MANUAL

When this message appears, you should make sure that all Programs and Sequencer Data are saved to tape, Cartridge or **Mirage**, and then take the **ESQ 1** to an authorized **ENSONIQ** Repair Station as soon as possible to have the Battery replaced.

Available Options

These optional accessories are available from your **ENSONIQ** dealer:

- > **ENSONIQ Model SW 1 Foot Switch** -- For Voice sustain or Starting and Stopping the Sequencer.
- > **Model STC-8 E² PROM Storage Cartridge** -- For Storing the Programs you create.
- > **Model STC-8A, STC-8B, etc. Program Cartridges** -- **ENSONIQ** will regularly release new versions of the **E² PROM** storage cartridge, each with 80 all new Factory- programmed Sounds.
- > **Model SQX-10 SEQUENCER EXPANDER Cartridge** -- To expand Sequencer Memory from 8k to 32k of **RAM**, or up to 10,000 notes.
- > **Model CVP-10 CV PEDAL** -- A Control Voltage Foot Pedal which can be assigned as a Modulator within the Voice section of the **ESQ 1**.

SECTION 2 -- PROGRAMMING THE ESQ 1

12	ABOUT PAGE-DRIVEN PARAMETRIC PROGRAMMING
12	Parametric Programming
12	Pages
12	"Soft" Buttons
13	USING THE PROGRAMMER
13	Changing a Parameter
14	*C* -- Change/Compare
15	Edit Buffer
15	Bailing out
16	Active and Inactive Buttons
17	"GLOBAL" PAGES
18	MASTER -- Master Tuning, Velocity Sensitivity, and Bend Range
20	MIDI -- MIDI Parameters
25	WAVEFORMS
25	Digital Waveform Memory
25	What's a Waveform?
26	Synthetic Waveforms
26	Sampled and Multisampled Waveforms
26	Names
27	Selecting a Waveform
27	Check Them Out
28	The Waveforms
31	MODULATORS
31	About Modulation
31	Selecting a Modulator
32	Modulation Depth
33	Modulation Sources
36	USING MODULATORS
36	Modulating Oscillator Volume
38	Negative Modulation
38	Modulating the Filter Cutoff Frequency
39	Limits of Modulation
40	VOICE ARCHITECTURE -- AN ESQ 1 VOICE
41	PROGRAMMING PAGES
42	OSC 1-3 -- Oscillator Pitch Page
44	DCA 1-3 -- Oscillator Volume Page
46	FILT -- Filter Page
48	DCA 4 -- Final Volume Page
50	LFO 1-3 -- Low-Frequency Oscillator Page
53	Understanding The Envelopes
60	ENV 1-4 -- Envelope Page
63	MODE -- Modes Page
66	Split/Layer -- Splitting the keyboard and Layering Programs
71	PROGRAMMING CONVENTIONS

ABOUT PAGE-DRIVEN PARAMETRIC PROGRAMMING

To modify or "edit" programs, the **ESQ 1** employs a method known as **Page-driven parametric programming**. Sounds scary, but don't worry. Once you've mastered a few basic concepts you'll find that programming the **ESQ 1** is really quite simple, given its enormous flexibility. You'll soon appreciate the ease and clarity with which it allows you to modify, or just keep track of, a great many variables.

Parametric programming

You may well have already encountered some form of **parametric programming** on other synthesizers. What this means is that instead of having a separate knob or Slider for each function, you have one master Data Entry Slider, and two buttons, which adjust the value of whichever parameter you select.

This approach has many advantages, the most obvious of which is that it greatly reduces the amount of hardware-- knobs, switches, faders, etc.-- needed to control a wide variety of functions. (If the **ESQ 1** had a separate control for each function, it would literally have hundreds of knobs.) The disadvantage has often been that you were only able to see the value of one parameter at a time, making it hard to keep track of things. This is where the Page concept comes in.

Pages

The **ESQ 1**'s 80 character fluorescent Display makes it possible to display information in **Pages**. For each function you select, the Display shows you its 'Page', which contains all the information (all the parameters) related to that function.

You can think of the **ESQ 1** in relation to a book -- each time you press one of the Programming buttons on the front panel, you are in effect "turning to" that function's **Page**. Once you have turned to the Page you want, the Display shows you which parameters are controlled from that Page. To activate a control, simply press the button directly above or below its name on the Display.

"Soft" Buttons

The ten Buttons above and below the Display thus have multiple functions -- what they select depends upon which Page is being displayed. Whenever you select a new Page, these ten Buttons serve to select whatever parameters are displayed on that Page.

We call these "**Soft**" Buttons, to distinguish them from buttons which have fixed, "**Hard**," functions, such as the **Bank Buttons**.

Not all "**Soft**" buttons are active on all Pages. Only those buttons related to a selectable parameter will be active on a given Page.

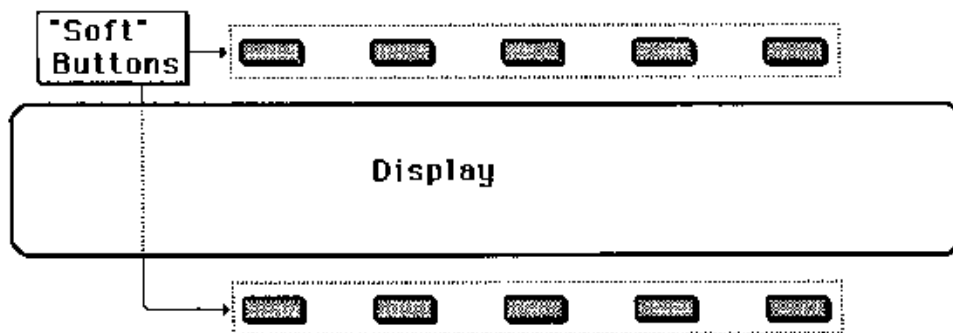

USING THE PROGRAMMER

Changing a Parameter

Suppose you want to adjust the pitch of **Oscillator 1**. Select the Program called **BASIC** in the Internal Memory. Now press the front panel Button labeled **OSC 1**:

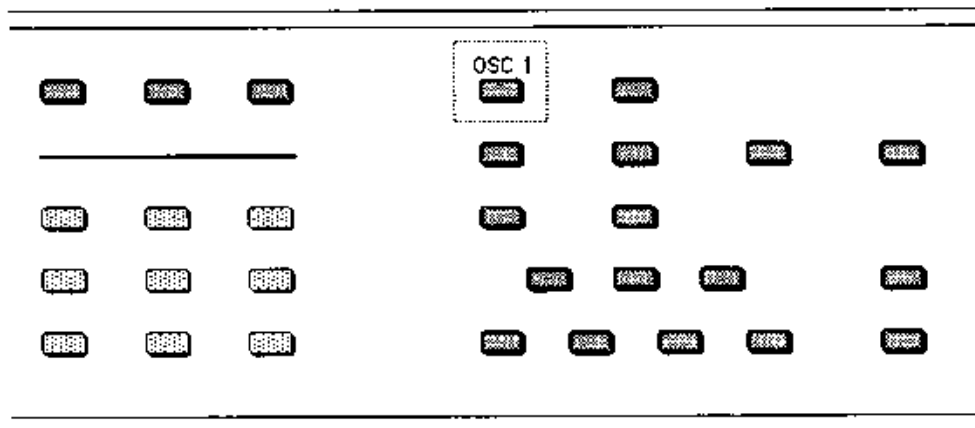

The Display now shows **Oscillator 1's** Page. It looks like this:



In the top left-hand corner of the Display you will always find the Name of the Page, which corresponds to that of the button you pressed. To the right of that are the various parameters which can be selected and modified from this page.

To raise or lower the pitch of Oscillator 1 by an octave, press the button directly above where it says **OCT=**__. This segment of the Display will now be underlined, telling you that it has been **selected**, and can be modified.

The currently selected parameter on a Page is always underlined.

Now that you have selected a parameter to be modified (**OCT=**__), use the **Data Entry Slider** and/or the **Up and Down Arrow** buttons to the left of the Display to adjust its value. Moving the Slider will scroll quickly up and down through the available range of values. Pressing the **Up and Down Arrow** buttons will increase or decrease the value one step at a time.

To select and modify another parameter on the same Page, press the button above or below its name. That parameter will now be underlined, and its value can be adjusted as before, with the **Data Entry Slider** and the **Up and Down Arrow** buttons.

You'll notice that when changing Program parameters on the **ESQ 1**, you must **restrike** a key in order to hear the change. If you are **holding down** a key (or keys) when you change a parameter, you won't hear any difference until you release the key and play it (or any other key) again.

If you select another Page (**DCA 1** for instance), change some parameter on that Page, and then return to the **OSC 1** Page, the parameter you had last selected will still be underlined. The **ESQ 1** always "remembers" which parameter was last selected on a given Page, even when the power is turned off.

Be sure that the parameter you want to edit is selected before moving the **Data Entry Slider** or the **Up and Down Arrow** Buttons. Some parameter is always selected on any given Programming Page.

C -- Change/Compare

As soon as you change any parameter in a program, a ***C*** will appear in the lower left-hand corner of the Display, below the Page Name. It will remain there until you select another Program or save (Write) the newly edited Program into memory.

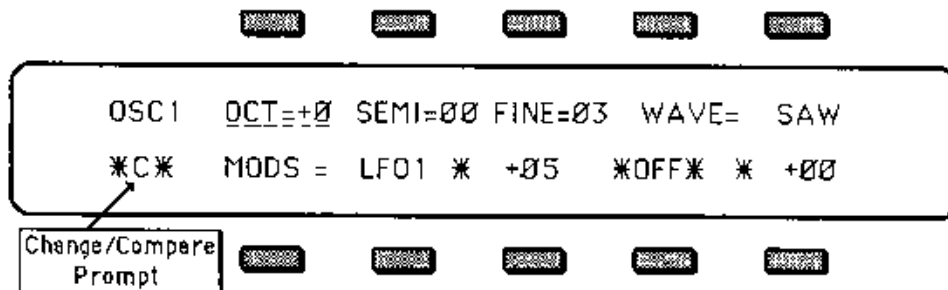

Once a parameter change of any kind has been made, the ***C*** prompt will appear

in the corner of **every** programming Page you select -- not just on the Page that has been modified. This is a constant reminder that something in the Program has been changed.

To hear the original, unchanged, Program, press the button labeled **COMPARE**. The *C* will disappear; you will hear the original sound and see the Page with its original settings. Press **COMPARE** again to return to your edited sound. You can toggle back and forth between the original and the edited sound as often as you like.

Edit Buffer

You can edit a Program, while keeping the original Program intact, because the edited version is kept in a special area of Memory called the **Edit Buffer**. Whenever you change any parameter of a Program, the altered Program is put in the **Edit Buffer**, replacing whatever was previously there. Only one Program at a time can reside there -- the **Edit Buffer** always contains the results of your last edit.

If you like the results of the changes you have made to a Program, you should rename it and save the new Program permanently, to another Location. The procedure for this is covered in **Section 3**.

When you press the **COMPARE** Button, what you are doing is alternating between the Program in the original Memory Location and the Program in the **Edit Buffer**. We refer to the Program in the **Edit Buffer** as the **Edit Program**.

You can return to the **Edit Program**, even after selecting another Program (as long as you don't change any parameters there) by pressing the **Compare** Button. This puts you back in the **Edit Buffer**, and any changes you make will affect the **Edit Program**.

The rule of thumb is this: **Whatever Sound you hear, that's what you're editing.**

Bailing Out

Should you decide, while editing a Program, that you're not happy with what you've done, and you want to start over with the original Program, just go to the proper **Program Select** Page and select the Program again. Then you can start editing the Program again from scratch. You will lose the one you were working on before.

Active and Inactive Buttons

As mentioned previously, not all buttons are active on a given Page. Throughout this Manual, whenever a Page is depicted, the active buttons will be shown in grey, the inactive ones in white. Taking the example used above, the **OSC 1** Page would appear like this:

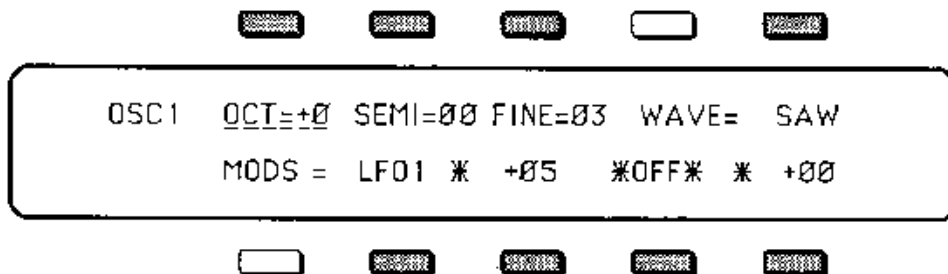

Also, for consistency's sake, these buttons will always be referred to by location number -- from upper left to lower right, **1** through **10**, as shown below:

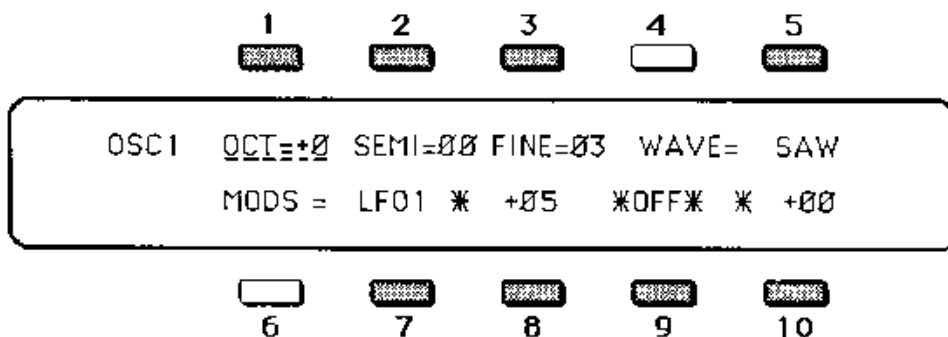

So we see that on the **OSC 1** Page, Buttons number **1, 2, 3, 5, 7, 8, 9,** and **10** are active -- they can be pressed to select a parameter to be modified. Buttons **4** and **6** are inactive on this Page. Pressing them will have no effect.

"GLOBAL" PAGES

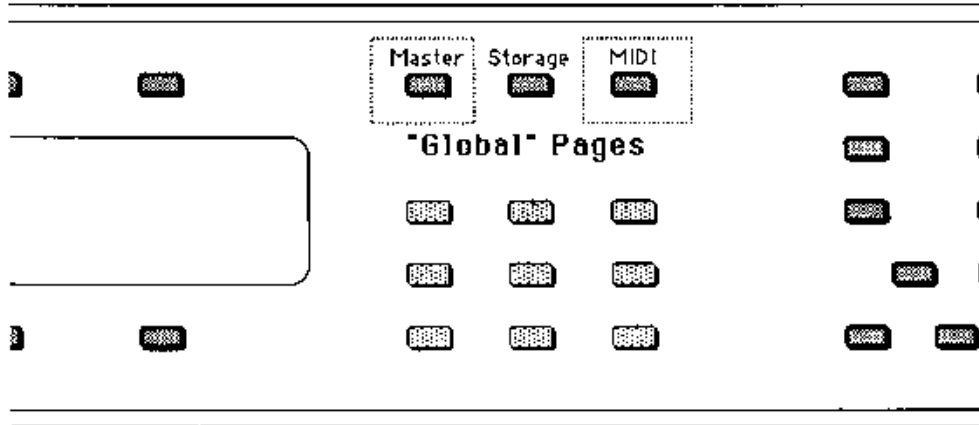

The Parameters on the following Pages are Keyboard-wide, or "Global". Their settings will not change with different Programs, but will remain the same whichever Program is selected.

[MASTER] MASTER PAGE

Controls Keyboard Tuning, Velocity Sensitivity and Bend Range.

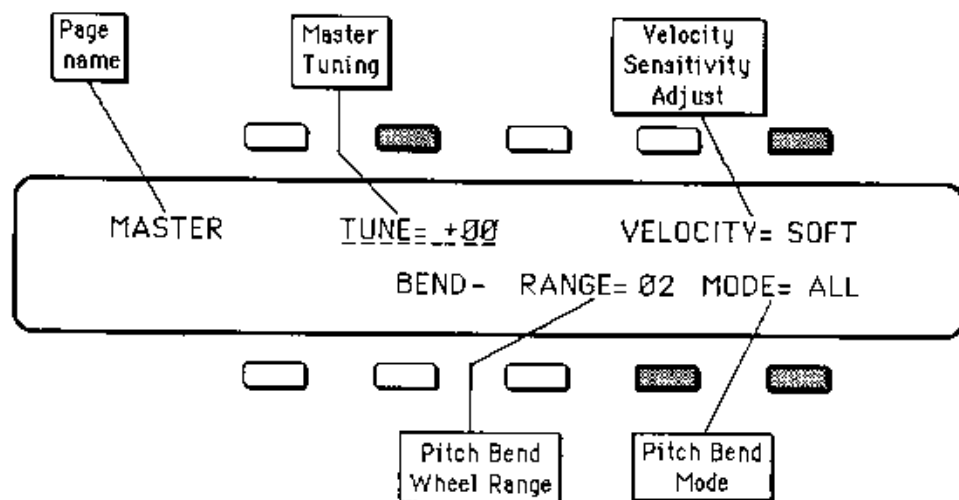

(Inactive Buttons appear in White)

The parameters on this page are keyboard-wide, or "Global." The settings here will not change with different Programs selected, but will remain in effect for whatever Program you are playing.

Aside from Master Tuning and overall Velocity Sensitivity, this page also contains a control for selecting between Pitch Bend Modes -- normal operation, where the Bend Wheel affects all notes; and a special "Held" mode in which the Bend Wheel only affects those keys which are being held down.

These settings, like all **ESQ 1** parameters, will be "remembered" even when the **ESQ 1** is turned OFF.

Use this Page to:

- 1) Adjust the **Master Tuning** of the keyboard;
- 2) Adjust the overall **Velocity Sensitivity** of the Instrument;
- 3) Set the **range** of the **Pitch Bend Wheel**; and
- 4) Select a **Pitch Bend Mode**.

[MASTER] MASTER PAGE (cont'd)

ACTIVE CONTROLS:

2. TUNE

Master Tune Adjust. Tunes the Keyboard to the desired Pitch. A setting of **TUNE= +00** will yield Concert A=440 tuning. The total range of this control is about a half step (semitone) up or down.

Range: -31 To +31.

5. VELOCITY

Velocity Sensitivity Adjust. This parameter determines the responsiveness of all Velocity-related parameters on the **ESQ 1**. You can adjust it to suit your own touch -- that is, how hard you play.

The three available settings are:

- > **SOFT** -- This is for someone with a light touch. On this setting, a minimum of force is required to reach the maximum level of any Velocity-controlled parameter.
- > **MED** -- Medium sensitivity. This setting should be right for the player with an average touch.
- > **HARD** -- This setting is for the player who really digs in. It provides the widest possible range of velocity sensitivity.

9. BEND RANGE

Pitch Bend Wheel Range. Adjusts how far the **Pitch Bend Wheel** will bend a note Up or Down. Each increment represents a Semitone.

Range: 0 To 12.

10. BEND MODE

Pitch Bend Wheel Mode. Selects between two modes of operation for the Pitch Bend Wheel. There are two Modes:

- > **ALL** -- Moving the Pitch Bend Wheel will affect the pitch of all notes that are being played. This is how most Pitch Wheels usually operate.
- > **HELD** -- In this Mode, only those keys that are being held down when you move the Pitch Wheel will be affected by the wheel. Keys that have been released will not bend, even if they are being sustained by holding down the Sustain Foot Switch. This enables you to bend certain notes while others remain unchanged in pitch. With a little practice you can simulate guitar and pedal steel-type techniques, and many other interesting effects.

[MIDI] MIDI PAGE

Controls MIDI Functions

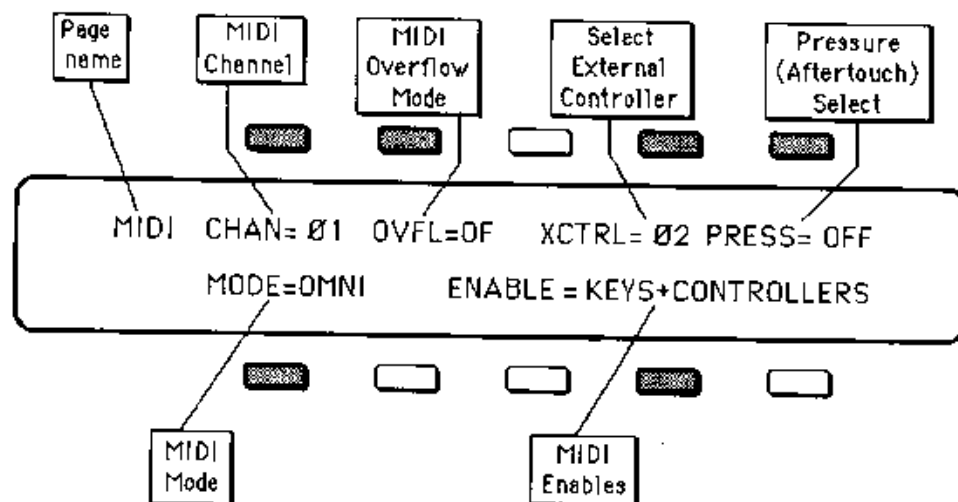

(Inactive Buttons appear in White)

From this Page you control the **MIDI** (Musical Instrument Digital Interface) configuration of the **ESQ 1**. The MIDI implementation of the **ESQ 1** is a bit more involved than most synthesizers, because of its built-in Sequencer. In many ways, each Track of a Sequence acts like a separate little synthesizer. We need some way to distinguish between "Normal" Synth operation (which is what this half of the Manual is concerned with) and what happens when one of the Tracks of a Sequence is selected.

Accordingly, when no Sequencer Track is selected, we call this the "**Straight Synth**" mode. In "Straight Synth" operation, the keyboard is entirely independent of the Sequencer. You are automatically put in this mode whenever you select a Program in the usual way. Most of the time you are in the "Straight Synth" section of the **ESQ 1** -- you don't have to do anything special to get there. The only way to leave "Straight Synth" operation is to deliberately select one of the Tracks of a Sequence.

Use this Page to:

- 1) Select a MIDI Channel;
- 2) Turn On or Off the **MIDI Overflow Mode**;
- 3) Select an External Controller to be used as a Modulator;
- 4) Enable **Pressure** (Aftertouch) as an external MIDI Controller;
- 5) Select a MIDI Mode; and
- 6) Determine which types of information will be sent and received over MIDI by the **ESQ 1**.

[MIDI] MIDI PAGE (Cont'd)

ACTIVE CONTROLS:

1. CHAN -- Base MIDI Channel

We call this the **Base Channel**. It is the MIDI Channel that the "Straight Synth" section of **ESQ 1** will send and receive MIDI information on when no Sequencer Track is selected. When a Track is selected, that Track will receive on the Base Channel if the **ESQ 1** is in **POLY** Mode.

Any of the sixteen MIDI Channels may be selected. Range: **01 To 16**.

The **ESQ 1**'s "Straight Synth" section will always send MIDI information on the Base Channel, and only on this channel. Which Channel (or Channels) it receives on depends upon this setting and which MIDI Mode is selected (see #6 below).

2. OVFL -- MIDI Overflow Mode

MIDI Overflow Mode is a unique feature of the **ESQ 1** that allows two units connected together by MIDI to act like a single 16 Voice synthesizer.

When OFF: The **ESQ 1** will behave normally, sending out all enabled MIDI data.

When ON: The **ESQ 1** will send out no MIDI data until all eight Voices are playing, and another key is struck. At this point, instead of "stealing" a Voice to play the new note, it sends that note out over MIDI. It will continue sending notes out MIDI until there is an internal Voice available to play a note.

Note: Overflow Mode will work exactly the same way with any other synth set up to receive MIDI Data from the **ESQ 1**. However, the effect of a different synth, with a different patch, picking up and playing whenever the **ESQ 1** runs out of voices will be unpredictable at best.

4. XCTRL -- Select External Controller

One of the Modulators that can be selected in the Programming section of the **ESQ 1** is **XCTRL** -- External Controller. Each Controller on a Synthesizer (Breath Controller, MOD Wheel, or Pressure, for example) has a standardized MIDI number, which is the number you select here to make a particular Controller a Modulator in any of your Programs.

Suppose, for example, that you are driving the **ESQ 1** from a keyboard with a Breath Controller (or want to use Breath Controller as a Modulator when playing the **ESQ 1** Keyboard). You can set up a Program on the **ESQ 1** where the **Filter Cutoff Frequency**, or some other Manual Level, is modulated by **XCTRL**. Then assign this parameter a value of **XCTRL= 02**. The Breath Controller will now modulate the **Filter**, or whatever, on this Program. The chart on the next page lists the accepted MIDI Controller numbers.

[MIDI] MIDI PAGE (Cont'd)

The following Controller Numbers have been agreed upon:

Number	Controller	Number	Controller
1	Modulation Wheel	66	Sostenuto Pedal
2	Breath Controller	92	Tremelo
4	Foot Pedal Controller	93	Chorus
6	Data Entry Slider	94	Celeste
7	Volume Pedal	95	Phaser

Though the range of this Control is from **01** to **95**, most of the values other than those listed above have no accepted function, as yet. They are there to accommodate future MIDI standards.

5. PRESS -- Pressure (Aftertouch) Select

Pressure (also called Aftertouch) is available as a Modulator on many synthesizers and Keyboard Controllers. The **ESQ 1**, and its Sequencer, can receive Pressure via MIDI from those keyboards which send it. There are two types of Pressure -- **Channel Pressure** and **Key Pressure**. This control has three possible states:

- > **PRESS=OFF** -- The **ESQ 1** will not receive any Pressure information. All such information will be ignored.
- > **PRESS=CHAN** -- This enables the **ESQ 1** to receive the most common type of Pressure -- **Channel Pressure**. With Channel Pressure, after a note is played, pressing down harder on the key modulates every note currently playing. Like a MOD Wheel, Channel Pressure is "Global" -- it affects the entire keyboard when activated.
- > **PRESS=KEY** -- This enables the **ESQ 1** to receive another type of Pressure -- **Key Pressure**. Key Pressure (also called Polyphonic Pressure) only modulates the note that is pressed -- all others remain unmodulated.

You should consult the Manual of the MIDI instrument you will be using in conjunction with the **ESQ 1** and its Sequencer, to see which, if any, type of Pressure it has.

6. MODE -- Select MIDI Mode

The **MIDI Mode** determines how MIDI information will be received by the **ESQ 1** and its Sequencer. The MIDI Mode has no effect on what is sent -- The "Straight Synth" Section and eight Tracks of the Sequencer will always send on their selected MIDI channels. There are four MIDI Modes that can be selected here:

[MIDI] MIDI PAGE (Cont'd)

- > **OMNI** -- In **OMNI Mode** the "Straight Synth" section of the **ESQ 1** will receive on any of the sixteen MIDI channels, when no Track is selected. If one of the eight Tracks of a Sequence is selected, then the Track will receive any enabled MIDI data on any channel.
- > **POLY** -- In **POLY Mode** the "Straight Synth" section of the **ESQ 1** will receive only on the **Base MIDI** channel (see #1 above). Midi information on all other channels will be ignored. If any of the eight Tracks of a Sequence is selected, then the Track will receive incoming MIDI data, only on the **Base** channel.
- > **MULTI** -- **MULTI Mode** is an **ENSONIQ** innovation which was specially designed to make optimal use of the **ESQ 1's** Sequencer. In **MULTI Mode** the "Straight Synth" section and each of the Sequencer's eight Tracks can send and receive MIDI information independently on a different MIDI Channel.

The "Straight Synth" will send and receive on the Base Channel selected on this Page (#1 above). Each Track of a Sequence will send and receive on its selected Channel (selected on the **Mix/ Midi** Page in the Sequencer Section).

Different MIDI Channels should be selected for each Track! If the same MIDI Channel is selected twice, priority is given first to the "Straight Synth" and then to the lowest numbered Track that shares the Channel. For example:

If MIDI Channel 1 is selected on this Page for the "Straight Synth", and Channel 1 is also selected for Tracks 1 and 3, the "Straight Synth" will receive on Channel 1, and Tracks 1 and 3 will receive nothing. Or;

If MIDI Channel 6 is selected for Tracks 2, 4, and 7, then Track 2 will receive on Channel 6, and Tracks 4 and 7 will receive nothing.

- > **MONO** -- Before **MULTI Mode** was developed, **MONO Mode** was about the only way to have a poly-timbral synthesizer. It is particularly useful for driving the **ESQ 1** from a Guitar Controller, or any other application where having up to eight independent, monophonic, Channels is desirable.

When **MONO Mode** is selected:

- 1) The "Straight Synth" section becomes Monophonic -- only one note will play at a time. Unlike the usual **Mono Mode** of the **ESQ 1**, in this state there is no Note Memory -- releasing one note does not retrigger another note which is being held.
- 2) The "Straight Synth" Section does not receive any MIDI information at all.
- 3) The **Base MIDI Channel** selected on this Page (#1 above) will be received by Track 1 of the Sequencer. Track 2 will receive on the next Channel, Track 3 on the next, and so on. The Base Channel cannot have a value greater than nine.

[MIDI] MIDI PAGE (Cont'd)

The chart below shows the MIDI channels that will be received by the eight Tracks, in **MONO Mode**, for the possible Base Channels:

If Base Channel =	1	2	3	4	5	6	7	8	9
Track 1 receives on	1	2	3	4	5	6	7	8	9
Track 2	"	2	3	4	5	6	7	8	9
Track 3	"	"	3	4	5	6	7	8	9
Track 4	"	"	"	4	5	6	7	8	9
Track 5	"	"	"	"	5	6	7	8	9
Track 6	"	"	"	"	"	6	7	8	9
Track 7	"	"	"	"	"	"	7	8	9
Track 8	"	"	"	"	"	"	"	8	9

- 4) The Base Channel Minus One becomes a global MIDI Channel for Controllers (Pitch bend, Pressure, MOD Wheel, etc.). For example, if the Base Channel is Chan. 3, any Controllers received on Chan. 2 will affect all the Tracks. If the Base Channel is Chan. 1, Chan. 16 becomes the Global Channel for Controllers.

1) ENABLE -- MIDI Enables

This parameter determines what kinds of MIDI information will be sent and received by the **ESQ-1**, including the receiving of MIDI Song Selects (see p. 169). There are five possible states for this parameter:

- > **KEY EVENTS ONLY** -- In this state the **ESQ 1** will send and receive only notes that are played on the Keyboard, along with Song Selects (Song Selects are always sent). Controllers (such as MOD Wheel, Pitch Bend, etc.), Program changes, and Parameter Changes will not be sent or received. Song Selects will not be received.
- > **KEYS + CONTROLLERS** -- Key Events and Controllers only will be received. Parameter Changes and Song Selects will be sent, but not received. Program changes will not be sent or received.
- > **KEYS + CT + PROG CHNG** -- Key Events, Controllers, and Program Changes will be sent and received in this Mode. This means that changing Programs on the **ESQ 1** will instruct a slave unit to change to the same numbered Program; or, if the **ESQ 1** is being driven by another keyboard, Program changes made on that keyboard will cause the **ESQ 1** to change to the same-numbered Program. Again, Parameter Changes and Song Selects are sent but not received.
- > **KEYS + CT + PC + SNGSL** -- Same as **KEYS + CT + PROG CHNG** above, with the addition that MIDI Song Select messages will also be received. Key Events, Controllers, Program Changes and Song Selects will be sent and received in this Mode.
- > **KEYS + CT + PC + SS + SX** -- Key Events, Controllers, Program Changes, Song Selects and System Exclusive messages will all be received via MIDI in this Mode. This enables the **ESQ 1** to receive System Exclusive messages, such as Parameter Changes, Program Dumps, Sequencer Data, etc. Any Parameter (Program or Global) that is changed on the **ESQ 1** will also be changed on another **ESQ 1** connected to the first by MIDI.

WAVEFORMS

Digital Waveform Memory

The same Digital technology that allowed the **ENSONIQ Mirage** to make Digital Sampling affordable gives the **ESQ 1** its ability to play complex sounds from "the real world". The **ESQ 1's** three Digital Oscillators, rather than just producing simple sawtooth or square waves, actually "read" from memory whichever Waveforms they are instructed to play.

The **ESQ 1** has 32 different **Waveforms** stored in its **Digital Waveform Memory**. Some of these Waveforms have been sampled (digitally recorded) from real musical sources; others have been created synthetically.

What's a Waveform?

The Waveforms are the "raw material" of the sounds that the **ESQ 1** makes. A waveform is a single cycle of a sound wave. It is Digitized, or converted into a series of numbers, and stored in the **ESQ 1's Digital Waveform Memory**. When you play a note, each of the **ESQ 1's** three Oscillators "reads" the proper Waveform from the Memory, similar to the way a Compact Disc player reads the music on the disc when you play a CD.

By rapidly repeating this single cycle over and over, the Oscillator can produce a pitched sound which becomes a continuous Sound wave.

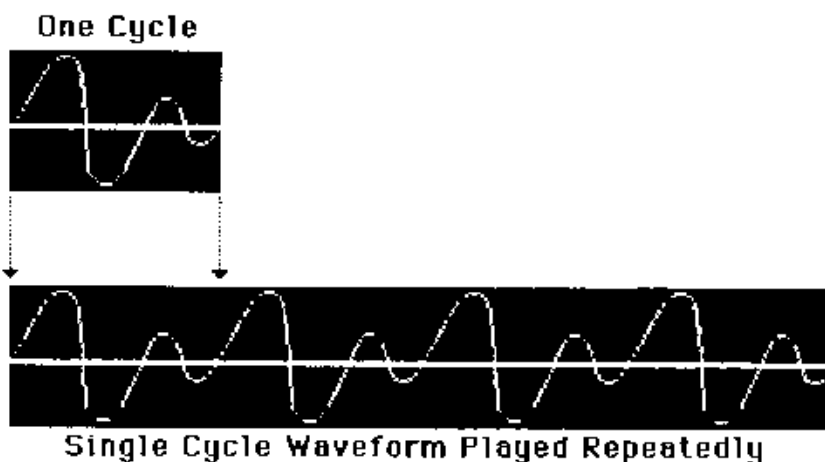

Unlike the sounds generated by analog oscillators, Digital Waveforms can be very complex, and can contain any combination of harmonics -- frequencies that are multiples of the wave's fundamental frequency. Every Waveform has its own unique **Spectrum**, which is the number and amplitude of harmonics present in the Wave. It is this Spectrum which gives every sound its own identifiable characteristics.

Synthetic Waveforms

Most of the Waveforms in **ESQ 1**' Digital Waveform Memory have been generated synthetically, using a number of different techniques, to create a variety of Waves which contain specific harmonics in specific amounts. By assigning different combinations of these synthetic Waveforms to the three Oscillators, it is possible to create sounds with almost any timbral characteristics.

Sampled and Multisampled Waveforms

Other Waveforms are sampled -- a single cycle of a sound wave from some real musical source has been isolated and stored in Memory. By playing back these Waveforms in the manner described above, it is possible to synthesize sounds that capture the character of the Source instrument in a way that no ordinary synthesizer can.

Some of the **ESQ 1**'s Waveforms (such as the Piano Waveform) have been **Multisampled** -- that is, different waves play in different ranges of the instrument. This is because many sounds lose their realism if they are transposed too far from their source. The lowest note on a piano, if transposed up three octaves, doesn't sound like a piano any more. Neither does the highest note transposed down three octaves. Or to use another example -- take a recording of a human voice and play it back twice as fast. Does it sound like a human voice? No. What does it sound like? Chipmunks.

Multisampling means that the low notes of the Piano Waveform were sampled from a low note on the piano, the middle notes were sampled from a middle note, and so on. So really you get more than 32 Waveforms, since some of them are actually made up of several Waveforms. You don't have to do anything special to use these **Multisampled Waveforms**. The **ESQ 1** treats each one as a single Waveform, and they are selected just like the others.

The Synthetic Waveforms can be combined with the Sampled ones, to add harmonic content which enhances the sound in some way. Any combination of Waveforms is possible, and each will have its own unique sound.

Names

The **ESQ 1**'s 32 Waveforms are identified by their **Names**. In the case of the Sampled Waveforms especially, you should neither take them too literally, nor let yourself be limited by those Names. Don't, for example, expect the **VOICE** Waveform to always sound like Vocals -- everything depends on the Program (the Envelopes, the Filter settings, etc.). On the other hand, don't let the Names alone limit what you try in terms of being creative. For example, if you find that within a certain Program the **BASS** Waveform sounds like a harpsichord, or a kazoo, or whatever, go with it. Your ears are the only valid judge of what works.

Selecting a Waveform

Each of the three Oscillators can play a different Waveform within a Program. The Waveforms are selected from the **Oscillator Pitch Pages** [**OSC1**, **OSC2** and **OSC3**].

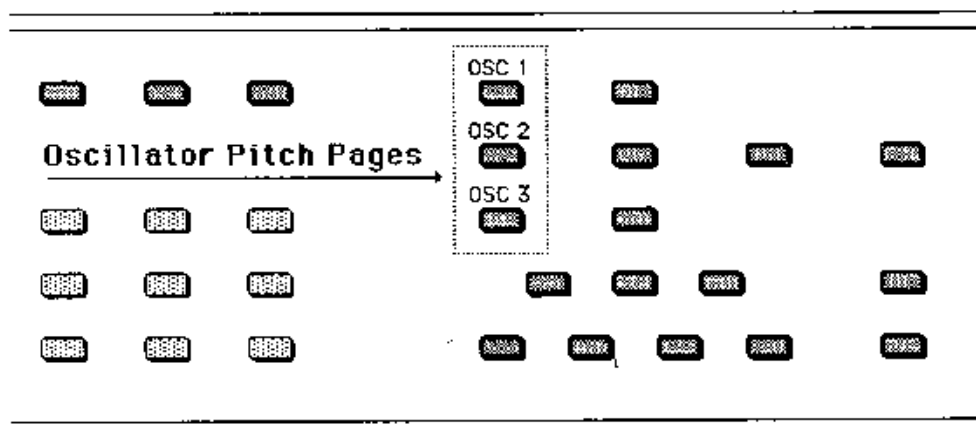

To select a Waveform for **Oscillator 1**, press the Button labeled **OSC 1**. The Display shows you **Oscillator 1's** Page. In the upper right portion of the Page you find the **Waveform** select.

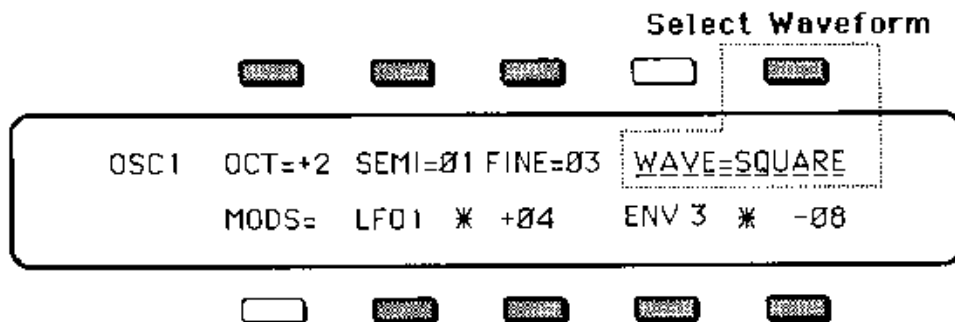

Press the "Soft" Button above the **WAVE NAME**. Now you can use the **Data Entry Slider** and the **Up and Down Arrow** Buttons to change the Waveform that **OSC 1** will play. There are 32 available choices, each with its own Name. Follow the same procedure to select a Waveform for **OSC 2** and **OSC 3**. The following section details each Waveform by Name.

Check Them Out

The best way to understand the Waveforms is not to read about them, but to hear them. Select the Internal Program called **BASIC**. This Program has only one Oscillator playing, and all the Envelopes wide open. Select the **OSC 1** Page as shown above, and select **WAVE**. The Sawtooth Wave is selected (**WAVE= SAW**).

While repeatedly playing a note or chord, press the **Up Arrow Button** to step to the next **Waveform**. Press it again to hear the next one, and so on. In this way you can listen to each **Waveform** in succession, compare them to each other, and compare the timbral characteristics you hear in various ones to their text descriptions below. When you are looking for the right **Waveform** for a particular application, let your ears be the guide.

The Waveforms

1) CLASSIC SYNTH WAVEFORMS

These **Waveforms** collectively form the bases of almost all classic Analog synthesizer sounds. Their inclusion here gives the **ESQ 1** its ability to make those sounds with the best of them.

- > **SAW -- SAWTOOTH.** The Sawtooth Wave needs no introduction. It contains all the harmonics, and is extremely bright. The Sawtooth is the basis for many Analog sounds, notably Strings and Brass.
- > **BELL.** The Bell Waveform contains many widely spaced harmonics, many of them odd harmonics. It makes bright, Bell sounds.
- > **SINE.** The Sine Wave contains only the Fundamental, with no higher harmonics. It has very pure tone, good for flutes, organs, etc.
- > **SQUARE.** The Square Wave contains the Fundamental and all its odd-numbered harmonics at a fixed ratio. The level of the harmonics is the same as the Sawtooth, except that there are no even-numbered harmonics. The Square Wave has a hollow sound, and is also the basis for many classic synth sounds.
- > **PULSE.** This Pulse Wave contains the Fundamental and all its integral harmonics at equal amplitude. This is a very bright Waveform.
- > **NOISE 1.** This is a Waveform taken from filtered Noise. It works best when tuned down low (**OCT= -3**). (Note that the Noise Waveforms here differ from analog Noise generators, in that Waveforms are by definition repeating patterns, and Noise is random.)
- > **NOISE 2.** This is very close to White Noise. It has almost no pitch, but modulating the Oscillator playing this Waveform with a fast LFO or an Envelope, will eliminate what pitch tracking there is.
- > **NOISE 3.** This Waveform is good for putting random frequency components into a sound (the attack "ping" of a mallet instrument, for example). It has a clangorous, metallic quality, and its pitch tends to be unpredictable.

2) SAMPLED WAVEFORMS

The **Sampled Waveforms** contain harmonics that simply cannot be generated

by an ordinary synthesizer, since every musical source produces its own unique waveshapes and Frequency Spectrum.

- > **BASS.** This is a bright Bass Waveform, full of interesting harmonics, which, depending on the Program, makes a great regular or synth-type Bass. Higher up it takes on a Clav-like character,
- > **PIANO.** A multisampled acoustic Piano wave. Its best range is **OCT= -1.**
- > **EL PNO -- ELECTRIC PIANO.** A Waveform taken from a popular Electric Piano -- allows you to recreate this instrument with tremendous realism.
- > **VOICE 1.** A multisampled Vocal wave, saying "Ah".
- > **VOICE 2.** A multisampled Vocal wave, using the same waveforms as **VOICE 1,** but with a higher split point for each Wave
- > **KICK.** This Waveform is optimized for one application. Tuned to **OCT= -3,** properly enveloped, and played on the lowest key of the Keyboard, it reproduces a Kick drum.
- > **REED.** One cycle from an Alto saxophone wave. With different Programs it can sound like different Reed Instruments.
- > **ORGAN.** This Waveform contains the fundamental and four Octaves (2nd, 4th, 8th, 16th and 32nd harmonics). Instant Pipe Organ. Also good for Bells.

3) ADDITIVE SYNTHESIS WAVEFORMS

These three Waveforms were created through Digital Additive Synthesis. Each contains the Fundamental and certain specific harmonics in equal amounts.

- > **SYNTH 1.** Contains the fundamental, and every third harmonic, starting from the 2nd, up to the 26th, in equal amounts:
Harmonics: 1, 2, 5, 8, 11, 14, 17, 20, 23, 26.
- > **SYNTH 2.** Contains the fundamental, and every third harmonic, starting from the 4th, up to the 25th, in equal amounts:
Harmonics: 1, 4, 7, 10, 13, 16, 19, 22, 25.
- > **SYNTH 3.** Contains the fundamental, and the prime-numbered harmonics, up to the 23rd, in equal amounts:
Harmonics: 1, 2, 3, 5, 7, 11, 13, 17, 19, 23.

4) FORMANTS

These five Waveforms were created through a process called Time-Domain Formant-Wave-Function Synthesis. Each one has a sharp peak in its frequency spectrum -- like pushing one band of a graphic equalizer all the way up. These

Waves are multisampled in such a way that the frequency peak remains relatively constant up and down the keyboard, rather than tracking the pitch of the note. Each has its peak centered around a different frequency. They tend to have a nasal quality, and make excellent component waveforms for Vocals, Strings etc.

- > **FORMT 1.** Has a frequency peak centered around 750 hz.
- > **FORMT 2.** Has a frequency peak centered around 1 khz.
- > **FORMT 3.** Has a frequency peak centered around 1.4 khz.
- > **FORMT 4.** Has a frequency peak centered around 1.75 khz.
- > **FORMT 5.** Has a frequency peak centered around 2.25 khz.

5) **BAND LIMITED WAVEFORMS**

These Waveforms are Band Limited -- that is, their harmonic content has been restricted along certain specific lines. They are good for adding controlled harmonics to a sound, or for combining to achieve various timbres. Some are other Waves with some harmonics pulled out; some were built "from scratch" to contain only certain harmonics.

- > **PULSE2.** Originally a Pulse Wave, like the Pulse Wave above, but with only the first 11 harmonics left in.
- > **SQR 2.** Originally a Square Wave, but with only the first 7 harmonics left in.
- > **4 OCTS.** Contains, in equal amounts, only four harmonics -- 1st, 2nd, 4th, 8th. Fundamental and three Octaves; again, good for Organ sounds.
- > **PRIME.** Contains, in equal amounts, only the first five prime-numbered harmonics: 1st, 3rd, 5th, 7th, and 11th.
- > **BASS 2.** Originally the Bass Wave, but with only the first eighteen harmonics left in.
- > **E PNO2.** Originally an Electric Piano Wave, but with only the first nine harmonics left in. An Electric Piano without the "ping."
- > **OCTAVE.** Contains only the 1st and 2nd harmonics in equal amounts -- the Fundamental and one Octave.
- > **OCT+5.** Contains only the 1st, 2nd, and 3rd harmonics in equal amounts -- the Fundamental, one Octave and the Fifth above the octave.

MODULATORS

About Modulation

To **modulate** something is simply to cause it to change. Within the Voice architecture of the **ESQ 1** we begin by setting basic, or Manual, levels for Volume, Pitch, Brightness, etc., and we then **modulate** those levels in various ways in order to create movement and dynamics within the Sound.

Suppose you switch on your stereo, and turn the volume half way up. We can call this the Manual Volume setting. It will stay at that level until it's changed. Now suppose that you take the Volume knob and begin quickly turning it up and down, so the volume gets continuously louder and softer, louder and softer. What you would be doing is **modulating the volume** of your stereo. If you were to take the Treble control, and do the same to that knob, you would be **modulating the brightness** of your stereo.

In much the same way we modulate various levels within the **ESQ 1** (though generally the approach is *less haphazard*). There are 15 different **Modulation Sources** available, and they can each be independently assigned to vary the Manual levels for:

- > The Pitch of each Oscillator [**OSC 1, OSC 2 and OSC 3**]
- > The Volume of each Oscillator [**DCA 1, DCA 2 and DCA 3**]
- > The **Filter Cutoff Frequency**, or the Brightness of the Program [**FILTER**]
- > The Depth of the **Low Frequency Oscillators** [**LFO 1, LFO 2 and LFO 3**]
- and
- > Panning the Program within the stereo mix [**DCA 4**] Page

The Final Volume of the Program [**DCA 4**] is a special case -- it is always controlled by **Envelope 4**, which is fixed as its Modulator.

Selecting a Modulator

On each of the **Oscillator Pitch Pages**, [**OSC 1, OSC 2 and OSC 3**], the **Oscillator Volume Pages**, [**DCA 1, DCA 2 and DCA 3**], and the **FILTER** Page, you can select two different Modulators. The format is similar for all these Pages -- the controls on the bottom row of the Page are used to Modulate the Levels set on the top row. Take for example the **OSC 1** Page:

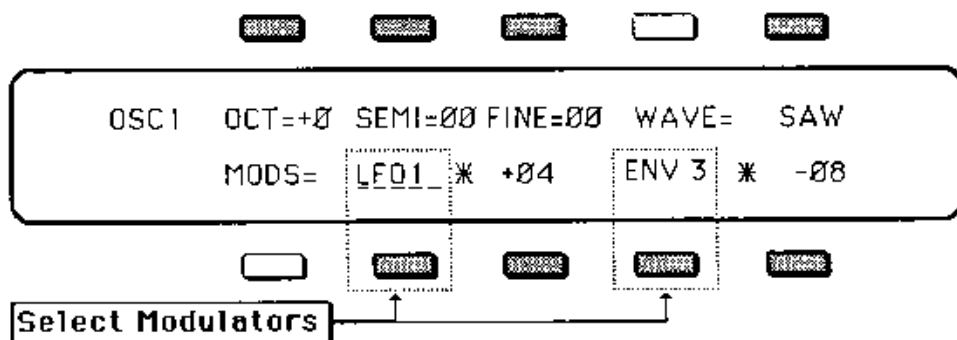

To select a **Modulator** (or **Modulators**) for the pitch of **Oscillator 1**, first press the **OSC 1 Button**, then press either of the **Select Modulator "Soft" Buttons** on the Display, as pictured above. Use the **Data Entry Slider** and the **Up and Down Arrow Buttons** to select from among the 15 available Modulation Sources. Follow the same procedure to select Modulators on the other Pages listed above.

For Modulating Program **Pan [DCA 4 Page]** and **LFO depth [LFO 1, LFO 2 and LFO 3 Pages]** only one Modulator can be selected.

*** * * * Helpful Hint:** Moving the **Data Entry Slider** all the way up selects ***OFF***, which is handy if you don't want a Modulator applied in a particular location.

Modulation Depth

Once you have selected a Modulator, use the control immediately to its right to adjust the **Modulation Depth**, or the amount by which the Modulator will affect the Manual Level.

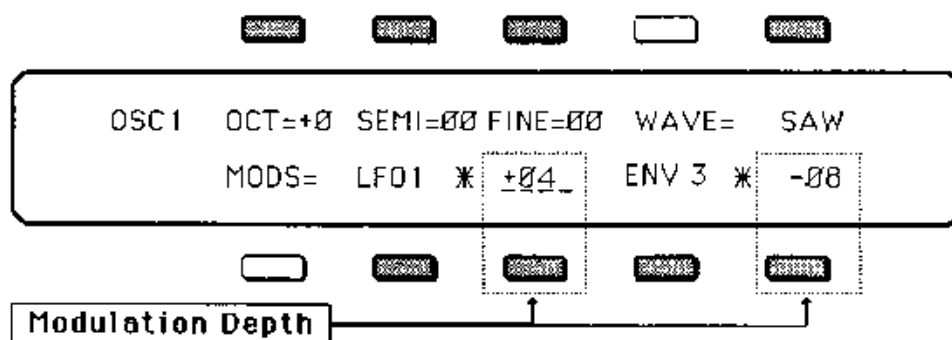

Press the appropriate "Soft" Button, as shown above, and use the **Data Entry Slider** and the **Up and Down Arrow** Buttons to adjust the Modulation Depth. Modulation Depth can be Positive or Negative. A Modulation Depth of +00 has the same effect as turning the Modulator ***OFF***.

*** * * * Helpful Hint:** With Modulation Depth, as with all Parameter values that have a center value (in this case, +00), there is an easy way to reach that value. With the Modulation Depth selected, press the **Down Arrow** Button, and while holding it down, press the **Up Arrow** Button. This automatically sets the Modulation Depth to +00.

Modulation Sources

The 15 **Modulation Sources** available on the **ESQ 1** are as follows:

-----> **LFO 1, LFO 2 and LFO 3**

The three **Low Frequency Oscillators** generate only very low frequency waves, which can produce Vibrato, Tremelo, and many other effects, depending on the **LFO** wave selected, and where it is applied as a Modulator. There are four possible waveshapes for each **LFO**. The Square wave only goes in a positive direction; the Triangle, Sawtooth and Noise Waves go positive and negative. (Though negative Modulation depth will reverse the effect.) The Diagrams below show the maximum levels for each LFO waveshape.

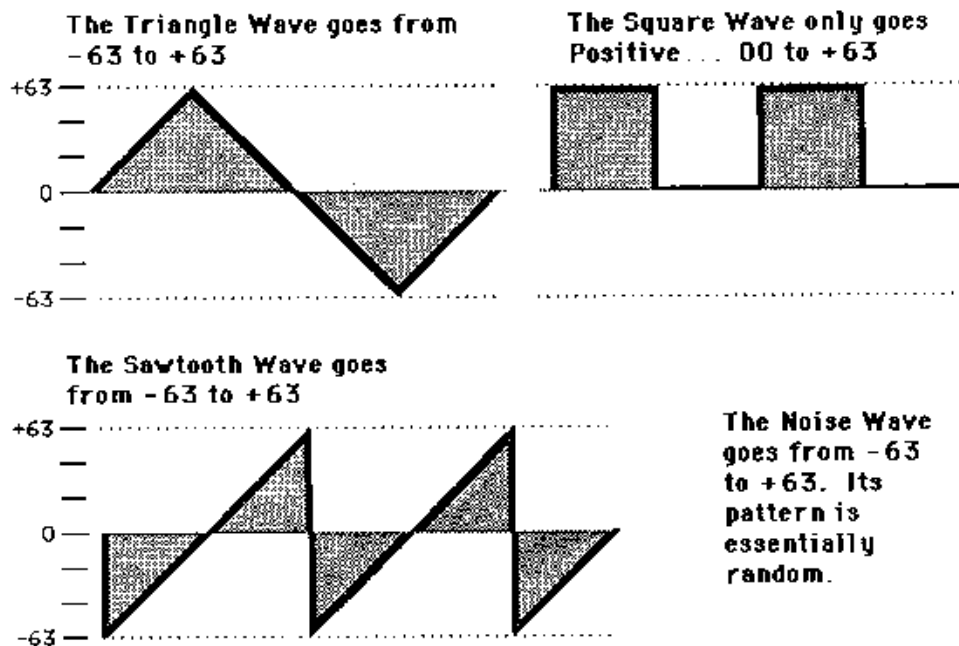

See the **LFO Page** (p. 50) for a complete discussion of the LFO's.

-----> **ENV 1, ENV 2, ENV 3 and ENV 4**

The **ESQ 1** has four complex **Envelopes** which can be applied as Modulators. Envelope Levels can be positive or negative.

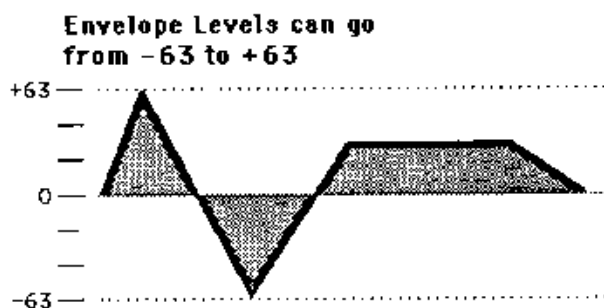

A comprehensive discussion of the **ESQ 1 Envelopes** follows in the Section entitled **Understanding the Envelopes**, p. 53.

-----> **VEL -- Velocity**

Velocity means how hard you strike a key. Selecting **VEL** as a Modulator allows you to modulate any Manual Level with Velocity. Velocity as a Modulation Source only goes positive (though again, assigning a negative Modulation depth will make the net result be to decrease a Manual Level with Velocity). **VEL** is velocity with a straight linear curve.

-----> **VEL 2**

This is Velocity with a different Curve. Where the effect of **VEL** is linear, **VEL 2** reaches the top end of the Modulation range quicker, with less velocity, and after that the curve levels off. The illustration below shows the difference between **VEL** and **VEL 2**.

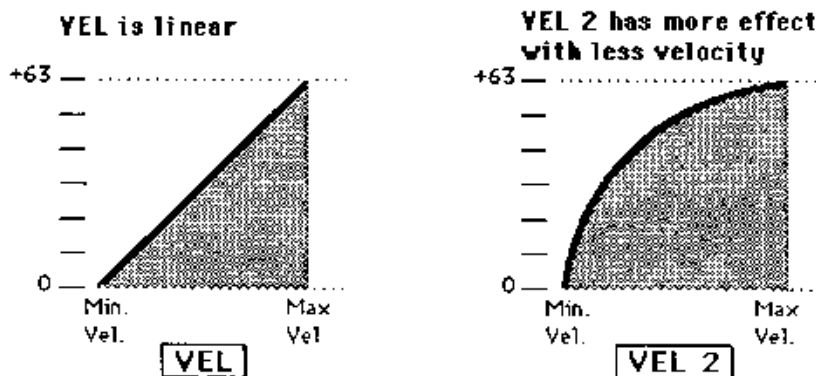

-----> **KYBD -- Keyboard "Control Voltage"**

Uses the position of a note on the Keyboard as a Modulator. The scaling effect of this Modulator is figured from MIDI key 0 to MIDI key 127.

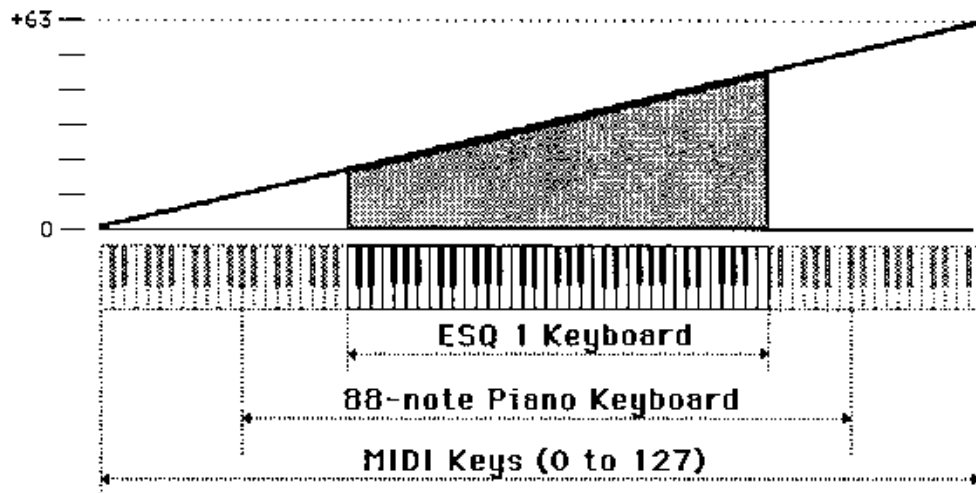

As the above illustration shows, the effect of **KYBD** is only positive-going (though a negative Modulation depth will reverse the effect). Since scaling starts from MIDI key 0, there will always be some effect on the **ESQ 1** keyboard, even on the lowest note. Manual Levels should be adjusted accordingly.

----> **KYBD 2**

Another way to modulate any Manual Level with the position of a note on the Keyboard, **KYBD 2** employs a different curve. **KYBD 2** goes negative as well as positive and, unlike **KYBD**, has its full effect over the **ESQ 1**'s Keyboard.

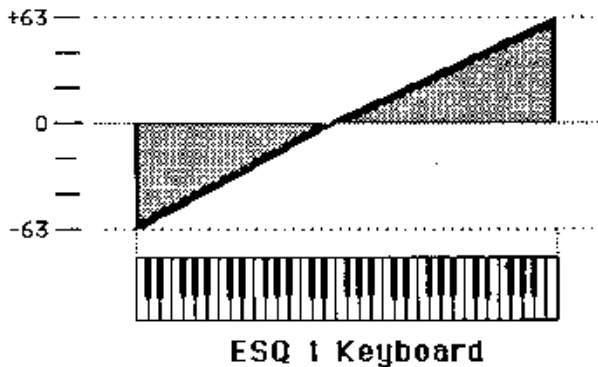

As the above illustration shows, the effect of **KYBD 2** is to reduce the Manual Level on notes below the break point (E above Middle C), and increase levels above that point. Negative Modulation depths will do the opposite.

----> **WHEEL -- Modulation Wheel**

The MOD Wheel to the left of the Keyboard is assignable wherever a Modulator is selected. To use the MOD Wheel for Vibrato (one common application) **WHEEL** must be assigned to modulate the LFO that is modulating Oscillator Pitch. The MOD Wheel's effect is positive-going only, from 0 (Wheel towards you) to +63 (Wheel away from you). Negative Modulation depths will reverse the effect.

----> **PEDAL -- Voltage Control Foot Pedal**

This selects the **SW-10** Foot Pedal, which can be plugged into the **CV/Pedal** Jack on the **ESQ 1**'s rear panel, as a Modulator. Its effect will be the same as that of the MOD Wheel. The Pedal makes an excellent alternative to the MOD Wheel when you wish to apply Modulation and both hands are full. It can be applied wherever a Modulator is selected.

----> **XCTRL -- External Controller (MIDI only)**

An External Controller such as a Breath Controller, Data Entry Slider, MOD Wheel, etc., which is received via MIDI from another synthesizer, can be assigned as a Modulator within your **ESQ 1** Programs. On the **MIDI** Page, you select the number of the External Controller that will be received by the **ESQ 1**.

You don't have to be playing the **ESQ 1** from an external instrument for this to work. For example, if you have a Keyboard with a Breath Controller; 1) Connect

its MIDI Out to the **ESQ 1's** MIDI In; **2)** Make sure both instruments have Controllers Enabled (**MIDI Page**); **3)** Select Breath Controller as the External Controller that will be received by the **ESQ 1** (**XCTRL=02**, also on the **MIDI Page**); **4)** assign **XCTRL** as a Modulator for Oscillator Volume, Filter Cutoff Frequency, or some other Manual level within a Program, as shown in the following Section; and **5)** Play the Sound from the **ESQ 1** keyboard, while blowing into the Breath Controller connected to the sending instrument. The Modulation will have the same effect as if you were playing from the sending instrument.

-----> **PRESS -- Pressure (Aftertouch) (MIDI only)**

Pressure, also called Aftertouch, is received by the **ESQ 1** and its Sequencer, and can be Programmed as a Modulator. A Control on the **MIDI Page** enables Pressure to be received, as well as determining which type will be received -- **Key** or **Channel Pressure**. (See p. 22.)

If you will be driving the **ESQ 1** from a synth which sends Pressure, you can assign Pressure as a Modulator within your **ESQ 1** Programs, just as you would the MOD Wheel, or the C.V.Pedal. Also the Sequencer will Record and Play back Pressure, if a Track is recorded from an external instrument which sends it. In either case, Pressure must be enabled on the **MIDI Page**.

USING MODULATORS

Modulating Oscillator Volume

The Volume of each of the three Oscillators within a Program depends on a combination of two things:

- 1) the setting of the base, or Manual Level (the Control labeled **LEVEL=**__ on the **DCA 1**, **DCA 2** and **DCA 3** Pages), and
- 2) the effect of any **Modulators** applied on any of those Pages.

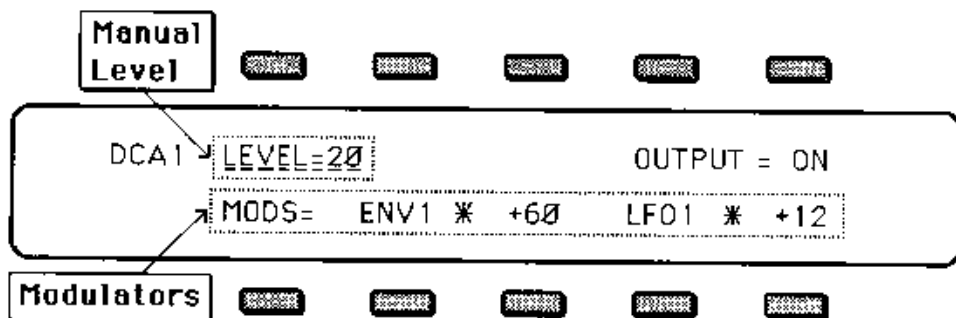

The Manual Level can be thought of as a **Volume Floor** :

- > If this Level is set to some value greater than Zero for a given **DCA**, and no Modulators are applied, The Oscillator will play at that level as long as a key is held down.

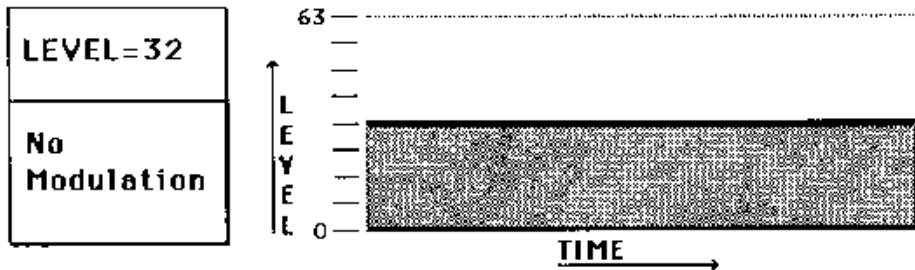

- > If the Manual Level is set to some value greater than Zero, and a Modulator (in this case an Envelope) is selected and assigned a depth other than Zero, the effect of the Modulator will be added to (or subtracted from) the Manual Level.

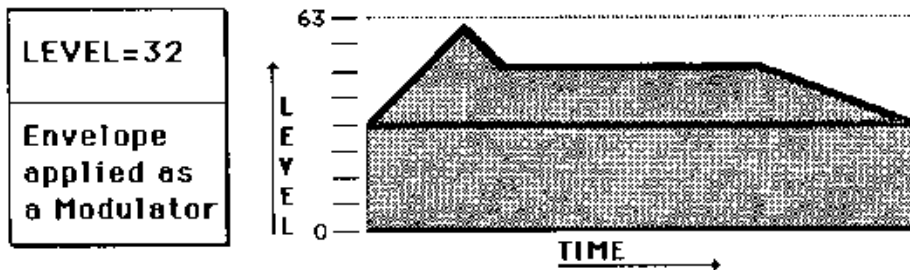

- > If the Manual Level is set to Zero, and a Modulator (the same Envelope) is selected and assigned a depth other than Zero, the depth of the Modulator alone will determine the Volume of the Oscillator.

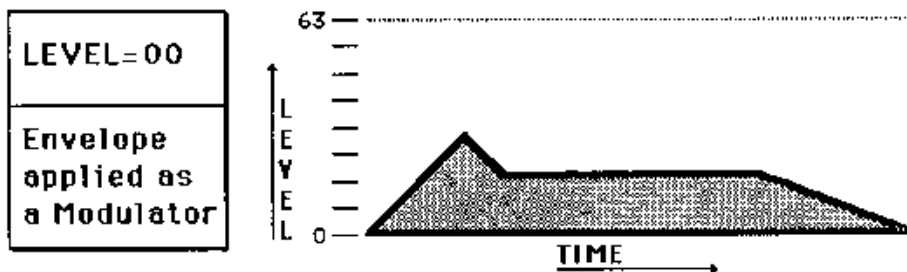

Bear in mind that when you use an **Envelope** or an **LFO (Low Frequency Oscillator)** as a Modulator, the final effect will depend on the Modulation Depth and the Levels that are set for the Envelope or LFO on their respective Pages.

Negative Modulation

Modulation Depth can be Positive or Negative (ranging from **-63** to **+63**), making a great many interesting effects possible. If, for example, the Manual Level is set to **48**, and the same Envelope used in the previous examples is selected and assigned a Negative Modulation depth, the resulting Volume curve looks like this:

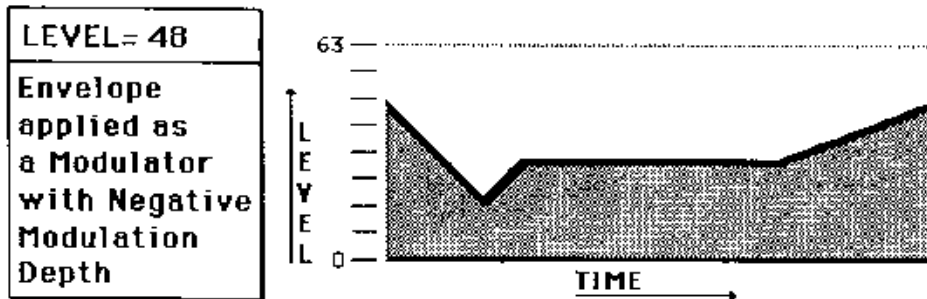

Modulating the Filter Cutoff Frequency

Like Oscillator Volume, the **Filter Cutoff Frequency**, or the Brightness contour of a Program, depends on a combination of two things:

- 1) the setting of the base, or Manual Level (the Control labeled **FREQ=**__ on the **FILTER** Page), and
- 2) the effect of any **Modulators** applied on that Page.

----> If we set the **Filter Cutoff Frequency** manually (by adjusting the parameter **FREQ =**__ on the **FILTER** Page) to a level of **64**, and turn all Modulators OFF, the Filter will open up to that level when a key is pressed, allowing frequencies below the Cutoff point to pass, and close down to Zero when the key is released.

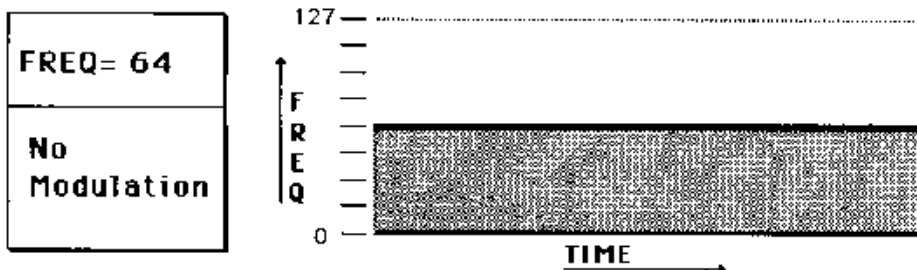

- > If we select an Envelope as a Modulator on the **FILTER** Page and assign it a value greater than Zero, its effect will be added to the the Manual Level.

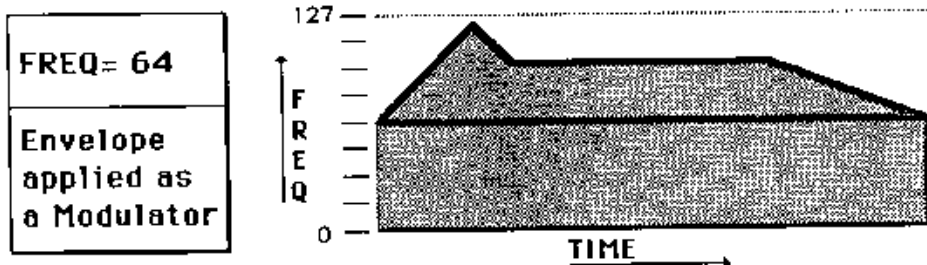

- > If, instead, we generate a Triangle-shape wave with one of the **LFOs (Low Frequency Oscillators)**, and apply that LFO wave as a Modulator on the **FILTER** Page, its effect will be added to the Manual Level, and the **Filter Cutoff Frequency** will rise and fall with the cycles of the LFO.

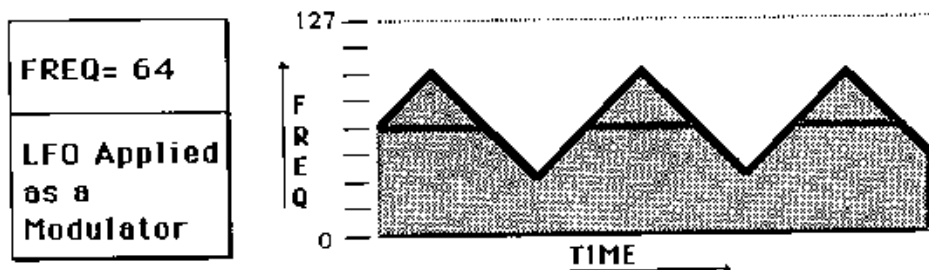

Of course, since two Modulators can be selected, you could apply both of these Modulators (or any other combination) to the **Filter Cutoff Frequency**, and their effect would be added together, and then added to the Manual Level.

As with Oscillator Volume, If the Manual Level on the **FILTER** Page is set to **FREQ= 00**, the **Filter Cutoff Frequency** will depend entirely on the depth and settings of any Modulators applied there.

Limits of Modulation

For all Modulation effects there is a maximum and a minimum range that cannot be exceeded. For example, if the **Filter Cutoff Frequency** is manually set to its maximum value [127], you will not be able to modulate the Frequency any higher, with an Envelope, LFO or other Modulator.

You cannot modulate an Oscillator's Output Level lower than Zero (silence). If a Modulator doesn't seem to be having any effect, check that the other Modulators and manual settings are at appropriate levels.

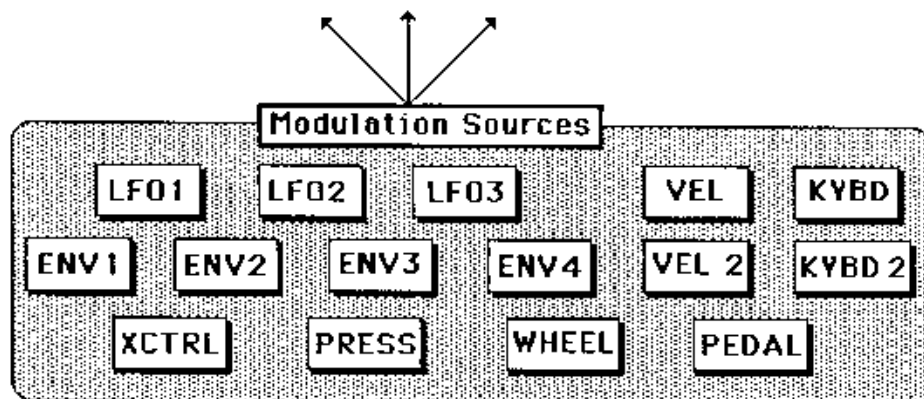
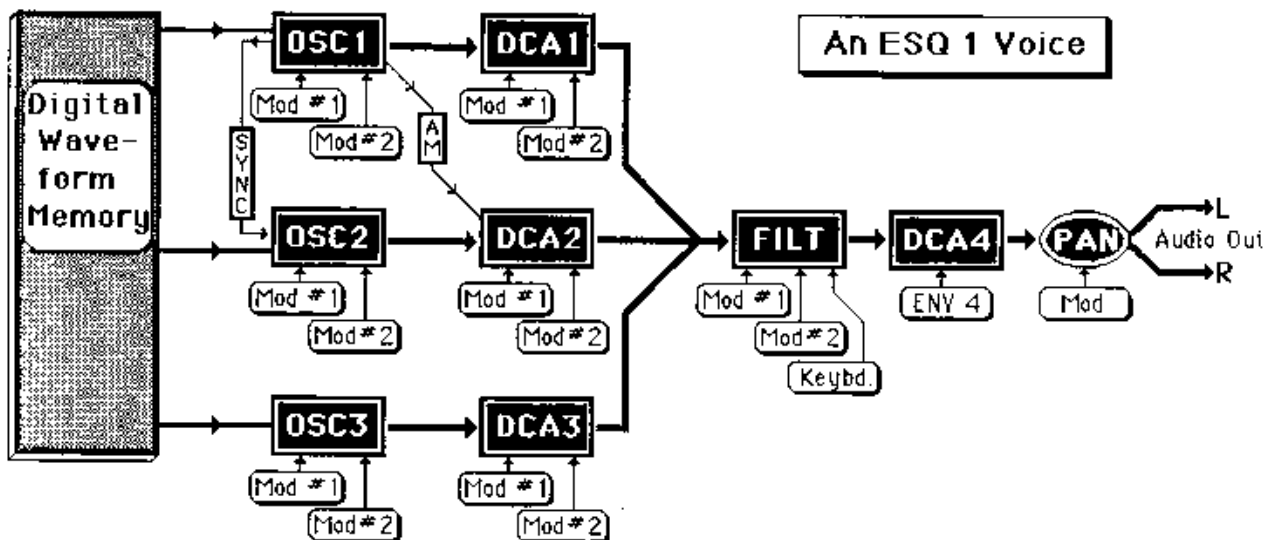

Any of these 15 Modulation Sources can be independently assigned wherever a MOD is indicated above.

For each of the ESQ 1's 8 Voices:

- Each Oscillator plays a Waveform from the Digital Waveform Memory;
- The output of each Oscillator passes through the same-numbered DCA (Digitally Controlled Amplifier);
- The output of the 3 DCA's passes through the Four-Pole Low-pass Filter;
- The output of the Filter goes to the Final DCA -- DCA 4;
- The output of DCA 4 goes to the Panner, which pans the Program between the Left and Right Audio Outputs.
- Wherever a **Mod** is indicated in the above diagram, any of the 15 available Modulators may be assigned to vary the "Manual" setting.

PROGRAMMING PAGES

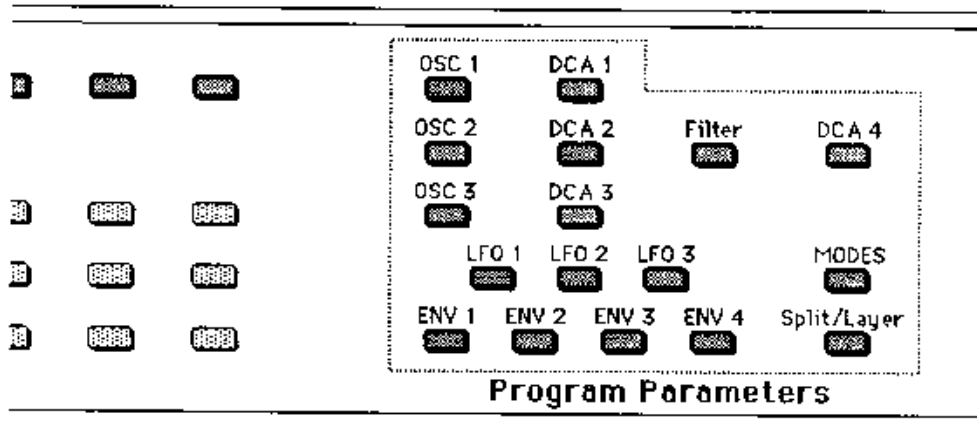

The **Page** descriptions in this Section encompass all the **Program Parameters** -- those Parameters which are saved with the individual Programs stored in the Memory of the **ESQ 1**.

In case you wish to make a written record of the settings for a particular Program, you will find a blank **Program Parameter Sheet** in the back of this Manual. **Feel free to photocopy this sheet and use the copies to record the Parameter settings.**

[OSC1] OSCILLATOR PITCH PAGE
[OSC2]
[OSC3]

Controls Oscillator pitch and selects the waveform to be played.

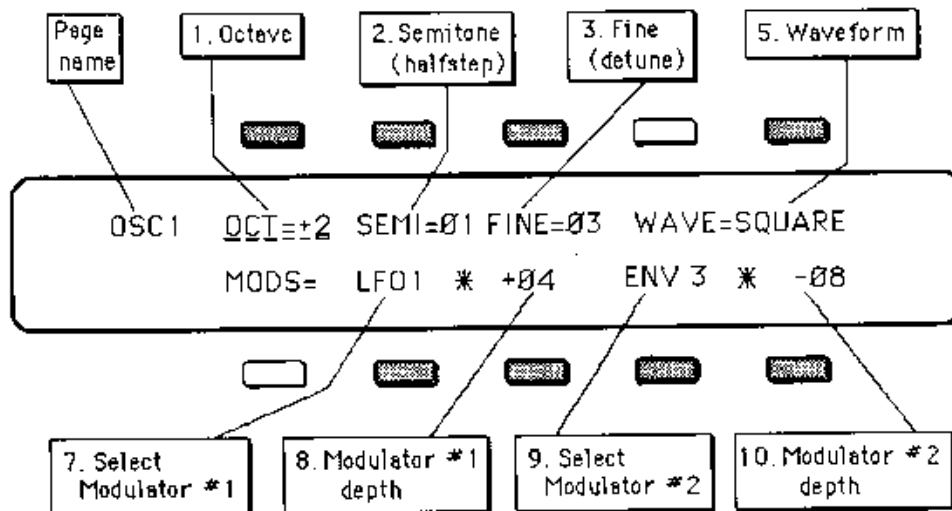

(Inactive Buttons appear in White)

The format of the **Oscillator Pitch Page** is the same for [OSC 1], [OSC 2] and [OSC 3], although each of these Pages is entirely independent.

Use these pages to:

- 1) Adjust the pitch of each Oscillator by octave, semitone, and fine increments;
- 2) Modulate the pitch of each Oscillator using any of the 15 available Modulation sources; and
- 3) Select the Waveform to be played by each Oscillator.

[OSC] OSCILLATOR PITCH PAGE (cont'd)

ACTIVE CONTROLS:

1. OCT

Adjusts the pitch of the Oscillator by octaves.

Range: -3 To +3.

2. SEMI

Adjusts the pitch of the Oscillator up by semitones (halfstep). Adjusting this control upwards beyond 11 automatically increases the **OCTAVE** by one.

Range: 0 To 11.

3. FINE

Adjusts the pitch of the Oscillator up by fine steps (detunes). Each step here is about 3 Cents (hundredths of a semitone).

Range: 0 To 31.

5. WAVE

Selects the **Waveform** that the Oscillator will play from among the 32 available Waveforms. (See **WAVEFORMS**, p. 25.)

7. MOD # 1

Selects the first source of Modulation. The Modulators selected on this page affect only the pitch of the Oscillator.

8. MOD # 1 DEPTH

Sets the depth, or amount, by which Modulator #1 will affect the pitch of the Oscillator. The Modulation amount can be positive or negative.

Range: -63 To + 63.

9. MOD # 2

Selects the second source of Modulation. The effects of Modulator #1 and Modulator #2 are added together. You can thus double the maximum Modulation depth of a given modulator by selecting the same source for Modulator #1 and Modulator #2. The Modulators selected on this page affect only the pitch of the Oscillator.

10. MOD # 2 DEPTH

Sets the depth, or amount, by which Modulator #2 will affect the pitch of the Oscillator. The Modulation amount can be positive or negative.

Range: -63 To + 63.

[DCA1] OSCILLATOR VOLUME PAGE
[DCA2]
[DCA3]

Controls The Volume of Oscillators 1 through 3.

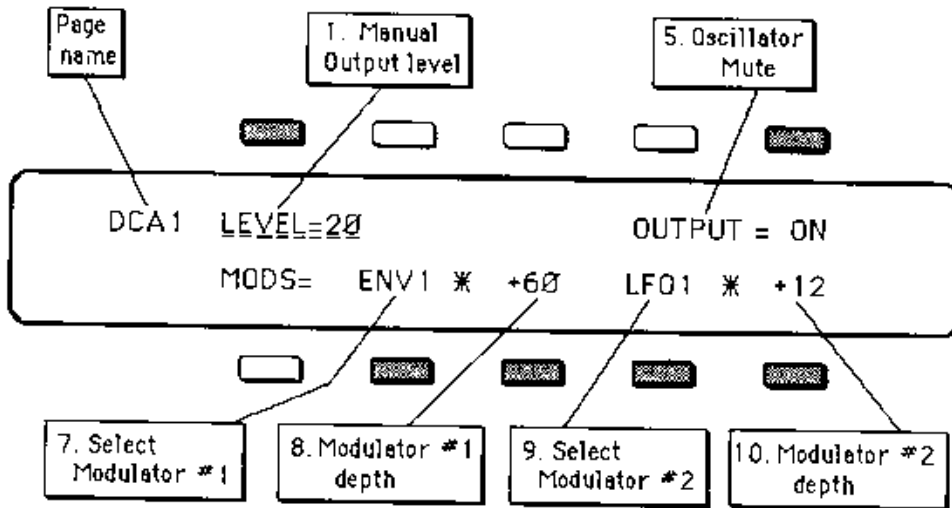

(Inactive Buttons appear in White)

The format of the **Oscillator Volume Page** is the same for [DCA1], [DCA2] and [DCA3], although each of these Pages is entirely independent.

Each of these three **DCA's** (Digitally Controlled Amplifiers) controls the Volume (or amplitude) of the same-numbered Oscillator (**OSC**).

Use these pages to:

- 1) Set the Manual Output levels of the three Oscillators;
- 2) Modulate those levels using any of the 15 available Modulation Sources; and
- 3) Turn each Oscillator ON or OFF.

ACTIVE CONTROLS:

1. LEVEL

Determines the Manual, or base, volume (amplitude) of the Oscillator. This Level can be thought of as a 'Volume floor' -- the effect of any Modulator(s) is added to the Level set by this parameter. So even if **LEVEL = 0**, the Oscillator will still have some amplitude if there is a Modulator (an **Envelope** for instance,) selected and assigned a Depth greater than Zero. Negative modulation depths bring the volume lower than the **LEVEL** setting. Large amounts of negative Modulation can silence the Oscillator, regardless of the setting of this control.

DCA's 1, 2, and 3 have been set up so that it is possible to get full volume from just one Oscillator. This means, however, that it is possible to clip (overload) the output stage when all three Oscillators are at full level. Different Waveforms contain different amounts of fundamental energy, so the effect will vary. a conservative rule of thumb for Oscillator Volume is as follows:

With 1 Oscillator playing -- set that Oscillator to **63**.

With 2 Oscillators playing -- set both Oscillators to **56**.

With 3 Oscillators playing -- set all three Oscillators to **52**.

5. OSCILLATOR MUTE

Turns the Output of the Oscillator **ON** or **OFF**. This control is very helpful when setting up complex Programs, as it allows you to silence any Oscillator, and listen to the others, without disturbing your settings.

7. MOD # 1

Selects the first source of modulation. The modulators selected on this page affect only the amplitude of the Oscillator.

8. MOD # 1 DEPTH

Sets the depth, or amount, by which Modulator #1 will affect the amplitude of the Oscillator. The Modulation amount can be positive or negative.

Range: -63 To +63.

9. MOD # 2

Selects the second source of modulation. Again, a Modulator's maximum depth can be doubled, by assigning the same Modulator to **MOD #1** and **MOD #2**. The Modulators selected on this page affect only the amplitude of the Oscillator.

10. MOD # 2 DEPTH

Sets the depth, or amount, by which Modulator #2 will affect the amplitude of the Oscillator. The Modulation amount can be positive or negative.

Range: -63 To +63.

[FILT] FILTER PAGE

Controls the Four-Pole Low Pass Filter

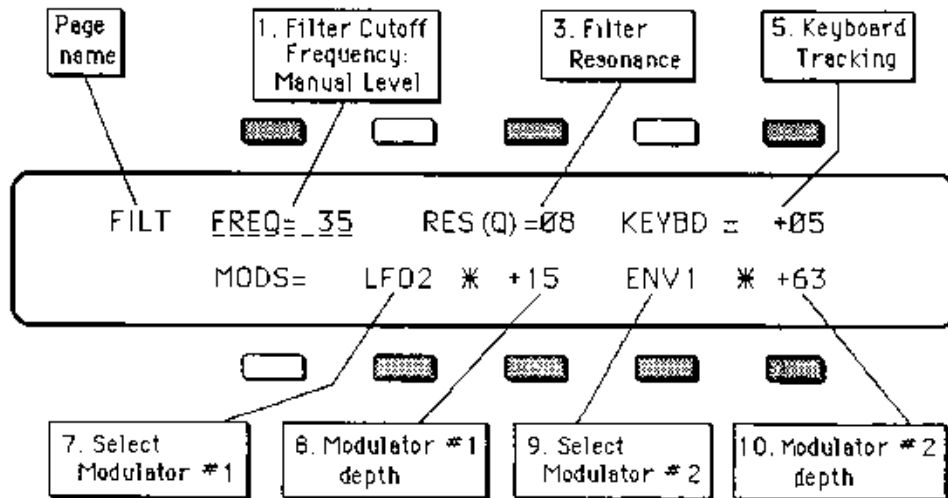

(Inactive Buttons appear in White)

The outputs of the three Oscillators pass through the **Filter** before going to the Final Volume stage, [DCA4]. The **Filter settings** determine what frequencies will be allowed pass through to the output.

A **Low Pass Filter** allows only those frequencies below the **Filter Cutoff Frequency** to pass. Higher frequencies are filtered out. The Filter Cutoff Frequency is set to a certain level, and then it can be continually varied by modulating the Filter (with an **Envelope**, an **LFO**, **Velocity**, etc.).

Use this page to:

- 1) Set the **Manual Level** for the **Filter Cutoff Frequency**;
- 2) Set the amount of Filter Resonance (or **Q**); and
- 3) Modulate the **Filter Cutoff Frequency**, using the Keyboard "Control Voltage" and any of the 15 available Modulation Sources.

[FILT] FILTER PAGE (cont'd)

ACTIVE CONTROLS:

1. **FREQ**

Sets the initial, or Manual Level of the **Filter Cutoff Frequency**. A higher setting will result in a brighter sound. This setting represents the "Filter Floor" -- the effect of any selected Modulators will be added to (or subtracted from) this level.

Range: 0 To 127.

3. **RES (Q)**

Sets the amount of **Filter Resonance**, or **Q**. This controls the amplitude of the resonant peak of the filter. When the **Q** is raised, the Filter Cutoff Frequency is emphasized over all other frequencies. By then modulating the Filter Cutoff Frequency with an Envelope, LFO, Mod Wheel etc., you can create Filter Sweeps, Wah and Growl effects.

Range: 0 To 31.

5. **KEYBD**

Keyboard Filter Tracking. It sets the amount by which the location of a note on the keyboard will modulate the **Filter Cutoff Frequency**. (This is comparable to the **Keyboard Control Voltage** of most Analog synths.)

Higher values of this parameter will cause the Filter to open up more (get brighter) as you play higher up the keyboard. The maximum value (**63**) will raise the Filter Cutoff Frequency roughly one octave for each octave you go up the Keyboard.

Range: 0 To 63.

7. **MOD # 1**

Selects the first source of Modulation for the **Filter Cutoff Frequency**.

8. **MOD # 1 DEPTH**

Sets the depth, or amount, by which Modulator #1 will affect the **Filter Cutoff Frequency**. Modulation amounts can be positive or negative.

Range: -63 To + 63.

9. **MOD # 2**

Selects the second source of Modulation for the **Filter Cutoff Frequency**.

10. **MOD # 2 DEPTH**

Sets the depth, or amount, by which Modulator #2 will affect the **Filter Cutoff Frequency**. Modulation amounts can be positive or negative.

Range: -63 To + 63

[DCA 4] FINAL VOLUME PAGE

Controls Program Volume and Panning.

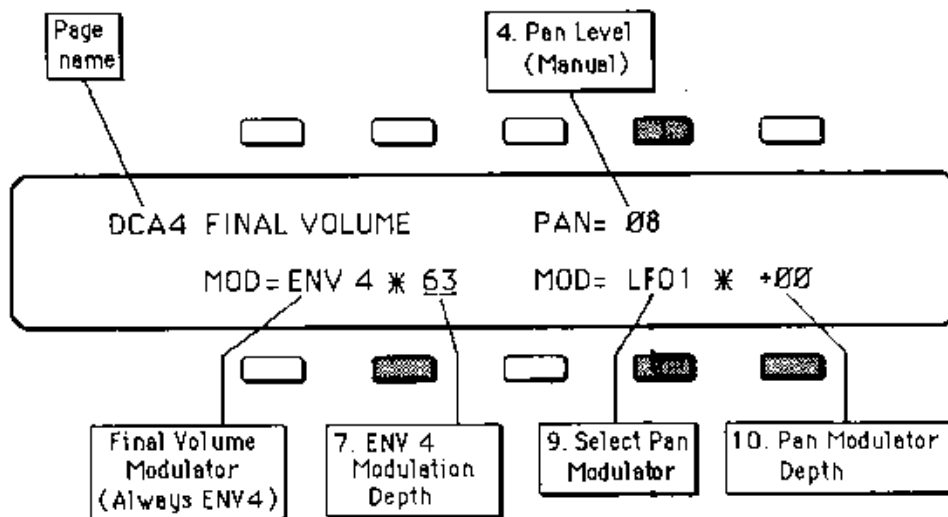

(Inactive Buttons appear in White)

Note: The Modulation Source for [DCA 4] is always [ENV 4].

The outputs of the three Oscillators, after passing through the Filter, go to [DCA4]. This Final **DCA** (Digitally Controlled Amplifier), together with [ENV4], which is fixed as its Modulator, determines the overall volume envelope of the Program.

Use this page to:

- 1) Adjust the amplitude of the entire Program;
- 2) Pan the Program left, right or center; and
- 3) Modulate the Program Pan using any of the 15 available Modulation Sources.

ACTIVE CONTROLS:

4. PAN -- Manual Level

Pans the Program the between the Left and Right Outputs. Possible Values range from **00** (all the way to the Left), to **15** (all the way Right.) A value of **08** will pan the Program to Center. Note that the **ESQ 1's** audio outputs must be connected in Stereo for this parameter to have any effect.

Range: **00** to **15**.

8. ENV 4 MOD. DEPTH -- Final Volume

Determines the amount by which **DCA 4** will be Modulated by **ENV 4**, which is fixed as its Modulator. The net-effect of this parameter is to increase or decrease the Volume of the entire Program. This is useful for matching the levels of different Programs, to avoid radical volume changes when switching between them. Also it is useful for balancing the relative levels of Split and/or Layered Programs (see **SPLIT/LAYER** Page, p. 66).

Range: **00** to **63**.

Bear in mind that the overall Volume of the Program will depend on the setting of this parameter and the settings on the **ENV 4** Page.

9. Select PAN Modulator

This control selects a Modulator for the **PAN** Setting. Modulators applied here will add to, or subtract from, the Manual Level, just as they do elsewhere. Thus an **LFO** used as a Modulator here will make the Program Pan back and forth with Time. Applying **Velocity [VEL]** here would make a note's placement in the stereo mix depend on how hard you strike a key. And so on.

Or you can apply the Keyboard (**KYBD 2**) as a Modulator to make the low keys play on the left side, the middle keys in the middle, and the high keys on the right side of the stereo mix.

10. PAN Modulator Depth

Sets the amount by which the **PAN Modulator** will affect the Manual Pan Setting. Higher values will cause more dramatic Pan Modulation. Negative Modulation Depths are particularly useful here. Any Negative value here (**-32** for instance) will have exactly the opposite effect of the same, Positive, value (**+32**) in terms of how it affects the Pan of the Program (assuming a Manual Level of **08**).

Range: **-63** to **+63**.

[LFO 1] **LOW-FREQUENCY OSCILLATOR PAGE**
[LFO 2]
[LFO 3]

Controls the three Low-Frequency Oscillators (LFO's)

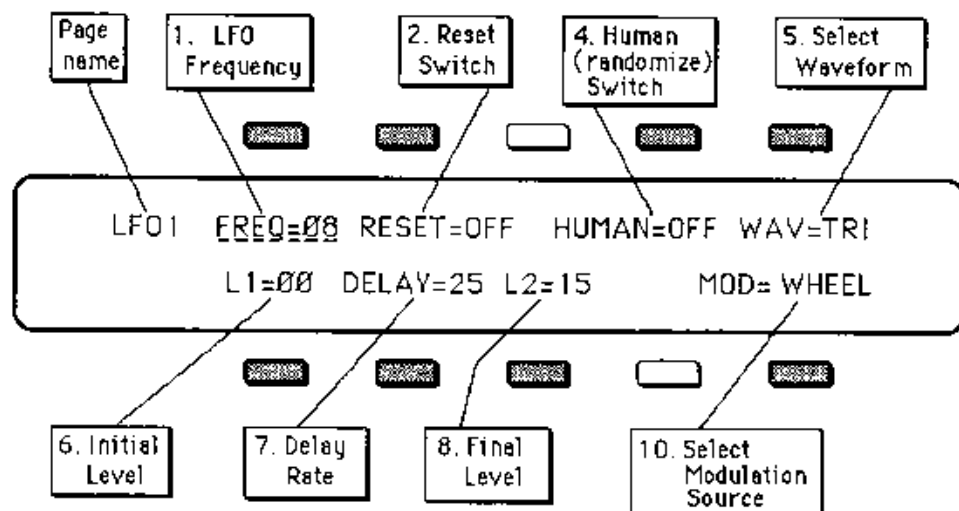

(Inactive Buttons appear in White)

The format of the **LFO Page** is the same for [LFO 1], [LFO 2], and [LFO 3], although each of these Pages is independent. The **Low Frequency Oscillators** are used as **Modulators**, and may be applied wherever a **Modulation Source** is to be selected.

Note that the **LFO Delay** (which normally allows the effect to enter gradually) is set using a **Ramp** which goes from **Level 1 (L1)** to **Level 2 (L2)**. Since **L1** can have a higher value than **L2**, the Ramp can actually be a decreasing one, causing the effect of the **LFO** to diminish, or disappear, over the time the key is held down.

Use this page to:

- 1) Set the **LFO Frequency** (speed);
- 2) Determine whether the **LFO** resets each time a key is struck;
- 3) Select the waveform that the **LFO** will play;
- 4) Set **LFO Delay** parameters; and
- 5) Select a **Modulator** from any of the 15 available Sources to modulate the Output Level of the **LFO**.

ACTIVE CONTROLS:

1. LFO FREQ.

Determines the speed of the LFO. Range: 0 To 63.

2. RESET

Turns **RESET** mode on or off.

When ON: The LFO Waveform will return to the beginning of its cycle each time a new key is struck. This is good for synchronizing LFO sweeps with key hits.

When OFF: The LFO wave will cycle continuously, without Resetting.

4. HUMAN

When ON: This control will add a random element to the LFO Frequency, making the effect less "mechanical" sounding.

When OFF: The LFO Frequency will behave normally, with perfect repetition.

5. WAV

Selects the **Waveform** which the LFO will play. The choices are:

TRI -- Triangle wave

SAW -- Rising Sawtooth wave (Use negative modulation for a falling Sawtooth.)

SQR -- Square wave (positive-going only)

NOISE -- Random

NOTE: Controls # 6., 7., and 8. combine to form a linear Ramp which defines the LFO Delay. The Ramp goes from **LEVEL 1**, which is the starting Level, to **LEVEL 2**, which is the sustain Level, and it can be an increasing or a decreasing Ramp.

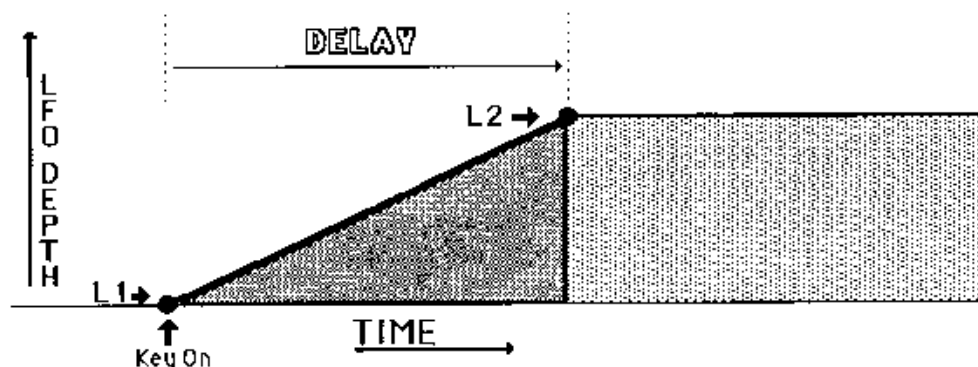

Example of LFO Modulation which 'fades in' over Time.

[LFO] LOW FREQUENCY OSCILLATOR PAGE (cont'd)

6. L1

This is **LEVEL 1**, the Level at which the **LFO** will play when the key is first struck.
Range: 0 To 63.

7. DELAY

Determines the **Rate** at which the **LFO's** amplitude will go from **LEVEL 1** to **LEVEL 2**. Range: 0 To 63.

Note that here it is the Rate of Change (or the Slope of the Ramp) which is set, not a fixed Time. Therefore, **lower** values of this parameter will cause a **longer** Delay; **higher** values will result in a **shorter** Delay. The amount of Time it takes for the **LFO** to reach **LEVEL 2** thus depends on both the Rate and the Level.

A value of Zero will cause the LFO to remain at LEVEL 1.

8. L2

This is **LEVEL 2**, the Level that the **LFO** will reach at the end of the Ramp defined by the **DELAY**. It will remain at this Level until the key is released.
Range: 0 To 63.

10. MOD

Selects the **Modulation Source** for **LFO** depth. The effect of this Modulator is added to the amount of **LFO** depth provided by the Ramp defined by Controls # 6., 7. and 8.

Note that the **LFO** itself can be used to modulate its own Output, or that of another **LFO**, producing unusual **LFO** waveforms.

The final, modulated, **LFO** Output is then available as a Modulation Source, whose depth can be adjusted precisely using the Modulation Depth controls on the other Pages.

*** * * * Note: To use the MOD Wheel for Vibrato** within a Program, perhaps the most common application for an **LFO**:

- 1) assign **WHEEL** as the Modulator for an **LFO**,
- 2) set **L1** and **DELAY** to Zero for that **LFO**, and
- 3) assign that **LFO** to modulate the Pitch of the Oscillators (**OSC** Pages).

Within the Factory Sounds that came with your **ESQ 1**, **LFO 1** is always used for Wheel Vibrato (where it is applicable).

UNDERSTANDING THE ENVELOPES

An **Envelope** is a shape, or "contour" that we apply to some signal source to make it change through time. Naturally occurring sounds have their own Envelopes. They don't just start and stop -- they might start loud and fade to silence, or slowly swell from silence to a huge crescendo; they might start out very bright and grow duller; they might have subtle variations in pitch, and so on.

In a synthesizer we imitate these effects, and create wholly new ones, by generating Envelopes and then using them to modulate pitch, volume, brightness, etc. The **ESQ 1** has four **Envelopes** which can be independently assigned as modulation sources to the various **OSC's**, **DCA's**, **LFO's**, **PAN** and the **FILTER**.

The ADSR Connection

Let's start by taking a look at the commonly used **ADSR** (Attack, Decay, Sustain, Release) type Envelopes found on many synthesizers. With the **ADSR** Envelope, the name says it all. You have four parameters to control:

- Attack** -- The Time it takes to go from zero, when a key is struck, to peak level
- Decay** -- The Time it takes to go from the peak level to the Sustain Level
- Sustain** -- The Level at which the signal remains as long as the key is held down
- Release** -- The Time it takes to return to zero after the key is released

ADSR Envelope

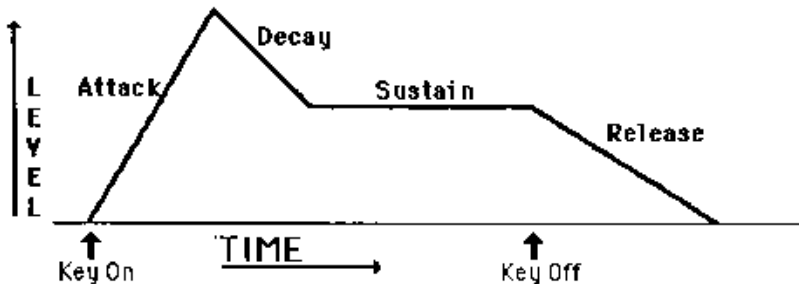

Notice that an Envelope is really just a series of Levels that change through Time. With the four parameters of the **ADSR** Envelope, we can control three Times (Attack, Decay and Release) and one Level (Sustain). This is fine for many basic volume and brightness Envelopes, but for more complex sounds -- for subtle pitch Envelopes and other cool effects -- it becomes necessary to have more specific control over more **Times** and **Levels**. Which brings us back to the **ESQ 1**.

UNDERSTANDING THE ENVELOPES (Cont'd)

Times and Levels

The four Envelopes on the **ESQ 1** are defined in terms of **Time** and **Level**. For each Envelope, you have control over four **Time** segments (**TIME 1**, **TIME 2**, **TIME 3**, and **TIME 4**) and three **Levels** (**LEVEL 1**, **LEVEL 2** and **LEVEL 3**).

When a key is struck, the **Envelope** level, starting at Zero, takes a fixed amount of time, defined by **TIME 1**, to reach **LEVEL 1**. It then takes **TIME 2** to reach **LEVEL 2**. Next, at the end of **TIME 3** it reaches **LEVEL 3**, where it will remain as long as the key is held down. After the key is released the signal takes **TIME 4** to return to Zero.

The four **TIME** parameters appear on the **Envelope Page** as [T1], [T2], [T3] and [T4], the three **LEVEL** parameters as [L1], [L2] and [L3]. The figure below shows a typical Envelope as defined by the **ESQ 1** Envelope parameters:

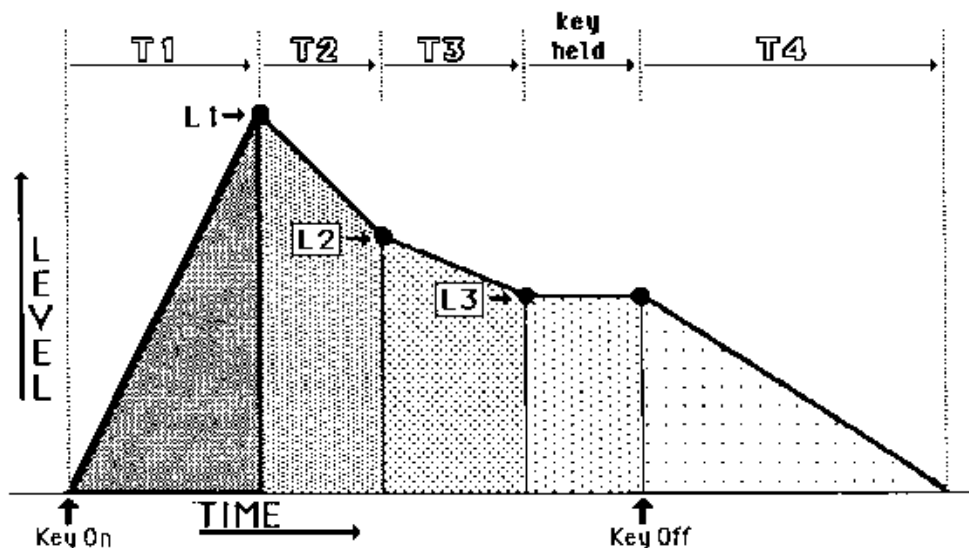

Notice that the Envelope shape depicted above resembles the **ADSR** Envelope discussed earlier. Though this is only one of many shapes that are possible with the **ESQ 1** Envelopes, it is one of the most useful for modulating the Volume and Brightness of a Sound.

If we now look at the **ESQ 1** Envelope parameters as they apply to this standard **ADSR**-type Envelope, we can see that **TIME 1** represents the attack time; **TIME 2** and **TIME 3**, a two-stage decay; and **TIME 4** represents the release time. **LEVEL 1** is the peak level; **LEVEL 2** is an intermediate decay level; and **LEVEL 3** is the sustain level.

UNDERSTANDING THE ENVELOPES (Cont'd)

Time, not Rate

It is very important to note that all of the Envelopes' **Time** components, [T1], [T2], [T3] and [T4] are expressed in terms of **Time, not Rate**. Thus, for example, when a key is struck the signal will always travel from Zero to **LEVEL 1** in the fixed amount of time defined by **TIME 1**. If the value of **LEVEL 1** is raised, the signal will still reach the new, higher, **LEVEL 1** in the same amount of time.

Negative Levels

In the sample Envelope shown above, all of the **Level** values were positive. But the **ESQ 1** also allows you to assign a negative value to any of the Envelope **Levels**, making possible a wide variety of interesting shapes. In the Envelope below, for example, **LEVEL 2** is given a value of **-32**.

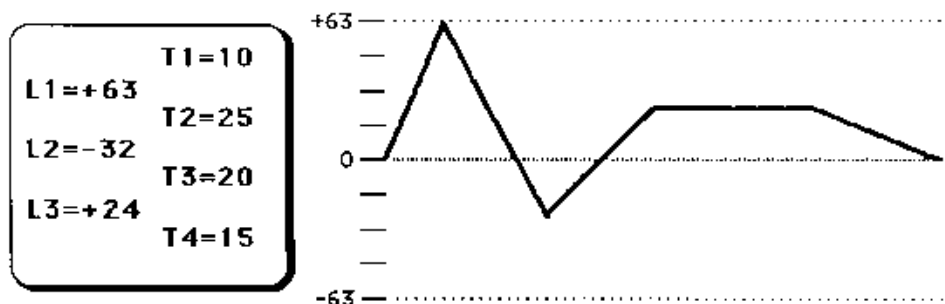

Example of Envelope with LEVEL 2 Negative

Such an Envelope allows you to modulate a signal to levels below the Manual settings, as well as above them. Say you apply the Envelope shown above as a modulator to the **Filter Cutoff Frequency**. If the Manual setting on the **FILTER** Page, (**FREQ=**__) is set for about 2 khz., modulating the **Filter Cutoff Frequency** with this Envelope would cause the **Filter** to behave like this:

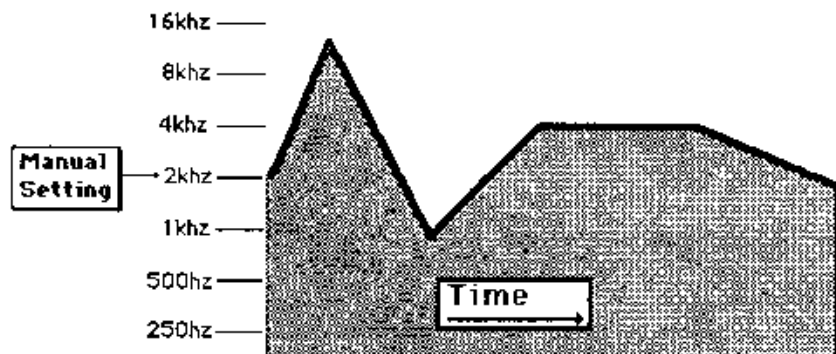

Filter Cutoff Frequency Modulated by a Complex Envelope

UNDERSTANDING THE ENVELOPES (Cont'd)

The extent of the effect in the example above would vary depending on the **Modulation depth**. Bear in mind that **Modulation depth** can also have a negative value. The combination of negative **Envelope Levels** and negative **Modulation depths** makes for almost infinite possibilities for controlling Pitch, Volume, Brightness, LFO depth, etc.

Other Envelope Shapes

There are many possibilities for creating interesting Envelopes -- here are just a few. If **LEVEL 1** is set to Zero, then **TIME 1** becomes a delay, **TIME 2** the attack time, **LEVEL 2** the peak level, and so on. Such an Envelope, applied to one of the **DCA's**, would cause that Oscillator to "wait" before beginning to play.

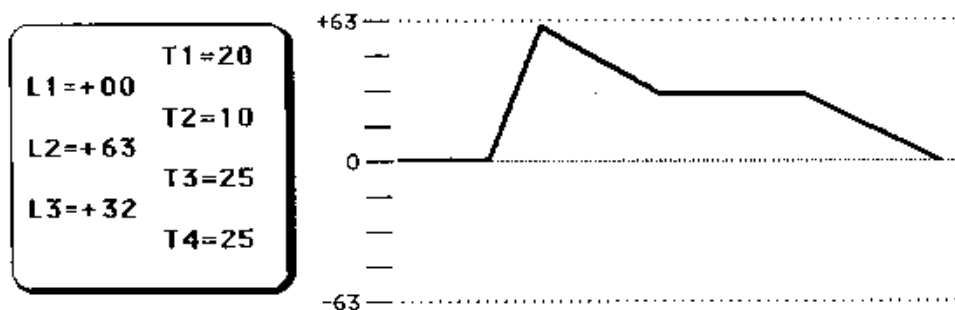

If LEVEL 1=0, TIME 1 Acts as a Delay

Another useful shape is a simple pitch Envelope. You can, for example, imitate the way Horns often "slide" into a note, rather than beginning right on pitch. By setting **TIME 1** to Zero, **LEVEL 1** to some negative value, and **LEVEL 2** and **LEVEL 3** to Zero, you now have an Envelope which, when used to modulate Oscillator Pitch, will cause the pitch to "slide" up to the proper note in the amount of time defined by **TIME 2**.

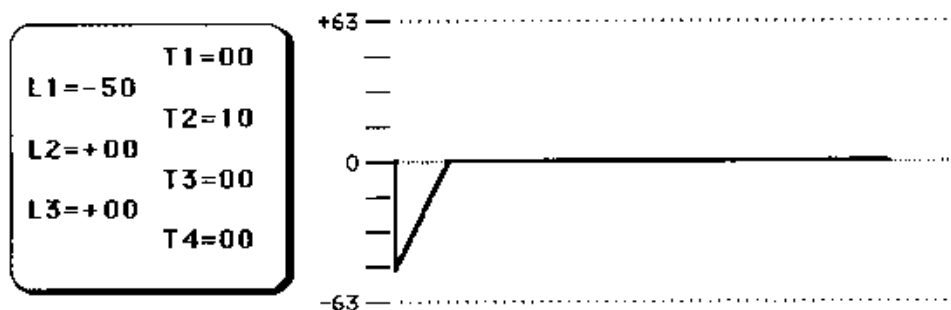

Rising Pitch Envelope

This could be a rather long, dramatic "slide", or an almost imperceptibly short one, depending on the value you assign to **T2**. How much the Pitch is altered will depend on the value of **LEVEL 1** and the Modulation depth.

UNDERSTANDING THE ENVELOPES (Cont'd)

Limits of Modulation

Note that for all Modulation effects there is a maximum and a minimum range that cannot be exceeded. For example, if the **Filter Cutoff Frequency** is manually set to its maximum value [127], you will not be able to modulate the Frequency any higher with an Envelope or other Modulator. You cannot modulate an Oscillator's Output Level lower than Zero (silence). If an Envelope or other Modulator doesn't seem to be having any effect, check that the other Modulators and manual settings are at appropriate levels.

Velocity Control Of Envelopes

There are two parameters on the **Envelope** Page allow you to alter an Envelope depending on keyboard velocity, or how hard you strike a key.

[LV] Velocity Level control

The first of these, **LV** or **Velocity Level Control**, will lower all three levels (**L1**, **L2** and **L3**) with a softer keystrike. This means that the settings you assign to **LEVEL 1**, **LEVEL 2**, and **LEVEL 3** are maximum Levels, the Levels that will be reached with the hardest keystrike. The amount of **LV** determines how much those Levels will be reduced as you play softer.

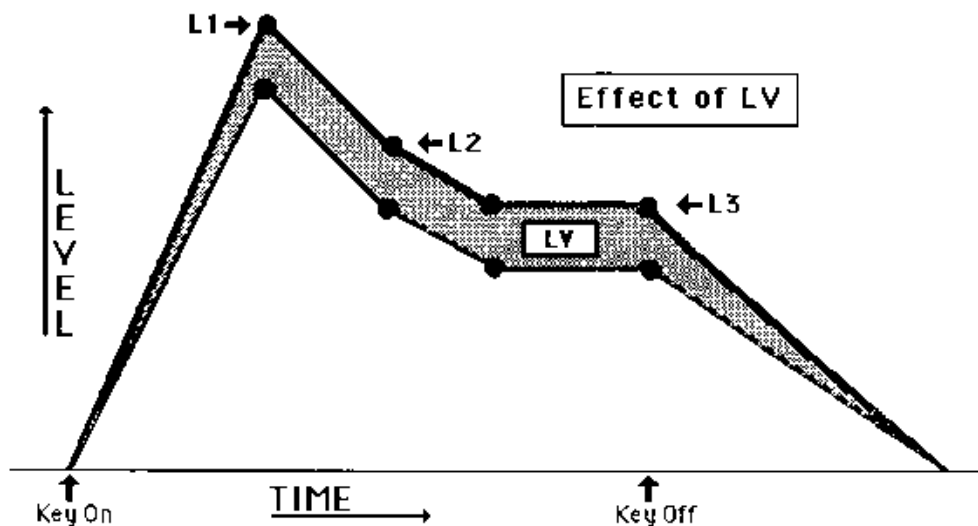

With this parameter you can have continuous dynamic control over the three levels by varying how hard you play. The most common uses of the **Velocity Level Control** have to do with varying the volume and brightness of a Program, though in the previous example, **[LV]** could be used to alter the depth of the **Pitch Envelope** with velocity.

UNDERSTANDING THE ENVELOPES (Cont'd)

[T1V] Velocity Attack control

The second velocity-related parameter is **T1V -- Velocity Attack Control**. As the name implies this parameter makes **TIME 1**, the Envelope attack time, respond to keyboard velocity. When the value of **T1V** is increased, a harder keystrike will decrease **TIME 1**, resulting in a faster attack.

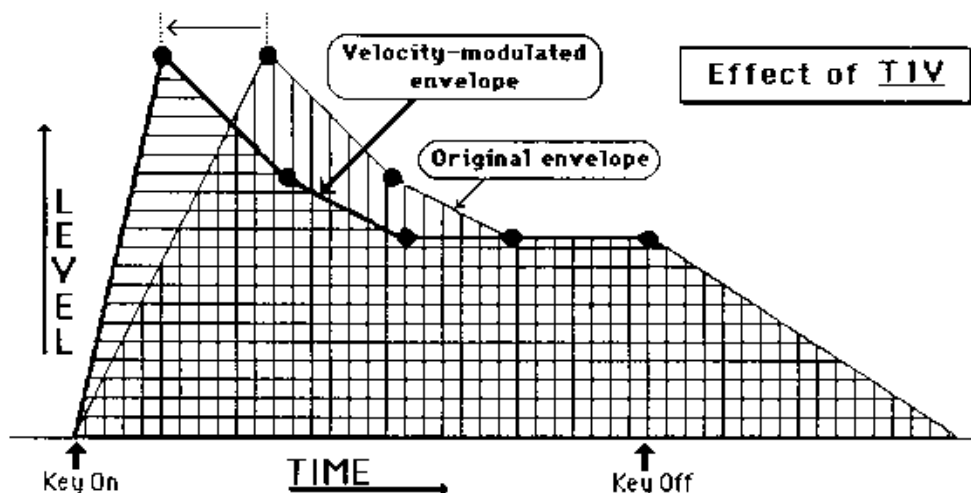

This allows for great expression on String sounds and the like, making it possible to have a long, smooth Attack or a sharp, crisp Attack simply by varying how hard you play. The greater the value of **T1V**, the more **TIME 1** will be decreased with velocity. If **TIME 1** already equals Zero, this parameter will have no effect.

[TK] Keyboard Decay Scaling

The final Envelope parameter is **[TK] -- Keyboard Decay Scaling**. Raising the value of **TK** has the effect of decreasing **TIME 2** and **TIME 3** as you play higher up the Keyboard. Higher notes will therefore decay faster than lower ones. The higher the value assigned to **TK**, the greater the difference in Decay Time between the highest and lowest notes. This is useful for simulating the Decay patterns of many acoustic instruments (piano, for instance) whose lower notes tend to ring much longer than the higher ones.

Note that if **TIME 2** and **TIME 3** both have a value of Zero, this parameter will have no effect.

UNDERSTANDING THE ENVELOPES (Cont'd)

Envelope Times

The chart below gives the approximate amount of Time, in seconds, that corresponds to each possible value of the **Time** components of the Envelopes (**T1**, **T2**, **T3** and **T4**). The numbers in **bold** type are the values that can be assigned to **T1**, **T2**, **T3** or **T4**; the numbers in plain type show how long a **Time** each of those values will yield.

<u>T=:</u>	<u>Time(sec.)</u>	<u>T=:</u>	<u>Time(sec.)</u>	<u>T=:</u>	<u>Time(sec.)</u>	<u>T=:</u>	<u>Time(sec.)</u>
0	.00	16	.09	32	.57	48	3.62
1	.01	17	.10	33	.64	49	4.06
2	.01	18	.11	34	.72	50	4.56
3	.02	19	.13	35	.81	51	5.12
4	.02	20	.14	36	.91	52	5.75
5	.03	21	.16	37	1.02	53	6.45
6	.03	22	.18	38	1.14	54	7.24
7	.03	23	.20	39	1.28	55	8.13
8	.04	24	.23	40	1.44	56	9.12
9	.04	25	.25	41	1.61	57	10.24
10	.04	26	.29	42	1.81	58	11.49
11	.05	27	.32	43	2.03	59	12.90
12	.06	28	.36	44	2.28	60	14.48
13	.06	29	.40	45	2.56	61	16.25
14	.07	30	.45	46	2.87	62	18.25
15	.08	31	.51	47	3.23	63	20.48

- * * * **Note:** Envelope Times will be as shown above only when **TK=0**, and **T1V=0**. These two parameters have the effect of decreasing Envelope Times (**TK** based a note's position on the keyboard, and **T1V** based on Velocity.) If either has a value greater than Zero, **T1**, **T2** or **T3** could be shorter than indicated by the chart, depending on where and how hard you play.

[ENV 1] ENVELOPE PAGE
 [ENV 2]
 [ENV 3]
 [ENV 4]

Controls the parameters of the four Envelopes.

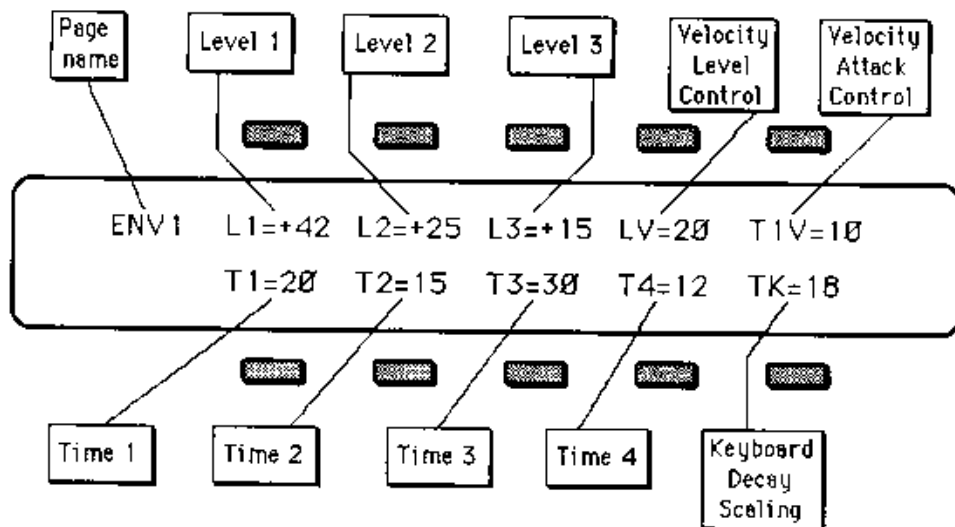

The format of the **Envelope Page** is the same for [ENV 1], [ENV 2], [ENV 3] and [ENV 4], although each Page is independent. The **Envelopes** are used as Modulators, and may be applied wherever a **Modulation Source** is selected.

All **Envelope** parameters are expressed in terms of **TIME** and **LEVEL**. It is important to note that the Time components of the **Envelopes** ([T1], [T2], [T3], and [T4]) each define a fixed Time, not a Rate. Thus, if you raise the value of **LEVEL 1** but leave **TIME 1** the same, the **Envelope** will still take the same amount of Time to reach the new, higher, **LEVEL 1**.

Also note that the **Level** parameters can be positive or negative. This allows for a wide variety of Envelope shapes, especially useful for modulating the **FILTER** Frequency, the pitch of an **Oscillator**, etc.

[ENV] ENVELOPE PAGE (cont'd)

ACTIVE CONTROLS:

1. L1 - LEVEL 1

This is the **LEVEL** that the Envelope will reach at the end of the Time defined by **TIME 1**. All Envelopes start at a level of Zero and proceed toward **LEVEL 1** when a key is pressed.

Range: -63 To +63.

2. L2 - LEVEL 2

The **LEVEL** that the Envelope will reach at the end of **TIME 2**.

Range: -63 To +63.

3. L3 - LEVEL3

The **LEVEL** that the Envelope will reach at the end of **TIME 3**. This is the **Sustain Level**. The Envelope will remain at this level until the key is released. After the Key is released, the Envelope will return to Zero.

Range: -63 To +63.

4. LV

Velocity Level Control. This parameter makes all three Levels, **LEVEL 1**, **LEVEL 2** and **LEVEL 3**, respond to Keyboard Velocity, or how hard you strike the key. When the value of [LV] is raised, a **softer** keystrike will **decrease** all three Levels. The greater the value, the more the Levels will decrease as you play softer. Thus the Levels set by **LEVEL 1**, **LEVEL 2** and **LEVEL 3** define the **maximum** Levels, and parameter [LV] **subtracts** from those Levels.

Range: 0 To 63.

5. T1V

Velocity Attack Control. This control makes **TIME 1** respond to Keyboard Velocity. Raising its value will cause a **decrease** in the value of **TIME 1** as a key is struck harder, shortening the Attack Time. The greater the value, the faster **LEVEL 1** will be reached with a hard keystrike. (This Parameter will have no effect if **TIME 1 = 0**.)

Range: 0 To 63.

6. T1 - TIME 1

The amount of Time between when the key is struck and when the Envelope reaches **LEVEL 1**. In most applications this is the **Attack Time**. The higher the value the longer the **TIME**.

Range: 0 To 63.

[ENV] ENVELOPE PAGE (cont'd)

7. T2 - TIME 2

The Time it takes the Envelope to go from **LEVEL 1** to **LEVEL 2**. In most applications this is the first of two **Decay** stages.

Range: 0 To 63.

8. T3 - TIME 3

The Time it takes the Envelope to go from **LEVEL 2** to **LEVEL 3**. In most applications this is second **Decay** stage. At the end of **TIME 3**, the Envelope will remain at **LEVEL 3** until the key is released.

Range: 0 To 63.

9. T4 - TIME 4

Release Time. Defines the amount of Time it will take the Envelope to return to Zero from **LEVEL 3** (or from whatever it currently is, if **LEVEL 3** has not yet been reached) after the key is released.

Range: 0 To 63.

10. TK

Keyboard Decay Scaling. Raising the value of this parameter will cause the value of both **TIME 2** and **TIME 3** to **decrease** as you go higher up the keyboard. Thus higher notes will decay faster than lower ones. This is true of many acoustic instruments. The greater the value of **[TK]**, the more the decay time will **decrease** as you play higher up the keyboard. **[TK]** will have no effect if **TIME 2** and **TIME 3** are Zero.

Range: 0 To 63.

[MODE] MODE PAGE

Controls Glide, Sync, AM, and Mono Modes, as well as Voice, Envelope and Oscillator Restart Modes.

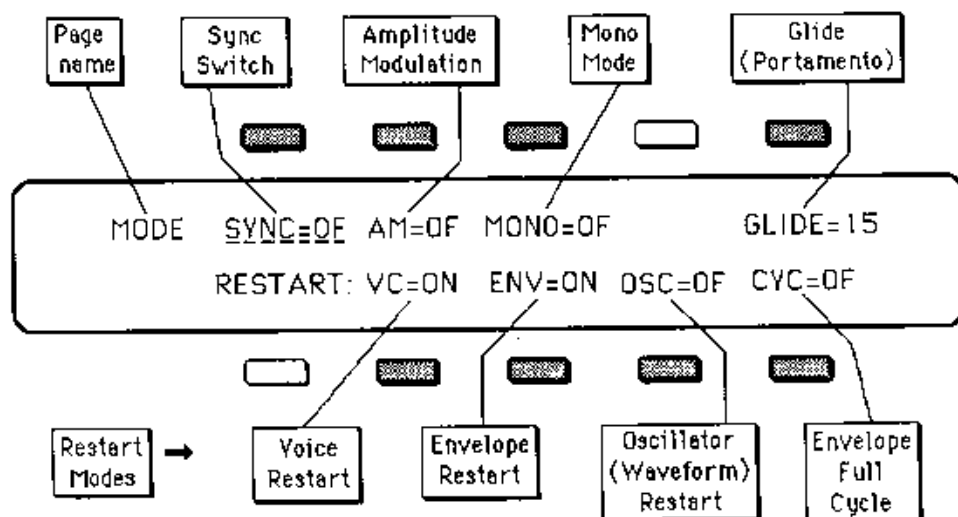

(Inactive Buttons appear in White)

All of the Parameters on this Page are part of the **Program** (or patch), and will apply only to the selected Program.

ACTIVE CONTROLS:

1. SYNC

Syncs the phase of **Oscillator 2** to that of **Oscillator 1**. In other words, whenever **OSC1** finishes playing one complete cycle of its waveform and begins another, **OSC 2** will reset to the beginning of its cycle, whether the previous cycle is complete or not.

This produces the popular "Hard Sync" effect, which can be similar to a Filter sweep. The effect is most noticeable when the Frequency of **Oscillator 2** is varied, or modulated.

2. AM

Amplitude Modulation. When ON, the Amplitude of **Oscillator 1** modulates the Amplitude of **Oscillator 2**. **OSC 2's** Amplitude Envelope will be ignored. This results in the creation of "Sideband" frequencies at the sum and difference of the frequencies being played by the two Oscillators.

[MODE] MODE PAGE (cont'd)

When **OSC 1** and **OSC 2** are tuned to simple intervals of each other (such as octaves or fifths, etc.), **AM Mode** can produce FM-like enharmonics, for bell sounds, etc. When the Oscillators are tuned to more complex intervals, the effect is more extreme.

Since the Amplitude of **Oscillator 2** is no longer being controlled by **DCA 2**, you must use **DCA 4** and **ENV 4** to control the volume of the Sound.

3. MONO

In **MONO mode** the **ESQ 1** behaves like a classic one-voice Monophonic synth. It is useful with lead-type sounds where chords are not necessary or desirable. With **MONO mode ON**, only one note can be played at a time. Priority is given to the **last note** played -- even if another note is being held down, the most recent note you play will sound. However, the envelope will not be re-triggered by striking a key as long as any other key is held down. **Mono mode** on the **ESQ 1** does not stack all eight voices on one key -- only one voice plays.

5. GLIDE

Also called **Portamento**. This causes the pitch of the Oscillators to "glide" between notes instead of the usual abrupt transition. The higher the value, the longer it will take to get from the pitch of the first note played to that of the second. Range: 0 To 63.

Note: The **GLIDE** function behaves in one of two ways, depending on whether or not **MONO mode** is engaged:

With **MONO mode OFF**: The pitch of any note played will 'glide' to its proper pitch from that of the note played immediately before it, at the rate that has been set. In this mode the **GLIDE** is **polyphonic**, and whole chords can be made to swoop up and down together. (Very dramatic.)

With **MONO mode ON**: You have what is called **Fingered Portamento**. If a key is pressed with no other keys held down, there is no **GLIDE**. If you then play a second key while holding down the first, the note will glide from the pitch of the first key to that of the second. Release the second key (still holding the first one down) and it glides back. In other words, **the effect is only present when a note is played while another key is held down**. You can thus play Staccato for runs without **GLIDE**, and Legato for runs with **GLIDE**.

Note: The next two Parameters (#7, [VC] VOICE Restart, and #8, [ENV] ENVELOPE Restart) affect only what happens when you play the same note twice in succession.

[MODE] MODE PAGE (cont'd)

7. VC --VOICE Restart

When ON: If the same key is restruck before the note has died away, it will be assigned the same **Voice** that was previously playing it. That Voice will be 'stolen' to play the new note. This is fine for many sounds, such as piano, but it can be annoying with others, especially sounds with long Attack or Release times, like strings, where you don't necessarily want a note to abruptly disappear just because you have played the same note again.

When OFF: If a key is restruck before the note has died away, a new **Voice** will be assigned to it, and the first Voice will continue to play. If there are already two Voices playing that note, the older of the two is 'stolen'. (Two Voices will alternate playing the note if it is struck repeatedly.) As mentioned above, for sounds with long Attack or Release times (such as long filter sweeps, etc.) this is often better.

8. ENV --ENVELOPE Restart.

When ON: If the same key is restruck, all four Envelopes will reset, and start their cycles at Zero level.

When OFF: Each Envelope will start its cycle at its present level, regardless of what that level is, when the same note is played again. It will then take **TIME 1** to reach **LEVEL 1**, whether the new ramp is in the same direction (up or down) as the original attack segment or not. In other words, each Envelope behaves normally, except that its **Starting Level**, normally Zero, becomes whatever Level it was at when the key was restruck.

9. OSC --Oscillator (Waveform) Restart

When ON: All three Oscillators are halted before the start of a sound, and are restarted together when a key is struck, so that they will start out playing in phase with each other. Any phasing, or "beating" between the oscillators (due to detuning, etc.) will be the same each time a key is struck.

When OFF: The Oscillators are not stopped before a new note is played, but continue to play. Therefore the relative phase of the Oscillators will be unpredictable. This will tend to randomly vary the phase shift and tonal characteristics of the sound.

10. CYC --Envelope Full Cycle Mode

When ON: The Envelopes will pass through their full cycles every time a key is struck. In this Mode the **ESQ 1** pays no attention to whether you hold the key down or let it go immediately -- each Envelope simply 'runs' through all its stages (ignoring the sustain stage after **TIME 3**) with each keystroke. This can be useful for many percussion-type sounds, bell sounds, filter sweeps and other sounds where you want consistently repeatable Envelopes that are not dependent on keyboard technique.

When OFF: This is the Normal Mode of operation. All Envelopes will reset and begin their cycles from Zero whenever a new key is struck.

[SPLIT/LAYER] Split/Layer PAGE

Controls Splitting the Keyboard and Layering Different Sounds together

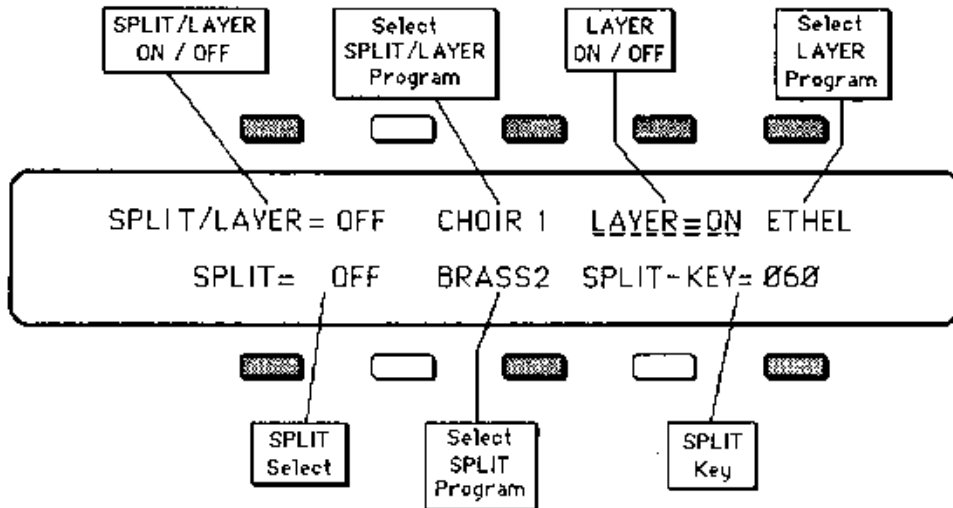

(Inactive Buttons appear in White)

Programs on the **ESQ 1** can be **Layered** (so that two Programs play at once over the whole keyboard), **Split** (so that each half of the keyboard plays a different Program), and **Split/Layered** (so that the **Split** Program is layered with yet another Program).

It is important to note that the parameters on this Page are all **part of the Program** -- that is, any **Split** and/or **Layer** configurations you set up here must be Saved as part of a new Program in order to be retained. For example, if you start with a Piano Program, and then Layer that with a String Program, you can now save the new Layered combination in a new Location -- the original String and Piano Sounds will remain intact in their original locations.

Also bear in mind that wherever two Programs are Layered, the **ESQ 1** becomes a four-voice Synthesizer -- it will start "stealing" voices after four have been played, rather than the usual eight.

Use this Page to:

- 1) Activate the **Layer** function;
- 2) Choose the **Layer Program**;
- 3) **Split** the Keyboard (Upper or Lower) between two different Programs;
- 4) Choose the **Split Program**;
- 5) Choose the **Split Key**;
- 6) Layer a second Sound with the Split Program (**Split/Layer** mode); and
- 7) Choose the **Split/Layer Program**.

ACTIVE CONTROLS:

1. SPLIT/LAYER ON/OFF

This activates the **Split/Layer** mode. In order for this control to have any effect, the Keyboard must first be **Split**, either Upper or Lower (see #6 below).

When ON: The **Split Program** will be Layered (will play simultaneously) with the Program whose name appears to the right of this control (#3). This will result in a reduction to four Voices only on the **SPLIT/LAYERED** half of the Keyboard.

3. Select SPLIT/LAYER Program

The Program whose name appears here will be Layered with the **Split Program** when an Upper or Lower Keyboard **Split** has been selected. It is possible to have a **Split/Layer** without **Layer** mode being on. The Program shown here is Layered only with the **Split Program**.

When this control is selected (Underlined), you can choose a new **SPLIT/LAYER** Program in one of two ways:

- 1) Use the **Data Entry Slider** and the **Up and Down Arrow** Buttons to scroll through the various Programs in Memory until you find the one you want; or
- 2) Press **Internal, CART A, or CART B** to select a Master Bank; then press one of the four **Bank Select** Buttons and, while holding it down, select the Program you want. You will be returned to the **Split/Layer** Page with the new Program selected as the **SPLIT/LAYER** Program. There will always be a Program name in this Location, whether the **SPLIT/LAYER** mode is engaged or not.

4. LAYER ON/OFF

This acts as a switch to turn On or Off the **Layer** mode.

When ON: The Current Program (the one you are editing) will be Layered (combined) with the Program whose name appears immediately to the right (see #5 below), and both Programs will play simultaneously. Activating the **Layer** mode reduces the number of available Voices to four (from eight).

5. Select LAYER Program

The Program whose name appears here will be Layered with the Current Program when the **Layer** mode is switched On. When this control is selected (Underlined), you can choose a new LAYER Program in one of two ways:

- 1) Use the **Data Entry Slider** and the **Up and Down Arrow** Buttons to scroll through the various Programs in Memory until you find the one you want; or
- 2) Press **Internal, CART A, or CART B** to select a Master Bank, then press one of the four **Bank Select** Buttons and, while holding it down, select the Program

[SPLIT/LAYER] Split/Layer PAGE (cont'd)

you want. You will be returned to the **Split/Layer** Page with the new Program selected as the **LAYER** Program.

There will always be a Program name in this Location, whether the **Layer** mode is engaged or not.

6. SPLIT Select

This control is used to **Split** the Keyboard between two Programs, as well as to determine which Keyboard half each will occupy. There are three possible states:

----> **OFF** -- Normal Keyboard assignment; no **Split**.

----> **UPPER** -- When **SPLIT=UPPER** is selected, the **Split Program** (see #8) will play on the Upper Keyboard (that is, above the **Split Key**), and the Current Program will play on the Lower Keyboard (below the **Split Key**).

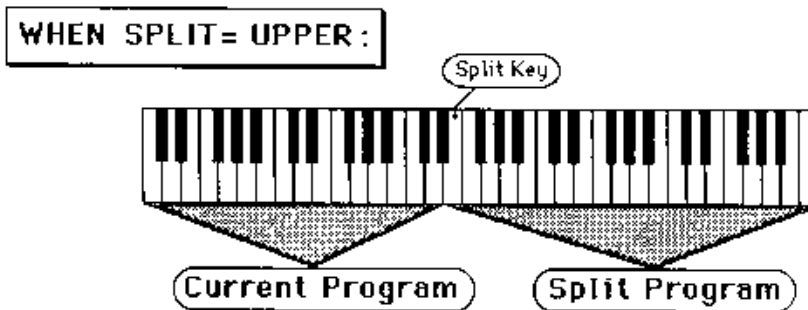

----> **LOWER** -- When **SPLIT=LOWER** is selected, the **Split Program** will play on the Lower Keyboard (that is, below the **Split Key**), and the Current Program will play on the Upper Keyboard (above the **Split Key**).

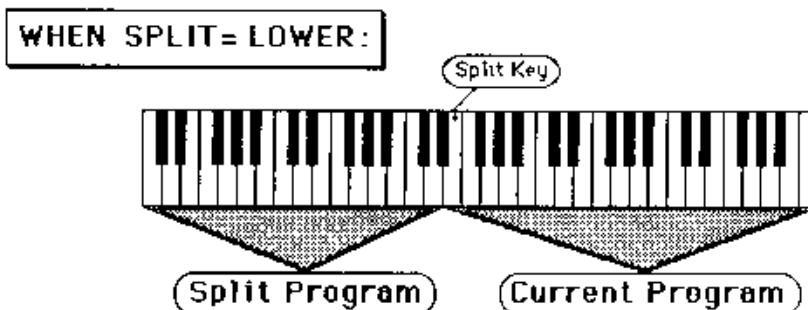

[SPLIT/LAYER] Split/Layer PAGE (cont'd)

So when you select **UPPER** or **LOWER** here, you are selecting which area of the Keyboard the **Split Program** will occupy. The Current Program (the one you started from) will always occupy the the opposite Keyboard half.

8. Select SPLIT Program

The Program whose name appears here will occupy the half of the Keyboard as designated above (#6), if **SPLIT=UPPER** or **SPLIT=LOWER** has been selected.

When this control is selected (Underlined), you can choose a new **SPLIT** Program in one of two ways:

- 1) Use the **Data Entry Slider** and the **Up and Down Arrow** Buttons to scroll through the various Programs in Memory until you find the one you want; or
- 2) Press **Internal**, **CART A**, or **CART B** to select a Master Bank, then press one of the four **Bank Select** Buttons and, while holding it down, select the Program you want. You will be returned to the **Split/Layer** Page with the new Program selected as the **SPLIT** Program.

* * * * **Note:** Whenever you select a **Layer Program**, a **Split Program**, or a **Split/Layer Program**, the **ESQ 1** only "remembers" the Location of that Program in Internal or Cartridge Memory -- not the Program itself. If you move a Program, put another in its place, or transfer an entire Bank of Programs, the **Layer**, **Split**, or **Split/Layer** Program on this Page might still be "pointing to" a Location that no longer contains the sound you had in mind.

For example, if you create and save a Program where a Brass sound is Layered with a String sound, and you then Write over the String Program (or insert a different Cartridge in the case of Layering with a Cartridge Program,) a different Layer Program will play -- whatever is now in the Location originally occupied by the String sound.

If your **Layer**, **Split**, or **Split/Layer** Program is a Cartridge Program, and you remove the Cartridge, the word ***CART*** will appear instead of the Program name, and the Program that will play will be the Internal Program with the same relative Memory Location (until you replace the Cartridge).

This also means that if you transfer an entire Bank of Programs from a Cartridge to the Internal Memory (or vice versa), any **Layer**, **Split**, and **Split/Layer** Programs will still be "pointing to" their previous Locations, and may not work once the Cartridge is removed, or you insert a different Cartridge. In this case, you should go through the transferred Programs and edit them so that the **Layer**, **Split**, and **Split/Layer** Programs are in the new Bank, and then Save (Write) the Programs back into their current Locations

[SPLIT/LAYER] Split/Layer PAGE (cont'd)

Note also that if you select a Program for your **Layer**, **Split**, or **Split/Layer** Program that itself contains a Layer, or Split, only the main part of that Program will play -- not any Layers or Splits that are programmed into it. It is only possible for one **Layer**, **Split**, or **Split/Layer** to be active at any time. So you can't, for example, make a Triple Layer by selecting an already-Layered Program as the Layer Program.

10. Select SPLIT Key

This designates the note on the keyboard at which the Programs will **Split**, if **SPLIT=UPPER** or **SPLIT=LOWER** has been selected (#8 above).

Range: 21 To 108.

Key Numbers given here are **MIDI key** Numbers -- they reflect the **MIDI** standard for numbering keys, rather than just counting up from the lowest note on the keyboard. Thus the Low C on the **ESQ 1** Keyboard is MIDI Key # 37; Middle C is MIDI Key # 60; the High C is MIDI key # 96.

The available range of values (**21 To 108**) corresponds to the the 88 key range of a grand piano. This allows the Split Key to actually be out of the range of the **ESQ 1** keyboard -- but such splits will only be effective if the **ESQ 1** is played via MIDI from an instrument with more than a 61-note keyboard. The **Split Key** itself always plays whichever Program is on the Upper half.

MIDI Key Numbers

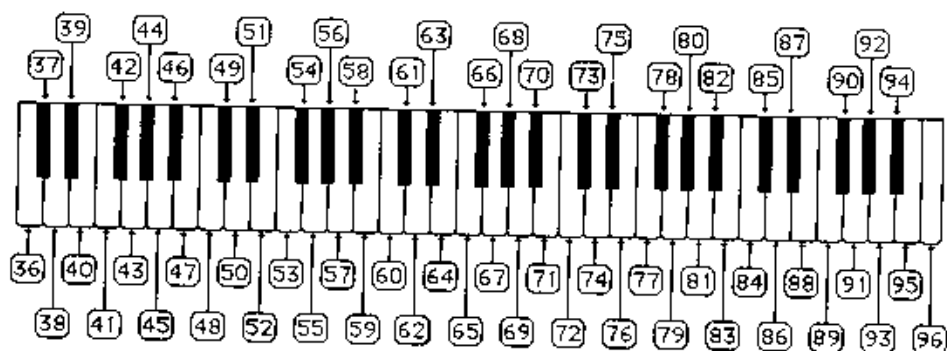

PROGRAMMING CONVENTIONS

There are a number of Programming conventions that have been followed within the **ESQ 1** factory Programs. They will help you to know where to begin when editing factory Programs. You may also find them to be handy rules of thumb to follow when creating your own Programs.

LFO's

- > **LFO 1** is used for Wheel Vibrato, when it is part of the Program.
- > **LFO 2** and **LFO 3** are available for other purposes.

Envelopes

- > **ENV 1** is used for Pitch Envelopes (modulating **OSC 1, 2 or 3**.)
- > **ENV 2** is used for individual volume Envelopes (modulating **DCA 1, 2 or 3**.)
- > **ENV 3** is used for Filter Envelopes (modulating the **Filter Cutoff Frequency**.)
- > **ENV 4** is always fixed as the overall volume Envelope (**DCA 4**.)

Of course these do not all apply for every Program. Any Envelope can be routed anywhere you want it to go (except to **DCA 4**), and some Programs will call for different applications. But where applicable, the factory Programs follow these conventions.

Program Names

- > (/) Where a Program is Layered, a slash (/) is incorporated into the Name.
- > (+) Where a Program contains a Split, a plus sign (+) is incorporated into the Name.

SECTION 3 -- Saving and Storage of Programs

- 74 **WRITE PROGRAM Page**
- 74 Saving a New Program to Memory
- 77 Copying an Existing Program to Another Location

- 78 **STORAGE Page**

- 78 **Cartridge -- Bank Copy**
- 79 Transferring Internal Programs to Cartridge
- 79 Transferring Cartridge Programs to Internal Memory

- 80 **Tape Storage**
- 80 A "Decent" Tape Deck
- 81 Tape Connections
- 81 Saving all Internal Programs to Tape
- 82 Verifying Internal Programs Saved to Tape
- 83 Loading all Programs from Tape

- 84 **MIDI Transfer of Programs**
- 84 MIDI Connections
- 84 Sending All Internal Programs via MIDI to Another ESQ 1
- 85 Sending One Program via MIDI to Another ESQ 1

[WRITE] WRITE PROGRAM PAGE

To Save a New or Edited Program into Memory, or Copy an Existing Program to another Location.

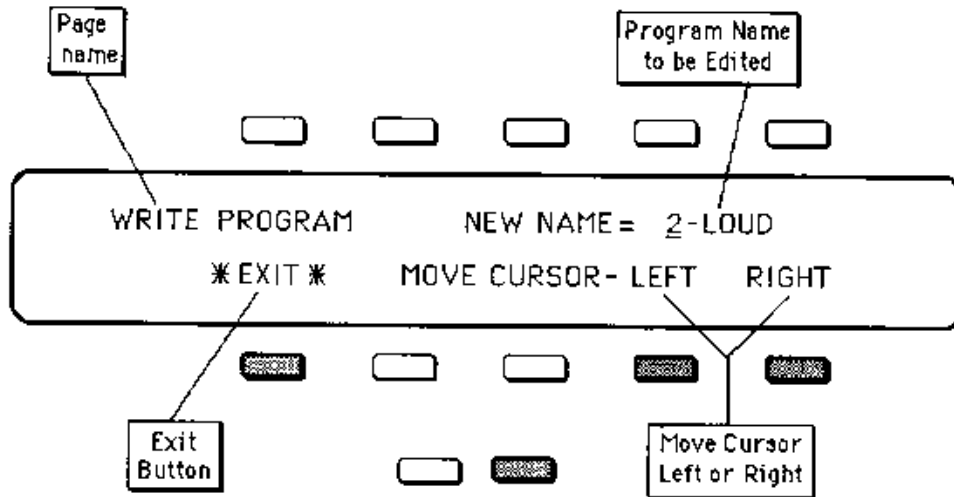

(Inactive Buttons appear in White)

Saving a New Program Into Memory

Once you have modified an existing **Program**, or created an entirely new one, you can **Write**, or save, that **Program** to any **Internal** or **Cartridge Memory** Location using the **WRITE PROGRAM** Page. This Page is also used to **Rename** the **Program** with the name of your choice.

When you are ready to **Write** a **Program** into **Memory**, first decide on a **Name** of up to six letters for your new **Program**. Then:

1. **Select the WRITE Page** by pressing the button labeled **WRITE** on the front Panel. The Page will come up as shown above, with the current **Program Name** showing. You will see a **Cursor**, or underling, beneath the first letter of that **Name**.

2. **Edit the Program Name** using the **Data Entry Slider** and the two **Move Cursor** buttons on the **Display**, labeled **LEFT** and **RIGHT**. You can move the **Data Entry Slider** up and down to scroll through the available characters, or step through them one at a time with the **Up** and **Down Arrow** buttons. Experiment until you find the first letter you want. Then press the **RIGHT** button to move the **Cursor** to the next location. Again, scroll through the characters until you find the correct one. Repeat this procedure until the display shows the name you have chosen.

You can move the **Cursor** back and forth using the **LEFT** and **RIGHT** buttons, changing letters, as often as you like, until you're satisfied. There are some pretty weird

[WRITE] WRITE PROGRAM PAGE (cont'd)

characters in there, along with the usual letters and numbers, to choose from. Be creative.

**** **Helpful Hint:** Moving the **Data Entry Slider** all the way down gives you a blank space.

3. Select a Memory Location for your new Program. You can "flip through" the various **Program Select Pages** in both the **Internal Memory** or the **Cartridge** to find a Program you want to write over. (Remember that you will be replacing whatever is already there, so be careful!)

Press one of the **Bank Select Buttons, 1 - 4**. As long as you hold the button down, the display will show the **Program Select Page** for that Bank, with two differences:

1) None of the **Program** names are underlined, and 2) the word **"WRITE"** is flashing in the lower left-hand corner, below the Page Name.

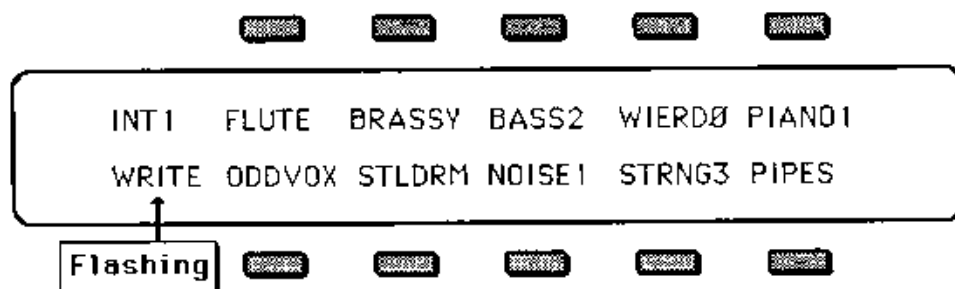

When you release the **Bank Select Button**, the Display will return to the **WRITE PROGRAM Page**. Press another **Bank Select Button** and the Display shows you the Programs for that Bank. To look at the Programs in a different **Master Bank** (**CART A** or **CART B** for instance), simply press the Button for that **Master Bank**, and then press and hold down any of the four **Bank Select Buttons**, as before.

4. "But Wait, I need to hear them!" You may find that it's not enough to look at all those Program Names -- you want to audition a few before deciding which to erase. In this case, press the button beneath the word ***EXIT*** on the Display. This returns you to the Page you were on before entering the **WRITE** mode.

Now use the **Bank Select Buttons** and the **Program Select Pages** in the usual way to select and listen to the Programs in memory. Your new Program is still safe in the **ESQ 1's** Edit buffer.

WARNING! -- While you're doing this, **DO NOT** change any parameters in the Programs you audition, as this would instantly replace your hard-earned new Program in the Edit Buffer with something else entirely, and you might get upset.

[WRITE] WRITE PROGRAM PAGE (cont'd)

When you are through listening, return to the Program you want to save by pressing the **COMPARE** Button. The *C* prompt will appear in the lower-left corner of the Page. Now press the **WRITE** Button to return to the **WRITE PROGRAM** Page. Your new Sound, and its new Name should be just where you left them.

5. Write the Program in Memory. Once you have decided where you want to save the new Program, Press the appropriate **Bank Select** Button, and while holding it down, press the "Soft" Button which corresponds to the Program you wish to Write over. This Writes the new Program, with its new Name, into that Memory Location.

The Display will show a message



which will remain for about two seconds.

It will then return to the **Program Select** Page of the **Bank** into which the new Program has just been saved. The new Program is underlined, and is thus selected as the Current Program:

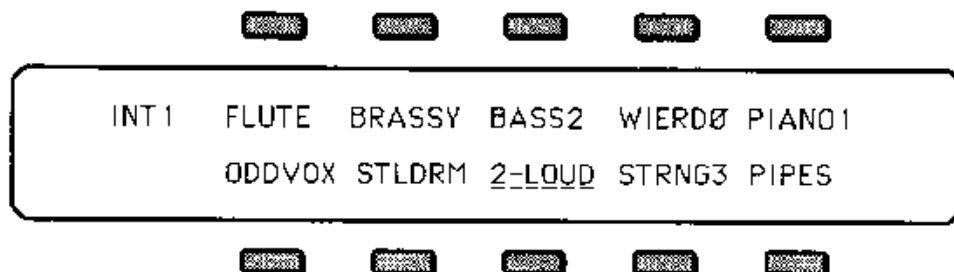

EXIT

The Button beneath the word *EXIT* can be pressed at any time to exit the **WRITE** Page and return to the Page you were on before entering it.

[WRITE] WRITE PROGRAM PAGE (cont'd)

Copying an Existing Program to Another Location

Sometimes you'll want to take an existing Program, one that you haven't been editing, and simply copy it to another Memory Location. For example, you might want to put the ten most commonly used Programs in the same Bank, for easy access during performance. Normally, the **WRITE** Page "looks" at the Edit Buffer. But you have the option of Writing an existing, unedited Program.

First select the Program you want to copy. Then press the **WRITE** Button. Pressing the **WRITE** Button when the ***C*** (**Change/Compare**) is not showing in the lower-left corner of the Display causes the **ESQ 1** to ask you the following question:

REPLACE EDIT PROGRAM WITH * YES *
CURRENT PROGRAM BEFORE WRITING * NO *

Answering ***YES*** places the Current Program onto the **WRITE** Page, and you can now use the **WRITE** Page exactly as before to copy that Program to any other Memory Location. Again, remember that you will erase whatever Program you write over -- it's not a bad idea to save all Internal Programs to a Cartridge or to audio tape before doing any major Memory reshuffling, because once a Program is gone, it's gone.

Answering ***NO*** will return you to the Page you were on before pressing the **WRITE** Button, leaving the Edit Program intact.

[STORAGE] STORAGE PAGE

For Saving and Loading Programs and Sequencer Data to Cartridge, to Audio Tape, or Over MIDI.

The **STORAGE** Page is used to send and load Program and Sequence Data to various media for saving and storage. Transferring Sequencer Data is covered in the **Sequencer** half of this Manual. Here we are concerned with transferring Programs.

The **STORAGE** Page handles three basic types of Program Data transfer:

- 1) **CARTRIDGE** -- An entire Master Bank (all 40 Programs) can be transferred from the Internal Memory to **CART A** or **CART B**. Or the 40 Programs in **CART A** or **CART B** can be transferred to the Internal Memory.
- 2) **TAPE** -- The 40 Programs in the Internal Memory can be saved to Audio Tape, or a Bank of 40 Programs can be loaded into the internal Memory from Tape.
- 3) **MIDI** -- All 40 Internal Programs, or any single Internal or Cartridge Program, can be sent via MIDI to another **ESQ 1**, or to a Computer which has been programmed to accept such information.

When you press **STORAGE**, the Page appears like this:

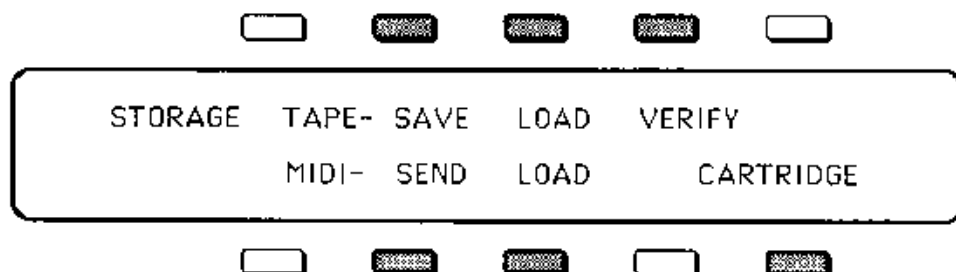

From here you choose which type of Data Transfer you want.

CARTRIDGE -- Bank Copy

When you press **CARTRIDGE** from the menu on the **STORAGE** Page, the following Page appears:

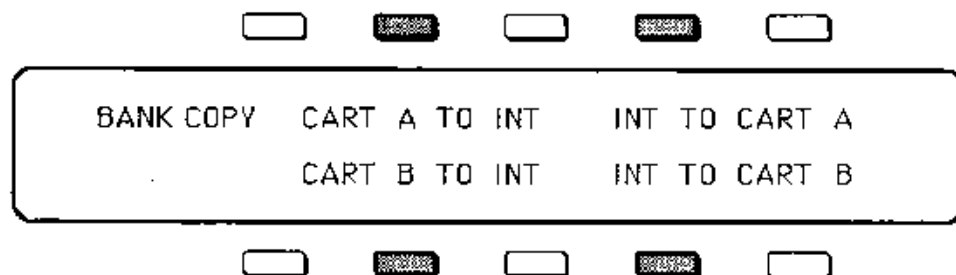

TRANSFERRING INTERNAL PROGRAMS TO A CARTRIDGE

To Transfer all 40 INTERNAL Programs to CART A:

- > Insert an **ENSONIQ E² PROM** Storage Cartridge in the Program Cartridge Slot.
- > Select the **STORAGE** Page.
- > Press **CARTRIDGE**. The **BANK COPY** Page appears as shown above.
- > Press **INT TO CART A**. The Display will ask **COPY PROGRAMS FROM INT TO CART A?** and give you the option of answering ***YES*** or ***NO***.
- > Press ***YES*** to Copy the Internal Programs to CART A. The Display will read **PROGRAMS BEING COPIED, PLEASE WAIT**. Copying an entire Bank to the Cartridge takes about two minutes. Or Press ***NO*** to cancel the procedure for any reason.
- > When the **PLEASE WAIT** message disappears, the transfer is complete.

To Transfer all 40 INTERNAL Programs to CART B:

- > Insert an **ENSONIQ E² PROM** Storage Cartridge in the Program Cartridge Slot.
- > Select the **STORAGE** Page.
- > Press **CARTRIDGE**. The **BANK COPY** Page appears as shown above.
- > Press **INT TO CART B**. The Display will ask **COPY PROGRAMS FROM INT TO CART B ?** and give you the option of answering ***YES*** or ***NO***.
- > Press ***YES*** to Copy the Internal Programs to CART B. The Display will read **PROGRAMS BEING COPIED, PLEASE WAIT**. This takes about two minutes. Or Press ***NO*** to cancel the procedure for any reason.
- > When the **PLEASE WAIT** message disappears, the transfer is complete.

TRANSFERRING CARTRIDGE PROGRAMS TO INTERNAL MEMORY

To Transfer all 40 CART A Programs to the INTERNAL Memory:

- > Insert an **ENSONIQ E² PROM** Storage Cartridge in the Program Cartridge Slot.
- > Select the **STORAGE** Page.
- > Press **CARTRIDGE**. The **BANK COPY** Page appears as shown above.
- > Press **CART A TO INT**. The Display will ask **COPY PROGRAMS FROM CART A TO INT?** and give you the option of answering ***YES*** or ***NO***.
- > Press ***YES*** to Copy the 40 Programs in CART A to the Internal Memory. The Display will read **PROGRAMS BEING COPIED, PLEASE WAIT**. Copying an entire Bank from a Cartridge to the Internal Memory takes only about two seconds. Or Press ***NO*** to cancel the procedure for any reason.
- > When the **PLEASE WAIT** message disappears, the transfer is complete.

To Transfer all 40 CART B Programs to the INTERNAL Memory:

- > Insert an **ENSONIQ E² PROM** Storage Cartridge in the Program Cartridge Slot.
- > Select the **STORAGE** Page.

- > Press **CARTRIDGE**. The **BANK COPY** Page appears as shown above.
- > Press **CART B TO INT**. The Display will ask **COPY PROGRAMS FROM CART B TO INT?** and give you the option of answering ***YES*** or ***NO***.
- > Press ***YES*** to Copy the 40 Programs in **CART B** to the Internal Memory. The Display will read **PROGRAMS BEING COPIED, PLEASE WAIT**. Or Press ***NO*** to cancel the procedure for any reason.
- > When the **PLEASE WAIT** message disappears, the transfer is complete.

TAPE STORAGE

The 40 Programs in the Internal Memory can be saved to audio Tape, cassette or reel-to-reel, and later loaded back into the **ESQ 1's** Internal Memory from Tape.

A "Decent" Tape Deck

Because of the sheer amount of information involved, the **ESQ 1** sends Data to Tape at a rate that is a good bit faster than most synthesizers. For this reason it is recommended that you use a "decent" Tape deck to Save and Load your **ESQ 1** Program and Sequence Data. This doesn't mean you need an audiophile unit -- any home stereo-type cassette or reel-to-reel deck should do fine. Decks specifically designed for use with computers should work as well.

What is definitely NOT recommended is a very cheap portable-type recorder. Such recorders cannot be relied upon to handle the **ESQ 1's** high speed data transfer.

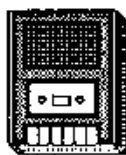

The higher grade of tape you use, the more reliable the results you will get. Definitely do not use three-for-a-dollar generic cassettes. A good quality Normal Bias cassette should do the job; a Chrome Bias cassette is better; a Metal Bias cassette is best. Tapes which are specifically made for computer data storage will work. These are available at any Computer store.

It is generally recommended that you not use any Noise Reduction when Saving or Loading Programs, as Noise Reduction circuits tend to "round off" the square pulses that the **ESQ 1** uses to store information.

Small differences in record level can make a big difference when saving Data to Tape. You may need to experiment a bit to see what works best with your equipment.

Tape Connections

To Save Program Data to Tape, connect the **Tape Out Jack** on the Rear Panel of the **ESQ 1** to the **Input** of your tape recorder. For Loading Data, or Verifying Data that has been Saved, connect the proper **Output** of the tape recorder to the **Tape In** jack of the **ESQ 1**.

When Saving Data to Tape, it's not a bad idea to use a "Y" adapter at the tape recorder end of the cable, and to feed the signal to both channels of the deck. That way you can record duplicate copies of the information (on the left and right channels of the Tape), in case a dropout or other problem causes an error on one of the channels. Also, when you later Load the Data into the **ESQ 1**, this method allows you to monitor one channel while sending the other to the **ESQ 1**.

*** * * * Note:** The first time you save Data to Tape, it is a good idea to go through the procedure once without Starting the Tape Deck, just to get your Record levels properly adjusted. Also, recording some sort of spoken "Slate" on the tape, immediately before each batch of Programs you save, will help you keep Track of which Bank is where on the Tape.

To SAVE All 40 Internal Programs to Audio Tape

- > Connect the **ESQ 1's Tape Out Jack** to the **Input** of one channel of your tape recorder (or to both channels, as described above).
- > Put your Tape Deck in **Record/Pause**.
- > Select the **STORAGE** Page.
- > Press **TAPE SAVE**. The Display shows the following:



- > Start the Tape Deck Recording.
- > Press **INT BANKS**. This starts the DataTransfer. The Display will read ***SAVING DATA TO TAPE***. The **ESQ 1** will put out an eight second "Leader" tone, followed by the Program Data, which takes about 16 seconds. During the Leader tone, adjust the Recorder's Input level. The VU meter(s) should read between -3 and 0 dB for home and semi-pro cassette decks; lower (around -10 to -6) for professional equipment operating at +4 dBm.
- > When the Data has been transferred, the Display reads ***TAPE PROCEDURE COMPLETE***, and the **STORAGE** Page returns.
- > Stop the Tape Deck, and Verify the Transfer, as described below.

To VERIFY Program Data Saved to Audio Tape

- > Connect the **Output** of the channel of your tape recorder that contains the Program Data to the **ESQ 1's Tape In Jack**.
- > Select the **STORAGE** Page.
- > Rewind the Tape Deck to the beginning of the Data to be Verified.
- > Press **TAPE VERIFY**. The Display shows the following:



- > Start the Tape Deck Playing. Listen to the Output, or watch the VU meters, and wait for the Leader Tone which precedes the Data to begin.
- > After the Leader Tone begins, press **INT BANKS**. This starts the **ESQ 1** checking the Data on the Tape. The Display will read ***READING DATA FROM TAPE***.
- > If the Data on the Tape is correct, the Display will say ***TAPE PROCEDURE COMPLETE***, and then return you to the **STORAGE** Page.
- > If the Verify is unsuccessful, you will get one of the following messages:
 - 1) ***TAPE NOT STARTED ON LEADER TONE*** -- The Leader Tone must be actually playing when you press **INT BANKS** to begin Verifying. Try the Procedure again.
 - 2) ***VERIFY FAILED -- INVALID TAPE DATA*** -- This can result from a number of things -- the Data was recorded at too high, or too low, a level; a serious dropout or other Tape problem has garbled the Data; or a bad connection has resulted in a loss of Data. In any case, when you get this message, Save the Data again, to another part of the Tape, or to another Tape.
 - 3) ***INCORRECT TYPE OF DATA ON TAPE*** -- This message would result if, for example, you pressed **INT BANKS** and then played Sequencer Data into the **ESQ 1**. Don't do that.
- > There is one more message you might get, which is not fatal, but requires your attention. If after a Verify, the Display reads ***DATA ERROR FROM TAPE WAS FIXED***, that means that the **ESQ 1** found one bit of wrong information on the Tape, but was able to correct it. This might indicate an aging Tape, or a slight dropout, and it is a good idea to save the information to another Tape.

To LOAD Program Data from Audio Tape

- > Connect the **Output** of the channel of your tape recorder that contains the Program Data to the **ESQ 1's Tape In Jack**.
- > Select the **STORAGE** Page.
- > The Tape Deck should be in Stop or Pause, at the beginning of the Data to be Loaded.
- > Press **TAPE LOAD**. The Display shows the following:

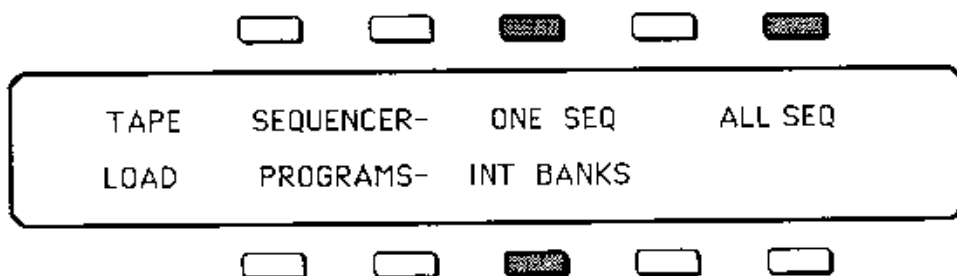

- > Start the Tape Deck Playing. Listen to the Output, or watch the VU meters, and wait for the Leader Tone, which precedes the Data, to begin.
- > After the Leader Tone begins, press **INT BANKS**. This starts the **ESQ 1** Loading the Data on the Tape. The Display will read ***READING DATA FROM TAPE***.
- > If the Load is successful, the Display will say ***TAPE PROCEDURE COMPLETE***, and then return you to the **STORAGE** Page.
- > If the Load is unsuccessful, one of the following error messages will appear:
 - 1) ***TAPE NOT STARTED ON LEADER TONE*** -- The Leader Tone must be actually playing when you press **INT BANKS** to begin Loading. Try the Procedure again.
 - 2) ***INCORRECT TYPE OF DATA ON TAPE*** -- The Data was not Program Data.
 - 3) ***FATAL ERRORS DETECTED-- ALL INTERNAL PROGRAMS RESET*** This means that midway through the transfer, the **ESQ 1** got some bad Data, and had to erase and re-initialize all the Internal Bank Programs.
- > The Display might read ***DATA ERROR FROM TAPE WAS FIXED***. This means that the **ESQ 1** found one bit of wrong information on the Tape, but was able to correct it. Save the information to another Tape location.
- * * * Note:** Whenever you get an error message while transferring Data by Tape or via MIDI, the message will remain on the Display until you press one of the front panel buttons. Press any button (except a Soft Button) to continue.

MIDI TRANSFER OF PROGRAMS

The **ESQ 1** can be instructed to send Program Data over MIDI to another **ESQ 1**. This Data could also be received by a Computer which has been programmed to receive such Data. Here we are concerned with sending Programs from one **ESQ 1** (the Sending Unit) to another (the Receiving Unit).

MIDI Connections

In the case of Sending Program Data via MIDI, it is only necessary that the **MIDI Out** jack of the Sending **ESQ 1** be connected to the **MIDI In** jack of the Receiving Unit. Three other conditions must be met:

- 1) Both Units must be set to the **same MIDI Channel**. (MIDI Page) MIDI Mode doesn't matter.)
- 2) The Receiving Unit must have System Exclusive messages Enabled. (On the MIDI Page, set MIDI Enables to **ENABLE=KEYS+CT+PC+SS+SX.**)
- 3) The Receiving Unit must be on a **Program Select** Page when receiving the Programs. Any Program Select Page, Internal or Cartridge, will do.

To SEND All Internal Programs via MIDI to another ESQ 1

This will Send the Internal Memory of the Sending Unit to the Internal Memory of the Receiving Unit, replacing whatever is there.

- > Connect the MIDI cable, and set up the units as described above.
- > On the Sending Unit, select the **STORAGE** Page, and press **MIDI SEND**. The following Page appears:



- > Press **INT PROG BANKS**. The Display will read ***MIDI DATA BEING TRANSFERRED* PLEASE WAIT...** for about two seconds
- > The Display will say ***MIDI PROCEDURE COMPLETE***, and then return to the **STORAGE** Page. The new Programs are now in the Internal Memory of the Receiving Unit.
- > If the Receiving Unit does not respond, check 1) your MIDI connections, 2) the MIDI Channel on both units, and 3) the MIDI Enables on the Receiving Unit, and try again.

To SEND One Program via MIDI to another ESQ 1

This will Send the selected Program of the Sending Unit to the Edit Buffer of the Receiving Unit, replacing whatever is there.

- > Connect the MIDI cable, and set up the units as described above.
- > On the Sending Unit, select the **STORAGE** Page, and press **MIDI SEND**.
- > Press **CURRENT PROGRAM**. The Display will flash ***MIDI DATA BEING TRANSFERRED* PLEASE WAIT...** (One Program doesn't take long)
- > The Display will say ***MIDI PROCEDURE COMPLETE***, and then return to the **STORAGE** Page. The new Program is now on the **WRITE** Page of the Receiving Unit. Edit its Name if you wish, and then Write it into Memory as described earlier (**WRITE PROGRAM** Page, p. 74).
- > If the Receiving Unit does not respond, check **1)** your MIDI connections, **2)** the MIDI Channel on both units, and **3)** the MIDI Enables on the Receiving Unit, and try again.

*** * * * Note:** When you save all Sequencer Data to a **Mirage** Digital Sampling Keyboard, or **Mirage** Digital Multi-Sampler, as described in Section 9, the 40 Internal **ESQ 1** Programs are sent to the **Mirage** along with the Sequencer Data. When you later Load the Sequencer Data back into the **ESQ 1**, you have the choice of Loading just the Sequencer Data, or the Sequencer Data plus the 40 Programs. You cannot Load just the Programs from a **Mirage**. This does, however, provide another method of storing Programs. The catch is that Sequence Data must be Loaded at the same time, replacing whatever Sequence Data was there before.

PART 2 -- THE SEQUENCER

SECTION 4 -- About the Sequencer

89	OVERVIEW
89	The MIDI Connection
89	Digital Sequencing
91	THE ESQ 1 SYSTEM
92	SEQUENCES AND SONGS
92	What is a Sequence?
92	Sequencer Master Bank
93	Sequencer Banks
93	Selecting a Sequence
94	Selecting a Song
94	Playing Sequences
94	Playing Songs
95	Sequencer Expander Cartridge
96	"TRANSPORT" CONTROLS
96	Record, Stop/Cont, and Play Buttons
97	Sequencer Foot Switch
97	SEQUENCER STATES
99	UTILITY PAGES
99	KEEP FIRST TRACK
99	PLAY/KEEP Page
100	SAVE CHANGES TO OLD SEQUENCE
101	Altering a Sequence in SONG Mode

THE SEQUENCER

The **Sequencer** section of the **ESQ 1** was not an afterthought -- as in "Hey, let's put a sequencer in this thing." It is a fundamental part of the whole concept of the **ESQ 1**, and an extremely powerful device in its own right. Building a Sequencer this sophisticated into the same box with a synthesizer creates many new possibilities for writing, recording and performing music.

At the same time, it can make for a few complexities. Since the Synthesizer and the Sequencer are interrelated, what you do on one sometimes affects the other. There are a few possible routes to confusion here. However, if you pay close attention to the explanations in this Manual, use your common sense, and open your mind to a few new concepts, you will be happily sequencing in no time.

The MIDI Connection

Almost everyone is familiar by now with **MIDI** -- that magical connection that lets you play one instrument (or a whole roomfull of them) from another. **MIDI** -- Musical Instrument Digital Interface -- is a standard that has been agreed upon by manufacturers for translating musical Events into specific numbers.

When you strike the Middle C on the **ESQ 1**, for instance, it instantly sends to its MIDI Out jack a series of numbers representing a Key Down, along with the location on the Keyboard, and how hard the key was struck. When you release the key the **ESQ 1** sends a number meaning Key Up. A MIDI instrument connected to the **ESQ 1** can read and translate those numbers to play the same middle C itself.

Now imagine a recorder which, instead of recording the sounds of an instrument, records the same kind of Digital information that is sent and received over MIDI -- Key Down, Key Up, Key Number and Velocity, Pitch Bend, MOD Wheel, and so on -- and you have imagined a Digital Sequencer.

Digital Sequencing

A general understanding of how a Digital Sequence Recorder like the **ESQ 1** does what it does, and how it differs from an eight track audio tape recorder, will help you to get the most out of your instrument. The key thing to bear in mind is this -- the Sequencer only records what you play. Sequencer Memory is used up on the basis of Events (Keys struck, Controllers, etc.), while a tape recorder's memory (the tape) is always used up by the same amount over a fixed period of time.

This means that a Sequencer will use virtually the same amount of Memory to record 100 notes, whether you play those notes over ten seconds or ten minutes. When you strike a key, the Sequencer records a Key Down. It then counts the Clock pulses until you release the key, when it records a Key Up. The amount of time between the Key Down and the Key Up doesn't really affect the amount of Memory required to record the note.

Compare this to an audio tape recorder. With tape, Time is the thing. A tape recorder will use the same amount of tape to record a minute of music, whether the signal contains one note or one hundred.

You might say that tape is linear -- it is spent at a fixed rate -- while Digital Sequencer Memory is dynamic -- it is used only as needed. The difference is essential to learning how to manage the **ESQ 1's** Sequencer Memory. For example, while Key Events (the notes you play) use up relatively little Memory each, Controllers such as MOD Wheel, Pitch Bend, Breath controller, etc., are recorded as a flood of numbers which can fill up the Memory in a hurry. Thus if you're trying to squeeze one more Track into a Sequence when there is not much Memory left, you know to go easy on the Controllers.

THE ESQ 1 SYSTEM

The diagram below illustrates the signal paths and the "component parts" that make up the **ESQ 1** -- the **ESQ 1 System**. As you grow more familiar with the **ESQ 1** and its functions, you should refer back to this diagram, as it will answer many of your questions concerning which signals can be routed where.

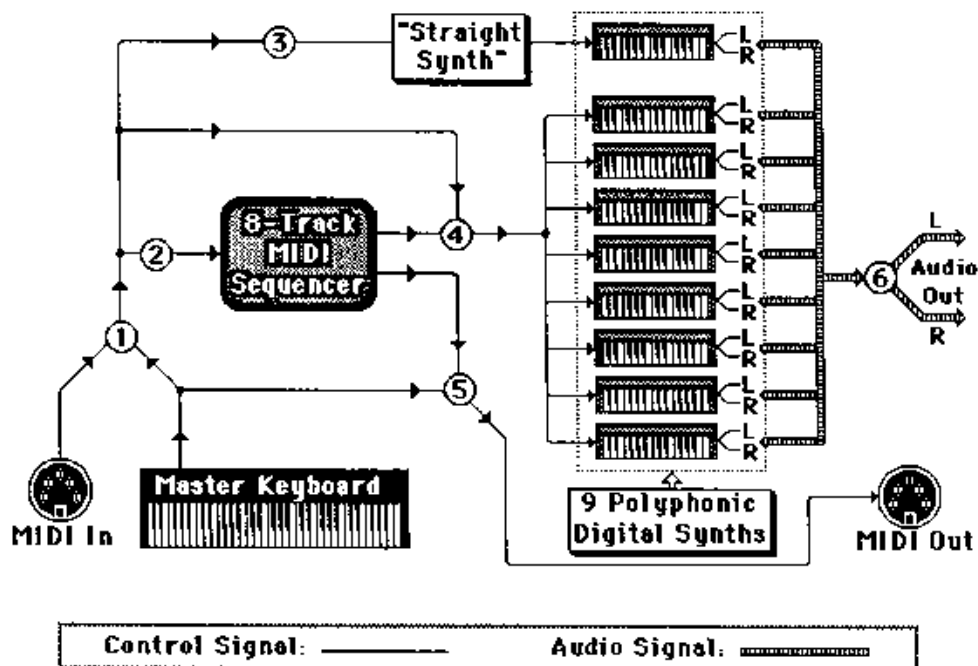

As indicated by the above diagram:

- 1) There are two available Control Signal sources -- incoming MIDI Data, and the **ESQ 1** Keyboard (shown above as Master Keyboard.)
- 2) Both the **ESQ 1** Keyboard and incoming MIDI can address any of the Tracks of the eight-Track MIDI Sequencer.
- 3) Both the **ESQ 1** Keyboard and incoming MIDI can address the Straight Synth.
- 4) Each of the Tracks can be thought of as a "virtual synth" and can be addressed from the **ESQ 1** Keyboard, from MIDI, or from Data recorded on the Sequencer. (A "virtual synth" is defined here as something that has 1) its own Program, 2) its own MIDI Channel, and 3) eight voices available for it to play. Of course, since the **ESQ 1** has only eight voices, the nine "synths" -- the Straight Synth and the eight Tracks -- cannot all play at any one instant in time. But the **ESQ 1**'s Dynamic Voice Assignment means that each has eight voices available at any time, if someone else is not using them.)
- 5) Both the **ESQ 1** Keyboard the Sequencer can send MIDI Out.
- 6) The stereo outputs of the Straight Synth and the eight Tracks combine to form the Left and Right Audio Outputs of the **ESQ 1**.

Note: The diagram above is conceptual and somewhat simplified. It is intended primarily as an aid to understanding.

SEQUENCES AND SONGS

What is a Sequence?

A **Sequence** on the **ESQ 1** is comparable to a **Pattern** on a drum machine. Each **Sequence** has a defined length (though you can change it at any time). A **Sequence** can be as short or as long as you want (within the limitations of **Memory**). Within a given **Sequence**, each of the eight **Tracks** has its own **Internal Program** and **MIDI** configuration (**MIDI Channel**, **Status**, **Program number**, etc.), all of which is "remembered" by the **ESQ 1** for each **Sequence**.

Each time you select a new **Sequence**, each **Track** used within a **Sequence** will send out a **Program Change** and **Midi Volume** instructions on its designated **Midi Channel**, unless it has been assigned **LOCAL** only **Status** -- in which case you can have the new **Track** play a new **Internal Program**. **Internal Program**, **Midi Channel**, **Midi Program**, etc. for each **Track** do not change within a given **Sequence** -- that is what the **ESQ 1's Song Mode** is for.

In **Song Mode**, **Sequences** will play consecutively in any order, with up to 99 **Steps**, and up to 99 **Repetitions** of each **Step**. Whenever a new **Sequence** begins to play as a **Step** in a **Song**, the effect is the same as when you select the **Sequence** -- each **Track** will send out a **Program Change** on its **MIDI Channel**, change its **Internal Program**, or whatever you have programmed that **Track** of that **Sequence** to do.

You'll find that you can control all your **MIDI** instruments -- playing, recording, and changing **Sounds** -- without ever leaving the **ESQ 1 Keyboard**.

Sequencer Master Bank

The one yellow **Button** labeled **SEQ**, above the three **Program Master Bank** **Buttons**, selects the **Sequencer Master Bank**. The **Sequencer Master Bank** contains 30 **Sequence Memory Locations**, and 10 **Song Memory Locations**. Not all of these locations necessarily contain a **Sequence** or **Song** at a given time.

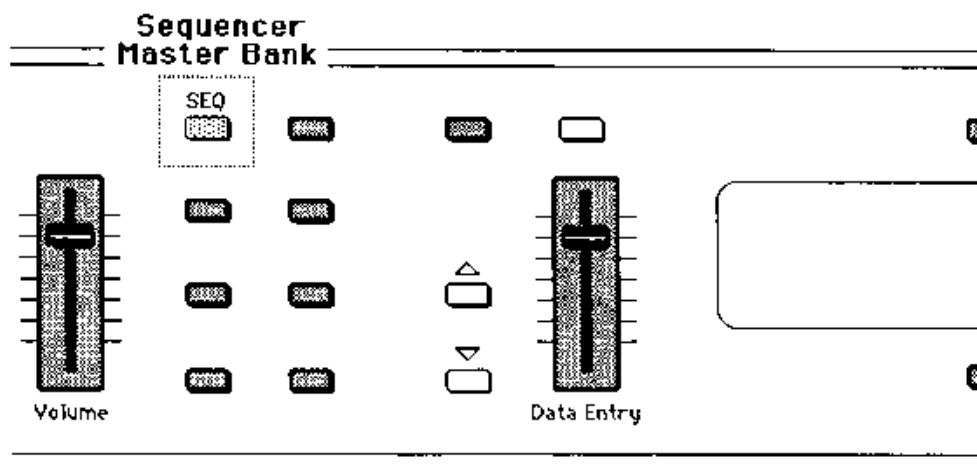

Sequencer Banks

Press the **Sequencer Master Bank** Button. The four **Bank Select** Buttons now access the Sequencer Memory rather than the Program Memory. There are three Banks of ten Sequences and one Bank of ten Songs.

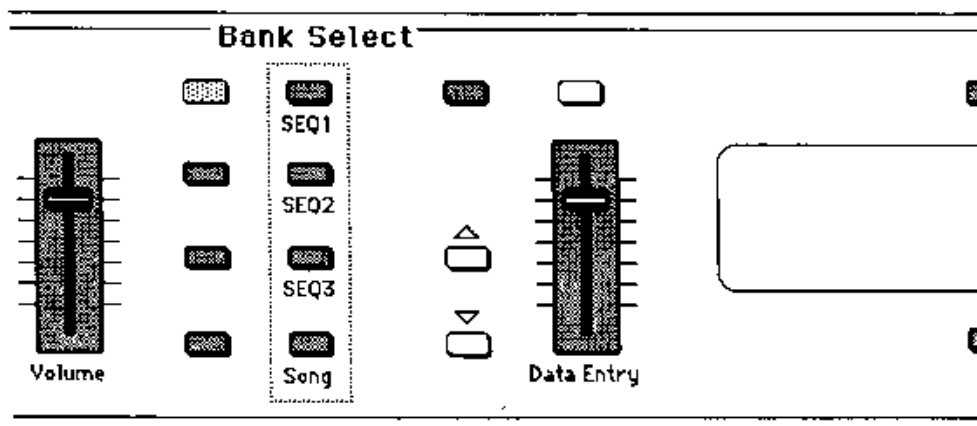

Selecting a Sequence

Press **SEQ 1**, **SEQ 2** or **SEQ 3** to see the **Sequence Select Pages** for each of the three **Sequence Banks**. The Sequences in Memory are numbered **01** through **30**. When you press **SEQ 1**, the Display shows:

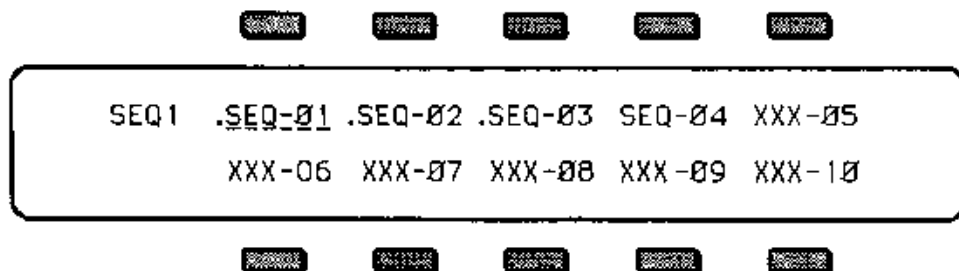

Pressing the **Soft** Button next to any of the ten Sequence Locations selects that as the current Sequence. Only those with **(SEQ--)** before the Sequence number can be selected. A location where **(XXX--)** appears represents a Sequence which hasn't been defined yet -- it contains no Sequence Data and cannot be selected until you Create a Sequence in that Location.

As with everything on the **ESQ 1**, when you select a Sequence it becomes underlined. **The currently selected Sequence is always underlined.**

A **dot (.)** to the left of a Sequence location means there is data recorded in that Sequence. A Sequence Location with no dot (as in SEQ-04 in the illustration above) means that nothing has yet been recorded there.

Whenever you select a Sequence or a Song, the **ESQ 1** sends out a MIDI Song Select message. See p. 169 for more details on Song Selects.

Selecting a Song

With the **ESQ 1's** Song Mode you can chain Sequences together to form up to ten different Songs. Press **Song** to see the **Song Select Page**. Either a Sequence or a Song can be selected --never both. While the thirty Sequences are identified by number only, the ten **Songs** can have Names. When you press **Song**, the Display shows:

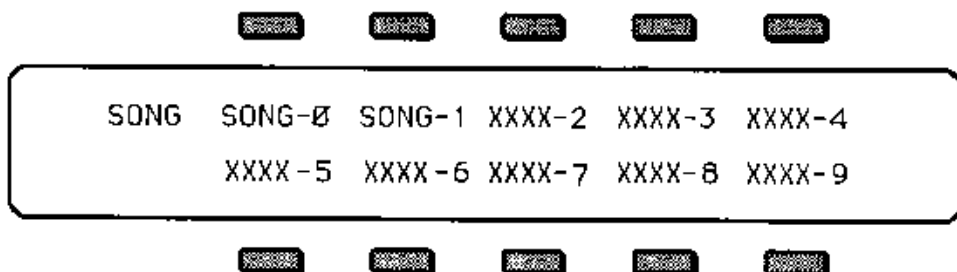

Pressing the "Soft" Button next to any of the ten Song Locations selects that as the current Song. Only those with a Name can be selected. A location where (**XXXX**) appears represents a Song which hasn't been created yet and cannot be selected.

The currently selected Song is always underlined.

Playing Sequences

Try selecting a Sequence, and pressing the **Play** Button in the Sequencer Section, to the right of the Display. The selected Sequence will begin to play.

While one Sequence is playing you can select another one. An underline will begin to flash beneath the new Sequence, but the original one will continue to play. When the first Sequence is finished, the underline will switch to the new Sequence, and it will play. In this fashion you can string Sequences together in real time, as they play. The Display always tells you which is Playing (underline) and which is selected to play next (flashing underline).

Press the **Stop/Cont** Button or the **Sequencer Foot Switch** to Stop the Sequence.

Playing Songs

To Play a Song, simply select one of the Songs in memory, as described above, and press the **Play** Button in the Sequencer Section. Unlike Sequences, you can't switch Songs while one is playing. The Sequencer must be stopped to select a new Song.

Press the **Stop/Cont** Button or the **Sequencer Foot Switch** to Stop the Song.

Sequencer Expander Cartridge

The optional **Sequencer Expander Cartridge** can be installed in your **ESQ 1** to increase its Internal Sequencer Memory capacity to 32K -- over 10,000 notes. The **Sequencer Expander Cartridge** is intended to be installed in the **ESQ 1** and left there. Once inserted, it acts as a part of the internal circuitry of the **ESQ 1**, and there is no reason to remove it. Unlike the Program Cartridge, the **Sequencer Expander Cartridge** will not retain any Data when disconnected from the **ESQ 1**.

The **Sequencer Expander Cartridge** can be easily installed by an authorized **ENSONIQ** Repair Station, or you can do it yourself. However, since installing the Cartridge basically reconfigures the **ESQ 1's** Memory system, the **ESQ 1** should be Re-initialized after you do so. This involves erasing all Memory. You should save all Programs and Sequence Data before proceeding. You can load them back in after the Cartridge has been inserted.

To install the Cartridge:

- 1) Save all Internal Programs and Sequence Data to audio tape, Program Cartridge, **Mirage**, or to another **ESQ 1**.
- 2) **Turn the ESQ 1's power Off!** The **Sequencer Expander Cartridge** must not be inserted or removed with the power On. Doing so may seriously damage the **ESQ 1**.
- 3) Remove the two screws that hold on the metal plate covering the Sequencer Expansion Port on the rear panel, and remove the metal plate.
- 4) Insert the **Sequencer Expander Cartridge**, connector end first, and with the label facing up, into the Cartridge port.
- 5) Carefully press the Cartridge into place until it is seated firmly. Don't force it.
- 6) Replace the metal plate and retighten the two screws that hold it in place.
- 7) Re-initialize the **ESQ 1**. Turn the **ESQ 1's** power On. While holding down the **Record** Button, press the top-left (#1) Soft Button. The Display will ask "**ERASE ALL MEMORY AND REINITIALIZE.**" Answer ***Yes***.
- 8) Select the **CREATE/ERASE** Page, and check the Available Memory (see p. 124). The number of available bytes of Sequencer Memory, **FREE =**, should now be greater than **32,000**.

You can now Load back in the Internal Programs and Sequencer Data that you stored. Bear in mind that all Global and Sequencer parameters (MIDI Channel, Bend Range, Click, Loop, etc.) that are normally remembered by the **ESQ 1** will now be reset to their Default values, and must be adjusted again to the values you want.

"TRANSPORT" CONTROLS



"Transport" Controls



Sequencer
Foot Switch

The bottom row of Buttons in the Sequencer section of the **ESQ 1** are used to start and stop the Sequencer, and to enter the various other Sequencer States. These buttons are similar to the Play, Stop and Record controls on a tape deck. Together with the **Sequencer Foot Switch** (which duplicates the **Stop/Cont** Button), and the **Auto-Locate** controls found on the **LOCATE** Page (which might be compared to the fast forward and rewind), they give you the ability to Play or Record from any Bar within a Sequence.

When the Sequencer is Stopped;

Pressing Play starts the Sequencer playing from the beginning of the Sequence or Song. (Unless you have just used the **Auto-Locate** Controls, in which case the first press of the **Play** Button acts like **Stop/Cont**.)

Pressing Stop/Cont starts the Sequencer playing from the point where it was last stopped, or from the location selected with the **Auto-Locate** Controls.

Pressing Play while holding down Record starts the Sequencer Recording from the point where it was last stopped, or from the location selected with the **Auto-Locate** Controls.

When the Sequencer is in PLAY;

Pressing Stop/Cont stops the Sequencer.

Pressing Play starts the Sequence again from the beginning.

Pressing Record puts the Sequencer into **Overdub**. It will wait for you to play before going into Record.

When the Sequencer is in RECORD;

Pressing Stop/Cont stops the Sequencer.

Pressing Play takes the Sequencer out of **Record** and puts it into **Audition Play**. (Except on the First Track. When recording the First Track, pressing Play has no effect.)

Sequencer Foot Switch

The Rear Panel jack labeled **Sequencer Ft. Sw.** accepts an **ENSONIQ FSW-1** Foot Switch. When a Foot Switch is plugged into this jack, pressing it will have the same effect as pressing **Stop/Cont**, except when recording the first Track of a Sequence, or when in Overdub, when it can be used to put the Sequencer into Record without playing.

*** * * * The Sequencer Foot Switch exactly duplicates the behavior of the Stop/Cont Button (except in the REC Standby or Overdub states).**

SEQUENCER STATES

On all Sequencer Pages except the **CREATE/ERASE** Page and the **EDIT** Page, the **Status** of the Sequencer is always shown in the lower-left corner of the Display. This tells you which State the Sequencer is in at any given time.

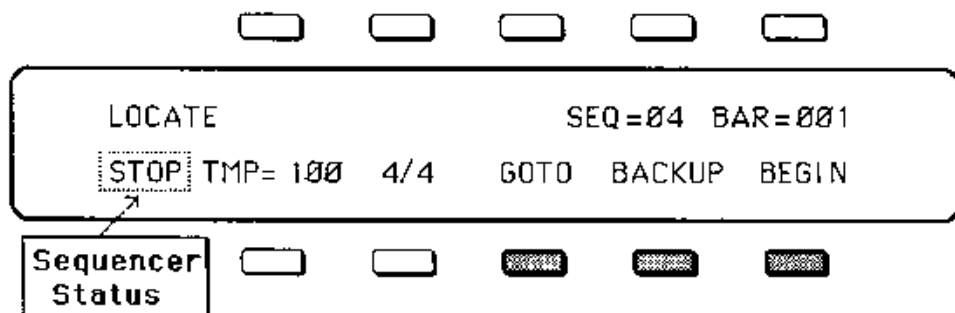

When a Sequence is selected, the possible Sequencer States are:

STOP -- Sequencer at rest.

PLAY -- Sequencer Playing current Sequence. From **STOP**, **PLAY** is entered by pressing the **Play** Button, or pressing the **Stop/Cont** Button.

REC (flashing) -- This is a Record "Standby" state that occurs only when recording the First Track of a Sequence. When **Record/Play** is pressed to record the First Track, **REC** flashes and the metronome starts (**CLICK** must be ON), allowing you to adjust the Tempo. Recording does not start until you begin to play. The point where you begin to play then becomes Bar # 1 of the new Sequence.

REC -- Recording on the selected Track. **Record** is entered by:

- 1) Playing any note while **REC** is flashing (First Track only);
- 2) Pressing **Record/ Play** (all later Tracks); or
- 3) Playing any note while **ODUB** is flashing (see **Overdub Mode** below).

The **ESQ 1** automatically exits the **Record** State at the end of a Sequence on all Tracks after the first -- that is, after the length of the Sequence is defined. It will not Record past the end of a Sequence. At the end of the Sequence it will leave **Record** and (assuming **LOOP= ON**) enter the **Audition Play** State.

ODUB (flashing) -- **Overdub** is another way of entering **Record**. It allows you to "Punch In" wherever you want on a Track, on any Track after the first.

To enter **Overdub**: While the Sequencer is in **Play**, press the **Record** Button. The **Status** indicator in the lower left corner of the Display will begin flashing **ODUB**. Nothing will be recorded until you play a note or press the **Sequencer Foot Switch**.

At the point you wish to punch in, just begin to play or press the Foot Switch. The Sequencer will record your new data from the point where you began to play up to the end of the Sequence, where it will leave **Record** and go into the **Audition Play** State.

AUDP -- Audition Play. This State is entered automatically from **Record** when the end of the Sequence is reached (assuming **LOOP=ON**). After leaving **Record** and entering **Audition Play**, the Sequence will continue to play in this state, with the newly recorded Track, until you press the **Stop/Cont** Button. Pressing **Stop/Cont** from this State will put you on the **PLAY/KEEP** Page (see below).

AUDS -- Audition Stop is entered when you stop the Sequencer from the **Audition Play** State. To exit **Audition Stop** and return to the normal **Stop** State, you must first instruct the **ESQ 1** to **KEEP** either the new or the original Track (see **PLAY/KEEP** Page below).

When a Song is selected, things are simpler. Since you can't record in **Song** mode, there are only two possible Sequencer States:

SNGS -- Song Stop. Sequencer at rest.

SNGP -- Song Play. Sequencer playing currently selected Song.

UTILITY PAGES

There are a number of Utility and Dialogue Pages that you will encounter as you use the **ESQ 1** Sequencer. These Pages give you the choice of either keeping or rejecting changes you make to a Sequence and its Tracks.

KEEP FIRST TRACK

When you press **Stop** (or the Foot Switch) after recording the First Track of a Sequence, the Display shows the following Page:

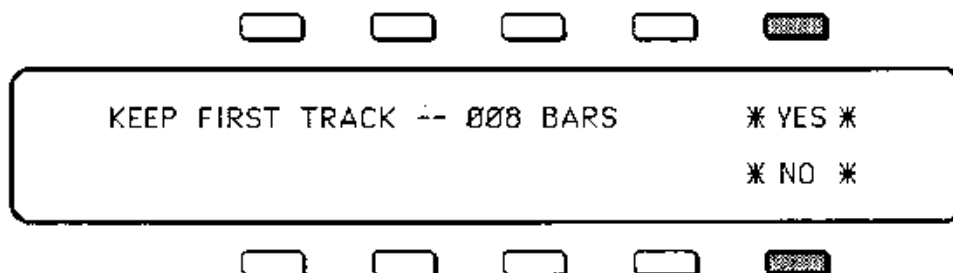

Pressing ***YES*** installs the Track in Memory as the First Track of the Sequence, and defines the length of the Sequence as the number of Bars shown.

Pressing ***NO*** returns the Track (and the Sequence) to an unrecorded state, so you can record the First Track again from scratch.

PLAY/KEEP PAGE

After accepting a First Track, everything you record (including recording over the First Track) will be followed by the **PLAY/KEEP** Page. From the **Record** or **Audition Play** States, pressing the **Stop** Button (or the Foot Switch) results in the following Display:



Because all recording of Tracks is done into an Buffer Memory, no new Track is entered into the Sequencer Memory until you decide you want to keep it. The **PLAY/KEEP** Page lets you listen to either the New or the Original Track, and to Keep (enter into Sequencer Memory) whichever you want.

When you are on the **PLAY/KEEP** Page, all other **ESQ 1** Pages and functions are inactive (except the **Auto-Locate** Controls -- see below). You will not be allowed to do anything other than Audition the new and original Tracks, until you make a decision on which to keep; though you can, while auditioning a Track, press the **LOCATE** Button to view the **LOCATE** Page in order to see where you are in the Sequence.

From the **PLAY/KEEP** Page:

Pressing **PLAY ORIGINAL TRACK** plays the Sequence from the beginning, with the selected Track as it was before you recorded over it.

Pressing **PLAY NEW TRACK** plays the Sequence from the beginning, with the new Track as you just recorded it.

Pressing the **Stop/Cont** Button Stops the Sequencer between plays.

Pressing the **Sequencer Foot Switch** from this Page will Stop and Continue the Sequencer -- but will always Play **only the NEW TRACK**.

You can select the **LOCATE** Page and use the **Auto-Locate Controls** from the **PLAY/KEEP** Page. For long Sequences or Overdubs you might want to start listening from some Bar other than the first. Select the **LOCATE** Page and use any of the three **Auto-Locate** Controls (as described on page 116) to select a starting point. You will be returned to the **PLAY/KEEP** Page, where the **PLAY ORIGINAL TRACK** or the **PLAY NEW TRACK** Button will now start the Sequence from the selected Bar.

Pressing **KEEP ORIGINAL TRACK** leaves the Track in the Sequencer Memory as it was before you recorded the New Track. If the Track was empty before recording, pressing **KEEP ORIGINAL TRACK** simply leaves the Track empty.

Pressing **KEEP NEW TRACK** enters the Track you just recorded into the Sequencer Memory. It will replace the original Track there.

SAVE CHANGES TO OLD SEQUENCE

Along with the **Track Data** (the Notes and Controllers that are recorded on each Track) there are several other parameters that are saved with each Sequence. These are:

- > the **Tempo** of the Sequence
- > the setting of the **LOOP** Switch, ON or OFF (**CONTROL** Page)
- > the **Program** assigned to each Track (**Tracks Select** Page)
- > the **Mix Level** of each Track (**Mix/MIDI** Page)
- > the **MIDI Channel** assigned to each Track (**Mix/MIDI** Page)
- > the **MIDI Program number** assigned to each Track (**Mix/MIDI** Page)
- > the **MIDI Status** of each Track (**Mix/MIDI** Page)

Whenever you record any Track of a Sequence, all of these values are automatically saved -- that is, they will be remembered by the **ESQ 1** if you leave the Sequence (by selecting another one) and return to it later.

However, if you change any of these parameters, and then select a new Sequence before you record any new Track Data, the following Page will appear:

SAVE CHANGES TO OLD SEQUENCE * YES *
 * NO *

Pressing *YES* saves the Sequence, with the current settings of all the parameters listed above, into Sequencer Memory.

Pressing *NO* leaves the settings of the parameters listed above as they were when you last Recorded a Track, or answered ***YES*** when exiting the same Sequence.

In either case, the **Track Data** (Notes and Controllers recorded) is always saved. Sometimes its hard to remember, when you get this Page, exactly what you changed. As a general rule, if you are happy with the Sequence as it is, answer ***YES***. If you have just been experimenting with different Tempos, Programs, MIDI configurations, etc., and want to keep the Sequence as it was before your experiments, answer ***NO***.

Altering a Sequence in **SONG Mode**

Another time you will get this Page is when you are in **SONG Mode** (a Song is selected rather than a Sequence), and you change one of the above parameters in a Sequence which is a Step in the selected Song. If the Song is playing, any changes you make on the fly will be "forgotten" as soon as the Step is over. If, however, the Song is stopped, and you change one of these parameters, when you next press **Play**, or select another Song or Sequence, the **ESQ 1** will ask "**SAVE CHANGES TO OLD SEQUENCE?**"

Pressing *YES* installs the altered settings of any parameters you changed into Sequencer Memory.

Pressing *NO* leaves the Sequence as it was before you changed it.

After you answer, the **ESQ 1** will immediately **Play**, change Sequences, or whatever you had instructed it to do.

SECTION 5 -- TRACKS and Other Sequencer Pages

105	ABOUT TRACKS
105	In General
105	When Recording Tracks
106	TRACKS SELECT Page
106	Selecting a Track
107	Changing the Program on a Track
108	"Unselecting" a Track -- Straight Synth Mode
109	Track Displays
111	Mix/MIDI Page
111	Sub-pages
112	Track Status
113	Track Program Number
114	Track Mix
114	Muting a Track
115	Track MIDI Channel
117	OTHER SEQUENCER PAGES
118	CONTROL Page -- Metronome, Clock Source and Loop Switch
121	LOCATE Page -- Sequence Location and Auto-Locate Controls
124	CREATE/ERASE Page
124	Creating a New Sequence
125	Creating a New Song
126	Erasing a Sequence
127	Erasing a Song
127	Erasing All Sequencer Data

TRACKS

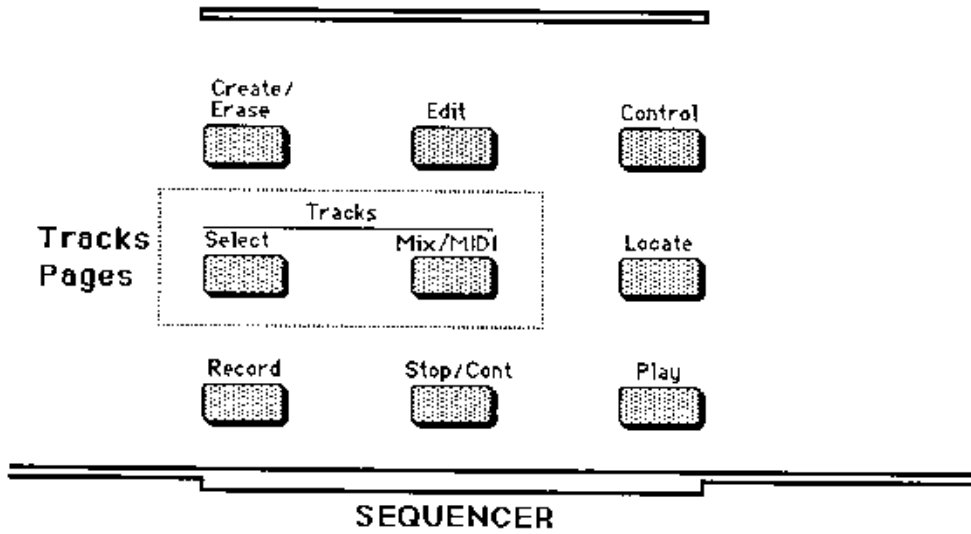

ABOUT TRACKS

Because the Synthesizer and Sequencer sections of the **ESQ 1** are interrelated in certain ways, it is important to understand that almost all Sequencer functions have some effect on the Synthesizer -- especially those which deal with **Tracks**. Here are a few basic Truths about Tracks:

In General

- > There are eight independent, polyphonic Tracks in each Sequence.
- > A Track can be selected from the **Tracks Select Page** or the **Mix/MIDI Page**.
- > Only one Track is ever selected at a time.
- > The selected Track is always underlined.
- > Each Track of each Sequence has its own:
 - Program** (Local)
 - Mix Level** (Local, and MIDI for instruments which receive MIDI volume)
 - MIDI Channel**
 - Status** (LOCAL, MIDI, BOTH, or SEQ)
 - MIDI Program Number** (same as Internal Program Number)
- > When you select a Track, that Track (its Program, MIDI Channel, MIDI Status etc.) "takes over" the Keyboard -- when you play, the Track's Program is the one you will hear; the Track's MIDI channel is the one that is transmitted on.
- > When No Track is selected, the Current Program plays on the Keyboard -- normal, "Straight Synth" operation.

When Recording Tracks

- > You can only record on one Track at a time.
- > When you enter **Record**, you will always record on the selected Track, and only on that Track.
- > When no Track is selected, going into **Record** automatically puts you on the Track that was last selected (or Track 1, in the case of a newly created Sequence).
- > The length of the First Track you record determines the length of the Sequence.
- > Recording on a Track always replaces what was previously there. It is Sound Over Sound, not Sound On Sound. You can achieve Sound On Sound, in which new Track data is added to the old, by Merging two Tracks together, an **EDIT** function.

[SELECT] Tracks Select PAGE

For Selecting Tracks and Selecting a Program for each Track

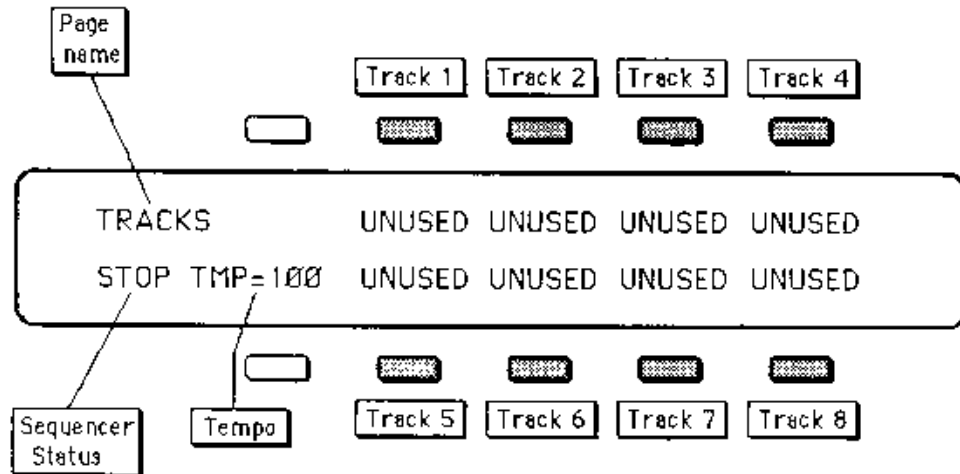

(Inactive Buttons appear in White)

From the **Tracks Select** Page, along with its companion Page, **Mix/MIDI**, you control all the characteristics of the various Tracks within a Sequence. On both the **Tracks Select** and the **Mix/MIDI** Pages, the eight Tracks of each Sequence always occupy the same eight locations on the Display, and are selected with same "Soft" Buttons, as shown above.

Each Track has a Local Program -- an **ESQ 1** sound that will play what is recorded on the Track, and will play from the keyboard when that Track is selected (unless a MIDI only Status has been selected). From the **Tracks Select** Page you select a Track (to Record on, to Edit, etc.), as well as selecting the Local Program that will play on that Track.

The illustration above shows the **Tracks Select** Page as it appears when a new Sequence is first created. When a Track location says "**UNUSED**," it simply means that that Track has not yet been defined. You define a Track by selecting it.

Selecting a Track

Any of the eight Tracks is selected by pressing the "Soft" Button corresponding to that Track. When you select a Track that was previously **UNUSED**, two things happen:

- 1) The word "**UNUSED**" is replaced by the name of the Current Program, and
- 2) The Track is now underlined, telling you that it is selected.

Take the above illustration, which shows the **Tracks Select** Page for a newly

[SELECT] Tracks Select PAGE (cont'd)

created Sequence. Say the current Program in the Synthesizer section is called **DRUMS**. If you select **Track 1**, the Page now looks like this:

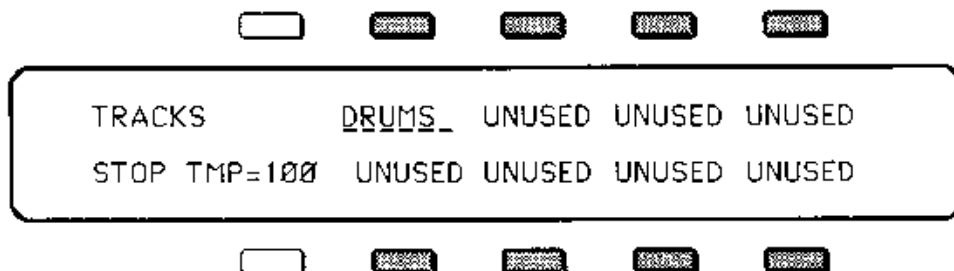

Now select **Track 2**, and the Page looks like this:

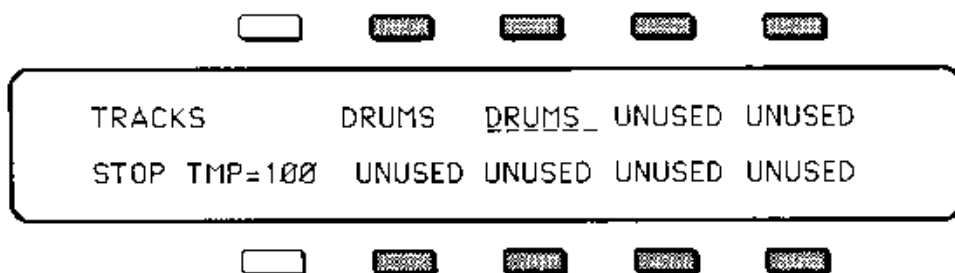

The Program from Track 1 was "carried over" and assigned to Track 2 when it was selected. **Selecting an UNUSED Track automatically assigns that Track the Program, and all the Mix/MIDI Data, from the previously selected Track (or the "Straight Synth" Program and MIDI Channel, if no Track was selected).**

When a Track is selected:

- 1) Its Program becomes the Current Program, the one that plays on the Keyboard;
- 2) Its MIDI Channel (**Mix/MIDI Page**) will be transmitted on;
- 3) That Track (and only that Track) is the one that will be Recorded when **Record** is entered;
- 4) That Track is the one that will be Edited when any of the **Track EDIT** functions is selected from the **EDIT Page**.

Changing the Program on a Track

The procedure for choosing a Program for a Track is similar to that for choosing a **WRITE** location, or a **LAYER** Program. While you are on the **Track Select Page**, the Program **Master Bank** and **Bank Select** Buttons act as momentary switches -- they only work as long as they are held down. Let them go and the Display springs back to the **Tracks Select Page**.

[SELECT] Tracks Select PAGE (cont'd)

The procedure for selecting an Internal Program for a Track is as follows:

- > Select **Tracks Select** Page.
- > Select one of the eight **Tracks**.
- > Press **INTERNAL**, **CART A** or **CART B** to select a **Master Bank**.
- > Press **Bank Select** Button(s) # 1, 2, 3 or 4 to find the Program you want.
- > While holding the Bank Select Button down, press the "Soft" Button above or below the Program.
- > Release the **Bank Select** Button. You will be returned to the **Tracks Select** Page, with the new Program Name showing in the selected Track's location.

"UNSELECTING" a Track -- Straight Synth Mode

Pressing the "Soft" Button above or below any of the eight Track locations on the **Tracks Select** Page selects that Track. Pressing the same Button again "Unselects" the Track, so that no Track locations on the Page are underlined. When no Track is selected, you are in the **Straight Synth Mode**. This is a state in which the Keyboard and the current Program are independent of the Sequencer.

Like each of the eight Tracks, the **Straight Synth Mode** has its own Program -- the Current Program -- which was the last one you selected before selecting a Track. The MIDI Channel selected on the **MIDI** Page in the Synth Section is its MIDI Channel. The **Straight Synth Mode** is another way of saying the Synthesizer Section of the ESQ 1 as it would behave if there were no Sequencer built in.

Straight Synth operation = No Track selected.

Whenever you call up a **Program Select** Page (from anywhere other than the **Tracks Select** Page) and select a Program in the usual fashion, the **ESQ 1** is automatically put into this **Straight Synth Mode**, to avoid inadvertently changing Sequencer settings from the Synthesizer.

Being in the **Straight Synth Mode** does not in any way disable the Sequencer, however. A Sequence or Song can be Played when no Track is selected, and you can play along, with the Current Program, which is independent of all eight Tracks. The elusive Ninth Track!

When no Track is selected, if you enter **Record**, the **ESQ 1** will automatically put you on the Track that was last selected, and will record on that Track.

[SELECT] Tracks Select PAGE (cont'd)

TRACK DISPLAYS

On the **Tracks Select** Page, the Display tells you a number of things about each Track. The illustration below shows a typical **Tracks Select** Page for a Sequence that has been recorded:

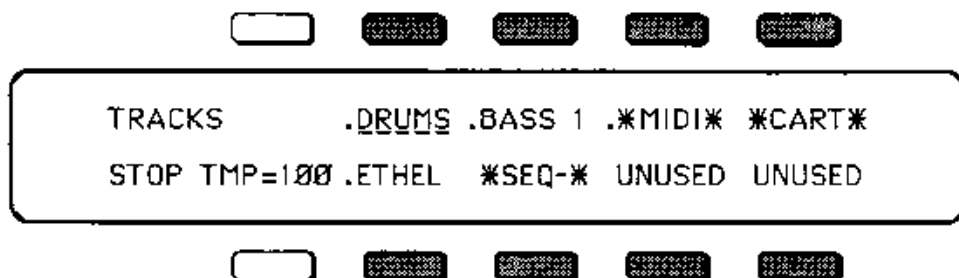

DOT = DATA

Notice that there is a **Dot** to the left of Track Locations 1, 2, 3 and 5. The other four locations have no Dot. As with the Sequence Locations, a **Dot to the left of a Track Location means that there is Data recorded on that Track.** Absence of a Dot means that nothing has yet been recorded on the Track. This allows you to tell at a glance whether a given Track contains any recorded Track Data, or whether it has simply been defined, but not yet recorded.

CART

When a Cartridge Program has been selected for a particular Track, it will play that Program and display the Program's name as described earlier, for as long as the Cartridge remains inserted. If, however, the Cartridge is removed, that Track Location will display the word ***CART*** instead of the Program Name, as in the case of **Track 4** above. This is to remind you that the Track is "pointing to" a Cartridge Program, but no Cartridge is inserted.

When this is the case, the Internal Program that is in the same relative Memory Location as the missing Cartridge Program will play on that Track until the Cartridge is re-inserted (or until another Program is selected for the Track). When the Cartridge is re-inserted, the proper Cartridge Program's Name will reappear, and that Program will play on the Track.

MIDI

On the **Mix/MIDI** Page (which we will cover next), it is possible to assign **MIDI only** Status to a given Track. This means that whatever is recorded on the Track, or played from the Keyboard when the Track is selected, will be sent out over MIDI, but will not sound at all on the **ESQ 1**. When **MIDI only** Status has been selected for a Track on the **Mix/MIDI** Page, the word ***MIDI*** will replace the Program Name on the **Tracks Select** Page, as in the case of **Track 3** above.

[SELECT] Tracks Select PAGE (cont'd)

SEQ-

When **SEQ-** Status has been selected for a Track on the **Mix/MIDI** Page, the word ***SEQ-*** will replace the Program Name on the **Tracks Select** Page, as with **Track 6** in the previous illustration.

FLASHING UNDERLINE -- Playing the EDIT Program on a Track

When a Track is selected, you can hear the Sound that's in the Edit Buffer (the EDIT Program) on that Track by simply pressing the **COMPARE** Button. Two things happen:

- 1) The Name of the Edit Program appears in that Track's Location on the **Tracks Select** Page, and
- 2) The underline beneath the Track Location **flashes**. The flashing underline means that the Track is playing the EDIT Program.

Pressing the **COMPARE** Button again returns you to the Program that is really on the Track -- the underline stops flashing, and the original Program Name reappears. This function is useful if you want to Edit the Program that is on a Track, and then hear the Track with the Edited Program.

Note: You cannot Record a Track with the Edit Program. Going into **Record** automatically puts the original Program back onto the Track. If you want to Record with the Edited Program on a Track you must first **Write (save)** it to a Program Location and then select the newly written Program for the Track, as described earlier. Also, if you leave the Track, by "unselecting" the Track or selecting another Track, the original Program will automatically be put back on the Track.

[Mix / MIDI] Tracks Mix/MIDI Page

For setting the Mix Level, MIDI Channel, MIDI Status and Program Number of each Track.

When you are using the **ESQ 1** by itself, Recording Tracks with only internal sounds, you won't need to concern yourself with the **Mix/MIDI** Page too much, except to balance the output levels of the different Tracks (**Mix down**). But once you start serious MIDI Sequencing -- driving numerous external instruments from the **ESQ 1** -- this page becomes the control center for your entire MIDI rig. From here you can determine the **Status** of each Track, send **Program Changes** to external instruments, adjust the **Mix Level**, and select a **MIDI Channel** for each Track.

When you begin setting up the MIDI configuration of a new Sequence, the **Mix/MIDI** Page should be your first stop. When you select a previously **UNUSED** Track from this Page, the effect is same as from the **Tracks Select** Page -- the new Track takes on all the characteristics of whatever Track was selected before (or of the Straight Synth section, if no Track was selected). You will find that this allows you quickly to define the configuration of a new Track, by first selecting a defined Track with a similar setup, then selecting an **UNUSED** Track and changing only the settings you want to be different for the new Track.

Sub-pages

The **Mix/MIDI** Page is actually four different Sub-pages, all of which are reached by pressing the **Mix/MIDI** Button. On all of these Sub-pages, each Track occupies the same relative location on the Display as it does on the **Tracks Select** Page:

	Track 1	Track 2	Track 3	Track 4
TRACK MIX	63	63	45	59
STOP *MORE*	63	63	(52)	63

On each of these Sub-pages, Display location # 6 shows the word ***MORE***. Pressing ***MORE*** advances the Display to the next Sub-page. Which of the four Sub-pages will appear when the **Mix/MIDI** Page is selected depends on which was last used. Here we will take them in order starting with the **Track Status** Sub-page.

Select the **Mix/MIDI** Page and press ***MORE*** until the upper left segment of the Display says **TRACK STATUS**.

[Mix / MIDI] Tracks Mix/MIDI Page (cont'd)

TRACK STATUS

The **Status** of a Track determines whether that Track will play only Locally (on the **ESQ 1**); over MIDI only; or Locally and over MIDI. This applies to playing the **ESQ 1** Keyboard with the Track selected, as well as playing back data Recorded on the Track.



- > Select any of the eight Tracks -- it becomes underlined.
- > Use the **Data Entry Slider** and the **Up and Down Arrow** Buttons to step through the four possible Track States:

BOTH -- The Track will play the **ESQ 1** Program showing on the **Tracks Select** Page and will be sent out over MIDI on its selected MIDI Channel.

MIDI -- The Track will be sent out over MIDI on its selected MIDI Channel, but will not play on the **ESQ 1**. When this Status is selected, the word ***MIDI*** will appear instead of the Program Name on the **Tracks Select** Page. Incoming MIDI Data will, however, play on the **ESQ 1**.

LOCAL -- The Track will play on the **ESQ 1** but will not be sent out over MIDI.

SEQ -- Same as MIDI Status, except that incoming MIDI data will not play locally on the **ESQ 1**. When **SEQ** is selected, the word ***SEQ-*** will appear instead of the Program Name on the **Tracks Select** Page.

The chart below details the behavior of a selected Track for each **Track Status**:

Track Status=	BOTH	LOCAL	MIDI	SEQ
Playing the ESQ 1 keyboard plays on the ESQ 1	Yes	Yes	No	No
Playing the ESQ 1 keyboard sends out MIDI	Yes	No	Yes	Yes
Playing the Track (pressing Play) plays on the ESQ 1	Yes	Yes	No	No
Playing the Track (pressing Play) sends out MIDI	Yes	No	Yes	Yes
Incoming MIDI data plays on the ESQ 1	Yes	No	Yes	No
Incoming MIDI data will be recorded on the Track (if you enter Record.)	Yes	No	Yes	Yes

[Mix / MIDI] Tracks Mix/MIDI Page (cont'd)

----> Selecting a Track on the **Track Status** Sub-page, and then pressing its button again, causes the underline to disappear, "Unselecting" the Track and putting the **ESQ 1** into the **Straight Synth** mode (no Track Selected).

* * * * **Note:** If you select a Track and get no sound from the keyboard, check to see if the Track has been assigned **MIDI** or **SEQ** Status here or has been turned **OFF** on the **Track Mix** Sub-page. **Now Press *MORE***

TRACK PROG NUM -- Track Program Number

From this Page you can adjust the Program a Track plays in terms of its MIDI Program Number. This is the number of the Program Change that will be sent out over MIDI when a Sequence is selected, or comes around in a Song.

It is also the MIDI number of the Internal **ESQ 1** Program assigned to the Track. The Program you selected for the Track from the **Tracks Select** Page and the Program number selected here are linked to each other -- changing either one will cause the other to change.

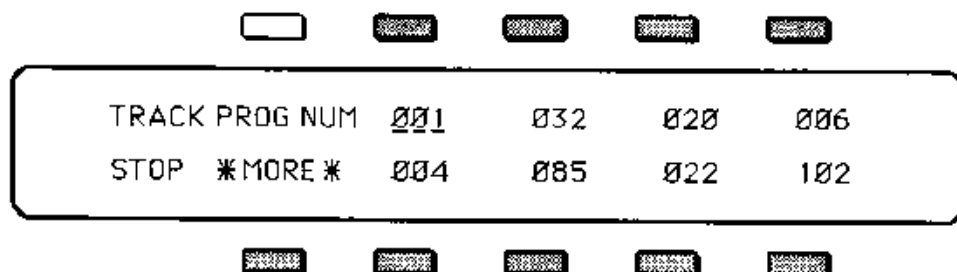

----> Select any of the eight Tracks -- it becomes underlined.

----> Use the **Data Entry Slider** and the **Up and Down Arrow** Buttons to change the MIDI Program Number. Range for each Track is **001 To 120** if a Program Cartridge is inserted, **001 to 40** if no Cartridge is in. Changing this number will also change the Program for that Track on the **Tracks Select** Page to the Internal or Cartridge Program which corresponds to the new number.

----> Selecting a Track, and then pressing its button again, causes the underline to disappear, "Unselecting" the Track and putting the **ESQ 1** into the **Straight Synth** mode (no Track Selected.)

When a Track is sending to an external instrument via MIDI, you can use this Sub-page to change the Program (or patch) that instrument is playing, assuming it receives MIDI Program changes. This means that once you have assigned each external instrument a different MIDI Channel, you can control them all right from the **ESQ 1**.

Now press *MORE*.

[Mix / MIDI] Tracks Mix/MIDI Page (cont'd)

TRACK MIX

TRACK MIX determines the relative volume of each Track. This controls the LOCAL, or Internal, volume of a Track, as well as MIDI Volume (MIDI Controller #7). When a new Sequence is selected, each Track sends out MIDI Volume information on its selected MIDI Channel. (Not all instruments receive MIDI Volume, but the Sequencer Tracks send it to and receive it from those who do.)

TRACK MIX	<u>63</u>	63	45	59	
STOP *MORE*	63	63	(52)	63	

- > Select any of the eight Tracks -- it becomes underlined.
- > Use the **Data Entry Slider** and the **Up and Down Arrow** Buttons to adjust the Level of the Track. Range for each Track is **OFF To 63**. The Level can be continuously adjusted, either while playing back recorded Track Data, or while playing the **ESQ 1** Keyboard with the Track selected.
- > Adjusting a Track all the way to **OFF** will silence the Track, Locally and on external instruments which receive MIDI Volume.

Muting a Track

Unlike the other three Sub-Pages, selecting a Track on this Page, and then pressing its button again, **Mutes** the Track on the **ESQ 1** and over MIDI. (This works whether the Receiving Unit reads MIDI Volume or not.)

When a Track is Muted in this way, **Parentheses** appear around the Mix number, as in the case of **Track 7** in the illustration above. Pressing the Button again removes the Parentheses and Unmutes the Track. This is a handy way to temporarily mute a Track without disturbing its **MIX Level**. This is a temporary state and is not saved with the Sequence. If you Mute Track 6, and then select another Sequence, Track 6 will still be Muted in the new Sequence.

You can think of this Sub-page as the "Mix down" section of the Sequencer. For each Sequence you can balance the Output Level of each Track that is playing Locally, and of each MIDI Track that is playing on an instrument which receives MIDI Volume. For external instruments which don't receive MIDI Volume, you will have to adjust their volume controls separately.

Now Press *MORE*

[Mix / MIDI] Tracks Mix/MIDI Page (cont'd)

TRACK MIDI CHANNEL

From this Sub-page, each Track of a Sequence is assigned its own **MIDI Channel**. The Track will always send information on that Channel, and only on that Channel. This applies to playing the **ESQ 1** Keyboard when the Track is selected, as well as playing back recorded Track Data. (Of course, if the Track is assigned LOCAL Status, its MIDI Channel doesn't matter -- it will not send on any Channel.)

What information a Track receives depends on which **Mode** is selected on the **MIDI** Page. When the **ESQ 1** is in **MULTI** Mode each Track will receive incoming MIDI information only on the Channel you select here. In **OMNI** Mode, a selected Track will receive on any Channel. In **POLY** Mode, a selected Track will receive only on the **Base Channel** (the Channel selected on the **MIDI** Page.)

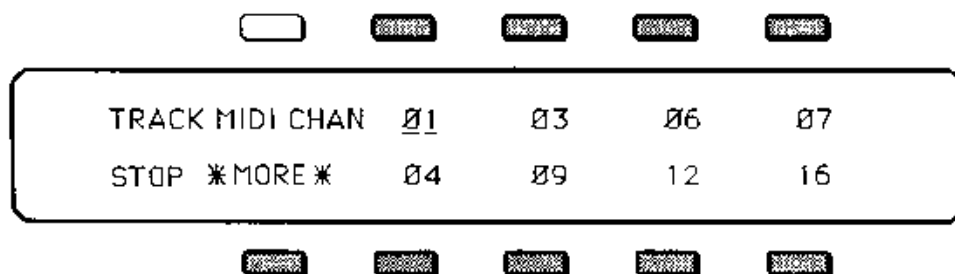

- > Select any of the eight Tracks -- it becomes underlined.
- > Use the **Data Entry Slider** and the **Up and Down Arrow** Buttons to assign a MIDI Channel to the Track. Range for each Track is **1 To 16**.
- > The **ESQ 1** must be in **MULTI** Mode for each Track to receive MIDI information on its selected Channel. You should assign each Track to a different Channel. If two or more Tracks have the same MIDI Channel, the lowest-numbered Track will receive the information, and the higher-numbered one(s) will receive nothing.
- > Selecting a Track, and then pressing its button again, causes the underline to disappear, "Unselecting" the Track and putting the **ESQ 1** into the **Straight Synth** mode (no Track Selected).

*** * * * Note:** When you are playing an external instrument from a Track, don't change the MIDI Channel while you are holding down a key or pressing the Sustain Pedal. This can cause the receiving instrument to sustain notes forever, which can be annoying. If this happens, turn the receiving unit Off, and then turn it back On.

Pressing ***MORE*** again returns you to the **Track Status** Sub-page.

OTHER SEQUENCER PAGES

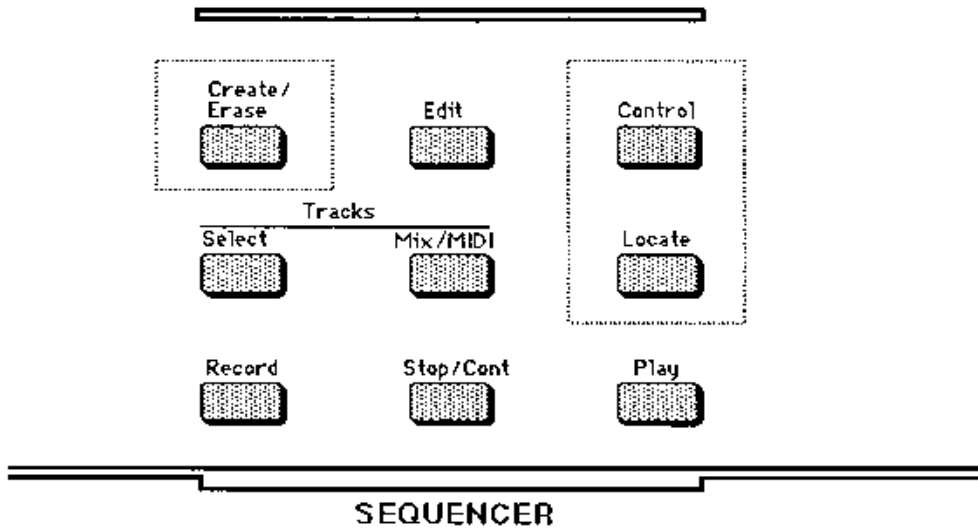

[CONTROL] SEQUENCER CONTROL PAGE

Controls Clock Source, Loop and Metronome Parameters

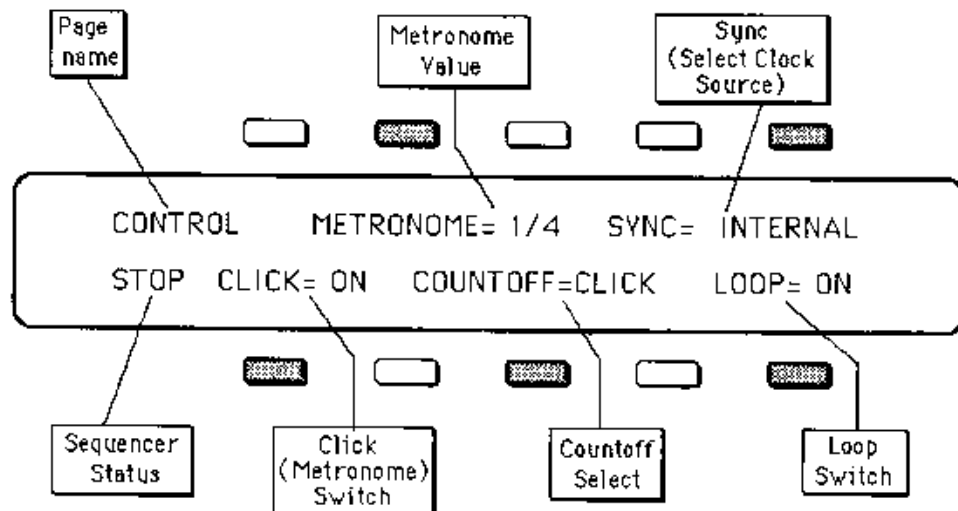

(Inactive Buttons appear in White)

Before recording or playing back a Sequence, you will want to select the **CONTROL** Page and adjust its parameters to suit your current needs. From this Page you control the **CLICK** track (or metronome), the **COUNTOFF** (a one measure count, with or without Click track, before the Sequence begins), the **LOOP** switch and the Clock Source.

Don't forget that the settings you select here (as with all **ESQ 1** parameters) will be remembered by the **ESQ 1**, even while it is OFF. It is a good idea, when starting to record or play Sequences, to check this Page first. (You don't, for example, want the Click Track ON while playing sequences in live performance.)

Use this Page to:

- 1) Select the Sequencer Clock Source;
- 2) Turn ON or OFF the **CLICK** (metronome);
- 3) Adjust which beats the Metronome plays on;
- 4) Choose whether or not you want a **COUNTOFF**; and
- 5) Turn ON or OFF the **LOOP** switch.

[CONTROL] SEQUENCER CONTROL PAGE (cont'd)

ACTIVE CONTROLS:

2. METRONOME

When **CLICK=ON** (see #6 below) a Click Track, or Metronome, will play throughout the Track. This Click Track will normally fall on each beat of the measure (on each 1/4 note in 4/4 Time, for instance), with the first beat accented. When you select a new Sequence, the Metronome is automatically set for one Click per beat. You don't have to adjust it unless you want something different.

You can, however, use this control to adjust which beats of the measure the Click will play on. If you are recording something with a shuffle feel, for example, you might want to set the **METRONOME** to 1/8th-note Triplets. Any value which is valid within the Sequence's Time Signature can be selected from the following:

1/4	(Quarter Notes)	1/4T	(Quarter-note Triplets)
1/8	(Eighth Notes)	1/8T	(Eighth-note Triplets)
1/16	(Sixteenth Notes)	1/16T	(Sixteenth-note Triplets)
1/32	(Thirty-second Notes)	1/32T	(Thirty-second-note Triplets)

5. SYNC

Selects Sequencer Clock source. The setting of this control determines where the Sequencer gets its Clock signal -- Internally, or from an external source.

The three options are:

- > **INTERNAL** -- The **ESQ 1** uses its own Clock.
- > **MIDI CLOCK** -- The **ESQ 1** Sequencer will sync to the Clock of any MIDI device which has a clock pulse (a Drum machine, other sequencer, etc.) and whose MIDI OUT is connected to the **ESQ 1**'s MIDI IN. (See p. 168 for more details.)

MIDI Clocks are transmitted and received regardless of which MIDI Channels the two devices are set to. Almost all current MIDI sequencing devices send **Start**, **Stop** and **Continue** messages, so you can use the sending device to Start, Stop and Continue the **ESQ 1** Sequencer as well as controlling its Clock rate.

- > **TAPE SYNC** -- When **TAPE SYNC** is selected, the Sequencer will take its clock source from the **Tape In** jack on the rear panel. This jack can be connected to the output of a multitrack tape deck, where a Tape Sync track has previously been recorded. When put into **Play** or **Record** modes, the **ESQ 1** will wait for the recorded sync signal before starting to play. (See p. 169 for more.)

The **Tape In** jack on the rear panel can also be connected to the **Tape Out** or **Clock Out** jack on any other sequencing device, drum machine, etc. By setting **SYNC** to **TAPE SYNC**, you can then sync the **ESQ 1** to the other machine's clock without connecting them via MIDI. (This does not, however, send Start, Stop and Continue messages.)

[CONTROL] SEQUENCER CONTROL PAGE (cont'd)

Likewise, if the **Tape Out** jack of the **ESQ 1** is connected to the **Tape In** of another sequencing device, then that device can sync to the **ESQ 1's** clock without connecting them via MIDI. (The other device must be set for **Tape Sync**.)

6. CLICK

This control turns On or Off the "**Click**" track, or metronome, during the Sequence. The **Click** is an electronic "Tick" which plays on each beat of the measure (or whatever value has been assigned at #3 above). The **first beat** of every Bar is **accented**.

The setting of this parameter affects only the body of the Sequence (or Song) itself, and has no effect on the **Countoff**. As a general rule, you will want the **Click ON** when recording Tracks, and **OFF** when playing them back.

The volume of the **Click** Track is fixed, and is not affected by the **Volume** Control of the **ESQ 1**. With the **Click ON**, first adjust your mixer or amplifier so that the **Click** plays at an appropriate level. Then use the Volume Control to set the Synthesizer volume to the proper level relative to the **Click**.

8. COUNTOFF

The **Countoff** is a one-Bar count which precedes a Sequence or Song, when it is played from the beginning. This count can be with or without a **Click** track. The available options are:

- > **NONE** -- The Sequence begins playing immediately after you press **Play** or **Rec/Play**.
- > **QUIET** -- There is one measure of silence before the Sequencer begins to **Play** or **Record**. This is good when using the **ESQ 1** with a Drum Machine -- you can use the Drums as a lead-in instead of the **ESQ 1's** **Click**.
- > **CLICK** -- There is one measure of **Click** track before the Sequence begins to play. In many normal sequence recording situations, this setting, **COUNTOFF=CLICK**, is the most useful.

10. LOOP

Determines whether a Sequence or Song will repeat after playing through once.

When ON: At the end of a Sequence, or Song, the Sequencer will return to the beginning and play it over again. It will continue to repeat until **STOP** is hit.

When OFF: The Sequence or Song will play once through and stop.

The setting of the **LOOP** Switch is saved for each Sequence, but not for a Song. A Song will only loop if **LOOP=ON** when it is played.

[LOCATE] SEQUENCE LOCATE PAGE

Provides information about location within a Sequence; Allows access to any Bar within a Sequence; Adjusts Tempo; Shows Time Signature and Selected Track.

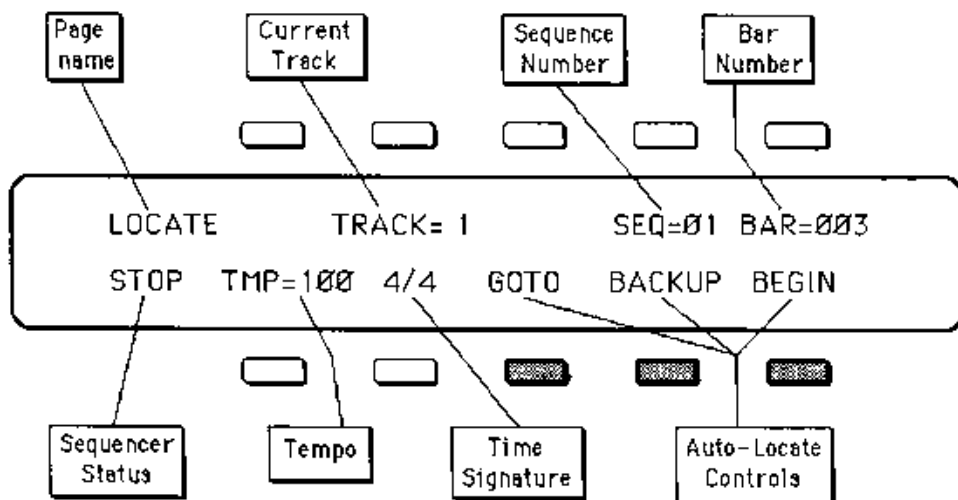

(Inactive Buttons appear in White)

The **LOCATE** Page appears whenever the Sequencer is in the **Play** or **Stop** modes, and when the **LOCATE** Button on the front panel is pressed. This Page provides valuable Sequencer information as well as control over **Tempo** and **Auto-Locate** functions.

The **Status** of the Sequencer (whether it is in **Play**, **Stop**, **Record**, etc.) is always shown in the lower left-hand corner of the Display on this Page. The currently selected **Track** is displayed on the top row. (You can't select a different Track from here; this Readout is just there to help you keep things straight.) If no Track is selected (Straight Synth operation), it will read **TRACK=NONE**.

The **TEMPO** Control is always active. Unless you have pressed **GOTO**, the **Data Entry Slider** and the **Up and Down Arrow Buttons** will affect only the Tempo while you are on the **LOCATE** Page. **TEMPO** does not have to be selected.

The last three buttons on the **LOCATE** Page are the **Auto-Locate Controls**. They allow you to quickly go to any Measure within a Sequence, to back up one measure at a time, or to reset to the beginning of the Sequence.

This section describes the **LOCATE** Page as it appears when a Sequence is selected. When a Song is selected, the **LOCATE** Page is a little different (see **SONG LOCATE** Page, p. 164).

[LOCATE] SEQUENCE LOCATE PAGE (cont'd)

READOUTS AND ACTIVE CONTROLS:

2. TRACK=

Tells you which of the eight **Tracks** is selected. If no Track is selected, it will read **TRACK=NONE**.

4. SEQ=

Tells you which Sequence is selected.

5. BAR=

Tells you which Bar of the Sequence is playing; or, if the Sequencer is in **Stop Mode**, which Bar it will play from if you press **Stop/Cont**.

6. TMP=

The **Tempo** of the Sequence, in **Beats per minute**, is displayed here, and is continuously controlled by the **Data Entry Slider** and the **Up and Down Arrow Buttons**. **Tempo** does not have to be selected.

When an External Clock Source is selected (see **SYNC**, p. 119) this readout will show **TMP=EXT**.

7. TIME SIGNATURE

The **Time Signature** of the Sequence is displayed here. The **Time Signature** is set when the Sequence is Created, and cannot be changed from here.

Auto-Locate Controls:

8. GOTO

GOTO allows you to start Playing or Recording the Sequence from any Bar within the Sequence. To reach a particular Bar:

----> Press **GOTO**. The Display shows:

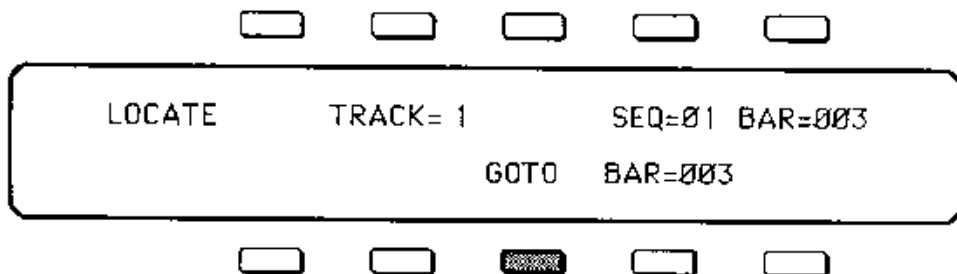

----> Use **Data Entry Slider** and the **Up and Down Arrow Buttons** to adjust the **GOTO Bar** number to the Bar at which you want to start. You can choose any Bar within the current Sequence.

[LOCATE] SEQUENCE LOCATE PAGE (cont'd)

----> Press **GOTO** again. You are returned to the **LOCATE** Page, with the new Bar number showing in the upper-right corner of the Display.

Helpful Hint: The **GOTO** Bar you last selected is remembered by the **ESQ 1**. This means that you can just press **GOTO** twice to quickly locate to the same Bar, when, for example you want to start from the same point in the middle of a Sequence for repeated takes of a Track.

9.) **BACKUP**

Each press of this button backs the Sequence Location up One Bar from the current Location.

10.) **BEGIN**

Pressing this button resets the Sequence to the beginning of Bar 1. It's a good idea to get in the habit of hitting **BEGIN** before recording any Track, since going into **Record Mode** does not automatically start the Sequence from the beginning.

[CREATE/ERASE] CREATE/ERASE PAGE

For Creating new Sequences or Songs, Erasing existing Sequences or Songs, and Erasing all Sequencer Memory.

Until a Sequence or Song has been created, it is just an empty, undefined slot in the **ESQ 1's** Memory, and cannot be selected or played. An undefined Sequence will be shown on the **Sequence Select** Page as **XXX - 05**, instead of **SEQ - 05**, which is how a Sequence appears after it has been defined. The first step in recording a new Sequence is to **Create**, or define, a Sequence in one of the empty Sequence Locations.

When you press the **CREATE/ERASE** Button, the Page appears as shown below:

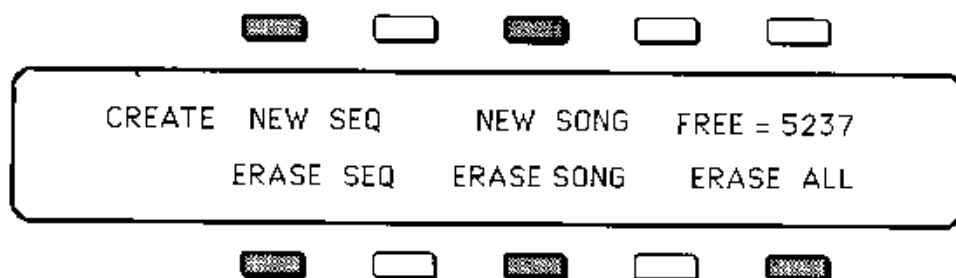

Available Memory

First notice the upper-right segment of the Display -- [**FREE=**___]. This tells you the number of **Bytes** of Sequencer Memory available. A **Byte** is eight **Bits** of digital information. Each note you play uses a little over three Bytes, so when all the Internal Sequencer Memory (about 8000 Bytes) is available, you can record about 2400 notes. This can be expanded to 32000 Bytes, or about 10000 notes, by installing the optional **SQX-10 Sequencer Expander Cartridge**.

These numbers reflect notes played (Key Events) only, and do not take into account Controllers such as Pitch Bend, MOD Wheel, Pressure, etc. Controller values are recorded by a digital sequencer as a steady stream of numbers, and thus use up available memory much faster than Key Events. When you record using a lot of Controllers, you will expend the available memory rather quickly.

ACTIVE CONTROLS:

1. CREATE NEW SEQUENCE

A new Sequence can be Created in any of the thirty Sequence Memory Locations that doesn't contain a defined Sequence -- where **XXX** appears instead of **SEQ** on the **Sequence Select** Pages. It is important to note that at the time a Sequence is created, you must define the **Time Signature** of that Sequence. The Time Signature cannot be changed after the Sequence has been created.

To CREATE a New Sequence

----> Select **CREATE/ERASE** Page

----> Press **NEW SEQ.** The Display shows the following:

CREATE NEW SEQUENCE 05 * YES *
TIME SIGNATURE = 4 / 4 * NO *

----> **Select a Memory Location.** Use the **Data Entry Slider** and the **Up and Down Arrow** Buttons to select which Sequence Memory Location you wish to create the new Sequence in. Only the numbers of empty, or undefined, Locations are available for selection.

----> **Adjust the Time Signature.** If you want the new Sequence to have a Time Signature other than 4/4, press the "Soft " button below the Time Signature and then use the **Data Entry Slider** and the **Up and Down Arrow** Buttons to adjust it to the one you want. If you want 4/4 Time you don't have to adjust anything -- the Page always appears with 4/4 Time selected.

----> Press ***YES*** to Create a Sequence, with the selected Time Signature, in the selected Sequence Memory Location. You will then be returned to the **Sequence Select** Page that the new Sequence is on, and the new Sequence will be selected. Or Press ***NO*** to cancel the procedure for any reason.

3. CREATE NEW SONG

The **ESQ 1's Song Mode** allows you to chain Sequences together in any order, with up to 99 Steps and up to 99 Repetitions of each Step per Song. There are ten **Song Memory Locations** which, unlike the 30 Sequence Locations, have Names instead of numbers. You name the Song when you create it.

When you create a new Song, it is automatically put in the first empty Song Memory Location on the **Song Select** Page. Since all ten Songs are selected from the same Page, and they are all named, there is no need to be able to select the exact location of a given Song. If there are no empty Song Locations, you must Erase a Song (see below) before you can create a new one.

To CREATE a New Song

----> Select **CREATE/ERASE** Page

----> Press **NEW SONG**. The Display shows the following:



----> **Select a Name for the New Song.** In the middle of the upper row of the Display is the six-letter **Song Name**, with a Cursor beneath the first letter. Use the **Data Entry Slider** and the **Up and Down Arrow** Buttons to change the first letter to the one you want. Press the "Soft" Button labeled **RIGHT** to move the Cursor to the next letter, and change that letter the same way.

Do the same for each space, using the **Data Entry Slider** and the **Up and Down Arrow** Buttons to scroll the available characters and the **LEFT** and **RIGHT** Buttons to move the Cursor, until the Display shows the Song Name you want.

----> Press ***YES*** to Create the Song. You will then be placed on the **SONG EDIT** Page from which you can combine Sequences to form a Song (see **SONG EDIT** Page, p. 160) Or Press ***NO*** to cancel the procedure for any reason.

6. ERASE SEQUENCE

Erasing a Sequence returns that Sequence Memory Location to its undefined, or empty state. The Sequence you want to Erase must be selected before entering the **CREATE/ERASE** Page.

To ERASE a Sequence

----> Make sure the Sequence you want to Erase is selected.

----> Select **CREATE/ERASE** Page.

----> Press **ERASE SEQ**. The Display asks "ERASE EXISTING SEQ 01".

----> Press ***YES*** to Erase the Sequence. You will be returned to the **Sequence Select Page**. Or Press ***NO*** to cancel the procedure for any reason.

8. ERASE SONG

Erasing a Song returns that Song Memory Location to its undefined, or empty state. The Song you want to Erase must be selected before entering the **CREATE/ERASE** Page.

To ERASE a Song

- > Make sure the Song you want to Erase is selected.
- > Select **CREATE/ERASE** Page.
- > Press **ERASE SONG**. The Display asks "**ERASE EXISTING SONG SONG-0**" (where **SONG-0** stands for whatever the name of the Song is).
- > Press ***YES*** to Erase the Song. You will be returned to the **Song Select Page**. Or Press ***NO*** to cancel the procedure for any reason.

10.) ERASE ALL

This procedure will erase all Sequences and Songs in the **ESQ 1's** Memory. This is not something you want to do casually. Save any Sequencer data you value to audio Tape, or via MIDI to a **Mirage** or another **ESQ 1** before you even think about doing an **ERASE ALL**.

ERASE ALL will return every Sequence except **SEQ 01**, and every Song except **SONG 00** to its undefined state. (You can't totally Erase the last Sequence. There will still be one Sequence and one Song defined, though after an **ERASE ALL** they contain no Track or Song Data.)

To ERASE ALL Sequences and Songs

- > Save any Sequences and Songs you want to keep to Tape or via MIDI.
- > Select **CREATE/ERASE** Page.
- > Press **ERASE ALL**. The Display asks "**ERASE ALL SEQUENCES AND SONGS**".
- > Press ***YES*** to Erase All Sequences and Songs in Memory. You will be returned to the **Sequence Select Page**. Or Press ***NO*** to cancel the procedure for any reason.

SECTION 6 --Recording a Sequence

- 130 SEQUENCING ON THE ESQ 1**
- 130 Recording The First Track**
 - 131 Using the Foot Switch to Define Sequence Length
- 132 Recording Other Tracks**
 - 132 Recording from the Beginning of a Track
 - 133 Overdub Mode -- "Punching In"
 - 135 "Punching Out"
- 135 MIDI SEQUENCING ON THE ESQ 1**
 - 135 Basic MIDI Connections
 - 136 Using a MIDI Thru Box
- 136 MIDI MODE AND CHANNEL -- Destination Instruments**
- 137 TRACK CONFIGURATION**
 - 138 Recording the First Track
 - 138 Other Tracks

SEQUENCING ON THE ESQ 1

You may or may not own a roomful of other MIDI Instruments to sequence from the **ESQ 1** -- either way you will find that the **ESQ 1** Sequencer allows you to create poly-timbral recordings with amazing ease. In this section we will deal first with Recording various Tracks of a Sequence on the **ESQ 1** alone (no MIDI connections).

RECORDING THE FIRST TRACK

The length of the First Track defines the length of the Sequence. For this reason, there is a special procedure for recording the First Track of a new Sequence.

To Record the First Track of a Sequence:

- > **Create a New Sequence.** (See **CREATE/ERASE** Page, p. 124.)
- > **Select a First Track.** Go to the **TRACKS SELECT** Page. All the Track locations of a newly created Sequence will say "**UNUSED**":

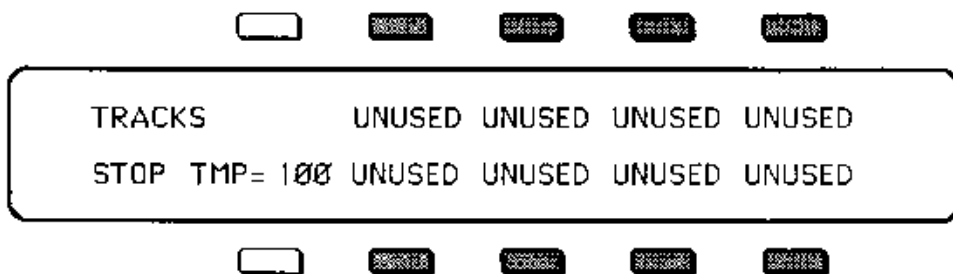

Pressing any of the eight active "Soft" Buttons will select that Track and put the current Program on it. The first Track does not have to be Track 1 -- any of the eight Tracks can be selected and recorded first, and will be considered the First Track.

- > **Select a Program.** While on the **Tracks SELECT** Page, press **INTERNAL**, **CART A** or **CART B**. Then press any of the **Bank Select** Buttons to locate the Program you want. While holding a Bank Select Button down, press the "Soft" Button that corresponds to the Program you want. Release the **Bank Select** Button. The Program you chose is now on the selected Track.
- > **Turn the CLICK Track ON.** Select the **CONTROL** Page and make sure that **CLICK= ON**.
- > **Press Record/Play.** While holding down the **Record** Button, Press the **Play** Button. The Metronome starts, and "**REC**" flashes in the lower left corner of the Display. Don't play anything yet -- the Sequencer is in a special Record "Standby" mode that only applies to recording the First Track. Nothing will be recorded until you begin to play.

- > **Adjust the TEMPO.** Use the **Data Entry Slider** and the **Up** and **Down Arrow Buttons** to set the Tempo you want. Tempo does not have to be selected.
- > **Start Playing.** As soon as you strike any key, the Sequencer will begin recording the Track. The **TMP=**, Tempo readout on the Display will now change to show the Bar Number. The Bar in which you first began playing becomes Bar 001. You can also press the **Sequencer Foot Switch** to put the Sequencer into **Record** without playing anything.
- > **Press STOP to halt recording.** When you get to the end of what you want to record, press the **STOP** Button, or the Footswitch, to stop the Sequencer.

After recording the First Track, the Display shows the Following:

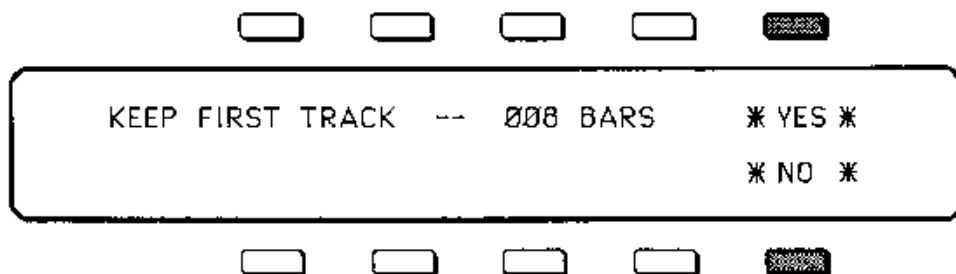

- > **Press *YES* to accept the First Track.** If the length and Performance of your First Track are acceptable, you can answer ***YES*** to enter it into Memory as the First Track. It's length will now define the length of the Sequence. After you answer ***YES***, the First Track is treated like any other, and Recording over the First Track proceeds as shown below, in "**Recording Other Tracks.**" Or,
- > **Press *NO*** to leave the First Track blank, and try again. If the length and/or the performance of the Track you just recorded is way off, answering ***NO*** will return the Track to its unrecorded state. Press **Record/Play** and repeat the procedure, as many times as needed to get a First Track that you want to keep.
- * * * **Note:** Even after you press ***YES*** to accept a First Track, neither the length nor the performance of that Track is chiseled in stone. After answering ***YES***, you can, for instance, use the **Change Length** EDIT function to alter the Length of the Sequence, and then Record over the First Track, replacing it entirely. So don't worry that you have to get the First Track perfect before accepting it. You don't.

Using the Foot Switch to Define Sequence Length

You can use the Sequencer Foot Switch to simply define the length of the Sequence without Recording any Track Data on the First Track. With the Sequencer in the Record "Standby" mode (**REC** flashing), press the Foot Switch. This puts the Sequencer into **Record**, and the Bar Count begins. Near the end of the Bar you want to be the Last

Bar, press the Foot Switch again to Stop the Sequencer. The Display will ask **KEEP FIRST TRACK**, as above. If the length is right, answer ***YES***. Now you can Record over the first Track as you would any other, as explained below.

RECORDING OTHER TRACKS

After you have answered ***YES*** to the question "**KEEP FIRST TRACK?**," all other Recording, including re-recording the First Track, will follow the same basic routine. The length of the Sequence is now defined (by the length of the First Track). The rest of the Tracks will automatically have the same length.

There are two methods of entering **Record** -- going straight into **Record** by pressing **Record/Play**, or using the **Overdub Mode**, which waits for you to play before Recording anything.

Recording From the Beginning of A Track

- > **Select Tracks SELECT Page.**
- > **Select another Track.** (Or leave the First Track selected if you want to Record over it.) All the Track locations except for the First Track will still say "**UNUSED**". To Record a different Track, press the "Soft" Button above or below another Track Location to select another Track. The name of the Program, and all the **Mix/MIDI** Page information, from the previous Track is copied onto to the new Track.
- > **Select a Program.** As shown above, from the **Tracks SELECT** Page, press **INTERNAL, CART A** or **CART B**. Then press any of the **Bank Select** Buttons to locate the Program you want. While holding a **Bank Select** Button down, press the "Soft" Button that corresponds to the Program you want. Release the **Bank Select** Button. The Program you chose is now on the selected Track.
- > **Check the CONTROL Parameters.** Select the **CONTROL** Page and see that the **Click, Countoff** and **Loop** switches are set according to your needs. For most recording, the recommended settings are:
LOOP= ON, CLICK= ON, COUNTOFF= CLICK.
- > **Select the LOCATE Page, and press BEGIN.** This resets the Sequence to the beginning. It is a good idea to get in the habit of doing this each time you Record a Track. (Pressing **Record/Play** doesn't reset the Sequencer to the beginning of the Sequence.)
- > **Press Record/Play to begin recording.** The **Click** will play for one measure (assuming **COUNTOFF= CLICK**) and then the Sequencer will enter **Record mode**. It will record whatever you play on the new Track until:
 - 1.) The end of the Sequence is reached, or
 - 2.) You press **STOP** (or hit the Foot Switch).

At the end of the Sequence, the **ESQ 1** will leave **Record** Mode and (assuming **LOOP= ON**) enter **Audition Play Mode** -- the lower-left corner of the display reads "**AUDP.**"

- > Press **Stop** or the **Foot Switch** to **Stop the Sequencer**. This puts you onto the **PLAY/KEEP** Page:

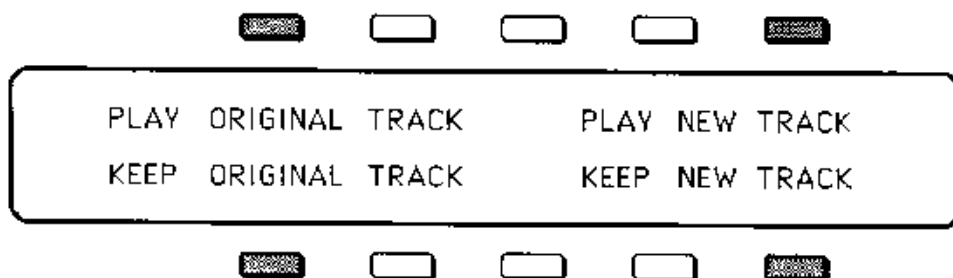

- > Press **PLAY ORIGINAL TRACK** to hear the Track as it was before you recorded the new Track. The first Time you Record a particular Track, this isn't much use, but it is invaluable when you begin to do second and third takes, since it allows you to compare the Tracks before deciding which to Keep.
- > Press **PLAY NEW TRACK** to hear what you just recorded.
- > Press **KEEP ORIGINAL TRACK** to leave the Track as it was in Memory, and "Burn" the one you just recorded. If the Track was empty before Recording, pressing this Button will leave it Empty.
- > Press **KEEP NEW TRACK** to save the New Track into Memory, replacing whatever was on the Track before.

OVERDUB Mode -- "Punching In"

The second method of entering **Record** is to "Punch In" using the **Overdub** Mode. Whenever the **ESQ 1** is in **Play**, pressing the **Record** Button puts it into **Overdub**. The message **ODUB** flashes in the lower-left corner. The moment you play a note, or press the **Sequencer Foot Switch**, the **ODUB** message changes to **REC**, and the Sequencer begins Recording on the selected Track. It will record from that point to the end of the Sequence, unless you press **Stop** first.

To "Punch In" on a Track:

- > Make sure the Track you want to Punch In on is Selected. (Or, for a new Track, select a Track, and a Program for it as shown above.)
- > Press the **Play** Button. The Sequence begins to play.
- > Press the **Record** Button. **ODUB** will flash on the Display. Now the **ESQ 1** will wait for you to play before recording anything. You can (assuming that the **LOOP** is **ON**) let the Sequence play through as many times as you want before Punching in.

----> **Begin to Play.** As soon as you play a note, or press the **Sequencer Foot Switch**, Recording begins. Unless you then press **Stop** or the Foot Switch, new Track Data will be Recorded from the point where you Punched in to the end of the Sequence, where the Sequencer will leave **Record** and enter **Audition Play**. How much of the Track you record over depends on where you Punch in:

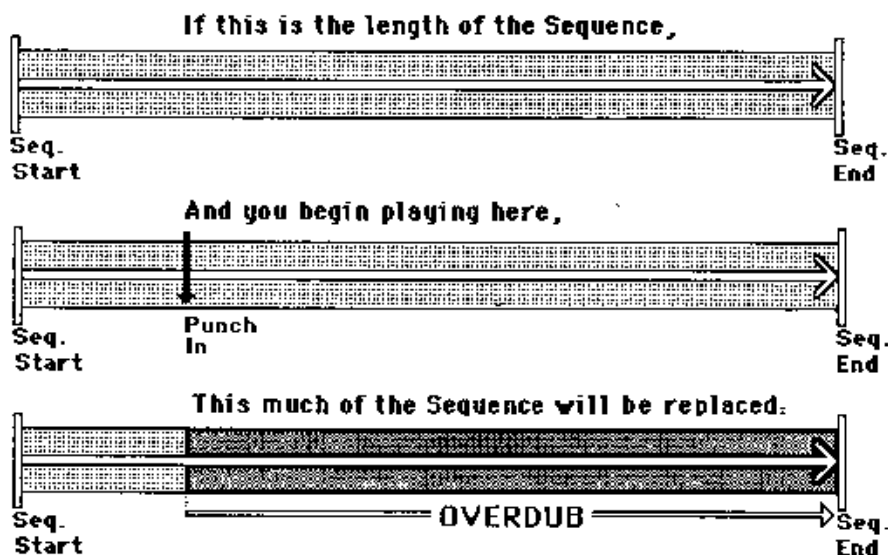

OR,

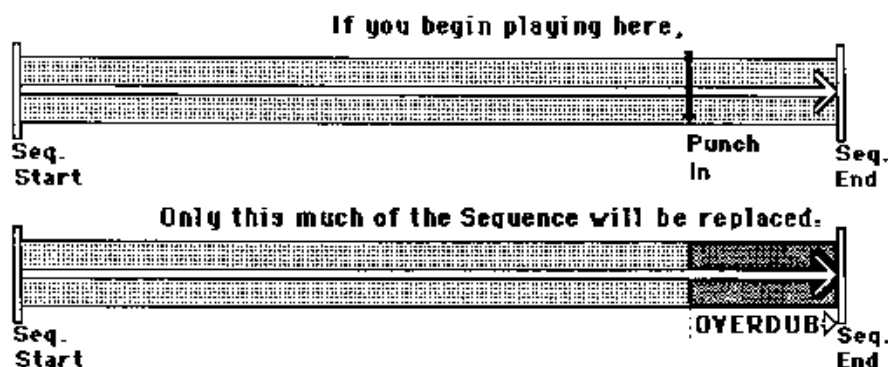

----> **Press Stop.** You will then get the **PLAY/KEEP** Page where you can audition the New and the Original Tracks before deciding which to keep.

The **Overdub** Mode is often a desirable way to enter **Record** even if you plan to record from the beginning of the Track -- just press the **Record** Button while playing a Sequence, wait for the beginning to come around again, and then play, to start Recording. This method lets you get a feel for the Sequence, while listening to it one time through (or more), before Recording. For many players this may work better than having just a one measure **Countoff** in which to get ready to Record.

"Punching Out"

As mentioned previously, pressing the **Stop Button**, or the **Sequencer Foot Switch** while recording not only stops the Sequencer, but takes it out of **Record**. Pressing **Play** will also take you out of Record, putting you into **Audition Play**. So if, for example, you want to replace the first part of a Track but leave the rest intact, you can do so by simply pressing **Stop**, **Play** or the Sequencer Foot Switch at the point where you wish to Punch Out.

MIDI SEQUENCING ON THE ESQ 1

Basic MIDI Connections

When using the **ESQ 1** to sequence multiple MIDI devices, first connect the various Destination instruments to the **ESQ 1**, and to each other, as shown below. Connect the **MIDI Out** jack of the **ESQ 1** to the **MIDI In** jack of the first instrument. Then connect the **MIDI Thru** jack of the first instrument to the **MIDI In** jack of the second instrument. Connect the **MIDI Thru** jack of the second instrument to the **MIDI In** jack of the third instrument. And so on, for as many devices as you will be using.

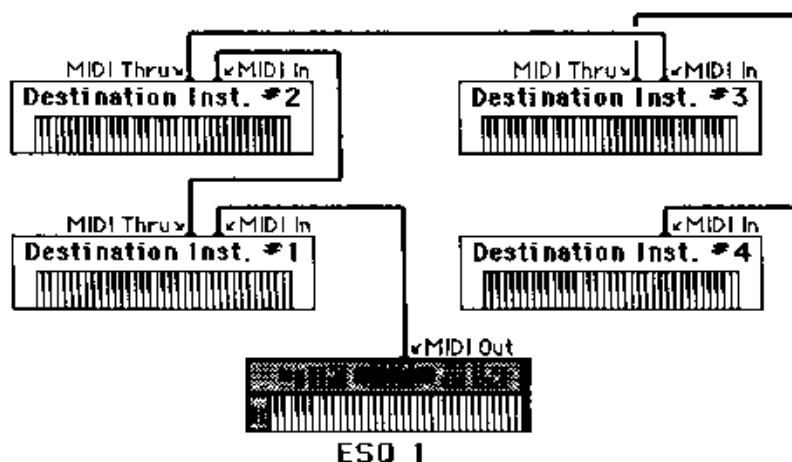

If one (or more) of the receiving devices has a single MIDI Jack which is switchable between **MIDI Out** and **MIDI Thru**, be sure to set that instrument for **MIDI Thru**. Or simply make it the last one in the chain.

With this arrangement, once you set up the proper MIDI Channels, etc. (see below), each device will receive and play only the data that is intended for it, and will "pass along" all other Data. Also, each can be played from its own keyboard (as well as from the **ESQ 1**'s) without affecting the others, because **MIDI Thru** jacks only pass along incoming MIDI data, and do not transmit what is played on the instrument. Of course, the above connections will work the same for a MIDI device which doesn't have a keyboard, such as a rack mount unit, a drum machine, etc.

This set up is ideal for controlling everything right from the **ESQ 1**. Simply by selecting the Track which is set to the same MIDI Channel as to a particular instrument, you can:

- 1) Play that instrument from the **ESQ 1** Keyboard;
- 2) Record a Track that will play back on that instrument when you Play the Sequence; and
- 3) Send the Destination device Program Changes and adjust its Volume (for those devices that receive MIDI Volume --not all do.)

In other words, once you have made the appropriate connections, and set up the MIDI Configuration of the Tracks and all Destination devices, you can use the **ESQ 1**'s Keyboard and its front panel to control and Record all the instruments in your rig.

Using a MIDI Thru Box

Coming out the **MIDI Thru** jack of some instruments, particularly those with a switchable **MIDI Out/Thru** jack, can cause a certain amount of delay in the MIDI signal, causing those devices further down the chain to lag behind. In most cases, the delay is negligible (a few milliseconds.) But it can vary from instrument to instrument, depending on the circuitry used, and could conceivably pose a problem. One solution is to figure out which device has the worst delay, and put that device last in the chain. The other alternative is to connect the **ESQ 1**'s MIDI Out to a **MIDI Thru Box**, or MIDI Splitter, which will feed all the receiving devices simultaneously. In this case you would make your MIDI connections as shown below:

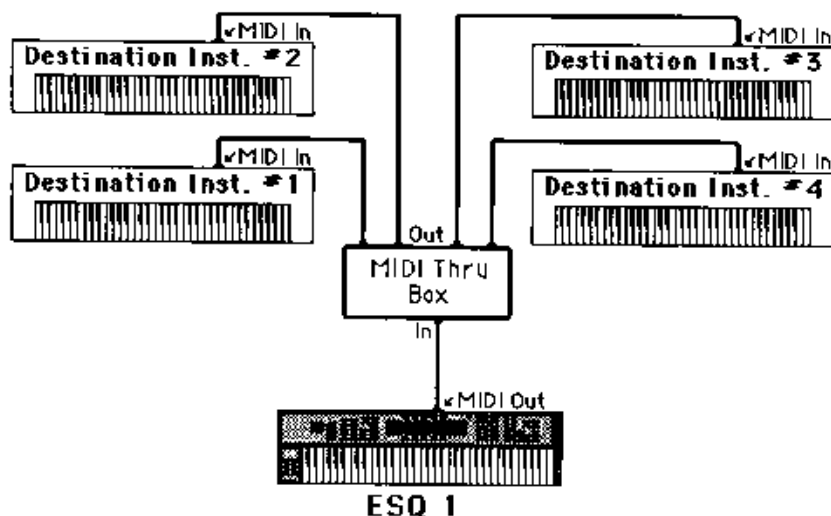

MIDI MODE AND CHANNEL -- Destination Instruments

The next step is to set up each Destination Instrument to receive only the MIDI information that is intended for it. When each of the receiving units is set to receive on a different MIDI Channel, you can control them all right from the **ESQ 1**.

For each Destination Instrument:

- > **Select a MIDI Channel.** The best idea is to assign each Destination Instrument its own MIDI Channel and always set it to that Channel. If you know, for instance, that a certain synth is always set to receive on MIDI Channel 4, you can quickly set up a Track to drive that synth by simply selecting an Unused Track, then assigning that Track **MIDI Status** and **MIDI Channel 4** on the **Mix/MIDI** Page.

When each Destination Instrument is always set to its own distinct MIDI Channel, it also means that different Sequences recorded at different times will always play the right instrument on the right Track.

- > **Set to OMNI OFF.** Each Destination synth must be in a mode where it receives only on its selected MIDI Channel. On some instruments this is referred to as **POLY Mode**; some call it **OMNI OFF**; some are always in this mode. Consult the owner's manual if there is any question about a particular instrument.
- * * * **Note:** Once you have assigned MIDI Channels to each instrument in your rig, **Write them down**, and keep the paper handy for quick reference. Or better yet, photocopy the **Track Sheet** at the back of this Manual and fill it out for each Sequence (or group of related Sequences) you record.

TRACK CONFIGURATION

After you have made the MIDI connections, and set up your Destination Instruments as described above, you now configure the Tracks of a Sequence to send to those instruments. Let's suppose that you are sequencing several external instruments, as depicted in the illustration on p. 135.

- > **Create a New Sequence.** Select the **CREATE/ERASE** Page and Create a new Sequence, as explained on p. 124.
- > **Select a Track.** Go to the **Tracks Select** Page. All the Track Locations will read **UNUSED**. Press one of the "Soft" Buttons corresponding to a Track Location to select and define a Track. The name of the current Program will appear there.
- > **Assign the Track MIDI Status.** Select the **Mix/MIDI** Page. Press ***MORE*** until the **TRACK STATUS** Sub-page appears. The selected Track is underlined. Use the **Data Entry Slider** or the **Up and Down Arrow** Buttons to set the Track to **MIDI Status**. You will notice that when you play the keyboard now, it doesn't sound on the **ESQ 1**.
- > **Assign the Track a MIDI Channel.** Press ***MORE*** until the **TRACK MIDI CHAN** Sub-page appears. Your Track is still selected (underlined). Use the **Data Entry Slider** or the **Up and Down Arrow** Buttons to set the Track to the MIDI Channel of the Instrument you want to sequence from that Track. Playing the **ESQ 1** keyboard should now play the Receiving Instrument.

- > **Set the Program Number.** Still on the **Mix/MIDI** Page, press ***MORE*** until the **TRACK PROG NUM** Sub-page appears. Now you can use the **Data Entry Slider** or the **Up and Down Arrow** Buttons to change the Program, or Patch, that the Receiving Unit is playing. While playing the **ESQ 1** Keyboard, adjust the Program Number until the External Instrument is playing the sound you want.

From now on, whenever you select that Sequence, or when it plays as a Step in a Song, this Track will send out a Program Change, to this Prog. Number, on its selected MIDI Channel.

- * * * * **Note:** You should always select the Program for external instruments from the **ESQ 1**, and not from the external instrument itself. This assures that the Track has the proper Program Number for that instrument in each Sequence.

Recording the First Track

Once everything is set up, you can proceed with Recording the first Track exactly as you would for an Track with **LOCAL** Status.

- > Select **CONTROL** Page, and make sure the **CLICK** is **ON**.
- > While holding down the **Record** Button, press **Play**. **REC** flashes on the Display.
- > Adjust the Tempo.
- > Start playing. The Bar in which you begin playing becomes Bar 1.
- > Press **Stop** or the **Sequencer Foot Switch** to halt recording. The Display will ask "**KEEP FIRST TRACK**".
- > Answer ***YES*** to keep the first Track (and define the length of the Sequence) or ***NO*** to scrap it, and try again from scratch.

Other Tracks

Tracks that are sent out MIDI are treated the same as Internal Tracks in terms of Recording, Rerecording, Punching In, Editing, etc. For each successive Track you Record, the procedure will follow the same lines:

- 1) Define the **Mix/MIDI** configuration of the Track,
- 2) Record the Track, and
- 3) Either **KEEP** or reject the new Track from the **PLAY/KEEP** Page.

To Record the next Track, select one of the **UNUSED** Tracks. This can be done from the **Mix/MIDI** Page as well as from the **Tracks Select** Page. Remember that when you select an **UNUSED** Track, it "takes on" all the settings of the Track that was previously selected (or of the Straight Synth, if no Track was selected).

- > Select an **UNUSED** Track.
- > Select the **Mix/MIDI** Page.
- > On the **TRACK STATUS** Sub-Page, set the Track to **MIDI** (it should be already).

- > On the **TRACK MIDI CHAN** Sub-Page, set the Track to send on the MIDI Channel of the the device you will be sequencing with this Track.
- > On the **TRACK PROG NUM** Sub-Page, adjust the Program, or Patch, of the Receiving Unit to the one you want.

Playing the **ESQ 1** Keyboard should now play the appropriate synth (or whatever) with the appropriate sound. You now Record a Track, with that instrument, just as you would an Internal Track, as described in **Recording Other Tracks**, p. 132.

- > Select **CONTROL** Page, and make sure the **CLICK** is **ON**, and **COUNTOFF=CLICK**.
- > While holding down the **Record** Button, press **Play**. After the one-Bar Countoff, Recording begins.
- > Start playing. At the end of the Sequence the **ESQ 1** will leave **Record** and enter **Audition Play**.
- > Press **Stop** or the **Sequencer Foot Switch** to halt recording. The Display will show the **PLAY/KEEP** Page.
- > Audition the New or the Original Track (which in this case is empty) before deciding which to keep.
- > Press **KEEP NEW TRACK** or **KEEP ORIGINAL TRACK**

You can Re-record the Track, Punch In or Punch Out, as described earlier, just as you would for Tracks that play Internally.

- * * * **Note:** Most often you will be recording Sequences which contain some MIDI Tracks and some LOCAL Tracks. When this is the case, be sure that you assign **LOCAL** Status (as opposed to **BOTH**) to the Tracks that you want to play only on the **ESQ 1**. This will avoid **1)** accidentally sending unintended MIDI Data to an external instrument, and **2)** sending out a lot of unnecessary information, which tends to slow things down.

Note also that when a Track is assigned **BOTH** Status, the Internal Program it will play and the Program on the external instrument must have the same Program Number. This may require rearranging some of the Program locations within the **ESQ 1** and/or your other instruments.

EDIT PAGE

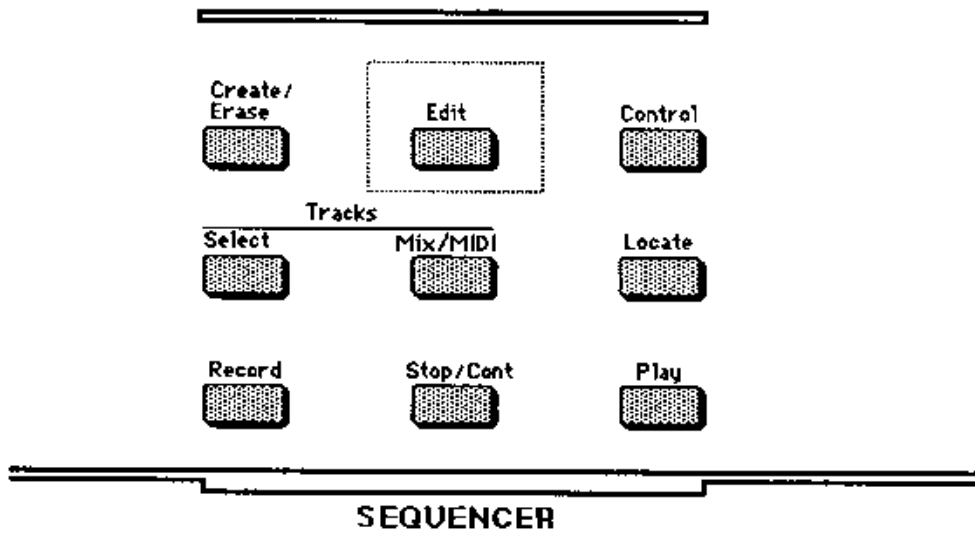

SECTION 7 -- Sequencer EDIT Functions

- 142** **EDIT PAGE --** Editing Tracks, Sequences, Songs and Single Events
- 143** **EDITING A TRACK**
- 144** **TRACK EDIT Functions**
 - 144 Transpose
 - 144 Remove Controllers
 - 145 Quantize
 - 147 Erase
 - 148 Merge
 - 149 Copy
- 150** **STEP -- TRACK STEP EDITING**
 - 150 STEP Edit Page
 - 153 Using the Step Edit Mode
- 155** **EDITING A SEQUENCE**
- 155** **SEQUENCE EDIT Functions**
 - 155 Append
 - 156 Change Length
 - 157 Copy
 - 158 Making a Sequence Template
- 159** **SONG MODE**
- 160** **SONG EDIT Page**
 - 162 Making a Song
- 164** **LOCATE -- Song LOCATE Page**

[EDIT] EDIT PAGE

For Editing Tracks, Sequences, Songs and Step Editing

The **EDIT** Page is actually many pages in one. Unlike most of the Programming Pages, which are self-contained, the **EDIT** Page is really just the starting point for all the **EDIT** functions. Though there are many different tasks that are performed from this Page, the Display always leads you logically to the one you want, with a series of Menus and Dialogue Pages.

You select the **EDIT** Page (by pressing the **EDIT** Button) to edit a **Song**, a **Sequence**, an individual **Track**, or to enter the **Step Edit Mode**. When you press the **EDIT** Button, the Page appears as shown below:



From the Menu on this Page you choose which you want to **EDIT** :

- 1) **SONG** -- The **ESQ 1's SONG** Mode allows you to chain any of the 30 Sequences together to create 10 different **Songs** of up to 99 Steps, with up to 99 Repetitions of each Step.
- 2) **SEQUENCE** -- There are three **EDIT** functions available when you choose **SEQ**:
 - > **APPEND** -- To Append one Sequence to the end of another (or to itself, to double the length of a basic track, for instance).
 - > **CHANGE LENGTH** -- To remove measures from the end of a Sequence, or add empty measures onto the end.
 - > **COPY** -- To Copy one entire Sequence to another Location.
- 3) **TRACK** -- Five **EDIT** functions are available for editing an individual **TRACK**:
 - > **TRANSPOSE** -- This function allows you to transpose a Track up or down in pitch by a full octave in either direction.
 - > **REMOVE CONTROLLERS** -- Removes any Controller data (such as Pitch Bend, MOD Wheel, Breath Controller, etc). and leaves only Key Events.
 - > **QUANTIZE** -- Quantization, or Auto-correct, takes the notes played and moves them to the nearest 1/4, 1/8th, 1/16th, or 1/32nd note, or 1/4, 1/8th, 1/16th or 32nd-note Triplet.

[EDIT] EDIT PAGE (cont'd)

- > **ERASE** -- Erases the track.
- > **MERGE** -- Takes all the Key and controller data from one Track and adds it in to another Track. This is good for conserving Tracks, and for achieving "Sound-on-Sound" which the **ESQ 1** Sequencer does not otherwise do -- you can record two Tracks separately with the same sound, then **MERGE** them together.

4) **STEP** -- Step Editing. This **EDIT** function allows you to make minute changes in Track Data, by recording, erasing, punching in or punching out while manually stepping through the Sequence one beat, or one clock pulse, at a time.

10) ***EXIT*** -- The **EXIT** Button gets you off the **EDIT** Page any time you change your mind, select the wrong function, or want to go back and make sure that the proper Track, Sequence or Song is Selected.

*** * * * Note: All EDIT functions affect only the currently selected Track, Sequence or Song. Before selecting any EDIT function you must make sure that the Track, Sequence or Song you want to Edit is selected. You cannot change the Track, Sequence or Song to be edited from the EDIT Page.**

EDITING A TRACK

When you select **TRACK** from the menu on the **EDIT** Page, the Display in turn gives you another menu, from which you select which **TRACK EDIT** function you want:

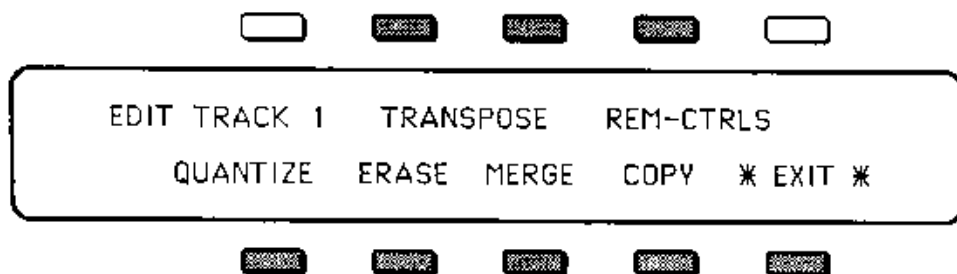

The upper-left segment of the Display tells you which Track you are editing -- remember you can't change Tracks from here. If you have the wrong Track, or you just aren't sure, press ***EXIT***, then go to the **TRACKS SELECT** Page and make sure that the right Track is selected.

TRACK EDIT FUNCTIONS:

2 or 3) TRANSPOSE

(Pressing either the #2 or #3 "Soft" Button will select Transpose.)

This function Transposes (raises or lowers the the pitch of) all the notes in a Track, by as much as one octave up or down.

To TRANSPOSE a Track:

- > Make sure the Track you want to Transpose is selected.
- > Select **EDIT** Page, and press **TRACK**.
- > Press **TRANSPOSE** -- the Display shows the following:

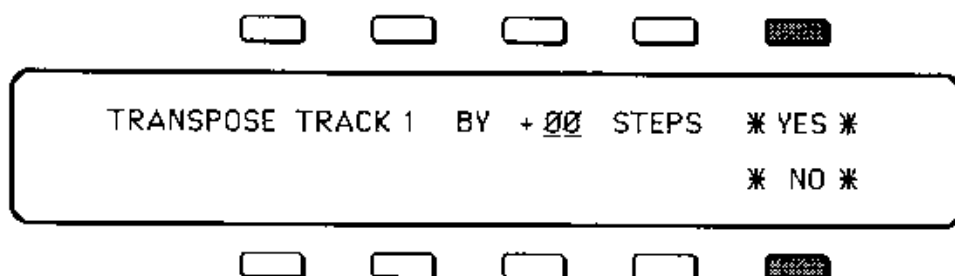

- > Use the **Data Entry Slider** and the **Up and Down Arrow** Buttons to adjust by how many semitone Steps the selected Track will Transposed., up or down in pitch.

One **Step** is a half-tone (up or down by one key); four Steps, a major third; seven Steps, a fifth, and so on. Range is from **-12** (Down one Octave) To **+12** (Up one Octave).

- > Press ***YES*** to Transpose the Track. You will then be returned to the **EDIT TRACK** Page. Or Press ***NO*** to cancel the procedure for any reason.

4) REM CTRLS -- Remove Controllers

This EDIT function will leave all Key Events intact, but remove any Controller Data (Pitch Bend, MOD Wheel, Breath Controller, Pressure -- in short, anything that isn't a Key Event) from the Track.

Because a Digital Sequencer records every event as a separate number stored in Memory, Controllers tend to eat up an enormous amount of Memory, compared to Key Events. A MOD Wheel used extensively, for example, spews out a constant stream of numbers, which are dutifully recorded by the Sequencer. Sometimes you might want to trade off some vibrato for some extra Memory. Sometimes you might just want to remove an obnoxious Pitch Bend or other Controller. In either case, this can be a handy function.

To REMOVE CONTROLLERS From a Track:

- > Make sure the Track you want to Remove Controllers from is selected.
- > Select **EDIT** Page, and press **TRACK**.
- > Press **REM CTRLS** -- the Display shows the following:

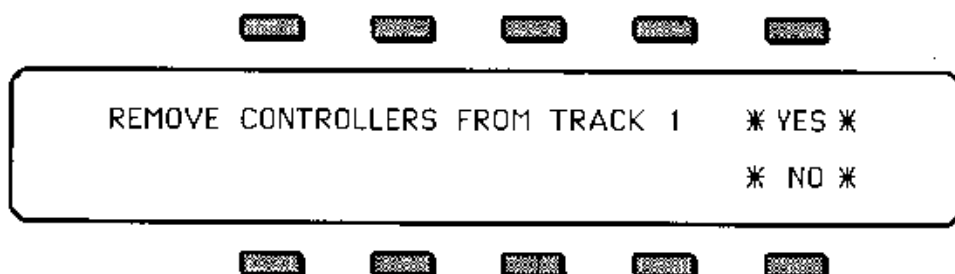

- > Press ***YES*** to Remove all Controller Data from the Track. You will then be returned to the **EDIT TRACK** Page. Or Press ***NO*** to cancel the procedure for any reason.

6) QUANTIZE -- Auto-Correct

The **Quantize** or Auto-Correct function can take a less than perfect Track and put it right on the beat. The **ESQ 1** uses post-quantization -- that is, you first record a Track, then apply the Auto-Correct later as an Editing option. This has two advantages over quantizing a Track on the way in.

First, you are less likely to accidentally Quantize a Track to sixteenth-note triplets, or some other value that's not what you had in mind. Second, by putting up the **PLAY/KEEP** Page after each Quantize procedure, the **ESQ 1** gives you the chance to hear the effect of a given quantization before deciding whether to keep it.

To QUANTIZE a Track:

- > Make sure the Track you want to Quantize is selected.
- > Select **EDIT** Page, and press **TRACK**.
- > Press **QUANTIZE** -- the Display shows the following:

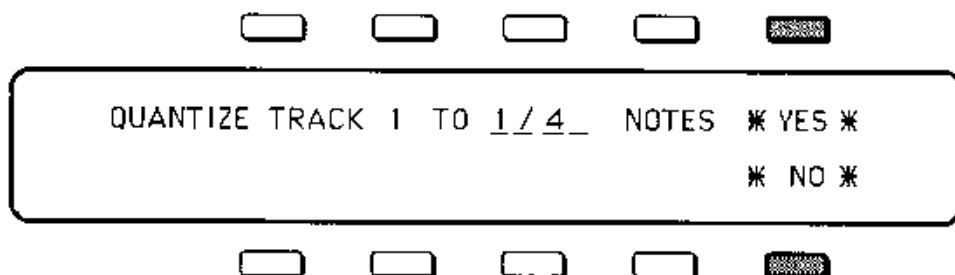

-----> Use the **Data Entry Slider** and the **Up and Down Arrow** Buttons to select the Quantization value you want. For whatever value is selected, the beginning of each note played is moved to the nearest note of that value. The length of a note is not changed -- each entire event will be moved so that its beginning (or Key Down) falls on the nearest Quarter note, Eighth note, Sixteenth note, etc.. **Quantization** values that can be selected here are:

- 1/4 -- **Quarter Notes**
- 1/4T -- **Quarter Note Triplets**
- 1/8 -- **Eighth Notes**
- 1/8T -- **Eighth Note Triplets**
- 1/16 -- **Sixteenth Notes**
- 1/16T -- **Sixteenth Note Triplets**
- 1/32 -- **Thirty-second Notes**
- 1/32T -- **Thirty-second Note Triplets**

-----> After selecting a Quantization value, press ***YES*** to Quantize the Track to that value. Press ***NO*** to return to the **EDIT TRACK** Page.

-----> Pressing ***YES*** Quantizes the Track to the desired value, then puts you on the **PLAY/KEEP** Page:

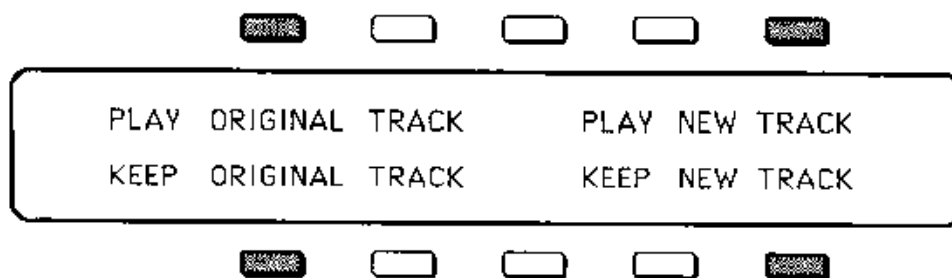

You can now audition the Quantized Track, to see if the effect was what you wanted. Play the new (Quantized) Track, or the Original (Unquantized) Track, pressing **Stop/Cont** to halt the Sequencer between plays. The **Auto-Locate** Controls on the **LOCATE** Page can be used before either PLAY command, to start from somewhere other than the beginning of the Sequence.

-----> Press **KEEP NEW TRACK** to accept the Quantized Track. This will replace the Original Track in the Sequence, and you will be returned to the **LOCATE** Page. Or,

-----> Press **KEEP ORIGINAL TRACK** to return to the **LOCATE** Page, with the Track unchanged (no Quantization). In this case you can repeat the procedure, trying other Quantization values, until you find the one that works for a particular Track.

*** * * * Note:** When you Quantize a Track, each note recorded on the Track will be moved to the nearest beat of the selected value -- it will be moved ahead or back in time, depending on which beat it is closer to. Sometimes, especially when using small Quantization values such as 1/16th or 1/32nd Notes, a given note might get Quantized to the beat just before or just after the one you wanted it on. In this case you might try a different value, and if that doesn't work, record the Track again

6) ERASE

This Erases the selected Track entirely -- puts it back into its original **UNUSED** state. This is a good thing to do after you have Merged a Track into another, or if you accidentally selected (and thus defined) an **UNUSED** Track, or if you just really don't like a Track, and want it to go away.

If you want to Erase only the Track Data but leave the Program and MIDI Configuration of the Track intact, you should simply Record over the Track, as described earlier, but without playing anything.

To ERASE a Track:

- > Make sure the Track you want to Erase is selected.
- > Select **EDIT** Page, and press **TRACK**.
- > Press **ERASE** -- the Display shows the following:

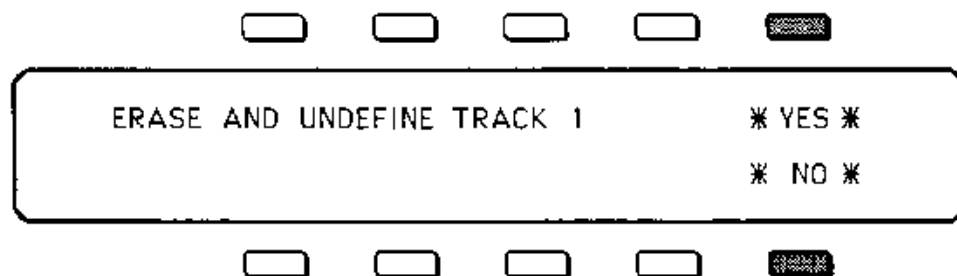

- > Press ***YES*** to Erase the Track. You will then be returned to the **EDIT TRACK** Page. Or Press ***NO*** to cancel the procedure for any reason.
- * * * * **Note:** After you Erase a Track and then exit the **EDIT** Page, the **ESQ 1** will be in the Straight Synth mode -- no Track selected. The Track you just Erased will read **UNUSED** on the **Tracks Select** Page.

7) MERGE

This EDIT Function takes all the Key and Controller Data from one Track and adds, or Merges it together with another Track. This allows you to record several different Tracks, all with the same Program and MIDI Configuration, and then Merge them into one. The effect is a kind of Sound-on-Sound -- the ability to add to Track Data rather than replacing it.

This also allows you to Quantize the two Tracks to different Quantization values before Merging them together. When sequencing a drum part, for instance, you could record the Kick and Snare on one Track, and Quantize that Track to 1/4 or 1/8th Notes. Then record the Toms on another Track, and Quantize that Track to 1/8th-note Triplets, or whatever. Then merge the two Tracks together.

After Merging Tracks together, you should Erase the Source Track, to avoid confusion, and to conserve your Tracks and your available Memory.

To MERGE a Track Into Another Track:

- > Make sure the Track you want to Merge Into another (the Source Track) is selected.
- > Select **EDIT** Page, and press **TRACK**.
- > Press **MERGE** -- the Display shows the following:

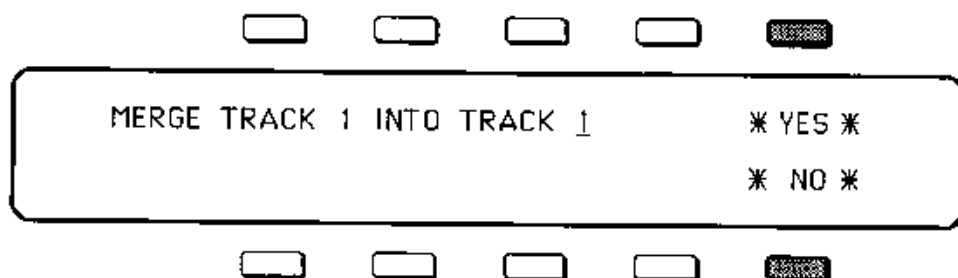

- > Use the **Data Entry Slider** and the **Up and Down Arrow** Buttons to choose which Track the selected Track will be Merged with (the Destination Track). When the procedure has been done, all the Key and Controller Data from both Tracks will be on this Track.
Note: The Program, Mix Level, MIDI Channel, Status, and Program Number of the Source Track are not copied in this procedure -- the settings of the Destination Track remain in effect for the new, Merged, Track.
- > Press ***YES*** to Merge the Source Track with the Destination Track. You will then be returned to the **EDIT TRACK** Page. Or Press ***NO*** to cancel the procedure for any reason.

5) COPY

This is one of the most useful Track EDIT functions. It simply makes a Copy of a Track onto another Track. You can, for instance, easily double a Track with another Sound, by Copying it to another Track Location, then assigning the new Track a new Program, MIDI Channel, etc. Or Copy a Track to another Track Location, then Transpose the new Track up an octave (see **Transpose**, below), for doubling an octave up. Along with the recorded Track Data, the Source Track's Internal Program, MIDI Channel, Status, Program Number and Mix Level will be copied to the Destination Track.

You can't Copy a Track onto a Track Location that has been recorded already. The Destination Track must be blank -- free from recorded Track Data.

To COPY a Track to Another Track:

- > Make sure the Track you want to make a Copy of (the Source Track) is selected.
- > Select **EDIT** Page, and press **TRACK**.
- > Press **COPY** -- the Display shows the following:

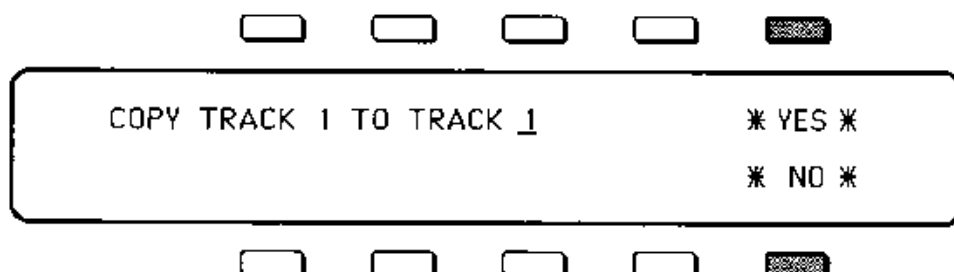

- > Use the **Data Entry Slider** and the **Up and Down Arrow** Buttons to choose which Track the selected Track will be Copied into (the Destination Track). This must be a Track that hasn't yet been recorded.
- > Press ***YES*** to Copy the Source Track onto the Destination Track. You will then be returned to the **EDIT TRACK** Page. Or Press ***NO*** to cancel the procedure for any reason.

STEP -- TRACK STEP EDITING

The **Step** Editing function of the **ESQ 1** is a way of getting into a Track to make minute changes. It is important to understand that the **STEP EDIT** Mode is an extension of **TRACK EDIT**, and of the Recording process itself. Whatever you do here affects **ONLY** the selected Track. Pressing **STEP** from the **EDIT** Page puts you on the **STEP EDIT** Page, which looks like this:

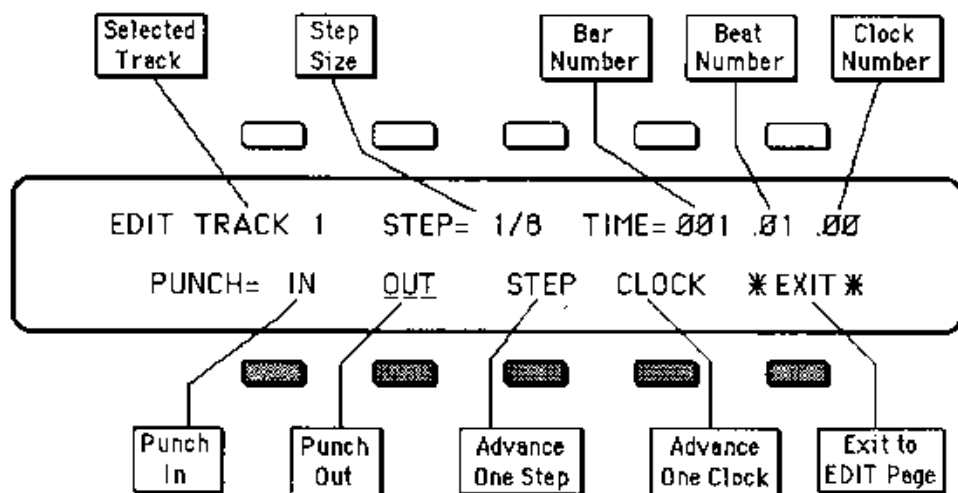

(Inactive Buttons appear in White)

Step Editing is really just a method of Recording or Playing back a Sequence in which you are the Clock. In normal Sequencer operation, The **ESQ 1**'s internal Clock controls the playback rate of a Sequence. The **STEP EDIT** Page is specially set up so that you can **Punch In** (enter **Record**) or **Punch Out** (leave **Record** and enter **Play**) while "Stepping through" the Sequence one **Step**, or one **Clock** pulse at a time.

On the **STEP EDIT** Page, shown above, the top row of the Display contains the **Step Size**, which you can adjust using the **Data Entry Slider** and the **Up and Down Arrow** Buttons, and a three-part **Time** Readout which tells you exactly where you are in the Sequence.

On the Bottom row of the Display are the Buttons for **Punching In** and **Punching Out** of **Record**, and two Buttons which allow you to advance the Sequence by one **Step**, or by one **Clock** pulse at a Time.

This Function allows you to **Punch In** at any point within the Sequence, and play the keyboard (to Record new Track Data) or not play (to simply erase Track Data) while advancing the Clock manually, by pressing **STEP** or **CLOCK**.

READOUTS AND ACTIVE CONTROLS:

STEP= -- STEP SIZE

This is the amount by which the Sequence will be advanced when the **STEP** Button is pressed (see #8 below). On this Page, **Step Size** is continuously controlled by the **Data Entry Faders** and the **Up and Down Arrow Buttons**, and does not have to be selected.

The available **Step** values are the same as the **Quantize** values on the **Quantize** EDIT function. The chart below shows the possible **Step Sizes**, along with how many **Clock** pulses each corresponds to.

1/4 --	Quarter Note -----	24 Clocks
1/4T --	Quarter Note Triplet -----	16 Clocks
1/8 --	Eighth Note -----	12 Clocks
1/8T --	Eighth Note Triplet -----	8 Clocks
1/16 --	Sixteenth Note -----	6 Clocks
1/16T --	Sixteenth Note Triplet -----	4 Clocks
1/32 --	Thirty-second Note -----	3 Clocks
1/32T --	Thirty-second Note Triplet -----	2 Clocks

When, for example, **Step Size=1/8**, each time you press the "Soft" Button below **STEP**, the Sequence will be advanced by one eighth note, or twelve "ticks" of the **ESQ 1's** Clock. When **Step Size=1/4**, each time you press **STEP**, the Sequence will be advanced by one quarter note, or twenty-four "ticks" of Clock. And so on.

TIME=

The readout in the Upper left corner tells you exactly where you are in the Sequence. The three numbers displayed after **TIME=** represent the **Bar**, the **Beat**, and the **Clock** number of your exact location within the Sequence.

- > **Bar Number** tells you which bar of the Sequence you are in.
- > **Beat Number** tells you which Beat of that Bar you are in. The value of a Beat is defined by the Time Signature of the Sequence. In **4/4** or **3/4** Time, for example, one Beat is a Quarter note. In **6/8** Time, one beat would be an Eighth note.
- > **Clock Number** tells you which Clock pulse, within that Beat, you are on. One **Clock** is a very small amount of time defined as **1/24** of a Quarter note. In normal Sequencer operation, when you change the Tempo of a Sequence, what you are really doing is varying the Clock Frequency. In the **Step Edit Mode**, the Clock is stopped, and this readout tells you exactly which Clock pulse within the Beat it is stopped at.

So if the Display reads: **TIME= 003 .02 .12**, that means that you are in **Bar Number 3** of the Sequence, **Beat Number 2** of that Bar, and **Clock Number 12** of that Beat.

If the Display reads: **TIME= 007 .01 .09**, that means that you are in **Bar Number 7** of the Sequence, **Beat Number 1** of that Bar, and **Clock Number 9** of that Beat.

The illustration below shows the relationship of Bars, Beat and Clocks, for a **Four Bar Sequence** in **4/4 Time**.

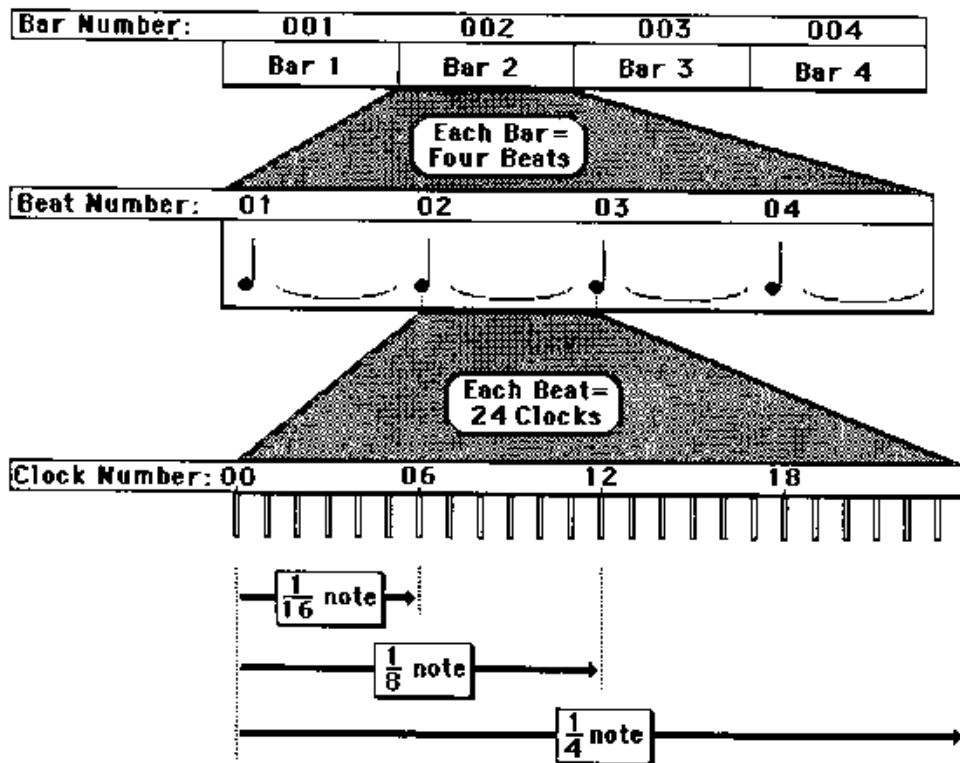

6. IN -- Punch In

Pressing this Button puts the **ESQ 1** into **Record**, causing the word **IN** to be underlined. Remember that all recording will be done on the selected Track. The right Track must be selected before you enter the **EDIT** Page.

Punching In will have no effect until you press either the **STEP** or **CLOCK** (see below) Button to advance the Sequencer. Anything you play (or don't play) will then be recorded as long as you continue to advance the Sequencer, pressing **STEP** or **CLOCK**, or until you press **OUT** to Punch Out. Either **IN** or **OUT** is always underlined.

7. OUT -- Punch Out

When **OUT** is underlined the **ESQ 1** is in **Play Mode**. In this state you can step through the Sequence by pressing the **STEP** or **CLOCK** Button to find the exact place where you want to Punch In.

8. **STEP -- Advance One Step**

Pressing **STEP** moves the Sequence ahead by one Step, as defined by the **Step Size**, above. If **STEP=1/16**, pressing **STEP** once will advance you exactly one Sixteenth Note, or 6 Clocks, beyond where you were. If **STEP=1/8**, pressing **STEP** once will advance you exactly one Eighth Note, or 12 Clocks, beyond where you were. And So on.

9. **CLOCK -- Advance One Clock**

Pressing **CLOCK** moves the Sequence ahead by one Clock PULSE. There are 24 Clocks per Quarter note, so this is a very slow way to step through a Sequence. Often it is a good idea to press the **STEP** Button to get into the area where you want to edit, then slowly press **CLOCK** to find the exact note.

10. **EXIT**

If you haven't Recorded anything, pressing **EXIT** simply returns you to the **EDIT** Page. If you have **Punched In**, while you were on this Page, pressing **EXIT** gets the **PLAY/KEEP** Page, where you can hear the fruits of your **Step Editing** labors before deciding whether to keep them, or to leave the Track as it was.

Using the Step Edit Mode

The basic procedure for **Step Editing** is as follows:

- > Make sure the Track you want to Edit is selected.
- > Select **EDIT** Page, and press **STEP**
- > The Page appears, as shown at the beginning of this Section, with the **TIME=** Readout showing the location where you were before entering the **EDIT** Page. The Page always comes up in the **Punch Out** state, so you don't have to worry about accidentally recording anything. A note might sound, and keep playing, when you press **STEP**. That means there is a Key Down on that beat. The note will remain until you advance the Sequencer (by pressing **STEP** or **CLOCK**) to the point where the Key Up for that note was recorded.
- > Advance the Sequencer by one Step or one Clock Pulse at a time (by pressing **STEP** or **CLOCK**) to get to the place where you want to Punch In. When you are close, start pressing **CLOCK**, one press at a time, until you reach the exact point where you want to record.
- > Press **IN** to **Punch In**.
- > Play the note on the Keyboard that you want to start on that beat. Now press **STEP** or **CLOCK** to advance to the point where you want to release the note. When you release the key, a Key Up will be recorded at exactly the time showing on the Display.
- > Press **OUT** to **Punch Out**. This puts you back in **Play**, where you can Step through to listen to more of the Sequence, or press **EXIT**. You cannot **Punch back In** once you have punched out. You can only do one edit per trip to this page.
- > Pressing **EXIT** puts you on the **PLAY/KEEP** Page. Audition the edited Track by pressing **PLAY NEW TRACK**. If the effect was not what you had in mind, press **KEEP ORIGINAL TRACK**. If it worked, press **KEEP NEW TRACK**.

It might take you a while to get good at **Step Editing**. But because each attempt is followed by the **PLAY KEEP** Page, you can afford to experiment without the risk of trashing a good Track. Here are a few more hints:

- > Any note that sounds the instant you press **CLOCK** was recorded exactly on that Clock Pulse (the one indentified on the Display). This is not necessarily true when you press **STEP**. If **STEP=1/4** notes, for example, when you press **STEP**, all the notes that were recorded between the new location and the location 24 Clocks back will sound. So the only way to really zero in on a single Event is to step through by single Clocks.

- > To Erase just one note:
 - 1) First get to a location a little before the note, pressing **STEP** or **CLOCK**, depending on how far into the Sequence it is.
 - 2) Then press **CLOCK** slowly, one press at a time, until the offending note sounds (Don't step past the note yet -- let it sustain.)
 - 3) Press **IN** to **Punch In**.
 - 4) Press **CLOCK** once. This records over the Key Down of the note.
 - 5) Now press **OUT** to **Punch Out**. The Note is gone. (Since you Erased the Key Down and then Punched out, the Key Up was erased automatically.)

- > If you want to perform a **STEP** Edit somewhere in the middle of a Sequence, use the **Auto-Locate** Controls to Locate to the Bar you want before going to the **EDIT** Page. The **STEP EDIT** Page will then appear showing the Location you selected. This is especially useful with long Sequences, since it is considerably faster than Stepping through sixteen Bars to get to the point where you want to begin editing.

EDITING A SEQUENCE

When you select **SEQUENCE** from the Menu on the **EDIT** Page, the Display shows another menu, from which you select which **SEQUENCE EDIT** function you want:



The upper portion of the Display tells you which Sequence is selected, how many Bars long that Sequence is, and its Time Signature. As with all **EDIT** Pages, the **EXIT** Button is there in the lower-right corner, so you can bail out at any time. Pressing **EXIT** will return you to the **EDIT** Page.

The **EDIT** functions here will affect the entire Sequence -- all eight Tracks (or however many Tracks have been Recorded.)

As with the **TRACK EDIT** Pages, you can't change the selected Sequence from here. You must make sure that the right Sequence is selected before entering the **EDIT** Page.

SEQUENCE EDIT FUNCTIONS:

6) **APPEND**

Use this function to take a Sequence and "tack it on" to the end of the selected Sequence. This allows you to record a Sequence in parts, as several different Sequences, and then use the **APPEND** function to put them together into one long Sequence.

Also, you can Append a Sequence to itself, doubling its length. Say you need a sixteen Bar repeating pattern. To save yourself aggravation, you can record a four Bar Sequence, then Append it to itself twice.

The Sequence to be Appended must have the same Time Signature as the selected Sequence. Also, the Programs and all Mix/MIDI configurations of the selected Sequence will still apply to the new Sequence, so it is best to use this function to Append Sequences that are set up the same as the selected Sequence.

To APPEND a Sequence to the Selected Sequence:

- > Select **EDIT** Page, and press **SEQ**.
- > Press **APPEND** -- the Display shows the following:

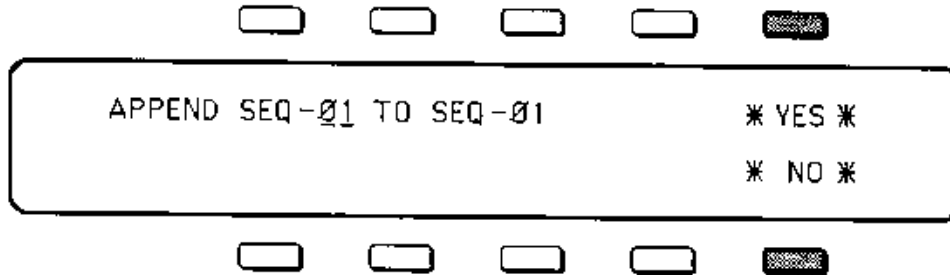

- > Use the **Data Entry Slider** and the **Up and Down Arrow** Buttons to choose which Sequence will be Appended to the end of the selected Sequence.
- > Press ***YES*** to Append the Source Sequence to the selected Sequence. You will then be returned to the **EDIT SEQUENCE** Page. Or Press ***NO*** to cancel the procedure for any reason.

7 or 8) CHANGE LENGTH

Though the length of the First Track determines the Length of the Sequence, you can, at any time, use the **CHANGE LENGTH EDIT** function to remove Bars from the end of the Sequence, or to add empty Bars at the end.

This is especially helpful when, for example, you record a first Track which is perfect in every way except that it runs to 5 Bars instead of four. With this EDIT function you can easily chop off the extra Bar.

To CHANGE THE LENGTH of the Selected Sequence:

- > Make sure the Sequence whose Length you want to Change is selected.
- > Select **EDIT** Page, and press **SEQ**.
- > Press **CHANGE LENGTH** -- the Display shows the following:

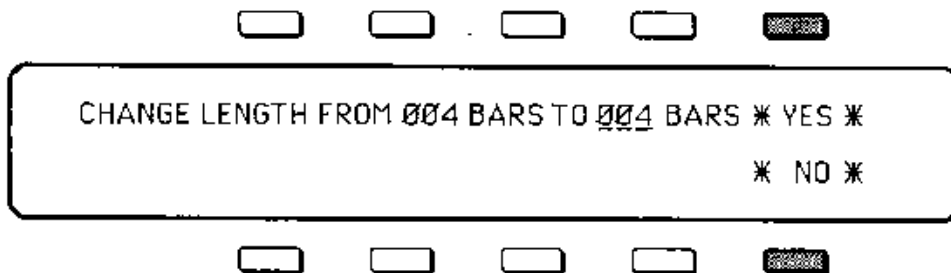

- > Use the **Data Entry Slider** and the **Up and Down Arrow** Buttons to determine the new Length of the selected Sequence. You can adjust this from 001 to 999 Bars (though there are practical limitations) If the new Length you select is shorter than the original, the Bars **will be removed** from the end of the Sequence. If the new Length you select is longer than the original, empty Bars (no Track Data) will be added at the end of the Sequence
- > Press ***YES*** to Change the Length of the selected Sequence. You will then be returned to the **EDIT SEQUENCE** Page, which will now reflect the new Length of the Sequence. Or Press ***NO*** to cancel the procedure for any reason.

9) COPY

This EDIT function copies the selected Sequence, with all of its Track, Program and MIDI information and Tempo, to another Sequence Location, leaving the Source Sequence intact.

The **COPY** function can save you time and trouble in many ways. If you have a good basic track, you can Copy the Sequence to another Location, and record different data on the remaining Tracks, for easy Song construction. Or, if you are planning to do some radical re-recording or Editing of a Sequence, Copy it to another Location, and edit the copy. That way your original Sequence is still there if your experiments aren't completely successful.

* You can't Copy a Sequence into a Location that already has one. The Destination Sequence Location must be blank.

To COPY a Sequence to Another Location:

- > Make sure the Sequence you want to make a Copy of (the Source Sequence) is selected.
- > Select **EDIT** Page, and press **SEQ.**
- > Press **COPY** -- the Display shows the following:

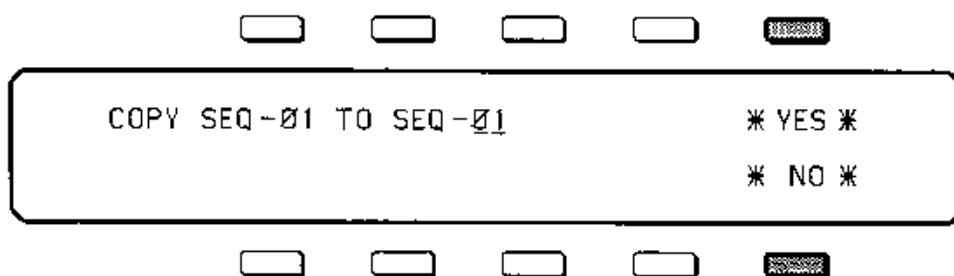

- > Use the **Data Entry Slider** and the **Up and Down Arrow** Buttons to choose which Sequence Location the selected Sequence will be Copied into. This must be a Location where a Sequence that hasn't yet been created. The **ESQ 1** will not let you Copy over an existing Sequence.

----> Press ***YES*** to Copy the Source Sequence into the Destination Sequence Location. You will then be returned to the **EDIT SEQUENCE** Page. Or Press ***NO*** to cancel the procedure for any reason.

Making a Sequence Template

One highly recommended application of the Copy function is the use of a Sequence **Template**. If you plan to record a number of Sequences with the same basic Track configuration, you can set up a "Template" Sequence with no recorded Track Data.

Create a new Sequence, and set up its various Tracks the way you want them to be for the group of Sequences you are about to record. For each Track, assign a Status, Program, MIDI Channel, etc. Set the Tempo of the Sequence to the Tempo you'll want. But don't Record anything on any of the Tracks.

Now Copy the Template to an empty Sequence Location, and start Recording on the copied Sequence. For each new Sequence, Copy the Template to another Location and Record there. This way you avoid having to set up the Tracks of each Sequence individually.

*** * * * Note:** As you will see in the next section, a Song is a series of Sequences which the **ESQ 1** has been programmed to play in a particular order. If, when a Sequence is selected, you press **SONG** on the **EDIT** Page, this may have the effect of changing which Sequence is the current Sequence -- from the Sequence that was selected, to the one that is the next Step in the Song. If you do this the Display will ask "**SELECT SEQUENCE IN NEXT SONG STEP?**" If you pressed **SONG** by accident, and wish to avoid confusion over what is really the current Sequence, answer ***NO***. You will be returned to the **EDIT** Page, with nothing changed. If you meant to edit a Song, answer ***YES***. But bear in mind that when you return to Sequence Mode, a different Sequence might be selected than when you left.

SONG MODE

The **ESQ 1's** **Song Mode** allows you to chain Sequences together in any order to create up to ten Songs.

Each Song can be given a name of up to six characters. You name a Song when you Create it (see **CREATE** Page, p. 125), much as you name a Program when Writing it to Memory.

Songs are constructed in **Steps**. Each Step of a Song consists of:

- 1) A Sequence that will be played during that Step;
- 2) The number of times the Sequence will be Repeated during the Step; and
- 3) The Transpose value, which allows you to Transpose the entire Sequence up or down by as much as an octave for the duration of the Step.

Either a Song or a Sequence is selected at any time -- never both. When a Song is selected, the **ESQ 1** is in **Song Mode**. Pressing **Play** will cause the selected Song to play. You cannot Record in Song Mode -- a Song is really just a series of instructions to the Sequencer, telling it to play certain Sequences in a certain order.

Each time a new Sequence starts playing as a Step in a Song, each Track of the new Sequence sends out a Program Number and MIDI Volume instructions on its selected Midi Channel (unless the Track is assigned LOCAL Status). This allows you to change the Patch that a remote instrument is playing for each Song Step, if you wish.

Any Sequence can be connected to any other in a Song -- they don't have to have the same Tempo or Time Signature. The **ESQ 1** will simply play the Sequences in the order you program them in.

When a Song is selected, you can make changes to a Sequence within the Song, but, unless the Song is stopped, those changes will be forgotten as soon as the next Step begins to play. For example, while playing a Song, you might change the Tempo of the Sequence that's currently playing, or change the Program that's playing on a Track. Those changes will only remain as long as that Step is playing. The next time the same Step comes around, the Sequence will be as it was originally.

If you make these changes while the Sequencer is stopped, or you Stop the Sequencer before the Song Step is over, the **ESQ 1** will ask you whether you want to save those changes when you next press **Play** or select a new Sequence or Song (see **SAVE CHANGES TO OLD SEQUENCE**, p. 100.)

*** * * * All changes made to a Sequence must be made with the Sequence selected, or when the Sequence is the Current Step in a Song and the Song is stopped.** If you find yourself trying to make changes to a Sequence, and the **ESQ 1** keeps changing them back, or otherwise reacting strangely, make sure you are not in Song Mode.

SONG EDIT PAGE

For Chaining Sequences together to make Songs.

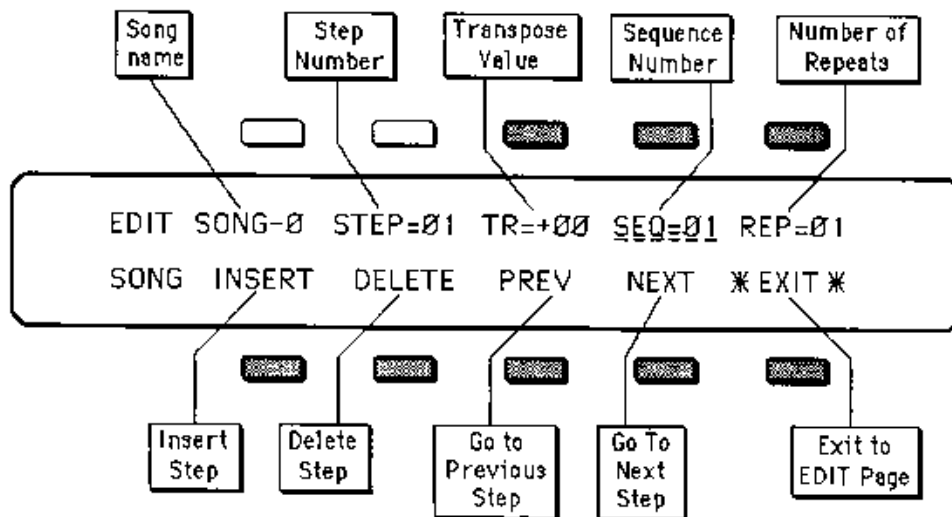

(Inactive Buttons appear in White)

The **SONG EDIT** Page appears when you 1) Create a new Song, or 2) select **SONG** from the menu on the **EDIT** Page.

READOUTS AND ACTIVE CONTROLS:

1. SONG NAME

The **Name** of the selected Song appears in this Location.

2. STEP

This tells you which **Step** of the Song you are on. Up to **99** Steps can be programmed into a Song. The Step Number which appears here is always the one you are currently Editing. You move from one step to another by pressing the **PREV** and **NEXT** Buttons (see below).

3. TR -- TRANSPOSE

This control will Transpose (raise or lower the pitch of) the selected Sequence for the duration of the Step. If **TR=** anything other than Zero for a given Step, when the Song reaches that Step every Track in the Sequence will be Transposed up or down by the selected amount. Each increment represents a semitone (halfstep). The range is from one Octave up (+12) to one Octave down (-12).

By using the same Sequence for several Steps, and transposing some of the Steps, you can save time and Sequence Memory. Remember, though that if you have Drums, or similar sounds, on a Track, they will be Transposed too.

4. SEQ

Here you select which Sequence you want to be played during the current Step. For each Step of the Song, press **SEQ** (it gets underlined) and use the **Data Entry Slider** and the **Up and Down Arrow Buttons** to select the Number of the Sequence you want for that Step. (While editing a Song, whenever you press **NEXT** or **PREV**, to change Steps, **SEQ** is automatically selected for the new Step.)

5. REP -- REPEATS

Here you select the number of times that the Sequence is to **Repeat** during the selected Step. If, for example, on a given Step, **SEQ=05**, and **REP=04**, that Step would repeat Sequence # 5 four times when the Song is played.

For each Step of the Song, after you select a Sequence, press **REP** (it gets underlined) and use the **Up and Down Arrow Buttons** to select the number of the Repeats for that Step. Up to **99** repetitions can be programmed for each Step.

6. INSERT

Pressing **INSERT** simply inserts a new Step into a Song. The Inserted Step always reads **SEQ=01**, **REP=01**. After inserting a Step you then adjust the **SEQ** and **REPs** as described above. The new Step is inserted in front of the one you were previously on, and all later Steps are moved back by one.

For example; if you are on **Step 3** of a Song, and you press **INSERT**, a new Step 3 (defined as **SEQ=01**, **REP=01**) will show on the Display. The old **Step 3** is now **Step 4**. The old **Step 4** is now **Step 5**. And so on.

7. DELETE

Pressing **DELETE** removes the currently selected Step from the Song.

For example; if you are on **Step 5** of a Song, and you press **DELETE**, the old **Step 5** will disappear and all later Steps will move up by one. The old **Step 6** is now **Step 5**. The old **Step 7** is now **Step 6**. And so on.

8. PREV

Pressing **PREV** "backs up" one Step within a Song.

9. NEXT

Pressing **NEXT** advances the Song forward to the next Step. You can't advance more than one Step beyond the last defined Step. If Steps **1** through **4** have been defined (by selecting a Sequence for those Steps), when you press **NEXT** to advance to Step **5**, it will read **SEQ=XX**, **REP=XX**. You cannot go to Step **6** until you have defined Step **5**. Moving the **Data Entry Slider** or the **Up and Down Arrow Buttons** replaces the **XX's** with numbers, and Step **5** is now defined.

MAKING A SONG

Lets suppose that you have recorded a number of Sequences, and that you now want to Create a Song that consists of the following:

- Step 1 -- Sequence 04 for 2 times through,
- Step 2 -- Sequence 05 for 1 time through,
- Step 3 -- Sequence 06 for 1 time through,
- Step 4 -- Sequence 08 for 2 times through,
- Step 5 -- Sequence 08, Transposed up a Fifth, for 2 times through,
- Step 6 -- Sequence 10 for 4 times through,

The Procedure is as follows:

1) Create a New Song

- > Select **CREATE/ERASE** Page, and press **NEW SONG**.
- > **Name** the new Song, as described on p.126.
- > Press ***YES***. You will automatically be placed on the **SONG EDIT** Page. (The **SONG EDIT** Page is also reached from the **EDIT** Page by pressing **SONG**.) The Page comes up as follows: **STEP=01**, **TR=+00**, **SEQ=01**, **REP=01**.

2) Edit Step 1

- > **SEQ** is already selected (underlined). Move the **Data Entry Slider** or the **Up and Down Arrow** Buttons until the Display reads **SEQ=04**.
- > Press **REP**. Adjust to **REP=02**.

3) Edit the Remaining Steps

Step 2:

- > Press **NEXT**. The Display reads: **STEP=02**, **TR=+00**, **SEQ=XX**, **REP=XX**. **SEQ** is already selected.
- > Move the **Data Entry Slider** or the **Up and Down Arrow** Buttons until **SEQ=05**.
- > Press **REP**. Adjust to **REP=01**.

Step 3:

- > Press **NEXT**. The Display reads: **STEP=03**, **TR=+00**, **SEQ=XX**, **REP=XX**.
- > Move the **Data Entry Slider** or the **Up and Down Arrow** Buttons until **SEQ=06**.
- > Press **REP**. Adjust to **REP=01**.

Step 4:

- > Press **NEXT**. The Display reads: **STEP=04**, **TR=+00**, **SEQ=XX**, **REP=XX**.
- > Move the **Data Entry Slider** or the **Up and Down Arrow** Buttons until **SEQ=08**.
- > Press **REP**. Adjust to **REP=02**.

Step 5:

- > Press **NEXT**. The Display reads: **STEP=05**, **TR=+00**, **SEQ=XX**, **REP=XX**.
- > Move the **Data Entry Slider** or the **Up and Down Arrow Buttons** until **SEQ=08**.
- > Press **REP**. Adjust to **REP=02**.
- > Press **TR=**. Adjust to **TR=+07**. This will Transpose **Sequence 06** up a Fifth (seven semitones) during this Step.

Step 6:

- > Press **NEXT**. The Display reads: **STEP=06**, **TR=+00**, **SEQ=XX**, **REP=XX**.
- > Move the **Data Entry Slider** or the **Up and Down Arrow Buttons** until **SEQ=10**.
- > Press **REP**. Adjust to **REP=04**.

4) Check your Song

- > Press **PREV** to back up, one Step at a time, until you reach **Step 1**. Now use the **NEXT** and **PREV** Buttons to move around the various Steps and check to see that they are right. If one of the values is wrong, or if you just decide you want something different, simply select it, and change it.

5) Press *EXIT* to exit to the EDIT Page.

* * * * **Note:** Remember that a Song is just a series of pointers telling the ESQ 1 which Sequences to play, and in which order. A Song contains no Track Data. It doesn't have to be saved -- it just stays like it is until you change it, or Erase it. You can't do any harm to a Sequence or any of its Tracks by anything you do in Song Edit Mode. When playing back a Song, any changes you make to a Sequence will only be saved if you instruct the ESQ 1 to save them, as described earlier.

[LOCATE] SONG LOCATE PAGE

Provides information about location within a Song; Allows access to any Step within a Song; Shows Tempo and Time Signature.

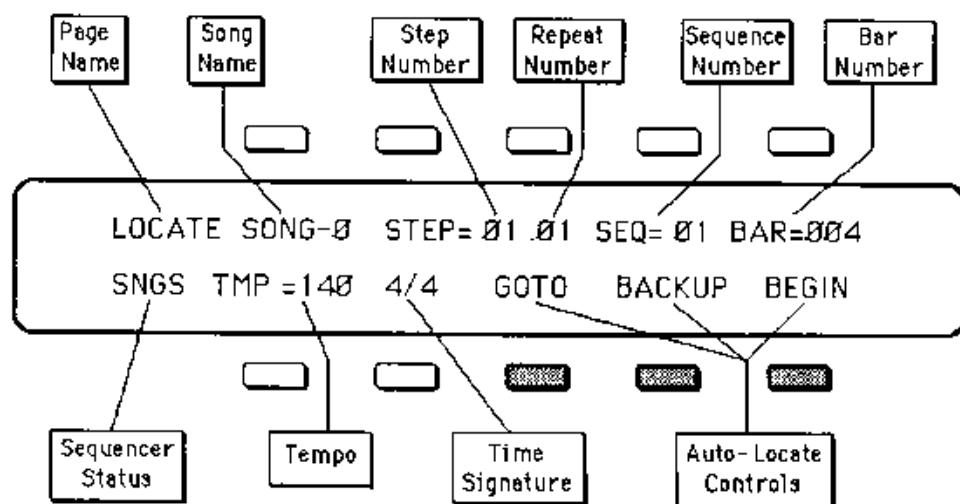

(Inactive Buttons appear in White)

When a **Song** is selected, the **LOCATE** Page looks a little different than in Sequence Mode. In Song Mode the Page is reconfigured to show you where you are within a Song. The **Auto-Locate** Controls now locate to Song Steps rather than Bars.

The **Status** of the Sequencer, whether it is in **Song Play (SNGP)** or **Song Stop (SNGS)** is always shown in the lower left-hand corner of the Display on this Page.

The **TEMPO** Control is still active, but any changes you make to a Sequence during a Step of a Song will be immediately forgotten as soon as the next Step comes around, unless you Stop the Song during the Sequence you changed.

READOUTS AND ACTIVE CONTROLS:

1. SONG NAME

The name of the current song is displayed here.

2. STEP=

This Segment of the Display shows the **Step** that the Song is on, and which **Repeat** of that Step it is on. For example, if **STEP= 02 .03**, it is on the third repeat of Step 2.

4. **SEQ=**
Tells you which Sequence is currently playing; or, if the Sequencer is in **Song Stop Mode**, which Sequence will play from if you press **Stop/Cont.**
5. **BAR=**
Tells you which Bar of the Sequence is playing; or, if the Sequencer is in **Song Stop Mode**, which Bar it will play from if you press **Stop/Cont.**
6. **TMP=**
The **Tempo** of the Sequence that is currently playing is displayed here.
7. **TIME SIGNATURE**
The **Time Signature** of the currently playing Sequence is displayed here. Sequences with different Time Signatures can be put together into Songs.

AUTO-LOCATE CONTROLS:

8. **GOTO**
GOTO allows you to start Playing the Song from any Step within the Song. To reach a particular Step:

----> Press **GOTO**. The Display shows:

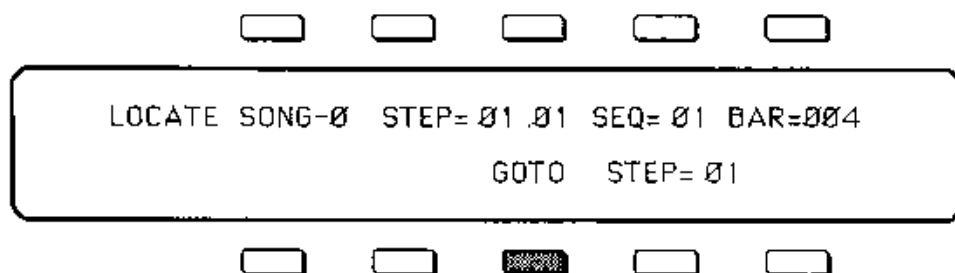

- > Use **Data Entry Slider** and the **Up and Down Arrow** Buttons to adjust the **GOTO** Step number to the Step at which you want to start. You can choose any Step within the current Song.
- > Press **GOTO** again. You are returned to the **SONG LOCATE** Page, with the new Step number showing on the Display.

9. **BACKUP**
Each press of this button backs the Song Location up One Step .
10. **BEGIN**
Pressing this button resets the Song to the beginning of Step 1.

SECTION 8 -- Sequencer Applications

- 168 Using the ESQ 1 with a Drum Machine**
- 168 To Sync a Drum Machine to the ESQ 1
- 168 To Sync the ESQ 1 to a Drum Machine
- 168 To Sequence a Drum Machine from a Track of the ESQ 1

- 169 Song Position Pointers**

- 169 MIDI Song Selects**

- 170 Tape Sync**
- 170 Recording a Sync Track
- 170 Syncing the ESQ 1 to a Recorded Sync Track

- 171 The ESQ 1 as a System Controller**

USING THE ESQ 1 WITH A DRUM MACHINE

When you use the **ESQ 1** in conjunction with a Drum machine or other rhythm Sequencer, there are basically three ways you can go:

- 1) Sync the Drum Machine's clock to the **ESQ 1**;
- 2) Sync the **ESQ 1**'s clock to the Drum Machine; or
- 3) Sequence the Drum Machine from the **ESQ 1**, just as you would a Synthesizer.

To Sync a Drum Machine to the ESQ 1

- > **Connect the MIDI Out of the ESQ 1 to the MIDI In of the Drum Machine.** If you have other instruments connected to the **ESQ 1** via MIDI, you can simply include the Drum Machine in the MIDI Thru chain depicted on p. 135. (If the Drum Machine has no MIDI Thru jack, put it last in the Chain.)
- > **Set the Drum Machine to MIDI Sync.**
- > **Set the Drum Machine to receive on an unused MIDI Channel, OMNI Off; or disable Channel information.** You don't want the Drum Machine playing **ESQ 1** Sequence Data intended for other instruments. MIDI Clocks, Start, Stop and Continue are **Real Time** commands, and are sent and received regardless of MIDI Channel or Mode.
- > The Drum Machine should now Sync to the **ESQ 1**'s clock. Pressing **Play** or **Stop/Cont** will Start, Stop and Continue the Drum Machine, assuming it receives those commands (most do.)

To Sync the ESQ 1 to a Drum Machine

- > **Connect the MIDI Out of the Drum Machine to the MIDI In of the ESQ 1.**
- > **Set the ESQ 1 to MIDI Sync.** On the **CONTROL** Page, select **SYNC= MIDI CLOCK**.
- > **Set the Drum Machine to send on a MIDI Channel that is not being used by the ESQ 1 (Straight Synth or any Track.)** Again, MIDI Clocks, Start, Stop and Continue are **Real Time** commands, and are sent and received regardless of MIDI Channel or Mode.
- > The **ESQ 1** should now Sync to the Drum Machine's clock. Starting, Stopping or Continuing the Drum Machine will Start, Stop and Continue the **ESQ 1**.

To Sequence a Drum Machine from a Track of the ESQ 1

- > **Connect the MIDI Out of the ESQ 1 to the MIDI In of the Drum Machine.**
- > **Set the Drum Machine to Tape Sync or External Clock,** or any setting other than Internal or MIDI Clock. This way it will not play it's own patterns, but will act only as a sound-producing device, sequenced from a Track of the **ESQ 1**.

- > Set the Drum Machine to **OMNI Off**, and select a **MIDI Channel**.
- > From the **Mix/MIDI Page**, assign a **Track** on the **ESQ 1 MIDI Status**, and set it to the same **MIDI Channel** you assigned the **Drum Machine**.
- > You should now be able to play the **Drum Machine** from the **ESQ 1's** Keyboard. You can then record a **Track** on the **ESQ 1**, from the **ESQ 1's** Keyboard, which will play on the **Drum Machine** -- just as if you were sequencing an external synthesizer. The advantage of this approach is that some **Drum Machines** respond to **Velocity** when played from **MIDI**, but not when played from their own front panels. Thus you may get more dynamic range out of your **Drum Machine** if you use this approach. The disadvantage is that you use up **ESQ 1 Sequencer Memory** to sequence the **Drum Machine**.

SONG POSITION POINTERS

The **ESQ 1** sends and receives **Song Position Pointers** via **MIDI**. **Song Position Pointers** are **MIDI** commands that tell a **Sequencer** or **Drum Machine** where to **Locate** within a **Song** or **Sequence**.

The **ESQ 1** receives **Song Position Pointers** over **MIDI** only when **SYNC= MIDI CLOCK** on the **CONTROL** Page. When it receives a **Song Position Pointer**, it will **Locate** to the appropriate place in the selected **Song** or **Sequence**.

The **ESQ 1** sends a **Song Position Pointer** over **MIDI** whenever you use the **Auto-Locate** Controls. Any receiving unit which recognizes **Song Position Pointers** will **Locate** to the same spot. (Not all devices recognize **Song Position Pointers**. Consult the **Manual** of any other sequencing device you are using, to see if it does.)

MIDI SONG SELECTS

MIDI Song Selects allow a sequencer such as the **ESQ 1** to instruct a remote sequencer or drum machine to select a new song whenever you select a **Sequence** or **Song** on the **ESQ 1**. The **ESQ 1** will always send **Song Selects**. Whether or not it receives them depends on the setting of the **MIDI ENABLES** on the **MIDI** Page (p.24)

The **ESQ-1** transmits and receives **MIDI Song Selects** in **Sequence Mode** as well as **Song Mode**. (depending again on the setting on the **ENABLE** control). This allows you to select **ESQ-1 Sequences** as well as **Songs** from a remote sequencer, computer or drum machine, and vice versa. They are set up as follows:

MIDI Song selects # 00-09 will select **ESQ-1 Songs # 1-10**.

MIDI Song selects # 20-49 will select **ESQ-1 Sequences # 1-30**.

Conversly, selecting **Songs # 1-10** will cause the **ESQ 1** to send **MIDI Song selects # 00-09**. Selecting **Sequences # 1-30** will cause the **ESQ 1** to send out **MIDI Song selects # 20-49**.

TAPE SYNC

Whenever the **ESQ 1** is running off its internal clock (**SYNC=INTERNAL**), and the Sequencer is running, it sends a Clock Signal to the **Tape Out** jack on the Rear Panel. By recording this signal on one Track of a multi-track tape recorder, you can then sync the **ESQ 1** to the recorded Clock Signal on the tape. This enables you to combine sequenced and recorded Data, to increase the capabilities of a small (or large) multitrack set-up.

Recording a Sync Track

- > **Connect the Tape Out Jack of the ESQ 1 to the input of one Track of your Tape Recorder.** Generally, it's best to use an outside Track -- Track 1 or 4 on a 4-Track deck, Track 1 or 8 on a 8-Track deck, etc. Also, if possible, you should not have any noise reduction on the Channel of the deck where you record a sync Track.
- > **Adjust the Record Level.** Press **Play** on the **ESQ 1** (make sure **SYNC=INTERNAL**) to start the Song or Sequence playing. Adjust the level to around **-10 to -6 dB**. You may have to experiment to find the level that works best for you.
- > **Start the Tape Deck recording.**
- > **Press Play on the ESQ 1 to play the Song or Sequence.** Let the Song or Sequence run its full length. Remember, what you are recording is a Clock Signal that will cause the **ESQ 1** to play at a certain Tempo when you later sync it to the recorded track.
- > **At the end the Song or Sequence, stop the Tape deck, and press Stop to stop the Sequencer.**

Syncing the ESQ 1 to a Recorded Sync Track

- > **Connect the Tape In Jack of the ESQ 1 to the output of the Track of your Tape Recorder which contains the Sync Track.**
- > **Rewind the Tape Deck to the beginning of the recorded Sync Track.**
- > **Set the ESQ 1 to Tape Sync (**SYNC= TAPE SYNC** on the **CONTROL** Page.)**
- > **Press Play on the ESQ 1.** It will now wait for the recorded Clock Signal before starting to play the Song or Sequence.
- > **Start the Tape deck.** When the Sync Track begins, the **ESQ 1** will begin to play.

* * * **Note:** The Sync Track you record to tape sends only Clock, or Tempo, information to the **ESQ 1** -- it doesn't communicate where you are in a Song or Sequence. If you rewind the tape to a different place and start it playing again, the **ESQ 1** will start from wherever it last stopped -- things will definitely get out of sync. To keep everything playing together, you must start the Tape from the beginning each time. Always press **Play** on the **ESQ 1** first, to start it from the beginning of the Song or Sequence.

THE ESQ 1 AS A SYSTEM CONTROLLER

One of the by-products of the **ESQ 1** Sequencer is the fact that it makes a versatile MIDI controller, allowing you, among other things, to change Programs on every instrument in your rig with the push of a button. Each Sequence you create and store in the **ESQ 1**'s Sequencer Memory contains up to eight sets of Program and Volume information, each of which will be sent out on the designated MIDI Channel when you select that Sequence.

If you have the **ESQ 1** connected to other instruments via MIDI, try this:

- > Create a new Sequence.
- > Select the **Tracks Select** Page, and select an UNUSED Track.
- > Go to the **Mix/MIDI** Page, and set up the Track to send to one of your external instruments, as described in **MIDI SEQUENCING**, on p. 137.
- > Select another UNUSED Track, and do the same, setting this Track up to drive another instrument. And so on, until you have one Track playing each external instrument. Create a couple of **LOCAL** Tracks with different Programs too. Selecting them will let you play the **ESQ 1** only. Selecting any of the **MIDI** Tracks will let you play only the receiving instrument.

You see that from the **Tracks Select** Page, you can change what plays from the **ESQ 1** keyboard simply by selecting different Tracks. Remember too that a Track with **BOTH** Status will play on the **ESQ 1** and an external instrument.

Now Create another Sequence. (The **ESQ 1** will ask you "SAVE CHANGES TO OLD SEQUENCE?" Answer Yes.) For the Tracks of the new Sequence, go through the same procedure as before, but assigning different Program Numbers to the external instruments. (Remember always to change Programs from the **ESQ 1**'s **Mix/MIDI** Page.)

Again, you can play a different external instrument, or the **ESQ 1**, or the **ESQ 1** and an external Instrument, depending on which Track is selected. If you press a selected Track's button again, so there's no Track selected, you hear the "Straight Synth" Program and transmit on the Base MIDI Channel, giving you a ninth possibility.

Now go to the right **Sequence Select** Page and reselect the first Sequence. (Again, the **ESQ 1** will ask you "SAVE CHANGES TO OLD SEQUENCE?" Answer Yes.) Notice when you select the New Sequence that all the external instruments connected to the **ESQ 1** change to the proper Program for that Sequence -- each Track sent out a Program Change on its MIDI Channel when the Sequence was selected. Now select the second Sequence again. Each external instrument again changes back to the proper Program.

Notice that you haven't recorded anything on either of these Sequences. They exist merely as Templates, which serve two useful purposes when using the **ESQ 1** as a System Controller:

- 1) Every time you select a new Sequence, each Track can send a Program Change to an external instrument. You can change the sound that every synth in your rig is playing with one press of a button.
- 2) When you select any Track of a Sequence, the **ESQ 1** Keyboard plays whatever Program is on that Track, or sends on the Track's MIDI Channel, or both. Select a different Track and you have a different configuration. From the **Tracks Select** Page you select up to nine different internal Programs and/or MIDI channels to send on (counting the Straight Synth.)

Of course you can record data on any of these Sequences if you want. Whether you do or not, they will work as Templates. You can play external instruments from the **ESQ 1** or from their own Keyboards. You can have a Track send a Program Change to a MIDI Digital Delay or Reverb unit; or have it send Load instructions to a **Mirage** while you play the Straight Synth Program on the **ESQ 1**, just by selecting a new Sequence. No doubt you will come up with some applications of your own, based on your equipment and your needs.

SECTION 9 -- Storage of Sequencer Data

174	STORAGE Page
174	Tape Storage of Sequencer Data
174	Tape Connections
175	Saving all Sequencer Memory to Tape
176	Saving One Sequence to Tape
176	Verifying Sequencer Data Saved to Tape
178	Loading All Sequencer Memory from Tape
179	Loading One Sequence from Tape
180	MIDI Transfer of Sequencer Data
180	MIDI Connections
180	Sending All Sequencer Memory via MIDI to a Mirage
181	Loading Sequencer Data via MIDI from a Mirage
182	Sending All Sequencer Memory via MIDI to another ESQ 1
183	Sending One Sequence via MIDI to another ESQ 1

[STORAGE] STORAGE PAGE

For Saving and Loading Programs and Sequencer Data to Cartridge, to Audio Tape, or Over MIDI.

The **STORAGE** Page is used to send and load Program and Sequence Data to various media for saving and storage. Transferring Program Data is covered in the **Synthesizer** half of this Manual. Here we are concerned with transferring Sequencer Data.

The **STORAGE** Page handles two basic types of Sequencer Data transfer:

- 1) **TAPE** -- The entire Sequencer Memory (all Sequences and Songs), or a single Sequence, can be saved to Audio Tape; the entire Sequencer Memory or a single Sequence can be Loaded from Tape.
- 2) **MIDI** -- The entire Sequencer Memory or a single Sequence can be sent via MIDI to another **ESQ 1**. The entire Sequencer Memory can be sent to, or Loaded from a **Mirage** Digital Sampling Keyboard or **Mirage** Digital Multisampler.

When you press **STORAGE**, the Page appears like this:

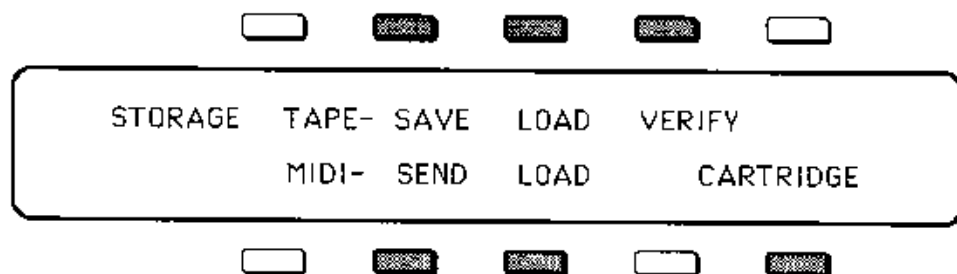

From here you choose which type of Data Transfer you want.

TAPE STORAGE

The entire Sequencer Memory, or just one Sequence, can be saved to audio Tape, and later loaded back into the **ESQ 1**'s Sequencer Memory from Tape.

As mentioned earlier, because of its high Data transfer rate, the **ESQ 1** will work best with a good Tape deck, as opposed to an extremely cheap portable model. See p. 80 of the Synthesizer Section for more details.

Tape Connections

To Save Sequencer Data to Tape, connect the **Tape Out** Jack on the Rear Panel of the **ESQ 1** to the **Input** of your tape recorder. To Load, or Verify Data that has been Saved, connect the **Output** of the tape recorder to the **Tape In** jack of the **ESQ 1**.

SAVING All Sequencer Memory to Audio Tape

This procedure will Save the entire Sequencer Memory (all Sequences and Songs including all Track Data, etc.) to Tape. It is a good idea to keep track of what Programs were where in Memory, what Cartridge was inserted, and what external devices were used when the Sequences were recorded. The Track Sheet at the back of this Manual will help to keep all this straight. Feel free to photocopy this sheet, and fill one out for each Sequence, or group of similar Sequences, you save.

One good idea is to move all the Programs used in your Sequence(s) into the Internal Banks and save the Internal Program Data on the Tape right after the Sequence Data. That way you can load them both in together (one at a time, of course) when you want them.

*** * * * Note:** Before saving Data to Tape, it is a good idea to go through the procedure once without Starting the Tape Deck, just to get your Record levels properly adjusted.

- > Connect the **ESQ 1's Tape Out** Jack to the **Input** of one channel of your tape recorder (or to both channels, as described earlier).
- > Put your Tape Deck in **Record/Pause**.
- > Select the **STORAGE** Page.
- > Press **TAPE SAVE**. The Display shows the following:



- > Start the Tape Deck Recording.
- > Press **ALL SEQ**. This starts the DataTransfer. The Display will read ***SAVING DATA TO TAPE***.

The **ESQ 1** will put out an eight second "Leader" tone, followed by the Sequence Data, which can take up to two minutes, depending on how much Data is in Memory. During the Leader tone, adjust the Recorder's Input level so that the VU meter(s) read between **-3** and **0** dB.

- > When the Data has been transferred, the Display reads ***TAPE PROCEDURE COMPLETE***, and the **STORAGE** Page returns.
- > Stop the Tape Deck, and Verify the Transfer, as described below.

As mentioned earlier, recording a spoken "Slate" on the tape, immediately before each block of Data you save, will help you locate it later.

SAVING One Sequence to Audio Tape

This procedure will Save the selected Sequence to Tape. If you want to combine Sequences that were recorded at different times, and stored in different places, into the same Sequencer Memory, this is a handy function.

- > Make sure the Sequence you want to save is selected.
- > Connect the **ESQ 1's Tape Out Jack** to the **Input** of your tape recorder.
- > Put your Tape Deck in **Record/Pause**.
- > Select the **STORAGE** Page.
- > Press **TAPE SAVE**. The Display shows the following:

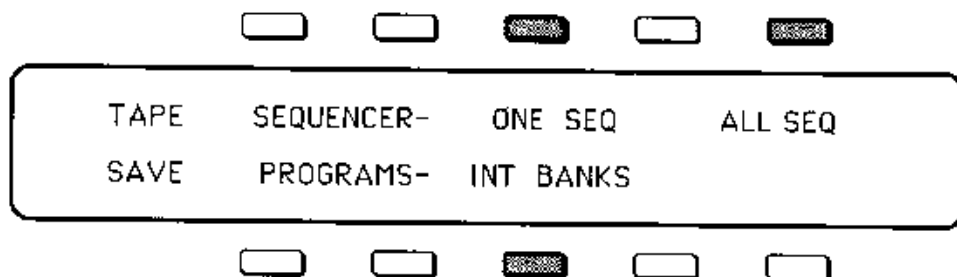

- > Start the Tape Deck Recording.
- > Press **ONE SEQ**. This starts the Data transfer. The Display will read ***SAVING DATA TO TAPE***. The **ESQ 1** will put out an eight second "Leader" tone, followed by the Sequence Data. During the Leader tone, adjust the Recorder's Input level so that the VU meter(s) read between **-3** and **0** dB.
- > When the Data has been transferred, the Display reads ***TAPE PROCEDURE COMPLETE***, and the **STORAGE** Page returns.
- > Stop the Tape Deck, and Verify the Transfer, as described below.

VERIFYING Sequencer Data Saved to Audio Tape

After you have saved Data to Tape, you should **Verify** the Data on the tape, to make sure that the transfer was successful. This will save you from finding out later, when you try to Load the data back into the **ESQ 1**, that a dropout or other problem has garbled your data (very annoying).

To VERIFY Sequencer Data Saved to Audio Tape

- > Connect the **Output** of the channel of your tape recorder that contains the Program Data to the **ESQ 1's Tape In Jack**.
- > Select the **STORAGE** Page.
- > Rewind the Tape Deck to the beginning of the Data to be Verified.

-----> Press **TAPE VERIFY**. The Display shows the following:

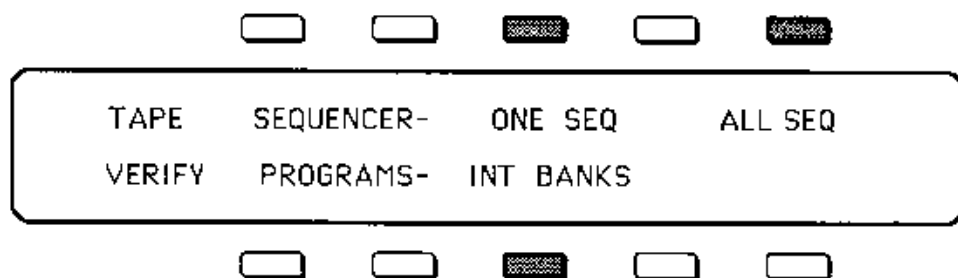

-----> Start the Tape Deck Playing. Listen to the Output, or watch the VU meters, and wait for the Leader Tone which precedes the Data to begin.

-----> After the Leader Tone begins, press **ALL SEQ** or **ONE SEQ**, depending on which you just saved. This starts the **ESQ 1** checking the Data on the Tape. The Display will read ***READING DATA FROM TAPE***.

-----> If the Data on the Tape is correct, the Display will say ***TAPE PROCEDURE COMPLETE***, and then return you to the **STORAGE** Page.

-----> If the Verify is unsuccessful, you will get one of the following messages:

- 1) ***TAPE NOT STARTED ON LEADER TONE*** -- The Leader Tone must be actually playing when you press **ALL DATA** or **ONE SEQ** to begin Verifying. A too-high or too-low playback level can also cause this message. Try the Procedure again, making sure that the leader has started, and perhaps adjusting the playback level of the deck.
- 2) ***VERIFY FAILED -- INVALID TAPE DATA*** -- This can result from a number of things -- the Data was recorded at too high, or too low, a level; a serious dropout or other Tape problem has garbled the Data; or a bad connection has resulted in a loss of Data. In any case, when you get this message, Save the Data again, to another section of the Tape, or use another Tape.
- 3) ***INCORRECT TYPE OF DATA ON TAPE*** -- This message would result if you pressed **ONE SEQ** or **ALL DATA**, and then played Program Data, or some other non-Sequencer Data, into the **ESQ 1**.

-----> If after a Verify, the Display reads ***DATA ERROR FROM TAPE WAS FIXED***, it means the **ESQ 1** found one bit of wrong information on the Tape, but was able to correct it. This might indicate an aging Tape, or a slight dropout, and it is a good idea to save the information to another Tape, or to another location on the same tape.

*** * * * Note:** Whenever you get an error message while transferring Data by Tape or via MIDI, the message will remain on the Display until you press one of the front panel buttons. Press any button (except a Soft Button) to continue.

LOADING All Sequencer Memory from Audio Tape

- > Connect the **Output** of the channel of your tape recorder that contains the Sequence Data to the **ESQ 1's Tape In Jack**.
- > Select the **STORAGE** Page.
- > The Tape Deck should be in Stop or Pause, at the beginning of the Data to be Loaded.
- > Press **TAPE LOAD**. The Display shows the following:

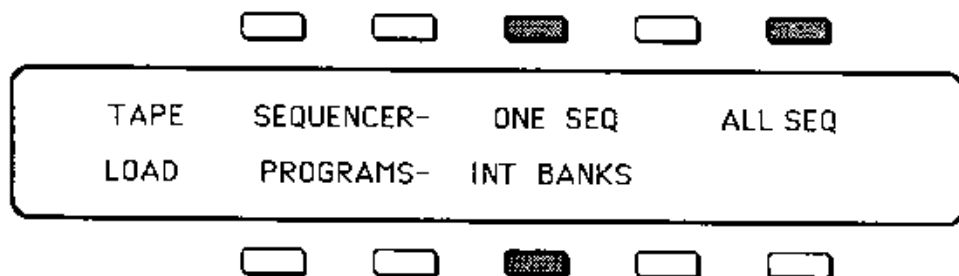

- > Start the Tape Deck Playing. Listen to the Output, or watch the VU meters, and wait for the Leader Tone which precedes the Data to begin.
- > After the Leader Tone begins, press **ALL SEQ**. This starts the **ESQ 1** Loading the Data on the Tape. The Display will read ***READING DATA FROM TAPE***.
- > If the Load is successful, the Display will say ***TAPE PROCEDURE COMPLETE***, and then return you to the **STORAGE** Page. The Sequencer Memory from the Tape is now in the **ESQ 1**, replacing whatever Songs and Sequences were in the Memory.
- > If the Load is unsuccessful, one of these messages will appear:
 - 1) ***TAPE NOT STARTED ON LEADER TONE*** -- The Leader Tone must be actually playing when you press **ALL DATA** to begin Loading. Try the Procedure again.
 - 2) ***INCORRECT TYPE OF DATA ON TAPE*** -- The Data was not Sequence Data.
 - 3) ***INSUFFICIENT MEMORY TO LOAD SEQUENCE*** -- This message will appear if you try to Load more Data than the **ESQ 1** has Sequencer Memory for. For example, if you Saved the Data from an **ESQ 1** which had a **Sequencer Expander Cartridge** in it, and then tried to Load it into an **ESQ 1** that didn't a Sequencer Expander Cartridge, the Data might exceed the available Memory of the second unit.
 - 4) ***FATAL ERRORS DETECTED -- SEQUENCER MEMORY IS CLEARED*** If the **ESQ 1** encounters more than one serious Data error after it has already begun replacing the Sequencer Memory with the Data off the Tape, you will get this message. It means that the Load failed but it was too late to save the Internal Sequencer Memory.

---->The Display might read ***DATA ERROR FROM TAPE WAS FIXED***. Again, this means that the **ESQ 1** found one bit of wrong information on the Tape, but was able to correct it. Save the information to another Tape location.

LOADING One Sequence from Audio Tape

- > Connect the **Output** of the channel of your tape recorder that contains the Sequence Data to the **ESQ 1's Tape In Jack**.
- > Select the **STORAGE** Page.
- > The Tape Deck should be in Stop or Pause, at the beginning of the Data to be Loaded.
- > Press **TAPE LOAD**. The Display shows the following:



- > Start the Tape Deck Playing. Listen to the Output, or watch the VU meters, and wait for the Leader Tone which precedes the Data to begin.
- > After the Leader Tone begins, press **ONE SEQ**. This starts the **ESQ 1** Loading the Data on the Tape. The Display will read ***READING DATA FROM TAPE***.
- > If the Load is successful, the Display will say ***TAPE PROCEDURE COMPLETE***, and then return you to the **STORAGE** Page.
- > When you Load One Sequence from Tape, that Sequence is placed in the **highest-numbered** empty Sequence Memory Location. So if **SEQ #30** is not defined, the new Sequence will be put there when you Load it into the **ESQ 1**. If location **#30** already contains a Sequence, the new Sequence will be put in Location **#29**. If locations **#29** and **30** contain Sequences, the new Sequence will be put in Location **#28**. And so on. If there are no empty Sequence Locations when you try to Load One Sequence, the Display will read ***NO SEQUENCE LOCATIONS AVAILABLE***. Erase a Sequence and try again.
- > If the Load is unsuccessful, any of the Error messages listed on the previous page under **Loading All Sequencer Memory from Audio Tape** may appear, except for **#4**. The **ESQ 1** will not erase the entire Sequencer Memory while trying unsuccessfully to Load one Sequence. If the **ESQ 1** cannot Load the Sequence because of bad Data on the tape, the Display will read ***SEQUENCE LOAD FAILED -- TAPE ERROR***. This does not damage the Sequences and Songs that were already in the **ESQ 1's** Memory -- they should still be intact.

MIDI TRANSFER OF SEQUENCER DATA

The **ESQ 1** can send All Sequencer Data, or a single Sequence, over MIDI to another **ESQ 1**. It can also send All Sequencer Data, along with the 40 Internal Programs, to a **Mirage** Digital Sampling Keyboard or **Mirage** Digital Multisampler. The Data can then be stored on formatted **Mirage** diskettes, just like **Mirage** sound Data. The **ESQ 1** can also Load All Sequencer Data, by itself or with the 40 Internal Bank Programs, from a **Mirage**.

MIDI Connections

In the case of Sending or receiving Sequencer Data via MIDI, both the **MIDI Out** jack and the **MIDI In** jack of the Sending Unit must be connected to the **MIDI In** and the **MIDI Out** jacks of the receiving Unit. To receive Sequence Data from an **ESQ 1**, a **Mirage** must be booted with a **MASOS** (Mirage Advanced Sampling Operation System) Diskette.

SENDING All Sequencer Memory via MIDI to a Mirage

Whenever you send Sequence Data to a **Mirage**, the 40 Programs in the **ESQ 1**'s Internal Memory are automatically sent to the **Mirage** along with the Sequence Data. When you later Load the Sequence Data back into the **ESQ 1**, you will be given the choice of Loading only the Sequencer Data, or the Sequencer Data plus the 40 Internal Programs.

When you send Sequencer Data to a **Mirage**, the MIDI Channel and MIDI Mode of each Machine doesn't matter. This procedure "tricks" the **Mirage** into thinking that it is receiving Sound Data. The Data goes into both halves of the **Mirage** Memory -- Upper and Lower. Both Upper and Lower must be saved to diskette to preserve the Data.

- > Boot the **Mirage** with a **MASOS** Diskette.
- > Connect the **MIDI Out** of the **ESQ 1** to the **MIDI In** jack of the **Mirage**.
Connect the **MIDI In** of the **ESQ 1** to the **MIDI Out** jack of the **Mirage**.
- > On the **ESQ 1**, select the **STORAGE** Page, and press **MIDI SEND**. The following Page appears:



- > Press **SEQ TO MIRAGE**. The Display will read ***MIDI DATA BEING TRANSFERRED* PLEASE WAIT...**

- > If the transfer is successful, the Display will say ***MIDI PROCEDURE COMPLETE***, and then return to the **STORAGE** Page. The Sequencer Data is now in the Upper and Lower Memory of the **Mirage**, and can be saved as a Sound to a formatted diskette. Remember you must save both Banks of **Mirage** Memory.
- > If the Display says ***TARGET SYSTEM NOT RESPONDING***, check your MIDI connections, make sure the **Mirage** is booted with **MASOS**, and try again.

LOADING All Sequencer Memory via MIDI from a Mirage

*** * * * Note:** To load Sequencer Data from a **Mirage**, the **ESQ 1** must have System Exclusive messages enabled (**ENABLE=KEYS+CT+PC+SS+SX** on the **MIDI** Page.)

As mentioned earlier, when you Load Sequencer Data from the **Mirage**, you have the option of also Loading the 40 Internal Programs that were saved to the **Mirage** along with that Data. This will replace the Internal Programs that were there before.

- > Boot the **Mirage** with a **MASOS** diskette.
- > Load the Sequence Data into the **Mirage** from a diskette where it has been stored. Both Upper and Lower Memory must be loaded.
- > Connect the **MIDI In** of the **ESQ 1** to the **MIDI Out** jack of the **Mirage**. Connect the **MIDI Out** of the **ESQ 1** to the **MIDI In** jack of the **Mirage**.
- > On the **ESQ 1**, Set the Enables on the **MIDI** Page to **ENABLE= KEYS+CT+PC+SS+SX**.
- > On the **ESQ 1**, select the **STORAGE** Page, and press **MIDI LOAD**. The following Page appears:

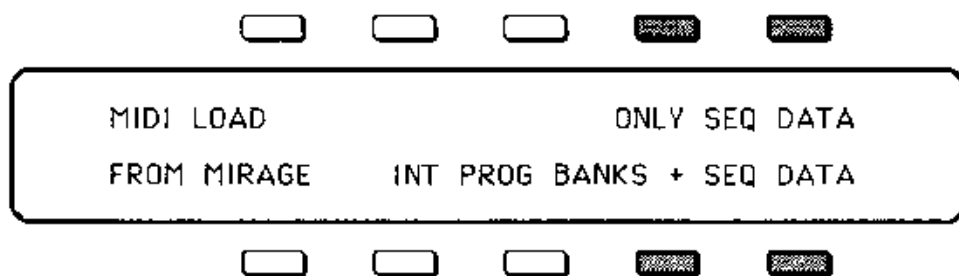

- > Press **ONLY SEQ DATA** to Load only the Sequencer Data; or press **INT PROG BANKS + SEQ DATA** to Load both the Sequencer Data and the Programs. The Display will read ***MIDI DATA BEING TRANSFERRED* PLEASE WAIT...**
- > If the transfer is successful, the Display will say ***MIDI PROCEDURE COMPLETE***, and then return to the **STORAGE** Page. The Sequencer Data is now in the **ESQ 1**'s Sequencer Memory; and if you selected **INT PROG BANKS + SEQ DATA**, the 40 Internal Programs have also been replaced.
- > If the Display says ***TARGET SYSTEM NOT RESPONDING***, check 1) your MIDI connections, 2) that the **Mirage** is booted with **MASOS**, and 3) the MIDI Enables on the **ESQ 1**, and try again.

- > A number of other error messages are also possible:
- 1) ***INSUFFICIENT MEMORY TO LOAD SEQUENCE*** -- As explained earlier, this message will appear if you try to Load more Data than the **ESQ 1** has Sequencer Memory for.
 - 2) ***ONLY SEQUENCE DATA CAN BE LOADED*** -- If you try to load **Mirage** sound Data into the **ESQ 1**'s Sequencer Memory, you will get this message.
 - 3) ***FATAL ERRORS DETECTED -- SEQUENCER MEMORY IS CLEARED***
The MIDI connections being disconnected during the transfer can result in this message. Try the Load again.
- *** **Note:** Whenever you are using a **Mirage** to store Sequence Data, it is a good idea move all **ESQ 1** Programs used in those Sequences to Internal Memory locations. That way when you Load the Sequences back into the **ESQ 1** from the **Mirage**, you can Load the Internal Banks with them, and the right Programs will always play with each Sequence.

SENDING All Sequencer Memory via MIDI to another ESQ 1

When you send all Sequencer Data to another **ESQ 1**, both units must be assigned the same MIDI Channel, but the MIDI Mode of each Machine doesn't matter. The Receiving Unit must have System Exclusive messages Enabled (Set the Enables on the **MIDI** Page to **ENABLE= KEYS+CT+PC+SS+SX.**)

- > Connect the **MIDI Out** of the Sending **ESQ 1** to the **MIDI In** jack of the Receiving **ESQ 1**
Connect the **MIDI In** of the Sending **ESQ 1** to the **MIDI Out** jack of the Receiving **ESQ 1**
- > On the Receiving **ESQ 1**, Set the Enables on the **MIDI** Page to **ENABLE= KEYS+CT+PC+SS+SX.**
- > On the Sending **ESQ 1**, select the **STORAGE** Page, and press **MIDI SEND.**
The following Page appears:



----> Press **SEQ TO ESQ 1**. The Display shows the following:

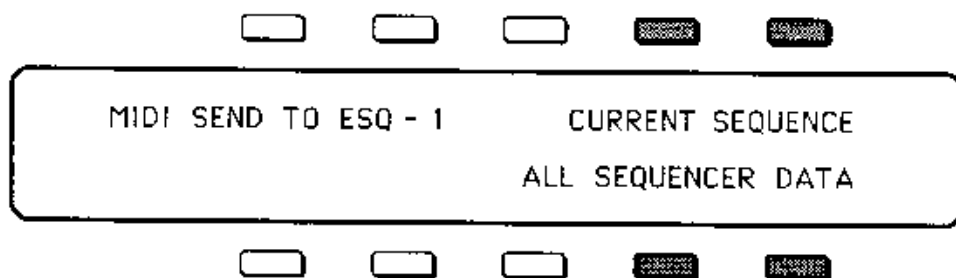

- > Press **ALL SEQUENCER DATA**. The Display will read ***MIDI DATA BEING TRANSFERRED* PLEASE WAIT...**
- > If the transfer is successful, the Display will say ***MIDI PROCEDURE COMPLETE***, and then return to the **STORAGE** Page. The Sequencer Data is now in the Sequencer Memory of the Receiving **ESQ 1**, replacing whatever was there previously.
- > If the Display says ***TARGET SYSTEM NOT RESPONDING***, check your MIDI connections, and the MIDI Enables on the **MIDI** Page of the Receiving Unit, and try again.

SENDING One Sequence via MIDI to another ESQ 1

Again, both units must be assigned the same MIDI Channel, but the MIDI Mode of each Machine doesn't matter. The Receiving Unit must have System Exclusive messages Enabled (Set the Enables on the **MIDI** Page to **ENABLE= KEYS+CT+PC+SS+SX**.)

- > Make sure the Sequence you want to Send is Selected.
- > Connect the **MIDI Out** of the Sending **ESQ 1** to the **MIDI In** jack of the Receiving **ESQ 1**
Connect the **MIDI In** of the Sending **ESQ 1** to the **MIDI Out** jack of the Receiving **ESQ 1**
- > On the Receiving **ESQ 1**, Set the Enables on the **MIDI** Page to **ENABLE= KEYS+CT+PC+SS+SX**.
- > On the Sending **ESQ 1**, select the **STORAGE** Page, and press **MIDI SEND**. Press **SEQ TO ESQ 1**. The Display shows the following:

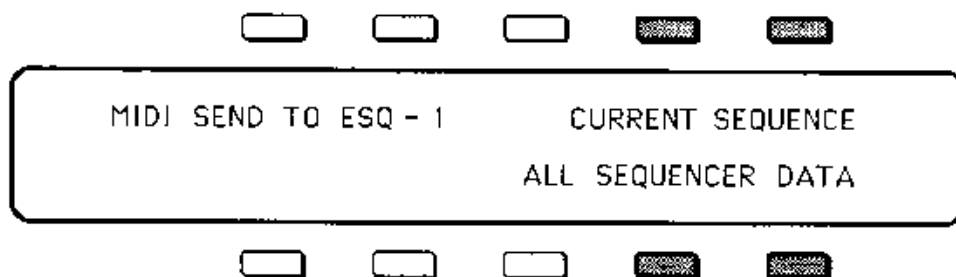

- > Press **CURRENT SEQUENCE**. The Display will read ***MIDI DATA BEING TRANSFERRED* PLEASE WAIT...**
- > If the transfer is successful, the Display will say ***MIDI PROCEDURE COMPLETE***, and then return to the **STORAGE** Page. The Sequence is now in the **highest-numbered** empty, Sequence Memory Location of the Receiving **ESQ 1**.
- > If there were no empty Sequence Locations on the Receiving Unit, the Display of the Sending Unit will read ***NO SEQUENCE LOCATIONS AVAILABLE***. Erase a Sequence and try again.
- > If the Display says ***TARGET SYSTEM NOT RESPONDING***, check your MIDI connections, and the MIDI Enables on the **MIDI** Page of the Receiving **ESQ 1**, and try again.
- > If the Receiving Unit doesn't have enough free Memory for the Sequence, the Display of the Sending Unit will read ***INSUFFICIENT MEMORY TO LOAD SEQUENCE***. Erase some Sequences on the receiving **ESQ 1** and try again.

Appendices

- Appendix 1 MIDI Program Numbers on the ESQ 1
- Appendix 2 ESQ 1 MIDI Implementation Specifications
- Appendix 3 ESQ 1 MIDI Parameter Number List
- Appendix 4 ESQ 1 MIDI Implementation Chart
- Appendix 5 Program Parameter Sheet
- Appendix 6 Program Control Block Structure
- Appendix 7 Track Sheet

MIDI Program Numbers on the ESQ 1

The Chart below shows the Program Number of each Internal and Cartridge Program on the **ESQ 1**. For each Program Bank, the chart shows the Program number that corresponds to each of the ten locations on the Display. For a given **ESQ 1** Program, this number is:

- 1) The Program Number (plus 1; see note below) that will be sent out over MIDI whenever the corresponding **ESQ 1** Program is selected (assuming Program Changes are Enabled);
- 2) The Program Number that will cause the corresponding **ESQ 1** Program to be selected when it is received over MIDI; and
- 3) The number that will show on the **TRACK PROG NUM** Sub-Page of the **Mix/MIDI** Page, when the corresponding Program is selected for a Track on the **Tracks Select** Page.

Internal Memory	Bank 1	001	002	003	004	005
		006	007	008	009	010
	Bank 2	011	012	013	014	015
		016	017	018	019	020
Cart A	Bank 3	021	022	023	024	025
		026	027	028	029	030
	Bank 4	031	032	033	034	035
		036	037	038	039	040
Cart B	Bank 1	041	042	043	044	045
		046	047	048	049	050
	Bank 2	051	052	053	054	055
		056	057	058	059	060
Cart B	Bank 3	061	062	063	064	065
		066	067	068	069	070
	Bank 4	071	072	073	074	075
		076	077	078	079	080
Cart B	Bank 1	081	082	083	084	085
		086	087	088	089	090
	Bank 2	091	092	093	094	095
		096	097	098	099	100
Cart B	Bank 3	101	102	103	104	105
		106	107	108	109	110
	Bank 4	111	112	113	114	115
		116	117	118	119	120

Note: True MIDI Program Numbers begin at **00** instead of one. To determine the true MIDI Program number, subtract 1 from the number shown in the table above.

ESQ-1 MIDI Implementation Specifications (Software v. 2.0)

1.0 Sequencer Dump - Mirage Format

1.1 Mirage Wavesample Absolute Dump Format

NOTE: The format of this message is identical to the Mirage wavesample dump absolute data message described in the MIDI documentation included in the Mirage Advanced Samplers Guide.

11110000	System Exclusive status byte
00001111	ENSONIQ Code
00000001	Mirage Code
00001100	Wavesample dump absolute data code
000nllll	n=0 lower, n=1 upper
0000llll	l=low byte of start address
0000hhhh	h= high byte of start address
0000llll	l= low byte of end address
0000llll	l= low byte of end address
0000hhhh	h= high byte of end address
0000hhhh	h= high byte of end address
0000llll	Data: each byte is sent as 2 nybbles, with the most significant nybble of each byte reset. (l = low nybble, h = high nybble)
0000hhhh	Data: each byte is sent as 2 nybbles, with the most significant nybble of each byte reset. (l = low nybble, h = high nybble)
0ccccccc	c=check sum formed by modulo 128 add of all of the nybbles plus the low and high pointers
11110111	End of exclusive

1.2 Formation of the Sequence Dump Data Messages

Four wave dump packets are actually transmitted in the process of transferring sequence data from the ESQ-1 to a Mirage.

1.2.1 I.D. Packet

The first packet contains 0 1 2 3 4 5 6 7, followed by the amount of sequencer RAM used in the ESQ-1. This data is sent to location FF00H through FF0AH in the upper bank.

This is necessary because, during reloading, this information will be checked by the

ESQ-1 MIDI Implementation Specifications (Software v. 2.0)

ESQ-1 to insure that the data is actually sequencer information and that the ESQ-1 has sufficient memory to load the stored sequence data.

1.2.2 Sequencer Variables Packet

The second packet contains the sequencer's internal variables, as well as Sequence Header information, etc. The data in the second packet is sent to locations 0000 through 0132H in the upper bank.

1.2.3 Sequence Data Packet

The third packet is the sequence data itself. It is sent to location 0000H in the lower bank. The length of the message depends on how much sequence memory is currently used in the ESQ-1.

1.2.4 Internal Bank Programs

The fourth packet contains the 40 voice programs from the four internal banks of the ESQ-1. The program data is sent to locations 1000H through 1FF0H in the upper bank.

1.3 Wave Sample Requests

The ESQ-1 will issue up to four Mirage wavesample absolute dump messages in order to retrieve the sequence data from a Mirage. Refer to the Mirage Advanced Samplers Guide for more information on these messages.

11110000	System Exclusive
00001111	ENSONIQ Code
00000001	Mirage Code
00001010	Wavesample absolute request code
000nllll	n=0 lower, n=1 upper
0000llll	l=low byte of start address
0000hhhh	
0000hhhh	h= high byte of start address
0000llll	
0000llll	l= low byte of end address
0000hhhh	
0000hhhh	h= high byte of end address
11110111	End of exclusive

1.3.1 I.D Packet Request

Requests the Mirage to send the data from upper bank locations FF00H through FF0AH.

ESQ-1 MIDI Implementation Specifications (Software v. 2.0)

The data sent in response to this request is then checked to determine if the data in the Mirage is actually ESQ-1 sequence data. If it is, then the size of the data block is also checked to determine if the receiving ESQ-1 has sufficient available memory to load the data. This is useful in determining whether or not the sequencer memory expansion cartridge is required to load the sequence data.

1.3.2 Sequencer Variables Request

Requests the Mirage to send the sequencer variables and sequence header data from upper bank locations 0000H through 0132H.

1.3.2 Sequence Data Request

Requests to send the data from the lower bank starting at location 0000H. The end address is determined by the data that was retrieved in the I.D. packet.

1.3.3 Voice Program Request

An optional request to send the voice program data in locations 1000H through 1FF0H of the upper bank. The user may specify whether or not to load the internal program banks of the ESQ-1 with this data when the sequence load command is initiated.

2.0 ESQ-1 System Exclusive Format

2.1 ESQ-1 System Exclusive Header

All ESQ-1 System Exclusive messages start with the following header. The receiving ESQ-1 will only recognize system exclusive messages if the MIDI channel number in the message is the same as the MIDI base channel selected on its MIDI page and its MIDI enable parameter is set to recognize system exclusive messages (i.e the display should show ENABLE=KEYS+CT+PC+SS+SX).

11110000	System Exclusive status byte
00001111	ENSONIQ I.D. code
00000010	ESQ Product I.D. code
0000nnnn	MIDI channel number

2.2 Program Dumps

To be able to receive this data, the ESQ-1 must be in program select mode (i.e. one of the program bank pages must be displayed) and the MIDI enable parameter on the MIDI page must be set to receive system exclusive messages.

ESQ-1 MIDI Implementation Specifications (Software v. 2.0)

2.2.1 Single Program Dump

This transmits the program currently selected on the synth main keyboard (the "straight-synth" program). Refer to Table 1 for details on the structure of the program.

xxxxxxx	ESQ System Exclusive header
00000001	Single Program Dump code
0000llll 0000hhhh	2 nybbles per byte of program data 102 data bytes (204 nybble-ized MIDI bytes) l = low nybble, h = high nybble
11110111	End of exclusive

2.2.2 All Program Dump

This message transmits the 40 programs currently in the four internal banks.

xxxxxxx	ESQ System Exclusive header
00000010	All Program Dump code
0000llll 0000hhhh	2 nybbles per byte of program data 102 * 40 data bytes (9160 nybble-ized MIDI bytes) l = low nybble, h = high nybble
11110111	End of exclusive

2.3 Sequence dumps

Sequencer dumps are transmitted as a multi-packet sequence of messages. The transmitter first sends a dump alert packet. This packet contains the size of the sequence to be transmitted. If the receiver can accept this amount of data it sends an accept message; otherwise it sends a reject message.

After the transmitting ESQ-1 receives an accept message, it will then transmit the sequence data dump.

NOTE: Sequence dumps should not be sent to an ESQ-1 without first transmitting a sequence dump alert message and then waiting for the response.

ESQ-1 MIDI Implementation Specifications (Software v. 2.0)

2.3.1 All Sequence Dump Alert Packet

This message is transmitted by the sending ESQ-1 to inform the receiving unit that it wishes to dump the entire sequencer memory.

xxxxxxx	ESQ System Exclusive Header
0000011	All Sequence Dump Alert code
0000lll	Low byte (in nybbles) of sequence size
0000lll	Low byte (in nybbles) of sequence size
0000hhhh	High byte (in nybbles) of sequence size
0000hhhh	High byte (in nybbles) of sequence size
11110111	End of exclusive

2.3.2 One Sequence Dump Alert Packet

Transmitted by the sending ESQ-1 to inform the receiving unit that it wishes to dump the currently selected single sequence.

xxxxxxx	ESQ System Exclusive Header
0000011	One Sequence Dump Alert code
0000lll	Low byte (in nybbles) of sequence size
0000lll	Low byte (in nybbles) of sequence size
0000hhhh	High byte of sequence size
0000hhhh	High byte of sequence size
11110111	End of exclusive

2.3.3 Accept Message

Transmitted by the receiving ESQ-1 to indicate that it will accept a sequence dump.

xxxxxxx	ESQ System Exclusive Header
00000100	Sequence Accept code
11110111	End of exclusive

ESQ-1 MIDI Implementation Specifications (Software v. 2.0)

2.3.4. Reject Message

Transmitted by the receiving ESQ-1 to indicate that it does not have sufficient memory to accept the dump from the sending ESQ-1

xxxxxxx	ESQ System Exclusive Header
00000101	Sequence Reject code
11110111	End of exclusive

2.3.5 No Free Sequence Message

Transmitted by the receiving ESQ-1 in response to a One Sequence Dump Alert Packet (2.3.2) to indicate that it does not have any empty sequence locations in which to place the incoming sequence.

xxxxxxx	ESQ System Exclusive Header
00001101	No free sequence reject code
11110111	End of exclusive

2.3.6 All Sequence Dump Packet

This packet contains the sequence data. The data block consists of 132H bytes of track and pointer information, followed by the number of bytes of sequence data, as determined by the sequence size specified in the All Sequence Dump Alert packet. (see 2.3.1).

xxxxxxx	ESQ System Exclusive Header
00000110	Sequence Dump code
0000llll 0000hhhh	Data.. variable number of bytes of sequence data l = low nybble, h = high nybble
11110111	End of exclusive

ESQ-1 MIDI Implementation Specifications (Software v. 2.0)

2.3.7 One Sequence Dump Packet

This packet contains the data for the current sequence. The packet will contain the number of bytes specified in the one sequence alert packet (see section 2.3.2).

xxxxxxx	ESQ System Exclusive Header
00001000	One sequence Dump code
0000llll 0000hhhh	Data.. variable number of bytes of sequence data l = low nybble, h = high nybble
11110111	End of exclusive

2.4 Request Messages

The following are messages which can be sent to an ESQ-1 to initiate program or sequence dumps.

2.4.1 Current Program Dump Request

This request asks for a dump of the currently selected program. The ESQ-1 responds with a Single Program Dump Packet (2.2.1).

xxxxxxx	ESQ System Exclusive Header
00001001	Program Dump Request code
11110111	End of exclusive

2.4.2 All Program Dump Request

This request asks the ESQ-1 to dump all 40 of its internal programs. The ESQ-1 responds with an All Program Dump Packet (2.2.2).

xxxxxxx	ESQ System Exclusive Header
00001010	All Program Dump Request code
11110111	End of exclusive

ESQ-1 MIDI Implementation Specifications (Software v. 2.0)

2.4.3 All Sequence Dump Request

This request asks the ESQ-1 to dump all sequencer data. The ESQ-1 responds with a Sequence Dump Alert Packet (2.3.1). The requesting unit should then respond with an accept or reject packet as described in section 2.3.1

xxxxxxx	ESQ System Exclusive Header
00001011	All Sequence Dump Request code
11110111	End of exclusive

2.4.4 One Sequence Dump Request

This request asks the ESQ-1 to dump its currently selected sequence. The ESQ-1 Responds with an One Sequence Dump Alert Packet (2.3.2).

xxxxxxx	ESQ System Exclusive Header
00001100	One Sequence Dump Request code
11110111	End of exclusive

2.5 Received Virtual Keypad Events

This system exclusive message allows an external device to simulate the pressing of the ESQ-1's front panel buttons. The format of the message is an ESQ System Exclusive Header, followed by the Keypad Command Code, and then a stream of button down and button up codes which is terminated by an End of Exclusive.

NOTE: Each Button Down keypad event should be followed by a Button Up event for the same button to prevent the inbound keypad event processor from becoming "hung up" while waiting for a button to be released. This should usually be done within one system exclusive message. It should also be possible to follow up with separate messages, but be careful not to leave dangling button downs !

xxxxxxx	ESQ System Exclusive header
00001110	Keypad Command code
	(Data stream...)

ESQ-1 MIDI Implementation Specifications (Software v. 2.0)

0nnnnnnn Any number of keypad events (button down/up codes)
 One button down or button up event per byte.
 (button codes are specified in the table below)

11110111 End of exclusive

Button Codes				<u>Front Panel Button Name</u>
Down		Up		
<u>Dec</u>	<u>Hex</u>	<u>Dec</u>	<u>Hex</u>	
01	01	52	34	ENV1
02	02	53	35	ENV2
03	03	54	36	ENV3
04	04	55	37	ENV4
05	05	56	38	LFO1
06	06	57	39	LFO2
07	07	58	3A	LFO3
08	08	59	3B	OSC1
09	09	60	3C	OSC2
10	0A	61	3D	OSC3
11	0B	62	3E	DCA1
12	0C	63	3F	DCA2
13	0D	64	40	DCA3
14	0E	65	41	DCA4
15	0F	66	42	FILTER
16	10	67	43	MODES
17	11	68	44	SPLIT/LAYER
18	12	69	45	MASTER
19	13	70	46	MIDI
20	14	71	47	CONTROL
21	15	72	48	STORAGE
22	16	73	49	WRITE
23	17	74	4A	COMPARE
24	18	75	4B	INC (up arrow)
25	19	76	4C	DEC (down arrow)
26	1A	77	4D	CREATE
27	1B	78	4E	EDIT
28	1C	79	4F	TRACKS-SELECT
29	1D	80	50	LOCATE
30	1E	81	51	TRACKS-MIX/MIDI
31	1F	82	52	RECORD
32	20	83	53	STOP
33	21	84	54	PLAY
34	22	85	55	BANK 1
35	23	86	56	BANK 2

ESQ-1 MIDI Implementation Specifications (Software v. 2.0)

Button Codes				<u>Front Panel Button Name</u>
Down		Up		
<u>Dec</u>	<u>Hex</u>	<u>Dec</u>	<u>Hex</u>	
36	24	87	57	BANK 3
37	25	88	58	BANK 4
38	26	89	59	INTERNAL
39	27	90	5A	CART A
40	28	91	5B	CART B
41	29	92	5C	SEQuence
42	2A	93	5D	SOFTKEY 0
43	2B	94	5E	SOFTKEY 1
44	2C	95	5F	SOFTKEY 2
45	2D	96	60	SOFTKEY 3
46	2E	97	61	SOFTKEY 4
47	2F	98	62	SOFTKEY 5
48	30	99	63	SOFTKEY 6
49	31	100	64	SOFTKEY 7
50	32	101	65	SOFTKEY 8
51	33	102	66	SOFTKEY 9

As you may have observed, the button up codes are differentiated from the button down codes by a positive offset of 51 decimal or \$33 hex. The Button Code 00 is reserved for illegal key events within the system and should not be sent to the ESQ-1. Also, button codes out of the range specified in the above table should not be sent to the ESQ-1.

2.6 MIDI Song Selects

MIDI Song Selects may be received by the ESQ-1 when the setting of the MIDI Enable parameter is "KEYS+CT+PC+SNGSL" or "KEYS+CT+PC+SS+SX". Inbound MIDI Song Selects are recognized only in sequencer **STOP** or **SNGS** (Song Stop) modes. Song Selects 00 to 19 will select defined songs within that range and put the sequencer into Song Mode. Selects for undefined songs will be ignored. The ESQ-1 will interpret MIDI Song Selects 20 and above as sequence selects, and will map them onto SEQ-1 and above. A Song Select 20, for example, will select SEQ-1 if it is defined, and will then put the sequencer into Sequence Mode.

MIDI Song Selects are transmitted whenever a song or sequence is selected from the SEQ BANK pages by using the softkeys on the front panel (virtual keypad events will also transmit them).

ENSONIQ ESQ-1 MIDI Parameter Number List

<u>Page</u>	<u>Param#</u>		<u>Parameter Name</u>
	<u>Dec</u>	<u>Hex</u>	
ENV1	0	00	ENV1 L1 parameter
	1	01	ENV1 L2 parameter
	2	02	ENV1 L3 parameter
	3	03	ENV1 T1 parameter
	4	04	ENV1 LV parameter
	5	05	ENV1 T1V parameter
	6	06	ENV1 T2 parameter
	7	07	ENV1 T3 parameter
	8	08	ENV1 T4 parameter
	9	09	ENV1 TK parameter
ENV2	10	0A	ENV2 L1 parameter
	11	0B	ENV2 L2 parameter
	12	0C	ENV2 L3 parameter
	13	0D	ENV2 LV parameter
	14	0E	ENV2 T1V parameter
	15	0F	ENV2 T1 parameter
	16	10	ENV2 T2 parameter
	17	11	ENV2 T3 parameter
	18	12	ENV2 T4 parameter
	19	13	ENV2 TK parameter
ENV3	20	14	ENV3 L1 parameter
	21	15	ENV3 L2 parameter
	22	16	ENV3 L3 parameter
	23	17	ENV3 LV parameter
	24	18	ENV3 T1V parameter
	25	19	ENV3 T1 parameter
	26	1A	ENV3 T2 parameter
	27	1B	ENV3 T3 parameter
	28	1C	ENV3 T4 parameter
	29	1D	ENV3 TK parameter
ENV4	30	1E	ENV4 L1 parameter
	31	1F	ENV4 L2 parameter
	32	20	ENV4 L3 parameter
	33	21	ENV4 LV parameter
	34	22	ENV4 T1V parameter

ENSONIQ ESQ-1 MIDI Parameter Number List

Page	Param#		Parameter Name
	Dec	Hex	
	35	23	ENV4 T1 parameter
	36	24	ENV4 T2 parameter
	37	25	ENV4 T3 parameter
	38	26	ENV4 T4 parameter
	39	27	ENV4 TK parameter
LFO1			
	40	28	LFO1 frequency parameter
	41	29	LFO1 reset parameter
	42	2A	LFO1 humanize switch parameter
	43	2B	LFO1 modulation waveform parameter
	44	2C	LFO1 L1 parameter
	45	2D	LFO1 delay parameter
	46	2E	LFO1 L2 parameter
	47	2F	LFO1 modulation source parameter
LFO2			
	48	30	LFO2 frequency parameter
	49	31	LFO2 reset parameter
	50	32	LFO2 humanize switch parameter
	51	33	LFO2 modulation waveform parameter
	52	34	LFO2 L1 parameter
	53	35	LFO2 delay parameter
	54	36	LFO2 L2 parameter
	55	37	LFO2 modulation source parameter
LFO3			
	56	38	LFO3 frequency parameter
	57	39	LFO3 reset parameter
	58	3A	LFO3 humanize switch parameter
	59	3B	LFO3 modulation waveform parameter
	60	3C	LFO3 L1 parameter
	61	3D	LFO3 delay parameter
	62	3E	LFO3 L2 parameter
	63	3F	LFO3 modulation source parameter
OSC1			
	64	40	OSC1 octave parameter
	65	41	OSC1 semitone parameter
	66	42	OSC1 finetune parameter
	67	43	OSC1 waveform parameter
	68	44	OSC1 modulation source 1 parameter

ENSONIQ ESQ-1 MIDI Parameter Number List

Page	Param#		Parameter Name
	Dec	Hex	
	69	45	OSC1 modulation amount 1 parameter
	70	46	OSC1 modulation source 2 parameter
	71	47	OSC1 modulation amount 2 parameter
OSC2			
	72	48	OSC2 octave parameter
	73	49	OSC2 semitone parameter
	74	4A	OSC2 finetune parameter
	75	4B	OSC2 waveform parameter
	76	4C	OSC2 modulation source 1 parameter
	77	4D	OSC2 modulation amount 1 parameter
	78	4E	OSC2 modulation source 2 parameter
	79	4F	OSC2 modulation amount 2 parameter
OSC3			
	80	50	OSC3 octave parameter
	81	51	OSC3 semitone parameter
	82	52	OSC3 finetune parameter
	83	53	OSC3 waveform parameter
	84	54	OSC3 modulation source 1 parameter
	85	55	OSC3 modulation amount 1 parameter
	86	56	OSC3 modulation source 2 parameter
	87	57	OSC3 modulation amount 2 parameter
DCA1			
	88	58	DCA1 level parameter
	89	59	DCA1 output enable parameter
	90	5A	DCA1 modulation source 1 parameter
	91	5B	DCA1 modulation amount 1 parameter
	92	5C	DCA1 modulation source 2 parameter
	93	5D	DCA1 modulation amount 2 parameter
DCA2			
	94	5E	DCA2 level parameter
	95	5F	DCA2 output enable parameter
	96	60	DCA2 modulation source 1 parameter
	97	61	DCA2 modulation amount 1 parameter
	98	62	DCA2 modulation source 2 parameter
	99	63	DCA2 modulation amount 2 parameter

ENSONIQ ESQ-1 MIDI Parameter Number List

<u>Page</u>	<u>Param#</u>		<u>Parameter Name</u>
	<u>Dec</u>	<u>Hex</u>	
DCA3			
	100	64	DCA3 level parameter
	101	65	DCA3 output enable parameter
	102	66	DCA3 modulation source 1 parameter
	103	67	DCA3 modulation amount 1 parameter
	104	68	DCA3 modulation source 2 parameter
	105	69	DCA3 modulation amount 2 parameter
DCA4			
	106	6A	DCA4 modamt parameter
	107	6B	PAN position parameter
	108	6C	PAN modulation source parameter
	109	6D	PAN modulation amount parameter
FILTER			
	110	6E	FILTER Fc (cutoff) parameter
	111	6F	FILTER Q (resonance) parameter
	112	70	FILTER modulation amount 3 parameter
	113	71	FILTER modulation source 1 parameter
	114	72	FILTER modulation amount 1 parameter
	115	73	FILTER modulation source 2 parameter
	116	74	FILTER modulation amount 2 parameter
MODES			
	117	75	MODES AM switch parameter
	118	76	MODES glide parameter
	119	77	MODES mono switch parameter
	120	78	MODES sync switch parameter
	121	79	MODES rotate switch parameter
	122	7A	MODES envelope reset switch parameter
	123	7B	MODES wave reset switch parameter
	124	7C	MODES cycle switch parameter
SPLIT/LAYER			
	125	7D	S/L layer switch parameter
	126	7E	S/L layer program parameter
	127	7F	S/L split layer switch parameter
	128	80	S/L split layer program parameter
	129	81	S/L split direction parameter
	130	82	S/L split program parameter
	131	83	S/L split point parameter

ENSONIQ ESQ-1 MIDI Parameter Number List

<u>Page</u>	<u>Param#</u>		<u>Parameter Name</u>
	<u>Dec</u>	<u>Hex</u>	

* the following parameter numbers (132-143) are used for the non-pcb system parameters

System parameters:

MASTER

132	84	MASTER tuning parameter
133	85	MASTER velocity parameter
134	86	MASTER chorus switch parameter
135	87	MASTER pitch bend range parameter
136	88	MASTER pitch bend mode parameter

MIDI

137	89	MIDI base channel parameter
138	8A	MIDI overflow switch parameter
139	8B	MIDI xcontrol parameter
140	8C	MIDI pressure parameter
141	8D	MIDI mode parameter
142	8E	MIDI output enable parameter

CONTROL

143	8F	CONTROL metronome rate parameter
144	90	CONTROL sync source parameter
145	91	CONTROL click switch parameter
146	92	CONTROL countoff parameter
147	93	CONTROL seqencer loop switch parameter

*** **Note:** The above numbers are the numbers that are sent in the Parameter Select controllers (MIDI Controller #'s 98 and 99).

MODEL: ESQ 1 MIDI Implementation Chart

Function...		Transmitted	Recognized	Remarks
Basic Channel	Default Channel	1 1 - 16	1 1 - 16	
Mode	Default Messages Altered	Memorized	Memorized OMNI On/Off, MONO On OMNI Off > MULTI	Global Controllers in MIDI Mono Mode
Note Number	True Voice	21 - 108	21 - 108	
Velocity	Note ON Note OFF	<input type="radio"/> <input type="radio"/>	<input type="radio"/> <input type="radio"/>	
After Touch	Key's Ch's	<input type="radio"/> <input type="radio"/>	<input type="radio"/> <input type="radio"/>	Transmitted only if recorded
Pitch Bender		<input type="radio"/>	<input type="radio"/>	
Control Change		1 - 95 1 Mod Wheel 2 Breath 4 Foot Pedal 6 Data Entry 7 Volume 96 Inc. Arrow 97 Dec. Arrow 98 Param. Select Low 99 Param. Select High	1 - 95 1 Mod Wheel 2 Breath 4 Foot Pedal 6 Data Entry 7 Volume 96 Inc. Arrow 97 Dec. Arrow 98 Param. Select Low 99 Param. Select High	Programmable
Prog Change	True #	0 - 119	0 - 119	
System Exclusive		<input type="radio"/>	<input type="radio"/>	
System Common	: Song Pos : Song Sel : Tune	<input type="radio"/> <input type="radio"/> <input checked="" type="checkbox"/>	<input type="radio"/> <input type="radio"/> <input checked="" type="checkbox"/>	
System Real Time	: Clock : Commands	<input type="radio"/> Clock <input type="radio"/> Start, Stop, Cont	<input type="radio"/> Clock <input type="radio"/> Start, Stop, Cont	
Aux Messages	: Local ON/Off : All Notes Off : Active Sense : Reset	<input checked="" type="checkbox"/> <input checked="" type="checkbox"/> <input checked="" type="checkbox"/> <input checked="" type="checkbox"/>	<input checked="" type="checkbox"/> <input type="radio"/> <input checked="" type="checkbox"/> <input checked="" type="checkbox"/>	Only Mode Change
Notes				

Mode 1: OMNI ON, POLY
Mode 3: OMNI OFF, POLY

Mode 2: OMNI ON, MONO
Mode 4: OMNI OFF, MONO

: Yes
 : No

ESQ1 PROGRAM SHEET

PROGRAM:

	OCT=	SEMI=	FINE=	WAVE=	MOD#1	DEPTH	MOD#2	DEPTH
OSC 1								
OSC 2								
OSC 3								

	LEVEL=	OUTPUT=	MOD#1	DEPTH	MOD#2	DEPTH
DCA 1		On Off				
DCA 2		On Off				
DCA 3		On Off				

	FREQ=	Q=	KEYBD=	MOD#1	DEPTH	MOD#2	DEPTH
Filter							

	Final Vol.(ENV 4)	PAN=	PAN MODULATOR	DEPTH
DCA 4				

	FREQ=	RESET=	HUMAN=	WAY=	L1=	DELAY=	L2=	MOD=
LFO 1		On Off	On Off					
LFO 2		On Off	On Off					
LFO 3		On Off	On Off					

	L1=	L2=	L3=	LV=	T1V=	T1=	T2=	T3=	T4=	TK=
ENV 1										
ENV 2										
ENV 3										
ENV 4										

	SYNC=	AM=	MONO=	GLIDE=	VC=	ENV=	OSC=	CYC=
Modes	On Off	On Off	On Off		On Off	On Off	On Off	On Off

	Split/Layer=	Split/Layer Program	Layer=	Layer Program	Split=	Split Program	Split Key=
Split/Layer	On Off		On Off		Off Lower Upper		

PCB Structure, Part One

Envelopes

Four sets of envelope variables

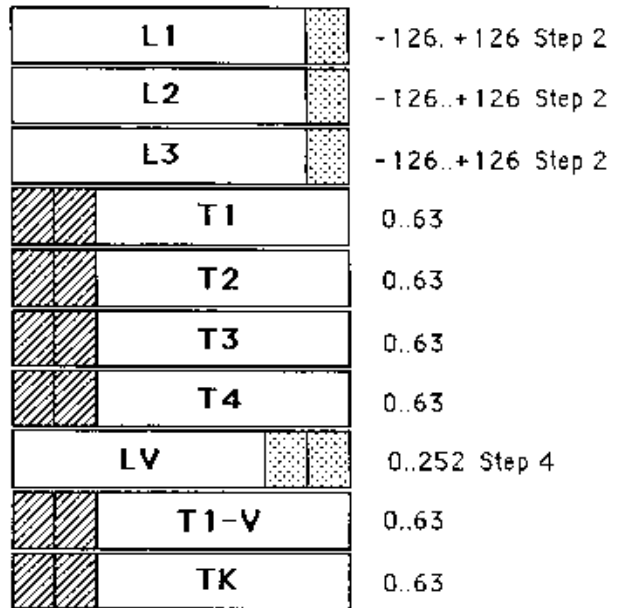

Low Frequency Oscillators

Three sets of LFO variables

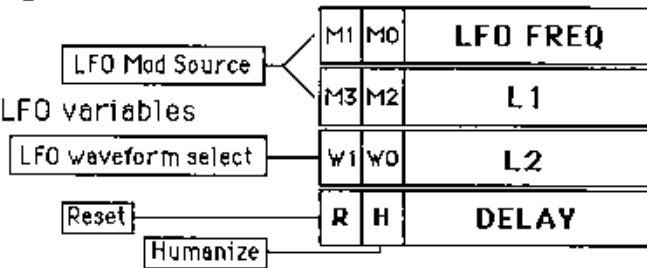

Oscillators

Three sets of OSC variables

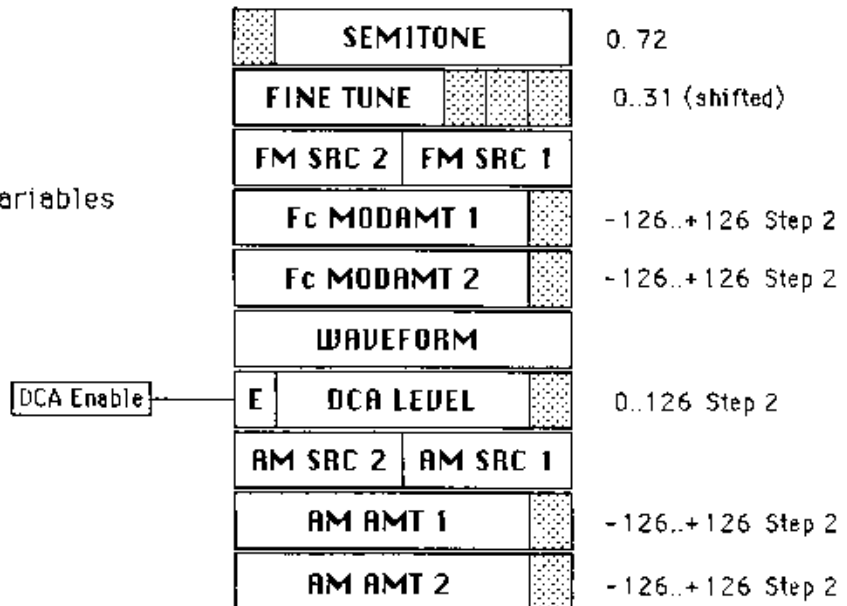

PCB Structure, Part Two

Miscellaneous

DCA 4

Filter

Keyboard and Voice Control

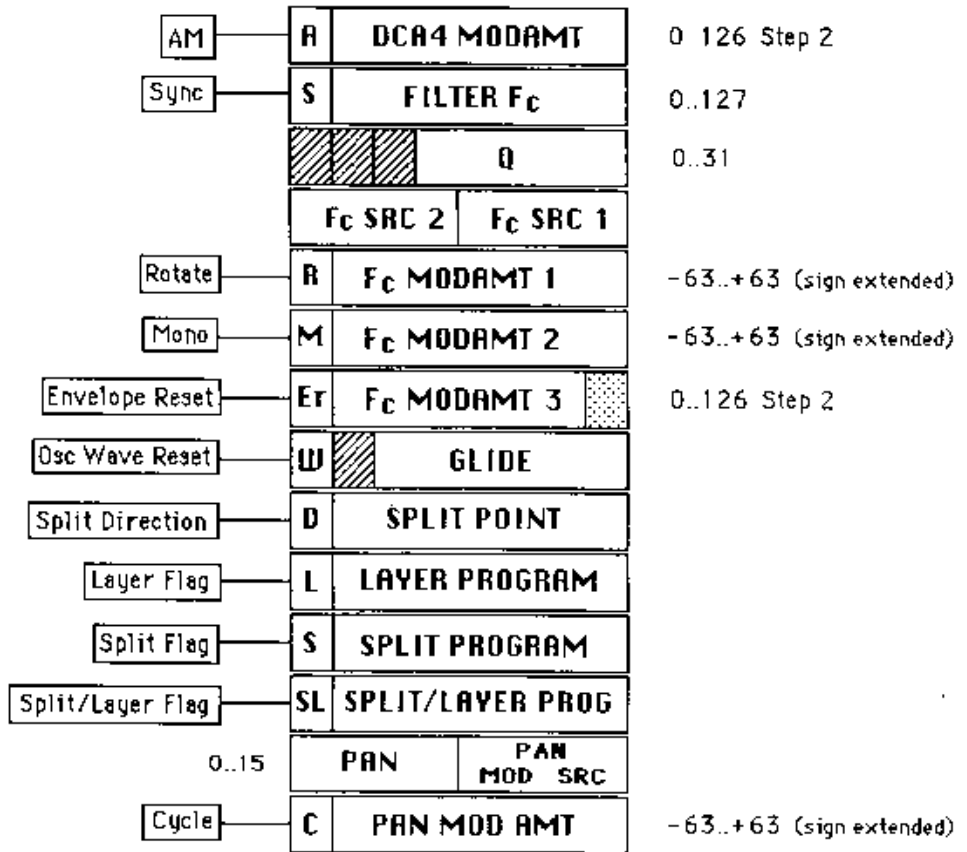

Available



Unavailable

Complete PCB Structure

102 Bytes Total

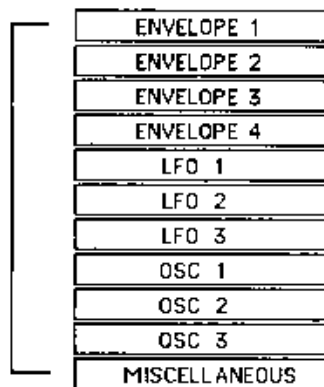

ESQ1 TRACK SHEET

SEQ *

 Template

STORED:

 Recorded Seq.

TIME SIG=

TEMPO=

SYNC=

LOOP = On
 Off

Tracks Select	Tracks Mix/Midi				Receiving Instrument		
	Program	Status	Prog. Num.	Mix	MIDI Chan	Name	Special Notes
Track 1							
Track 2							
Track 3							
Track 4							
Track 5							
Track 6							
Track 7							
Track 8							

Other Notes: