

EMAX II OPERATIONS MANUAL

Copyright E-mu Systems Inc.

*For future reference, copy the
Serial Number from your Emax II here.*



Emax II

16-Bit Digital Sound System
Operation Manual
© 1989 E-mu Systems, Inc.
All Rights Reserved

Written by
Craig Anderton

Editing and additional
illustrations by
Riley Smith

Cover by Dan Borba

■ FI368 Rev. E

E-mu Systems, Inc.
1600 Green Hills Road
Scotts Valley, CA 95066
(831) 438-1921

Important Notice: In order to obtain warranty service on your Emax II, the serial number sticker must be intact and you must have a sales receipt or other proof of purchase. If there is no serial number sticker on your unit, please contact E-mu Systems at once.

This product is covered by one or more of the following U.S. patents: 3,969,682; 3,986,423; 4,404,529; 4,506,579; 4,699,038; and foreign patents and/or pending patents. Emax II is a registered trademark of E-mu Systems, Inc.

WARNING: READ THIS FIRST

IMPORTANT SAFETY INSTRUCTIONS

Changing the voltage selector may require the use of a different line cord or attachment plug, or both. To reduce the risk of fire or electric shock, refer servicing to qualified service personnel. To reduce risk of fire or electric shock do not expose this product to rain or moisture.

GROUNDING INSTRUCTIONS

This product must be grounded. If it should malfunction or break down, grounding provides a path of least resistance for electric current, reducing the risk of electric shock. This product is equipped with a cord having an equipment-grounding conductor and a grounding plug. The plug must be plugged into an appropriate outlet properly installed and grounded in accordance with all local codes and ordinances.

DANGER

Improper connection of equipment grounding conductor can result in the risk of electric shock. Check with a qualified electrician or service personnel if you are in doubt as to whether the product is properly grounded. Do not modify the plug provided with this product — if it will not fit the outlet, have a proper outlet installed by a qualified technician.

CAUTION

If the 2201-06 Emax II is rack mounted, a standard 19 inch open frame rack must be used. Make sure ventilation openings on the rear of the 2201-06, Emax II are not blocked.

USER-MAINTENANCE INSTRUCTIONS

1. The Emax II should be kept clean and dust free. Periodically wipe the unit with a clean, lint free cloth. Do not use solvents or cleaners.
2. There are no user lubrication or adjustment requirements.
3. Refer all other servicing to qualified service personnel.

INSTRUCTIONS PERTAINING TO A RISK OF FIRE, ELECTRIC SHOCK, OR INJURY TO PERSONS

WARNING; When using electric products, basic precautions should always be followed, including the following:

1. Read all instructions before using the Emax II.
2. To reduce the risk of injury, close supervision is necessary when the Emax II is used near children.
3. Do not use the Emax II near water — for example near a bathtub, washbowl, kitchen sink, in a wet basement, on a wet bar, or near or in a swimming pool.
4. The Emax II should be situated so that its location or position does not interfere with its proper ventilation.
5. The Emax II should be located away from heat sources such as radiators, heat registers, fireplaces, stoves, or ovens.
6. The Emax II should only be connected to a power supply of the type described in the operating instructions and as marked on the product.



■ This symbol is intended to alert the user to the presence of important operating and maintenance (servicing) instructions in the literature accompanying the appliance.

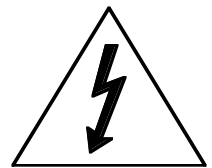

■ This symbol is intended to alert the user to the presence of uninsulated dangerous voltage within the product's enclosure that may be of sufficient magnitude to constitute a risk of electric shock to persons.

7. This product, in combination with an amplifier and headphones and speakers, may be capable of producing sound levels that could cause permanent hearing loss. Do not operate for a long period of time at a high volume level or at a level that is uncomfortable. If you experience any hearing loss or ringing in the ears, consult an audiologist.
8. This Emax II may be equipped with a polarized line plug (one blade wider than the other). This is a safety feature. If you are unable to insert this plug into the outlet, do not defeat the safety purpose of the plug. Contact an electrician to replace your obsolete outlet.
9. The power supply cord of the Emax II should be unplugged from the outlet when left unused for a long period of time.
10. Care should be taken so that objects do not fall and liquids are not spilled into the enclosure of the Emax II through openings.
11. The product should be serviced by qualified service personnel when:
 - A. The power supply cord has been damaged; or
 - B. Objects have fallen, or liquid has been spilled into the product; or
 - C. The product has been exposed to rain; or
 - D. The product does not appear to operate normally or exhibits a marked change in performance; or
 - E. The product has been dropped or the enclosure damaged.
12. All servicing should be referred to qualified service personnel.

SAVE THESE INSTRUCTIONS

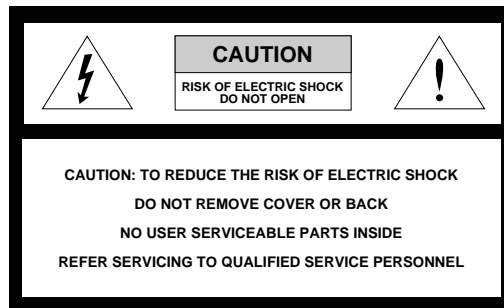

RADIO and TELEVISION INTERFERENCE

The equipment described in this manual generates and uses radio-frequency energy. If it is not installed and used properly-- that is, in strict accordance with our instructions - it may cause interference with radio and television reception.

This equipment has been tested and complies with the limits for a Class A computing device in accordance with the specifications in Subpart J of Part 15 of the FCC rules. These rules are designed to provide reasonable protection against such interference in a residential installation. However, there is no guarantee that the interference will not occur in a particular installation, especially if a "rabbit ear" television antenna is used.

If the Emax II *does* cause interference to radio or television reception, you can try to correct the interference by using one or more of the following measures:

- Turn the television or radio antenna until the interference stops.
- Move the Emax II to one side or the other of the television or radio.
- Move the Emax II farther away from the television or radio.
- Plug the Emax II into an outlet on a different circuit than the television or radio.
- Consider installing a rooftop antenna with a coaxial lead-in between the antenna and television set.

CONTENTS

| | |
|---|-----------|
| INTRODUCTION | 1 |
| EMAX II BASICS | 9 |
| Sampling Basics | 11 |
| The Bank | 12 |
| Samples & Voices | 12 |
| Making a Preset..... | 13 |
| The Current Preset..... | 13 |
| The Current Voice..... | 13 |
| More About Voices | 14 |
| Other Definitions | 16 |
| GUIDED TOURS | 19 |
| Guided Tour No. 1 - Meet the Emax II | 21 |
| Guided Tour No. 2 - Specifying the Current Voice | 25 |
| Guided Tour No. 3 - Dynamic Processing of a Voice | 27 |
| Guided Tour No. 4 - Realtime Control Programming | 31 |
| Guided Tour No. 5 - Basic Sampling | 33 |
| Guided Tour No. 6 - Digitally Processing Samples | 35 |
| Guided Tour No. 7 - Managing the Bank..... | 38 |
| Guided Tour No. 8 - The Sequencer | 38 |
| Guided Tour No. 9 - Make Your Own..... | 39 |
| GENERAL INSTRUCTIONS | 41 |
| Selecting the Current Preset | 43 |
| Exiting a Function..... | 43 |
| Keyboard Numbering Protocol | 44 |
| Disk Handling | 44 |
| FUNCTION BUTTONS | 47 |
| Transpose | 49 |
| Select Drive | 50 |
| Load Bank | 50 |
| Enter Data | 51 |
| MASTER | 53 |
| 1. Master Tune | 55 |
| 2. Memory Remaining..... | 55 |
| 3. Velocity Curve | 56 |
| 4. Erase All | 56 |

CONTENTS

MASTER (continued)

| | |
|------------------------------|----|
| 5. Format Disk | 57 |
| 6. Erase HD Bank | 59 |
| 7. Bird Run | 60 |
| 8. Backup/Restore | 60 |
| 0. Define Custom | 61 |
| 1. Copy HD to HD | 61 |
| 2. New Banks Only | 62 |
| 3. Selected Banks | 62 |
| 4. Custom Backup | 63 |
| 5. Continue Backup | 63 |
| 6. Backup to Floppy | 63 |
| 7. New Banks to Floppy | 64 |
| 8. Selected to Floppy | 64 |
| 9. Floppy Restore | 64 |
| 9. Special | 65 |
| 1. Copy Software | 65 |
| 2. MIDI Master | 66 |
| 3. Recalibrate | 67 |
| 4. Audition Note | 67 |
| 5. MIDI Analyzer | 68 |
| 6. SCSI Boot ID | 68 |
| 7. Install Disk | 69 |
| Software Revision | 69 |

SAMPLE 71

| | |
|-------------------------|----|
| 1. VU Mode/Gain | 73 |
| 2. Place Sample | 73 |
| 3. Sample Rate | 74 |
| 4. Sample Length | 75 |
| 5. Threshold | 76 |
| 6. Arm Sampling | 76 |
| 7. Force Sampling | 77 |
| 8. Stop Sampling | 77 |
| 0. Change Sample | 77 |

DIGITAL PROCESSING 79

| | |
|-----------------------|----|
| 0. Change Voice | 81 |
| 1. Truncate | 82 |
| 2. Loop | 84 |
| 3. Release Loop | 88 |
| 4. Loop Mode | 91 |
| 5. Taper | 92 |
| 6. Splice | 93 |
| 7. Combine | 95 |

CONTENTS

DIGITAL PROCESSING (continued)

| | |
|-----------------------------------|-----|
| 8. Crossfade Loop | 96 |
| 9. Digital Effects | 98 |
| 1. Gain/Attenuation | 98 |
| 2. Reverse Sound | 99 |
| 3. Change Sample Rate | 99 |
| 4. Change Pitch | 100 |
| 5. Transform Multiplication | 101 |
| 6. Spectrum Synthesizer | 103 |

PRESET MANAGEMENT 105

| | |
|--------------------------|-----|
| 1. Load Preset | 107 |
| 2. Save Compressed | 108 |
| 3. Create Preset | 109 |
| 4. Erase Preset | 109 |
| 5. Copy Preset | 110 |
| 6. Rename Preset | 110 |
| 7. Preset Size | 111 |
| 8. Save All 16 Bit | 112 |

PRESET DEFINITION 113

| | |
|----------------------------|-----|
| 1. Copy Voice | 115 |
| 2. Edit Assignment | 118 |
| 3. Erase Voice | 120 |
| 4. Stereo Voice | 121 |
| 5. Crossfade | 123 |
| 6. Arpeggiator | 126 |
| 7. MIDI | 133 |
| 8. Pitch Bend Range | 138 |
| 9. Realtime Controls | 138 |
| 0. Stack Presets | 144 |

DYNAMIC PROCESSING 147

| | |
|------------------------------------|-----|
| 00. Change Voice | 149 |
| 11. Attenuation/Tuning/Delay | 151 |
| 12. VCA AHDSR | 151 |
| 13. Filter Setup | 155 |
| 14. Filter AHDSR | 156 |
| 15. LFO Setup | 157 |
| 16. LFO To | 158 |
| 17. Velocity To A | 159 |
| 18. Velocity To B | 160 |
| 19. Panning | 161 |
| 20. Chorus | 162 |

CONTENTS

DYNAMIC PROCESSING (continued)

| | |
|--------------------------|-----|
| 21. Keyboard Mode | 163 |
| 22. Control Enable | 164 |

SEQUENCER

165

| | |
|-----------------------|-----|
| Play | 167 |
| Record | 167 |
| Stop | 167 |
| Select Sequence | 168 |

Sequencer Manage

| | |
|--------------------------|-----|
| 1. Tempo | 168 |
| 2. Clock Source | 169 |
| 3. Load Sequence | 169 |
| 4. Erase Sequence | 171 |
| 5. Copy Sequence | 173 |
| 6. Rename Sequence | 173 |

Sequencer Setup

| | |
|-----------------------|-----|
| 1. Track Status | 174 |
| 2. Track Preset | 174 |
| 3. Auto Extend | 175 |
| 4. Erase Track | 176 |
| 5. Bounce Track | 176 |
| 6. Supermode | 177 |

ADVANCED APPLICATIONS

181

The Art of Sampling

183

| | |
|---|-----|
| Part 1: Taking the Best Possible Sample | 183 |
| Session #1: Sampling from Tape | 186 |
| Session #2: Sampling Acoustic Instruments | 187 |
| Session #3: Sound Effects | 190 |
| Part 2: Manipulating the Sample | 192 |
| Part 3: Multi-Sampling | 195 |

Fix It in the Mix

197

Multi-Timbral Operation

201

Multi-Timbral Banks

203

Spectrum Synthesis

205

| | |
|-----------------------|-----|
| Overview | 205 |
| Spectrums | 206 |
| Time Slice | 207 |
| Creating Sounds | 208 |

CONTENTS

Spectrum Synthesis (continued)

| | |
|--------------------------------------|-----|
| Interpolation | 209 |
| 1. Frequency Spectrum | 210 |
| 2. Time Slice | 211 |
| 3. Amplitude Contour | 213 |
| 4. Pitch Contour | 214 |
| 5. Pitch/Ratios | 216 |
| 6. Interpolate | 216 |
| 7. Load Parameters | 217 |
| 8. Save Parameters | 217 |
| 9. Erase Parameters | 218 |
| 0. Synthesize! | 218 |
| Approaching Spectrum Synthesis | 219 |
| Spectrum Synthesis Experiments | 219 |

| | |
|-------------------------------|------------|
| Digital Sound Transfer | 221 |
|-------------------------------|------------|

| | |
|------------------------|------------|
| MIDI Supplement | 223 |
|------------------------|------------|

APPENDIX

| | |
|--|-----|
| Velocity Charts | 230 |
| Emax II Memory Expansion | 235 |
| Technical Specifications | 236 |
| MIDI Implementation Chart | 237 |
| Note-to-Frequency Conversion Chart | 238 |
| Index | 239 |
| Warranty | 243 |

INTRODUCTION

WHAT'S AN EMAX II? 2

INSTANT GRATIFICATION 3

CONNECTION INSTRUCTIONS 5

CONNECTION DIAGRAM 6

INTRODUCTION

WHAT'S AN EMAX II?

Emax II is a responsive, low cost, surprisingly easy-to-use musical instrument with staggering creative possibilities. It's also a composer's personal orchestra, a recording studio's chance to have hundreds of acoustic and electronic instruments "on call" at any one time, a university's research tool...but most of all, it provides the means for some truly special musical experiences. To give you a better idea of its capabilities, here are just a few of Emax II's highlights:

In addition to synthesizing sounds, Emax II digitally records ("samples") real-world sounds into its memory with 16-bit, CD quality in either mono or stereo (optional). If you want Emax to sound like a piano, sample a piano; if you want it to sound like a barking dog, sample a dog. Pre-sampled sounds can also be loaded into Emax II's memory from disks. Emax II also contains Spectrum Synthesis, a powerful additive synthesizer.

These sounds may then be modified with Emax II's synthesizer processors and/or state-of-the-art digital processors. The synthesizer-type processors include:

- Dynamic digital lowpass filters (VCF) with AHDSR envelope generators
- Digital amplifiers (VCA) with AHDSR envelope generators
- LFOs with adjustable rate, delay, and speed variation
- Two programmable wheels for real-time control over pitch, filter cutoff, AHDSR attack rate, level, LFO modulation index, etc.
- Two programmable footswitches for real-time control over sustain, release, sustenuto, "patch" change, and sequencer start/stop
- Velocity sensitive keyboard, where keyboard dynamics can control any or all of the following: VCA level, VCA attack, VCF cutoff, VCF attack, and VCF Q.

The keyboard can play up to sixteen notes simultaneously; however, *Emax II can chorus its voices or play in stereo with no loss of polyphony!* Note that like standard analog synthesizers, there is a complete set of modifiers for each note. Therefore, when we refer to the "filter", "LFO" or "VCA," we are really talking about *sixteen* filters, LFOs and VCAs.

Digital processing techniques include:

- Truncation (shortening the beginning and/or the end of the sample)
- Looping the sample (or any portion thereof)
- "Crossfade" looping for smooth, clean loops
- Digitally combining (mixing) two samples
- Sound reversal, as well as sample rate conversion and pitch conversion
- Transform Multiplication™, a powerful new DSP effect
- Splicing two or more samples together (imagine a piano that turns into a voice, that turns into a seagull...)
- Advanced split capabilities and the ability to layer four presets on a single key
- Easy doubling, plus velocity-controlled crossfading and switching between samples
- Individual tuning and attenuation for each sample
- Ultra-flexible, programmable arpeggiation
- 16 track "scratchpad" sequencer

Sounds can be stored on Emax II's built-in hard disk drive, on an external hard disk drive, or on commonly available double-sided, double-density (DSDD) 3.5 inch floppy diskettes (as used with many personal computers). Thanks to sophisticated disk management techniques, it's easy to save, organize, retrieve, rename and catalog various sounds. Perhaps best of all, Emax II is fully compatible with Emax I disks, allowing access to the huge Emax I library already in existence.

For outside world interfacing, the built-in sequencer can sync up to a 24, 48, or 96 pulses-per-quarter note clock or MIDI sync; there's also a complete complement of MIDI functions.

Despite all this flexibility Emax II is nonetheless not that hard to learn...as you will see during the course of this manual.

SEND IN YOUR WARRANTY CARD NOW!

It is vital that you send in your warranty card so that we can notify you of enhancements, new features, and software bugs (nobody's perfect) and cures. Don't miss out: Send it in now!

INSTANT GRATIFICATION!

If you just can't wait another second before hearing the Emax II, we understand. Follow the directions below EXACTLY as given and get ready to hear some great sounds. (Incidentally, in case you make a mistake or run into problems, don't worry. This process is described in greater detail later.)

1. With the Emax II unplugged, patch the rear panel Right & Left, or Right Mono jack to the input of a high quality amplification system. You can also plug stereo headphones directly into the headphone jack.
2. Check that the rear panel voltage selector is set for the correct voltage in your part of the world.
3. Plug the Emax II line cord into an AC outlet.
4. Check that no disk is currently in the drive. If so, or if the disk drive contains cardboard packing materials, push in on the disk eject button towards the bottom of the drive, remove the disks or packing materials, and put them in a safe place.
5. Turn on power; Emax II will do a drive check for a few seconds, then the display will say "Please Insert Disk" if you do not have a hard disk or "Checking SCSI 1, then Booting from SCSI 1" if you *do* have a built-in hard disk.

If you don't have a hard disk, insert one of the diskettes that came with your Emax II into the disk drive. The Emax II will begin loading software from the disk you have placed in the drive.

SELECT DRIVE

6. Press the button labeled **DRIVE SELECT** on the front panel of Emax II. Use the data slider to select "SCSI 0: Floppy", if you want to load a floppy disk; or "SCSI 1 Conner", if you have a built-in hard disk drive. Then, press **ENTER**.

LOAD FROM FLOPPY DISK

7a. Press the **LOAD BANK** button, then simply insert a floppy disk and press **ENTER**.

LOAD FROM HARD DISK

7b. Press the **LOAD BANK** button, then select one of the sound banks using the data slider. When you find one that strikes your fancy, press **ENTER**.

8. Raise the volume slider to the up position.

9. The display will show the name of the Current Preset (we'll talk more about the Current Preset concept later). Turn up the volume control and start playing the keyboard. All right!! The display will show you the ID number (P followed by two digits) and name of the sound you are playing. These sounds are called presets, for reasons which will become clear later.

10. Use the telephone-type numeric keypad underneath the display to call up different presets. Press a two-digit number; start with 01 and play the keyboard for awhile, then press 02 and play, 03, 04, etc. At some point you will run out of factory presets, and the display will say "Empty Preset."

If you want, vary the control wheels towards the left hand side of the keyboard. They may not be active with some presets, as they perform different functions with different presets.

To load another floppy disk, press **LOAD BANK**, and the display will say:

Load All Presets
And Sequences

Insert another floppy disk, then press **ENTER**. Emax II will begin loading the new bank.

Note: Some Emax II banks require two or more floppy diskettes. In this case, simply insert the diskettes in sequential order (1, 2, 3...).

To try out presets from other factory hard disk banks, locate the **LOAD BANK** button (in the group of four buttons to the right of the numeric keypad) and press it. Use the data slider to scroll through the available hard disk banks. When you find a bank that interests you, press the flashing **ENTER** button right below it. The disk drive will start making noises, and a few seconds later you will have loaded another bunch of sounds into the Emax II.

CONNECTION INSTRUCTIONS

CONNECTION TO A MIXER

■ **STEREO:** Emax II has provisions for a variety of output connection schemes. The most common hookup will probably be for stereo operation. Once you have heard the Emax II in stereo, you will never be satisfied with mono again. Connect the left and right audio out phone jacks to the inputs of your mixer or stereo preamp. Emax II will also drive stereo headphones, which can be plugged directly into the headphone output. For maximum dynamic range, keep the front panel volume control turned up full.

■ **MONO:** If a monophonic amplifier is used, simply connect the right/mono output to the input of the amplifier. Guitar amps are not recommended because they are generally noisy and low fidelity. The output level of the Emax II is somewhere between instrument and line level. Care should be taken when connecting to an instrument amplifier so that the delicate nerve cells in your ears are not damaged.

■ **SUBMIX OUTPUTS:** There may be times when different equalization or reverb settings are desired on the various instruments that have been sampled. Emax II has eight polyphonic outputs that can be used when individual processing on specific instruments is desired. Any combination of voices can be programmed to appear at any channel output. Voices are assigned to output channels using the Edit Assignment function in the Preset Definition module or in the Keyboard Mode function of the Dynamic Processing module. Each of the Sub A, Sub B, and Sub C outputs on Emax II are stereo jacks. The tip of each jack (accessed when a standard phone plug is inserted) connects to the right or left output of the group. If a stereo plug is inserted, the Ring of the stereo plug serves as a signal return, which sums into the Main outputs.

Therefore, the Sub A, B, C jacks can serve as effect sends and returns in order to further process selected voices and then return them to the main mix.

The submix send/return jacks can be used to process selected voices and return them to the main mix instead of using the effects bus on your mixing board. In a pinch, the effects returns could also be used to sum additional instruments into the main outputs of the Emax II.

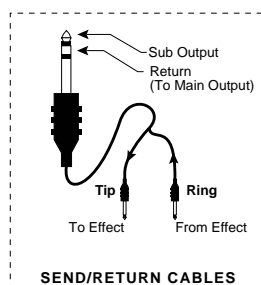

This diagram shows the type of cable used to access the Emax II submix sends and returns.

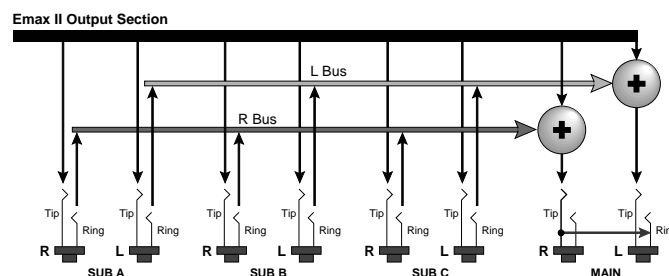

This diagram shows how the stereo jacks are used to function as effect sends and returns.

CONNECTION DIAGRAM

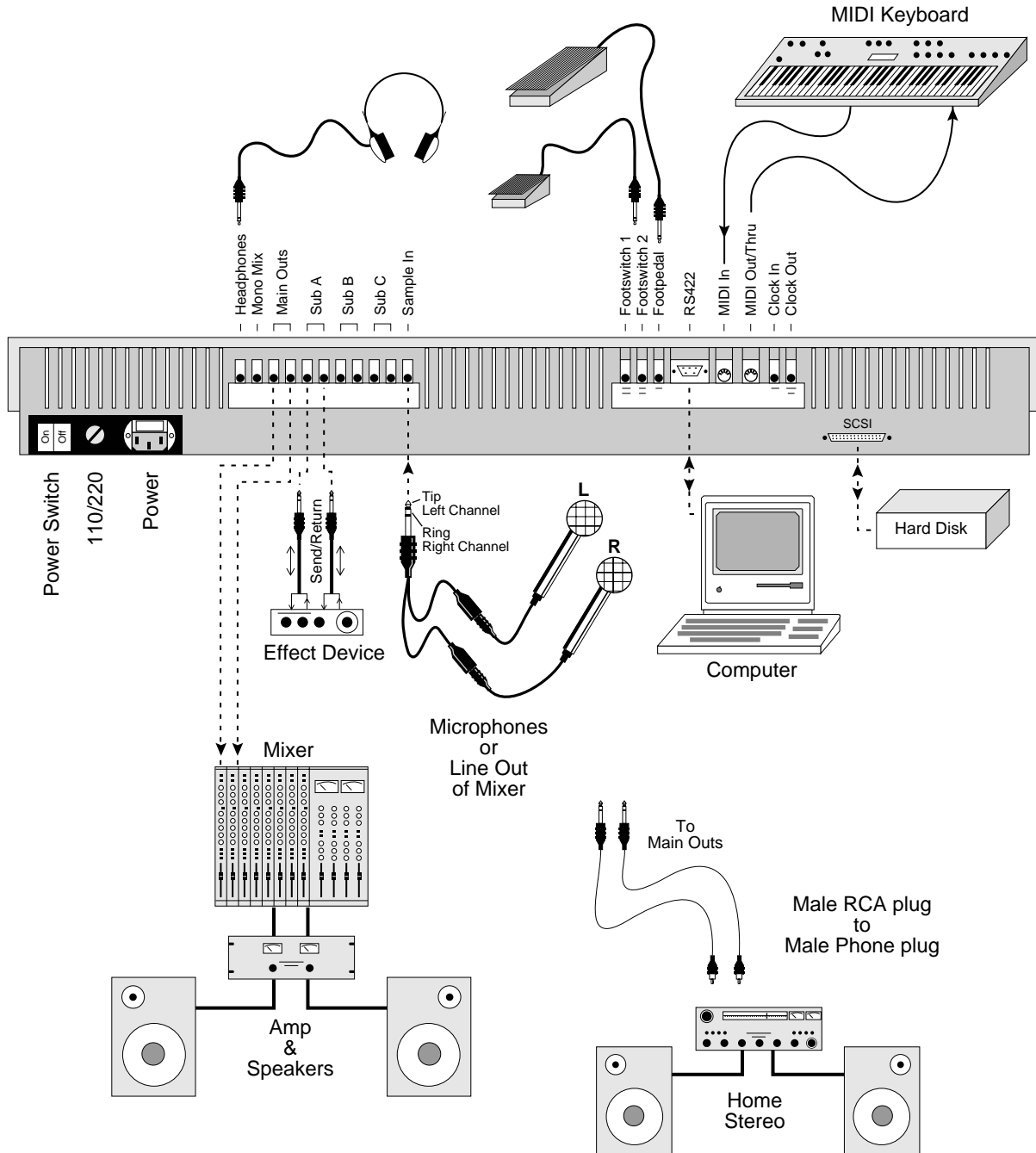

This diagram shows how various pieces of equipment can be interfaced with the Emax II. The connections to the Emax II rack are identical.

SAMPLE IN CONNECTION

The Sample In jack can accept any signal level from microphone level to line level. The gain is adjusted with the data slider while in VU/gain mode in the sample module. The level can be read in the liquid crystal display while in this mode.

If your Emax II contains the stereo sampling option, use a stereo plug in the Sample In jack to sample in stereo. The **Tip** of the stereo plug corresponds to the **Left** channel and the **Ring** of the plug corresponds to the **Right** channel.

MIDI CONNECTION

Emax II provides a MIDI In and a MIDI Out/Thru port.

■ The MIDI In port on the Emax II is connected to the MIDI Out port of an external MIDI controller which could be a keyboard, a sequencer, MIDI drum kit or whatever. Note that the Emax II can only respond to information that your controller transmits. Therefore, if your MIDI keyboard does not have velocity and pressure sensitivity, Emax II will not respond to velocity and pressure.

■ MIDI Out can be connected to another MIDI instrument or sequencer. In MIDI Thru mode, MIDI Out will re-transmit any MIDI information that appears at the MIDI In port. In MIDI Out mode, only information from the Emax II's keyboard, sequencer or realtime controls will be transmitted, except when overflow mode is selected. Overflow mode allows a second Emax II to be connected to the MIDI Out to allow 32 channel operation. **Use cords that have been designed specifically for MIDI.** While regular 5 pin DIN cords may work, they are not shielded correctly for MIDI use and may cause ground loops between equipment.

FOOTSWITCH AND PEDAL CONNECTION

■ Two control footswitch jacks are provided for performance control of sequencer, arpeggiator, sustain, release, X-switch, and preset advance. The footswitches need not be connected for the unit to operate but they offer exciting control possibilities. The footswitches should be of the momentary contact type, but can be either normally-open or normally-closed.

■ The control pedal is used as a realtime control in the same manner as the wheels. It can be programmably routed to a destination by using the realtime control section of the preset definition module. The pedal can either be a voltage type, (which outputs a DC voltage from 0-9 volts at the tip of the jack) or a resistance type (which varies a 10K ohm resistance from the tip to ground of the jack). Both the footswitches and the pedal are available from your dealer.

CLOCK IN CONNECTION

The Clock In jack allows a non-MIDI external device such as a drum machine or sequencer to control the tempo of the sequencer or arpeggiator. Emax II can receive input clock rates of 24, 48, or 96 pulses-per-quarter note. The pulses should be at least 1 millisecond wide and have a level of 1 to 5 volts.

▼ *High level signals should **not** be present at the sample input jack when entering the sample module because the Emax II auto-calibrates the sample inputs during this time.*

CLOCK OUT CONNECTION

The Clock Out jack allows the Emax II to be the master clock and drive non-MIDI sequencers and drum machines at a rate of 24 pulses-per-quarter note. This is a 5 volt pulse which is about 6 milliseconds wide.

SCSI CONNECTION

The 25-pin connector on the rear of your Emax II is a SCSI port (pronounced scuzzy), which stands for Small Computer Systems Interface. SCSI is an ultra high-speed parallel port, normally used to connect external hard disk drives. Up to 7 external devices can be connected to the SCSI port. Each device on the SCSI bus must have its own unique ID number so that Emax II can distinguish it from the other devices. If you have an internal hard disk, it will be assigned ID #1. The floppy drive is assigned ID #0. If there are two devices on the SCSI bus with the same ID number, a SCSI error will result. Consult the operation manual of your external storage device for information on changing the ID number.

■ **Warning:** All SCSI devices connected to the SCSI bus must be turned on, or Emax II will not boot.

- Always use quality SCSI cables which are as short as practical (total length <12 ft).
- Tighten the thumbscrews on the jacks to ensure good electrical connection.
- Power up external SCSI devices *before* the Emax II.
- All SCSI devices on the bus *must* be turned on.

RS-422 CONNECTION

The RS-422 connector is a high-speed *serial* communication port which allows data to be transferred to and from an external computer at a high rate (500K baud). The connection cable to the external computer will generally be supplied with a software package (such as Sound Designer by Digidesign) and will not usually be available from your music dealer.

110V/220 V SELECTOR

The 110V/220V selector allows the Emax II to be used in either 110 volt or 220 volt environments at either 50 Hz or 60 Hz. In the USA, 110 volts is the standard. To change the voltage setting, first UNPLUG the unit; then use a flat blade screwdriver to change the setting. **WARNING:** Operating Emax II at the wrong setting may seriously damage the unit.

AC POWER CONNECTION and FUSE

The AC power connector is how the Emax II gets power (obviously). The fuse receptacle is not as obvious. It is located directly over the power receptacle. Before changing or checking a fuse, UNPLUG the power cord. To remove the fuse holder, squeeze the two tabs located on either side of the fuse holder together. The fuse holder will now pop out with its two fuses. The Emax II uses (2) 1 amp, 250 volt fast-blo mini-fuses. The Emax II should not normally blow fuses. If a fuse that has been replaced blows again, do not attempt another replacement. Have the unit serviced!

EMAX II BASICS

| | |
|-----------------------------|-----------|
| SAMPLING BASICS | 11 |
| THE BANK | 12 |
| SAMPLES & VOICES | 12 |
| MAKING A PRESET | 13 |
| THE CURRENT PRESET | 13 |
| THE CURRENT VOICE | 13 |
| MORE ABOUT VOICES | 14 |
| OTHER DEFINITIONS | 15 |
| THE BIG RE-CAP | 17 |

EMAX II BASICS

HOW EMAX II ORGANIZES SOUND

READ THIS SECTION CAREFULLY OR THE REST OF THE MANUAL WILL NOT MAKE SENSE!!

Throughout this manual we will use the terms and concepts described and defined below. Read through this section carefully, even if you don't retain it all, and refer to this section periodically as you read the manual until you know the meaning of all the following definitions.

SAMPLING BASICS

The Emax II is conceptually like a tape recorder in that it records sound. However, the recording *process* is very different since Emax II records into its computer memory.

Computers can accept information only in the form of numbers, so first Emax II converts audio signals into numbers. It does this by examining (sampling) the incoming signal level at a maximum rate of 39,000 times a second, and sequentially records these different levels in computer memory. The diagram below shows a one-second percussive sound being sampled. The magnified view shows how the samples define the instantaneous level of the signal. Once stored in Emax II's memory bank, these samples may be played back (in the proper sequence, of course) to reconstruct the original signal. If a two-second sound was being sampled, it would require $2 \times 39,000$ or 78,000 samples at the highest sampling rate. Shorter sounds require fewer samples. Note: The sampling rate can be altered for reasons which we will get into later.

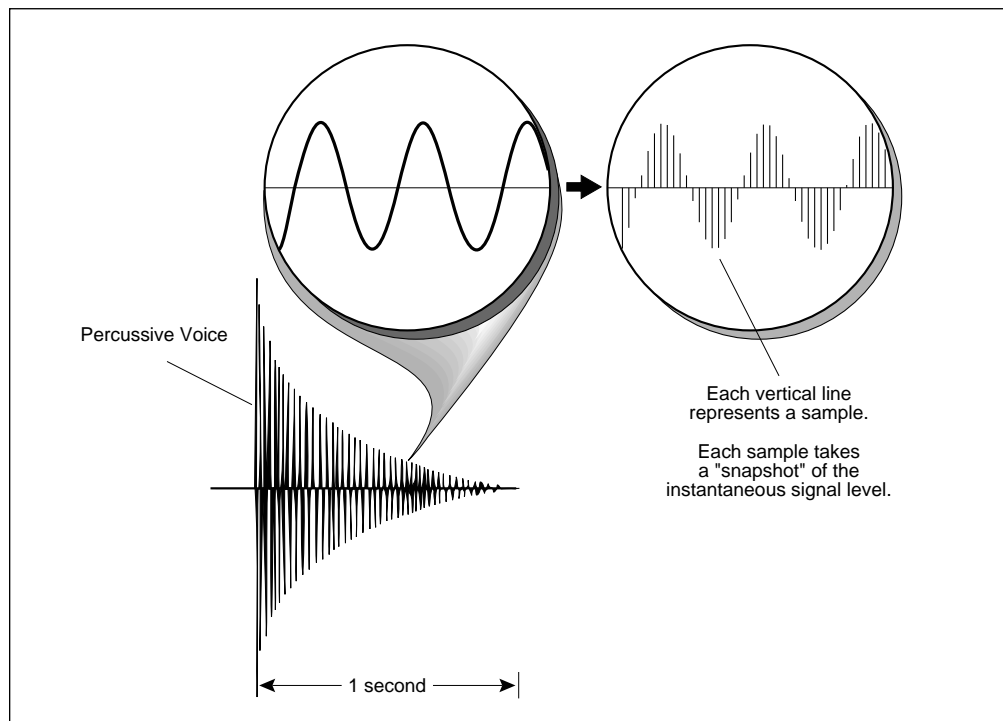

EMAX II BASICS

Just like tape, a sound can be manipulated once it has been recorded. Playing back the samples in the reverse order from which they were stored plays the sound backwards. Playing back the samples at a faster rate than the rate at which they were stored raises pitch; playing back at a slower rate lowers pitch (like a tape recorder's variable speed control).

THE BANK

The bank contains all of Emax II's memory, which includes preset, voice, sample and sequence data. **Consider the bank as the central storehouse for all of Emax II's data.** Although the memory is *volatile*, meaning that the data disappears when you turn off power or load a new bank, the bank data can be saved permanently on disk to keep a record of your work. Since we now have a place to store information temporarily (the bank), and two ways to store information permanently (saving to disk), let's take a look at the different kinds of information being stored.

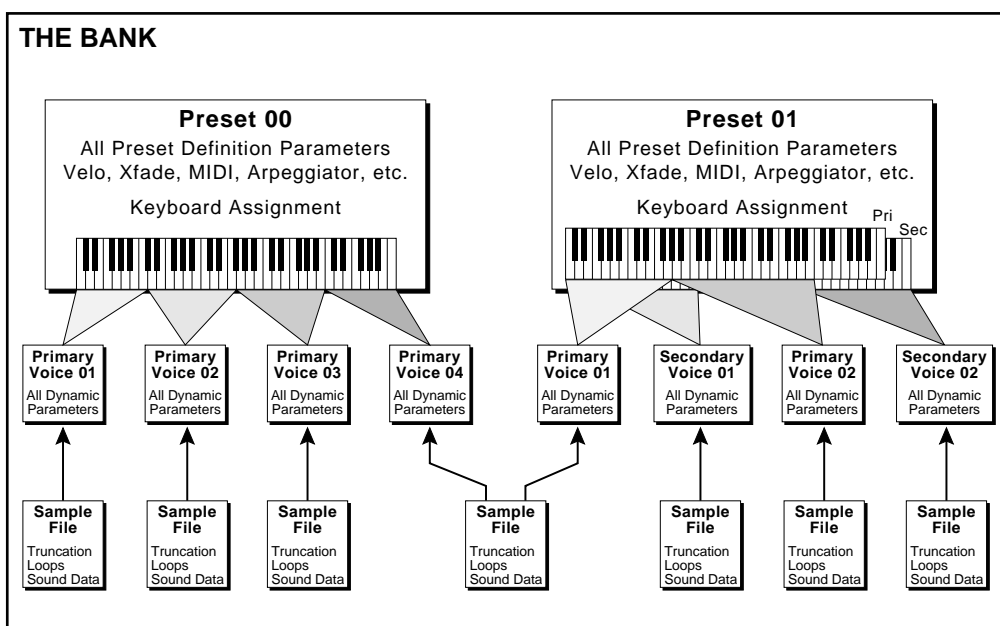

An Emax II bank is **all** the data currently loaded into its memory.
Each preset has its own set of voices which may share sample data with other voices.

SAMPLES and VOICES

Sampling a sound (drum sound, oboe, zither, hamster sneeze or whatever) using the instrument's "Recording Studio" capabilities creates a **Sample**, the "raw material" with which the instrument works. The total available sampling time can be divided up any way you like—one long sample, lots of short samples, a few medium samples, or any combination thereof. Note that a "sample" is a digital recording of a complete sound, or each "snapshot" of the sound that makes up the recording.

EMAX II BASICS

You may process this raw sample via filtering, truncation and so on to create a *Voice*. Individual voices can be saved to disk and loaded from disk as part of a *Preset*. The preset can store up to two voices per key, each identified by a two-digit voice number and the voice's original pitch.

MAKING A "PRESET"

A voice can be assigned to a single note on the keyboard, or transposed polyphonically to cover a wider range of the keyboard. The process of assigning, and optionally transposing, voices to specific ranges of the keyboard is called *Making a Preset*. (Note: It is often necessary to use multiple voices to make up a preset, since wide-range transposition alters the voice's timbre. Therefore, using multiple samples and transposing each over a small range usually gives the most realistic sound). Individual presets, including their voices and samples, can be loaded from disk. Making a preset is a three-step process:

1. Create the preset and give it a number and name. The bank can hold up to 100 presets.
2. Assign voices to different ranges of the keyboard (for example, with five voices you could assign each voice to cover one octave of the keyboard). Note that the same sample can be assigned to more than one range of the keyboard in a given preset. Also, that sample can be assigned to more than one preset.
3. Choose from a number of options that further define the preset, such as assigning voices to partially or fully overlap other voices (thus producing doubling effects), assigning dynamic control to individual voices in a preset, erasing presets you don't like, cataloguing presets, adding arpeggiation, setting up MIDI parameters, etc.

THE CURRENT PRESET

When you load a sound disk, a preset will be ready to play and the display will show the preset number. This is the *Current Preset*. If you select another preset, or create a preset, it will become the current preset.

THE CURRENT VOICE

Voices contained in a preset can be sent to the Dynamic and Digital Processing modules for further alteration. However, since a preset typically contains several voices, we need to specify which voice, or voices, we want to process. This is called *Selecting the Current Voice*, another three-step process.

1. Call up a preset that contains the voice(s) to be processed.
2. Select the range of the keyboard to be processed. This will automatically select the voice, or voices, that fall within the specified range (a group of voices being processed simultaneously is still referred to as the "current voice").

EMAX II BASICS

■ On an Emax II with the Stereo Sampling option, the Left channel will correspond to the Primary Voice and the Right channel will correspond to the Secondary Voice.

3. You may send the current voice through the Dynamic and Digital Processing modules, whereupon they return back to the bank in their modified form.

MORE ABOUT VOICES: THE PRIMARY AND SECONDARY VOICE

An Emax II key can contain up to two “channels.” These two channels contain the *Primary and Secondary* voices. For example, the primary voice might be a guitar note, and the secondary voice a detuned version of the same guitar note. When they are played together, you hear chorusing. Also, a preset contains information about how the keyboard dynamics affect the primary and secondary voices. For example, the primary voice could be that of a drum hit played softly, and the secondary of a drum hit played loudly. You could then set up the keyboard so that playing the keyboard softly plays the primary voice, and playing the keyboard more forcefully plays the secondary voice.

MODULE

A *Module* controls a particular section of the Emax II. There are six main modules (see the labels to the right of the 12 main pushbuttons) and a sequencer module that has six sub-modules (see the labels to the left of the 12 main pushbuttons).

FUNCTION

Each module contains individual numbered *Functions*. Example: function 2 in the **MASTER** module checks the amount of memory remaining.

ACTIVATING A MODULE

To work with a module, you must first *activate* it. Press the button associated with the desired module. The display will then show the *Module Identifier*.

THE MODULE IDENTIFIER

When you activate a module, the display identifies which module you have activated, and how many functions are available.

There are two ways to select a function within the module. Those just getting started can move the data slider until the display shows the desired function, then press **ENTER**. As you work with the Emax II, though, you will start to memorize the function numbers and will probably find it faster to simply key in the appropriate function number using the numeric keypad.

Example: if the manual says to “activate **MASTER 2**,” you would first press the **MASTER** main pushbutton. Then, either key in **2** using the numeric keypad, or move the slider until the display shows function **2** and press **ENTER**.

Note: If a module is already active, and you are finished with one function, you do not need to re-activate the module—just key in the new function number.

EMAX II BASICS

FLOPPY DISK DRIVE

The floppy disk drive (mounted on the left-front of the unit), allows you to transfer sounds and sequences in and out of the Emax II and allows you to “back-up” your precious work permanently.

HARD DISK DRIVE

Why hard disks? There are two big advantages to using a hard disk over floppy disks.

- Greater storage. The hard disk can hold many banks; the floppy, half a bank or less.
- Faster access time. A 1 Megabyte bank can be saved from the Emax II to the hard disk in 12 seconds (as opposed to 2 minutes for saving to floppy), or loaded from the hard disk to the Emax in 6 seconds (as opposed to 50 seconds from a floppy). In most cases, you can treat the hard disk like a super-floppy; transferring data to and from the Emax II is straightforward.

SCSI

SCSI (pronounced skuzzy) stands for Small Computer System Interface. SCSI is an industry standard hardware and software specification that allows high-speed data transfers between different pieces of equipment. SCSI devices can include hard disks, tape drives, optical disks and other types of digital equipment. Why use SCSI? SCSI is *FAST!* SCSI is a parallel interface which transmits 8-bits of information at a time at high speed. MIDI in comparison, is a serial interface which can only transmit 1-bit at a time.

- Each device on the SCSI bus has its own ID number so that it can distinguish its data from data meant for another device. *Each SCSI device must have its own unique ID number.* Most SCSI devices have hardware defined ID numbers. This means that there is a little switch somewhere on the device to change the ID number.
- Keep SCSI cable lengths as short as possible. Data errors may occur with long cables.

VELOCITY-SENSITIVE KEYBOARD

A velocity-sensitive keyboard measures how long it takes for a key to go from the key up to key down position, and uses this data to control dynamics. If it takes a long time for the key to reach the key down position, it is assumed you are playing that key less forcefully (minimum dynamics). If the key goes to the key down position almost instantaneously, it is assumed that you are playing the key more forcefully (maximum dynamics). In this manual, we will refer to playing the keyboard “harder” or “softer,” even though technically speaking the keyboard is reacting to speed of key position change, not force.

PRESSURE-SENSITIVE KEYBOARD

A pressure-sensitive (also called aftertouch) keyboard responds to pressure applied to a key after it is down. This pressure data is typically used to control vibrato amount, pitch-bending, and so on after the key is down. Emax II can respond to pressure when an external keyboard with pressure sensitivity is controlling the Emax II via MIDI.

EMAX II BASICS

OTHER DEFINITIONS

The Disk Archives

So far, we've loaded a bunch of voices into the bank, created some presets containing those voices, and done some voice processing. However, *remember that the bank only retains this information for as long as the Emax II is plugged in and turned on.* Of course, we don't expect you to leave the thing on all the time, which brings us to the subject of saving data on disks.

Commanding the central computer to "Save All 16-bit" (**PRESET MANAGEMENT 8**) shuttles all the bank data (voices, presets, and sequences) to disk. This disk permanently (well, at least as long as the disk lasts) stores data so that even after turning off the Emax II, the disk will contain a record of your work.

■ Emax II also allows you to save your work in an Emax I format. This process uses a data compression process to squeeze more data onto a disk. A 1 megabyte Emax II bank, when compressed, may be stored on a single floppy disk. In many cases the compressed data will be audibly indistinguishable from the 16-bit version.

IF YOU DO NOT DO A "SAVE ALL", ALL BANK DATA WILL BE LOST WHEN YOU TURN OFF EMAX II.

Do not wait until the end of a session to save—save your work (**PRESET MANAGEMENT 8**) periodically in case of power failure or some other unforeseen circumstance which might erase the bank's memory.

Since the disk (hard disk or floppy) contains a record of the bank data, loading the disk back into the bank transfers all the voice, preset, and sequencer data into the bank (this will replace the existing bank data, if any). Therefore, you can work a bank of sounds out at leisure, and save the results of your work on disk; when you go to a gig, simply load all your hard work from disk into the Emax II in a few seconds.

■ *The Emax II will not boot up unless all devices on the SCSI bus are turned on.*

The Keyboard

The LFO, VCA, VCF and AHDSR analog signal processors are tied to keyboard dynamics (for example, playing harder can alter the loudness, attack time, filter cutoff, etc.), as are some preset assignment characteristics (i.e. playing louder assigns a different voice to a particular key).

Booting

Booting Emax II is not a repair technique; rather, it is a computer term that means "having the computer read software necessary for its operation from the disk" (It's easy to see why this was shortened to "booting"). Emax II automatically "boots" itself when you turn it on. Once booted, the instrument is ready to go.

Default

A default setting is what we've judged to be a useful initial setting, and remains in effect until you change it. For example, the arpeggiator defaults to off when a new preset is created. Had it defaulted to the on position, new presets would all be arpeggiated!

EMAX II BASICS

Cursor

The cursor is a small line that shows up in the display, and flashes when it wants data from you about the number or letter under which it is located. Entering a new value will over-write the old one, whereupon the cursor moves on to the next number or letter (if applicable). Note: If the Emax II is expecting a two or three-digit number, in most cases you must enter all the required digits even if some of these are zeroes (called "leading zeroes"). For example, if Emax is expecting a two-digit number and you want to enter 8, you would enter **08**. If it is expecting a single-digit number, entering **8** would be sufficient.

Data Slider & Increment/Decrement

On virtually all Emax II menus where the data slider selects options, the Increment (**ON/YES**) and Decrement (**OFF/NO**) switches duplicate the slider function.

Saving

We can't emphasize this enough. **Whenever you have done enough work on a preset, voice, sample or sequence that you would hate to lose it, save it.** Hard disks are not infallible. All hard disk banks should be backed-up on floppy disk. Should you improve the preset, voice, sample or sequence later, you can always replace the original with the revised version — and if something goes wrong, the original will still be available to save you the hassle of starting from scratch.

THE BIG RE-CAP

One more time: A *Sample* is a raw sound, that upon being recorded into the *Bank* immediately becomes a *Voice*.

To create a new *Preset*, make sure you have all the voices required for the preset in the bank, number and name a preset, then assign combinations of voices from the bank to specific sections of the keyboard. By specifying one or more of these voices as the *Current Voice*, the current voice may then be processed by Emax II's dynamic and digital signal processors.

Since loading in a disk fills the bank with voices and presets, you can group these voices into new presets, process the voices or alter the existing presets.

THE REWARD

If you've assimilated this information, the rest of the manual should be fairly easy to understand. If not, re-read the previous information again. If it still doesn't make sense, plunge right into the Guided Tours - as you actually work with the Emax II, all of the above definitions will make sense as you relate theory to practice.

GUIDED TOURS

| | |
|--|-----------|
| <i>Guided Tour No. 1</i> | 21 |
| <i>Meet the Emax II</i> | |
| <i>Guided Tour No. 2</i> | 25 |
| <i>Specifying the "Current Voice"</i> | |
| <i>Guided Tour No. 3</i> | 27 |
| <i>Dynamic Processing of a Voice</i> | |
| <i>Guided Tour No. 4</i> | 31 |
| <i>Realtime Control Programming</i> | |
| <i>Guided Tour No. 5</i> | 33 |
| <i>Basic Sampling</i> | |
| <i>Guided Tour No. 6</i> | 35 |
| <i>Digitally Processing Samples</i> | |
| <i>Guided Tour No. 7</i> | 38 |
| <i>Managing the Bank</i> | |
| <i>Guided Tour No. 8</i> | 38 |
| <i>The Sequencer</i> | |
| <i>Guided Tour No. 9</i> | 39 |
| <i>Make Your Own</i> | |

GUIDED TOURS

GUIDED TOUR #1: MEET THE EMAX II

Welcome to the Guided Tours! If you have just met Emax II for the first time, follow these tours until you complete the Guided Tours section. This will get you “up and running” on the Emax II in the fastest possible time. Also, you’ll learn some tricks in this section that will come in handy as you play some more with the Emax II.

This tour covers how to...

- Get ready for the tours
- Load a bank from the hard disk
- Select different presets within the bank
- Load a floppy disk
- Tune the Emax II to other instruments
- Transpose the keyboard

...and also discusses Emax II’s “modular” design philosophy.

HOW TO USE THE GUIDED TOURS

Please follow all steps exactly as given. For example, if we ask you to load the Arco Strings disk, even if you would really rather hear something else load in the strings—several sections of the tour will refer to specific sounds on that disk.

Occasionally during a tour you will be told to refer to something like **PRESET DEFINITION 4**, **SAMPLE 2**, or some other name. This means that you will find more information in the specified section of the manual’s reference section. For example, **PRESET DEFINITION 4** indicates that the information is in the preset definition chapter under section 4; **SAMPLE 2** indicates that the information is in the sample chapter under section 2.

GETTING READY FOR THE GUIDED TOURS

Have you sent in your warranty card yet? Listen, we’re not kidding! Send it in!! Okay. Now you can proceed.

Set up the Emax II as described in the Introduction under **Instant Gratification**. After completing step 5, return to this section.

LOADING FLOPPY DISKS

So far, so good...now it’s time to move on.

1. Press the button labeled **DRIVE SELECT** and use the data slider to select, SCSI 0: Floppy.

GUIDED TOURS

2. Select the Arco Strings disk (4 M Emax IIs- Piano & Strings) , and insert it in the drive.
3. Press the button labeled **LOAD BANK**. The display will say:

Load All Presets
and Sequences

4. Press **ENTER** to load the floppy disk. Remember that loading in a new bank will erase the currently loaded bank, so always think twice before pressing Enter to load the bank.
5. Play the sounds from the newly-loaded disk, then move on to the next section.

LOADING A BANK FROM THE HARD DISK

If you are using an external hard disk, make sure that it is correctly connected (Connection Instructions) and formatted (**MASTER 5**) for the Emax II.

1. Press the button labeled **DRIVE SELECT** and use the data slider to locate the hard disk. Hard disk drives may use SCSI ID numbers 1-7.
2. Press the **LOAD BANK** button; the display says: Load Bank, and shows the name and number of the current bank. Use the data slider to scroll through the available hard disk banks. Stop when you find the bank labeled Arco Strings (4 M Emax IIs- Piano & Strings), then press **ENTER**.

■ An alternate method of loading a hard disk bank is to press **LOAD BANK**, then simply type in the number of the bank using the numeric keypad.

The display will show the current preset number and name (the cursor will flash underneath the first digit). Start playing the keyboard and adjust the Volume slider for a comfortable listening level.

SELECTING DIFFERENT PRESETS

1. The bank you just loaded contains several presets. To call up a new current preset, use the keypad underneath the display. Note that "leading zeroes" must be entered for preset numbers (i.e. type 0 and 0, not just 0, to call up preset 00). Now type 0 then 0 on the keypad; these will replace the numbers indicated by the flashing cursor.
2. The display says P00. Play the keyboard... hey, check out those sounds!
3. Now call up more presets (refer to **GENERAL INSTRUCTIONS 1**, "Selecting the Current Preset,"). If you enter a number for which there is no preset, the display will list the entered preset number and say "Empty Preset"; try again.

GUIDED TOURS

4. To scroll through the presets available in the bank, move the data slider. The various preset names will scroll on the lower display line. When this line shows the desired preset, press **ENTER** to make that the current preset. This is an alternative preset selection method.

5. Increment or decrement the current preset (as displayed in the top line) with the **CURSOR** buttons. This method is useful for live performance—arrange your presets in the desired order, and step through them as needed.

When you're ready to check out some more sounds, proceed.

THE EMAX II "MODULAR" SYSTEM

The left side of the Emax II front panel includes the volume, data slider, **ON/YES** and **OFF/NO** (Increment and Decrement) buttons, the Liquid Crystal Display, two cursor control buttons, and a numeric keypad. Once you select a module and function, this area is where you will specify parameters.

The *modules* start towards the right of the keypad. Each module will be discussed in detail later on; the following is intended mostly as background information. Each module affects a certain area of Emax II's operation.

■ **Function Buttons** These are the buttons that get you going. Load Bank and Enter load disk data into the Emax II, Drive Select selects which disk drive will be used, and Transpose, as you probably suspect, transposes the keyboard.

■ **Sequencer** This module is a 16-track solid state control data recorder. While optimized for downloading MIDI data from other sequencers, it has some very useful features such as Mono operation when driven via MIDI, ability to re-assign presets, track bounce, and so on. It consists of the Sequencer Setup module (which sets up a sequence for recording) and the Sequencer Manage module (which lets you load, erase, copy, and do other sequence "housekeeping"). All sequencer functions are controlled by the left-hand column of buttons.

■ **Master** This module contains functions that affect the overall keyboard or bank (memory remaining, keyboard velocity curve, master tune, erase all and format disk). This also contains the Special commands, which are explained in the Reference section.

■ **Sample** This "recording studio" module records sounds from the outside world into the bank. Features include adjustable preamp gain, variable threshold setting, and adjustable sample rate and length.

■ **Digital Processing** With this powerful module, you may edit a voice's length, loop (i.e. infinitely sustain) any portion of the voice (with several different looping options), have Emax II automatically find the best loop points ("Autoloop"), splice two different voices together, mix two voices, amplify or attenuate the voice, and more.

GUIDED TOURS

■ **Preset Management** This module handles the preset “housekeeping”—load presets from disk, save presets to disk, create, copy, rename, or erase presets, and check on how much memory space a preset uses up.

■ **Preset Definition** This module lets you change parameters within a given preset. Set up the arpeggiator or MIDI options, assign the pitch bend and modulation wheels to control various parameters in real time, copy or erase voices, edit the voice assignment, choose Stereo Voice mode (more on this later), and set some keyboard parameters (dynamics and crossfade between overlapping voices).

■ **Dynamic Processing** This module sets parameters that should be familiar to those who have worked with analog synthesizers. Set the dynamics by adjusting the VCA envelope, control timbre using the VCF (filter) and its associated AHDSR envelope generator, modulate the signal with the LFO, tie the keyboard velocity to various parameters, set the tuning, attenuation, and delay for each voice, and more.

Remember—if you want to save modified voices or presets, save the altered bank to disk. Otherwise, any changes will be lost as soon as power to the Emax II is interrupted.

ACTIVATING A MODULE, SELECTING FUNCTIONS, DE-ACTIVATING A MODULE

Here’s important background information on how to access the various module functions. As the tours progress, we’ll relate this information to practical examples.

■ **Activating** Each module has an associated switch. Most of these are found in the right-most series of blue buttons, however, the Sequencer Setup and Sequencer Manage module buttons are found in the green column of Sequencer-related buttons. Pushing the associated switch “activates” the module, as indicated by an LED next to the switch lighting up. Upon activation, the display’s top line will show the Module Identifier (such as “Master,” “Preset Management,” etc.). In some cases, upon activation the display will ask you to specify the current voice (as described in the next Guided Tour). Once the module is active, it’s time to start...

■ **Selecting functions** Each module includes a printed list of functions on the front panel; these functions are available when the module is active. Selecting a module function requires keying in its associated number with the keypad. We will shortly give an example of how this all works.

■ **De-activating** When you’re finished with the module, either press its button again to de-activate, or simply activate a new module.

■ *Any time you make a mistake, get confused, or get lost in the module, simply de-activate the module. Then, re-activate and try again.*

GUIDED TOURS

TUNING THE EMAX II TO OTHER INSTRUMENTS

Refer to **MASTER 1**. This function demonstrates how Emax II uses the data slider to adjust a parameter (in this case, overall tuning).

TRANSPOSING THE KEYBOARD

Refer to **FUNCTION, TRANSPOSE** and follow the instructions.

GUIDED TOUR #2: SPECIFYING THE “CURRENT VOICE”

BACKGROUND

Emax II has two modules dedicated exclusively to processing voices within a preset: **DIGITAL PROCESSING** and **DYNAMIC PROCESSING**. *Each voice* stored in a bank can be processed independently (or groups of voices may be processed simultaneously if desired). Therefore, we need a way to specify the *Current Voice*, which is the individual voice (or collection of individual voices) to be processed.

The concept of the *Current Voice* is important. To process one voice out of a preset, assign the current voice to be that one voice, and process it. To process more than one voice at a time, specify a group of voices to be the current voice and process all voices simultaneously.

This section covers how to identify which keyboard keys belong to which voice, and how to specify which voices or voices make up the current voice. For a short form version of this tour, see **DYNAMIC PROCESSING 00** and **DIGITAL PROCESSING 0**.

Begin this tour by loading Arco Strings (Piano & Strings) into the bank. Also, read the section **FUNCTION, ENTER DATA** as the **ENTER** button will be used frequently during this and most subsequent tours.

IDENTIFYING WHICH KEYBOARD KEYS BELONG TO WHICH VOICE

1. Once the Arco Strings (Piano & Strings) bank is loaded, the display should show 00 as the current preset. Select preset #10 - Demo Strings, then activate the Dynamic Processing module. Its LED will light after a second. If a current voice has not been previously selected (it shouldn't have if you just loaded in the disk), the display will say:

Lo:A-1
Select Lo Voice

GUIDED TOURS

If this is the case, move on to step 2. If a current voice has been previously assigned, the display's top line will give the module identifier. If this is the case, before proceeding to step 2 initiate the **CHANGE CURRENT VOICE** function by keying in **00**.

Note: that if the preset contains primary and secondary voices, the display will ask whether you want to process the primary, secondary, or both voices (**GENERAL INSTRUCTIONS 2**). With this preset, however, there are only primary voices. Emax II is a smart little critter, so it won't ask you to select between primary and secondary voices unless both types of voices are present.

2. Play the keyboard, starting at the lowest note. The upper display line will show the note you're playing, while the lower display line will show the voice number and its original pitch (in this case, 01 and F#0). The original pitch is the pitch of the sample itself. See **GENERAL INSTRUCTIONS 3** for details on the keyboard numbering protocol.

■ The data slider may also be used to quickly find all the voices assigned to the keyboard.

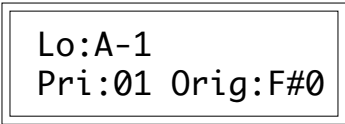

This lower display line remains as is until you play the first A. From this, we can conclude that voice 01's original pitch is F#0, and that it was transposed to cover the range from A-1 to G#0.

If there were both primary and secondary voices present, the display might look something like this:

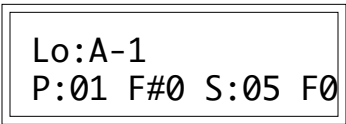

Play ascending keys, one at a time, over the full range of the keyboard. The display will give the voice number and the original pitch. Take a minute or two and note where the various voices begin and end, and which voices are at which locations on the keyboard. They should be as follows, with the original keys indicated by the numbered arrows:

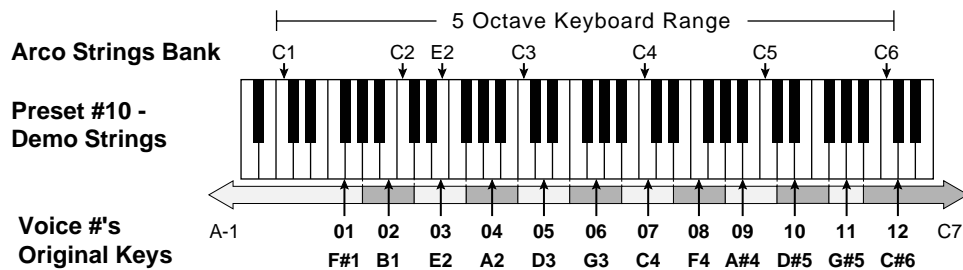

GUIDED TOURS

SPECIFYING THE DYNAMIC PROCESSING MODULE CURRENT VOICE

Now that we know how many voices there are in the preset, and the range covered by each voice, let's specify a range of voices to be altered by the Dynamic Processing module, starting with the lowest voice. This will become the lowest part of the current voice.

1. Press a key in the lowest voice of the range you want to process. For this exercise, press E2. When the upper display line confirms your choice, press **ENTER**. Since E2 is located within voice 03, that voice becomes the lowest voice of the current voice. Note that you could have pressed any key within voice 03 to specify that voice.

2. The display now shows the highest note of the voice in which E2 resides. Don't press **ENTER** yet—but if you did, this highest note would set the upper limit of the current voice. Instead, let's make the current voice cover a somewhat wider range. Press C4 (the display will show this as the new high note) and press **ENTER**. As with selecting the lowest voice, selecting any key within the highest voice makes that voice the upper range of the current voice. Thus, the current voice now extends from V03 to V07, and covers the range from D2 to D4.

3. You will now see the module identifier, which means you're ready to start modifying the sounds in the bank with the Dynamic Processing module, the subject of the next tour.

4. The assigned current voice will remain as is until you either change the current voice assignment, change presets, or load another bank. If you switch between modules, the current voice remains as assigned (unless you select the Digital Processing module, which will be a subject of a later tour).

5. Before proceeding, look over **DYNAMIC PROCESSING 00** to help reinforce what you've learned. Now that you know what a current voice is and how to specify it, we've reached the end of this tour (although you may need to come back from time to time to refresh your memory). In the next tour, we'll see how to modify voices with the Dynamic Processing section.

GUIDED TOUR #3: DYNAMIC PROCESSING OF A VOICE

BACKGROUND

The Dynamic Processing module consists of several sound processing functions. Let's start with the Filter and VCA sections, as they are among the most important.

Make sure you have loaded in the Arco Strings (Piano & Strings) bank and selected the current voice as specified in Guided Tour #2 before proceeding. The display should show the Dynamic Processing module identifier. If not, repeat Guided Tour #2.

GUIDED TOURS

WORKING WITH THE FILTER

You could activate the Filter Setup function directly by keying in 13. However, let's investigate another way to select the Filter function. Move the data slider to catalog the various Dynamic Processing functions. When the display shows function 13, **Filter Setup**, press **ENTER**.

CHANGING FILTER CUTOFF FREQUENCY

1. Refer to **DYNAMIC PROCESSING 13**. The display should look like the one in Step 1 of **DYNAMIC PROCESSING 13**.
2. Play with the cursor buttons (the left and right arrow buttons directly below the display). Note how you can move the cursor under the various parameters to be adjusted. For now, move the cursor under Fc.
3. Vary the data slider. Note how the numbers under Fc change. Lower numbers mean a lower filter cutoff frequency (less high frequencies). Higher numbers mean a higher filter cutoff frequency (more high frequencies). Observe how only the notes within the current voice are affected by the slider setting.

Note: You must re-trigger a note to hear any changes. Holding down a note and playing the slider will not change the sound; you must play a note after changing the slider to hear the results of changing the slider. This is true when making any changes to the sound, not just while you're in the Filter function or the Dynamic Processing module.

By the way, now might be a good time to mention that although we are changing the sounds in the bank, the sounds on the disk remain unchanged. This is because we haven't saved the bank to disk. Thus, you can fool around with the bank sounds as much as you want without having to worry about altering the original sounds on the disk.

CHANGING FILTER Q

1. Move the cursor under Q on the display. Vary the slider to change the sharpness of the sound; higher numbers give a sharper sound. Again, this affects only the range of notes covered by the current voice. Leave the Q at about 90 and proceed.
2. Move the cursor back to Fc and vary the data slider. Note how this produces a sort of wa-wa effect (remember, you have to re-trigger the key to hear the results of changing the Q).
3. Now set Fc and Q to about 50. The range of notes covered by the current voice should sound muted.

CHANGING THE FILTER CUTOFF ENVELOPE

1. Let's investigate the effects of envelope control over the filtered sound. Move the cursor under Env and use the slider to set a value of +40. This allows the envelope to control the filter cutoff frequency. (See **DYNAMIC PROCESSING 14.**)

GUIDED TOURS

2. Now we need to change over to **DYNAMIC PROCESSING 14**. Press **ENTER** to exit from the current function (see **GENERAL INSTRUCTIONS 3**), and the display will show the module identifier.

3. Key in 14 to select the filter envelope parameters.

4. Move the cursor under A and vary the slider. With larger values, it will take more attack time for the filter frequency to go from lowest to highest cutoff frequency. Refer to **DYNAMIC PROCESSING 14**, vary the various envelope parameters, and observe the effect these changes have on the sound.

5. Now let's check out inverted envelopes. Set the envelope parameters as follows:

| | | | | | |
|----|----|----|----|----|----|
| F: | A | H | D | S | R |
| | 01 | 01 | 07 | 01 | 01 |

... and play and hold a chord. This is a non-inverting envelope in the sense that the envelope increases the filter cutoff frequency above the initial cutoff. To select an inverting envelope, where the cutoff decreases below the initial cutoff, exit Function 14 by pressing **ENTER** (this puts you back at the module identifier), then key in 13.

6. We're back at the familiar Filter Setup screen. Move the cursor under Env and select -40 to invert the envelope. Note that the envelope effect is not all that noticeable when you play a chord. This is because the envelope forces the cutoff frequency in a negative direction, and since the cutoff frequency is already fairly low, it can't go that much lower.

7. Now move the cursor under Fc and increase the cutoff frequency to around 90 or 100. The effect will be far more noticeable since there will be more range available for the negative-going envelope excursion.

8. If you feel like experimenting, play with the Trk control to affect the way the filter frequency tracks the keyboard pitch (see **DYNAMIC PROCESSING 13**).

9. Before proceeding with the Tour, set Fc=100, Q=00, Env=+00, and Trk=1.00. Set the envelope to A=01, H=01, D=01, S=32, and R=05 (**DYNAMIC PROCESSING 14**). After entering these values, press **ENTER** to return to the module identifier.

FUN WITH VCAS

1. In preparation for the following experiments, let's change the current voice to include the entire keyboard. Enter 00, then press Enter twice. You have now selected the entire keyboard.

GUIDED TOURS

■ Pressing the **Enter** button twice in succession will also select all voices.

2. Now key in 12 to select the VCA function. Referring to **DYNAMIC PROCESSING 12**, move the cursor under the various envelope parameters and see how different settings affect the sound.

3. Before moving on, make sure you have a sound that is fairly sustained with little or no envelope attack time.

OTHER DYNAMIC PROCESSING OPTIONS

1. Key in 11, refer to **DYNAMIC PROCESSING 11**, and note how the controls affect the sound.

2. Let's add some LFO effects. Key in 16 and position the cursor under each display option. Vary the data slider and observe how this affects the sound. Note that adding LFO to Fc might not sound all that noticeable; if you want a more obvious effect, bounce back to function 13 and set Fc to about 50 and Q to about 50. This should make the LFO's effect more noticeable.

3. If the LFO settings aren't to your liking, then key in 15 to change the LFO rate, delay and variation (as explained in **DYNAMIC PROCESSING 15**).

UNDERSTANDING VELOCITY

1. By now you might have a pretty messy sound due to all those exercises. Let's start with a clean slate. Press function button **LOAD BANK** and then **ENTER** to re-load the disk. Select preset 10 as the current preset. Press the **DYNAMIC PROCESSING** button.

2. Let's make the entire keyboard the current voice. Press the **DYNAMIC PROCESSING** button again, which selects the entire keyboard.

3. Key in 17, and read over **DYNAMIC PROCESSING 17**. The velocity to level setting should be 06; move the slider to select different values, and note the effects. Emax II plays softer as you play softer. In other words, Emax II equates harder play with the nominal volume setting and goes down from there as you play softer.

4. Move the cursor under the other available parameters and vary the slider. Notice that the filter cutoff frequency lowers as you play softer. The amount of downward change is dependent on the value in the display.

Filter Q is affected differently than level or filter cutoff. It raises from the initial setting as you play harder. Also, note that velocity can be set to affect Q inversely—in other words, if the filter is set to a high Q setting, playing harder on the keyboard will lower the Q.

5. After you've had enough of function 17, key in 18. Here the velocity affects the VCA and filter envelope attacks, as well as panning. Refer to **DYNAMIC PROCESSING 18** as

GUIDED TOURS

you experiment with different settings. Remember that the velocity-to-envelope attack setting interacts with the initial envelope attack settings; if you don't take our word for it, then by all means call up the envelope attack parameters for the filter and VCA and see how different values interact with different velocity values.

MORE DYNAMIC PROCESSING...

Read over **DYNAMIC PROCESSING** sections 19, 20, and 21. If any of these interest you, use the knowledge you've gained in this tour to try out these functions on various presets.

GUIDED TOUR #4: REALTIME CONTROL PROGRAMMING

BACKGROUND

Ever wanted to add vibrato to a grand piano? Or bend its pitch? The Realtime Control module can do this, and lots more. Begin this Tour by re-loading Arco Strings (Piano & Strings), then select Preset 10 (Demo Strings).

PITCH-BENDING

First, let's check out pitch-bending. Play middle C and rotate the pitch bend wheel. Hmm...no pitch bend. Now play A5, and there will be pitch bend. Check further, and you'll see that pitch-bending affects only the range from A#3 to C7. This is because pitch bend can be enabled for any voice or voices within a preset. In this case, pitch bend was only enabled for the voices that span from A#3 to C7 (voices 07-12).

Let's have pitch bend affect the entire keyboard. Key in **DYNAMIC PROCESSING 22** and select the entire keyboard as the current voice (surely you know how to do this by now, so we'll spare you the details). Move the cursor, and you'll see a list of modulation destinations. Pitch will be set to **ON**. Press **YES**, and like magic, you can now pitch bend the entire current voice.

The important point of all this is that if modulation does not seem to affect a voice, *make sure that modulation is enabled*. Now read **DYNAMIC PROCESSING 22** for more information. Want to change the pitch bend range? De-activate the Dynamic Processing module, activate Preset Definition, and refer to **PRESET DEFINITION 8**.

CHANGING MODULATION WHEEL DESTINATIONS

Note: Emax II offers two vibrato options: Pre-programmed (which adds a constant, selectable amount of vibrato), and realtime (where the player adds in vibrato by using one of the wheels).

GUIDED TOURS

Each Emax II wheel can be assigned to a particular destination. For example, if the left wheel is assigned to pitch, then rotating the wheel bends pitch. If assigned to the filter, rotating the wheel varies the cutoff frequency.

Let's set up for the next part of the tour. Choose Preset 01 as the current preset if it is not already. Activate **DYNAMIC PROCESSING**, assign the entire keyboard as the current voice if necessary, then key in 22. Press the cursor buttons and press **YES** for all the enable options. This will make it easier to hear the results of the next series of experiments.

Now activate **PRESET DEFINITION** and key in 9. To make "live" playing as simple as possible, the display works somewhat differently for this module. The display shows eight pairs of numbers:

| | | | |
|-----|-----|-----|-----|
| 1:1 | 2:4 | 3:0 | 4:0 |
| 5:0 | 6:0 | 7:3 | 8:6 |

The first number of each pair stands for one of the eight possible control sources (the left-hand column of functions printed on the top panel under **Preset Definition 9**), namely:

- 1:** Left wheel (center detent, spring return type)
- 2:** Right wheel (continuously variable type)
- 3:** Pressure (from external MIDI controller)
- 4:** Control voltage pedal (plugs into rear panel PEDAL jack; also accepts any 0 to +10V control voltage source)
- 5:** MIDI control A (can be assigned to any MIDI controller #)
- 6:** MIDI control B (can be assigned to any MIDI controller #)
- 7:** Footswitch 1 (plugs into rear panel FOOT SWITCH 1 jack)
- 8:** Footswitch 2 (plugs into rear panel FOOT SWITCH 2 jack)

The second number of the pair represents a control destination (the right-hand column of functions printed in the module) which you assign to a control source.

Each of the destinations printed in the upper right-hand column (0-9) can be controlled by control source 1, 2, 3, or 4, or via data sent over MIDI. For more information on MIDI, see **PRESET DEFINITION 7** ("MIDI Setup") and the Advanced Applications section of this manual.

Each of the destinations printed in the lower right-hand column (0-6) can be controlled by sources 7 and 8.

You'll be happy to know that real time control settings are memorized for each individual preset. Thus, if desired each preset can react to the real time controls and MIDI controllers in different ways.

GUIDED TOURS

SELECTING A CONTROL SOURCE and CONTROL DESTINATION

1. With Arco Strings, preset 10 as the current preset, and **PRESET DEFINITION 9** activated, select the left wheel as a control source by keying in **1**. The cursor will flash underneath the number to the right of the chosen control source number, thus indicating that Emax II is ready for you to key in the control source's destination.

2. The left wheel should be assigned to **1** (pitch). Vary the wheel and check that the keyboard pitch is indeed affected. If sections of the keyboard are not affected, check that pitch control is enabled (**DYNAMIC PROCESSING 22**). Now press **2**; this assigns the left wheel to Filter cutoff. Rotating the wheel towards you should produce a more muted sound. Key in **13**, and the left wheel will affect overall volume. If you feel adventurous, check out the other control destinations. Note that if you select a destination that is already specified for one of the other control sources, the old assignment will be de-selected and that control source will be turned off (**0**).

3. Think about it for a bit...the left wheel can control a destination, the right wheel can control a different one (as can the pedal), and there are MIDI control possibilities too. These assignments can be different for each preset, and particular controller destinations can be disabled for different presets and voices. We're talking versatility here, so if you feel like taking out the next couple of hours and checking out all the possibilities, be our guest! Note: When assigning the footpedal, make sure it's plugged in to prevent unpredictable results.

4. Oh yes, and there are footswitches too. But before experimenting with the footswitches (sources 7 and 8), we need to understand the difference between looped and unlooped sounds. Looping is described more fully in **DIGITAL PROCESSING 2** and **DIGITAL PROCESSING 3**, but basically, a "sustain looped" sound is one where a portion of the sound is put into an "infinite repeat" loop for as long as you hold down the key. This is similar to the infinite repeat function on digital delay lines. Looping allows for sustaining a normally non-sustaining sound for as long as you like. An unlooped sound is not artificially sustained, and therefore lasts its normal length.

Keeping this in mind, refer to **PRESET DEFINITION 9**, Destinations 0-6. Assign various functions to the footswitches; note that some sounds lend themselves to the sustain function better than other sounds, so feel free to experiment.

GUIDED TOUR #5: BASIC SAMPLING

BACKGROUND

Sampling does not just involve sticking a microphone in front of something—sampling is an art. So, we've included information on the art of sampling in the Advanced Applications section of this manual. Meanwhile, this Guided Tour gives you the basics, and also lays the groundwork for the guided tour of the Digital Processing module.

GUIDED TOURS

SETUP

1. Plug a microphone into the rear panel Sample Input jack (an instrument can also be used, but a mic is easier to work with for now).
2. Erase the bank memory (**MASTER 4**). This gives us maximum sampling time.
3. Set the level (**SAMPLE 1**). The default keyboard placement will work for now, but if you want to change it, see **SAMPLE 2**. Also set the sampling rate (**SAMPLE 3**). This should be at 39 kHz; might as well leave it there for now. Check the available sampling time (**SAMPLE 4**), which should be at least 13.4 seconds.
4. Set the threshold (**SAMPLE 5**), arm the sampling process (**SAMPLE 6**), and you're ready to sample! Speak into the mic; as soon as the level exceeds the threshold, the display will say "sampling." Feel free to talk away for 13.4 seconds, but if you lose patience, press **8** to stop sampling.
5. Play the keyboard in the assigned range (lower keyboard, C1-B1) to hear the results of your sampling.
6. Now experiment with more sampling: Try setting a particular sample length (**SAMPLE 4**), using forced sampling instead of threshold-sensitive sampling (**SAMPLE 7**), assigning the sampled sound to other portions of the keyboard (**SAMPLE 2**), and also, practice terminating the sampling process (**SAMPLE 8**). As long as you do not deactivate the module, new samples will replace previous samples on the keyboard.
7. To save the sample as part of a preset, de-activate the sample module. Since memory was cleared prior to sampling, Emax II created a preset (00) called "Untitled," and this is the preset that holds your new sample. Had you sampled into a bank with existing presets, the sample would have been stored with the current preset. If you wanted to sample into a new preset, you would have first had to create a preset (**PRESET MANAGEMENT 3**) in which the sample could reside.
8. Let's try another sample. Activate **SAMPLE 2** to change the current voice. Notice that Emax II, a very polite instrument, doesn't overwrite the existing sample without your express permission; thus, the new sample is automatically assigned to the next higher octave. This assignment can always be modified with **SAMPLE 2**. Also note that if you're ever in a position where you're going to overwrite an existing sample, Emax II will notify you via the display.
9. Remember, this Guided Tour is intended simply as an overview to give you a "feel" for the sampling process. Good sampling requires skill and patience; practice!!

GUIDED TOURS

GUIDED TOUR #6: DIGITALLY PROCESSING SAMPLES

BACKGROUND and SETUP

Digital processing allows for radically altering voices stored in the bank. In this Guided Tour, we'll learn — among other topics — how to truncate, loop, reverse, splice, and combine samples. First, though, we need to take a couple of samples with which we can practice.

1. Clear the bank of memory (**MASTER 4**).
2. Follow the directions in Guided Tour #5 and make a sample of yourself speaking. However, select a 4 second sample length (**SAMPLE 4**). After setting the threshold and such, arm sampling and start jabbering.
3. De-activate the sample module, then re-activate and take another 4 second sample. You will not have to do any setup — just hit **SAMPLE 6** and talk away. You now have two samples suitable for experimentation.

CHOOSING THE CURRENT VOICE

Activate **DIGITAL PROCESSING**. You will be asked to select a voice, so press a key within the range of the voice that you want to work on and press **ENTER**.

TRUNCATING A VOICE

1. Choose **DIGITAL PROCESSING 1** to truncate the ends from voices.
2. Vary the data slider as you play a key in the range assigned to the current voice. Notice the start of the voice will disappear. Use this technique to get rid of silence at the start of a voice or for effects.
3. Move the cursor using the arrow keys to the End display. Use the data slider to truncate any undesired part off the end of the sample.
4. When you get tired of truncating, press **ENTER**. When Emax II asks if you want to "Make Truncation Permanent?", enter **NO** so that the full sample is available for subsequent experiments in this tour.
5. If desired, change the current voice (**DIGITAL PROCESSING 0**) and experiment with truncating the other sample you took. Again, when asked if you want to "Make Truncation Permanent?", press **NO**.

LOOPING A VOICE

1. If you haven't yet done so, activate the **DIGITAL PROCESSING** module and assign the current voice. Select function 4 and turn the loop mode **ON**.

GUIDED TOURS

2. Refer to **DIGITAL PROCESSING 2** to graphically see how looping affects a sample. If you play and hold a key in the current voice, it will play indefinitely since the loop function is on.

3. Now try modifying the loop. Activate **DIGITAL PROCESSING 2** and adjust the Start and Length values. Note that if the length equals the full length of the sample, you will not be able to set a new start point. Reduce the length, and you should be able to adjust the start point. For practice, try looping individual words or sentence fragments.

Please remember that looping is a very complex process which requires a great deal of practice for proficiency. The only way to fully understand looping is to experiment with a variety of signals. The purpose of this Guided Tour is to acquaint you with the concept of looping, but there is much more to the subject than simply fooling around with looping words from a spoken sample. For more information, refer to the Advanced Applications section of this manual.

SPLICING VOICES

Splicing marks an end point in one sample and a start point in a second sample; the first sample end and second sample start are then joined together. See **DIGITAL PROCESSING 6** to graphically see how this process works, then follow the instructions given to splice two samples together. (Make sure any loops are turned off in the samples for best results.)

COMBINING VOICES

Combining mixes two samples together digitally into a single sample whose length equals that of the longer sample. Assuming you still have two samples on the keyboard, follow the instructions in **DIGITAL PROCESSING 7** and combine them. If not, first clear the bank memory and record two samples as instructed at the beginning of this section.

FURTHER INVESTIGATIONS

The Digital Processing module is very powerful, but this is one case where spending some time experimenting with the various options works much better than just reading about them. Fool around with Taper (**DIGITAL PROCESSING 5**), Crossfade Looping (**DIGITAL PROCESSING 8**), and Digital Effects (**DIGITAL PROCESSING 9**). The more you work with these functions, the more sense they will make, and the more easily you can get Emax II to do your bidding.

A PRACTICE SAMPLING SESSION

1. Plug a microphone into the rear panel sample input jack.
2. Erase all memory (Use **MASTER 4**). This erases the bank, not the disk.

GUIDED TOURS

3. Set the level (**SAMPLE 1**). Sing "ahhhh" into the microphone (This is an easy sound to loop). The VU level should not quite reach the top of its range. Adjust the gain (use the data slider) until a good level is attained.

4. Set the threshold (**SAMPLE 5**). This should be set about 5 or 6 bars from the left. When the input sound exceeds this level, recording will start.

5. OK, now get ready to sing "ahhhh" and press (**SAMPLE 6**) to arm the sampling process.

6. Now sing "ahhhh". When you are out of breath, press (**SAMPLE 8**) to stop sampling.

7. Play the keyboard in the assigned range (lower keyboard, C1-B1) to hear the results.

8. Now we can truncate the silence from the beginning and end of the sound. Press (**DIGITAL PROCESSING**), the display will say: Select a Voice. Play a key in your sample range (C1-B1) and press **ENTER**. Now press **1** to select truncation.

9. Adjust the start and end points by moving the slider to remove any silence or unwanted portion of the sound (You must play the keyboard after you move the data slider in order to hear the results of the slider change). Press **ENTER** then **NO** to exit truncation.

10. Now we are ready to loop the sound. Press **2** to select looping. To loop, first move the data slider to make the loop length about 10,000 to 14,000 samples long. Next move the start point into the sustained portion of the ahhh sound so that the ticking sound becomes softer. When you get a fairly good loop press **ENTER**. The display says: Autoloop Y/N. Press **YES**. You now should have a fairly good loop. If not, adjust the start point and again press autoloop. It takes practice, but you'll get it. That's it! Feel free to play around with other processors such as chorus and LFO.

11. In summary; these are the steps you will go through every time you have a sampling session (of course you will develop your own order and style of doing it).

- Take the sample
- Truncate the sample
- Loop the sample (if desired)
- Assign the voice to a keyboard position
- Continue to refine and make presets

TIME TO SAVE?

Maybe you haven't created any masterpieces during these experiments...but maybe you have. If you want to save a preset to disk, take your blank formatted disk prepared in the last Guided Tour and Save All 16 bit (**PRESET MANAGEMENT 8**). Moral of the story: Always have a blank formatted disk around (or an empty hard disk bank) just in case you come up with something you want to save.

GUIDED TOURS

GUIDED TOUR #7: MANAGING THE BANK

BACKGROUND AND SETUP

The following functions don't necessarily do glamorous things, but they are very useful. This Guided Tour acquaints you with these utilities.

Begin by loading the Arco Strings (Piano/Strings) bank.

ERASING A PRESET

Refer to **PRESET MANAGEMENT 4** and erase Preset 01. Don't worry, this is just gone from the bank, not the disk. And we can get it back anyway by...

LOADING A PRESET

See **PRESET MANAGEMENT 1** and load Preset 01. Now it's back in the bank again.

OTHER BANK MANAGEMENT FUNCTIONS

The other functions—copy, rename, create, and preset size—are pretty much self-explanatory. Refer to **PRESET MANAGEMENT 5, 6, 3, and 7** respectively. Try these various functions to get a feel for how they work. **PRESET MANAGEMENT 8** lets you save the bank to disk.

GUIDED TOUR #8: THE SEQUENCER

The Emax II sequencer is a "scratchpad" for musical ideas, and is not intended to be a sophisticated do-all whiz-bang. However, you can create sequences on a fancy computer and, using Supermode, download these sequences via MIDI into the sequencer (**SEQUENCER SETUP 6**).

For now, we'll check out how the sequencer works as a scratchpad, so load the Arco Strings bank, activate **SEQUENCER MANAGE**, and let's go.

1. Key in 1 to set the tempo. While you're at it, activate **SEQUENCER MANAGE 2** and make sure that the Emax II clock is on Internal. The other Sequencer Manage options—Load, Erase, Copy, and Rename—are described under **SEQUENCER MANAGE 3** through **6**.

2. Now press **SELECT**. Enter sequence numbers 01, 02, 03 etc. from the keypad, until you find one that says, "Empty Seq". This is the sequence into which we will record.

GUIDED TOURS

3. Press **RECORD**, then **PLAY**. Start playing the keyboard immediately when you press play. When you've played enough, press **STOP**.
4. To play back the sequence, press **PLAY**. Varying the data slider will change the tempo. The display will show this is an untitled sequence; practice renaming it with **SEQUENCER MANAGE 6**.
5. To stop the sequence at its end, press **STOP** once. To stop it immediately, press **STOP** twice.
6. Now dig into the sequencer portion of the manual and check out all the various functions if you so desire. Bouncing tracks is fun, as is overdubbing.. and Supermode... in fact, sequencers in general are a lot of fun.

GUIDED TOUR #9: MAKE YOUR OWN

These Guided Tours cover only the basics; to cover every possibility of how to use the instrument would drown you in words. It's better that you just start playing! The best way to learn Emax II is to dive right in. Remember, you can experiment as much as you want on stuff in the bank; you have to actually save the bank to disk in order to alter the contents of the disk, and in case you're nervous, you can even write-protect the disk.

Try to spend some time not playing with, but rather practicing with, the instrument. After you're a little more familiar with Emax II, read through the Reference Section and delve deeply into a particular function or module. Emax II is like an audio construction set, where sounds can be captured, held, processed, mutated, spliced, sped up, slowed down...and lots more, so take advantage of what it is has to offer.

The more you practice with the Emax II, the more you'll be able to put your personal stamp on the music you play. And when you do play, you'll know the instrument well enough so that you are free to concentrate on the music.

GENERAL INSTRUCTIONS

SELECTING THE CURRENT PRESET **43**

EXITING A FUNCTION **43**

KEYBOARD NUMBERING PROTOCOL **44**

DISK HANDLING **44**

GENERAL INSTRUCTIONS

GENERAL INSTRUCTIONS 1

SELECTING THE CURRENT PRESET

This Function chooses one of the available bank presets.

1. With no modules active, the display will show the current preset name and number. The blinking cursor will appear under the preset number's first digit.

2. There are four ways to change the current preset:

■ Enter a two-digit number with the keypad. If you enter a number for which there is no preset, the lower display line will show the illegal preset number and say Empty Preset. Try again.

■ Move the data slider or the increment buttons. The top display line will continue to show the current preset, but the lower line will scroll through the available presets as you move the data slider. When the lower line shows the preset that you want as the current preset, press **ENTER**.

■ Increment or decrement the current preset (as displayed in the top line) with the **CURSOR** buttons. This method is useful for live performance—arrange your presets in the desired order, and step through them as needed.

■ Use a footswitch to advance through the presets.

3. To see the current preset number at any time, de-activate any active modules and look at the display.

GENERAL INSTRUCTIONS 2

EXITING A FUNCTION

After modifying a current voice or preset by adjusting any of its parameters, you have three options on how to proceed.

1. If the Enter LED is lit steadily, pressing **ENTER** will return you to the module identifier.

2. De-activate the module (Emax II returns to current preset).

3. Activate another function within the module or activate another module.

Remember: A modified voice or preset is saved in the bank, which loses its memory when the power goes off. To permanently save modified individual voices and complete banks, save to disk.

GENERAL INSTRUCTIONS

GENERAL INSTRUCTIONS 3

KEYBOARD NUMBERING PROTOCOL

Several functions reference particular keyboard keys. Emax II numbers the keyboard keys as follows.

For a 5 octave keyboard, the left-most (lowest) C is C1. The next highest note is C#1, then D1, D#1, E1, etc. through to B1. After B1, the next higher C is C2. Notes proceed upwards from C2 (C#2, D2, D#2, E2, etc.) until the next higher C, which is C3 (middle C). Notes count upwards in a similar fashion until reaching the very highest C, which is C6.

In summary:

The lowest octave spans the range C1 - B1.
The next octave higher spans the range of C2 - B2.
The next octave higher spans the range of C3 - B3.
The next octave higher spans the range of C4 - B4.
The next octave higher spans the range of C5 - B5.
The very highest note is C6.

Note: Emax II is able to accommodate an 88-note keyboard over MIDI, from keys A-1 to C7.

GENERAL INSTRUCTIONS 4

DISK HANDLING

Disks represent the sum total of your experience with Emax II, and should be handled with care.

Common courtesy for floppy disks

Disks should *never* be:

- Bent or sat on
- Exposed to strong magnetic fields (TVs, speakers, etc.)
- Subjected to temperature extremes
- Left out in the sun
- Used for coasters or frisbees.

Disks should *always* be:

- Kept away from dust, dirt, and smoke
- Treated carefully and gently.

GENERAL INSTRUCTIONS

DISK TYPE

Emax II requires double-sided, double-density (DSDD) 3.5-inch microfloppy disks. In some cases the less expensive single-density or single-sided disks will work with the Emax II, but we do not recommend using these except for non-critical applications.

FLOPPY DISK DRIVE

The floppy disk drive on your Emax II is used for transporting sounds in and out of the Emax II and also for *BACKING UP* your valuable sound collection. Floppy disk drives should be considered fragile and should not be subjected to mechanical shocks or temperature extremes. The mechanism will occasionally make "clunking" sounds; these are normal.

HARD DISK DRIVE

The hard disk drive built-in to your Emax II is the drive that you will want to use most often. In fact, you will be spoiled and will never again want to use a floppy disk after using the hard disk. If the hard disk ever develops an error, you will be very happy that you have made a backup. Hard disk drives should be considered extremely fragile (ie. do not drop your Emax II on a hard surface). If you treat your Emax II gently and with due consideration you should get years of faithful service from the hard disk. Hard disks are great!

LABELING DISKS

Write on an adhesive label which you then attach to the disk. Always label your disks so that you don't confuse blank and recorded disks.

WRITE-PROTECTING DISKS

Write-protecting a disk turns off the disk drive's ability to record on to the disk, thus preventing accidental erasure. To write-protect a disk, open the write-protect "switch" in the corner of the disk. To write-enable the disk, close the "switch" so that there is no visible hole in the disk case.

If you try to write on a disk that is write-protected, the Emax II display will say "Disk is Write Protected".

INSERTING A DISK INTO THE DRIVE

Referring to the diagram on the following page, insert the disk into the drive label-side up, with the metal disk protector flap going in first. Gently push the disk in as far as it will go, until you hear a solid click that indicates the disk is seated in the drive.

GENERAL INSTRUCTIONS

FLOPPY DISK DRIVE

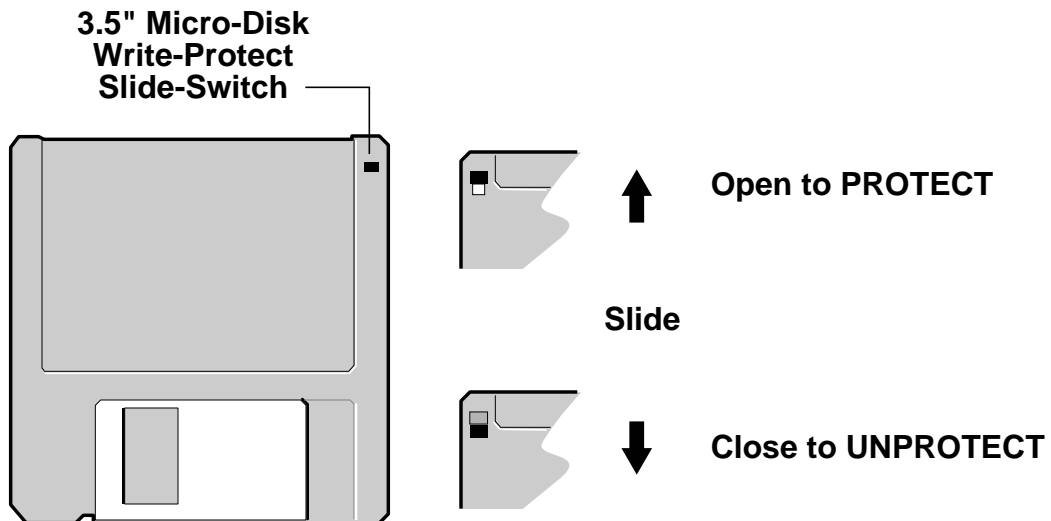
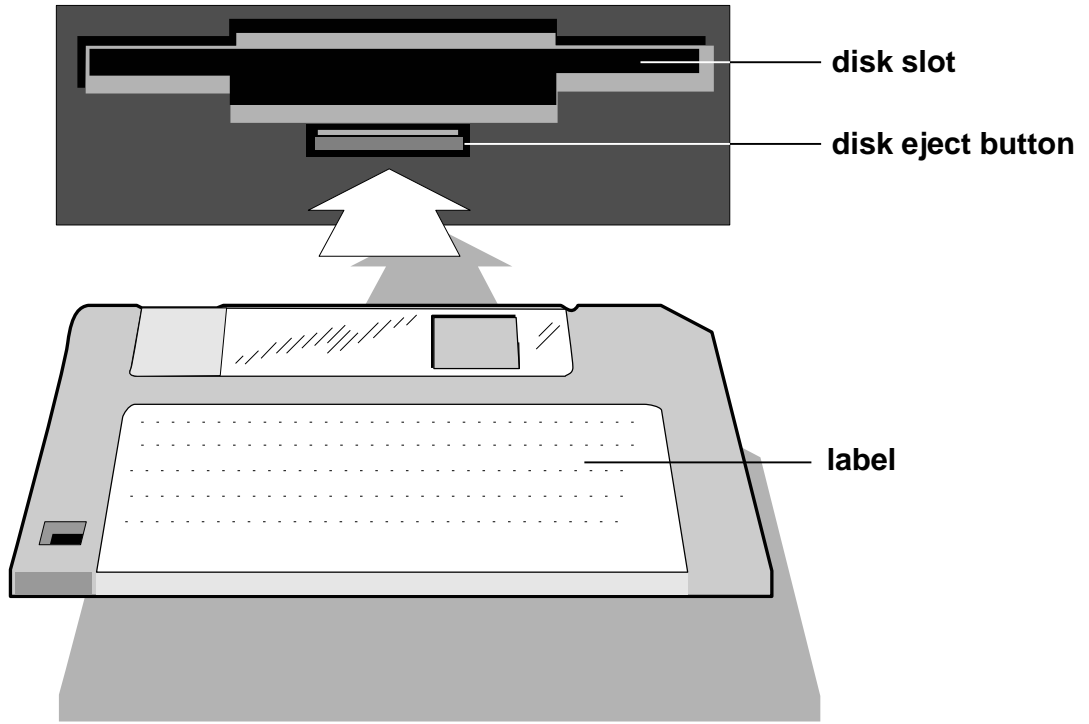

FUNCTION BUTTONS

TRANSPOSE ***49***

SELECT DRIVE ***50***

LOAD BANK ***50***

ENTER DATA ***51***

FUNCTION BUTTONS

FUNCTION

TRANSCOPE

This function transposes the keyboard in half-step intervals \pm one octave.

Applications: Use one key's fingerings in a different key. Modulate to a different key without having to use different fingerings.

1. Press and hold **TRANSCOPE** ; its LED will flash. The display says:

Transpose
Play a Key

If the keyboard has already been transposed, the **TRANSCOPE LED** will be steadily lit. If you press and hold **TRANSCOPE** , not only will its LED flash, but the display will show the amount of transposition referenced to C2 (see **GENERAL INSTRUCTIONS 6**), the second C from the left-hand side of the keyboard. For example, if the Emax II is one whole-step sharp, the display says:

Transpose +D
Play a Key

2. **To Transpose:** Continue to press **TRANSCOPE** and press a key between C1 and C3. The display shows which keyboard key you have selected for the transposition ratio (compared to C2).
3. **To Retain the Transposition:** Release **TRANSCOPE** (its LED stays lit to remind you that the Emax II is transposed).
4. **To Cancel the Transposition:** Press and hold **TRANSCOPE**, press C2, then release **TRANSCOPE** (its LED should now be off).

Note: Transpose transposes the key number rather than the voice assignment. This means that selecting the current voice and any other use of the keyboard will show the transposed key number. In short, you should turn off transpose before selecting or modifying any voices. The note sent over MIDI is post-transposition. Notes from the sequencer or MIDI are also transposed.

Application: Use transpose to easily reach "hidden" voices that lie beyond the ends of the physical keyboard.

FUNCTION BUTTONS

FUNCTION

DRIVE SELECT

This function selects which storage device will be used when loading or saving. The Emax II, in addition to its floppy disk drive, may have an internal hard disk or up to seven external SCSI devices (hard disks, etc.) may be attached to the SCSI port located on the back panel. **Drive Select**, selects which storage device will be used.

1. Press **DRIVE SELECT**. The display says:

SCSI 0: Floppy

Use the data slider to scroll through the SCSI numbers (0-7). If you have a formatted hard disk connected, the display will show the name of the hard drive and the amount of memory remaining.

Simply select the desired drive and press **ENTER** to select a particular drive.

FUNCTION

LOAD BANK

A disk stores presets, voices, and sequences. Load Bank loads all data on the disk into the Emax II.

When the machine is first turned on, a sound bank is not automatically loaded. Any time you want a bank of new sounds, you must use Load Bank to transfer disk data into the Emax II.

1. Insert the disk to be loaded into the drive (if applicable).
2. Press **LOAD BANK**. The display says:

Hard Disk

Load Bank
XX Bank Name

Floppy Disk

Load All Presets
And Sequences

...where "XX" is the bank number and "Name of Bank" is the name of the bank.

Note: The "Name of Bank" is simply the current preset at the time that the bank was saved. The **ENTER** light will flash.

FUNCTION BUTTONS

3. Use the data slider or the increment/decrement buttons to select the bank to be loaded, then press **ENTER**. In the case of a floppy disk, simply press **ENTER**. The display now says:

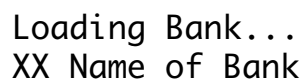

Loading Bank...
XX Name of Bank

After several seconds, the disk will be loaded and the display will show the current preset. If there is a problem with a floppy disk, the **ENTER** light will flash and the display will say...



Read Error

Press **ENTER** to give it another try. Otherwise, try a different disk.

4. To choose a different preset, enter its number with the keypad (see **GENERAL INSTRUCTIONS 1**, "Selecting the Current Preset").

5. To choose which current preset will be active when you load a bank, select the desired preset just before saving the bank to disk (see **PRESET MANAGEMENT 2**, "Save All"). The Emax II will default to that preset whenever you load the bank.

FUNCTION

ENTER DATA

ENTER is something that Emax II, rather than you, activates. Just as you can activate a module to tell Emax II something you want to do, Emax can activate this module to tell you something it wants you to do.

Sometimes the display will ask you for data (i.e., such as keying in a number to indicate a parameter you want to change). A flashing **ENTER** LED means that either data is needed to be entered, or another step is involved in completing a function. Under these conditions, Emax II is in a "holding pattern" where you must enter the desired data, or de-activate the module, before Emax II can move on to other functions (however, you can still play the keyboard).

After keying in the data, press **ENTER** to send the data into Emax II's computer. If the **ENTER** LED is lit steadily, pressing **ENTER** is optional. Usually this exits you from the function, and returns you to the module identifier so that you can go directly to another function within the module.

MASTER

| | |
|----------------------------|-----------|
| 1. MASTER TUNE | 55 |
| 2. MEMORY REMAINING | 55 |
| 3. VELOCITY CURVE | 56 |
| 4. ERASE ALL | 56 |
| 5. FORMAT DISK | 57 |
| 6. ERASE HD BANK | 59 |
| 7. BIRD RUN | 60 |
| 8. BACKUP/RESTORE | 60 |
| 0. Define Custom | 61 |
| 1. Copy HD to HD | 61 |
| 2. New Banks Only | 62 |
| 3. Selected Banks | 62 |
| 4. Custom Backup | 63 |
| 5. Continue Backup | 63 |
| 6. Backup to Floppy | 63 |
| 7. New Banks to Floppy | 64 |
| 8. Selected to Floppy | 64 |
| 9. Floppy Restore | 64 |
| 9. SPECIAL | 65 |
| 1. Copy Software | 65 |
| 2. MIDI Master | 66 |
| 3. Recalibrate | 67 |
| 4. Audition Note | 67 |
| 5. MIDI Analyzer | 68 |
| 6. SCSI Boot ID | 68 |
| 7. Headroom | 69 |
| 8. Install Disk | 69 |
| Software Revision | 69 |

MASTER

MASTER 1

MASTER TUNE

MASTER TUNE lets you tune the Emax II to other instruments.

1. Activate **MASTER 1**. The display says:

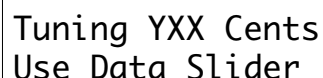

```
Tuning YXX Cents
Use Data Slider
```

... where XX is a two-digit number and Y indicates plus or minus.

2. Vary the data slider to change tuning. The display indicates, in cents, the amount sharp (+) or flat (-) compared to the normal keyboard pitch (+45 cents to -48 cents).

Note: The tunings of individual voices can also be varied (see **DYNAMIC PROCESSING 11**).

3. Press **ENTER** to return to the module identifier, or de-activate the module to return to **Select Preset**.

MASTER 2

MEMORY REMAINING

How close are you to filling up the Emax II memory with samples and presets? This command puts a dipstick in the memory to find out.

1. Activate **MASTER 2**. With an empty memory bank, the display says:

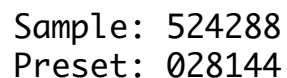

```
Sample: 524288
Preset: 028144
```

The sample memory shows the number of remaining 16-bit *samples* and preset memory shows the amount of remaining preset memory in 8-bit *bytes*.

2. Press **ENTER** to return to the module identifier, or de-activate the module to return to **Select Preset**.

MASTER

MASTER 3

VELOCITY CURVE

Emax II provides 14 different velocity curves (See Appendix) to provide different types of dynamics in response to your playing.

The Velocity Curves do not affect incoming MIDI data and therefore this function has no purpose on a rack mount Emax II.

1. Activate **MASTER 3**. The display says:

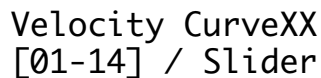

Velocity CurveXX
[01-14] / Slider

... where XX will be a number from 01 to 14. Use the data slider or the numeric keypad to select the desired velocity curve.

2. As you play a key, the lower line will display the MIDI velocity value (with 127 being the highest possible value). This helps you see how each velocity curve reacts to the dynamics of your playing.

3. Press **ENTER** to return to the module identifier, or de-activate the module to return to **Select Preset**.

Note: The velocity curve is stored as part of the preset.

MASTER 4

ERASE ALL MEMORY

This procedure clears out Emax II's entire RAM memory— Presets, Voices, Samples and Sequences.

Application: Provides maximum amount of memory for sampling.

1. Activate **MASTER 4**. The display says:

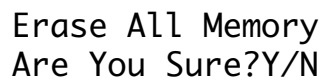

Erase All Memory
Are You Sure?Y/N

2. Press **YES** to erase, **NO** to exit without erasing.

MASTER

MASTER 5

FORMAT DISK

FLOPPY DISK

Before a floppy diskette can record (store) any data, it first must be told how to record this data (called *formatting* the disk). Run the following formatting procedure on *any* new disk, or on “recycled” disks previously used with other systems (such as home computers) since these will not be formatted correctly for the Emax II.

Formatting a disk that already contains data will “bulk erase” any data on the disk being formatted. Always check that disks are either blank, or contain nothing you want to save, before formatting. A disk need only be formatted once unless you want to use the “bulk erase” aspect of formatting.

Use 3.5" double-sided, double-density (DSDD) disks. Avoid bargain disks.

HARD DISK

Just as a floppy disk must be formatted in order to receive Emax II data, so must the hard disk. Formatting, which erases any existing hard disk data, occurs for one of two reasons:

- ▼ The hard disk has never been used previously and must be prepared for operation.
- ▼ The hard disk has developed one or more “Disk Read Errors” making one or more banks unavailable.

Formatting will re-initialize the hard disk and erase any existing banks. Hard disk crashes are not frequent occurrences, which may lull you into a false sense of security. However, Murphy’s Law dictates that a crash will occur when you have sampled fantastic, unique new sounds that aren’t backed up, so *ALWAYS* maintain floppy disk backups of any banks stored on the hard disk.

On either a hard disk or floppy disk, formatting not only formats the disk, but also writes Emax II’s operating system (the software that tells the system how to operate). Emax II writes the software that the machine was initially booted up with onto the disk to be formatted. Note: Emax II will not boot from a removable media hard disk.

1. Activate **MASTER 5**. (If you do not have a hard disk, make sure you have a formatted disk already in the drive.) The display says:

Format Erases
Memory! OK?

■ *If a new hard disk does not seem to be working correctly, it may not have been formatted for the Emax II.*

MASTER

If you don't want to lose what you have in the bank, save it to disk first (see **PRESET MANAGEMENT 2**). Otherwise, press **YES**.

2. If you booted from a floppy disk, Emax II will ask you to insert the source software disk. Check that a *formatted* Emax II disk with the latest software is in the drive. If not, insert one. To prevent any embarrassing errors, write-protect the disk (**GENERAL INSTRUCTIONS 4**). Press **ENTER**. There will be a short wait while Emax II loads the formatting software.

If you booted from a hard disk, Emax II will simply load the software into its memory from the hard disk. In either case, the display will say:

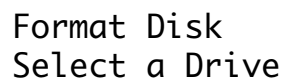

```
Format Disk
Select a Drive
```

FORMAT FLOPPY - Select **SCSI 0** in order to format a floppy disk, then press **ENTER**.

FORMAT HARD DISK - If you want to format a hard disk, select the correct SCSI ID number of the hard disk and press **ENTER**. When formatting a hard disk, disconnect any other HDs if possible, to avoid accidentally formatting the wrong hard disk. Formatting a hard disk takes 15-20 minutes, so take a break.

If you are formatting a floppy, the display says:



```
Pls Insert Disk
To Be Formatted
```

4. Remove the source disk and insert the disk to be formatted, then press **ENTER**.

The display will say:

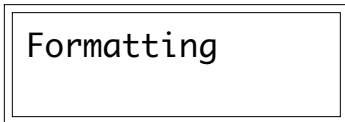

```
Formatting
```

Formatting a floppy takes about a minute and a half.

MASTER

After formatting is complete, the display asks:

```
Format Another  
Disk? Y/N
```

To format another disk, remove the newly formatted disk from the drive, insert the next disk to be formatted in the drive, then press **YES**. Otherwise, press **NO**, whereupon the display returns to the module identifier.

MASTER 6

ERASE HD BANK

This function lets you erase an entire bank from a hard disk in order to make room for other sounds.

1. Activate **MASTER 6**. The display says:

```
Erase Disk Bank  
BXX Name of Bank
```

...where "XX" is the bank number and "Name of Bank" is the name of the bank.

Note: The "Name of Bank" is simply the current preset at the time that the bank was saved.

2. Select the hard disk bank that you wish to erase and press **ENTER**.

The display says:

```
Erases HD Data  
Are You Sure?Y/N
```

3. Press **YES** to erase the bank or **NO** to return to the module identifier.

MASTER**MASTER 7****BIRD RUN**

This function aligns Emax II's internal stabilizers and prevents excessive gyro-cosmic relativation.

1. Activate **MASTER 7**.
2. Carefully observe the display for any signs of destabilization (eg. gravitational warps, apparent speeding up or slowing down of time, objects in mirrors appearing closer than they really are). If Emax II returns to the module identifier after a few seconds, all is well.

Note: Occasionally a small emu will get trapped within the Emax II and run across the screen during the stabilization scan process. This does not affect Emax II's normal functions.

MASTER 8**BACKUP/RESTORE**

This module allows you to backup either a portion or the entire contents of the hard disk on 3.5" micro-floppy diskettes. These functions make backup so easy that you will have no excuse for not backing up all your hard disk banks! Remember, If you would hate to lose it, BACK IT UP.

Note: Please read through all of the Backup/Restore procedures and try them out as well. These very flexible routines are designed to fit almost any style of backup you may have.

1. Activate **MASTER 8**. The display says:

Backup/Restore
[0-9] / Slider

Select the desired function using the data slider or keypad.

- 0) Define Custom
- 1) Copy HD To HD
- 2) New Banks Only
- 3) Selected Banks
- 4) Custom Backup
- 5) ContinueBackup
- 6) BackuptoFloppy
- 7) NewBanksToFlpy
- 8) SelectedTo Flpy
- 9) Floppy Restore

MASTER

■ 0 Define Custom

This function tells the Emax II to save the previous backup function as your custom backup. When you have chosen your preferred backup scheme, simply execute it once, then use this function and it will be permanently saved. The next time you want to backup, use the *Custom Backup* function and the procedure will be performed automatically. See also *Custom Backup*.

■ 1 Copy HD To HD

This function allows the backup of an entire hard disk to another hard disk. The display shows:

```
Backup SCSI X
Needs  YYMB
```

... where X is the currently selected SCSI drive and YY is the amount of HD memory (on the destination drive) needed to back it up.

Press **ENTER** to continue and the display says:

```
SCSI X to SCSI _
```

Use the numeric keypad to enter the destination drive ID number, then press **ENTER**. The display will show the amount of memory available on the destination drive in megabytes, and percentage of memory remaining.

The display now asks:

```
SCSI X to SCSI Y
Interactive? Y/N
```

If you select **YES** (Interactive), you will be asked to confirm the copying of each bank.

If you select **NO**, the backup will be performed on all banks without user intervention.

MASTER

The display will now ask for the Destination Mode.

Your choices are:

AddToEmpty Banks

Installs backup banks in the lowest empty banks on the destination drive and no data is lost.

CopyToSameNumber

Overwrites any existing bank with the same number.

Erase, Then Copy

Erases all data on the destination drive and provides an exact copy of the source disk.

If Interactive Mode has been chosen, the display will ask your permission before copying each bank. Use the **YES** and **NO** buttons to acknowledge.

■ 2 New Banks Only

This function works exactly like *Copy HD to HD* except that the only banks eligible to be copied are those that have been changed or added to since a previous backup.

■ 3 Selected Banks

This mode allows you to select a range of banks to be copied. The copy mode can either be interactive or automatic. After the standard backup prompts are complete, the display will say:

Select Low Bank
BXX Name of Bank

... where XX is the bank number and "Name of Bank" is the name of the bank.

Use the data slider to select the lowest bank to be backed up, then press **ENTER**.

MASTER

The display now says:

```
Select High Bank
BXX Name of Bank
```

Select the highest bank to be backed up, then press **ENTER**. The backup process will continue.

■ 4 Custom Backup

Custom Backup allows you to use a custom backup procedure that you defined using function *O-Define Custom*. When you *Define Custom*, the Emax II simply saves the previously used backup function as your custom backup. If you backup regularly, *Custom Backup* will be your main routine and will save you many keystrokes. As an example, this is what the screen would show for an automatic backup of selected banks 7-10 from SCSI 1 to SCSI 4.

```
Backup=07-10Auto
SCSI1->Same# OK?
```

■ 5 Continue Backup

This function is used when backing up to a removable media device or to a series of disks from a larger disk. If the destination HD become filled and cannot receive the entire backup, Emax II remembers which banks have *not* been backed up and allows you to change the removable media or switch SCSI ID numbers. The *Continue Backup* function allows you to continue backing up from where you left off. If a previous backup (which left any of the banks unsaved) has *not* been performed, the error message, "Cannot Continue Backup", will be displayed.

■ 6 Backup to Floppy

This mode is used if you want to backup the entire contents of a HD to floppy disk. The display shows:

```
Backup SCSI X
Need YY Floppys
```

... where X is the currently selected HD, and YY is the number of floppy disks needed.

MASTER

After the source drive is selected, you will be prompted as to the number of disks needed for each bank. Press **YES** to backup a particular bank, or **NO** to skip to the next bank.

```
Save to NN disks
BXX Name of Bank
```

... where NN is the number of floppy disks required, XX is the bank number, and "Name of Bank" is the name of the bank.

If **YES** is selected, the display says:

```
Takes NN disks
Insert disk 1
```

Continue to feed Emax II floppy disks as directed until the backup process is complete. *This will take awhile.*

■ 7 New Banks to Floppy

This function is identical to a normal backup to floppy, except that only banks that have been changed or added to since the last backup are eligible to be backed up.

■ 8 Selected to Floppy

This function allows you to choose a range of banks to be backed up. You select the starting and ending bank numbers of the banks you want backed up.

■ 9 Floppy Restore

This function is simply an automated load and save bank function, which could be used to restore the HD in the event of a hard disk failure. Insert a backup disk, then press **ENTER**. The disk will be loaded and you will be asked to which bank it should be saved. Choose the destination, and press **ENTER**. This process is repeated infinitely.

MASTER**MASTER 9****SPECIAL**

This module holds some seldom-used, but extremely useful, functions.

1. Activate **MASTER 9**. The display says:

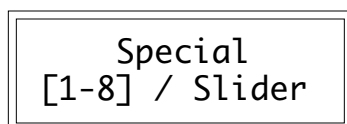

Special
[1-8] / Slider

2. Select the desired special function using the data slider or keypad.

- 1 Copy Software
- 2 MIDI Master
- 3 Recalibrate
- 4 Audition Note
- 5 MIDI Analyzer
- 6 SCSI Boot ID
- 7 Headroom
- 8 Install Disk

■ 1 Copy Software

The Emax II operating system deals with such tasks as disk transfers, memory management, and so on. Occasionally E-mu enhances the operating system. Each version of the operating system is numbered, as indicated when you move the data slider all the way to the top while in Special. As newer versions are introduced, use this function to copy the new software on to disks containing the old software. Everything else on the old disk—samples, presets, sequences, and so on—remain unchanged.

1. Upon selecting Copy Software, the display says:



Copy Sftw - Will
Erase Memory OK?

If it's not okay to erase memory, press **NO** and copy the bank contents to disk. Otherwise, press **YES**.

MASTER

The display now says:

```
Copy Sftwre from
SCSI X:DriveName
```

... where X is the SCSI ID number and "DriveName" is the name of the drive.

Use the data slider to select the SCSI drive that you wish to copy *from*.

2. Insert the Source disk (the one with the new software) in the drive if you are copying from floppy.

3. Press **ENTER** to select the source drive. This clears the bank and loads the operating system software into the Emax II. The display will say "Just A Moment...".

4. After the software has been loaded, the display says:

```
Copy Sftwre to
SCSI X:DriveName
```

... where X is the SCSI ID number and "DriveName" is the name of the drive.

Use the data slider to select the SCSI drive that you wish to copy *to*.

Insert the destination floppy disk (if applicable) and press **ENTER** to initiate the transfer. After copying the software to a floppy, you have the option of copying the software onto another disk (insert the disk then press **YES**) or exit back to the module identifier (press **NO**).

■ 2 MIDI Master

This contains three functions. **Channel** (Chan) allows you to set the MIDI channel of the Emax II and ignore the programmable channels in each preset. **Overflow** (Ovfl) is used to turn overflow mode on or off. Overflow mode transmits notes over MIDI only when the Emax II runs out of channels. **HD Load** allows you to load a hard disk bank via a MIDI program change. HD load is set to a preset that is used to tell the Emax II that the next preset change command will change the hard disk bank number. If an invalid bank number is sent, the Emax II will return to normal preset mode.

Note: Be careful when using the HD load function to prevent the accidental loading of seemingly random HD banks.

MASTER

| | | |
|------|------|--------|
| Chnl | Ovfl | HDBank |
| off | off | off |

■ 3 Recalibrate

With this function you can select minimum and maximum values for the left wheel, right wheel, foot pedal, data slider, and volume slider. You can also select a center value for the left wheel as well as the footswitch polarities and LCD contrast. Select the controller to be re-calibrated with the data slider. The Emax II controls should be recalibrated periodically in order to compensate for normal wear and tear on the controls themselves or if the controls ever behave strangely.

With the exception of the left wheel, LCD contrast and the footswitches, you will first set the minimum value and press **ENTER**, then the maximum value and press **ENTER**. For the left wheel, you can also set the center value. After making your choices, the display will ask if you want to save results. If so, press **YES**; otherwise, press **NO**. The wheels and sliders should be calibrated so that the "Post" setting ranges from 0-255.

The recalibrate footswitch function allows the Emax II to use either of two types of footswitches (normally open or normally closed). If your footswitch seems to work backwards, try changing the setting of the footswitch select from **Footswitch On=Closed** to **Footswitch On=Open**.

The LCD contrast control allows you to adjust the LCD viewing angle for easy reading. On the rack mount Emax II, the LCD angle is adjusted from the front panel and not from the recalibrate menu.

■ 4 Audition Note

This function is included for use on the Emax II rack at times when a MIDI keyboard is not connected. This function allows you to play the Emax II without a keyboard. Select **Special 5** and the display says:

| |
|------------------------------------|
| Audition Note:C3 (0-9) / Slider |
|------------------------------------|

Moving the slider will select which note is played and buttons 0-9 play the sound.

MASTER

■ 5 MIDI Analyzer

The MIDI Analyzer is a useful function designed to help you solve MIDI interconnection problems.

Select **Special 6** and the display says:

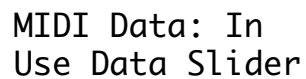

MIDI Data: In
Use Data Slider

Moving the data slider changes the analyzer from analyzing MIDI IN to analyzing MIDI OUT. Press **ENTER** to select.

The display now says:



Waiting for
MIDI Data

When MIDI data is received (or sent), the data will be displayed. The analyzer recognizes most MIDI messages, but does not display System Exclusive or Active Sensing messages.

■ 6 SCSI Boot ID

This function allows you to select which SCSI drive (0=floppy, 1-7=HD) Emax II will scan on initial power up for its operating software. Note: Emax II will always boot from floppy if a formatted floppy disk resides in the drive on power up.

The display says:

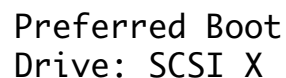

Preferred Boot
Drive: SCSI X

... where "X" is the preferred SCSI ID number.

Use the data slider to select the preferred boot drive, then press **ENTER**.

Note: You **MUST** press **ENTER** in order to store this setting in the Emax II.

MASTER

■ 7 Headroom

Headroom is the amount of dynamic range remaining before clipping will occur. The amount of headroom on the Emax II is adjustable from 0 dB to 15 dB in 1 dB increments with the front panel volume control set to maximum. A headroom setting of 0 dB, for example, will provide the hottest output level, (and the highest S/N ratio) but may cause "clipping" if too many notes are played at once. The default headroom setting is 6 dB, which is a good compromise between a good signal to noise ratio and having a bit of remaining headroom. If you hear clipping from the Emax II, raise the amount of headroom. The headroom setting *is* retained when power is switched off.

■ 8 Install Disk

The Install Disk utility allows you install new features (memory expansion, etc.) into the Emax II as they become available. Detailed instructions concerning this function will be supplied with the update kits.

■ Software Revision

This shows the operating system version number in the display.

SAMPLE

| | |
|--------------------------|-----------|
| 1. VU MODE/GAIN | 73 |
| 2. PLACE SAMPLE | 74 |
| 3. SAMPLE RATE | 74 |
| 4. SAMPLE LENGTH | 75 |
| 5. THRESHOLD | 76 |
| 6. ARM SAMPLING | 76 |
| 7. FORCE SAMPLING | 77 |
| 8. STOP SAMPLING | 77 |
| 0. CHANGE SAMPLE | 77 |

SAMPLE

SAMPLE 1

VU MODE/GAIN

This function sets the proper level for sounds being recorded into the Emax II.

1. First, insert the source to be sampled into the rear panel sample input jack. Select the preset in which you want the sample to appear. Next, activate **SAMPLE 1**.

If the preset already contains a sample in the default range in which a new sample would be recorded (C1 low note, G1 original note, B1 high note), the Emax II will look for the first available empty keyboard space to place the sample. If the Emax II can't find an empty keyboard space, it chooses the standard default and goes to the place sample screen (see **SAMPLE 2**). After this is taken care of, the display shows:

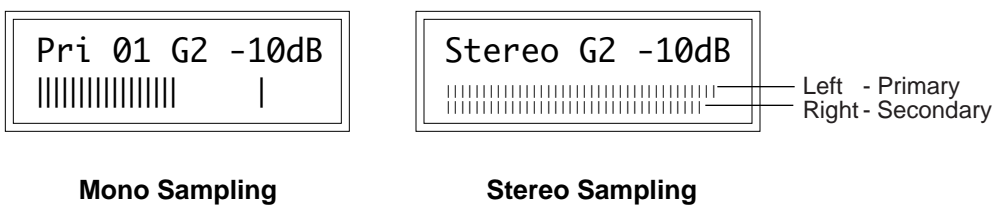

▼ High level signals should **not** be present at the sample input jack when entering the sample module because the Emax II auto-calibrates the sample inputs during this time.

There may or may not be some moving vertical bars in the display's lower line.

2. The data slider sets the sampling section gain from -10 to +40 dB in 2 dB steps. Play the sound to be sampled and observe the moving bar display; louder signals will kick the bars further over to the right. The signal can be monitored through the main outputs. The Emax II VU meter is a "peak hold" type which briefly "holds" the highest level attained.

The signal levels on the VU meter should be set as follows for optimum results:

- Emax II with **Mono** Sampling capabilities *only* : The signal level should be set so the peak does not exceed the level shown in the Mono Sampling diagram above.
- Emax II with **Stereo** Sampling option: The signal level should be set so that the peak bar comes close to the extreme right side without actually reaching it. This is the optimum recording level for either mono or stereo samples.

3. If the meter bar hits the extreme right hand side, the headroom of the Emax II has been exceeded. Adjust the data slider, and possibly the output control of the device being sampled (if present), so that peaks are below this overload point.

■ Please refer to "The Art of Sampling" in the Advanced Applications section of this manual for more information.

SAMPLE

SAMPLE 2

PLACE SAMPLE

Emax II defaults to placing the sampled sound on G1, transposed down to C1 and up to B1. However, this can be changed before sampling.

1. Activate **SAMPLE 2**. The display shows:

| | | | |
|-----|------|----|----|
| Sp1 | Orig | Lo | Hi |
| XXX | YY | YY | YY |

...where XXX indicates primary, secondary or stereo voice, and YY are keyboard notes.

2. Use the cursor buttons to select the parameter to be changed:

Sp1 = Use the data slider to select primary, secondary or stereo voice. Move the cursor to the next parameter to be changed or press **ENTER** to return to the module identifier. The status of this control can only be changed *before* a sample is taken.

Orig = Specifies the original key at which the sample will appear. Change this with the data slider, or play the desired keyboard key. Move the cursor to the next parameter to be changed or press **ENTER** to return to the module identifier.

Lo = Chooses the sample's low transposition point. Change this with the data slider, or play the desired keyboard key. Move the cursor to the next parameter to be changed or press **ENTER** to return to the module identifier.

Hi = Chooses the sample's high transposition point. Change this with the data slider, or play the desired keyboard key.

Note: If the display says "Illegal Asngmt", you are either trying to place the low note higher than the high note or the high note lower than the low note.

If you want to change a previously selected parameter, move the cursor; otherwise, press **ENTER** to return to the module identifier.

SAMPLE 3

SAMPLE RATE

The Emax II has an adjustable sample rate. Lower sample rates use up less memory, but increase distortion and reduce high frequency response. Higher sample rates give better fidelity but use up more memory.

1. Activate **SAMPLE 3**. The display shows:

| |
|------------------|
| SampleRate 39kHz |
|------------------|

SAMPLE

2. Use the data slider to choose from six different sample rates between 20kHz (medium-quality DDL sound) to 39 kHz (almost the same rate used with Compact Disks).

Press **ENTER** to return to the module identifier.

SAMPLE 4**SAMPLE LENGTH**

Once sampling is initiated, the Emax II will normally sample until it runs out of memory or is stopped (see **SAMPLE 8**, the “Stop Sampling” function). However, this function lets you program a particular sample time after which Emax II will stop sampling.

1. Activate **SAMPLE 4**. The display says:

Length XX.X secs
 (YY.Y Available)

...where XX.X is the time in seconds and YY.Y is the maximum time available.

Maximum time will depend on your sample rate; The chart below shows sample rates versus time (this chart assumes that all of the Emax II’s sample and sequence memory is empty).

| SAMPLE RATES | TIME (seconds) | | | | | | | |
|--------------------|----------------|-------------|-------------|-------------|-------------|--------------|--------------|--------------|
| | 1 M | 2 M | 3 M | 4 M | 5 M | 6 M | 7 M | 8 M |
| 20.000kHz | 26.1 | 52.5 | 78.6 | 104.9 | 131.1 | 157.3 | 183.5 | 209.7 |
| 22.050kHz | 23.7 | 47.6 | 71.3 | 95.1 | 118.9 | 142.7 | 166.4 | 190.2 |
| 27.778kHz * | 18.9 | 37.7 | 56.6 | 75.5 | 94.4 | 113.2 | 132.1 | 151 |
| 31.250kHz * | 16.8 | 33.5 | 50.3 | 67.1 | 83.9 | 100.7 | 117.4 | 134.2 |
| 39.0625kHz | 13.4 | 26.9 | 40.3 | 53.7 | 67.1 | 80.5 | 94 | 107.4 |

Note: The Sample Rates shown in **Bold**, have a maximum *continuous* sampling time equal to that of the 39kHz rate. Emax II samples at the 39kHz rate, then performs automatic sample rate conversion on the sample and frees up the additional memory for subsequent sampling.

The additional rates of 10kHz, 15.625kHz, 41.667kHz, and 44.1kHz are available in the Sample Rate Conversion function of the Digital Processing module.

SAMPLE

2. Use the data slider to change the sample length (the increment length depends on the available memory). When the display shows the desired sample length, press **ENTER**. The sample length will remain as set until changed.

SAMPLE 5

THRESHOLD

There are two ways to initiate sampling: Threshold-sensitive sampling and forced sampling (SAMPLE 7). With threshold-sensitive sampling, once sampling is “Armed” sampling begins whenever the signal to be sampled exceeds the programmable threshold level. This function sets the threshold level.

■ *When sampling in Stereo, sampling will begin whenever either the left or right channel exceeds the threshold.*

1. Activate **SAMPLE 5**. Once you move the data slider, the display will show a single bar on the top line that indicates the threshold level; the lower line will show the level of the signal to be sampled.
2. Set the desired threshold level with the data slider. Generally, you will set threshold just above the residual noise of the sound to be sampled. Therefore, any noise will not initiate sampling, but a signal that exceeds the threshold will.

Hint: Set the lowest possible threshold. If the beginning of a sound is cut off, the threshold is too high. If there’s a delay before the beginning of a sound, the threshold is too low and was probably triggered by some noise prior to the actual signal.

Note: Once sampling has begun, the Emax II will continue sampling even if the signal falls below the threshold level. To stop sampling, refer to **SAMPLE 8** or set a specific sample length (**SAMPLE 4**).

SAMPLE 6

ARM SAMPLING

Upon initiating this function, Emax II will begin sampling as soon as the sound to be sampled exceeds the threshold set with **SAMPLE 5**, or when sampling is forced (see **SAMPLE 7**).

1. Activate **SAMPLE 6**. The display’s top line says “Sample Armed”, while the bottom line shows the moving-bar VU meter (see **SAMPLE 1**).
2. As soon as the sound to be sampled exceeds the threshold, the display will say “Sampling.” After reaching the end of the sample length (if set with **SAMPLE 4**), being stopped manually (**SAMPLE 8**), or when the Emax II runs out of memory, the display will return to the module identifier.

SAMPLE

3. Play the keyboard in the sample range. If you are not satisfied with the sample, repeat steps 1-2 before de-activating the module. Otherwise, de-activate the module. Deactivating the module, then re-entering it, will automatically advance the default sample range to the next available space.

SAMPLE 7**FORCE SAMPLING**

Force sampling lets you initiate sampling manually as an alternative to threshold-sensitive sampling. This is useful for situations where the signal to be sampled is more or less continuous (continuous signals greatly complicate the threshold-setting process described in **SAMPLE 5**).

1. With the module active and levels properly set, as soon as you are ready to sample key in 7. Sampling will begin immediately, and the display will say "Sampling."
2. After reaching the end of the sample length (if set with **SAMPLE 4**), being stopped manually (**SAMPLE 8**), or when the Emax II runs out of memory, the display will return to the module identifier.
3. If you are satisfied with the sample, de-activate the module.

SAMPLE 8**STOP SAMPLING**

End sampling at any time by keying in 8. After sampling, the display will return to the module identifier.

SAMPLE 0**CHANGE CURRENT SAMPLE**

If you take consecutive samples without exiting the sample module, each sample will overwrite the previous sample. However, you can specify a new sample into which a sample will go—even without exiting the sample module—by keying in 0. Emax II will default to the next empty sample number.

The display says:

| |
|---------------------------------|
| <p>New Sample Pri XX YY</p> |
|---------------------------------|

... where XX is the voice number and YY is the keyboard placement of the sample.

DIGITAL PROCESSING

| | |
|-----------------------------|-----------|
| 0. CHANGE VOICE | 81 |
| 1. TRUNCATE | 82 |
| 2. LOOP | 84 |
| 3. RELEASE LOOP | 88 |
| 4. LOOP MODE | 91 |
| 5. TAPER | 92 |
| 6. SPLICE | 93 |
| 7. COMBINE | 95 |
| 8. CROSSFADE LOOP | 96 |
| 9. DIGITAL EFFECTS | 98 |
| 1. Gain/Attenuation | 98 |
| 2. Reverse Sound | 99 |
| 3. Change Sample Rate | 99 |
| 4. Change Pitch | 100 |
| 5. Transform Multiplication | 101 |
| 6. Spectrum Synthesizer | 103 |

DIGITAL PROCESSING

DIGITAL PROCESSING 0 CHANGE CURRENT VOICE

This function changes the current voice selection.

1. Activate **DIGITAL PROCESSING 0**. The display says:

```
Process Pri or  
Sec Voice: XXX
```

...where XXX is either Pri or Sec. Use the data slider to select whether you will edit the Primary or Secondary voice, then press **ENTER**. If there are only Primary or Secondary voices, Emax II will automatically go to step 2.

2. The display now says:

```
Key: XX YY KHZ  
Select a Voice
```

...where XX defaults to the lowest note of the lowest voice (whether Pri or Sec), and YY is the sample rate. Press a key in the range of the voice that you want to edit, or to quickly select the voice, use the data slider or increment buttons. While selecting the voice, the lower display line will show the voice number and its original pitch. After selecting the voice to be processed, press **ENTER**.

3. If the sample to be processed is used in other presets, processing the sample will process the sample in those other presets. Therefore, the display asks:

```
Used Elsewhere  
CopyItFirst? Y/N
```

Press **NO**, and any processing will affect other presets containing that sample. To avoid affecting other presets containing the sample, press **YES** to copy the sample—the current preset will contain the new copy in place of the original sample. Either response returns the Emax II to the module identifier. If there is “not enough memory” to duplicate the sample, the display will tell you.

If it is important to copy the sample, erase an unneeded voice (to gain memory space) (**PRESET DEFINITION 3**) and try again. Note that if a sample is used in other presets,

DIGITAL PROCESSING

processing it will process the sample in those other presets. Therefore, upon selecting the voice, you will be asked if you want to copy the sample.

Note that if two voices in the same preset use a single sample, then you will not be asked to copy first, and any changes will affect both voices in the preset.

3. While you remain in the Digital Processing module, all voices other than the current voice will be muted as you play the keyboard. The specified current voice will remain as is until you either change the voice assignment (**DIGITAL PROCESSING 0**), change presets, or load another bank. The current voice will need to be re-specified if you switch between modules.

DIGITAL PROCESSING 1

TRUNCATE (Set SampleStart/End)

Truncation shortens a voice's length by trimming off parts of the beginning and/or end.

Applications: Cut off unneeded portions of a voice to conserve memory. Change instrument characteristics (i.e. remove the attack from a plucked string note). Cut off long decay (i.e., simulate noise-gated reverb effect on drums). Use to isolate a particular section of a sample.

1. Activate **DIGITAL PROCESSING 1**.
2. Use the arrow keys to move the cursor under either the Start or End point. The display will show these as:

| | |
|----------|---------|
| Tr:Start | End |
| XXXXXXX | XXXXXXX |

3. The seven digits under Start indicate, in number of sample points, how much is being cut off the start of the voice. The seven digits under End indicate, in number of sample points, how much is being cut off the end of the voice. Select the parameter to be adjusted with the cursor buttons. Adjust the coarse value with the data slider and fine value with the increment and decrement keys, or enter a seven-digit number. The minimum voice size is 34 samples.

Example: Adjusting these sliders so that the bottom line indicates Trun Start 0039000 cuts one second off the beginning of the sample at the highest sample rate.

■ *Make a copy of the preset if you wish to save your original sample un-edited.*

■ *Each side of a Stereo Voice must be truncated separately! Truncate the primary voice, then write down the truncation points and truncate the secondary voice so that it exactly matches the primary. This will preserve the stereo image.*

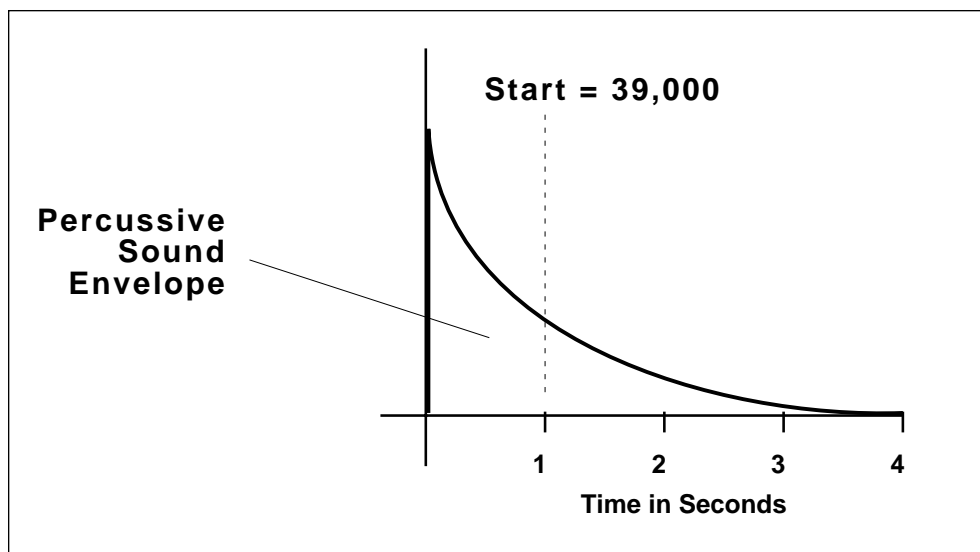
DIGITAL PROCESSING

Adjusting the Truncation Start to 0039000, cuts one second off the beginning of the sample at the highest sample rate.

4. After setting the desired truncation points, press **ENTER**. The display asks:

```
Make Truncation
Permanent?  Y/N
```

To permanently erase the truncated sections, press **YES**. To retain the truncated information in memory (so that you can truncate the sample again later in a different way), press **NO**. Note that if you exit the Digital Processing module or change the current voice (**DIGITAL PROCESSING 0**), this temporary truncation will be lost.

5. If you invoke this function to try and truncate a sample that has already been truncated, but for which the truncation has not been made permanent, the display will first ask:

```
Make Truncation
Permanent?  Y/N
```

DIGITAL PROCESSING

If you press **NO**, the Emax II enters the truncation function. **YES** permanently truncates the voice, the voice will be truncated at the previously selected truncation point(s), and the Emax II will return to the module identifier.

Note: As you change the truncation points of a looped sample (see **DIGITAL PROCESSING 2**), the loop(s) may disappear and reappear depending on the exact location of the truncation points. If the sample is permanently truncated while the loop is inaudible, then the loop will be lost. The minimum size of a voice is 79 samples.

DIGITAL PROCESSING 2

SET LOOP START and LOOP LENGTH POINTS

“Looping” lets you mark off a section (called a loop) of a voice with a Start Point and Loop Length. When you press a key, the voice plays normally until it reaches the end of the loop. It then jumps back to the Start point and re-plays through the loop. Upon reaching the loop end, it again re-plays the loop. This looping process continues for as long as the key is pressed.

Note: **DIGITAL PROCESSING 4** controls three aspects of looping: loop on/off, forwards/backwards, and loop in release. Refer to this section for specifics.

Note also that the Emax II offers two loops, each of which can loop a different portion of the signal. The Sustain Loop is operative when the key is down, and the Release Loop is operative in the release phase, when the key is up.

Applications: Looping provides “infinite sustain” effects, extends short samples, and if the loop time is rhythmically related to a composition, produces interesting rhythmic effects.

1. Activate **DIGITAL PROCESSING 2**. The display shows:

```
Lp:Start  Length
XXXXXXX XXXXXXX
```

The seven digits under Start indicate, in number of sample points, the Start of the Loop in relation to the beginning of the voice. A higher number moves the Start point closer to the end of the sample. Example: At a 39K sample rate, if the Start point reads 0039000, the Start point is located one second into the sample. The seven digits under Length indicate the Loop Length in number of sample points. A higher number increases the loop Length. The minimum start point is 3 samples and the shortest possible loop length on the Emax II is 32 samples.

■ *Each side of a Stereo Voice must be looped separately! Loop the primary voice, then write down the loop points and loop the secondary voice so that it exactly matches the primary. This will save time. Alternately, you may wish to have different loop points on each side.*

DIGITAL PROCESSING

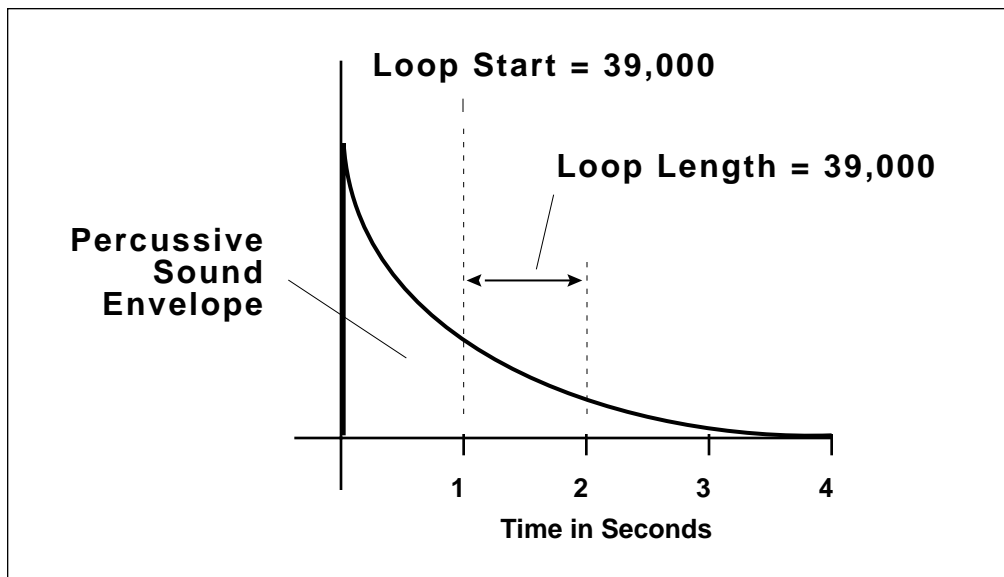

Example: If L reads L0039000, the loop is one second long at the highest sample rate. Select the parameter to adjust with the cursor buttons. Adjust the coarse value with the data slider and fine value with the increment and decrement keys, or enter a six-digit number. Loops have a minimum start point of 3 samples, and a minimum length of 32 samples.

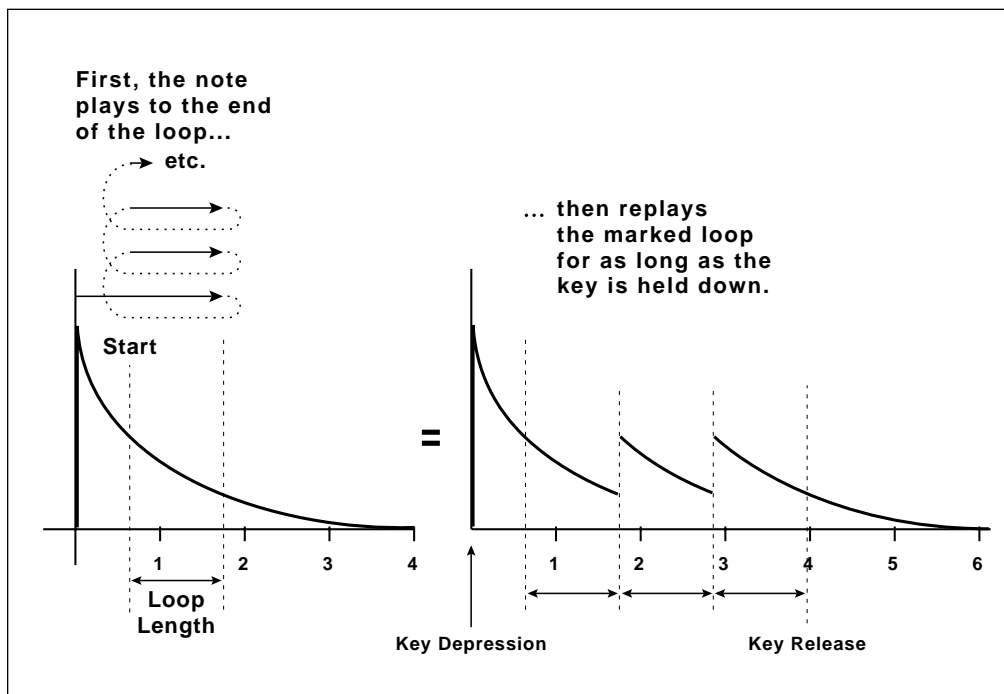

DIGITAL PROCESSING

2. Remember—L sets the Length, not the end point, of the loop. When S moves, the loop end point (as determined by the loop Length) moves in tandem with S.

After finding a good loop, press **ENTER**.

Hint: If the Loop Length is at maximum (as occurs when you first call up a voice for looping), you cannot set a new S point since that would force the loop to “run out of sample”. Shorten the Length before moving the S point.

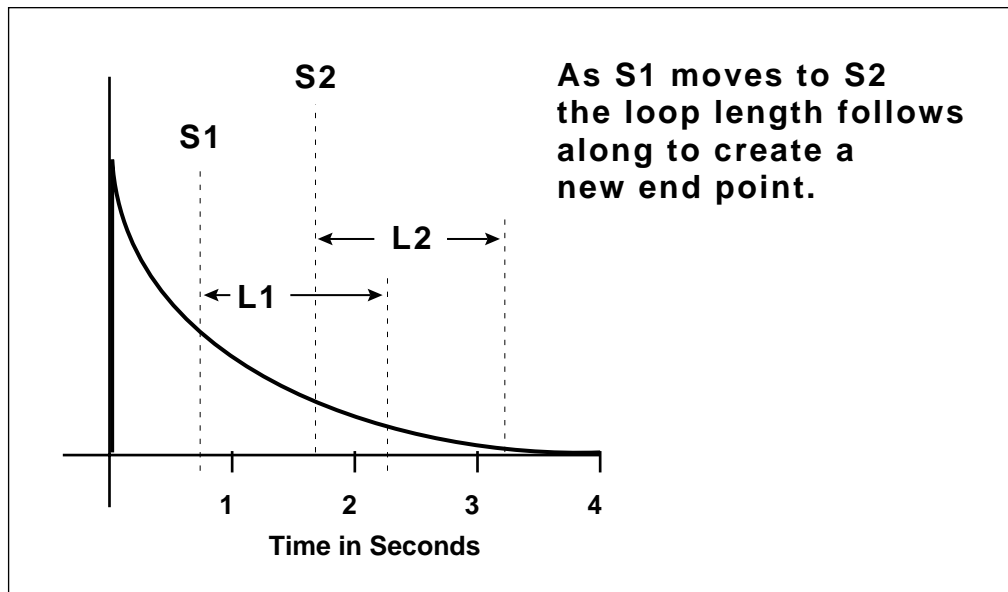

Moving the loop's Start Point adjusts the End Point of the loop as well.

ABOUT AUTOLOOPING

Looping performs an electronic “splice” which sometimes produces annoying glitches. Here’s why.

Refer to the diagram on the following page, which shows the waveform where a sample is to be looped. As the signal loops, note the discontinuity at the “splice point.” This can produce an annoying ticking or popping sound.

Fortunately, the Emax II can help find the optimum splice point for you. Set loop points as best you can, then press YES to invoke Autoloop. The computer will look for nearby points that can be spliced together with minimum discontinuity. The display will update to reflect the computer-chosen Start and Loop points.

How well does Autolooping work? Incredibly well, once you get the hang of it (getting the most out of this function does require practice). Autoloop can save you much time when doing looped samples, and is remarkably effective with short, sustained samples.

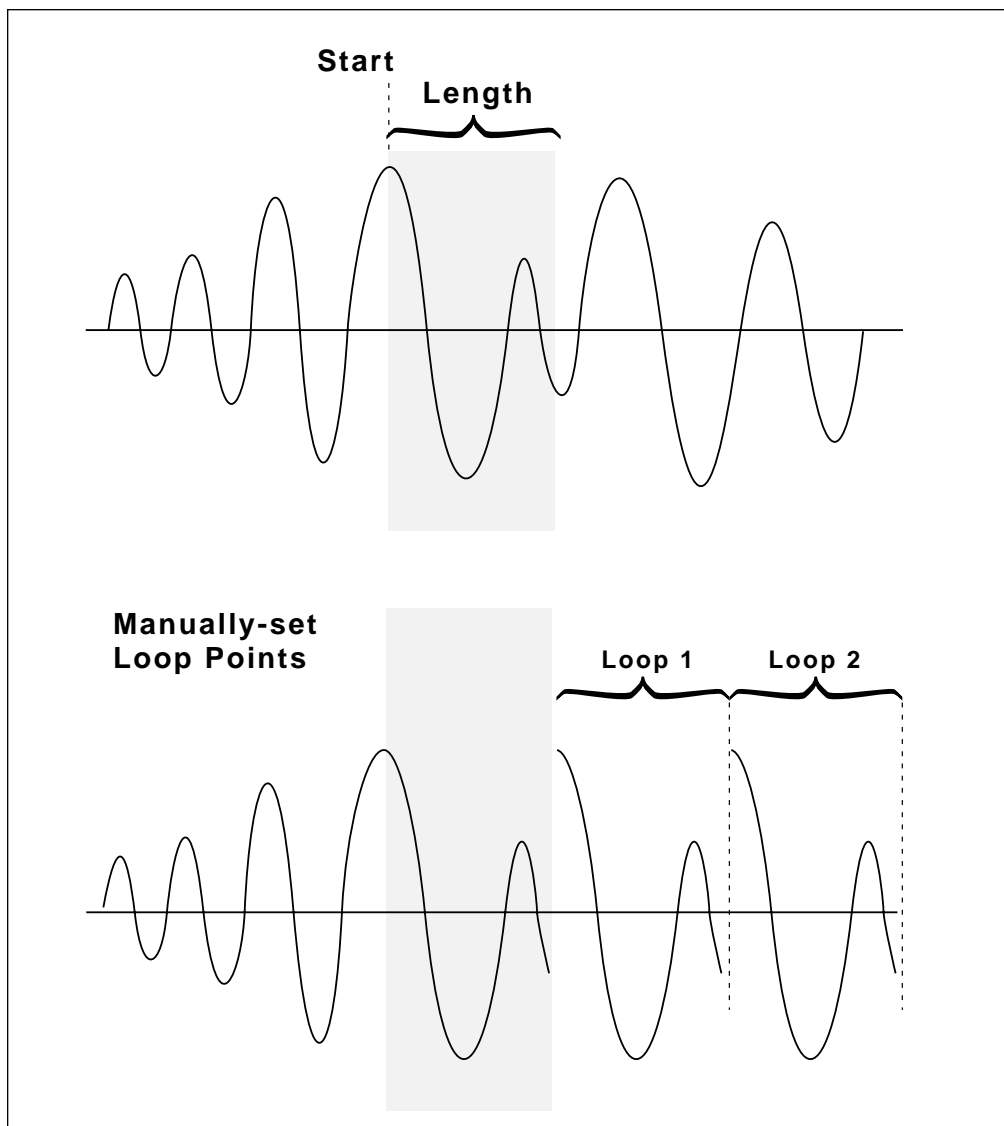
DIGITAL PROCESSING

3. The display now asks if you want to Autoloop...

Autoloop? Y/N

Press **YES** to autoloop, **NO** if you have a good loop and want to continue.

DIGITAL PROCESSING

Note: Sometimes the Emax II will choose the correct splice point from a technical standpoint, not a musical one. Therefore, if you find a good splice point, write down the S and L numbers before invoking Autoloop. Should Autoloop produce an inferior splice point, you can regain your original settings.

4. If desired, repeat steps 2 to 4 until the best possible loop results.

Note: Sometimes it will be impossible for you or the computer to find a perfect splice point. When you first try looping, you will probably think this is a common occurrence. However, you'll generally find that Autoloop, combined with practice and experimentation, can usually produce very smooth loops.

5. After establishing the desired loop points, press **ENTER**. The display asks:

Truncate After
Loop? Y/N

Press **YES** to discard all voice data after the loop end point (this conserves memory). However, if you might want to use the same sample later with a different loop point, press **NO** to keep the entire sample intact, or save the preset containing the original sample to disk.

DIGITAL PROCESSING 3

SET RELEASE, LOOP START and LENGTH POINTS

For an explanation of Looping and Autolooping, see DIGITAL PROCESSING 2 above. This function is the same, but affects the Release Loop (operational when the key is released) rather than the Sustain Loop (operational when the key is down).

1. Activate **DIGITAL PROCESSING 3**. The display asks:

Same As Sustain
Loop? Y/N

■ If a Release Loop is not defined, then it will default to the Sustain Loop settings.

DIGITAL PROCESSING

Press **YES** if you want to copy the Sustain Loop parameters to the Release Loop and then return to the module identifier, or **NO** if you want to set different parameters for the Sustain and Release Loops.

2. If you pressed **NO**, the display shows:

```

Lp:Start  Length
XXXXXXX XXXXXXX
```

The seven digits under Start indicate, in number of sample points, the Start of the Loop in relation to the beginning of the voice. A higher number moves the Start point closer to the end of the sample. The seven digits under Length indicate the Loop Length in number of sample points. A higher number increases the loop Length. Select the parameter to adjust with the cursor buttons. Adjust the coarse value with the data slider and fine value with the increment and decrement keys, or enter a six-digit number.

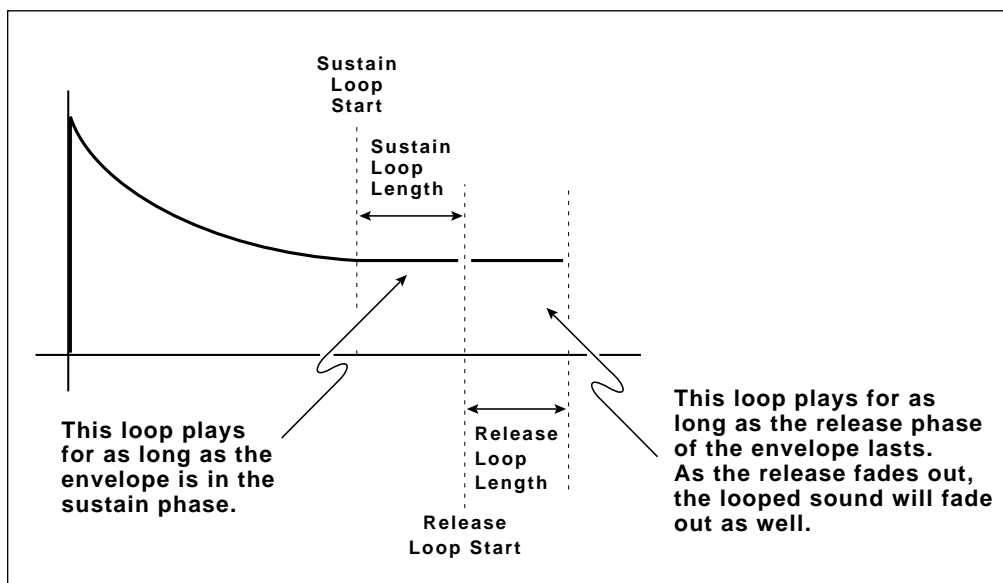

The Release Loop begins as soon as the key is released and continues until the sound fades out.

3. Remember—L sets the Length, not the end point, of the loop. When S moves, the loop end point (as determined by the loop Length) moves in tandem with S.

After finding a good loop, press **ENTER**.

DIGITAL PROCESSING

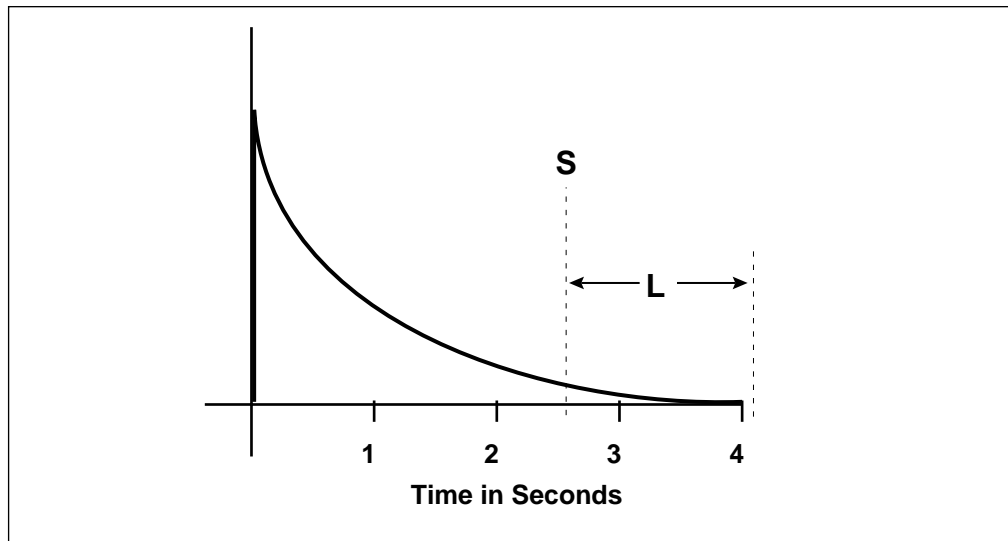

If the loop Length is at maximum (as occurs when you first call up a voice for looping), you cannot set a new S point since that would force the loop to “run out of sample”. Shorten the Length before moving the S point.

4. The display now asks if you want to Autoloop (for more information on Autolooping, see **DIGITAL PROCESSING 2**).

Autoloop? Y/N

Press **YES** to autoloop, **NO** if you have a good loop and want to continue.

Note: Sometimes the Emax II will choose the correct splice point from a technical standpoint, not a musical one. Therefore, if you find a good splice point, write down the S and L numbers before invoking Autoloop. Should Autoloop produce an inferior splice point, you can regain your original settings.

5. If desired, repeat steps 2 to 4 until you get the best possible loop.

Note: Sometimes it will be impossible for you or the computer to find a perfect splice point. When you first try looping, you will probably think this is a common occurrence. However, you’ll generally find that Autoloop, combined with practice and experimentation, can usually produce smooth, glitch-free loops.

DIGITAL PROCESSING

6. After establishing the desired loop points, press **ENTER**. The display asks:

Truncate After
Loop? Y/N

Press **YES** to discard all voice data after the loop end point (this conserves memory). However, if you might want to use the same sample later with a different loop point, press **NO** to keep the entire sample intact, or save the preset containing the original sample to disk.

DIGITAL PROCESSING 4

LOOP ON, LOOP IN RELEASE, and BACKWARDS modes

■ **Loop On** turns the loop on and off for a particular voice.

■ **Loop in Release** turns on the Release Loop. Without Release Loop, the signal may cut off abruptly after you remove your fingers from the keys; with Release Loop, you can loop the final portion of the sample so that the loop will keep playing—even after you lift your finger off the key—for as long as the VCA release lasts.

■ **Backwards** reads the voice out of memory in the reverse order from which it was stored. Backwards mode uses the Sustain Loop for its release, and the Release Loop for its sustain.

Applications: Backwards tape effects simulation. Reverse attack and decay characteristics of voices.

1. Activate **DIGITAL PROCESSING 4**. Move the cursor under the parameter to be adjusted in the display. Turn the function on or off with the **ON** or **OFF** keys respectively. To adjust other parameters, move the cursor under the next parameter to be adjusted and again use the **ON** or **OFF** keys to make your selection.

2. After making your selection(s), press **ENTER**. the Emax II returns to the module identifier.

DIGITAL PROCESSING

DIGITAL PROCESSING 5

TAPER

This adds a fade-in and/or fade-out to the sample, thus smoothing out samples with abrupt beginnings or endings.

You will not hear the effects of tapering until the Enter button is pressed. Always make sure you have a backup of anything that you taper in case the taper does not turn out well.

1. Activate **DIGITAL PROCESSING 5**. The display shows:

```

Taper Start End
      00ms 000ms
  
```

2. Start taper (fade-in) ranges from 00 milliseconds (ms) to 99 ms. End taper (fade-out) ranges from 000 ms to 999 ms. Use the arrow keys to position the cursor under the parameter to be adjusted. Set the value with the data slider .

3. After setting the desired taper point, press **ENTER**. The display will say "Tapering..." When tapering is complete, the Emax II will return to the module identifier and your voice will be tapered.

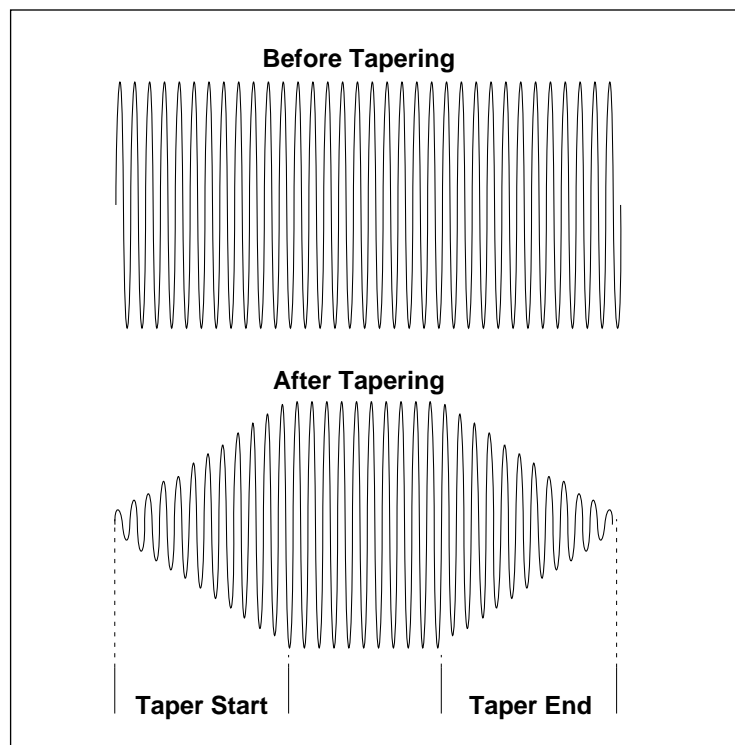

DIGITAL PROCESSING

DIGITAL PROCESSING 6

SPLICE

Splicing marks an End point in one sample and a Start point in a second sample, then crossfades the end of the first sample and the start of the second sample over an adjustable length of time. Portion of the samples not used in the spliced version are discarded, and any loops are ignored.

You will not hear the effects of splicing until the Enter button is pressed. *Always make sure you have a backup of anything that you splice in case the splice does not turn out well.*

Applications: Splice an unusual attack to one sample, or unusual decay on to another.

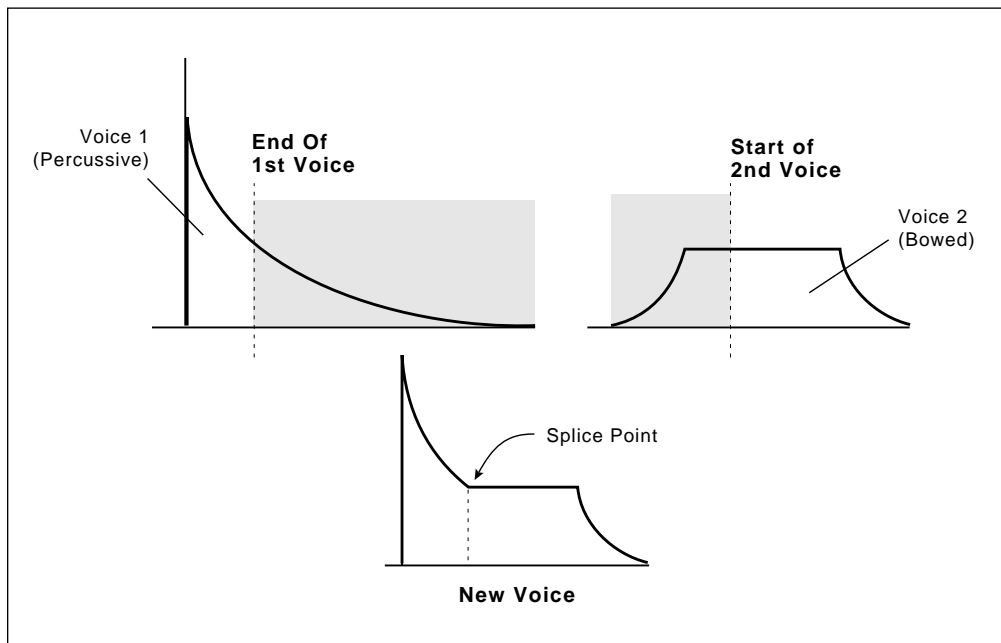

1. Activate **DIGITAL PROCESSING 6**. This voice provides the first part of the spliced sound.
2. The display now says:

```
Splice From P XX
Select A Preset
```

...where XX is a preset number. Since there are two samples used in splicing, first the preset containing the second sample must be identified. Select the preset, then press **ENTER**.

DIGITAL PROCESSING

3. The display says:

```
Select Voice
Play A Key
```

Play a note within the range of the desired voice, then press **ENTER**. The sample used by this voice will be spliced after the sample used by the first voice.

4. The display shows:

```
Splice
EXXXXXX  SYYYYYY
```

...where XXXXXX is the initial End point of the first sample and YYYYYY is the initial Start point of the second sample.

5. The six digits following the E indicate, in samples, the first sample's End point. Adjust the coarse value with the data slider and fine value with the increment and decrement keys, or type in a six-digit number with the keypad. Example: At the nominal sampling rate, E028000 means that the end point is located one second into the first sample. The keyboard will be inactive and you will not hear anything if you play it.

6. The six digits following the S indicate, in samples, the second voice's Start point. Adjust the coarse value with the data slider and fine value with the increment and decrement keys, or type in a six-digit number. Example: A reading of S028000 means that the Start point is one second into the second voice. When the splice points are correct, press **ENTER**.

7. The display now says:

```
Crossfade Time:
000ms
```

Use the slider to specify a crossfade time, in 10 ms increments, between 000 and 990 ms. Crossfade provides a smooth transition between the sounds at the splice point. When set as desired, press **ENTER**.

DIGITAL PROCESSING

8. Now comes the moment of decision, as the display asks...

Make Splice
Permanent? Y/N

Answer **NO** to forget about splicing, **YES** to permanently splice the two samples together. When splicing is complete, the first sample of the splice will be replaced with the spliced sound.

Hint: Before doing a splice, copy the first voice of the splice during the voice selection process. Thus, if you make the splice permanent but don't like the results, you can always retrieve the original voices.

Note: Remember, splicing ignores all analog parameters. Take care that the original samples are compatible in terms of pitch, volume and sample rate. Level can be altered using (**DIGITAL EFFECTS 1**).

DIGITAL PROCESSING 7

COMBINE VOICES

Combining voices mixes one sample with another, thus producing a more complex voice. The combined voice ignores any looping, tuning, or level changes programmed in the individual voices; it works solely on the original digital voice information. To loop the combined voice, it is necessary to treat it as a single voice and set loop points as described in DIGITAL PROCESSING 2.

Applications: Mix octave higher voices in with a guitar's original voices to create a 12 string guitar effect. Mix synthesized drum sounds in with acoustic drum sounds. Mix synthesized strings in with real strings to add "body." Combine two voices into one voice to conserve memory.

1. The current voice selected when entering the **DIGITAL PROCESSING** module will be the voice that will be combined with the next selected voice.

2. Activate **DIGITAL PROCESSING 7**. The display now says:

Combine From PXX
Select A Preset

DIGITAL PROCESSING

...where XX is a preset number. Since there are two samples used in combining, first the preset containing the second sample must be identified. Select the preset, then press **ENTER**.

3. The display says:

Select Voice
Play A Key

Play a note within the range of the desired voice, then press **ENTER**. The sample used by this voice will be combined with the sample used by the first voice.

4. The display now asks:

Combine Changes
Data OK?

If you're having second thoughts, press **NO**. Otherwise, press **YES** to permanently combine the two samples.

5. The display will say "Combining" for as long as it takes to combine the two samples. Depending on the sample length, this can be a very long process...if you need to catch up on your reading, now is a good time. Or, you can send out for pizza.

DIGITAL PROCESSING 8

CROSSFADE LOOP

This virtually eliminates a loop's splicing glitch by crossfading the end and beginning of the loop.

1. Activate **DIGITAL PROCESSING 8**.

The display will say:

Crossfade Loop:
Changes Data!OK?

DIGITAL PROCESSING

If you don't mind changing the data, press **YES**. Otherwise, press **NO** to return to the module identifier.

2. The display now asks:

Linear or EqPwr?
Linear

...where Linear is the default value. Use the data slider to select between Linear (a straight mathematical crossfade) and Equal Power (a weighted crossfade that produces no apparent level shift). After making your choice, press **ENTER**.

3. After taking a few seconds, the Emax II will ask "Truncate after Loop? Y/N. After you have made your choice, the Emax II will return to the module identifier.

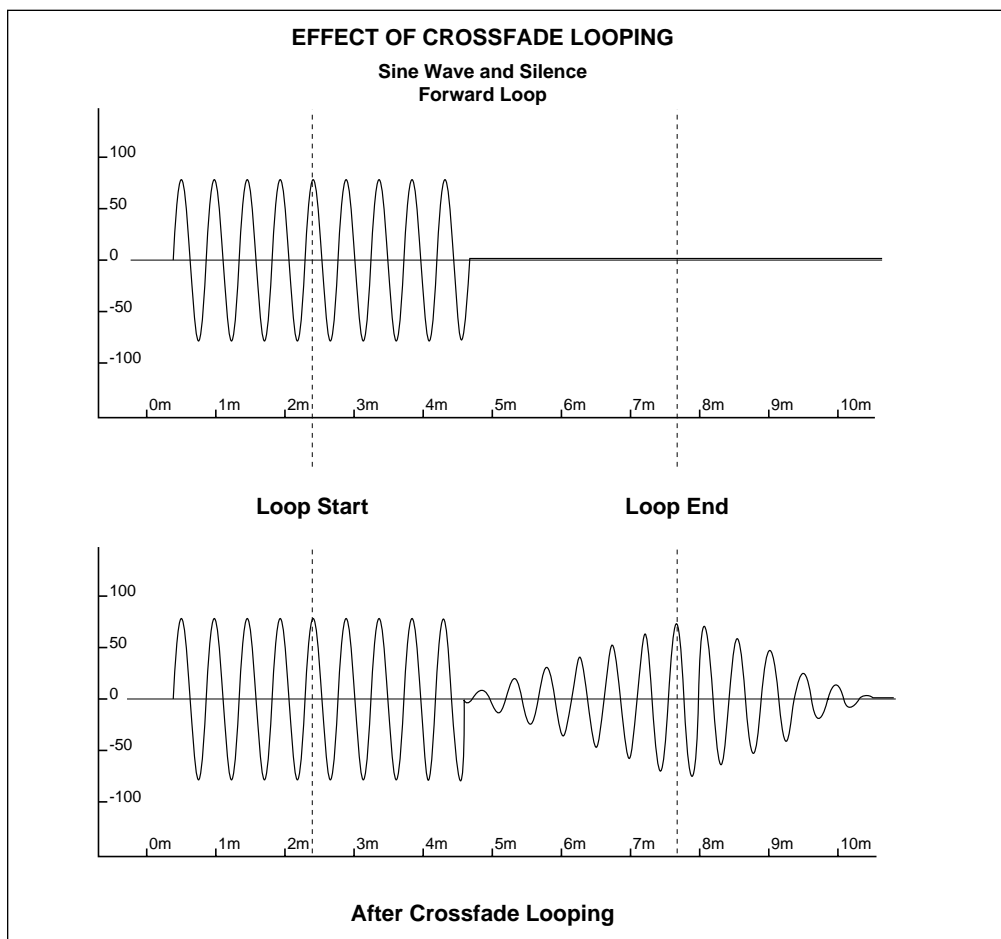

Crossfade Looping takes data from around the Start Point and fades it into the data from the End Point so that the data at both loop points is identical.

DIGITAL PROCESSING

Hints: Before doing a crossfade, copy the voice whose loop is to be crossfaded to another preset. Since crossfading permanently alters the voice, keeping a copy lets you retrieve the original voice and try again.

Linear mode is useful for well-correlated data, such as a sample which has already been autolooped. Otherwise, use equal power. If distortion occurs, try reducing the sample's level (see **DIGITAL PROCESSING 9**) then crossfading it.

DIGITAL PROCESSING 9

DIGITAL EFFECTS

Activate **DIGITAL PROCESSING 9**. The display will say:

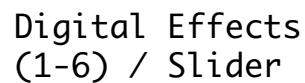

Digital Effects
(1-6) / Slider

Use the data slider or increment buttons to catalog the various options.

- 1 Gain/Atten
- 2 Reverse Sound
- 3 Change SmpRate
- 4 Change Pitch
- 5 Transform Mult
- 6 Spectrum Synth

■ 1 Gain/Atten

Alters the level of a voice.

1. Select with the slider and press **ENTER**, or key in 1 from the keypad.

The display shows:

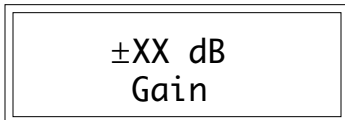

±XX dB
Gain

■ The default amount of gain change shown in the display is the amount of gain needed to normalize the sample (bring the sample to full level).

...where XX is a two-digit number.

DIGITAL PROCESSING

2. Use the slider to select the desired amount of attenuation (down to -40 dB) or gain (up to +40 dB), then press **ENTER**. Emax II tells you this "Changes Data! OK?" If you can handle that, press **YES**. The display will say "Computing..." during the time the level is changed.

3. Those who enjoy ugly, fuzz-tone, or noise-like sounds are welcome to boost the gain to absurd levels.

■ 2 Reverse Sound

Permanently reverses the sample.

1. Press **ENTER** to return to the **DIGITAL PROCESSING** menu, then **9** to return to **DIGITAL EFFECTS**. This time choose **2** from the menu.

The display says:

Reverse Sound
Changes Data!OK?

2. To reverse the sound permanently press **YES**, to return to the **DIGITAL PROCESSING** menu press **NO**. The reverse sound function reverses a sample with its loop points intact, however, the loop is turned off.

Note: Reverse Sound requires memory space to perform its calculations. In some cases there may not be enough memory left to reverse the sound, in which case the display warns you.

■ 3 Change Sample Rate

Allows you to digitally resample a sound at a different sample rate.

Applications: Conserve memory space by converting a sound to a lower sample rate or convert a sound that has been digitally transferred via MIDI Sample Dump to an Emax II sample rate.

1. Press **ENTER** to return to the **DIGITAL PROCESSING** menu, then **9** to return to **DIGITAL EFFECTS**. Choose **3** from the menu. The display says:

| | |
|---------|---------|
| OldRate | NewRate |
| XXXXXHz | YYYYYHz |

▼ *Make sure to change the sample rate of both sides of a stereo voice to prevent undesirable results.*

DIGITAL PROCESSING

... where XXXXX can be any sample rate from 7000 Hz to 50000 Hz and YYYYYY can be any Emax II sample rate (20.0 kHz, 22.050kHz, 27.778kHz, 31.250kHz, 39.0625kHz)

2. When the sample rates have been selected, press **ENTER** and the display warns:

Modifies Sample&
Takes XX min.OK?

... XX being the time it take the Emax II to do the calculations for the conversion.

3. Press **YES** to convert, **NO** to return to the module identifier.

Note: The rates given in the NewRate column are the *actual* Emax II sample rates. The sample rates shown in the sample module are approximations. When doing sample rate conversions to conserve memory, be sure to use the actual Emax II rates in the OldRate column.

Sample Rate Conversion requires memory space to perform its calculations. In some cases there may not be enough memory left to convert the sound, in which case the display warns you.

■ 4 Change Pitch

Allows you to digitally change the pitch of a sound.

Application: Change the pitch of a sound in order to splice or combine it with another sound of a different pitch.

1. Select **DIGITAL EFFECTS 4** and the display will say:

Change Pitch
+00.00 semitones

The Pitch Change range is ± 35 semitones, 99 cents. Use the cursor keys to select between semitones and cents.

2. When the amount of pitch change has been selected, press **ENTER** and the display warns:

▼ Make sure to change the pitch of both sides of a stereo voice to prevent undesirable results.

DIGITAL PROCESSING

Modifies Sample&
Takes XX min.OK?

... XX being the time it takes Emax II to do the calculations for the pitch change.

3. Press **YES** to change the pitch, **NO** to return to the module identifier.

Pitch Change requires memory space to perform its calculations. In some cases there may not be enough memory left to convert the sound, in which case the display warns you.

■ 5 Transform Multiplication - A New Way to Combine Sounds.

Transform Multiplication is a digital effect that can be used to create some of the wildest new sounds that you have ever heard. Basically, two sounds are merged together in a way that frequencies common to both sounds are accentuated while uncommon frequencies are discarded. Transform Multiplication works best using harmonically rich sounds. The length of the resulting sound will be equal to the length of the current voice.

1. After selecting the current voice, select **DIGITAL EFFECTS 5** and the display will say:

TranMultWith P01
Select a Preset

2. Use the slider to select the preset containing the second voice, press **ENTER** and the display will say:

Key: XX 39kHz
Select a Voice

3. Play a key to select a voice, then press **ENTER**.

If you do not have enough sample memory in your Emax II to complete the calculations, the display will inform you that there is "Not Enough Sample Memory!" and you will be returned to the module identifier.

Sound Designers: TM is a valuable tool in your arsenal which can be used to produce weird, mood-creating sounds that have never been heard before.

DIGITAL PROCESSING

If you do have enough sample memory to complete the operation, the display will say:

Modifies Sample &
Takes XX min.OK?

... XX being the time it takes Emax II to perform the necessary calculations.

4. Press **YES** to continue, **NO** to return to the module identifier.

APPROACHING TRANSFORM MULTIPLICATION

Transform Multiplication can be thought of as a sounding board on a mechanical musical instrument. It is a kind of electronic resonator which can be used to impart characteristics of one sound onto another. Transform Multiplication is a form of synthesis that until now has only been available at large electronic music research facilities using supercomputers. Because of its obscurity, the territory of sounds produced with Transform Multiplication remains largely unexplored. As you wait for Transform Multiplication to complete its computations, you will gain an appreciation for the early Electronic Music pioneers who had to wait days to hear the results of their efforts. TM does take time to do its thing and can be considered an advanced application for those willing to take the time to come up with something completely different. Begin your experiments with short percussion sounds or the InstAttacks on the Spectrum Synthesis disk as these will give good initial results.

TRANSFORM MULTIPLICATION EXPERIMENTS and HINTS

- Use speech as one of the voices, a pitched sound for the other. Via TM it is possible to "speak from within" violins, bassoons, cymbals, etc., similar to the effect of a vocoder.
- Try using the same sound for both voices.
- Use sounds created with Spectrum Synthesis as TM sound sources. Experiment with the effects different spectrums have on the result.
- Splicing silence to the beginning or ends of very short sounds can change the spectral characteristics of the result. If you truncate a sound, taper the ends to avoid spectral smearing. Splicing silence to the end of the current voice will also lengthen the final result.
- Sample a popping balloon, firecracker or handclap in a tiled bathroom (or other reverberant room). This will be the current voice. Choose any other interesting voice and perform Transform Multiplication. The current voice should sound as if it were in the room (or maybe not). This is a basic impulse response experiment. In this case, you have taken the impulse response of the room.

DIGITAL PROCESSING

■ 6 Spectrum Synth

This is a full function additive synthesizer with dynamically changing spectrums and envelopes. Virtually any imaginable waveform may be created. After a sound has been created it may be spliced, combined, and processed in the same manner as a sound that has been sampled into Emax II.

1. Select **DIGITAL EFFECTS 6** and the display will say:

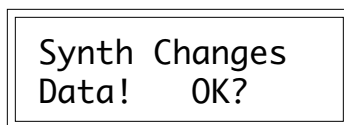

Synth Changes
Data! OK?

2. If it's OK to write over the current voice, press **YES**. If not press **NO** to return to the module identifier. If you pressed **YES**, the display will now say:

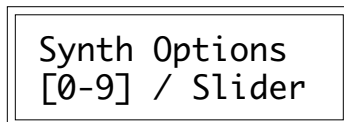

Synth Options
[0-9] / Slider

3. Use the slider to catalog the various options.

- 1 Freq. Spectrum
- 2 Time Slice
- 3 Ampl. Contour
- 4 Pitch Contour
- 5 Pitch/Ratios
- 6 Crossfade
- 7 Load Backup
- 8 Save Backup
- 9 Erase
- 0 Synthesize!

For complete instructions on how to use the Spectrum Synthesizer, see the Advanced Applications section of this manual.

PRESET MANAGEMENT

| | |
|---------------------------|------------|
| 1. LOAD PRESET | 107 |
| 2. SAVE COMPRESSED | 108 |
| 3. CREATE PRESET | 109 |
| 4. ERASE PRESET | 109 |
| 5. COPY PRESET | 110 |
| 6. RENAME PRESET | 110 |
| 7. PRESET SIZE | 111 |
| 8. SAVE ALL 16 BIT | 112 |

PRESET MANAGEMENT

PRESET MANAGEMENT 1

LOAD PRESET

Use this to load an individual preset from disk into the Emax II memory bank.

1. Insert the disk containing the preset to be loaded into the disk drive.
2. Activate **PRESET MANAGEMENT 1**. The display says:

```
Load PXX
Select A Preset
```

3. Use the data slider or the increment/decrement buttons to select the source bank (either from hard disk or floppy), then press **ENTER**. The display now says:

```
Load PXX
Select A Preset
```

...where XX is the number of the preset to be loaded (source preset). Use the data slider to catalog the presets available for loading, as displayed on the lower line. When you find the desired preset, press **ENTER**.

4. The display now says:

```
Load PXX To PYY
Select A Preset
```

...where XX is the number of the source preset and YY the number of the destination preset (this defaults to the first empty preset). Select the desired destination preset (use the data slider or numeric keypad) and press **ENTER**. If the preset is not empty, a message will appear asking if you want to overwrite the existing preset.

5. If the load was successful, the display will give you the chance to rename the preset. Name the preset as described in **PRESET MANAGEMENT 6** and then press **ENTER** to return to the module identifier.

Note: If you load a preset that uses samples already present in the bank, new copies of the samples will not be loaded. This technique saves a great deal of memory space.

PRESET MANAGEMENT

Hint: It is a good idea to check the size of the preset you wish to load (**PRESET MANAGEMENT 7**) to make sure there is enough sample memory in the Emax II bank to accomodate the new preset.

PRESET MANAGEMENT 2

SAVE COMPRESSED

This function saves the entire Emax II bank to disk in compressed 8-bit form. This allows a 1-megabyte bank to be stored on a single floppy disk which could be useful in a live performance situation. In many cases the compressed data will be audibly indistinguishable from the 16-bit version.

1. Insert the disk to which you want to save the bank, into the drive.
2. Activate **PRESET MANAGEMENT 2**. The display says:

Save All
Compressed? Y/N

3. Press **YES** to save the bank to floppy disk, or **NO** to return to the module identifier. While saving, the display will counsel patience. When the save is complete, the Emax II will return to the module identifier. Banks of 1 megabyte or less can be saved as compressed to a floppy disk only.

Using the Save Compressed function to create Emax I disks

The compressed format is the same data format used in the Emax I. This function can be used to create high quality Emax I banks. Emax II banks saved as compressed will be compatible with an Emax I, with a few exceptions:

- 1) Only banks which are 1 Meg or smaller can be saved compressed.
- 2) Samples should be converted to Emax I sample rates before saving as compressed.
- 3) Stereo voices will be saved as primary and secondary voices with Dual mode on.
- 4) The transposition limits of the Emax I will be in effect.
- 5) Output assignments should be set to Main, corresponding to outputs 1-8 on Emax I.

PRESET MANAGEMENT

PRESET MANAGEMENT 3

CREATE PRESET

Creating a preset provides a home for all those great samples you have.

1. Activate **PRESET MANAGEMENT 3**. The display says:



```
Create Preset XX
Select A Preset
```

...where XX defaults to the first empty preset. Select the desired preset number (use the slider, or numeric keypad) and press **ENTER**. Note: If you select a preset which already exists, the display will ask if you want to overwrite (that means *erase*, so think twice!) the existing preset. Press **YES** to overwrite, **NO** to return to the module identifier.

2. The display will now give you the chance to rename the preset. Name the preset as described in **PRESET MANAGEMENT 6** and then press **ENTER** to return to the module identifier.

PRESET MANAGEMENT 4

ERASE PRESET

Here's how to erase an unneeded preset.

1. Activate **PRESET MANAGEMENT 4**. The display says:



```
Erase Preset XX
Select A Preset
```

...where XX is the preset to be erased (this defaults to the current preset). Select the preset to be erased then press **ENTER**.

2. The display will ask...



```
Erase Preset XX
Are you Sure?Y/N
```

To erase preset XX, press **YES**, or press **NO** to return to the module identifier.

PRESET MANAGEMENT

PRESET MANAGEMENT 5

COPY PRESET

Use this function to copy one preset into another preset.

1. Activate **PRESET MANAGEMENT 5**. The display says:

Copy PXX
Select A Preset

...where XX is the preset to be copied (the source preset; this defaults to the current preset). Select the preset to be copied (use the data slider or numeric keypad) then press **ENTER**.

2. The display will ask...

Copy PXX to PYY
Select A Preset

...where XX is the number of the source preset and YY the number of the destination preset (this defaults to the first empty preset). Select the desired destination preset (use the slider or numeric keypad) and press **ENTER**. If the preset is not empty, a message will appear asking if you want to overwrite the existing preset.

2. The display will now give you the chance to rename the preset so that the destination preset has a different name from the the source preset. Name the preset as described in **PRESET MANAGEMENT 6** and then press **ENTER** to return to the module identifier.

PRESET MANAGEMENT 6

RENAME PRESET

Use this function to rename an existing preset.

1. Activate **PRESET MANAGEMENT 6**. The display says:

Rename Preset XX
Select A Preset

...where XX (which defaults to current preset) is the preset to be renamed. Select the

PRESET MANAGEMENT

preset to be renamed (use the slider or numeric keypad) then press **ENTER**.

2. Use the cursor buttons to select the character to be changed. Select the character itself with either the data slider (moving the slider all the way to the bottom of its travel produces a space), or the keyboard keys. You can also use the numeric keypad to enter any numbers that are part of the name. When the naming process is complete, press **ENTER** to return to the module identifier.

PRESET MANAGEMENT 7

PRESET SIZE

Memory space is precious, so you'll want to use this function to find out how much sample memory and preset memory each preset takes up.

1. Activate **PRESET MANAGEMENT 7**. The display says:

```

Preset Size PXX
Use Data Slider
  
```

...where XX defaults to the current preset. Select the preset whose size you want to check and then press **ENTER**.

2. The display now says...

```

PresMem SampMem
XXXXXX  YYYYYYY
  
```

...where XXXXXX is the preset memory in *bytes* and YYYYYYY is the sample memory in 16-bit sample *words*. After checking the memory, press **ENTER** to return to the module identifier.

Note: Erasing a preset won't necessarily reduce the amount of sample memory if these samples are used in other presets that are not erased.

Also, note that sequences and samples share the same memory space. Therefore, eliminating unneeded samples will allow more memory for sequences and visa versa.

PRESET MANAGEMENT

PRESET MANAGEMENT 8

SAVE ALL 16 BIT

This function saves the entire Emax II bank to disk in 16-bit linear format.

1. Use the **DRIVE SELECT** function to select the destination disk drive.
2. Activate **PRESET MANAGEMENT 8**.

FLOPPY DISK

If you are saving to floppy disk, the display says:

Save All 16 Bit
to X disks? Y/N

... where X is the number of floppy disks required to save the bank.

3. To save the preset, press **YES**, or press **NO** to return to the module identifier.

HARD DISK

If you are saving to a hard disk, the display says:

Save Bank to
BXX Name of Bank

... where XX is the bank number and “Name of Bank” is the name of the current preset at the time that the bank was saved.

4. Use the data slider to select the destination bank on the hard disk , then press **ENTER**.

PRESET DEFINITION

| | |
|-----------------------------|------------|
| 1. COPY VOICE (s) | 115 |
| 2. EDIT ASSIGNMENT | 118 |
| 3. ERASE VOICE | 120 |
| 4. STEREO VOICE | 121 |
| 5. CROSSFADE | 123 |
| 6. ARPEGGIATOR | 126 |
| 7. MIDI | 133 |
| 8. PITCH BEND RANGE | 138 |
| 9. REALTIME CONTROLS | 138 |
| 0. STACK PRESETS | 144 |

PRESET DEFINITION

PRESET DEFINITION 1

COPY VOICE(S)

This function copies voice(s) from one preset to another.

Application: Copying a voice back to a subset of its former range gives you another voice that uses the same sample. Using this technique, you can dynamically process each voice separately.

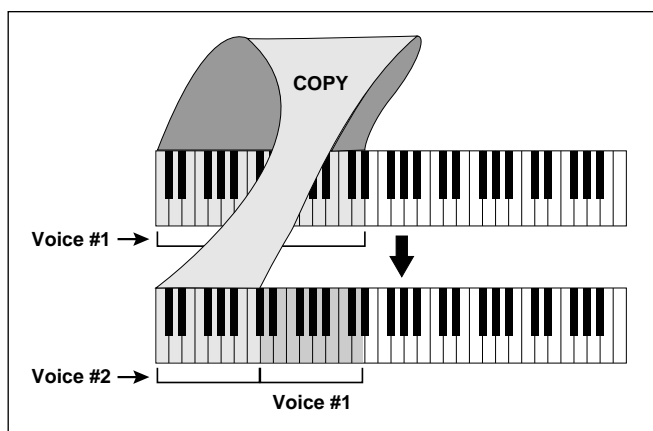

Copying a voice back to a subset of its former range gives you another voice, using the same sample, which may be separately processed.

■ Use the Copy Voice function to create multiple voices from one sample. This can be used to create alternate tunings, or different pan settings for each key.

1. Activate **PRESET DEFINITION 1**.

2. The display says:

```
GetVoiceFrom PXX
Select A Preset
```

... where XX defaults to the current preset.

Select the preset that contains the voice(s) to be copied, then press **ENTER**.

3. The display now shows:

```
Copy Pri,Sec,or
Both Voices:XXX
```

... where XXX is either Pri, Sec or Both.

PRESET DEFINITION

Use the data slider to select whether you will copy primary, secondary or both voices, then press **ENTER**.

Caution: If you select both, even though the source preset contains no secondary voices, you can overwrite double voices during the copying process (step 7).

4. The display says:

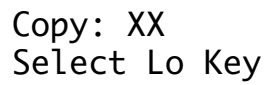

Copy: XX
Select Lo Key

...where XX defaults to the lowest note of the lowest voice (whether Pri or Sec).

Press the lowest key of the range you want to copy, or to quickly select the lowest note of the available voices, use the data slider. While selecting the low key, the lower display line will show the voice number and its original pitch. When the display shows the desired low key, press **ENTER**.

The display now asks you to choose the Hi Key:

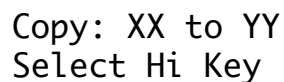

Copy: XX to YY
Select Hi Key

...where YY defaults to the highest note of the previously selected voice.

Press the highest key of the range you want to copy or to quickly select the highest note of the available voices, use the data slider. After selecting the range to copy, press **ENTER**.

5. The display asks:



CopyVoiceTo PXX
Select A Preset

... where PXX defaults to the current preset.

6. Select the destination preset to which you want to copy the voice(s), then press **ENTER**.

PRESET DEFINITION

If you select an empty preset, upon pressing **ENTER** you will be given a chance to rename the preset that the Emax II just created for you. Rename as described in **PRESET MANAGEMENT 6**.

After renaming is complete, press **ENTER**.

7. The display now shows:



Copy Voice To
Pri or Sec: XXX

...where XXX defaults to your previous selection in step 2 (note: if in step 2 you selected both, then the Emax II will automatically go to step 9). This step allows you to copy primary voice(s) to secondary locations and visa versa.

8. Use the data slider to select whether you will copy the voice(s) to a primary or secondary location, then press **ENTER**.

9. The display now says:



Lo:XX
Select New LoKey

...where XX defaults to the previously-selected low key.

Press the low key of the desired range in the destination preset. The lower display line will show the voice number and original pitch in the destination preset. Attempting to place the low note in such a way that the range cannot be assigned produces an "Illegal Asgnment" display.

10. After specifying the range's low note, press **ENTER**. The display will warn you if this assignment either modifies the existing assignment or erases (overwrites) any existing voice(s). If this is okay, press **YES** to copy and return to the module identifier. Otherwise, press **NO** to interrupt the copying process and return to the module identifier.

PRESET DEFINITION 2**EDIT ASSIGNMENT**

Use this function to change the assignment of a voice within a preset.

1. Activate **PRESET DEFINITION 2**. The display says:

Edit Pri or Sec
Voice: XXX

...where XXX is either Pri or Sec. Use the data slider to select whether you will edit the primary or secondary voice, then press **ENTER**. If there are only primary or secondary voices, Emax II will automatically go to step 2.

2. The display now says:

Edit: XX
Select A Voice

...where XX defaults to the lowest note of the lowest voice (whether Pri or Sec).

Press a key in the range of the voice that you want to edit, or to quickly select the voice, use the data slider. While selecting the voice, the lower display line will show the voice number and its original pitch. After selecting the voice to edit, press **ENTER**.

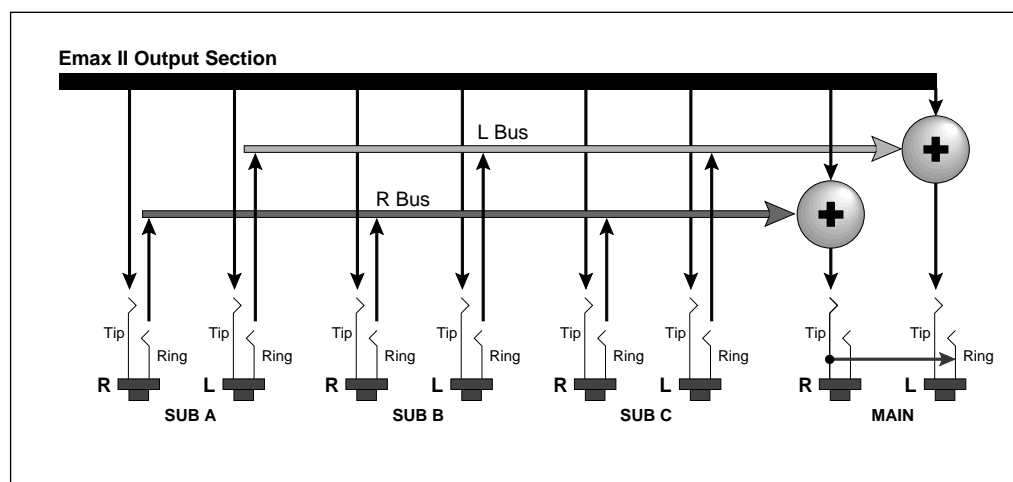

The Sub A, B, and C jacks can be used as effect returns to the Main Outputs.

▼ When editing stereo voices, make sure that the keyboard assignments of the primary and secondary voices match to prevent undesirable results.

PRESET DEFINITION

3. The display now shows the complete assignment:

| | | | |
|------|----|----|-----|
| Orig | Lo | Hi | Out |
| XX | XX | XX | Y |

...where XX are notes and Y is one of the 4 stereo output channels.

Place the new original note. If the display says "Illegal Asgnment," you are doing something like placing the lower note above the original. Play a key to select notes, and the cursor buttons to select the desired parameter to be changed. Note: You can also use the data slider to show the available keys.

To select the output channels (Out) over which the voice will appear, move the cursor under Out and select the desired output - **Main**, or one of the **A, B, C** submix outs. Press **ENTER**, and the Emax II will return to the module identifier.

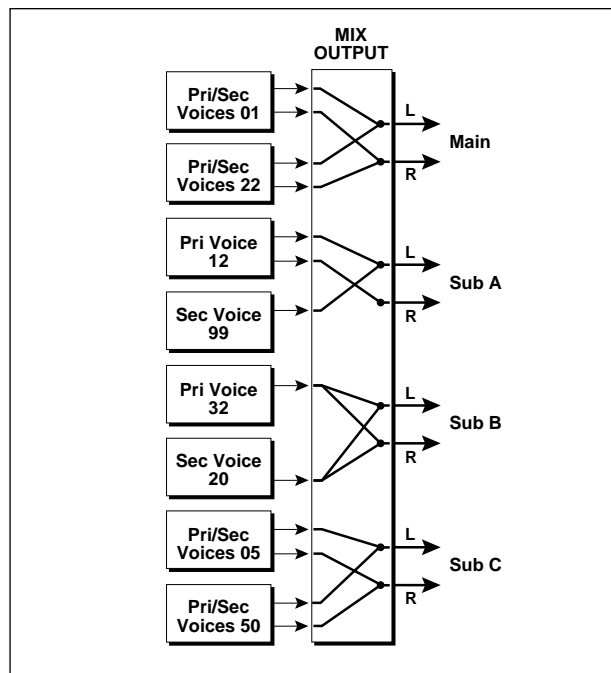

A voice may be assigned to any stereo output pair.

PRESET DEFINITION

PRESET DEFINITION 3

ERASE VOICE(S)

Use this function to erase a voice(s).

1. Activate **PRESET DEFINITION 3**. The display shows:

Erase Pri, Sec
or Both: XXX

... where XXX is either Pri, Sec or Both.

Use the data slider to select whether you will erase the primary, secondary, both voice(s), then press **ENTER**. If there are only primary or secondary voices, Emax II will automatically go to step 2.

2. The display says:

Lo:XX
Select Lo Key

...where XX defaults to the lowest note of the lowest voice (whether Pri or Sec).

3. Press the lowest key of the range you want to erase, or to quickly select the lowest note of the available voices, use the data slider. While selecting the low key, the lower display line will show the voice number and its original pitch. When the display shows the desired low key, press **ENTER**. The display now asks you to choose the Hi Key:

Lo:XX Hi:YY
Select Hi Key

...where YY defaults to the highest note of the previously selected voice.

4. Press the highest key of the range you want to erase or to quickly select the highest note of the available voices, use the data slider. After selecting the range to erase, press **ENTER**.

5. The display will warn you if this assignment either modifies the existing assignment or erases (overwrites) any existing voice(s). If this is okay, press **YES** to erase and return to the module identifier. Otherwise, press **NO** to interrupt the erasing process and return to the module identifier.

PRESET DEFINITION

PRESET DEFINITION 4

STEREO VOICE

The Emax II plays back stereo samples, with no loss of polyphony. Stereo is implemented using the primary and secondary voices and selecting Stereo Voice mode.

Stereo Voice mode uses all *primary* voice parameters for *both* primary and secondary layers. With Stereo Voice off, the primary and secondary voice parameters are totally independent and no sharing of functions occurs.

In order for a key to *become* stereo, it must meet all of the following criteria:

- The primary and secondary voices must be assigned to the same keyboard range.
- Both primary and secondary voices must have the same original key.
- Both primary and secondary voices must have the same sample rate.

The above rules must not be violated after a stereo voice has been created or unpredictable (and undesirable) side effects may result (wrong pitches, etc.).

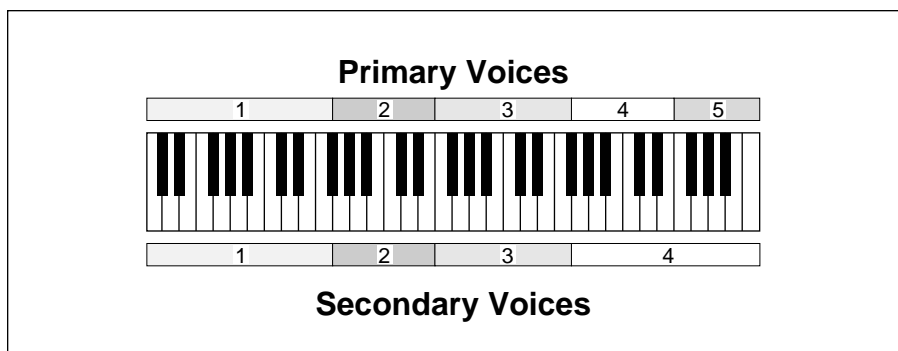

In this diagram, voices 1, 2 and 3 are eligible to become stereo, if the primary and secondary voices have the same original keys and the same sample rates.

1. Activate **PRESET DEFINITION 4**. The display shows:

```
Lo:XX Stereo:Off
Select Lo Voice
```

...where XX defaults to the lowest note of the lowest voice.

Press the lowest key of the low voice that you want to put into or out of stereo voice mode, or to quickly select the low voice, use the data slider. While selecting the low voice, the display will show the voice number, its original pitch and whether the voice has stereo on or off. After selecting the low voice, press **ENTER**.

- Stereo Voice mode may be used to "stack" voices without loss of polyphony, since the primary and secondary voices need not be the same instrument.

PRESET DEFINITION

2. Now the display shows:

```
Hi:XX Stereo:Off
Select Hi Voice
```

...where XX defaults to the highest note of the previously selected voice. Press the highest key of the highest voice that you want to put into or out of stereo voice mode, or to quickly select the voice, use the data slider. After selecting the high voice, press **ENTER**.

3. Now you see...

```
Stereo Voice:XX
Select on/off
```

...where XX is either on or off. Use the **ON** and **OFF** buttons to select whether stereo voice is on or off, then press **ENTER**. The Emax II will inform you that secondary parameters will be altered if you select stereo voice on. If that's okay, press **YES**; otherwise, press **NO** to abort and the Emax II will return to the module identifier.

Note: Stereo Voice mode automatically pans the primary and secondary voices to opposite sides. If the stereo pan position (**DYNAMIC PROCESSING 19**) is altered, the primary and secondary voice pan positions will move in opposing directions. In the center position, the signal will be monophonic.

■ *Using Chorus mode with stereo voices produces a beautiful stereo chorus effect.*

PRESET DEFINITION

PRESET DEFINITION 5 VELOCITY XFADE/SWITCH, POSITIONAL XFADE

Velocity Crossfade crossfades between the primary and secondary voices according to how hard you play the keyboard. One voice will become louder as you play harder and softer as you play softer, while the other voice will become louder as you play softer and softer as you play *harder*. Velocity switch is similar, however, there is a threshold above which one voice plays and below which the other voice plays.

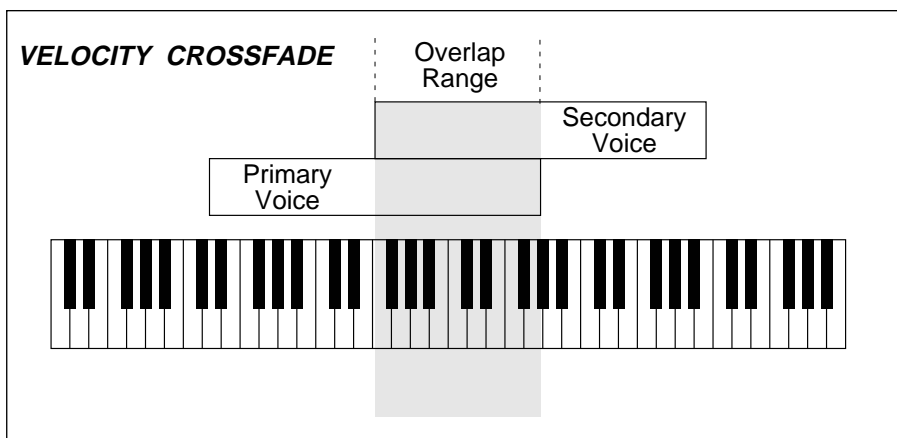

When playing in the shaded range, if the secondary voice equals "Hard", then the primary voice becomes progressively softer and the secondary voice becomes progressively louder as you strike a key with increasing force.

Where two voice's keyboard assignments overlap, Positional Crossfade alters the level balance (mix) between the two voices depending on where you play within the overlap range.

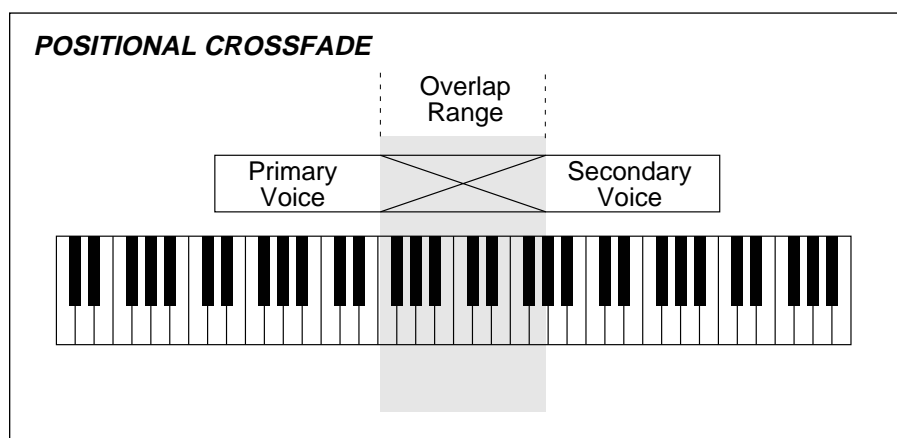

When playing from left to right across the shaded range, the primary voice fades out as the secondary voice fades in.

PRESET DEFINITION

Velocity XFade Application: Fade between cellos and violins, depending on how hard you play a key. Have a fuzz guitar sound assigned so that playing softly plays the fundamental, and playing harder brings in a feedback note an octave above the fundamental.

Positional XFade Application: Transposing a sampled sound lower usually produces a more muffled sound than the original sample, and transposing upwards usually produces a thinner, brighter sound. Overlapping voices and using Positional Crossfade can balance out the voice timbres; as one voice becomes progressively brighter, it can be fading out as the overly muffled part of the next voice fades in. Combining the overly thin and overly muffled voices in the correct proportion can produce an overall timbre that ends up sounding just right.

1. Activate **PRESET DEFINITION 5**. The display says:



Lo:XX
Select Lo Key

...where XX defaults to the lowest note of the lowest voice. Press a key in the range of the low voice that is to be crossfaded, or to quickly select the voice, use the data slider. While selecting the voice, the lower display line will show the voice's crossfade status. After selecting the low voice, press **ENTER**.

2. Now the display shows:

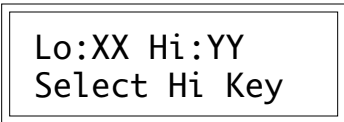

Lo:XX Hi:YY
Select Hi Key

...where XX defaults to the highest note of the previously selected voice. Press a key in the range of the highest voice that is to be crossfaded, or to quickly select the voice, use the data slider. After selecting the high voice, press **ENTER**.

3. The display now says:

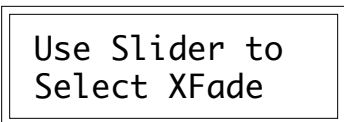

Use Slider to
Select XFade

PRESET DEFINITION

You now may select from the following choices:

- **XFade Off** = There is no crossfading between the primary and secondary voices.
- **Velocity XFade** = One voice will become louder as you play more forcefully; the other voice will become softer.
- **Velocity XSwitch** = If you strike a key with more force than the mid-point of the velocity range, one voice will play; if you strike a key with less force than the mid-point of the velocity range, the other voice will play.
- **Positional XFade** = As you play from low to high over the current voice, one voice will fade out as the other voice fades in. This is a useful technique for maintaining an even tone quality over the keyboard when using multi-samples.
- **Realtime XFade** = Crossfading occurs not according to keyboard velocity, but according to the real time controller that has been assigned. (See Preset Definition 9)
- **Realtime XSwitch** = Crossfading occurs not according to keyboard velocity, but according to the real time footswitch.

4. If you choose any option except for Positional XFade, the display says:

Pri or Sec Voice
Equals Hard: Sec

Use the data slider to select whether the primary or secondary voice will:

- Fade in when the keyboard is played forcefully (Velocity XFade);
- Switch in when the keyboard is played forcefully (Velocity XSwitch);
- Fade in according to the real time control wheel (Realtime XFade); or
- Switch in according to the real time footswitch (Realtime XSwitch).

If you choose Positional Crossfade, the display will say:

Pri or Sec Voice
On Top: Sec

The selected voice will become more prominent as you play higher on the keyboard, and the other voice will become less prominent.

5. After making your selection, press **ENTER**.

PRESET DEFINITION

PRESET DEFINITION 6

ARPEGGIATOR SETUP

You're going to love this arpeggiator: It does a lot and it's easy to set up. Best of all, arpeggiation settings are stored with the preset so that different presets can have totally different arpeggiation characteristics. Also, arpeggiation can be assigned to any range of the keyboard or the entire keyboard, and some arpeggiation parameters can be altered in real time for expressive arpeggiation.

1. Select the current preset; this preset will contain the arpeggiation information.
2. Activate **PRESET DEFINITION 6**. The display says:

Arpeg Setup Menu
Use Cursor Keys

Use the cursor keys to select the various Arpeggiator options or press **ENTER** to jump back to the module identifier.

The first arpeggiation option display says:

Arpeggiator: off
Select on/off

Select the desired arpeggiator status with the **ON** or **OFF** buttons. To jump back to the module identifier press **ENTER**, otherwise press the right arrow cursor key to continue the setup.

3. The next display says:

Tempo: ♩ =120.00
[040-240]Inc/Dec

Use the data slider or the numeric keypad to adjust the tempo through the range from 40-240 Beats Per Minute. Press the right cursor key to do fine adjustment to the tempo. Use the data slider or the numeric keypad to adjust the tempo through the range from .00-.99 Beats Per Minute.

If you have selected a clock other than the internal clock, (see next menu item), the arpeggiator will follow and display this clock rather than the internal clock.

PRESET DEFINITION

4. The next menu item chooses the note value; the display says:

Note Value: 1/16
Use Data Slider

Use the data slider to select between the following arpeggiation note values: 1/2 note, 1/4 note, 1/4 triplet, 1/8, 1/8 triplet, 1/16 (default setting), 1/16 triplet, 1/32, 1/32 triplet, and (believe it or not) 1/96 note. The note value can be manipulated in real time. To jump back to the module identifier press **ENTER**, otherwise press the right arrow cursor button to continue the setup.

5. The next display is:

Mode: fwd assign
Use Data Slider

Use the data slider to catalog the various modes.

- **UP** held notes arpeggiate continuously from lowest to highest pitch.
- **DOWN** held notes arpeggiate continuously from highest to lowest pitch.
- **UP/DOWN** held notes first arpeggiate from lowest to highest pitch, then from highest to lowest, then repeat this cycle.
- **FWD ASSIGN** held notes arpeggiate continuously in the order in which the keys were pressed.
- **BKWD ASSIGN** held notes arpeggiate continuously in the reverse order in which the keys were pressed.
- **RANDOM** held notes arpeggiate continuously in a random fashion.

To jump back to the module identifier press **ENTER**, otherwise press the right arrow cursor key to continue the setup.

6. The next display says:

Latch: off
Use Data Slider

PRESET DEFINITION

Use the data slider to catalog the various modes.

- **OFF** No latching of notes. When you release your fingers from the keys, arpeggiation stops.
- **AUTO** When you release your fingers from the keys, arpeggiation continues. When you press down new keys, the old notes stop arpeggiating and the new ones arpeggiate instead.
- **EXTEND** Same as auto, except that new notes are added in with old notes, thus all played notes arpeggiate.
- **MEMORY** Holds your arpeggio in memory until an un-latched, arpeggiator-on preset is selected. Arpeggios can be set up in advance, then started on command with the arpeggiator footswitch or by selecting the memory arpeggio preset.

To jump back to the module identifier press **ENTER**, otherwise press the right arrow cursor key to continue the setup.

7. To understand the next two menu items, let's define a couple of terms:

An arpeggio *Interval* specifies what additional intervals will be played if you play a key. For example, suppose you played C2 with an interval of 5 (a major fifth) and up mode arpeggiation. the Emax II would arpeggiate between C2 and G2.

An arpeggio *Extension* specifies how many times the interval will be extended. For example, with an interval of M3 (major third) and an extension of 04 (four times), if you played a C2 with the arpeggiator in up mode the arpeggiated sequence would consist of C2, E2 (a major third above C2), G#2 (a major third above E2), C3 (a major third above G#2) and the fourth extension, E3.

8. The next menu item after velocity specifies the number of extensions in the arpeggio. The display says:

Number of Ext:00
Use Data Slider

Use the data slider or the numeric keypad to step through the number of extensions, from 00 to 15. To jump back to the module identifier press **ENTER**, otherwise press the right arrow cursor button to continue the setup.

PRESET DEFINITION

9. The next menu item produces the following display:

Interval: Oct
Use Data Slider

Use the data slider to specify the arpeggiation interval, as listed below:

m2 = minor second
M2 = major second
m3 = minor third
M3 = major third
P4 = perfect fourth
m5 = minor fifth
P5 = perfect fifth
m6 = minor sixth
M6 = major sixth
m7 = minor seventh
m9 = minor ninth
M9 = major ninth
Oct = octave
m10 = minor tenth
M10 = major tenth

To jump back to the module identifier, press **ENTER**, otherwise press the right arrow cursor button to continue the setup. Note that you can change the interval in *real time* for some really nifty arpeggiation effects.

10. But wait, there's more!! The next great option is Harmony 1. This option plays a second note at the chromatic interval from the base note specified on the display. The interval is adjustable from a minor second, up to a major tenth. The display says:

Harmony 1: off
Use Data Slider

Use the **ON** and **OFF** buttons or the **DATA SLIDER** to adjust the interval or turn the function off.

11. The next arpeggiator option is Harmony 2, which plays another note, (making a total of three notes if Harmony 1 is also selected) at the chromatic interval from the base note specified on the display. The interval is adjustable from a minor second, up to a major tenth.

PRESET DEFINITION

The display says:

Harmony 2: off
Use Data Slider

Use the **ON** and **OFF** buttons or the **DATA SLIDER** to adjust the interval or turn the function off.

12. The next setup menu is for external clock. Press the right arrow cursor button, and the display says:

Clock: internal
Use Data Slider

Use the data slider buttons to choose the desired clock option. Your choices are:

- **internal** Emax II's arpeggiator syncs to the internal clock at the tempo chosen in the previous step.
- **MIDI** Emax II's arpeggiator syncs to MIDI clock signals coming in over the MIDI in port.
- **click 24** Emax II's arpeggiator syncs to 24 pulses-per-quarter-note signals appearing at the clock input jack.
- **click 48** Emax II's arpeggiator syncs to 48 pulses-per-quarter-note signals appearing at the clock input jack.
- **click 96** Emax II's arpeggiator syncs to 96 pulses-per-quarter-note signals appearing at the clock input jack.

To jump back to the module identifier press **ENTER**, otherwise press the right arrow cursor button to continue the setup.

13. Moving right along, the next option is:

Velocity: 127
Use Data Slider

PRESET DEFINITION

Use the data slider or numeric keypad to set the arpeggiator velocity value. The lowest possible value (obtained by entering **000**) gives the following display:



Velocity: Played
Use Data Slider

Each note will arpeggiate at a volume level determined by the velocity with which the note was played. Use the data slider to select the range of MIDI velocity values (1-127), with larger numbers giving louder levels if the dynamics are mapped to level; when mapped to other parameters, they are affected appropriately.

To jump back to the module identifier press **ENTER**, otherwise press the right arrow cursor key to continue the setup.

14. But wait, there's still more! Key Repeats sets the number of times that each note plays before moving on to the next note in the arpeggio. The display says:



Key Repeats: 1
Use Data Slider

Use the **ON** and **OFF** buttons or the **DATA SLIDER** to select the desired number of repeats on each note (1-8).

15. The next arpeggiator option is Cruz Control, which fits the number of notes you're holding into the specified note value (if you can't picture this effect, then give it a try and you'll hear what it does).

The display says:

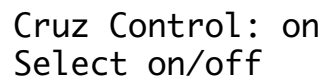

Cruz Control: on
Select on/off

Use the **ON** and **OFF** buttons to select whether Cruz Control is on or off

Note: Cruz Control cannot be used when either Key Repeats or Glissando are on. Turning on Cruz Control will simply turn off Key Repeats and Glissando.

PRESET DEFINITION

16. The next arpeggiator option is Glissando. The display says:

Glissando: off
Select on/off

Use the **ON** and **OFF** buttons to select whether Glissando is on or off. Glissando will play every chromatic step between the notes played, including extensions.

17. Last, but not least comes the range adjustment. The display says:

Range: A-1 to C7
Select Lo Key

This is the default setting and indicates that arpeggiation will occur in the range of A-1 to C7 (the full MIDI range of notes). Play the key that corresponds to the lowest note in the range you want arpeggiated (or use the data slider), then press the **RIGHT ARROW** key. The cursor will move to the second note in the display, which now says:

Range: XX to C7
Select Hi Key

...where XX is the note you just selected. Now play the note that corresponds to the highest note in the range you want arpeggiated (or use the data slider).

The display will confirm your choice; press **ENTER** to jump back to the module identifier, otherwise press the right arrow cursor button to continue the setup. Note: The Emax II will not let you choose a lower note higher than the currently selected upper note.

Now that the arpeggiation setup is complete, press **ENTER** to jump back to the module identifier. Or, you can use the cursor keys to go back and change previously selected parameters.

PRESET DEFINITION

PRESET DEFINITION 7

MIDI SETUP

MIDI is a way of exchanging musical information between various electronic music instruments. If you are not familiar with MIDI, read the “MIDI Supplement” in the Advanced Applications section before continuing.

1. With all modules de-activated, select the current preset. This preset will contain the default MIDI parameters, which you may now proceed to change for your particular application. Note that different presets can have different MIDI parameters.
2. Activate **PRESET DEFINITION 7**. The display says:

MIDI Setup Menu
Use Cursor Keys

Move the cursor keys to identify the various MIDI options. The first display says:

Basic Channel 01
[01-16] /Slider

This is the default channel over which this particular Emax II preset will send and receive MIDI information. To change channels, use the data slider or the numeric keypad. To jump back to the module identifier press **ENTER**, otherwise press the right arrow cursor button to continue the setup. MIDI channels can be set globally using the MIDI Master function (**MASTER, Special 2**).

3. The next display says:

MIDI Port: Out
Use Data Slider

The MIDI out connector can be set to provide one of two functions, MIDI out (i.e., data you play on the keyboard flows out the MIDI port) or MIDI thru (i.e., the MIDI out port echoes what's being received at the MIDI in port). To select, use the data slider. To jump back to the module identifier press **ENTER**, otherwise press the right arrow cursor button to continue the setup.

PRESET DEFINITION

4. The next display says:

MIDI Mode: omni
Use Data Slider

Use the data slider to change MIDI mode as follows:

- **OMNI** accepts MIDI information coming in on any channel.
- **POLY** accepts MIDI information only on the basic channel.

After making your selection, press **ENTER** to jump back to the module identifier, otherwise press the right arrow cursor button to continue the setup.

5. The next display says:

Preset Chng: on
Select on/off

MIDI also carries program (preset) change information from one synthesizer to another. Press **ON** if you want the Emax II to send and receive program changes, or **OFF** if you want to select Emax II presets independently of other MIDI instruments. To jump back to the module identifier press **ENTER**, otherwise press the right arrow cursor key to continue the setup.

Note: There is no specific standard between manufacturers regarding what program ("patch") will occur on "slave" synthesizers when a particular program is selected on the "master" synthesizer. Some instruments number programs sequentially, while others arrange programs in "banks" (e.g., A1, A2, A3,...B1, B2, etc.).

6. The next display says:

Start/Stop: off
Select on/off

When connected in a MIDI system, you may or may not want the Emax II to respond to "start and stop sequence" commands from other instruments, preferring instead to start and stop sequences from the Emax II. Press **ON** if you want the Emax II sequences to start and stop under control of another MIDI instrument; press **OFF** if you want to start and stop sequences exclusively from the Emax II.

PRESET DEFINITION

To jump back to the module identifier press **ENTER**, otherwise press the right arrow cursor button to continue the setup.

7. Moving right along we see:

```
Local Cntl: on
Select on/off
```

If you press **ON** (the default setting), the Emax II keyboard controls the Emax II sound generators and sends out MIDI data about which keys are being played. Pressing **OFF** “disconnects” Emax II from its keyboard, but still sends out MIDI data about which notes are being played. To return to the module identifier press **ENTER**, otherwise press the right arrow cursor button to continue the setup.

8. The next screen says:

```
Notes, Wheels: on
Select on/off
```

Press **ON** if you want the Emax II to send and receive note and wheel MIDI data as well as MIDI clock signals. Press **OFF** if you want the Emax II to send and receive MIDI clock signals but not note and wheel signals. To return to the module identifier press **ENTER**, otherwise press the right arrow cursor button to continue the setup.

9. The next item of interest is...

```
Lt Wheel <-> pwh
[00-33] /Slider
```

Moving the data slider upwards increases the MIDI controller number assigned to the left wheel, while moving the data slider downwards decreases the controller number. Or, hold either button to “fast forward” or “fast backward” through the range of MIDI controller numbers (off, 00 to 33). You may also enter a two-digit value with the numeric keypad, however, this will not allow you to enter off. Note that 32 assigns the Left Wheel to the standardized controller number for pitch bend (pwh), and 33 assigns the Left Wheel to the standardized controller for monophonic pressure (aftertouch, or chp).

Note: MIDI controller assignments are bi-directional. Example: If the left wheel is assigned to controller number 12, then the Emax II will send out controller data over 12 when the left wheel is moved; when the Emax II receives MIDI data over controller number 12, it will interpret this as if the left wheel was being moved.

Some of the standard MIDI Controller numbers are listed below.

- 1 - Modulation Wheel or Lever
- 2 - Breath Controller
- 3 - Pressure: Rev 1 DX7
- 4 - Foot Pedal
- 5 - Portamento Time
- 6 - Data Entry
- 7 - Volume
- 8 - Balance
- 9 - Undefined
- 10 - Pan

PRESET DEFINITION

To return to the module identifier press **ENTER**, otherwise press the right arrow cursor button to continue the setup.

10. The next screen says:

```
Rt Wheel <-> 01
[00-33] / Slider
```

You may now assign a controller number to the Right Wheel in exactly the same manner as you assigned a controller number to the Left Wheel in step 9. To return to the module identifier press **ENTER**, otherwise press the right arrow cursor button to continue the setup.

11. The next display shows:

```
Pedal <-> off
[00-33] / Slider
```

You can now assign a controller number to the Pedal in exactly the same manner as you assigned a controller number to the Left Wheel in step 9. To return to the module identifier press **ENTER**, otherwise press the right arrow cursor button to continue the setup.

12. We're not done yet. The next displays says:

```
Pressure <-> chp
[00-33] / Slider
```

You may now assign a controller number (chp = the MIDI standard for monophonic pressure) to the keyboard's pressure (aftertouch) function in exactly the same manner as you assigned a controller number to the Left Wheel in step 9. To return to the module identifier press **ENTER**, otherwise press the right arrow cursor button to continue the setup.

13. The next display says:

```
MIDI A <-> pwh
[00-33] / Slider
```

■ *The Emax II keyboard does not generate aftertouch (pressure). The Pressure function is used to route incoming pressure data when received over MIDI.*

PRESET DEFINITION

Real-time parameters (pitch, filter cutoff, level, LFO to pitch modulation, etc.) can be assigned to MIDI control source A (see **PRESET DEFINITION 9** for more information about control sources). You may then assign each MIDI control source to correspond to specific MIDI controller on another synthesizer.

Example: Suppose a second MIDI unit's vibrato controller is assigned to MIDI control number 01, and that MIDI control source A on Emax II controls the filter cutoff frequency. Selecting 01 for MIDI control source A would control Emax II's filter cutoff frequency via the second MIDI unit's vibrato information. (Assuming, of course, that the Emax II and the other MIDI unit are connected via MIDI.)

This step of the set-up procedure lets you assign a number to the MIDI control source that matches up with the number of the controller "transmitting" data from a MIDI unit into the Emax II. (For more information on controller numbers, see the MIDI supplement.) Controller numbers are assigned in exactly the same manner as you assigned a controller number to the Left Wheel in step 9.

To jump back to the module identifier press **ENTER**, otherwise press the right arrow cursor key to continue the setup.

14. The next display shows:

MIDI B <-> 01
[00-33] / Slider

Assign a controller number to control source B in exactly the same manner as you assigned a controller number to control source A in step 13.

This completes MIDI setup for the current preset. To return to the module identifier press **ENTER**, or if you want to change some parameters, dial them in with the cursor buttons.

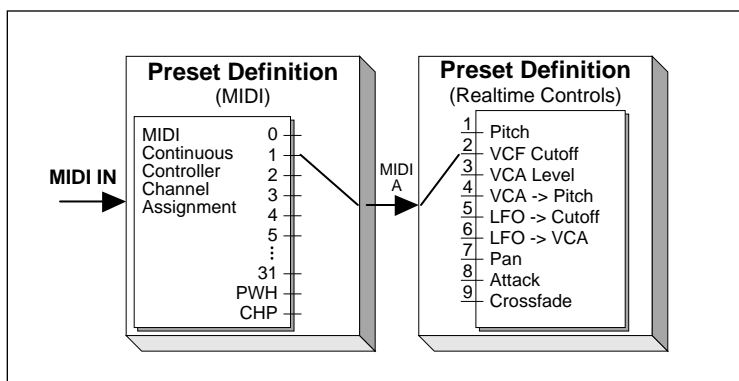

MIDI A and MIDI B can be thought of as "patchcords" which connect the MIDI Continuous Controller channels to the proper Realtime Control destination.

■ Remember to Save to Disk, or all your programming will be lost.

PRESET DEFINITION

PRESET DEFINITION 8

PITCH BEND RANGE

This function adjust the pitch wheel range from +0 (off) to ± 4 semitones.

1. Activate **PRESET DEFINITION 8**. The display says:

Pitchbend Range:
 $\pm X$ semitones

...where X is a number between 0 and 4.

2. Select the desired number with the data slider, numeric keypad. Press **ENTER** after making your choice, and the Emax II will return to the module identifier.

PRESET DEFINITION 9

REAL-TIME CONTROLS

Real-time functions are designed for fast, easy selection while playing live. Each preset can have its own unique set of pre-programmed realtime functions.

1. Activate **PRESET DEFINITION 9**.

2. The display shows each control source as a pair of numbers. The first digit of each pair represents the control source (e.g., wheel, pedal, etc.), the second digit the control source's destination (filter cutoff, pitch, etc.). Select the control source to which you want to assign a destination by keying in the appropriate control source number:

- 1: Left wheel (center detent, spring return type)
- 2: Right wheel (continuously variable type)
- 3: Pressure (sent from an external MIDI keyboard that has pressure sensitivity)
- 4: Pedal A/D (plugs into rear panel PEDAL jack)
- 5: MIDI control A
- 6: MIDI control B
- 7: Footswitch 1 (plugs into rear panel Foot Switch 1 jack)
- 8: Footswitch 2 (plugs into rear panel Foot Switch 2 jack)

1:1 2:4 3:0 4:0
 5:3 6:0 7:3 8:2

■ *The first number of each group represents the control source and the second number represents the destination.*

Each of destinations 0-9 printed in the upper part of the right-hand column located in the Preset Definition module can be controlled by control sources 1 through 4. Each destination can be controlled by only one of the 4 Emax II controllers.

PRESET DEFINITION

In addition to being controlled via Emax II's controllers, these destinations can alternatively be controlled via MIDI. These MIDI control sources are given controller numbers (see **PRESET DEFINITION 7**). These numbers match up with the numbers of the controllers "transmitting" data from a MIDI unit into the Emax II. For more information, see the MIDI supplement.

Each of destinations 0-6 printed in the lower right-hand column of the module can be controlled by sources 7 and 8 (footswitches). Each destination can be controlled only by a single source.

3. After keying in the source number, the cursor will flash under the second number of the pair, indicating that you may now select one of the destinations printed on the right-hand side of the module. These are described in more detail below.

Note: Realtime functions usually control all voices on the keyboard. However, when making up a preset, it is possible to exempt voices from real-time control. This is described fully in **DYNAMIC PROCESSING 22** ("Control Enable").

Note: For some presets on factory disks, default destinations will already have been selected. For other presets, all control sources will be turned OFF (0).

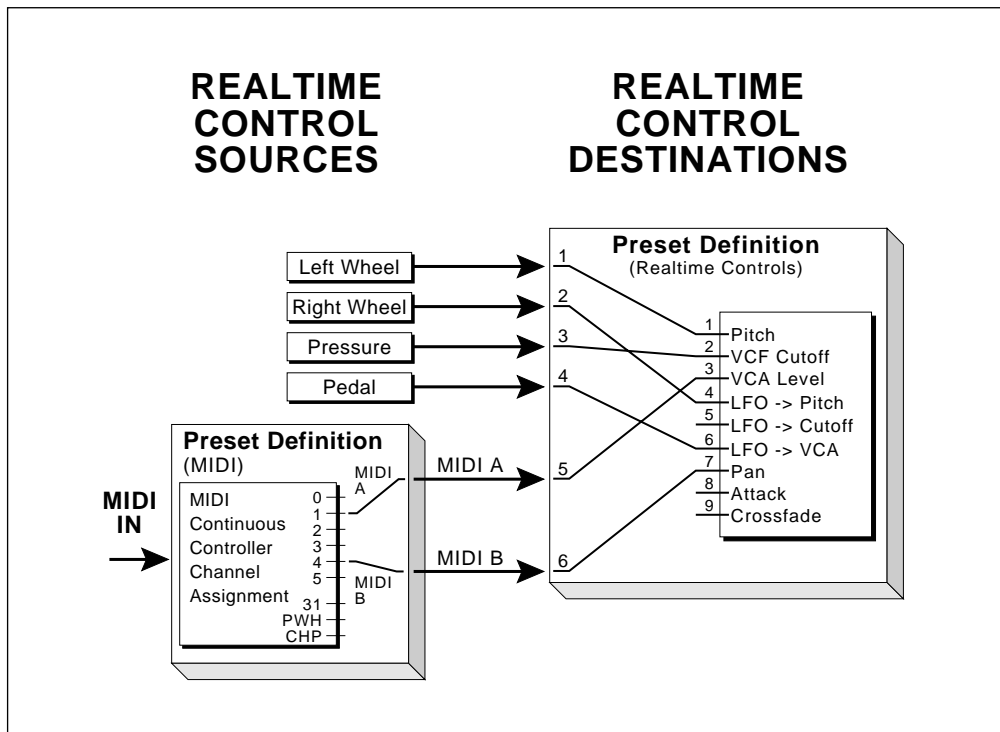

This diagram shows how realtime controllers can be connected to the various destinations.

PRESET DEFINITION

REALTIME CONTROL DESTINATIONS

● Destination: 0 OFF

To turn off (disable) the control source, first select the control source then select 0.

● Destination: 1 PITCH

To assign pitch bend to the control source, first select the control source then select 1.

Application: Generally, this destination is assigned to the left-hand wheel, which has a center detent. When so assigned, the center position gives no pitch bend. Rotating the wheel away from you bends pitch up, while rotating the wheel towards you bends pitch down. Maximum pitch bend is ± 4 semitones, as set in **PRESET DEFINITION 8**.

● Destination 2 FILTER Fc

To assign filter cutoff frequency control to the control source, first select the control source then select 2.

Application: This destination is normally assigned to the right wheel, pressure, or pedal to add expressiveness to your playing. Example: Brass sounds often increase in brightness towards the end of notes; simulate this by using the wheel to increase the filter cutoff frequency towards the end of a note. FILTER Fc can also be assigned to the Pedal for “wa-wa” effects; turn up the Q to simulate the most commonly used wa-wa sound.

Note: This function interacts with the filter module frequency and envelope settings. If the wheel does not seem to be working correctly, check these settings. Example: If the filter cutoff is already at maximum, you will not be able to use the wheel to increase the cutoff frequency. Therefore, for the right wheel to cover the greatest possible filter sweep, select **DYNAMIC PROCESSING 13** (“filter Fc”) and set Env (envelope) to +00. Next, assuming that the right wheel is assigned to filter Fc, rotate it fully towards you and adjust Fc for the lowest desired filter cutoff frequency. Rotating the right wheel away from you will increase the filter cutoff.

● Destination: 3 LEVEL

To assign overall level to the control source, first select the control source then select 3.

Application: Probably the most common use is to assign LEVEL to the pedal, thus giving pedal-controlled volume. Or, assign this destination to the Right wheel when you need a manual volume control (such as during fadeouts) or to a MIDI control for pseudo-automated mixdown effects when driving Emax II from a sequencer.

■ To assign Emax II **Level** to the MIDI standard controller #7, first assign MIDI A or B to #7 (MIDI Menu), then assign the MIDI A or B to Level.

PRESET DEFINITION

Assigning LEVEL to the left wheel can also be useful. At center position, the volume level is audible but can be increased by rotating the wheel away from you. Rotate the wheel towards you to fade out the sound completely.

● Destination: 4

LFO to PITCH

This function controls the extent (i.e., modulation index) to which the LFO modulates pitch. To assign this destination to the control source, first select the control source then select 4. (To change the LFO rate and LFO variation, refer to **DYNAMIC PROCESSING 15.**)

Application hint: This destination is most often assigned to the right wheel; rotating the wheel away from you increases the amount of vibrato. Assigning this destination to the pedal provides foot-controlled vibrato.

Note: Assigning this destination overrides the equivalent Dynamic Processing module function.

● Destination: 5

LFO to FILTER Fc

This function controls the extent to which the LFO modulates the filter cutoff frequency. To assign this destination to the control source, first select the control source then select 5. (To change the LFO rate and LFO variation, refer to section **DYNAMIC PROCESSING 15.**)

Application: This destination is most often assigned to the right wheel; rotating the wheel away from you increases the amount of filter modulation (“filtrato”) which is a type of timbre modulation. Assigning this destination to the pedal provides foot-controlled filtrato. Slow filtrato is useful for varying the timbre on long, sustaining sounds; fast filtrato gives a “bubbly” sound which can resemble that of mechanical rotating speaker systems.

Note: Assigning this destination overrides the equivalent Dynamic Processing module function. Also, LFO to FILTER Fc interacts with the filter module frequency and envelope settings. If this function does not seem to work, check these settings. Example: If the filter cutoff is already at maximum, you will not be able to modulate it to any great degree.

● Destination: 6

LFO to LEVEL

This function controls the extent to which the LFO modulates the overall level (this phenomenon is called tremolo). To assign this destination to the control source, first select the control source then select 6. (To change the LFO rate and LFO variation, refer to section **DYNAMIC PROCESSING 15.**)

PRESET DEFINITION

Application Hint: When assigned to the right wheel, rotating the wheel away from you increases the amount of tremolo. Assigning this destination to the pedal provides foot-controlled tremolo. Tremolo is useful for “Bo Diddley” and surf music guitar sounds, as well as for simulating some electric piano sounds. Assigning this destination overrides the equivalent Dynamic Processing module function.

● Destination: 7

ATTACK RATE

ATK RATE controls the VCA and VCF attack rate. To assign this destination to the control source, first select the control source then select 7.

Application hint: When assigned to the right wheel, rotating the wheel away from you increases the attack time. This effect is useful when changing from legato to percussive effects, especially with sustained sounds such as strings.

Note: With ATK RATE assigned to a wheel, Dynamic Processing module function 12, VCA attack (A) and module function 14, filter attack (A) are disabled. Therefore, filter and VCA attack rates are determined solely by the wheel setting.

● Destination: 8

PANNING

PANNING controls the spatial placement of the sound in the stereo field. To assign this destination to the control source, first select the control source then select 8.

Application Hint: When assigned to the left wheel, rotating the wheel away from you places the sound in one channel, rotating the wheel towards you places the sound in the other channel, and center wheel position places the sound in the center of the stereo field. You can also use the pedal for foot-controlled panning.

Note: Assigning this destination overrides the equivalent Dynamic Processing module function.

● Destination: 9

XFADE

XFADE allows you to crossfade between the primary and secondary voices in a preset. To assign this destination to the control source, first select the control source then select 9.

Applications Hint: When assigned to the left wheel, this function also provides for real time changes in mix between two separate sounds (e.g., strings can fade out while brass fades in, or vice-versa).

Note: This function must also be enabled under Preset Definition function 5 (Velocity XFade).

PRESET DEFINITION

FOOTSWITCH DESTINATIONS

Emax II has input jacks for two footswitches

- Destination: (Footswitch) 0 OFF

To turn off the footswitch, ***first select the footswitch then select 0.**

- Destination: (Footswitch) 1 ARP CTRL

To start and stop arpeggiation via the footswitch, ***first select the footswitch then select 1.**

- Destination: (Footswitch) 2 SEQ CTRL

To start and stop the sequencer via footswitch, ***first select the footswitch then select 2.**

- Destination: (Footswitch) 3 SUSTAIN

For footswitch controlled sustain, first select the footswitch then select 3.

Note: If you play a looped sound while the footswitch is pressed, as soon as the looped portion begins it will sustain (even after lifting your fingers off the keys) until the footswitch is released. Holding down the footswitch continuously provides a hold function for looped notes, where the last eight notes played will sustain for as long as the footswitch is pressed.

If you play an unlooped sound while the footswitch is pressed, it will play through its entire length (whether or not **it you are holding down a key), then stop.**

- Destination: (Footswitch) 4 RELEASE

For footswitch controlled release, first select the footswitch then select 4. Any note played while the footswitch is pressed will play through its entire length, whether or not you continue to hold down a key. Looped sections are not repeated unless you hold down the key. *Releasing* the footswitch cancels release.

Application: If you have a voice with a short release but where there are sounds after the end of the loop, playing the sound normally will play through to the end of the loop and you will not hear the sounds that occur after the loop. However, if you press down on the release footswitch during the loop and remove your finger from the key, the voice will play through **to the end—including the “after-loop” sounds.**

PRESET DEFINITION

- Destination: (Footswitch) 5 X-SWITCH

For footswitch controlled switching between the primary and secondary preset voices, first select the footswitch then select 5. Pressing the footswitch will alternate between the two samples.

Note: This function must also be enabled under **Pre▲*t Definition function 5 (Velocity XFade)**.

- l Destination: (Footswitch) 6 ADVANCE PRESET

To advance via footswitch from one preset to the next higher numbered preset (i.e., from Preset 01 to Preset 02), first select the footswitch then select 6. Press the footswitch momentarily to advance to the next preset. Advancing past the highest-numbered preset resets the Emax II to the lowest numbered preset.

Note: If you advance to a preset which does not have this destination assigned to one of the footswitches, you will not be able to advance out of that preset.

Hint: Use this function to return the display to the preset identifier mode when the sequencer is playing, enabling you to play different presets while listening to the sequencer.

Special Note: The Emax II is designed to work with two types of footswitches. If your **footswitch** seems to work **backwards**, refer to **Recalibrate, located under Special in the Master** module.

PRESET DEFINITION 0STACK PRESETS

This function allows you to stack up to four presets on each key of the keyboard.

In Stack Preset mode, the current preset can be "Stacked" with up to three adjacent presets above it. For instance; if the current preset is 01, then presets 02, 03, and 04 may be stacked up so that one key will sound all four presets. The polyphony of the Emax II will vary according to the **voice** architecture of each preset in the stack.

1. Select the current preset; this preset will **contain the stack** information.
2. Activate **PRESET DEFINITION 0**.

The display says:

PRESET DEFINITION

Stack Presets
XX thru YY

... where XX is the current preset and YY is the last preset that will be stacked.

3. Use the slider to select **the** number of presets to be stacked. Press ENTER after making your choice, and the E

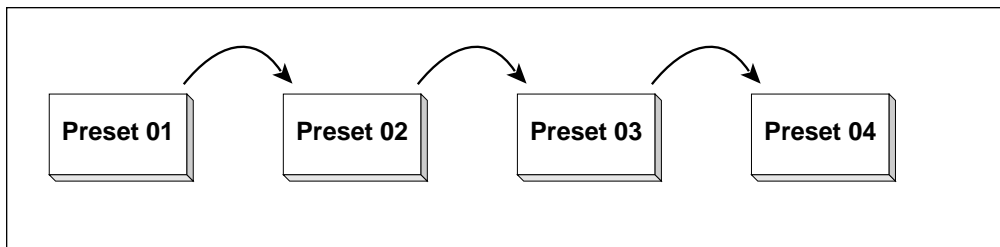

A preset may be "stacked" with up to three adjacent presets.

DYNAMIC PROCESSING

| | |
|-------------------------------|------------|
| 00. CHANGE VOICE | 149 |
| 11. ATTEN/TUNING/DELAY | 151 |
| 12. VCA AHDSR | 151 |
| 13. FILTER SETUP | 154 |
| 14. FILTER AHDSR | 156 |
| 15. LFO SETUP | 157 |
| 16. LFO TO | 158 |
| 17. VELOCITY TO A | 159 |
| 18. VELOCITY TO B | 160 |
| 19. PANNING | 161 |
| 20. CHORUS | 162 |
| 21. KYBD MODE | 163 |
| 22. CONTROL ENABLE | 164 |

DYNAMIC PROCESSING

DYNAMIC PROCESSING 00

CHANGE CURRENT VOICE(S)

This function lets you change the current voice assignment.

1. Activate **DYNAMIC PROCESSING 00**. The display will say:

```

Edit Pri, Sec or
Both Voices: XXX
  
```

...where XXX is either Pri, Sec or Both.

2. Use the data slider to select whether the primary , secondary, or both voices are to be included in the current voice group, then press **ENTER**.
3. You may select the *entire keyboard* by pressing the **DYNAMIC PROCESSING** or the **ENTER** button twice in succession.
4. If the preset contains only primary or secondary voices, the Emax II is smart enough to bypass the first screen and say:

```

Lo: XX
Select Lo Voice
  
```

...where XX defaults to the lowest note of the lowest voice. Press a key in the range of the low voice that you want to process, or to quickly select the low voice, use the data slider. While selecting the low voice, the lower display line will show the voice number, its original pitch. After selecting the low voice, press **ENTER**.

5. The display now says:

```

Lo:XX -> Hi:HH
Select Hi Voice
  
```

... where XX is the previously-selected low note and HH is the highest note of the voice that contains the lowest note. Press a key in the range of the high voice that you want to process, or to quickly select the high voice, use the data slider. After selecting the high voice, press **ENTER** to complete the current voice selection and return to the module identifier.

DYNAMIC PROCESSING

If the selected range includes part of a voice (sample), then the entire voice range will be processed, even though the display indicates the partial range. If, however, you wish to process just a portion of the voice assignment, simply copy the desired range (PRESET DEFINITION 1) back into the current preset. Emax II will now consider this a whole new voice for independent processing.

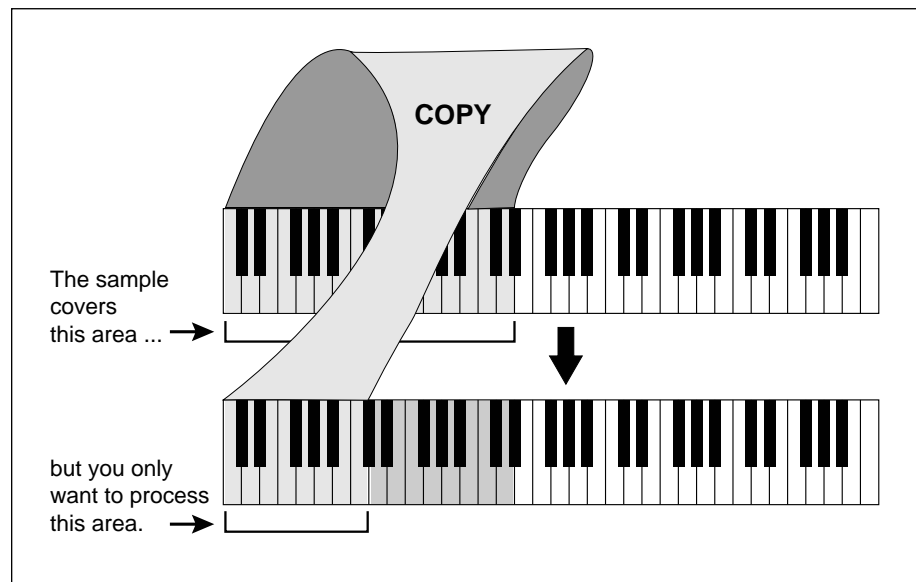

Copying a voice back to a subset of its former range gives you more voices that use the same samples. Using this technique, you could dynamically process each key separately if so desired.

DYNAMIC PROCESSING

DYNAMIC PROCESSING 11

VOICE ATTENUATION, TUNING, and DELAY

This function varies the attenuation, tuning, and delay for the current voice.

1. Activate **DYNAMIC PROCESSING 11**. The display will say:

```

Attn Tune Delay
00dB +00ct 00
```

2. Select the desired parameter for adjustment with the cursor (left arrow/right arrow) buttons, then vary the parameter as needed:

- **Attn:** Use the data slider to attenuate the voice up to 46 dB.
- **Tune:** Use the data slider to tune the voice pitch between +45 and -48 cents.
- **Delay:** Use the data slider to vary the delay between the time a key is first pressed (or MIDI data received at the MIDI input) to the onset of the note. The range is 0 to 63.

3. After making your selections, press **ENTER** to return to the module identifier.

■ *Alternate keyboard tunings may be obtained by defining each key as a voice and adjusting the voice tuning for each key.*

DYNAMIC PROCESSING 12

VCA ENVELOPE

This function sets the attack, hold, decay, sustain, and release characteristics of the VCA's AHDSR envelope generator.

Application: Change a voice's dynamics with respect to time.

1. Activate **DYNAMIC PROCESSING 12**. The display will say:

```

A: A H D S R
  XX XX XX XX XX
```

...where XX is a two-digit numeral between 01 and 32.

Hint: Filter and VCA settings interact. For example, if the VCA is set for an extremely short decay and sustain level is near 0, then you won't hear the effects of setting a long filter decay.

DYNAMIC PROCESSING

2. Select the desired parameter for adjustment with the cursor buttons, then use the data slider to change the parameter value. Refer to the diagram as you read the following descriptions of the five envelope parameters.

■ **A (Attack):** Varies the VCA envelope attack time from 01 to 32 (higher values increase the attack time).

■ **H (Hold):** Sets the duration of the peak. If a key is held down longer than the hold duration, the decay phase will begin. If a key is released during the hold duration, the release phase will begin.

■ **D (Decay):** Varies the initial decay time from 01 to 32 (higher values increase the initial decay time). 32 gives "infinite decay" (envelope stays at maximum amplitude for as long as you hold down keys).

■ **S (Sustain):** Varies the envelope sustain level from 01 to 32 (higher values give higher sustain levels).

■ **R (Release):** Varies the release time from 01 to 32 (higher values increase the release time). A setting of 32 inhibits the release phase of the envelope, thus keeping the VCA open at the previously selected Sustain level. This is useful if you want to trigger a long sound by simply tapping a key.

3. After making your selections, press **ENTER** to return to the module identifier.

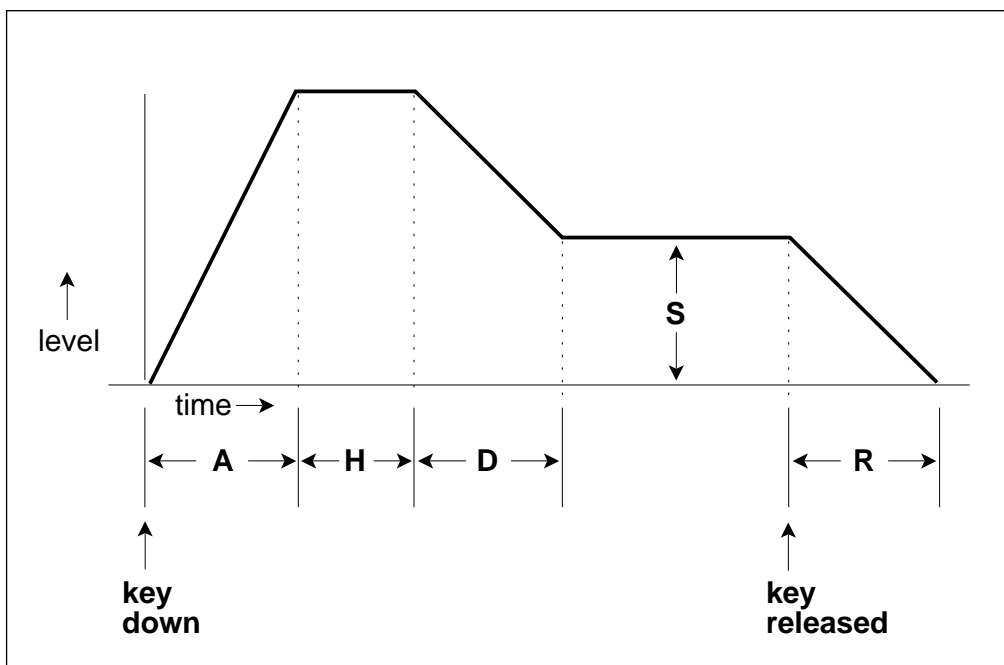

The Envelope Generators are used to shape the sound over the course of the note.

DYNAMIC PROCESSING

Note: If the filter and VCA release are both at 32 (also see **DYNAMIC PROCESSING 14**), a key will sustain at the sustain level even after you take your fingers off the keys. This is like the HOLD function found on standard synthesizers. The sound will continue to sustain unless you play more notes than there are available channels, in which case previously assigned channels will be assigned to newly played notes.

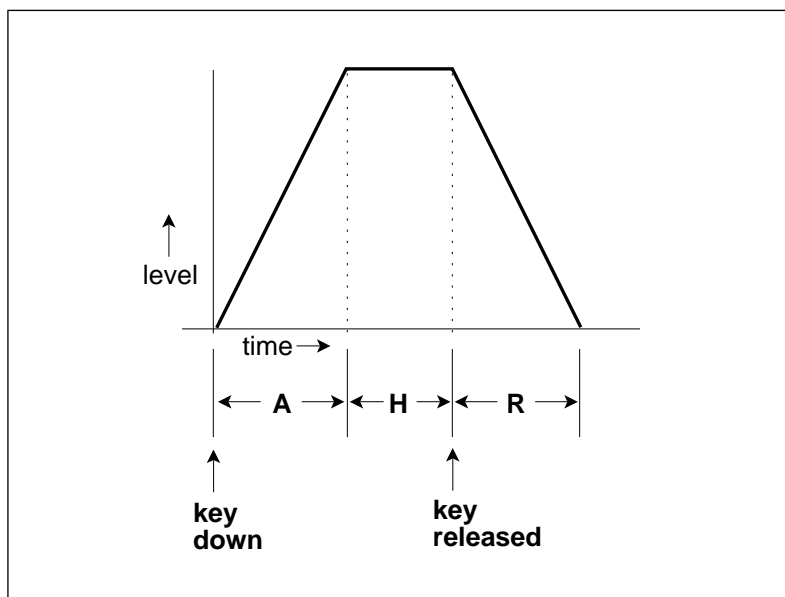

If a key is released during the Hold (H) phase, the Release (R) phase begins.

DYNAMIC PROCESSING

DYNAMIC PROCESSING 13

FILTER FREQUENCY, Q, ENVELOPE AMOUNT, TRACKING

This function determines the filter's initial cutoff frequency and Q (sharpness), the extent to which the associated AHDSR envelope affects the filter cutoff frequency, and the effect of keyboard position on cutoff frequency.

Application: Change the timbral quality of a sound.

1. Activate **DYNAMIC PROCESSING 13**. The display will say:

| | | | |
|-----|----|-----|------|
| Fc | Q | Env | Trk |
| XXX | XX | ±XX | X.XX |

Hint: Filter and VCA settings interact. For example, if the VCA is set for an extremely short decay, then you won't hear the effects of setting a long filter decay.

2. Select the desired parameter for adjustment with the cursor buttons, then use the data slider to change the parameter value. These are the parameters:

■ **Freq:** Varies the lowpass filter cutoff from 0 to 120. Higher values correspond to higher filter cutoff frequencies, hence a sound with more treble. The maximum filter sweep range is most obvious with Env set to +00.

■ **Q:** Varies the Q (resonance) from 00 to 99. Higher values correspond to increased resonance, accentuating the filter cutoff frequency, which gives a purer, more whistling sound.

■ **Env:** Varies the effect of the filter envelope (see **DYNAMIC PROCESSING 14**) on the filter cutoff frequency from -50 (maximum inverted envelope) to +00 (no envelope) to +50 (maximum positive envelope). It is usually necessary to raise the filter cutoff value when using inverted envelopes.

■ **Trk:** Varies the filter cutoff with respect to the note(s) being played on the keyboard from 0.00 (no tracking) to 1.87 (overtracking) filter-oct/keyboard-oct. With 0.00 tracking, the filter cutoff will not be affected by the keyboard pitch. With 1.00 tracking, the filter cutoff will track the keyboard pitch. With 1.87 tracking, the filter cutoff will change at almost twice as fast a rate as keyboard pitch changes.

DYNAMIC PROCESSING

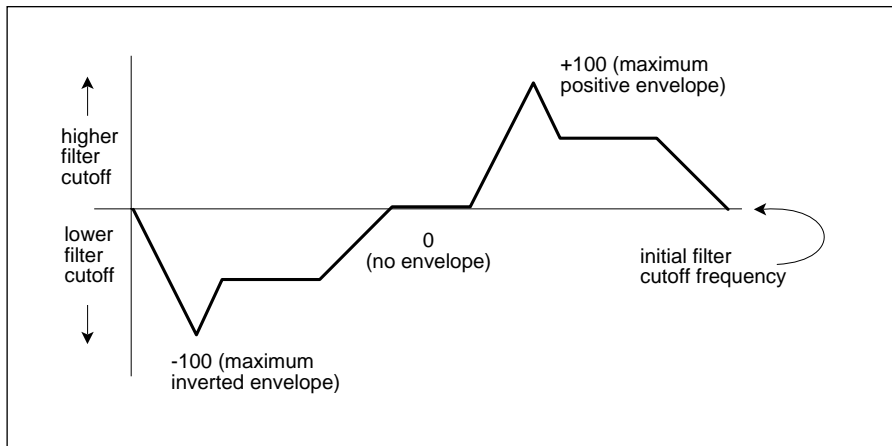

Inverted envelopes can be generated by applying a negative envelope amount.

Keyboard Tracking Application: With no tracking, a voice will become progressively less bright as you play higher on the keyboard. This is useful with some bass sounds, where you don't want the high notes to sound too trebly. With normal tracking (keyboard amount 1.00), the timbre of a voice remains constant as you play up the keyboard. This generally gives the most realistic synthesizer and instrument sounds. With overtracking (keyboard amount greater than 1.00), the overall timbre of the voice becomes brighter as you play higher up on the keyboard. This is useful for playing upper keyboard register leads that really "cut" while also playing a more sedate, muted line in the lower registers.

2. After making your selections, press **ENTER** to return to the module identifier.

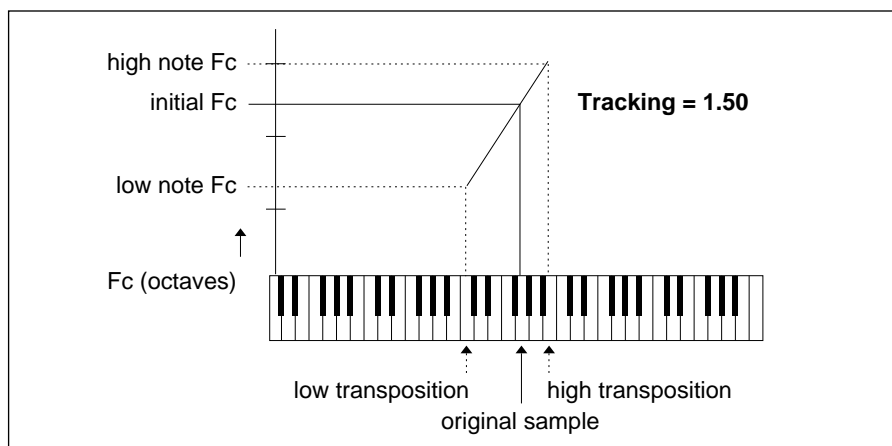

Use Filter Tracking to make the filter frequency follow the keyboard.

DYNAMIC PROCESSING

DYNAMIC PROCESSING 14

FILTER ENVELOPE

This function sets the attack, decay, sustain, and release characteristics of the filter AHDSR envelope generator.

Application: Change the filter cutoff frequency dynamically over time.

1. Activate **DYNAMIC PROCESSING 14**. The display will say:

| | | | | | |
|----|----|----|----|----|----|
| F: | A | H | D | S | R |
| | XX | XX | XX | XX | XX |

...where XX is a two-digit numeral between 00 and 32.

Hint: Filter and VCA settings interact. For example, if the VCA is set for an extremely short decay and 0 sustain level, then you won't hear the effects of setting a long filter decay.

2. Select the desired parameter for adjustment with the cursor buttons, then use the data slider to change the parameter value.

The envelope generators for the VCA and Filter are identical. Refer to the AHDSR diagram for the VCA as you read the following descriptions of the five parameters.

■ **A (Attack):** Varies the Filter envelope attack time from 01 to 32 (higher values increase the attack time).

■ **H (Hold):** Sets the duration of the peak attained during the attack phase. If a key is held down longer than the hold duration, the decay phase will begin. If a key is released during the hold duration, the release phase will begin.

■ **D (Decay):** Varies the initial decay time from 01 to 32 (higher values increase the initial decay time). 32 gives "infinite decay" (envelope stays at maximum amplitude for as long as you hold down keys).

■ **S (Sustain):** Varies the envelope sustain level from 01 to 32 (higher values give higher sustain levels).

■ **R (Release):** Varies the release time from 01 to 32 (higher values increase the release time). A setting of 32 inhibits the release phase of the envelope, thus keeping the Filter open at the previously selected Sustain level. This is useful if you want to trigger a long sound by simply tapping a key.

3. After making your selections, press **ENTER** to return to the module identifier.

DYNAMIC PROCESSING

Note: If the filter and VCA release are both at 32 (also see **DYNAMIC PROCESSING 12**), a key will sustain at the sustain level even after you take your fingers off the keys. This is like the HOLD function found on some synthesizers.

DYNAMIC PROCESSING 15 LFO SETUP (RATE, DELAY, VARIATION)

A Low Frequency Oscillator, or LFO, is simply a wave repeats at a slow rate. The Emax II contains a triangle wave LFO for each of its 16 channels. The triangle wave is very useful because it provides realistic vibrato and tremolo effects.

The LFO setup function sets three LFO parameters (initial rate, delay before onset of LFO modulation, and LFO variation).

Application: After pressing a key(s), LFO delay delays the onset of vibrato by an adjustable amount. This simulates an effect often used by string players, where the vibrato is brought in only after the initial note pitch has been clearly established.

Application: LFO variation adds a randomized quality to ensemble sounds by providing slightly different vibrato rates for each key being held down. This can make orchestral voices sound truly polyphonic.

1. Activate **DYNAMIC PROCESSING 15**. The display will say:

| | | |
|------|-------|------|
| Rate | Delay | Vari |
| XXX | XX | XX |

2. Select the desired parameter for adjustment with the cursor buttons, then use the data slider to change the parameter value. These are the available parameters:

■ **LFO Rate:** Varies from 1 to 120; higher values give a faster modulation rate.

■ **LFO Delay:** Sets the amount of time between hitting a key and the onset of modulation. Range is from 00 to 99, with higher values giving longer delays.

■ **LFO Variation:** In addition to having true, one-LFO-per-voice polyphonic modulation, the Emax II also has a great feature called variation. With 00 variation, each key will have the same vibrato rate. Increasing variation (to a maximum of 15) alters the LFO rate every time you hit a key; the higher the number, the greater the variation in LFO frequency. For effects such as ensemble playing, the variation feature is invaluable as it creates the illusion of multiple players, each having their own vibrato rate.

DYNAMIC PROCESSING

- After making your selections, press **ENTER** to return to the module identifier.

DYNAMIC PROCESSING 16

LFO TO (VIBRATO, TREMOLO, FILTER Fc, PANNING)

The LFO can modulate four different parameters—pitch, amplitude, filter cutoff frequency, and stereo placement. The modulation depth (index) is variable from 00 to 15.

Application: LFO modulating the pitch provides vibrato effects; LFO modulating VCA provides tremolo effects (as used for years in guitar amplifiers—attention surf music fans); LFO modulating filter provides timbre modulation effects; LFO modulating panning sweeps the sound back and forth between the left and right channels (i.e., spatial modulation).

- Activate **DYNAMIC PROCESSING 16**. The display will say:

| | | | |
|-----|------|----|-----|
| Vib | Trem | Fc | Pan |
| XX | XX | XX | XX |

- Select the desired parameter for adjustment with the cursor buttons, then use the data slider or increment buttons to change the parameter value as desired:

■ **Vibrato:** Determines the extent to which the LFO modulates pitch. Range is from 00 to 15, with higher values giving more modulation.

■ **Tremolo:** Determines the extent to which the LFO modulates the VCA. Range is from 00 to 15, with higher values giving more modulation.

■ **Fc (Filter Cutoff):** Determines the extent to which the LFO modulates the filter cutoff frequency. Range is from 00 to 15, with higher values giving more modulation.

■ **Pan:** Determines the extent to which the LFO modulates the stereo placement. Range is from 00 to 15, with higher values giving more drastic motion between the left and right channels.

- After making your selections, press **ENTER** to return to the module identifier.

DYNAMIC PROCESSING

DYNAMIC PROCESSING 17

VELOCITY TO (LEVEL, FILTER Fc, FILTER Q, PITCH)

This function ties dynamics (level), filter cutoff, filter Q, and pitch to how forcefully you play the keyboard.

Application: Sample sounds from an instrument (i.e. older synthesizers) without dynamics, and assign velocity dynamics in the Emax II.

Application: Acoustic instruments often sound brighter when played forcefully. Emax II can simulate this effect by tying filter cutoff to keyboard dynamics.

Application: Increasing Q with increasing velocity thins out a sound, yet also increases its sharpness. This can work well with percussive voices when you want a more intense, but not necessarily louder, sound.

Application: Since each voice in a preset can have its own keyboard dynamics settings, lower register bass sounds can have minimum dynamics to provide a constant bottom, while upper register lead sounds can be played more dynamically.

1. Activate **DYNAMIC PROCESSING 17**. The display will say:

```
Vel:Lv Fc Q Pit
   XX XX XX XX
```

2. Select the desired parameter for adjustment with the cursor buttons, then use the data slider to change the parameter value. Here are your choices:

■ **Level:** Determines the extent to which keyboard velocity controls dynamics. When set to 00, the overall level is at maximum (loudest possible dynamics) no matter how forcefully or softly you play the keyboard. Progressively *higher* values give a progressively wider dynamic range by making soft sounds softer. Example: When set to 05, softly played notes sound somewhat quieter than forcefully played notes; when set to 15, softly played notes sound *drastically* quieter than forcefully played notes.

■ **Fc:** Determines the extent to which keyboard velocity controls filter cutoff frequency. When set to 00, the filter cutoff frequency remains constant no matter how forcefully or softly you play the keyboard. Progressively *higher* values give a wider cutoff frequency range by lowering the cutoff frequency for softer playing. Example: When set to 05, softly played notes have a somewhat lower cutoff frequency than forcefully played notes; when set to 15, softly played notes have a *drastically* lower cutoff frequency.

■ *When using Emax II with an external sequencer, it is often necessary to increase the amount of velocity to level.*

DYNAMIC PROCESSING

■ **Q:** Determines the extent to which keyboard velocity controls filter Q. When set to 00, no matter how hard or soft you play the Q stays constant. With positive values (up to +15), playing more forcefully increases the Q. With negative values (down to -16), playing more forcefully decreases Q. Note that overall volume levels can change with changes in Q; this is normal.

Note: The Fc and Q settings interact with the Filter controls (**DYNAMIC PROCESSING 13**). You will probably need to “tweak” the Filter module settings for optimum results.

■ **Pitch:** Determines where pitch will be held relative to keyboard dynamics. When set to 00, the pitch remains constant no matter how forcefully or softly you play the keyboard. Progressively *higher* values give higher-pitched notes as you play more forcefully. Example: When set to 05, softly played notes are fairly close to (if not the same as) concert pitch and are somewhat lower in pitch than forcefully played notes; when set to 15, forcefully played notes are much higher in pitch than softly played notes. This can be useful for percussive sounds.

3. After making your selections, press **ENTER** to return to the module identifier.

DYNAMIC PROCESSING 18

VELOCITY TO (VCA ATTACK, FILTER ATTACK, PANNING)

This function ties the VCA attack time, filter envelope attack time, and panning to how forcefully you play the keyboard.

Application: Keyboard-controlled VCA attack is excellent for string and horn sounds, where bowing or blowing softly produces a slower attack than rapid bowing or blowing, which produces a much faster attack.

Application: Tying keyboard dynamics to filter attack is very useful with string parts when you want legato sections to sound more timbrally muted than staccato sections.

1. Activate **DYNAMIC PROCESSING 18**. The display will say:

| | | |
|---------|------|-----|
| Vel:Atk | FAtk | Pan |
| XX | XX | XX |

...where XX is a two-digit number between 00 and 15.

DYNAMIC PROCESSING

2. Select the desired parameter for adjustment with the cursor buttons, then use the data slider to change the parameter value. These are the available parameters:

■ **Atk**: Determines the extent to which keyboard velocity controls VCA attack time. When set to 00, no matter how hard or soft you play the attack time will remain as set in **DYNAMIC PROCESSING 12**, VCA Attack. Increasing the value causes the attack time to increase as you play more softly. A setting of 15 gives the greatest variation in attack times between hard and soft playing.

■ **FAtk (Filter Attack)**: Determines the extent to which keyboard velocity controls filter attack time. When set to 00, no matter how hard or soft you play, the filter attack time will remain as set in **DYNAMIC PROCESSING 14**, Filter Attack. Increasing the value causes the filter attack time to increase as you play more softly. A setting of 15 gives the greatest variation in attack times between hard and soft playing.

■ **Pan**: Determines the extent to which keyboard velocity controls stereo placement. When set to 00, no matter how hard or soft you play, the panning will remain as set in **DYNAMIC PROCESSING 19**, Panning. Increasing the value causes the signal to pan in the opposite direction of the current spatial placement; the higher the value, the greater the difference in stereo spread between soft and forceful keyboard playing. Example: With the voice panned slightly to the left and a high pan velocity value, playing softly leaves the voice slightly to the left, which playing forcefully pans the voice towards the right extreme. In-between dynamics produce placement in-between the two extremes.

3. After making your selections, press **ENTER** to return to the module identifier.

DYNAMIC PROCESSING 19

PANNING

This function controls the static stereo placement of a voice or voices. The stereo placement may additionally be modulated via the LFO (**DYNAMIC PROCESSING 16**), keyboard dynamics (**DYNAMIC PROCESSING 18**) or realtime controls (**PRE-SET DEFINITION 9**).

1. Activate **DYNAMIC PROCESSING 19**. The display will say:

```

Panning:      +00
L             ><             R
  
```

...and a marker will appear somewhere in the lower line of the display to indicate current position in the stereo field. The number in the upper display correlates to stereo position, where -07 is all the way left and +07 is all the way to the right. +00 indicates center.

DYNAMIC PROCESSING

2. Use the data slider to vary the stereo placement; moving the marker to the left shifts the sound to the left, and moving the marker to the right shifts the sound to the right.
3. After making your selections, press **ENTER** to return to the module identifier.

DYNAMIC PROCESSING 20

CHORUS

This function provides a thicker, richer sound by doubling the primary voice and slightly detuning this double sound.

1. Activate **DYNAMIC PROCESSING 20**. The display will say:

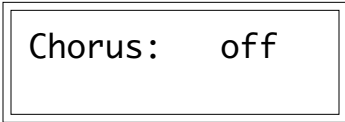

Chorus: off

...where off is the default position. Use the **ON**, **OFF** buttons or the data slider to choose chorus status and the amount of detuning. Chorus detuning is variable from 1 to 20 cents at the original pitch.

2. After making your selections, press **ENTER** to return to the module identifier.

Note: Chorus uses both halves of one channel, as in Stereo Voice mode (**PRESET DEFINITION 4**). Therefore, you can still play sixteen note polyphony while in Chorus mode. Using Chorus mode with Stereo samples detunes the primary and secondary voices from each other.

Also note: The effective amount of detuning will gradually increase as a voice is shifted downward in pitch. Therefore, you may wish to copy a chorused voice several times in order to apply a different amount of chorus to several keyboard ranges. (See Copy Voice, **PRESET DEFINITION 1**.)

■ To create a stereo chorus effect, slightly change the pan position of the chorused voice.

DYNAMIC PROCESSING

DYNAMIC PROCESSING 21 **KEYBOARD MODE** **(Solo, Non-Transpose,** **Output Channel Assignment)**

■ **Output Channel Assignment:** allows you to reassign any area of the keyboard to specific outputs without having to assign each individual voice.

■ **Solo mode:** provides the playing action of a monophonic synthesizer with single triggering and last-note priority. With single triggering, you must lift your finger off a key to initiate a new envelope.

■ **Nontranspose:** lets a voice play throughout its assigned keyboard range but at its original pitch only—there will be no transposition.

Solo Application: Produce more realistic effects when working with monophonic instrument sounds (i.e. solo trumpet, flute, sax, etc.) since this mode does not allow you to play a chord. Simulate the keying action of monophonic synthesizers.

Nontranspose Application: Determine the original note at which a voice was recorded. Or, if you're playing drum parts on the keyboard, you might want to assign the bass drum to the entire left-most octave of the keyboard so that it makes an easy target compared to hitting one key. In this case, put the bass drum into Nontranspose mode so that no matter where you hit, the sound is consistent. Or, if you have an environmental ocean sound layered beyond a melodic line, but don't want the ocean to transpose as you play the melody, Nontranspose the ocean sound.

Nontranspose Application: Assign a non-transposed sound and play several keys at almost the same time; you'll hear some pretty neat phasing/flanging effects.

Output Assignment Application: Assign a drum set which has been placed on one end of the keyboard to a set of submix outputs to add external processing such as reverb or EQ.

1. Activate **DYNAMIC PROCESSING 21**. The display will say:

```

Outs Solo Transp
Main  off Enabl'd
```

2. Select the desired parameter for adjustment with the cursor buttons, then use the **ON**, **OFF** buttons or slider to choose the desired status.

3. After making your selections, press **ENTER** to return to the module identifier.

DYNAMIC PROCESSING

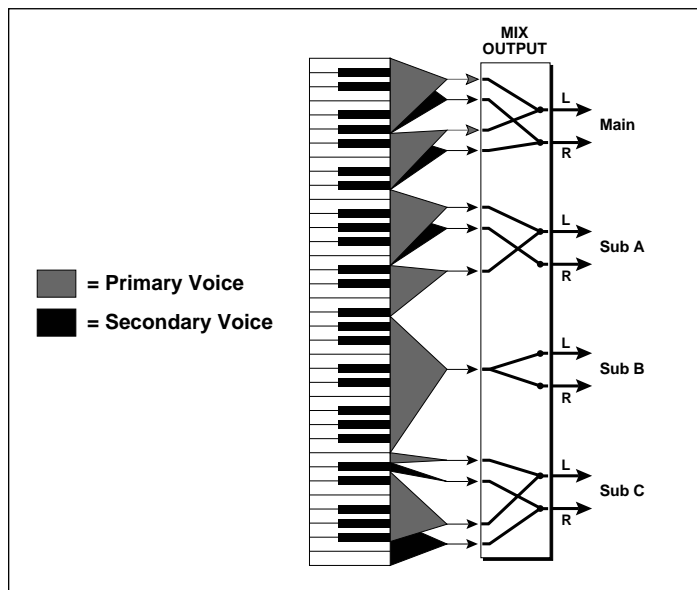

Groups of voices can be assigned to specific output channels using Dynamic Processing 21.

DYNAMIC PROCESSING 22

CONTROL ENABLE

This unique function allows you to exempt specific voices from certain real-time control functions.

Application: Exempt bass notes with long release times from pitch bending by disabling pitch bend for the bass voices. You may then bend pitch in the upper range without affecting the bass notes.

1. Activate **DYNAMIC PROCESSING 22**. The display will say.....

Control Enable
Use Cursor Keys

2. Press the right cursor key. The cursor keys scan through the various real time control destinations (see **PRESET DEFINITION 9**) in the following order: Pitch, LFO to Pitch, LFO to Filter, LFO to VCA, Filter cutoff frequency, Level, Attack, and Pan.
3. The default setting for all destinations is **ON**. To exempt the current voice from a particular control destination, press **OFF**. Example: To exempt the current voice from being pitch-bent, press **OFF** when the display shows Pitch.
4. After disabling the unwanted control destinations, press **ENTER** to return to the module identifier.

SEQUENCER

| | |
|------------------------|------------|
| PLAY | 167 |
| RECORD | 167 |
| STOP | 167 |
| SELECT SEQUENCE | 168 |

SEQUENCER MANAGE

| | |
|---------------------------|------------|
| 1. TEMPO | 168 |
| 2. CLOCK SOURCE | 169 |
| 3. LOAD SEQUENCE | 169 |
| 4. ERASE SEQUENCE | 171 |
| 5. COPY SEQUENCE | 172 |
| 6. RENAME SEQUENCE | 173 |

SEQUENCER SETUP

| | |
|------------------------|------------|
| 1. TRACK STATUS | 174 |
| 2. TRACK PRESET | 174 |
| 3. AUTO EXTEND | 175 |
| 4. ERASE TRACK | 176 |
| 5. BOUNCE TRACK | 176 |
| 6. SUPERMODE | 177 |

SEQUENCER

SEQUENCER BACKGROUND

To activate the sequencer module, press **SEQUENCER SELECT**. The green LED above the word sequencer and below the Emax II logo should light to indicate you are ready to sequence.

The **Sequencer Setup** module handles chores as you create a sequence. **Sequencer Manage** covers more general sequencer functions. After using the Setup or Manage modules, make sure you press **SELECT** before you attempt recording.

Here's how **Record**, **Play**, and **Stop** work:

Play starts the sequence playing. The sequence will repeat (loop) until you press **Stop** (see below). The lower display line will show the playback tempo; this may be varied in real time with the data slider. You may also change track status or the current preset while playing. If you don't change the track status, you can re-record the same track over and over again. The actual erase of the current track occurs when you press **Record**, which neatly segues us into...

Record then Play puts the sequencer in record ready mode; Play a key to actually start the recording process (it is not necessary to hold down record as you press play). The lower display line will show the tempo at which are recording. This may be varied in real time with the data slider. Yes, you can slow down tempo for the hard parts, and speed up for the easy ones! If you wish to start recording before any notes are played (For example: To begin with a rest) press **ENTER**.

Stop has two options. If you press it once while the sequence is playing, the sequence will stop at its end. If you press **Stop** twice while the sequence is playing, it will stop immediately.

SEQUENCE LENGTH

The Emax II sequencer uses the same memory used to store samples. Therefore, if you run out of sequencer memory you can free up more by erasing an unused voice. Naturally, sequences take far less memory than do samples, so that deleting even a short sound will free up quite a bit of memory. How much? A "Note-on" plus a "Note-off" uses 3 Emax II samples. Erasing a .5 second sampled sound taken at the 27 kHz sampling rate would "free-up" another 4629 notes of sequencer time. $(27,000 \times .5) \div 3 = 4629$.

If you have a hard disk for your Emax II, you can create and save sequences up to the limit of your memory (over a million notes with no samples). The limit for saving sequences to floppy disk is 85,333 notes (512 kBytes) for all sequences (ie. a lot of music). Trying to save more than this to floppy can cause lost data. Moral of story: Anyone creating long sequences (*especially if over a million notes*) should use a hard disk for storage.

SEQUENCER MANAGE

SEQUENCER SELECT

SELECT SEQUENCE

SELECT activates the sequencer module and also allows you to choose a sequence for recording or playback.

1. To enter the sequencer module, press **SELECT**.
2. Move the slider or use the cursor keys to catalog the already-recorded sequences. To select an empty sequence for recording, key in a number with the numeric keypad. The chosen sequence becomes the current sequence.

Note: Pressing **Select Sequence** while a sequence is playing will return the display to the preset select mode allowing you to change presets while a sequence is playing. Pressing play returns to tempo display.

SEQUENCER MANAGE 1

TEMPO

This sets the tempo for Emax II's internal clock.

1. With the sequence module active, press **MANAGE** then select 1. The display says:

Tempo: ♩ = 120.00
(040/240)/Slider

Use the data slider or the numeric keypad to adjust the tempo through the range from 40-240 Beats Per Minute. Press the right cursor key to do fine adjustment to the tempo. Use the data slider or the numeric keypad to adjust the tempo through the range from .00-.99 Beats Per Minute.

If you have selected a clock other than the internal clock, (see **SEQUENCER MANAGE 2**), the sequencer will follow and display this clock rather than the internal clock.

SEQUENCER MANAGE

SEQUENCER MANAGE 2

CLOCK SOURCE

You can drive the Emax II sequencer from the internal clock, MIDI, or three different flavors of pulse signals.

1. With the Sequencer module active, select **2**. The display says:

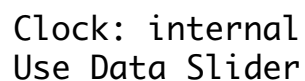

Clock: internal
Use Data Slider

2. Use the data slider to choose the desired clock option. Your choices are:

- **internal** = Emax II's sequencer syncs to the internal clock at the tempo chosen in **SEQUENCER MANAGE 1**.
- **MIDI** = Emax II's sequencer syncs to MIDI clock signals coming in over the MIDI IN port
- **click 24** = Emax II's sequencer syncs to 24 pulses-per-quarter-note signals appearing at the Clock Input jack.
- **click 48** = Emax II's sequencer syncs to 48 pulses-per-quarter-note signals appearing at the Clock Input jack.
- **click 96** = Emax II's sequencer syncs to 96 pulses-per-quarter-note signals appearing at the Clock Input jack.

3. Press **ENTER** when you've made your selection; Emax II returns to the module identifier.

SEQUENCER MANAGE 3

LOAD SEQUENCE

Use this function to load a sequence from disk into Emax II's memory.

1. Insert the disk containing the sequence you want to load into the bank. With the Sequencer Manage module active, select **3**.

SEQUENCER MANAGE

The display says:

Load Seq from XX
XX Name of Bank

...where "XX" is the bank number and "Name of Bank" is the name of the bank.

Use the data slider or the increment/decrement buttons to select the bank you want to load the sequence from, then press **ENTER**. The display now says:

Load SXX
Select Sequence

...where XX is a two-digit number. Use the data slider or numeric keypad to select the sequence you want to load, then press **ENTER**.

2. The display now says:

Load SXX To SYY
Select Sequence

...where XX is the sequence number selected in the previous step (source sequence), and YY is the sequence number the loaded sequence will have in the Emax II's bank (destination sequence; this defaults to the first available empty sequence). Use the slider or numeric keypad to select one of the 50 sequences in the Emax II.

3. Press **ENTER** after choosing the desired sequence, and the sequence will be loaded. If you haven chosen to load into a non-empty sequence, the display will prompt you with:

Load SXX to SYY
Overwrite Y/N

Press **YES** to overwrite, **NO** to select a different destination sequence.

SEQUENCER MANAGE

4. Once the sequence has been loaded, you have the option to rename it:

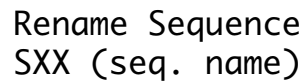

Rename Sequence
SXX (seq. name)

Press **ENTER** if you don't want to rename; this returns you to the module identifier. Otherwise, name the sequence as described in **SEQUENCER MANAGE 6**.

SEQUENCER MANAGE 4

ERASE SEQUENCE

This function erases a sequence in the Emax II memory. It does not erase a sequence from disk. To erase a sequence from disk, you must first load the disk, erase the sequence, then save the bank to disk (PRESET MANAGEMENT 2).

1. With the Sequencer Manage module active, select 4.
2. The display says:



Erase SXX
Select Sequence

...where XX is a two-digit sequence number. Use the slider, or numeric keypad to select the sequences in memory. After selecting the sequence to be erased, press **ENTER**. The display says:

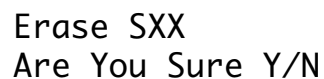

Erase SXX
Are You Sure Y/N

3. Press **YES** to erase and return to the module identifier, or if you change your mind, press **NO** (Emax II still returns to the module identifier).

SEQUENCER MANAGE

SEQUENCER MANAGE 5

COPY SEQUENCE

This function copies one sequence to another in the Emax II memory.

1. With the Sequencer Manage module active, select **5**.
2. The display says:

Copy SXX
Select Sequence

...where XX is a two-digit sequence number. Use the slider, or numeric keypad to select the sequences in memory available for copying. After selecting the sequence to be copied, press **ENTER**. The display says:

Copy SXX to SYY
Select Sequence

...where XX is the sequence number selected in the previous step (source sequence), and YY is the sequence number the copied sequence will have in Emax II's bank (destination sequence; this defaults to the first available empty sequence). Use the slider, or numeric keypad to select one of the 50 sequences in Emax II.

3. Press **ENTER** after choosing the desired sequence, and the sequence will be copied. If you have chosen to copy into a non-empty sequence, the display will prompt you with:

AppendSXX to SYY
Select Sequence

Press **ENTER** to append SXX to the end of SYY. SYY now = SYY+SXX. SXX remains unchanged.

4. Once the sequence has been copied or appended, you have the option to rename it:

Rename Sequence
SXX (seq. name)

■ Use the Copy Sequence function to backup your work in memory, allowing you to experiment without affecting the original sequence.

■ Use the Append Sequence function to build songs from short segments.

SEQUENCER MANAGE

Press **ENTER** if you don't want to rename; this returns you to the module identifier. Otherwise, name the sequence as described in **SEQUENCER MANAGE 6**.

SEQUENCER MANAGE 6

RENAME SEQUENCE

This function lets you rename a sequence in the Emax II memory.

1. With the Sequencer Manage module active, select **6**.
2. The display says:

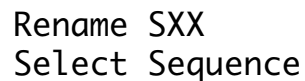

```
Rename SXX
Select Sequence
```

...where XX is a two-digit sequence number. Use the slider, increment buttons, or numeric keypad to select the sequences in memory available for naming.

3. After selecting the sequence to be renamed, press **ENTER**. The display says:

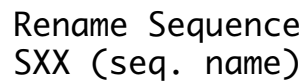

```
Rename Sequence
SXX (seq. name)
```

Use the cursor buttons to select the character to be changed. Select the character itself with either the data slider (moving the slider all the way to the bottom of its travel produces a space), the increment buttons, or the keyboard keys. You can also use the numeric keypad to enter any numbers that are part of the name.

4. Press **ENTER** after naming the sequence; Emax II returns to the module identifier.

SEQUENCER SETUP

SEQUENCER SETUP 1

TRACK STATUS

Emax II's sequencer has 16 tracks. If the track is unrecorded, its status can be set to Record. If it is recorded, its status can be set to Play, Mute, or Record (to re-record).

1. Select the current sequence (see **SEQUENCER SELECT**).
2. With the Sequencer Setup module active, select 1. If the sequence is unrecorded, the display shows:

```

TXX   R--- ----
Status:---- ----
```

...where XX is the track number whose status can be changed, and the dashes represent the 16 available tracks. The cursor will flash under the selected track; use the cursor buttons to select a different track.

With an already-recorded sequence, tracks that have been recorded will show .

3. Use the **ON/YES** and **OFF/NO** buttons to select the track status— "R" (record), "P" (playback) or "M" (mute).
4. Track status mode can also be entered while a sequence is playing by pressing the **SEQUENCER SETUP** button while in play mode. This is convenient for muting tracks on playback. Please note that record is not active in the play mode. Pressing the play button returns Emax II to the tempo display.

SEQUENCER SETUP 2

TRACK PRESET

You can re-assign any track to any preset using this function.

1. With the Sequencer Setup module active, select 2. The display says:

```

Track XX
Select Track
```

...where XX is the track number to be re-assigned. Use the slider or numeric keypad to select the track number, then press **ENTER**. If you select an unrecorded track, the lower display line will say "Empty Track."

SEQUENCER SETUP

2. The display now says:

Track XX -> PYY
Select A Preset

...where XX is the track number to be re-assigned and YY is the preset number currently assigned to the track.

3. Select the new preset number with the the data slider, increment buttons, or numeric keypad, then press **ENTER**.

4. Exit the setup module to exit this mode.

■ Use the Track->Preset function in SuperMode to assign presets to MIDI channels.

SEQUENCER SETUP 3

AUTO EXTEND

Auto Extend lets you extend the length of a previously recorded sequence. Care should be used with this function to prevent confusion!

1. Select the current sequence you want to extend.

2. With the Sequencer Setup module active, select **3**. The display shows:

Auto Extend: off
Select on/off

Use **ON** to select Auto Extend, **OFF** to de-select. After making your choice, press **ENTER**.

3. Assuming that you have selected Auto Extend, you are now ready to extend your sequence. Press **Record** then **Play** to put the sequencer into record mode. Let the sequence play for as long as desired; to end the sequence, press **Stop**.

4. Once you have extended the sequence, remember to turn Auto Extend off! Otherwise, next time you go into record you will extend the sequence even further unless you remember to hit Stop at the exact right moment.

5. If you want to record a track as you extend the sequence, no problem. Just put a track into record mode before you start.

SEQUENCER SETUP

SEQUENCER SETUP 4

ERASE TRACK

Okay, so that 32nd note bass track wasn't so cool after all. Here's how to get rid of it.

1. Select the current sequence whose track you want to erase.
2. With the Sequencer Setup module active, select **4**. The display shows:

```

Erase Track XX
Select Track
  
```

...where XX is the track number that's about to be erased. Select the track to be erased with the data slider or keypad; the display's lower line will show its associated preset. Press **ENTER**. Emax II, which always does what it can to help you prevent embarrassing mistakes, asks "Are You Sure Y/N." If yes, press **YES**, otherwise press **NO**.

SEQUENCER SETUP 5

BOUNCE TRACK

You may bounce a track to any other sequencer track, or even bounce several tracks, one at a time, into a composite track

1. Select the current sequence whose track you want to bounce.
2. With the Sequencer Setup module active, select **5**. The display shows:

```

Bnce TXX
Select Track
  
```

...where XX is the track number that's about to be bounced (source track). Select the source track (data slider, increment buttons or keypad), then press **ENTER**.

3. The display now shows:

```

Bnce TXX To TYY
Select Track
  
```

SEQUENCER SETUP

...where XX is the source track number and YY is the destination track number. Select the destination track number (data slider or keypad) and press **ENTER**. The source track will be erased, its data will now be in the destination track, and Emax II will return to the module identifier.

4. To mix several tracks to one track, repeat steps 2 and 3 and specify the same destination track for each bounce.

SEQUENCER SETUP 6

SUPERMODE

The Emax II sequencer does not include some of the features of fancy sequencers (step editing, autocorrection, etc.). However, you can work out sequences on a full-function sequencer and download the tracks en masse using the Super Mode function. Super Mode also allows Emax II to read all sixteen MIDI channels at once and to route each channel to a different preset. This is called Super Mode Mapping.

It is important to remember that each Emax II Track corresponds to a particular MIDI channel. In other words, Emax II Track 5 downloads on MIDI channel 5.

SUPERMODE MAPPING

Create the SUPERMODE MAP.

(This may already be done for you. Check your sequences.)

1. Select a new sequence and record a short blank sequence of any length (Don't play any notes). Since each track listens on the corresponding MIDI channel, repeat this process on all tracks you wish to use.

2. Assign each track to the desired preset using **SEQUENCER SETUP 2 (Track Preset)**. Assign unneeded tracks to a blank preset which is created by not assigning any voices to a new preset. This will prevent these unneeded tracks from sounding. That's it! You now have a SuperMode Map that you can copy to other sequencer locations and disks. By simply changing sequences, you can call up a new map!

Using the SUPERMODE MAP

3. Check that the Emax II MIDI IN connects to the external sequencer's MIDI OUT.

4. Activate the **SEQUENCER SETUP** module and select **6**.

SEQUENCER SETUP

The display shows:

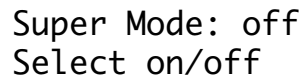

```
Super Mode: off
Select on/off
```

Press **ON** to enable SuperMode. Remember to make sure SuperMode is off (press **OFF** button) when you've finished with SuperMode. Emax II will now respond to multiple MIDI channels and route them to the preset specified in the map.

SUPER MODE DOWNLOAD

1. Check that the Emax II MIDI IN connects to the external sequencer's MIDI OUT.
2. Activate **SEQUENCER MANAGE 2** and select MIDI as the clock source.
3. Activate **SEQUENCER SELECT** and select the current sequence into which you will download the tracks.
4. Activate the **SEQUENCER SETUP** module and select 6.

The display shows:

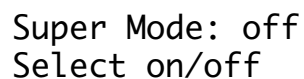

```
Super Mode: off
Select on/off
```

Press **ON** to enable SuperMode. Remember to make sure SuperMode is off (press **OFF** button) when you've finished downloading!

5. Select the tracks you want to download and put them in record mode according to the instructions in **SEQUENCER SETUP 1**. For example, if you want to download five tracks (MIDI channels), place the five Emax II tracks corresponding to each of the MIDI channels into record.
6. Press **RECORD** then **PLAY** on Emax II, then put your fancy sequencer into Play mode. The sequencer will start Emax II and send its MIDI data through the MIDI OUT into the Emax II MIDI IN. Emax II should be set for MIDI clock in. Either stop Emax II manually to terminate the downloading process, or stop the sequencer.
7. Assign the tracks to presets as desired—preset MIDI channel information is ignored—(**SEQUENCER SETUP 2**), change to Internal Clock (**SEQUENCER MANAGE 2**), and

SEQUENCER SETUP

play the sequence to make sure all is well. If it is, call up **SEQUENCER SETUP 6**, turn off SuperMode, press **ENTER**, and Emax II will return to the module identifier.

IN BRIEF:

To access multiple presets thru MIDI

- 1) Turn SuperMode on (Setup 6)
- 2) Select SuperMode Map
- 3) Enter Track Preset (Setup 2)
- 4) Since track numbers = MIDI channel numbers, assign proper presets to desired tracks

To download sequences into Emax II via MIDI:

- 1) Copy SuperMode Map with proper track/preset assignments to another sequence location (Manage 5)
- 2) Turn Auto Extend on (Setup 3)
- 3) Turn MIDI Start/Stop on for the current preset (Preset Def. 7)
- 4) Choose MIDI clock (Manage 2)
- 5) Hit "Play" on source sequencer

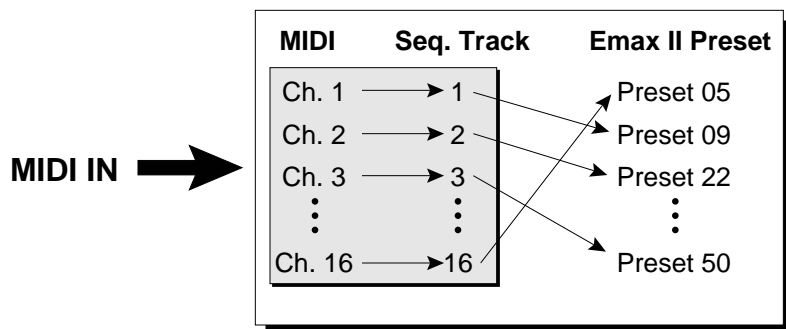

*MIDI Channels are always routed to the same numbered Track.
The Supermode Map directs a Track to the appropriate Preset.*

ADVANCED APPLICATIONS

| | |
|---|------------|
| THE ART OF SAMPLING | 183 |
| Part 1: Taking the Best Possible Sample | 183 |
| Session #1: Sampling from Tape | 186 |
| Session #2: Sampling Acoustic Instruments | 187 |
| Session #3: Sound Effects | 190 |
| Part 2: Manipulating the Sample | 192 |
| Part 3: Multi -Sampling | 195 |
| | |
| FIX IT IN THE MIX | 197 |
| | |
| MULTI-TIMBRAL OPERATION | 201 |
| | |
| MULTI-TIMBRAL BANKS | 203 |
| | |
| SPECTRUM SYNTHESIS | 205 |
| Overview | 205 |
| Spectrums | 206 |
| Time Slice | 207 |
| Creating Sounds | 208 |
| Interpolation | 209 |
| 1. Frequency Spectrum | 210 |
| 2. Time Slice | 211 |
| 3. Amplitude Contour | 213 |
| 4. Pitch Contour | 214 |
| 5. Pitch/Ratios | 216 |
| 6. Interpolate | 216 |
| 7. Load Parameters | 217 |
| 8. Save Parameters | 217 |
| 9. Erase Parameters | 218 |
| 0. Synthesize! | 218 |
| Approaching Spectrum Synthesis | 219 |
| Spectrum Synthesis Experiments | 219 |
| | |
| DIGITAL SOUND TRANSFER | 221 |
| | |
| MIDI SUPPLEMENT | 223 |

THE ART OF SAMPLING

by Craig Anderton

Recording good samples is not always easy; creating a really super set of sounds requires patience, practice, and skill. Sure, you can get musically useful results within a few days after working with the Emax II, but as you learn your craft the quality of your samples will improve dramatically.

Sampling is a multi-stage process, and consists of:

- Taking the best possible sample.
- Manipulating the sample within Emax II for maximum musicality (looping, splicing).
- Efficiently combining samples into presets.

Part One: TAKING THE BEST POSSIBLE SAMPLE

What comes out of the Emax II can only be as good as what you put in: Strive for maximum fidelity when sampling. Here are some ways to increase sample quality.

GENERAL TIPS

■ **Live Sampling:** Sample “live” whenever possible, rather than recording a sound on tape then sampling from the tape.

■ **Beware of Overloads:** Emax II is a digital recording device. Unlike analog recording devices, distortion does not increase slowly past a certain level; rather, it increases rapidly above the overload point, and produces a “non-musical,” splattering type of distortion. Monitor your levels carefully.

■ **Use a Sampling Rate Twice the Highest Frequency Produced by the Sound Source:** Because the Emax II can use different sample rates, you can optimize the sample rate for the particular sound. For instance, if the sound source is a kick drum, a 20k sample rate can be used to conserve memory because the kick drum does not have very much high frequency energy over 8k Hz. Whereas, if a cymbal were to be sampled, a 39k sample rate might be needed to capture the very high frequencies produced by the cymbal. Although this example is theoretically correct, the distortion produced by low sample rates can sometimes enhance the sampled sound. Use your ear for final judgement!

■ **Sampling Direct vs. Sampling via Microphone:** Whenever possible, sample electronic instruments directly into the Emax II. Avoid using a recording console, direct box, or other device in between the instrument and the Emax II, unless the device is of very high quality (ie. low noise).

THE ART OF SAMPLING

■ **Maintain the Instrument to be Sampled:** Tune your instrument and carefully check the intonation; change strings (if applicable); and check that the instrument doesn't have any loose parts that rattle, squeak, or make other noises.

■ **Sampling Acoustic Instruments:** Choose the microphone and mic placement as carefully as you would for any recording project. Musicians sometimes note how hard it is to get a good "sound" in the studio, but that's what sampling is all about...getting a good sound, and once you've got that sound, keeping it.

■ **Play Naturally:** Sometimes it's a lot harder to play one note than several hundred. Unless you're trying for a special effect, play the sample as you would normally play the instrument. It's often a good idea to play several notes, and use truncation to zero in on the best of the bunch.

■ **Avoid Ground Loops:** Ground loops occur when electricity can take two different paths to ground. If there is a resistance difference between the two paths, this can generate a signal (consisting mostly of digital "hash" or hum) that can work its way into the recording chain. *With all the instruments patched in place and connected to each other, turn off the Emax II and insert a ground lift adapter between the Emax II plug and the wall.*

CAUTION: Removing the ground connection defeats the safety advantage of using a three-wire plug, so use this technique only as a last resort and exercise extreme caution. *Make sure the Emax II chassis has some other path to ground (usually via the audio input and output cables).* Having two paths to ground can cause ground loops, but having no paths to ground can cause a potential shock hazard if there's an equipment malfunction in the studio.

Using Signal Processing While Recording

Just as with regular recording, there are no absolutes about recording signals with or without signal processing. Some engineers feel that tracks should always be recorded flat to allow for the maximum number of options during mixdown; others prefer to record with a bit of processing, especially if the processor might be needed on another track when mixing. Here are some thoughts about the use of various types of signal processors when recording samples.

■ **External Preamp:** If you need to preamplify the signal being sampled, set the sample gain to 00 dB and use an external, high-quality mic preamp to increase the signal level going into the Emax II. Emax II's preamp noise level, while acceptable, may not be as quiet as an external mic preamp.

■ **Limiting Dynamic Range:** Limiting the signal being sampled can put a higher average signal level into the Emax II, thus improving the already excellent signal-to-noise ratio. Also, the limit point can be set just under Emax II's overload point, which makes level setting less critical.

THE ART OF SAMPLING

■ **Equalization:** If using EQ gives a better instrument sound, then use it. You want the best possible sound going into the Emax II, and if a little EQ is indicated, it's best to add it while recording rather than having to think about it during playback.

■ **Flanging & Chorusing:** There will be no problem using time delay effects with unlooped sounds, but looped sounds are another story. The worst case is that the time-delay processing creates such a complex, non-repetitive signal that it becomes virtually impossible to find a good splice point for the loop. The best case occurs if the effect is used to give cyclical sweeps, since you can often loop one sweep of the LFO with good results. Remember too that Emax II can add chorusing effects all by itself (**DYNAMIC PROCESSING 20**).

■ **Compression:** Compression can be helpful when looping sounds since it evens out level changes, thus making it easier to find an equal-level splice point. If appropriate, use Emax II's VCA and AHDSR or velocity control to restore the original signal dynamics.

■ **Audio "Exciters":** To brighten up a sampled signal, use a psycho-acoustic enhancement device (such as the Aphex Aural Exciter or EXR Projector). These kinds of devices add a high-end "sheen" without adding the stridency encountered with excessive high-frequency equalization.

■ **Using Noise Reduction:** A number of single-ended noise reduction units (such as the Rocktron Hush) are now available; these do not require that the noisy signal have been previously encoded, as is the case with Dolby and dbx. If your source signal is noisy, one of these devices can help to greatly clean up the overall sound quality as you sample.

THE ART OF SAMPLING

Session No. 1: SAMPLING FROM TAPE

Maintaining Sample Quality with VCRs

One excellent way to sample involves using a VCR and digital audio adapter (such as the Sony PCM-F1) for recording different sounds. Compared to using conventional reel-to-reel tape recorders, this approach offers several advantages:

- **Digital-quality Fidelity:** A VCR/audio adapter combination adds virtually no degradation to the signal being sampled. Signal-to-noise ratio, wow, flutter, and dynamic range exceed that of all but the very finest analog recorders. These tapes of source sounds can serve as a “master” library.
- **Lower Tape Costs:** VCR cartridge tape is very inexpensive; you can record hours and hours of samples for only a few dollars.
- **Portability:** Using a portable VCR and battery powered audio adapter makes for a very compact and portable package.

Although splicing is not easy with VCR-based audio systems, you can generally do the required signal splicing and manipulation within the Emax II. A good alternative to the VCR/adapter approach is to use a Sony Beta Hi-Fi recorder—the audio tracks are of excellent quality. VHS Hi-Fi gives comparable results.

- **Digital Audio Tape** recorders (DATs) use the same type of technology, but are optimized for audio recording and are generally smaller and more convenient to use. All of the advantages of VCR/PCM recording apply to DATs, with the added advantage of DAT recorders being fully integrated, small-size units.

Maintaining Sample Quality with Reel-to-Reel

Follow common-sense recording practice—be extremely careful about mic placement, use noise reduction when recording samples on to tape, limit the signal going on to tape rather than limiting the signal coming off the tape into the Emax II, and add aural enhancement if desired.

- **Using Variable Speed Tape Recording:** Variable speed can help time-compress samples. For example, suppose you have one second of bank memory left and want to sample a two second sound. Record the sound on tape, and play back the tape at twice normal speed into the Emax II. This gives you a one second sample. Assign the original pitch one octave above the sample’s pitch, the low note one octave below the sample’s pitch, and the high note as desired. Playing the low note, which is an octave-lower version of the sample, will produce a two second sound at the desired pitch. This technique is also useful for speech compression.

Variable speed can help increase high frequency response as well. Record a sample on tape, then set the recorder to half speed and record the sound into the Emax II. Assign the original pitch to one octave below the sample’s pitch, the low note also one octave

THE ART OF SAMPLING

below the sample's pitch, and the high note at the sample's pitch. This high note will give the original sample sound with an extremely clean high end.

■ **Creative use of multi-tracking:** Try multi-tracking sounds on a conventional recorder, then sampling the combination sound into the Emax II. Recording a half-speed piano note along with an electric bass and a little bit of analog synth in the background gives a pretty outrageous bass sound...

Session No. 2: SAMPLING ACOUSTIC INSTRUMENTS

Sampling acoustic instruments is not easy, which you've already discovered if you've tried it. It's not impossible, but you need persistence and patience. Here are some tips that will help make matters easier.

Use Proper Miking Techniques

Prepare for a sampling session as if you were intending to record a Grammy-winning album. This means matching the right mics to the right instrument. The general rule is to use condenser mics for instruments that need delicacy, high end, and good transient response. Dynamic mics seem to work best when capturing the sound of instruments that exhibit raw power, such as bass drums, some singers, and stacks of Marshall amplifiers. Some mics are acquiring a reputation as good sampling mics. What this usually means is that the mic has a very flat and accurate frequency response, as opposed to, say, vocal mics that boost the high end for more vocal presence.

Mic placement is crucial. Sounds that come from several directions, as is the case with acoustic instruments, which tend to radiate sound, tend to be out of phase with respect to each other. If the mic picks up these multiple signals, some will reinforce each other, while others will tend to cancel. This reinforcement/cancellation effect produces frequency response anomalies that can make a sound thin (with excessive cancellation) or muddy and boomy (with excessive reinforcement).

One way to minimize phase problems is to use a PZM (Pressure Zone Microphone, Crown's trademarked name for this particular type of mic technology). A PZM mounts the mic element over a small gap, facing a broad rectangular plate. This mounting arrangement makes the mic relatively insensitive to receiving multiple out-of-phase signals from an acoustic sound source.

I've often determined proper mic placement by sitting in the control room and taking notes while the engineer, wearing headphones, tries a variety of miking positions. There are some standard mic placements, but use these as points of departures only. Every instrument, every microphone, and every player is different. Adapt to the circumstances at hand.

THE ART OF SAMPLING

Miking specific instruments requires specific techniques. For piano, mounting a PZM a few inches above the round holes in a piano's cast iron frame produces a high level output suitable for sampling. Another option is to mount a PZM to the cover of a grand piano, facing down into the strings. For nylon-string acoustic guitar, pointing a mic up towards the sound hole, from below the player's right hand, usually gives good results. (However, most acoustic guitars have a body resonance that you may want to attenuate with a parametric equalizer in order to get a higher average signal level into the Emax II.) Steel string guitars tend to produce more output, which implies that you might want to place the mic a little further away from the body to pick up more of an overall sound.

The job of miking an instrument is greatly simplified by sampling in mono. In some cases one mic will be all you need. However, on occasion mixing several mics together will give a better sound, such as with piano, where you may need two mics to cover the full range of the keyboard. It's important to monitor in mono, though, to check for phase cancellation. And if you're sampling in stereo, it's extremely important to check for phase cancellation. Two mics will, by definition, pick up signals with different phase relationships. Listening to the combined result in mono will indicate whether there are any serious phase cancellation or reinforcement problems.

Contact microphones can also be useful as supplements to standard mics or pickups. Attaching a contact mic to, say, an electric guitar will pick up some of the string and finger noises usually lost through the pickup, and when mixed in with the standard pickups, gives a more natural sound. (Don't overdo it, though, or the sound could become gimmicky.) Bases tend to gain more snap when you attach a contact mic to the body. I've had good results by attaching a contact mic to the headstock, or by mounting it in some of the free space underneath the pickguard. And of course, contact mics can be attached to garbage can lids, suspension bridge cables, steel girders, and just about anything else you might want to sample.

Avoid Including Ambience in the Sound

Of course, sometimes ambience is part of the sound, like recording a snare drum in a massive concrete stadium, or in a stone castle. But remember that once you record ambience, it is part of the sample. It's often best to record a dry sound then add ambience later, as desired, using electronic signal processors.

Adding Vibrato

Use the sampler's ability to add vibrato rather than playing the instrument with vibrato. To my ears, playing vibrato on the instrument sounds better, but there are some problems with this approach. First, when you transpose a sample, the vibrato speeds up or slows down, depending on whether the sample is transposed up or down respectively. With a multi-sampled sound where each sample doesn't need to be transposed very far, this is not a problem. But if you transpose the sound over a wide range, the vibrato will change from seasick-slow to Loony Tunes fast. Besides, the Emax II allows you to add vibrato anyway using the modulation wheels or other controllers. This gives you more flexibility, since you can alter the speed as required and bring the vibrato in and out as desired.

THE ART OF SAMPLING

Record Natural Playing

Record a musician playing naturally: runs, scales, solos, etc. It seems logical that when sampling, a musician would play just one note, and you would sample that note. However, it's very hard to play the same note over and over again naturally. It's often a good idea to play several notes, and use truncation to zero in on the best of the bunch. Some of my better samples have come from pulling parts off one track of a multi-track recorder, with the musician's knowledge, of course.

The problem then becomes how to capture the performance, since the Emax II only allows a couple of minutes of sampling even with maximum memory. As you might expect, the best sound does indeed come from playing a sound directly into the Emax II, but that is only practical for certain types of samples. Recording a musician on quality tape represents only a small compromise in sonic quality, and gives you much more material to work with. More affluent musicians do their sampling with PCM adapters connected to VCRs, RDATs, or on the audio tracks of Beta or VHS Hi-Fi recorders (whose performance often exceeds that of analog tape), or quality reel-to-reel recorders with noise reduction.

Music School Resources

Don't overlook students as possible sources of acoustic instrument sounds. Many music school students will be happy to work in a high-tech environment so that they, as well as you, can learn about sampling. Remember, though, that this kind of work is very difficult. It takes a particular breed of musician to play parts and notes over and over again while you adjust levels and try to get a good sound. It helps if the musician knows a bit about sampling, and while playing a note tries to give you a few seconds of highly consistent tonal quality to make looping easier.

Sampling Sources

Sampling from records, tapes, and CDs is good for practicing. However, I have a strong philosophical bias against actually using these sounds. The purpose of the sampler is to create new and exciting effects, not just imitate what already exists. You can take Phil Collins' drum sound off a CD...but so can everybody else. Still, for learning what makes a good sample, sampling from existing source material works very well.

Multi-sampling Frequencies

When multi-sampling, choose the frequencies at which you sample carefully. For example, with a guitar, the same note can be played at several places on the neck. Since most parts are played with fretted strings, it's often best to sample fretted, rather than open strings. Fretted strings also have a shorter decay, and tend to be somewhat easier to loop since the act of fretting dampens some of the harmonics.

THE ART OF SAMPLING

Session No. 3: SOUND EFFECTS

One of the most wonderful aspects of sampling is the ability to take real-world sounds, stuff them in a sampler, and play them back as actual pitched notes. Animals, industrial noises, acoustic environments, and much more can be used in all kinds of musical contexts. Hitting a metal garbage bin with a crowbar and sampling that sound makes quite a backbeat for your rhythm tracks.

Sampling these kinds of sounds, though, requires a different outlook from sampling acoustic instruments. The basic idea is to go out on a sampling expedition armed with some kind of quality recorder, and as always, have lots of patience.

Professional sound designers will often take something like a Nagra portable tape recorder (known for its ability to record high-quality sound in the field) or a complete PCM-F1/portable VCR combination out into the field. The PCM-F1 is a battery-powered digital audio adapter that records digitized audio on the video tracks of a VCR. Since it can be battery-powered, teaming it with a portable VCR frees the user from power lines.

Since I don't do sound design for a living, I saved some bucks and invested in a Sony Walkman Pro recorder. This is about the size of a standard Walkman, but it records in stereo, handles chrome or normal tape, has a pause control and index counter, includes Dolby noise reduction and an LED peak VU meter so you can get a sense for whether a signal is being recorded at a proper level, and comes with a reasonably high-quality condenser mic. It also has a transport that is quite immune to vibration. One of my favorite features, though, is size. I can stick the Walkman, headphones, extra set of batteries, microphone, and a couple of cables in a small bag and carry it with me wherever I go. Sometimes I just leave the thing strapped around my shoulder, ready to record. In many ways, it's like carrying around a camera.

The best way to learn what makes a good sample is to do as much sampling as possible. Sample industrial sounds, people, TV, commercials, whatever. Listen back to the tapes and keep a log that correlates the index counter setting to particular sounds. Then call up sounds that seem well suited to sampling and stuff them into the Emax II. Just about anything works for percussive effects, but some sound effects can also be tuned for melodic and chordal uses.

For example, I recently had a chance to tour one of Yamaha's piano factories. Sensing that this might provide some good samples, I took my Walkman along. While many of the machine sounds were spoiled by background noise, I did get a stunning sample of a piano testing device that sequentially played all the keys at a very high rate of speed. Some drill presses and other sounds were also pretty hip.

THE ART OF SAMPLING

Sampling Suggestions

If you want to go sampling, I have some suggestions:

■ **Always Carry Your Recorder With You**

Craig's Law: The best possible sample you have ever heard will always happen when you don't have your tape recorder, or don't have the tape set up and ready to go.

■ **Keep A Log of Your Tapes**

This is important so that you can locate particular samples fairly rapidly. Careful, though; there's a world of sound out there and you don't have to save everything. Unless you need sound effects on a professional basis, try to keep your collection of tapes manageable.

■ **Keep A Windscreen Handy**

A lot of outdoor samples are ruined by wind noise. And if you take samples while you are walking or moving, a wind screen is a virtual necessity.

■ **Try To Get As Much Level As Possible On Tape**

If you're using an inexpensive tape recorder, any extra noise can be a real problem, although you can use the Emax II's internal filter, VCA and envelopes to reduce and sometimes eliminate this noise.

THE ART OF SAMPLING

Part Two: MANIPULATING THE SAMPLE

Minimizing Timbre Differences

There are several ways to minimize timbre differences between adjacent samples as you play across the keyboard.

■ **Record Lots of Samples**

This is known as multi-sampling, and is most practical with relatively short samples.

■ **Overlap Samples and Use Positional Crossfade**

This can help even out the sound to a great extent; refer to **PRESET DEFINITION 5** ("Positional Crossfade") for further information.

■ **Carefully Adjust Filter Tracking**

When recording the sample, add some extra brightness via equalization. When adjusting the voice filter parameters on playback, set the filter tracking somewhere between 0.00 and 0.50, then adjust the filter cutoff for the desired overall timbre. This helps keep an even timbre across the entire voice. After assigning the voices to a preset, "tweak" the filter settings (if necessary) to insure consistent timbre as your playing transitions from one sample to the next.

■ **Combine Any or All of the Above Approaches**

Reducing Noise With Envelopes

You probably already know how envelopes can be used to create dynamics in an otherwise static sound. However, the envelope generators on the Emax II can do much more than just add dynamics. One of their most useful purposes is to help reduce any noise that may be in the sample itself.

To illustrate how this works, let's say you have a plucked sample from a guitar, bass, or piano recorded on tape. It's a great sample, but has quite a bit of residual noise in the background which becomes most apparent as the sound decays.

One approach to dealing with this problem is to even out the level of the decaying part of the signal going into the Emax II, either by manually turning up the Emax II's sample input gain control, or via compression (limiting) of the original signal. This produces a signal with more limited dynamics.

We can now use the amplitude envelope generator to restore the original dynamics. Set the decay and release to simulate the original decay curve, and you're set. This reduces noise for the same reason that a standard audio expander reduces noise; as the decaying part is attenuated, any noise that's part of the signal is attenuated as well.

For the ultimate in noise reduction, it would be even better to loop the sustained part of the sample, also saving memory, and then envelope the looped portion. However, if the

THE ART OF SAMPLING

looping isn't good, the sound would be less realistic than recording the regular sound along with its natural decay.

Suppose we sample a sound that has a fairly bright pluck-type attack, then settles down into sustain. Further assume that the noise is noticeable during the sustained portion of the sound. Carefully setting the filter envelope can minimize this noise. Since this kind of problem is most common with bass (there are fewer high frequencies to mask any noise), we'll use a bass sound to illustrate this technique.

First, since you're dealing with a plucked, percussive sound, set the filter envelope for a short attack. Also, since we have a bright attack, we want to make sure that the envelope interacts with the filter cutoff in such a way that the filter passes the full bandwidth of the signal during the initial attack.

In many ways the initial attack, which contains complex harmonic and amplitude changes, is the most important part to the ear in identifying a sound. It takes only about 50 to 150 milliseconds to recognize the difference between, say, a trumpet and a guitar. After this period of time, the signal tends to settle down into a more repetitive pattern that is of less interest to the ear. If some other instrument begins playing during the decay of the original sound, your ear will tend to focus its attention on the new sound.

We can take advantage of this psycho-acoustic phenomenon to reduce the apparent amount of noise that occurs after the attack. Consider the diagram below, a spectrum analysis of the signal being sampled. Here we can see that the initial pluck consists of lots of high frequency energy—energy that tends to mask any noise. After about 100 milliseconds of this initial burst, the signal loses high frequencies and consists mostly of lower frequencies. Most of the high frequencies are contributed by the noise. This means that we can lower the filter cutoff frequency and therefore, cut out the high frequencies, where the noise is most noticeable, while leaving the low frequencies, where the signal is, virtually unaffected.

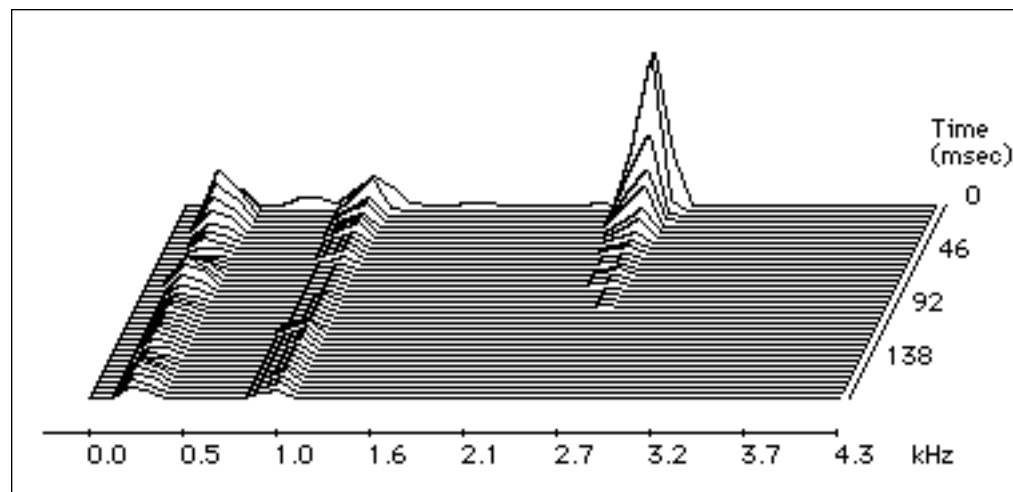

THE ART OF SAMPLING

The way to set the envelope is as follows: With no envelope applied to the filter, play the sampled sound and wait for the sustaining portion of the sound. Now adjust the filter cutoff so it lets through most of the signal, but attenuates the noise. This may take some trial and error before you obtain the desired result.

Now increase the effect of the envelope on the cutoff frequency. Start off with the attack at 0 time, sustain at 0 level, and the decay set to some minimum, but noticeable value. The release is not all that important for now. Repeatedly hit the note and adjust the decay until it is long enough to let through the sounds and high frequencies associated with the initial pluck. Adjust the envelope level to make sure that the cutoff is high enough to let these sounds through, but not so high that the hiss gets through.

I've noticed that sounds with few harmonics are particularly prone to noise problems. Applying the right kind of envelope to the filter will help dramatically towards lowering the overall amount of noise.

Signal Processing with the Emax II

■ ***Pitch Transposer with Regeneration***: To make a voice sound as if it is being pitch-shifted downward and regenerated, hit three or four adjacent keys from the same sample at the exact same time (try this with a sampled sentence for an obvious example of how the effect works).

■ ***Time Delay Special Effects***: Set a voice for non-transpose, then press several keys at almost the same time—you will hear all sorts of flanging, chorusing, and other delay effects.

■ ***Echo***: Loop a complete voice so that it begins repeating as soon as it ends. Then, set the VCA decay so that the repeated voices get softer as you hold down the key. The effect is very similar to echo, with the exception that different notes will have different echo rates. Or, set a voice for non-transpose, and hit a new key every time you want to hear an echo.

THE ART OF SAMPLING

Part Three: MULTI-SAMPLING

You would think that sampling an instrument would be a piece of cake, right? After all, you just play a note, sample it, and there it is—you're done.

Well, not quite. First of all, a single note transposed over the range of the sampler is going to sound very unrealistic. That's why most samplers allow for multi-sampling, or placing samples every few notes. This means that no note will have to be transposed over too wide a range. The tradeoff, of course, is that more samples use up more memory. As a result, it's usually best to concentrate the greatest number of samples toward the most-played range of the keyboard. For example, I've noticed that some bassy sounds can be transposed downwards to an octave or so without sounding too unnatural. Likewise, for some sounds like a cello, you're not going to play too much in the top octave. Therefore, one sample might suffice for, say, the top octave and a fifth. You might also be able to get away with a tighter loop on this sample as well since it will not be played as often as the other notes.

However, unless you take a sample for every note, there is going to be a noticeable difference in sound when you cross over from one sample to the next. For example, suppose you've sampled a sound at C3 and another at C4. You transpose the C3 sound up to G3, and transpose the C4 sound down to G#3. The note at G3 will tend to sound bright, and the note at G#3 will tend to sound rather dull, compared to their respective original samples. As a result, when you cross over from the G3 to the G#3 you'll notice a distinct timbral difference.

There are two common ways to minimize this problem. One involves the use of filter tracking, and the other requires equalizing the sample as it gets recorded into the Emax II.

Filter Tracking

If you're not sure what filter tracking is, refer to the Dynamic Processing module, VCF section. In this particular application, you will generally want to set the tracking so that the filter is open all the way (maximum brightness) for the lowest-transposed notes of the sample, then closes down as you play towards the highest-transposed notes of the sample. Thus, the lower notes are allowed to play as bright as possible, whereas the high notes, which tend to sound bright and sometimes shrill due to the transposition, are mellowed out a bit. This minimizes tonal differences as you transition from one multi-sample to the next. In fact I have used this technique so successfully with some analog synthesizer patches that even though there may be only five samples across the keyboard, which means that each sample has to be transposed over an octave, it is very difficult to tell where one sample begins and the next one ends.

One trick is to record the original sample with a bit of treble boost or aural enhancement (Aphex Exciter, EXR Projector, etc.). This extra brightness, when transposed downwards, gets reduced to what is perceived to be a normal amount of brightness on the lower transposed notes. Sure, the high notes will be very bright, but that's what filter

THE ART OF SAMPLING

tracking is for. By setting the tracking to zero (i.e. the filter frequency stays the same regardless of where you play on the keyboard), or slightly higher, these high notes can be tamed to the point where they sound acceptable.

Parametric Equalization

One of the problems with transposing a signal up or down is that it changes the characteristic formant of an instrument. The formant is a frequency at which an instrument tends to have some kind of resonant peak that gives the instrument its distinctive character. For example, I recorded a classical guitar once that had a very pronounced peak around 200 Hz. This gave a bassy, rich sound. However, if you sampled that guitar and transposed it up an octave, then the resonant frequency would transpose upward as well to 400 Hz, and the guitar wouldn't sound so bassy anymore. Conversely, transposing downwards an octave would lower the frequency to 100 Hz, which would be very bassy.

Sometimes it's possible to equalize the signal being sampled to minimize the formant shift problem. Generally, the tool of choice for this task is the parametric equalizer, an equalizer that can boost or cut a specific frequency (or group of frequencies) by a specific amount, usually +/- 12 to 15 dB. Reducing the formant doesn't affect the original sound very much, but can make a big difference on the transposed sounds.

Parametric Equalization is very much a trial-and-error sort of process, which makes a good argument for having samples originally recorded on tape so that you can experiment with them as you record them into the sampler.

The Art of Sampling is an excerpt from a forthcoming book by Craig Anderton and is used by permission.

FIX IT IN THE MIX WITH A SAMPLING KEYBOARD

by Craig Anderton

Uh-oh. You're doing a mix and you start hearing things...like clicks, and pops, and out-of-tune parts, and even a fluffed note on the piano section in the second verse. And the singer didn't quite make that high D

In the pre-sampling days, these problems would have meant either redoing a track, or getting intimately involved with a razor blade and splicing tape. But no more. Although most people look upon samplers as sampling *keyboards*, this is only one way to look at that these wonder boxes. In the studio, for example, you might be better off thinking of a sampler as a bunch of little digital audio recorders, controlled by switches that—just by coincidence—come in a piano keyboard's configuration. With our consciousness thus properly shifted, we're ready to "fix it in the mix" and get into some serious cut-and-paste work. Most of these applications involve recording a part from tape into the sampler, manipulating it within the sampler, then recording the part back on tape in place of the flawed original. Thanks to 16-bit sampling systems, the loss in fidelity that occurs during the transfer is minimal—and is certainly preferred to whatever glitch you wanted to eliminate.

STOP THAT PLOSIVE!

One of the quickest ways to spoil a great vocal take is with a popped "P" or "B" sound. Punching one word can be a Big Deal, since it's going to be difficult for the singer to get the same feel and match the level. Besides, what happens if sloppy engineering on the original session let through that exploding "P" sound, yet you have to solve the problem during the mix when the singer isn't around to re-do the part?

Simple. Sample the offending word, complete with pop, into the sampler. Next, use the truncation function to cut off the pop at the beginning of the sample. Well, maybe not the entire pop; usually you want to leave in just enough to retain a bit of the P sound. When the plosive has been properly tamed, send the truncated sample back into the recorder and punch it in over the original word.

What? You say it's a short word and who can do that quick a punch? Then transpose the sample down an octave, slow the recorder down to half speed, and do the transfer. Or if the word is embedded in the middle of a phrase, sample the entire phrase and copy it to a second sample. Then, truncate the end of the first sample just before the pop, truncate the beginning of the copy just after the pop, and splice the two samples back together again and record it over the original phrase. Usually any pops are short enough that the few milliseconds lost in the splicing process won't significantly affect the overall timing.

THE TRANSPLANT

Thanks to the repetitive nature of most pop tunes, melody lines and parts often repeat in more than one place. Recently, I was mixing an album project where, in the second verse, there was an audible electrical click on one of the notes in a part. The musician who played the part was on tour, so she wasn't available to replay the line. I checked back in the song and sure enough, there was an almost identical line in the first verse. We sampled it, and recorded it over the line with the glitch. The process worked so well it's impossible to tell which is the "transplant" and which is the original.

FIX IT IN THE MIX

TESTING A SPLICE POINT

Do you get as nervous as I do when slicing up a multi-track master tape? It's no fun to slash a 2-inch tape into pieces, only to find that maybe that snare hit wasn't the right splice point after all.

The usual procedure is to test your splice by recording a mix of the multi-track on to quarter-inch tape, and then doing your "practice" splices on the quarter-inch version. Once you find the right place, you then do the "real" splice on the multi-track master. This is all well and good, but no longer necessary if you have a sampler with a splicing function. Start by sampling a couple of seconds around each of the potential splice points. Truncate the samples to the splice points, then use the splice function to glue the truncated samples together. If it works, great—go do the splice. If not, re-truncate the samples and try again. When you find the right splice point, proceed to slicing and dicing the multi-track master.

FIXING THE OUT-OF-TUNE NOTE

Here is where a sampler can truly save a session. The singer has just given a stunning performance except...that last note was just flat enough to blow the take.

Or was it? Sample the note into the sampler, and punch over the existing bad note. Only this time, artfully move the pitch bend wheel at just the right moment to bring the note up to pitch. This is the kind of salvage job that can make a singer your friend for life.

Incidentally, you can also use this technique during the recording process to help a singer hit a note outside of his or her range. Sample the highest note the singer can sing, and when it's time to hit that ultra-high note, play it on the sampler by transposing the sampled sound upward.

STEADY, STEADY...

What happens if the kick drum is just a shade off tempo? You guessed it: assuming the kick is on its own track, you can sample the sound, then during the transfer back to tape hit the sampler key at the right time so that the bass drum falls right into the pocket.

CURING THE NO-VIBRATO EFFECT

During mixdown, I heard a vocal line that was just crying out for a real heavy, thick, even vibrato at the end of a phrase. Unfortunately, not all singers can provide this...but a sampler can. Sample the note, and when you record it over the existing note, turn up the mod wheel for the desired amount of vibrato. You can even do some really bizarre things like simultaneous pitch bend and vibrato...pretty bionic sounding.

FIX IT IN THE MIX

BUT I'VE RUN OUT OF DDLs!

You've got one DDL chorusing the lead vocal, one on the drum overhead mic, and your very last DDL doubling a sax solo. At this point the rhythm guitarist muses about how it would be nice to have a little eighth-note slapback every time he hits that fancy B maj 7th chord...you know, a tail of about three or four echoes that fade out nicely into the drum fill.

Here's where velocity keyboards come in handy. Sample the rhythm guitarist's fancy chord, and play the *sample* when the echo is supposed to come in. Play it once for each echo, and play the note a little softer each time so that the echo's level diminishes properly. If you have an open track, the echo can be recorded there and you won't have to think about it any more. If all your tracks are full, find someone to play the part in real time during the mix itself.

I must confess to using this technique a lot, even when I haven't run out of DDLs, since it allows for echo effects that would be just about impossible to achieve with standard DDLs (such as strange polyrhythms, echoes that get louder and then softer, and so on).

TESTING, TESTING...

And since we're in a mix-oriented frame of mind, we want to make sure everything is aligned level-wise. Sample a 100 Hz, 1 kHz, and 10 kHz tone into the sampler; they won't take up much memory since all you have to do is loop a few cycles. Then make up a little sequence that spits out these tones in the right order for calibration. Some samplers will have a hard time dealing with a 10 kHz signal, but if you sample at a fast sample rate and sample the tones at a moderate level, you should have something good enough to use. Keyboard players who would like to endear themselves to guitarists can sample an E = 164.8 Hz tone into the sampler. When transposed down an octave, this produces the right frequency for tuning the guitar's low E string. When transposed up an octave, you can tune the high E. Notes for the other guitar strings (A, D, G, B) lie within this two-octave range. You can even make up a little tuning sequence—say, 10 seconds on each note needed for tuning.

AND THERE'S MORE!

While technically not a fix-it-in-the-mix application, some samplers [Emax II, ed.] let you slow the sampling rate way down, thus allowing very long sampling times. This can be a real boon to songwriters. I don't know about you, but I often come up with words by playing a chorus or verse over and over and over again until I've got most of the words filled in. In the Dark Ages, this meant rewinding your tape a lot. Now TASCAM, Fostex, and others offer "block repeat" functions where the tape will rewind back to a set point, play forward to another set point, rewind, play, and so on. But why torture your tape deck transport? Sample the entire verse, chorus, or whatever, and loop it.

FIX IT IN THE MIX

END OF LINE

Samplers make great musical instruments, no doubt about that. But they also make versatile digital recorders with very useful editing capabilities. Next time you need to fix something in the mix, see if a sampler won't do the job in the quickest, simplest, and most cost-effective manner.

*This article was originally published in the December 1986 issue of **Electronic Musician** magazine and is used with permission.*

MULTI-TIMBRAL OPERATION

By Gerry Bassermann

WHAT IS SUPERMODE?

Supermode means that you can turn your Emax II sequencer into a MIDI matrix, capable of routing any of 16 MIDI channels to any of 100 Emax II presets simultaneously. Since there are 50 available sequence locations, you can have up to 50 such setups.

TO ACCESS MULTIPLE PRESETS THROUGH MIDI:

1. Turn Supermode on (Setup/#6).
2. Select Supermode Map (Sequence 00) (see below).
3. Hit Setup #2 (Track Preset).
4. Assign presets to the desired tracks.

When Supermode is on, all MIDI channel and mode settings within presets (Preset Definition #7) are ignored. Instead, incoming MIDI data will be individually channelled into respective sequencer tracks. Remember, MIDI channel numbers correspond to the same track numbers.

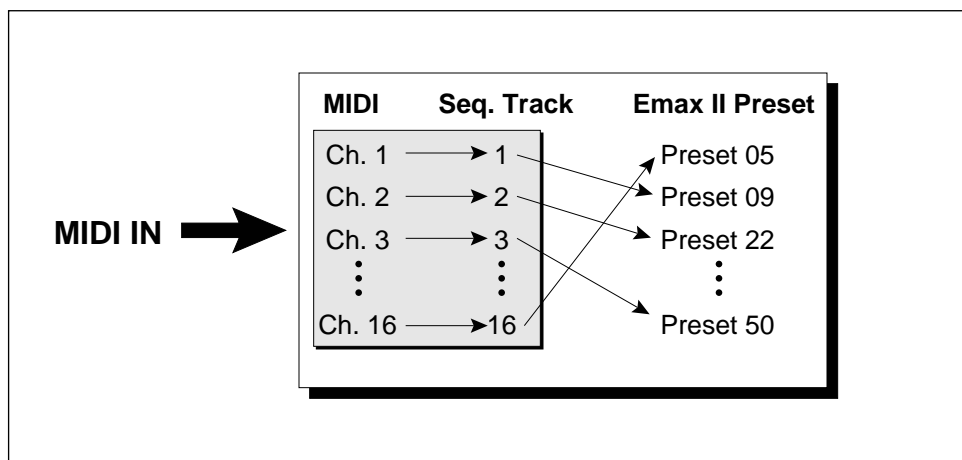

*MIDI Channels are always routed to the same numbered Track.
The SuperMode Map directs a Track to the appropriate Preset.*

WHAT IS A SUPERMODE MAP?

It is the sequence, labeled 00 on all E-mu factory disks, in which all 16 tracks have been recorded with nothing for one second. This is so that there exists a 'sequence' where you can assign presets to any one of the sixteen tracks. You can't make assignments to empty tracks.

MULTI-TIMBRAL OPERATION

It is also very easy to create your own Supermode Map. First, decide which MIDI channels the Emax II should receive. Then choose an empty sequence, turn Supermode on, put the tracks which correspond to those MIDI channels into record mode, then record one second of silence. Make the proper track/preset assignments, as described above, for whatever external sequencer project you're working on. It's a good idea to change the name from Supermode Map to the title of your piece, so that later, when you need to select the correct Supermode routing, you can easily find your work.

After you've slaved the Emax II sounds to your sequencer, and finished working on the music, it is possible to download all the data into the Emax II so you won't have to carry the dedicated sequencer around with you. In doing this, you're actually turning that Supermode Map into a real sequence. Remember, when downloading, that the Supermode Map was only recorded for one second and your download will terminate after that time if you don't first activate Auto Extend (Setup # 3).

TO DOWNLOAD SEQUENCES INTO EMAX II VIA MIDI:

1. Select SuperMode Map with proper track/preset assignments.
2. Turn Auto Extend on (Setup#3).
3. Turn MIDI Start/Stop on for current preset (Preset Definition #7).
4. Choose MIDI clock (Manage#2).
5. Hit record, play, and enter on the Emax II.
6. Hit play on source sequencer.

MULTI-TIMBRAL BANKS

One of the most powerful ways to use the Emax II sound library is to create an arrangement of sounds drawn from different disks and combine them all on your own disk. It is also one of the most asked questions of our customer service department.

HOW?

Creating a multi-timbral bank is easy. It's basically a matter of loading a preset from one bank and saving it into another.

- 1) Decide which presets you want in your multi-timbral bank.
- 2) Let's start with a clean slate, just to avoid confusion. So, clear the bank (**MASTER 4**).
- 3) Activate **PRESET MANAGEMENT 1**, Load Preset.
- 4) Use the data slider or inc/dec buttons to select the bank containing the first preset you want to use, then press **ENTER**.
- 5) Now use the data slider or inc/dec buttons to select the first preset you want, then press **ENTER**. You can now rename the preset if you desire.
- 6) Go back to step 3 and select the next preset that you want on your multi-timbral disk. Continue until you run out of memory or have enough presets.
- 7) Save the bank (**PRESET MANAGEMENT 8**), or your work will be lost.

NOT ENOUGH SAMPLE MEMORY

Problems come when you see the flashing error message;

"Not Enough Sample Memory".

This message is telling you that you have run out of sample memory. On an Emax II with only one Megabyte of RAM, this message will appear frequently when trying to load presets.

When this message appears, you have two alternatives;

- 1) Get more memory, or
- 2) Make room for the new preset by erasing unwanted presets, voices, parts of voices, making loops shorter or by using Sample Rate Conversion.

EXPAND YOUR MEMORY!

By far the easiest method is #1. Get More Memory! The Emax II can be memory expanded up to 7 or 8 Megabytes of RAM. To be honest, it's really a pain trying to create multi-timbral disks with only one Megabyte. On the other hand, creating a multi-timbral disk with 3 or more Megabytes is quick and easy. It's the only way to go.

MULTI-TIMBRAL BANKS

THE HARD WAY

No money left over for memory? OK, OK. Here's what you do.

Check the preset sizes of the presets you want to load (**PRESET MANAGEMENT 7**) before loading them. If the total number of samples in the presets you want to load exceeds the memory capacity of your Emax II (524,244 samples on a 1 Meg unit), you must take action.

The basic technique for combining impossibly large presets is Memory Reduction. Either erase voices and transpose your other voices further up and down the keyboard, erase voices that you don't absolutely need, make shorter loops or use Sample Rate Conversion in the Digital Processing module to reduce the memory required for each voice. Maybe you can use a combination of all three methods. All these methods take time, but will do the trick until you can save up for that memory expansion.

ORGANIZING YOUR MULTI-TIMBRAL BANK

If you are going to use the multi-timbral bank with an external sequencer, here are a couple of tips.

Create a system where certain types of sounds are assigned to certain preset numbers.

For example; **Preset 1 - Keyboard Sounds**
Preset 2 - Bass
Preset 3 - Drums
Preset 4 - Horns
etc.

Creating an organized system will allow you to easily swap sounds around if they don't work out in the sequence. You can try out several bass guitars, for instance, to hear which one sounds best. All you would have to do is "Load Preset" over the existing bass.

To make life even easier, assign the presets to their corresponding MIDI channels.

For example: **MIDI Channel 1 = Preset 1**
MIDI Channel 2 = Preset 2
etc.

Now you have one *less* thing to remember.

EXPERIMENT!

Combining sounds together is a true art. Take the time and try out various instruments in a given part. Many times an instrument that sounds thin and wimpy on its own will perfectly fill out the mix. And, too many "fat" sounds can create "MIDI Soup", a huge stifling sound. Keep experimenting until you get everything just right. Creating Multi-Timbral banks fulfills the promise of sampling technology by letting you have *any* sound, where and when you want it. Take advantage of it.

SPECTRUM SYNTHESIS

OVERVIEW

Sine waves are the most basic components of sound. All waveforms can be broken down to their component sine waves. *Additive Synthesis* is the process of constructing sounds by adding sine waves together in varying amounts.

The pitch of any sound is determined by its *Fundamental Frequency*. The fundamental is the lowest frequency component and usually the one with the greatest amplitude.

The other components of a complex sound are known as *Partials*. The way the different partials are mixed together with the fundamental frequency determines the tonal quality of a sound. Normally the partials are based on whole number multiples of the fundamental, 1x, 2x, 3x, etc. When partials are whole number multiples of the fundamental, they are called *harmonics*. Partials do not have to be exact multiples of the fundamental. In fact, many natural sounds have some partials which are not exact multiples. Bells and cymbals are examples of sounds in which many of the partials are detuned from a normal harmonic relationship.

So, sine waves can be added together in various amounts in order to form complex waves. But the waveform of most natural sounds varies quite dramatically over time. Simply being able to create any waveform is not enough. The waveform of a sound must *vary* over time or the sound is static and uninteresting.

Enter the Time Slice. Emax II's Spectrum Synthesis allows you to specify up to 24 complex waveforms, (called Spectrums) and to either step or fade through them during the course of the sound. The 24 waveform locations are called *Time Slices*, since they represent the waveform at that slice of the sound. This method allows more complex and interesting sounds to be created. In addition, each partial (sine wave) can have a 24 point envelope that determines the pitch of that partial over the course of the sound.

Each Emax II voice can consist of two synthesized timbres, a synthesized timbre and a sampled sound, or two sampled sounds. The resulting voice can then be processed using Emax II's extensive Dynamic Processing features and then placed anywhere in the stereo field. As an example, the primary voice could be the attack of an overblown flute while the secondary voice could be a synthesized timbre of your own creation. When played together, the total effect is that of a natural sound, but a totally NEW natural sound. The possibilities are endless!

1. Select **Digital Effects 6** and the display will say:

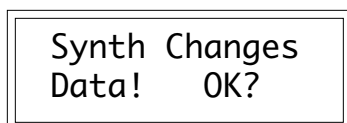

If it's OK to write over the current voice, press **YES**. If not press **NO** to return to the module identifier.

SPECTRUM SYNTHESIS

If you pressed **YES**, the display will now say:

Synth Options
[0-9] / Slider

2. Use the slider to catalog the various options.

0. Synthesize!
1. Freq. Spectrum
2. Time Slice
3. Ampl. Contour
4. Pitch Contour
5. Pitch/Ratios
6. Interpolate
7. Load Backup
8. Save backup
9. Erase

SPECTRUM INTERPOLATION SYNTHESIS

Spectrum Synthesis can create dynamically shifting timbres using additive synthesis techniques. Virtually any imaginable waveform may be created. Up to 24 sine waves are added together to form *Spectrums*. Spectrums are then placed at up to 24 *Time Slice* locations over the length of the sound. As the sound is played, it either steps or smoothly fades through the spectrums. Sounds may be any length (up to the maximum memory) and can be customized by using the sophisticated complement of edit parameters that are included. After a sound has been created it may be spliced, combined, and processed in the same manner as a sound that has been sampled into the Emax II.

ABOUT SPECTRUMS

The spectrum synthesizer development disk contains 95 pre-programmed spectrums for you to use, or you may create and store your own. Each spectrum may contain up to 24 sine waves, with each wave having its own specific amplitude (volume). These sine waves may be tuned to any ratio of the fundamental frequency. These ratios do not need to be harmonically related to the fundamental pitch of your sound, hence the sine waves are called *partials*, rather than harmonics. Varying the amplitude of a specific partial will result in a timbre change. Generally, the greater the amplitude of the higher partials, the brighter the resulting sound will be.

SPECTRUM SYNTHESIS

A spectrum may be placed at any of the 24 "time slice" locations. Placing a spectrum at a given time slice will determine the timbre of the sound at that point in time.

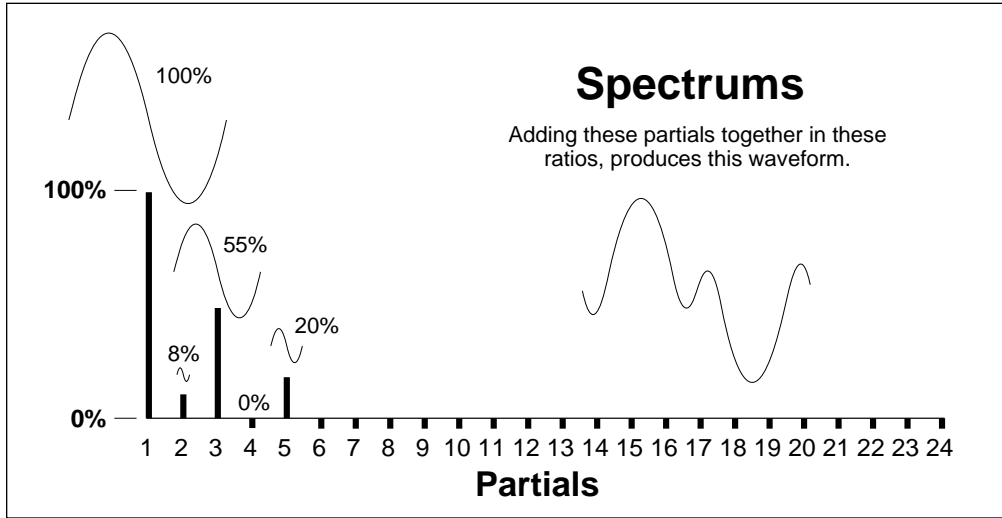

ABOUT TIME SLICES

Once you have determined the length of the sound that you wish to synthesize, Emax II automatically divides the sound into twenty-four equal sections. Each section is called a time slice. A time slice contains the spectrum at a given point in the sound. A *Time Slice* is simply a *Spectrum* which has been placed at a *Time Slice* location. You can create a time slice and save it as a spectrum, or place a previously created spectrum at a time slice.

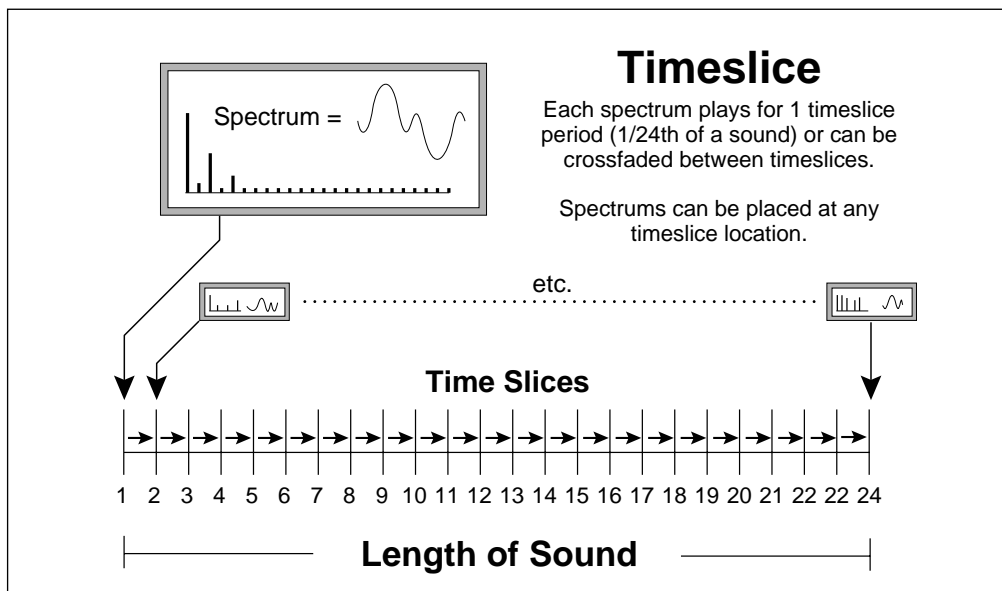

SPECTRUM SYNTHESIS

CREATING SOUNDS

The best way to learn about the spectrum synthesizer is by creating a sound, so load the Spectrum Synth development disk into your Emax II and follow these simple steps...

DEFINE THE LOCATION

First, we must define the location and the length of the sound. This can be accomplished in one of three ways:

- Select a preset 95-99 on the Spectrum Synth development disk. These contain empty samples.
- 1. Clear all memory. (**Master #4**)
 2. Enter the **SAMPLE** module
 3. Press **#4** on the keypad and select the length that you want the synthesized sound to be. (The longer the sound, the more time it will take to synthesize.)
 4. Press **#7** on the keypad to force sampling.
 5. Press the **SAMPLE** button to exit the sample module
- Write over an existing sample. The synthesized sound will replace the sampled sound. (Remember to back up the sample first!)

START SYNTHESIZING

Now you that you have defined a location and length for the sound, its time to start synthesizing!

1. Enter the **DIGITAL PROCESSING** module and select the voice you just created.
2. Press **#9** on the keypad to access the **Digital Effects** menu.
3. Press **#6** on the keypad to access "Spectrum Synth". The display will read "Synth Changes Data! OK?" Press **YES** to continue. (**NO** to exit)
4. Now you are in the Synth Options menu. Press **#1** (Freq. Spectrum) on the keypad and hit **ENTER**. The display will show Spectrum #1 and you will see a series of vertical lines. These lines represent the amplitudes of the 24 partials contained in the spectrum.

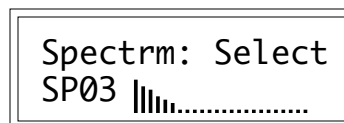

Note: Because of the limited display resolution, each dot in the bar graph represents 14% of full level. If a partial has a level of less than 14%, the bar will appear to be 0%.

5. Press **NO** until the display says "Spectrum->TS Y/N", then press **YES**.

SPECTRUM SYNTHESIS

6. The display now says "Move SP01 to: TS01...", and the ENTER light will be flashing. Press **ENTER**. Now Spectrum #1 has been placed at Time Slice #1.

INTERPOLATE

You have now defined a tonality for the beginning of the sound. To define the tonality at the end of the sound repeat steps #4 - #6 but in step #4 select Spectrum #2 instead of Spectrum #1. (Use the slider, yes/no buttons, or the keypad to select spectrums 1 - 99). In step #6, move Spectrum #2 to Time Slice #24. To fill in the "middle" of the sound, we use the "Interpolate" function. This tells the Emax II to create all of the spectrums between time slices 1 and 24.

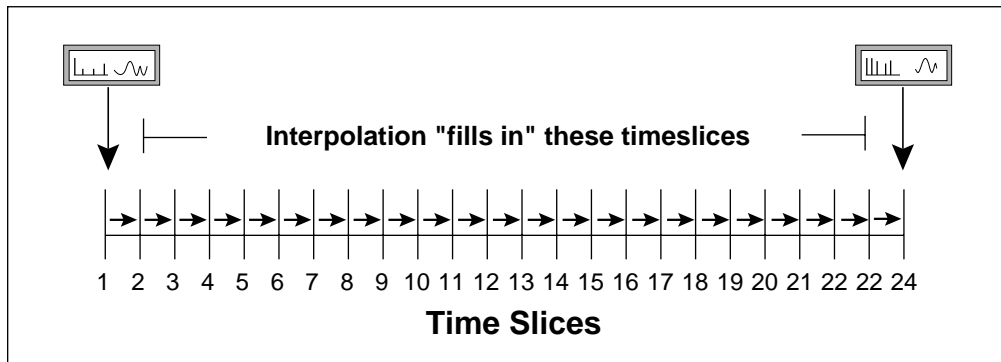

1. Press **#6** (Interpolate) on the keypad. The display reads "Interpolate from: TS01...".
2. Press **ENTER**. The display now reads "Interpolate to: TS01...". Use the slider to select Time Slice #24 and press **ENTER** to execute the interpolation.
3. Now press **#2** (Time Slice) and slowly move the slider. You will see that the Emax II has created time slices 2 - 23. These time slices represent the gradual transition from time slice #1 to time slice #24. Move the slider all the way to the bottom. The display will show "None - exit". Press **ENTER** to return to the Synth Options menu.

SYNTHESIZE!

At this point it is time to tell the Emax II to generate the sound that you have defined. This is done by pressing **#0** (Synthesize!) on the keypad. There are two modes of synthesis - "Smooth" and "Stepped". "Smooth" will produce a very gradual tonal change from time slice to time slice. "Stepped" will result in more abrupt tonal changes, as each time slice plays for exactly one twenty-fourth of the sound and then jumps to the next time slice. Select the "smooth" mode by using the **YES / NO** buttons, then press **ENTER** to begin synthesizing. The display will show how many time slices are left to synthesize, then prompt you to play the sound when the synthesis is complete.

SPECTRUM SYNTHESIS

SPECTRUM SYNTH OPTIONS MENU

There are ten options listed in the spectrum synthesis menu. Each of these options covers a specific function or group of functions, and some contain sub-menus and functions. When a menu option contains multiple functions, answering **YES** to the prompt “ ... ? **Y /N** “ will execute the function and then take you to the next level of operation. Answering **NO** to the prompt takes you to the next option in the sub-menu. The menu options are as follows:

1. FREQUENCY SPECTRUM

In this menu, spectrums may be drawn, edited, copied, and placed.

DRAW a Spectrum

(Use for quick and easy creation of spectrums)

- A.** Press **#1** on the keypad to access the Frequency Spectrum menu options.
- B.** Use the slider to select the number of the spectrum you wish to draw. Press **ENTER**.
- C.** Press **YES** to start the drawing countdown. You will see the display countdown 5...4...3...2...1... When the countdown finishes, the drawing process starts. The cursor position automatically moves from left to right - each position of the cursor denoting one partial. By raising and lowering the slider as the cursor moves across the screen, you can draw the amplitude of each of the twenty four partials. The bar graph displays the relative amplitude of the partials.
- D.** Press **NO** three times to return to the Additive Options menu.

EDIT a Spectrum

(Use for precise definition of spectrums and partial amplitudes)

- A.** Press **#1** on the keypad to access the Frequency Spectrum menu options.
- B.** Use the slider to select the number of the spectrum you wish to edit. Press **ENTER**.
- C.** Press **NO** to get to the spectrum EDIT screen. Press **YES** to edit.
- D.** Use the slider to enter the amplitude of the partials. Amplitude is shown in percentages on the right hand side of the screen.
- E.** Use the cursor (<- ->) buttons to move from partial to partial.
- F.** Press **ENTER** , then **NO** twice to return to the Synth Options menu.

SPECTRUM SYNTHESIS

COPY a Spectrum

(Use for creating a duplicate spectrum which can then be modified)

- A. Press **#1** on the keypad to access the Frequency Spectrum menu options.
- B. Use the slider to select the number of the spectrum you wish to copy. Press **ENTER**.
- C. Press **NO** two times to get to the spectrum COPY screen.
- D. Press **YES** to copy. The display reads "Copy SP01 to SP01...".
- E. Use the slider to select the number of the spectrum that you wish to copy *to*.
- F. Press **ENTER**, then **NO** to return to the Synth Options menu, or YES to make another copy.

SPECTRUM -> TS

(Use for placing a spectrum at a Time Slice location.)

- A. Press **#1** on the keypad to access the Frequency Spectrum menu options.
- B. Use the slider to select the number of the spectrum you wish to move. Press **ENTER**.
- C. Press **NO** three times to get to the **MOVE** screen.
- D. Press **YES**. The display will read "Move SP01 to: TS01...".
- E. Use the slider to select the number of the time slice where you want to move the spectrum.
- F. Press **ENTER** to execute the move.

Note: After executing a function in the Frequency Spectrum options menu, it is not necessary to exit the menu before accessing another function. For example, you may DRAW a spectrum, then EDIT, COPY, and MOVE it before returning to the Synth Options menu.

2. TIME SLICE

In this menu, time slices may be drawn, edited, copied, and saved.

Note: This is exactly like creating Frequency Spectrums, except here the Spectrums are already placed at Time Slice locations.

DRAW a Time Slice

(Use for quick and easy creation of time slices)

- A. Press **#2** on the keypad to access the Time Slice menu options.
- B. Use the slider to select the number of the time slice you wish to draw. Press **ENTER**.

SPECTRUM SYNTHESIS

C. Press **YES** to start the drawing countdown. You will see the display countdown 5...4...3...2...1... When the countdown finishes, the drawing process starts. The cursor position automatically moves from left to right - each position of the cursor denoting one partial. By raising and lowering the slider as the cursor moves across the screen, you can draw the amplitude of each of the twenty four partials. The bar graph displays the relative amplitude of the partials.

D. Press **NO** three times to return to the Synth Options menu.

EDIT a Time Slice

(Use for precise definition of time slices and partial amplitudes)

A. Press **#2** on the keypad to access the Time Slice menu options.

B. Use the slider to select the number of the time slice you wish to edit. Press **ENTER**.

C. Press **NO** to get to the time slice EDIT screen. Press **YES** to edit.

D. Use the slider to enter the amplitude of the partials. Amplitude is shown in percentages on the right hand side of the screen.

E. Use the cursor (<- ->) buttons to move from partial to partial.

F. Press **ENTER** , then **NO** twice to return to the Additive Options menu.

COPY a Time Slice

(Use for placing the same time slice at two different locations, or for creating a duplicate time slice which can then be modified)

A. Press **#2** on the keypad to access the Time Slice menu options.

B. Use the slider to select the number of the time slice you wish to copy. Press **ENTER**.

C. Press **NO** two times to get to the time slice COPY screen.

D. Press **YES** to copy. The display reads "Copy TS01 to TS01...".

E. Use the slider to select the number of the time slice that you wish to copy *to*.

F. Press **ENTER**, then **NO** to return to the Synth Options menu, or **YES** to make another copy.

SPECTRUM SYNTHESIS

T SLICE -> SP

(Use for moving a time slice to a spectrum location)

- A. Press **#2** on the keypad to access the Time Slice menu options.
- B. Use the slider to select the number of the time slice you wish to move. Press **ENTER**.
- C. Press **NO** three times to get to the MOVE screen.
- D. Press **YES**. The display will read "MoveTS01 to: SP01...".
- E. Use the slider to select the number of the spectrum where you want to move the time slice.
- F. Press **ENTER** to execute the move.

Note: After executing a function in the Time Slice options menu, it is not necessary to exit the menu before accessing another function. For example, you may DRAW a time slice, then EDIT, COPY, and MOVE it before returning to the Synth Options menu.

3. AMPLITUDE CONTOUR

In this menu you may draw, edit, and copy the amplitude envelope of specific partials.

DRAW a partial's Amplitude Contour

(Use for quick and easy creation of the volume envelope of a specific partial)

- A. Press **#3** on the keypad to access the Amplitude Contour menu options.
- B. Use the slider to select the number of the partial whose amplitude contour you wish to draw. Press **ENTER**.
- C. Press **YES** to start the drawing countdown. You will see the display countdown 5...4...3...2...1... When the countdown finishes, the drawing process starts. The cursor position automatically moves from left to right - each position of the cursor denoting one time slice. By raising and lowering the slider as the cursor moves across the screen, you can draw the amplitude of the partial at each of the 24 time slice locations. The bar graph displays the relative amplitude of the partial at each time slice.
- D. Press **NO** twice to return to the Synth Options menu.

EDIT a partial's Amplitude Contour

(Use for precise definition of partial amplitudes)

- A. Press **#3** on the keypad to access the Amplitude Contour menu options.
- B. Use the slider to select the number of the partial whose amplitude contour you wish to edit. Press **ENTER**.

SPECTRUM SYNTHESIS

- C. Press **NO** to get to the amplitude contour EDIT screen. Press **YES** to edit.
- D. Use the slider to enter the amplitude of the partial at each time slice. Amplitude is shown in percentages on the right hand side of the screen.
- E. Use the cursor (<- ->) buttons to move from time slice to time slice.
- F. Press **ENTER** , then **NO** twice to return to the Synth Options menu.

COPY a partial's Amplitude Contour

(Use for copying the amplitude contour of a partial to one or more partials)

- A. Press **#3** on the keypad to access the Amplitude Contour menu options.
- B. Use the slider to select the number of the partial whose amplitude contour you wish to copy. Press **ENTER**.
- C. Press **NO** two times to get to the amplitude contour COPY screen.
- D. Press **YES** to copy. The display reads "Copy AC01 to AC01...".
- E. Use the slider to select the number of the partial that you wish to copy the amplitude contour to.
- F. Press **ENTER** to execute the copy, then **YES** to make another, or **NO** to return to the Synth Options menu.

Note: After executing a function in the Amplitude Contour options menu, it is not necessary to exit the menu before accessing another function. For example, you may DRAW an amplitude contour, then EDIT and COPY it before returning to the Synth Options menu.

4. PITCH CONTOUR

In this menu you may draw, edit, and copy the pitch envelope of specific partials.

DRAW a partial's Pitch Contour

(Use for quick and easy creation of the pitch envelope of a specific partial)

- A. Press **#4** on the keypad to access the Pitch Contour menu options.
- B. Use the slider to select the number of the partial whose pitch contour you wish to draw. Press **ENTER**.
- C. Press **YES** to start the drawing countdown. You will see the display countdown 5...4...3...2...1... When the countdown finishes, the drawing process starts. The cursor position automatically moves from left to right - each position of the cursor denoting one time slice. By raising and lowering the slider as the cursor moves across the screen, you

SPECTRUM SYNTHESIS

can draw the pitch of the partial at each of the 24 time slice locations. The bar graph displays the relative pitch of the partial at each time slice, from plus 1 semitone to minus 1 semitone.

D. Press **NO** twice to return to the Synth Options menu.

EDIT a partial's Pitch Contour

(Use for precise definition of partial pitches)

A. Press **#4** on the keypad to access the Pitch Contour menu options.

B. Use the slider to select the number of the partial whose pitch contour you wish to edit. Press **ENTER**.

C. Press **NO** to get to the pitch contour EDIT screen. Press **YES** to edit.

D. Use the slider to enter the pitch of the partial at each time slice. Pitch is shown in cents on the right hand side of the screen, from -99 cents to +98 cents.

E. Use the cursor (<- ->) buttons to move from time slice to time slice.

F. Press **ENTER** , then **NO** twice to return to the Synth Options menu.

COPY a partial's Pitch Contour

(Use for copying the pitch contour of a partial to one or more partials.)

A. Press **#4** on the keypad to access the Pitch Contour menu options.

B. Use the slider to select the number of the partial whose pitch contour you wish to copy. Press **ENTER**.

C. Press **NO** two times to get to the pitch contour COPY screen.

D. Press **YES** to copy. The display reads "Copy PC01 to PC01...".

E. Use the slider to select the number of the partial that you wish to copy the pitch contour to.

F. Press **ENTER** to execute the copy, then **YES** to make another, or **NO** to return to the Synth Options menu.

Note: After executing a function in the Pitch Contour options menu, it is not necessary to exit the menu before accessing another function. For example, you may DRAW a pitch contour, then EDIT and COPY it before returning to the Synth Options menu.

SPECTRUM SYNTHESIS

5. PITCH/RATIOS

In this menu you may determine the pitch of the note you are synthesizing, and define the ratios of all of the partials. Original pitch may range from C \emptyset to C5. Partials may be any ratio to the fundamental pitch from 1.00 to 40.99. The default pitch is C3 (middle C). The default ratio tunings of the partials are harmonics 1 through 24.

To **DEFINE** the **PITCH** of the sound you wish to synthesize

- A. Press **#5** on the keypad to access the Pitch / Ratios menu. Partial #1 appears on the screen and shows a default pitch of C3.
- B. Press the right cursor button to move the cursor under the C3.
- C. Use the slider or the YES/NO buttons to select the desired pitch.
- D. Press **ENTER** to return to the Synth Options menu.

To **DEFINE PARTIAL RATIOS**

Use for tuning partials to ratios other than the first 24 in harmonic series.

- A. Press **#5** on the keypad to access the Pitch / Ratios menu.
- B. Use the slider to select the partial whose ratio you wish to define.
- C. Press the right cursor button to select the partial tuning "tens" column.
- D. Use the slider, YES/NO buttons or the keypad to enter the ratio you desire.
- E. Press the right cursor button to select the partial tuning "hundreds" column.
- F. Use the slider, YES/NO buttons or the keypad to enter the ratio you desire.
- G. Press **ENTER** to return to the Synth Options menu.

Note: After defining a pitch or ratio tuning in the Pitch / Ratios options menu, it is not necessary to exit the menu before accessing another partial. For example, you may define the pitch of the synthesized sound, then set the ratios of up to 24 different partials before returning to the Synth Options menu.

6. INTERPOLATE

Use for creating spectrums between time slices, or for smoothing out the harmonic movement from one time slice to another.

- A. Press **#6** on the keypad to access the Interpolation screens.
- B. Use the slider to select the time slice you wish to interpolate *from*.

SPECTRUM SYNTHESIS

C. Press **ENTER**.

D. Use the slider to select the time slice you wish to interpolate *to*.

E. Press **ENTER** to return to the Synth Options menu.

Note: An easy way to create a sound is to place a spectrum at time slice #1, place another spectrum at time slice #24, then Interpolate from time slice 1 to time slice 24. This fills in time slices 2 through 23. If there is no spectrum at a given time slice, then there will be no sound generated when that time slice is played. It is necessary to define a spectrum at each time slice, or interpolate across "blank" time slices to synthesize an uninterrupted sound.

7. LOAD PARAMETERS

Use to load Time Slices, Amplitude Contours, and Pitch Contours from one of the three backup banks into the current memory.

A. Press **#7** on the keypad to access the Load Parameters function.

B. Use the slider to select the backup bank you wish to load. (The display will show whether the bank is empty or full.)

C. Press **ENTER** to execute the load and return to the Synth Options menu.

8. SAVE PARAMETERS

Use to save Time Slices, Amplitude Contours, and Pitch Contours (All Parameters) into one of the three backup banks from the current memory.

A. Press **#8** on the keypad to access the Save Parameters function.

B. Use the slider to select the backup bank you wish to save the current memory to. (The display will show whether the bank is empty or full)

C. Press **ENTER** to execute the save and return to the Additive Options menu.

Please Note: Parameters are not saved to disk until you have "Saved Bank".

Also Note: The parameters of a sound are not automatically loaded when that sound file is selected in Digital Processing. If you believe that it will be necessary to edit a sound after you have already started working on another one, it is advisable to first save the parameters of the sound before starting on the new one. This is the only way that the sound's original parameters can be restored. Failure to save these parameters will prevent you from re-creating your sound!

SPECTRUM SYNTHESIS

9. ERASE PARAMETERS

The following parameters may be erased:

- None
- Backup #1
- Backup #2
- Backup #3
- Current Parameters
- Spectrums (*entire* palette)
- All! (everything listed above)

To **ERASE** parameters:

- A. Press **#9** on the keypad to access the Erase screens.
- B. Use the slider to access the erase option you desire.
- C. Press **ENTER** then **YES** to execute the erase and return to the Synth Options menu.

0. SYNTHESIZE!

Use to generate the sound that you have defined.

- A. Press **#0** on the keypad to access the Synthesize! menu.
- B. Use the slider to select "smooth" or "stepped".
- C. Press **ENTER** to begin synthesizing.
- D. When Emax has finished its calculations, play your sound!
- E. Press **ENTER** again to return to the Synth Options menu.

Note: After returning to the Synth Options menu, the sound will no longer be active on the keyboard. The only time you can hear your sound while in the Synth Options menu is immediately after it has been synthesized.

Also Note: There are two modes of synthesis - "Smooth" and "Stepped". "Smooth" will produce a very gradual tonal change from time slice to time slice. "Stepped" will result in more abrupt tonal changes, as each time slice plays for exactly one twenty-fourth of the sound and then jumps to the next time slice. A sound may be synthesized in one mode and then synthesized again in the other mode. Use the mode that best suits the type of sound you are trying to create.

SPECTRUM SYNTHESIS

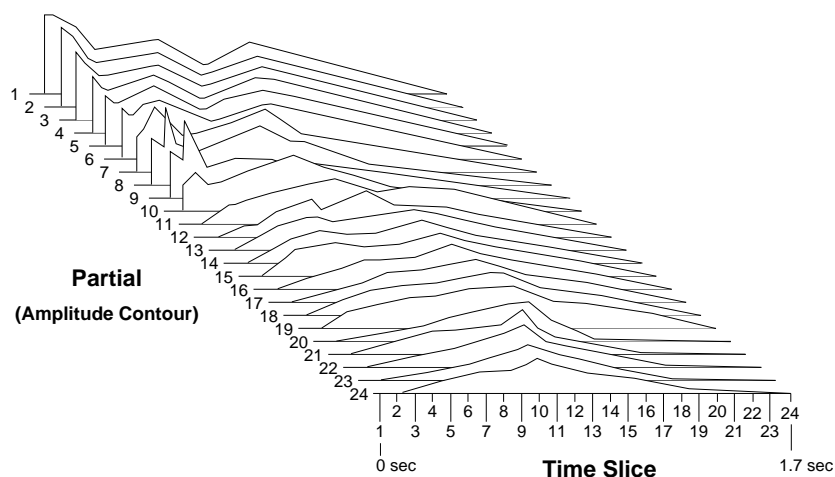

APPROACHING SPECTRUM SYNTHESIS

As with any type of synthesis, there are many ways of approaching the creation of sound. No matter how long you have worked with any synthesizer there are always sounds that have yet to be created. The palette of possible sounds is just so large that whole categories are bound to be missed. And remember that some of the best sounds are created by chance.

There is a great deal to be learned about sound. Spectrum Synthesis (and the Emax II in general) can be thought of as a powerful audio laboratory. Spectrum Synthesis is just one of the tools in your lab. Here we have presented some ideas so you will have a starting point with regard to your experiments. Remember to turn in your lab notebook by Friday.

SPECTRUM SYNTHESIS EXPERIMENTS

- Start with a Spectrum at Time Slice location 01 and one at location 24. Interpolate between them, then synthesize. Add Spectrums to the sound in order to add complexity.
- Create sounds by using the Amplitude Contour function. This may be a more intuitive way for you to synthesize sounds. Amplitude Contour lets you draw the amplitude envelope for each partial as shown in the Amplitude Contour diagram. Use combinations of Time Slicing and Amplitude Contouring.
- Insert wildly varying Spectrums at each Time Slice location and synthesize using the Step function for wavetable synthesizer sounds.
- Splice the sampled attack portion of a sound onto the beginning of your synthesized sound. Preset 01 (InstAttacks!) of the Spectrum Synthesis development disk contains a full range of various attacks just for this purpose. The attack portion of a sound carries a great deal of information to your ears about the nature of a sound. That sampled flute chiff might be just what your synthesized sound needs.

SPECTRUM SYNTHESIS

- Use the Pitch/Ratio function to set the upper 12 partials so that they are just slightly detuned from the first 12. For instance, set the ratio of partial 13 to 1.06, partial 14 to 2.06 and so on. This will cause beating between the oscillators and fatten up the sound just as it does on an analog synth. Spectrums 11 through 20 (marked "1-12" in their titles) on the Spectrum Synthesis development disk have their partials set up in this way.
- Use the Pitch/Ratio function to change the ratios of the partials so that they are not whole number multiples of the fundamental. This will get you into the realm of bell and clangorous noises. Try changing the ratios of just one or two partials and note the effects.
- Each partial has its own 24 stage pitch envelope. Many natural sounds have pitch variations occurring at various points during their evolution. For instance, plucked string instruments start off a little sharp, then return to pitch. Experiment by pitch bending different partials and noting the effect.
- Mathematics and music always seem to be closely related. Try applying mathematical ratios and number series to the creation of sound. For instance, interpolate between prime numbered harmonics and non-prime numbered harmonics. Fibonacci sequences, ie. 1,1,2,3,5,8,13,21...., or squares, cubes, etc. You name it.
- If you have Sound Designer by Digidesign, try taking a sampled sound and running a frequency analysis on it. Next, make a print out of the frequency plot and try to copy the partial envelopes using the Amplitude Contour function in Spectrum Synthesis. It probably won't sound exactly like the real sound but will put you into the general area for further experiments.

OTHER TIPS

- **Save Time** You have noticed that the Emax II takes time to perform the thousands of calculations necessary for Spectrum Synthesis. You can save your valuable time by working on short sounds (.6 sec to 1.2 sec), then lengthening it when it sounds the way you want. You will still be able to hear the sound's characteristics and the calculation time will be cut dramatically. Also bear in mind that the fewer partials that are in the sound, the less time it will take to synthesize. Interesting sounds can be created with just a few partials.
- **Multisample** Resynthesize your sound at at least 4 pitches and place them across the keyboard to minimize the negative effects of pitch shifting.
- **Save Parameters** When you have created an interesting sound, use the "Save Parameters" function to save it to one of the three backup banks. You can recall the parameters later and use them as a starting point to create new sounds. Remember to "Save Bank" or the parameters will be lost forever.

DIGITAL SOUND TRANSFER

Digitally transferring samples into the Emax II is an efficient way to quickly build up your sample library. Because of the Emax II's near perfect pitch shifting, phenomenal S/N ratio, and 16-bit resolution, the result will be improved sound quality even if the samples were originally sampled on a 12-bit sampler.

MIDI SAMPLE DUMP

The MIDI Sample Dump Standard was created so that sound samples could be transferred between samplers regardless of brand. The Emax II has the ability to send and receive MIDI Sample Dumps, *but*, it cannot initiate a transfer from the front panel. It can only send and receive samples in response to a MIDI command. The *other* device must be the initiator.

In sending or receiving a sample dump, the Emax II uses *sample numbers* to identify which sample will be transmitted or where a sample will be placed. Emax II has an 88 note keyboard range. Primary Voices are sent and received using sample numbers 0-87 and Secondary Voices are sent and received using sample numbers 256-343. For example; If the Emax II is sent sample # 24, that sample will be placed in a primary voice on Emax II key A2. If it is requested to send sample # 280, then the secondary voice assigned to Emax key A2 will be sent. If there is no voice on Emax II key A2, the request will be ignored. The diagram below shows the MIDI key numbers in relation to the Emax II keyboard.

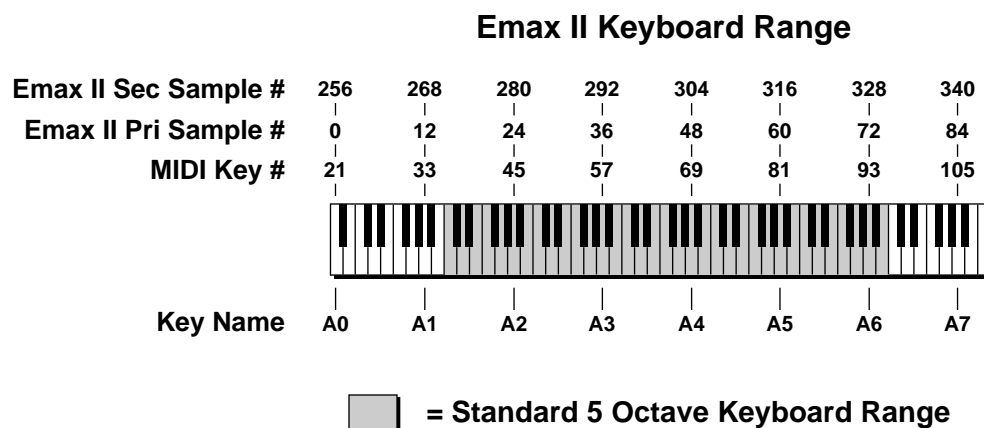

Sometimes after transferring a sound into the Emax II, the loop points may need to be adjusted. If there are clicks in transferred samples, try decreasing the Loop Start point by 2 (or 3) samples and increasing the Loop Length by 1 sample. This error is due to the way Emax II interpolates samples for pitch shifting.

DIGITAL SOUND TRANSFER

LOADING EMAX I DISKS

When Emax I disks are loaded into the Emax II, they are automatically expanded out into a 16-bit format. This dynamic range expansion coupled with the low noise of the Emax II, usually means that Emax I disks sound fantastic on the Emax II. In addition, all the preset parameters are retained. Sometimes, however, audio problems that were inaudible on Emax I, are quite noticeable on the Emax II and must be manually corrected. There are also a few restrictions on Emax I sounds.

- 1) Emax I banks which are completely full, will not load into a 1 Megabyte Emax II. This is because the Emax II needs some memory to perform the 16-bit dynamic range expansion. The solution is to delete sequences, presets or voices until the disk loads.
- 2) The minimum Loop Length on the Emax II is 32 samples. If Emax I voices are loaded which have Loop Lengths of less than 32 samples, the loop may be turned off of the transposition range may be limited. The solution is to re-loop those voices.
- 3) The Emax II has a few features which are different from the Emax I.

Emax II uses polyphonic outputs instead of mono outs like the Emax I. Emax I voices with outputs 1-8 selected will be routed to the Main outputs on Emax II. If specific outputs *are* selected on Emax I voices loaded into the Emax II, the output routing will be as follows:

| Emax I | Emax II | |
|--------|---------|------------------------|
| 1->1 | A | |
| X->2 | B | |
| X->3 | C | |
| X->4 | M | X = any channel number |
| X->5 | A | |
| X->6 | B | |
| X->7 | C | |
| X->8 | M | |

Emax I voices which are in Dual Mode will play normally on the Emax II but will use two channels.

MIDI SUPPLEMENT

BASICS: QUESTIONS AND ANSWERS ABOUT MIDI

MIDI is causing a certain amount of confusion among musicians. Fear not—it's not all that hard to understand, and the Emax II makes it particularly easy to deal with. For those of you who aren't that familiar with MIDI, we'll first answer some common questions.

What does the MIDI cable do?

An instrument already has an AC cord that carries electrical current, and an audio cord that carries audio signals to an amplifier. Now you have a third connection: the MIDI cable. This carries neither audio nor power, but transmits information about the status of the instrument to, and receives "status reports" from, other MIDI instruments. This information is coded in a computer language...a somewhat primitive language with few words and several dialects, but a language nonetheless.

What does MIDI stand for?

MIDI stands for Musical Instrument Digital Interface. You already know what "musical instrument" means, so that takes care of the first half of this phrase. *Digital* means that the instrument's information is conveyed in digital, or computer, language. *Interface* is the term for the actual link between instruments, where data passes from one instrument to another. So MIDI is a link between musical instruments that speaks data in computer language.

How can information control a synthesizer?

First we need to know a bit about computers, since MIDI instruments have microcomputer souls...in fact, MIDI could not exist without microcomputers.

Computers are decision makers, and they base those decisions on the data they receive. However, to be useable by a computer any data has to first be translated into a number-based language that the computer can understand. Actually, when you press a keyboard key with a computer-based instrument, you are not directly controlling the sound source. Instead, each time you close a keyboard switch you're sending a number to the computer, and this *number* tells the computer what note you want *it* to play for you.

The computer's "window on the world", where it receives and transmits numerical data, is called its *data bus*. The computer looks to see whether any information is on the data bus, and if so, acts on this data. For example, if it sees a digital "word" that says "play F#" on the data bus, it will do as the data commands and control a sound source so that it plays an F#. However, note that the computer doesn't care whether this word is placed on the data bus due to closing a keyboard switch or striking a guitar string—once MIDI translates a note into computer language, the note becomes compatible with any device that speaks the same language. MIDI provides access to the computer's data bus and selects which device will be "on the bus" at any particular moment, thus letting you determine the flow of information from one MIDI device to another. This is why having a specification that manufacturers can follow is so important; it insures that a variety of otherwise incompatible devices will be able to communicate with each other over a common data bus.

MIDI SUPPLEMENT

How does MIDI differentiate between different MIDI instruments on the same bus?

MIDI provides 16 independent channels of information suitable for driving up to 16 polyphonic synthesizers or other MIDI devices. There are three modes that determine how each MIDI instrument responds to these channels.

In **Omni** mode, the Emax II (or any other MIDI keyboard) listens to all channels at once. No matter how many notes from how many sources make it through the MIDI bus into the instrument, when in Omni mode it will attempt to play all of them.

In **Poly** mode, the instrument can “tune in” to one MIDI channel — just like you can tune in one channel of your television.

Mono mode is considered a “multi-timbral” mode. In mono mode, *each* individual analog synthesizer voice can be driven by one specific MIDI channel of information to play a certain melodic line. Each voice can also have its own “patch” (program), so an analog synthesizer capable of MIDI Mono mode can therefore produce multiple timbres simultaneously. Since the Emax II does not have an equivalent to the analog synthesizer voice, Mono mode is technically not supported by the Emax II. However, in the Emax II Super Mode, each preset can be assigned to receive information through a separate MIDI channel, which provides Mono-like operation but unlike traditional MIDI Mono operation, each preset can respond polyphonically. Of course, you still cannot play more than sixteen notes on the Emax II regardless of what MIDI mode you select.

16 channels, huh? Sounds like a lot of patch cords to me!

MIDI information is transmitted *serially*, which means that all data is sent in sequence. As a result, a single line can carry the MIDI information for all 16 channels, with each instrument monitoring all the words that pass over the MIDI interface but responding only to the data on its particular channel. Typically, MIDI instruments include a MIDI IN, MIDI OUT, and MIDI THRU jack. The instrument receives data over the MIDI IN jack and transmits data over the MIDI OUT jack; the MIDI THRU jack provides a replica of the signal at the MIDI IN jack. Therefore, if you want to slave three keyboards to a master keyboard, you would patch the MIDI OUT from the master keyboard to the MIDI IN of the first slave, patch MIDI THRU from the first slave to the MIDI IN of the second slave, and connect MIDI THRU from the second slave to MIDI IN of the third slave. Note that the Emax II provides two jacks, MIDI IN and another jack which is software-selectable to provide either the MIDI THRU or MIDI OUT function.

What kind of words does the MIDI language include?

Spoken language is a collection of words that convey a particular set of meanings, hopefully understood by all those who speak the language. As soon as we start talking about a musical language, the first question is: What concepts do we want this language to define? Since musical instruments will be doing the talking, the language should consist of musical terms—pitch, tempo, and so on. In fact, let’s set up a practical example and see what words our language would need.

MIDI SUPPLEMENT

Suppose we have two synthesizers, Synth A and Synth B, and want Synth B to precisely follow along with what is being played on Synth A to create a “doubling” effect. To do this, our “language” would have to convey several things.

First, Synth A would have to tell Synth B whenever a key was hit and which key it was (“hey Synth B, play F#!”). We’ll call this the NOTE ON word.

This turns on the keys just fine, but now we need a way for Synth A to tell Synth B when a note is over so it can turn the key back off again. We can call this the NOTE OFF word.

Now we have the notes under control, but what happens if we do some pitch-bending on Synth A? As it is, Synth B wouldn’t follow because it can only tell if a note has been turned on or off—not if its pitch has been changed. So, we need a new word that indicates a pitch bend CONTROL CHANGE.

Everything’s fine until we switch patches, at which point Synth A changes but Synth B doesn’t. We clearly need another word to signal PROGRAM CHANGE, so that if you call up a different patch on Synth A, Synth B will call up a different patch as well (which you have hopefully programmed to sound compatible with Synth A).

And the list of words goes on...what happens if both synthesizers can respond to dynamics? You’ll also want to transmit that data from one synth to another. We also need some information about the system tempo, as set by a drum machine or sequencer...

MIDI’s vocabulary encompasses all these considerations, as well as many others. For a more detailed description of the complete MIDI vocabulary, refer to the book “MIDI For Musicians” (AMSCO Publications, a division of Music Sales).

TYPICAL MIDI APPLICATIONS

■ **Slave two keyboards together so that one doubles the other for lush-sounding string effects, choirs, and so on.** To do this with the Emax II and another MIDI instrument, connect the MIDI IN from one machine to the MIDI OUT of the other instrument. Select Omni mode and the same basic channel for both instruments—either keyboard should be able to control the other instrument. If you program each instrument to receive “program change information”, changing presets on the Emax II should change programs on the other MIDI synthesizer, and vice-versa.

■ **Slave two keyboards together to create a composite sound.** For example, you might like the sound of Emax II violins fading in as the attack of a digital synth violin patch fades out.

■ **When composing, you can sequence parts via MIDI and experiment with changing timbres.** How would that harmony line sound as a piano instead of a guitar? Re-assign presets on an Emax II sequence and find out.

MIDI SUPPLEMENT

■ **Dynamic control of drum machines.** If you have a drum machine with MIDI, you can program it dynamically from Emax II keyboard. Run a MIDI cable from the Emax II MIDI OUT to the drum machine's MIDI connector, then consult your drum machine operation manual for information on which Emax II keys control which drums.

ABOUT THOSE MIDI CONTROLLERS...

MIDI controllers cause a lot of confusion all by themselves, so hooking them up to other instruments doesn't make things any easier. Fortunately, though, the Emax II is quite helpful in setting up the MIDI controllers functions.

To understand what a "MIDI controller" is, we first must understand what a "controller" is. A "controller" is a device which provides a means of smoothly controlling a certain parameter. The Emax II has 6 such controllers: Left Wheel, Right Wheel, Pressure, Pedal, MIDI Ctrl A, and MIDI Ctrl B.

MIDI however, does not support a "Left Wheel", "Right Wheel", or "Pedal" controller because that would be too machine-specific. Instead, MIDI simply numbers the controllers 0 to 63 and lets the manufacturer decide how it wants to adapt these "MIDI controllers" to its machine. In addition to the controller numbers, MIDI supports two special controllers that are used so often they have their own commands. These are "pitch wheel" and "channel pressure".

The Emax II supports MIDI controller numbers 0 to 31, as well as "pitch wheel" (pwh) and "channel pressure" (chp), for a total of 33 possible MIDI controllers. The Emax II allows the user to map each of the 6 internal controllers to any of the 33 MIDI controllers (**PRESET DEFINITION 7**).

As an example, let's say the Emax II's Left Wheel is set in **PRESET DEFINITION 9** to control pitch, and mapped to MIDI controller #19 **PRESET DEFINITION 7**. Now, every time the Emax II's Left Wheel moves, the pitch changes and the wheel value goes out the MIDI OUT jack as MIDI controller #19. Also, if MIDI controller #19 comes in the MIDI IN jack, the Emax II will treat it the same as it does its own Left Wheel, i.e., change pitch.

The Emax II's MIDI Ctrl A and MIDI Ctrl B, unlike its other four controllers, are only accessible via the MIDI IN port. However, all 6 controllers can be recorded to the sequencer and all 6 will be sent on MIDI OUT during playback.

MIDI SUPPLEMENT

FINDING OUT ABOUT OTHER SYNTHESIZER'S MIDI CAPABILITIES

It's easy to find out the controller numbers for parameters on another synthesizer by patching the Emax II MIDI OUT connector to the other synth's MIDI IN. During MIDI Setup select the "Rt Wheel" setup step, use the slider to select a controller number, vary the right wheel, and note any changes. Select another controller number, vary the right wheel, and see what that affects. Most synthesizers will only have a few controllers assigned; note which control numbers affect which parameters, and write them down for future reference.

For a practical example of how to use this feature, suppose you want to use the Emax II footpedal to simultaneously fade out the Emax II and a MIDI'ed synthesizer. During MIDI setup, select the "Pedal" setup step, and use the slider to change controller numbers until you find the number that corresponds to overall level. Suppose the controller number is 07. If you assign the Emax II "Level" Real Time destination to the footpedal and also send the footpedal information out over the MIDI controller 07, both instruments should fade in and out together.

DEALING WITH "MIDIOSYNCRACIES"

There are occasional compatibility problems between MIDI gear from different manufacturers; however, many problems are created by operator error and/or a lack of understanding of how MIDI works. If you transmit information on one channel and have the "receiver" set up for a different channel, forget it. MIDI is quite unforgiving that way...you can hit a bum note and not too many people will notice, but send a computer a wrong number and it will most definitely notice.

MIDI is a lot of fun provided that you don't get discouraged when things go wrong. Many times there is a solution; sometimes there isn't. In any event, MIDI as it is today is far better than no MIDI at all. At the very least you can almost always slave two keyboards together, and drive MIDI keyboards from a MIDI sequencer. If you don't understand things at first, don't worry—keep experimenting and eventually everything will fall into place.



APPENDIX

| | |
|------------------------------------|------------|
| VELOCITY CURVES | 230 |
| EMAX II MEMORY EXPANSION | 235 |
| TECHNICAL SPECIFICATIONS | 236 |
| MIDI IMPLEMENTATION CHART | 237 |
| NOTE-FREQ. CONVERSION CHART | 238 |
| INDEX | 239 |
| WARRANTY | 243 |

VELOCITY CURVES

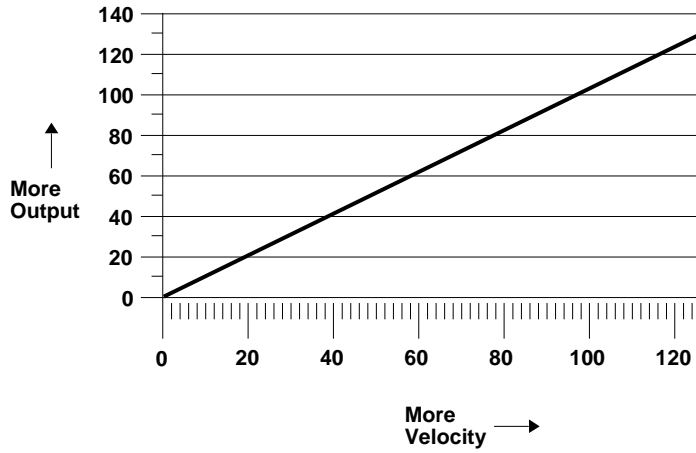

1. Linear

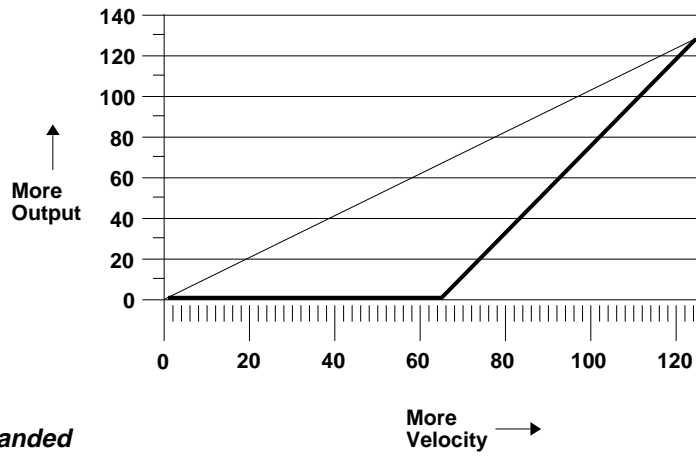

2. Heavy Handed

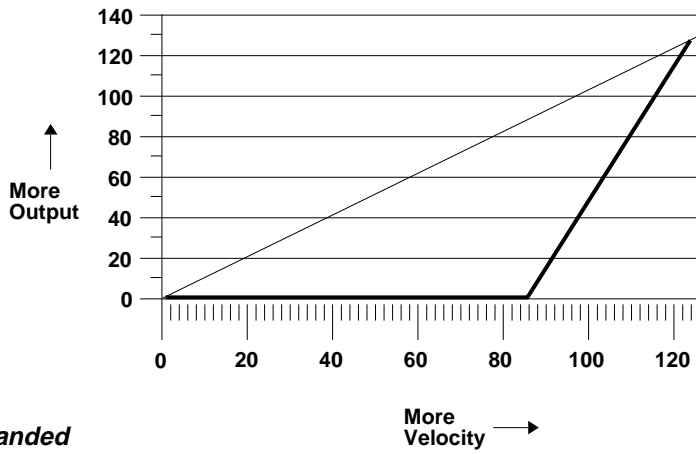

3. Heavy Handed

VELOCITY CURVES

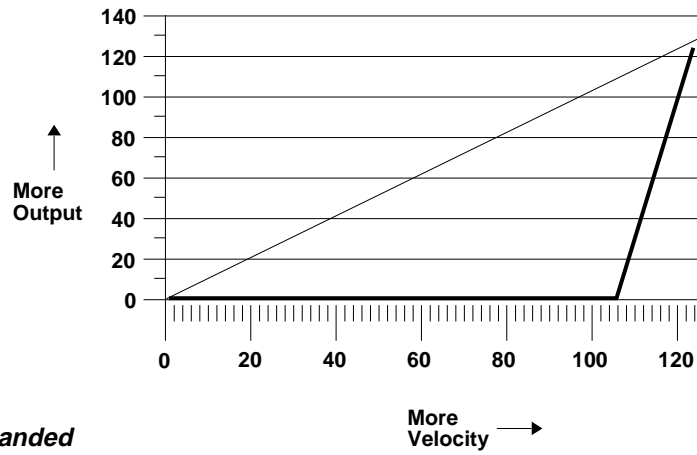

4. Heavy Handed

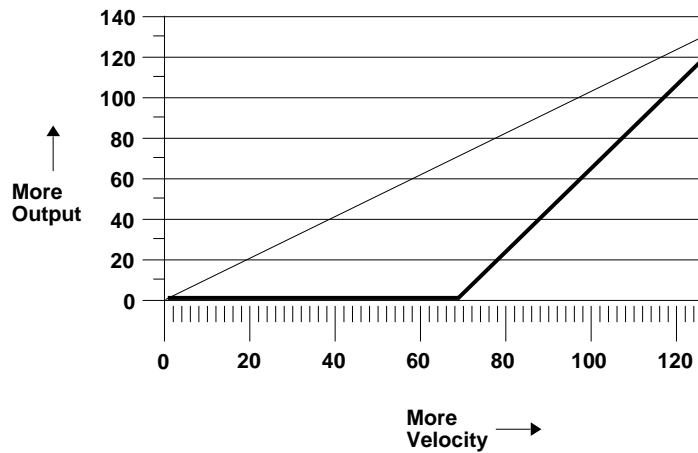

5. Clipped

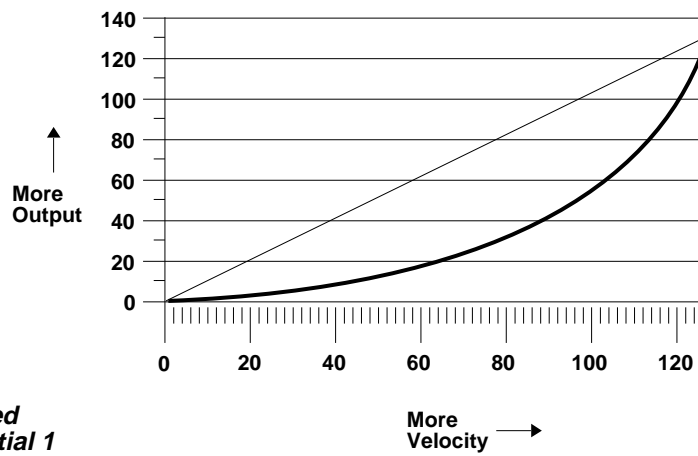

6. Concaved Exponential 1

VELOCITY CURVES

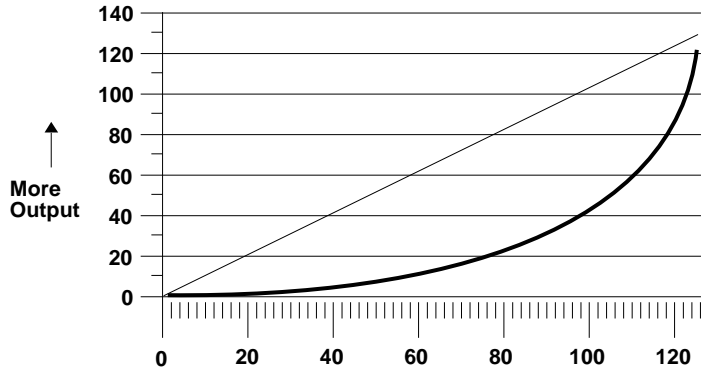

7. Concaved Exponential 2

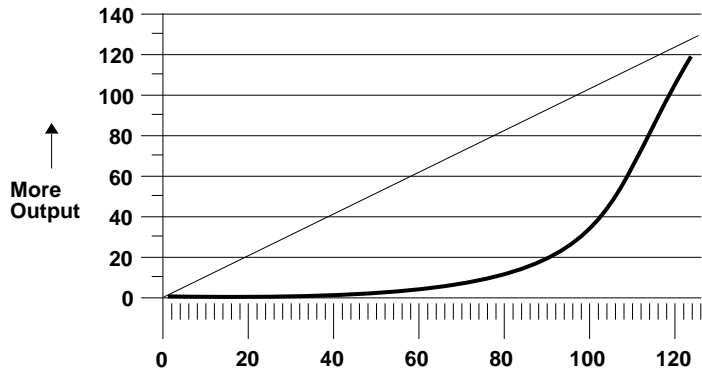

8. Concaved Exponential 3

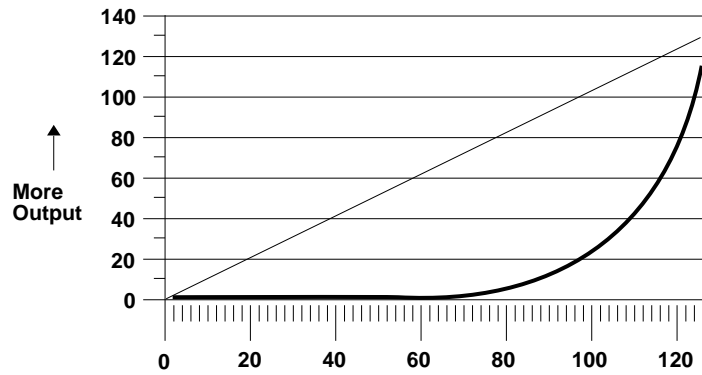

9. Concaved Exponential 4

VELOCITY CURVES

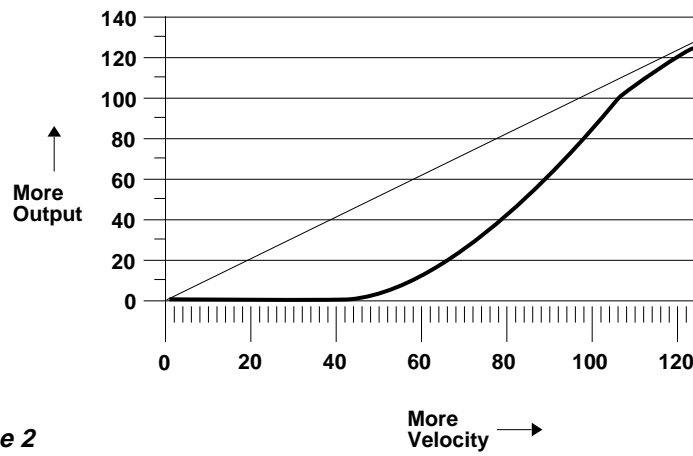
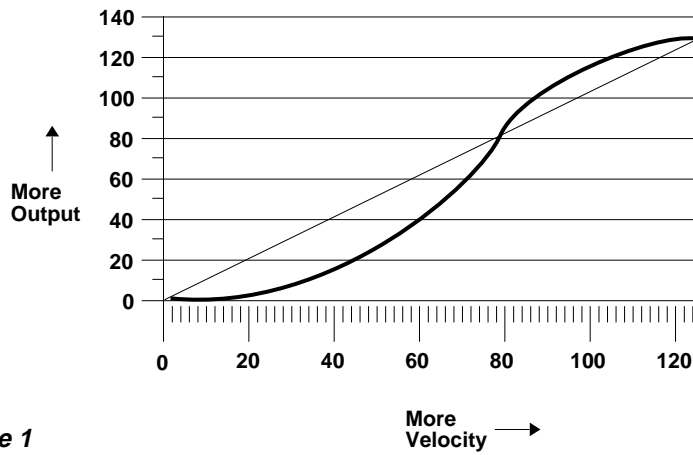
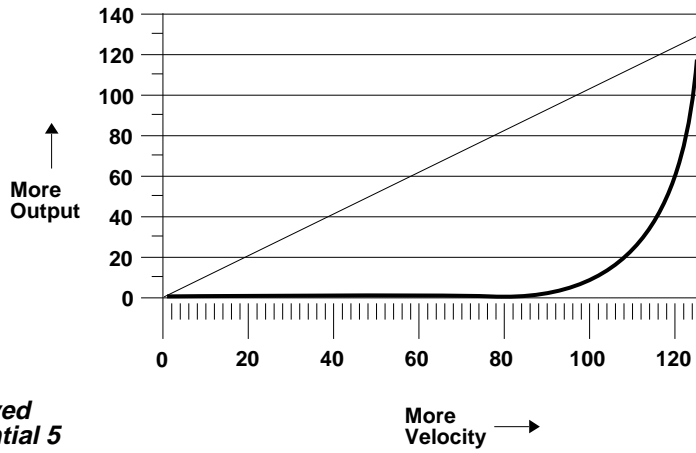

VELOCITY CURVES

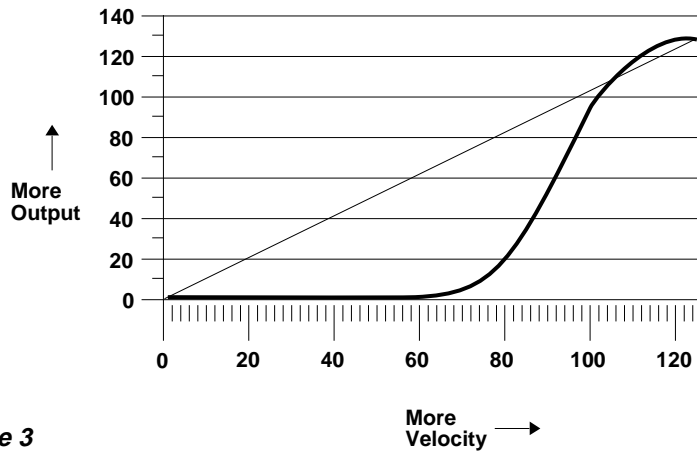

13. S-Shape 3

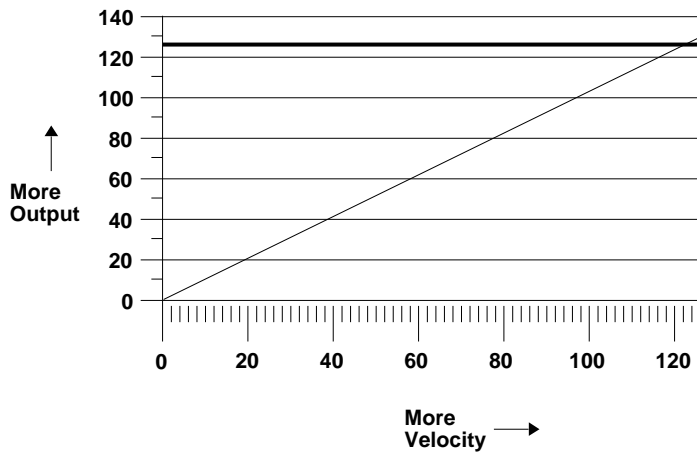

14. Trigger

EMAX II MEMORY EXPANSION

INCREASE YOUR MEMORY

The amount of memory in your Emax II determines the bank size and thus the amount of sample time which can reside in the unit at one time. Emax II comes standard with either 2 or 6 Megabytes of memory, but it can be considerably expanded. Memory expansion kits may be added to increase the bank size up to 8 Megabytes. The charts below show how Emax II may be expanded in 2 Megabyte stages.

| | 2 MB Emax II | Total Memory |
|---------|---------------|--------------|
| 1st add | Memory Board | 4 MB |
| 2nd add | 2 MB Xpansion | 6 MB |
| 3rd add | 2 MB Xpansion | 8 MB |

| | 4 MB Emax II | Total Memory |
|---------|---------------|--------------|
| 1st add | 2 MB Xpansion | 6 MB |
| 2nd add | 2 MB Xpansion | 8 MB |

The chart below shows the amount of sample time available with various amounts of memory. For stereo samples, divide the time in half.

| SAMPLE RATES | TIME (seconds) | | | | | | | |
|--------------------|----------------|-------------|-------------|-------------|-------------|--------------|--------------|--------------|
| | 1 M | 2 M | 3 M | 4 M | 5 M | 6 M | 7 M | 8 M |
| 20.000kHz | 26.1 | 52.5 | 78.6 | 104.9 | 131.1 | 157.3 | 183.5 | 209.7 |
| 22.050kHz | 23.7 | 47.6 | 71.3 | 95.1 | 118.9 | 142.7 | 166.4 | 190.2 |
| 27.778kHz * | 18.9 | 37.7 | 56.6 | 75.5 | 94.4 | 113.2 | 132.1 | 151 |
| 31.250kHz * | 16.8 | 33.5 | 50.3 | 67.1 | 83.9 | 100.7 | 117.4 | 134.2 |
| 39.0625kHz | 13.4 | 26.9 | 40.3 | 53.7 | 67.1 | 80.5 | 94 | 107.4 |

* Sample rates shown in bold have a maximum *continuous* sampling time equal to that of the 39kHz rate. Emax II performs automatic sample rate conversion on the sample, then frees up the additional memory for subsequent sampling.

Information about the memory expansion kits is available from your local E-mu dealer.

EMAX II TECHNICAL SPECIFICATIONS

| | |
|-------------------------------|---|
| AUDIO CHANNELS: | 32 (16 Stereo) |
| AUDIO OUTPUTS: | 2 Main (stereo, poly) 6 Submix (3 stereo, poly) Stereo/Phones Mono |
| SUBMIX INPUTS: | 6 (3 stereo) |
| MAX OUTPUT LEVEL: | +4 dB into 600 Ω |
| INPUT IMPEDANCE: | 5 k Ω |
| OUTPUT IMPEDANCE: | Stereo 100 k Ω Mono 2.5 k Ω Audio 600 Ω |
| MIDI: | In, Out/Thru |
| DATA ENCODING: | Input 16-bit Linear Output 18-bit Linear |
| MAX INPUT SAMPLE RATE: | 39kHz |
| SIGNAL TO NOISE: | >90 dB |
| DYNAMIC RANGE: | Input >90 dB Output >102 dB |
| FREQUENCY RESPONSE: | 20 Hz - 19 kHz |
| THD+N: | <.05% |
| STEREO PHASE: | Phase Coherent $\pm 1^\circ$ @ 1 kHz |
| POWER REQUIREMENTS: | 45 Watts |

MIDI IMPLEMENTATION CHART

| COMMAND | TRANSMITTED | RECEIVED | COMMENTS |
|-----------------------|--------------------|-----------------|---------------------------|
| Note Off | Y | Y | keys 21-108 |
| Note On | Y | Y | keys 21-108 |
| Poly Key Pressure | N | N | |
| Control Change | Y | Y | Cntr. # 0-31 |
| Program Change | Y | Y | Prog. # 0-99 |
| Channel Pressure | N | Y | |
| Pitch Wheel | Y | Y | |
| Sustain Footswitch | Y | Y | Cntr. # 64 |
| Local Control On/Off | N | Y | |
| All Notes Off | N | Y | |
| Omni Mode On/Off | N | N | |
| Mono Mode | N | N | |
| Poly Mode | N | N | |
| Song Position Pointer | N | N | |
| Song Select | Y | Y | |
| Tune Request | N | N | |
| Timing Clock | Y | Y | |
| Start Sequence | Y | Y | |
| Continue Sequence | N | N | |
| Active Sensing | N | N | |
| System Reset | N | N | |
| System Exclusives | Y | Y | Call for Documentation |

Y = implemented

N = not implemented

SuperMode is an Emax II MIDI mode designed to enhance the sequencer/MIDI interface. It is basically equivalent to "Poly Mode On" for all 16 channels simultaneously.

When SuperMode is on, the Omni/Poly setting is ignored, but the MIDI notes/wheels flag of the current preset is still checked by Emax II to determine whether or not to accept or ignore incoming MIDI performance data.

Emax II's sequencer has 16 tracks, and each track has an independent preset assigned to it. These presets are referred to as "Sequencer Presets".

NOTE-TO-FREQUENCY CONVERSION CHART

Use this chart when performing Spectrum Synthesis or to compute perfect single cycle loops.

| note | frequency | note | frequency | note | frequency | note | frequency |
|------|-----------|------|-----------|------|------------|------|------------|
| C0 | 16.35 Hz | D2# | 77.78 Hz | F4# | 369.99 Hz | A6 | 1760.00 Hz |
| C0# | 17.32 Hz | E2 | 82.41 Hz | G4 | 392.00 Hz | A6# | 1864.66 Hz |
| D0 | 18.35 Hz | F2 | 87.31 Hz | G4# | 415.31 Hz | B6 | 1975.53 Hz |
| D0# | 19.45 Hz | F2# | 92.50 Hz | A4 | 440.00 Hz | C7 | 2093.01 Hz |
| E0 | 20.60 Hz | G2 | 98.00 Hz | A4# | 466.16 Hz | C7# | 2217.46 Hz |
| F0 | 21.83 Hz | G2# | 103.83 Hz | B4 | 493.88 Hz | D7 | 2349.32 Hz |
| F0# | 23.12 Hz | A2 | 110.00 Hz | C5 | 523.25 Hz | D7# | 2489.02 Hz |
| G0 | 24.50 Hz | A2# | 116.54 Hz | C5# | 554.37 Hz | E7 | 2637.02 Hz |
| G0# | 25.96 Hz | B2 | 123.47 Hz | D5 | 587.33 Hz | F7 | 2793.83 Hz |
| A0 | 27.50 Hz | C3 | 130.81 Hz | D5# | 622.25 Hz | F7# | 2959.96 Hz |
| A0# | 29.14 Hz | C3# | 138.59 Hz | E5 | 659.26 Hz | G7 | 3135.96 Hz |
| B0 | 30.87 Hz | D3 | 146.83 Hz | F5 | 698.46 Hz | G7# | 3322.44 Hz |
| C1 | 32.70 Hz | D3# | 155.56 Hz | F5# | 739.99 Hz | A7 | 3520.00 Hz |
| C1# | 34.65 Hz | E3 | 164.81 Hz | G5 | 783.99 Hz | A7# | 3729.31 Hz |
| D1 | 36.71 Hz | F3 | 174.61 Hz | G5# | 830.61 Hz | B7 | 3951.07 Hz |
| D1# | 38.91 Hz | F3# | 185.00 Hz | A5 | 880.00 Hz | C8 | 4186.01 Hz |
| E1 | 41.20 Hz | G3 | 196.00 Hz | A5# | 932.33 Hz | C8# | 4434.92 Hz |
| F1 | 43.65 Hz | G3# | 207.65 Hz | B5 | 987.77 Hz | D8 | 4698.64 Hz |
| F1# | 46.25 Hz | A3 | 220.00 Hz | C6 | 1046.50 Hz | D8# | 4978.03 Hz |
| G1 | 49.00 Hz | A3# | 233.08 Hz | C6# | 1108.73 Hz | E8 | 5274.04 Hz |
| G1# | 51.91 Hz | B3 | 246.94 Hz | D6 | 1174.66 Hz | F8 | 5587.65 Hz |
| A1 | 55.00 Hz | C4 | 261.63 Hz | D6# | 1244.51 Hz | F8# | 5919.91 Hz |
| A1# | 58.27 Hz | C4# | 277.18 Hz | E6 | 1318.51 Hz | G8 | 6271.93 Hz |
| B1 | 61.74 Hz | D4 | 293.67 Hz | F6 | 1396.91 Hz | G8# | 6644.88 Hz |
| C2 | 65.41 Hz | D4# | 311.13 Hz | F6# | 1474.98 Hz | A8 | 7040.00 Hz |
| C2# | 69.30 Hz | E4 | 329.63 Hz | G6 | 1567.98 Hz | A8# | 7458.62 Hz |
| D2 | 73.42 Hz | F4 | 349.23 Hz | G6# | 1661.22 Hz | B8 | 7902.13 Hz |

Emax II Sample Rates

20.000 kHz
22.050 kHz
27.778 kHz
31.250 kHz
39.0625 kHz

$$\frac{\text{Sample Rate}}{\text{Frequency}} = \text{Number of Samples in a Single Cycle Loop}$$

INDEX**A**

aftertouch *See* pressure
arpeggiator 126-132
attack 151, 152, 156
 realtime control of 142
attenuation of voices 98, 151
audition note function 67
auto extend 175

B

backup/restore 60
backwards mode 91
 See also reverse sound
bank 12
 multi-timbral bank 203-204
bird run 60
booting 16
bounce track 176

C

channel assignment 119, 163
chorus 162
clock 7
 arpeggiator clock 130
 external clock 7
 sequencer clock 169
 MIDI clock 169
combining voices 95
connections 5-8
contour
 spectrum synth, ampl. 213
 spectrum synth, pitch 214
 See also envelope generator
control enable 164
copy
 sequence 172
 software 65
 voice 115-117
crossfade mode 123-125, 142
cruz control 131
current preset 13
current voice 13, 25
 changing 81, 149
cursor 16

D

data slider 17
decay 151-153, 156
default 16

delay

LFO delay 157
voice delay 151

disk

drive selection 50
floppy disk 15, 45
 handling 44
 labeling 45
 write protecting 45
hard disk drive 15, 45, 57
 multi-timbral disk 203-204
downloading sequences 178-179, 202

E

enable, control 164
enter button 51
envelope generator
 description 152
 filter envelope 156
 VCA envelope 151-153
erasing
 bank memory 56
 floppy disks 57
 hard disk banks 59
 presets 109
 sequences 171
 spectrum synth params 218
 tracks 176
 voices 120
extensions, arpeggiator 128
external processing 5

F

filter 154-156
filter guided tour 28
floppy disk drive 15,
footswitches 7, 143-144
formatting disks 57
function buttons 45-51

G

gain change 98
glissando, arpeg. 132

H

hard disk drive 15, 45, 57
harmony, arpeg. 129-130
headphones

INDEX

- headroom selection control 69
- hold 151-153, 156
- I**
- ID number, SCSI
- inputs 5-8
- install disk function 69
- instant gratification 3
- interpolation 209, 216-217
- interval, arpeggiator 129
- intonation 151
- K**
- keyboard 16
- key number chart 221
- key velocity
 - See* velocity
- keyboard tuning *See* master tune
- L**
- latch, arpeggiator 127-128
- layer *See* stack presets
- LCD viewing angle 67
- LFO
 - definition 157
 - programming 157, 158
- link *See* stack presets
- loading
 - Emax I disks 222
 - floppy disks 3, 21, 50
 - hard disk 3, 22, 50
 - sequences 169-171
 - spectrum synth params 217
- looping
 - crossfade looping 96
 - guided tour 35
 - set loop points 84-91
 - autolooping 86
 - loop in release mode 91
- M**
- master tune 55
- memory
 - memory remaining 55
- MIDI
 - A, B 138-139
 - analyzer 68
 - channel selection 133
 - HD bank load 67
 - input 7
 - key number chart 221
 - level control 138-139, 140
 - local control 135
 - master functions 66
 - modes 134, 224
 - output 7
 - overflow 66
 - panning control 138-139, 142
 - preset change 134
 - questions & answers 223-227
 - sample dump 221-222
 - specifications 236
 - start/stop 134
 - realtime controllers 135-137
 - thru 133
- mix outputs 5, 118, 163
- modulation
 - realtime controls 138-144
 - See also* LFO and envelope
- module identifier 14
- multi-timbral op. 177-179, 201-204
- N**
- naming
 - presets 110
 - sequences 173
- noise reduction 185, 192
- non-transpose mode 163
- O**
- omni 134, 224
- outputs 5-8, 118, 163
 - output assignment 119, 163
- P**
- pan
 - MIDI control of pan 138-139, 142
 - setting pan position 161
 - LFO control of pan 158
- pedal
 - assignment 138-142
 - connection 7
- pitch bend range 138
- pitch contour, spectrum synth 214
- pitch/ratios, spectrum synth 216
- change pitch function 100

INDEX

- poly 134, 224
 - power requirements
 - See also* precautions section
 - pressure
 - pressure sensitive keyboard 15
 - receiving MIDI pressure 138-139
 - primary 14
 - preset
 - description 13
 - copying presets 110
 - creating presets 109
 - current preset 13
 - erasing 109
 - loading 107
 - making 13
 - naming 110
 - size 111
 - selection 22, 43
 - preset change via MIDI
- R**
- realtime controls
 - assignment 138-142
 - guided tour 31
 - recalibration 67
 - release 151-153, 156
 - repeats, arpeggiator 131
 - reverse sound 99
 - See also* backwards mode
 - RS-422 8
- S**
- sampling
 - arm sampling 76
 - art of sampling 183-195
 - basic description 11, 12
 - change sample rate 99
 - force sampling 77
 - guided tour 33
 - placing samples 73
 - sample dump 221
 - sample in connection 7
 - sample length selection 75
 - sample rate selection 74
 - sample rate vs time chart 75
 - sample start threshold 76
 - stop sampling 77
 - saving
 - basics 17
 - compressed format 108
 - 16-bit format 112
 - spectrum synth params 217
 - SCSI 8
 - SCSI boot ID 68
 - secondary 14
 - send/return cables 5
 - sequencer 165
 - basic description 23
 - guided tour 38
 - select sequence 168
 - sine wave 205-207
 - software revision display 69
 - solo mode 163
 - specifications
 - MIDI 236
 - technical 235
 - spectrum synthesis 103, 205-220
 - splice 93
 - split keyboard *See* voice assignment
 - stack preset 144
 - submix
 - inputs/outputs 5, 118, 163
 - send/return cables 5
 - supermode 177-179, 201-204
 - sustain 151-153, 156
 - synthesis *See* spectrum synthesis
 - synthesize! 209, 218
- T**
- taper 92
 - tempo, sequencer 168
 - tempo, arpeggiator 126
 - timeslice 207, 211-213
 - track, sequencer
 - status 174
 - track->preset 174
 - tracking, filter 154
 - transpose 49
 - transform multiplication 101
 - tremolo 158
 - truncation 82

INDEX

- guided tour 35
- tuning
 - alternate tunings 151
 - master tune 55
 - voice tuning 151
- V**
- VCA 151-153
- VCA guided tour 29
- velocity
 - velocity control of... 159-161
 - velocity crossfade 123-125
 - velocity cross/switch 123-125
 - velocity curves
 - selection 56
 - diagrams 230-234
 - guided tour 30
 - velocity sensitive keyboard 15
- vibrato 158
- viewing angle 67
- voice
 - voice assignment 73
 - editing 118
 - voice attenuation 151
 - current voice 13
 - copy voice 115
 - voice delay 151
 - description 12-14
 - erasing 120
 - primary voice 14
 - secondary voice 14
 - stereo 121
- volume
 - MIDI volume control 138-140
- W**
- wheel
 - pitch wheel range *See pitch*
 - wheel assignment 138

E-MU SYSTEMS PRODUCT WARRANTY

Please read this warranty, as it gives you specific legal rights.

Length of Warranty

This warranty covers all defects in materials and workmanship for a period of one year (90 days for disk drives) from the date of purchase by the original owner, provided that the Warranty Registration Card is filled out and returned to E-mu Systems within 14 days from the date of purchase. Cases may arise where E-mu's Service Department or one of E-mu's authorized service centers will ask for a copy of your sales receipt to facilitate warranty service. Please keep your purchase receipt in a safe place.

E-mu Systems does not cover:

- Damages due to improper or inadequate maintenance, accident, abuse, misuse, alteration, unauthorized repairs, tampering, or failure to follow normal operating procedures as outlined in the owner's manual.
- Deterioration or damage of the cabinet.
- Damages occurring during any shipment of the product for any reason.
- An E-mu product that has in any way been modified by anyone other than E-mu Systems, Inc.

Limitation of Implied Warranties

No warranty is expressed or implied. E-mu Systems specifically disclaims the implied warranties of merchantability and fitness for a particular purpose.

Exclusion of Certain Damages

E-mu Systems' liability for a product found defective is limited to repair or replacement of the unit, at E-mu's option. In no event shall E-mu Systems be liable for damages based on inconvenience, whether incidental or consequential, loss of use of the unit, loss of time, interrupted operation or commercial loss, or any other consequential damages.

Some states do not allow limitation of the duration of implied warranties or the exclusion or limitation of incidental or consequential damages, so the above limitations and exclusions may not apply to you.

How To Obtain Warranty Service

All E-mu products are manufactured with the highest standards of quality. If you find that your instrument does require service, it may be done by an authorized E-mu service center. If you are unable to locate a service center in your area, please contact E-mu Systems Service Department at (408) 438-1921. They will either refer you to an authorized service center or ask that you return your instrument to the factory. When returning an instrument to the factory, you will be issued a Return Merchandise Authorization number (RMA). Please label all cartons, shipping documents and correspondence with this number. E-mu suggests you carefully and securely pack your instrument for return to the factory. Mark the outside of the shipping carton clearly with your RMA number. Send to E-mu Systems, Inc. 1600 Green Hills Road, Scotts Valley, California, 95066. You must pre-pay shipping charges to the service location. E-mu Systems will pay return shipping fees. You will be responsible for any damage or loss sustained during shipment in any direction.

E-MU SYSTEMS WARRANTY REGISTRATION

Please take the time right now to fill out and mail in this warranty registration card. By doing so, you are assured of receiving news of all updates, product bulletins, and manual revisions. Thank you.

MODEL NUMBER: _____

Date Purchased: _____

SERIAL NUMBER: _____

Dealer's Name: _____

Your Name: _____ Telephone: _____

Address: _____

We would appreciate your answers to the following questions.

What is your occupation? _____

For what activities will you use this E-mu product?

MUSIC

FILM/VIDEO PROD.

PERSONAL/HOBBY

Composition

Scoring

Performance

Performance

FX/Sound Design

Home Recording

Recording

Just Messing Around

What percentage of your income is derived from music? 100% 50-99% 25-49% 1-24% 0%

Where did you first learn about this E-mu product? _____

What led you to choose this E-mu product? _____

Where will this product be used? Studio Tour Local Venue Home Studio

Church Living Room Other _____

What other equipment are you using with this product (mixer,amp,effects)? _____

If you own a computer, what type? _____

Which of the following magazines do you read?

Keyboard (001) Musician (002) Output (004) Mix (005) Recording Engineer/

Producer (006) DownBeat (009) Electronic Musician (010) Modern Drummer (012)

Studio Sound (014) MCS (015) Music Technology (016) Post (017) Millimeter (018)

Sound on Sound (019) Home Studio Recording (021)

Non-Music/Sound Magazines? _____

What other products would you like to see marketed by E-mu Systems? _____

How would you characterize the service you received from our dealer?

Splendid

Very Good

Fair

Poor

Abysmal

Additional Comments: _____

Please fold this card and return it to us within 10 days of your purchase. Thank you.

Fold Here



NO POSTAGE
NECESSARY IF
MAILED IN THE
UNITED STATES

BUSINESS REPLY MAIL
FIRST CLASS PERMIT NO. 209 SANTA CRUZ, CA

POSTAGE WILL BE PAID BY ADDRESSEE

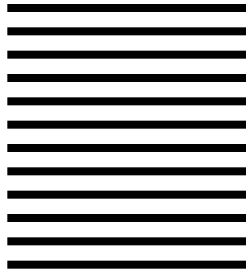

E-mu Systems, Inc.

P.O. BOX 67127

SCOTTS VALLEY, CA 95067-7127

