

**CIT 101XL**  
Video Display Terminal

User's  
Manual



**January 1987  
Revision A**

**CIT101XL  
VIDEO DISPLAY TERMINAL  
USER'S MANUAL**

**C.I.T.O.H**  
CIE Terminals

© 1987

## CIE TERMINALS

All rights reserved. No part of this book may be reproduced in any form by any electronic or mechanical means.

### NOTICE

This equipment generates, uses, and may emit radio frequency energy and if not installed and used in accordance with the instructions in this manual, may cause interference to radio communications. The equipment has been tested and found to comply with the limits for a class A computing device pursuant to Subpart J of Part 15 of FCC rules, which are designed to provide reasonable protection against such interference when operated in a commercial environment. Operation of this equipment in a residential area may cause interference in which case the user, at his own expense, may be required to take measures to correct this interference.

The following are trademarks or equipment designations of CIE Terminals, Irvine, California:

CIT101XL  
CIT-101  
CIT-101e

The following are trademarks or equipment designations of TELEVIDEO SYSTEMS, INC., Sunnyvale, California:

TeleVideo Model 910  
TeleVideo Model 920  
TeleVideo Model 925

The following are trademarks or equipment designations of APPLIED DIGITAL DATA SYSTEMS, INC., New York:

### ADDS VIEWPOINT

The following are trademarks or equipment designations of WYSE TECHNOLOGY,

WYSE-50

The following are trademarks or equipment designations of DIGITAL EQUIPMENT CORPORATION, Maynard, Massachusetts:

VT52  
VT100  
VT101  
VT102

The following are trademarks or equipment designations of HAZELTINE

HZ-1500

# CIE TERMINALS

## TABLE OF CONTENTS

### CHAPTER 1 -- INTRODUCTION

Introduction To Manual .....	1-1
How To Use This Manual .....	1-1

### CHAPTER 2 -- INSTALLATION

Choosing a Place .....	2-1
Location .....	2-1
Lighting .....	2-2
Environment .....	2-2
Power Requirements .....	2-2
Connecting Up the Terminal .....	2-3
Connectors .....	2-3
Connecting the Keyboard .....	2-4
Connecting to a Local Computer .....	2-5
Connecting to a Modem .....	2-6
Connecting to a Printer .....	2-7

### CHAPTER 3 -- OPERATION

Introduction .....	3-1
Starting Up .....	3-2
Screen Display Adjustments .....	3-2
Adjusting the Viewing Angle .....	3-2
Turning on the Power .....	3-3
Are You In the Right Mode? .....	3-4
The Message/Status Line .....	3-4
The ANSI Message/Status Line .....	3-4
The ASCII Message/Status Line .....	3-5
The Function Key Label Line .....	3-5
The Set-Up Field Display .....	3-5
The Keyboard .....	3-6
Categories of Keys .....	3-7
The Alphanumeric Keyboard .....	3-8
Control Keys .....	3-9
Cursor Positioning Keys .....	3-10
Numeric Keypad and Editing Function Keys .....	3-11
Function Keys .....	3-12
Special Purpose Keys .....	3-13
Set-Up Key .....	3-13
Break Key .....	3-14
Line Feed Key .....	3-14

## CHAPTER 3 -- OPERATION (Continued)

Next Page/Prev Page Key .....	3-14
No Scroll Key .....	3-15
Multinational Language Keyboards .....	3-16

## CHAPTER 4 -- THE SET-UP MODE

Introduction to Operating Parameters and the Set-Up Mode .....	4-1
How to Look at and Change Your Operating Parameters .....	4-1
Saving New Set-Up Parameters .....	4-3
Recalling Previously Saved Parameters .....	4-3
Recalling the Factory Default Parameters .....	4-3
Changing Emulation Modes .....	4-4
ASCII Standards, ANSI Standards, and Emulation Modes .....	4-4
Changing the ANSI/ASCII Emulation Modes .....	4-5
Selecting a Sub-Emulation Mode .....	4-5
Set-Up Menus .....	4-5
The ANSI Set-Up Mode .....	4-6
ANSI Set-Up Menus .....	4-6
Initial Set-Up Screen Menu .....	4-6
ANSI COMMS 1 Menu .....	4-6
ANSI COMMS 2 Menu .....	4-8
ANSI DISPLAY 1 Menu .....	4-9
ANSI DISPLAY 2 Menu .....	4-10
ANSI DISPLAY 3 Menu .....	4-11
ANSI DISPLAY 4 Menu .....	4-12
ANSI DISPLAY 5 Menu .....	4-13
ANSI DISPLAY 6 Menu .....	4-14
ANSI KEYBOARD 1 Menu .....	4-15
ANSI KEYBOARD 2 Menu .....	4-16
ANSI KEYBOARD 3 Menu .....	4-17
ANSI AUX 1 Menu .....	4-18
ANSI AUX 2 Menu .....	4-19
ANSI AUX 3 Menu .....	4-19
ANSI AUX 4 Menu .....	4-20
ANSI EMULATION Menu .....	4-21
ANSI TABS Menu .....	4-21
The ASCII Set-Up Mode .....	4-22
Initial Set-Up Screen Menu .....	4-22
ASCII Set-Up Menus .....	4-22
ASCII COMMS 1 Menu .....	4-22
ASCII COMMS 2 Menu .....	4-24
ASCII DISPLAY 1 Menu .....	4-25
ASCII DISPLAY 2 Menu .....	4-26
ASCII DISPLAY 3 Menu .....	4-27
ASCII KEYBOARD Menu 1 .....	4-28
ASCII KEYBOARD Menu 2 .....	4-28
ASCII AUX Menu .....	4-29
ASCII EMULATION Menu .....	4-30
Set-Up Mode Summary .....	4-31

## CIE TERMINALS

### CHAPTER 5 -- PROGRAMMABLE FUNCTION KEYS

Introduction .....	5-1
Function Key Editor .....	5-2
Entering the Function Key Editor .....	5-2
Editing a Function Key Sequence .....	5-3
Function Key Editor Commands .....	5-3
Function Key Label Editor .....	5-5
ANSI Programmable Function Key Controls .....	5-7
Function Keys .....	5-7
Function Key Control Sequences .....	5-7
Programmable Function Key Labels .....	5-10
ASCII Programmable Function Key Controls .....	5-12
Program Function Keys/Function Key Labels .....	5-13

### CHAPTER 6 -- ANSI APPLICATION GUIDE

Introduction to Terminal Control Codes .....	6-1
How Information is Presented in this Chapter .....	6-2
ANSI Keyboard Features and Codes .....	6-3
Keyboard Features .....	6-3
Codes Generated at the Terminal .....	6-4
Cursor Positioning Keys .....	6-6
Numeric Keypad .....	6-7
Auxilliary Port Controls .....	6-8
ANSI Control Sequences .....	6-10
Cursor Control Sequences .....	6-12
Erase Control Sequences .....	6-14
Width/Height Line Commands .....	6-16
Video Attribute Commands .....	6-16
Scroll Control .....	6-17
Tab Controls .....	6-18
Editing Commands .....	6-19
Terminal Mode Controls .....	6-20
Auxiliary Port Control Commands .....	6-27
25th Row Status Line .....	6-30
LED Control .....	6-31
Multiple Page Functions .....	6-32
Reports .....	6-34
Designate Character Set .....	6-37
Screen Alignment .....	6-37
Keyclick .....	6-37
Reset Terminal .....	6-37
VT52 Mode Control Sequences .....	6-38
Cursor Control Sequences .....	6-38
Erase Control Sequences .....	6-38
Graphics Mode .....	6-38
Keypad Application Mode .....	6-39
Bidirectional Auxiliary Port Control .....	6-39
Scroll .....	6-39

**CHAPTER 6 -- ANSI APPLICATION GUIDE (Continued)**

ANSI Mode .....	6-39
Request Identity .....	6-39

**CHAPTER 7 -- ASCII APPLICATION GUIDE**

Introduction .....	7-1
How Information is Presented in This Chapter .....	7-2
ASCII Keyboard Features and Codes .....	7-3
Keyboard Features .....	7-3
ASCII Control Code Generation .....	7-3
Control Codes Generated by Keyboard Function Keys .....	7-5
Control Keys .....	7-5
Cursor Position Keys .....	7-7
Editing Keys .....	7-10
Special Purpose Keys .....	7-13
Terminal Control Sequences .....	7-15
Operating Mode Controls .....	7-15
Communication Modes .....	7-15
Terminal Operating Submodes .....	7-18
Display Control .....	7-24
Split Screen Format Controls .....	7-24
Activate Text Segment .....	7-25
Move Cursor To Specific Text Segment .....	7-26
Select Screen Features .....	7-26
Character Display Attributes .....	7-28
Additional Attribute Controls .....	7-30
Tab and Carriage Controls .....	7-32
Cursor Control .....	7-34
Row/Column Codes .....	7-38
Clear Screen Controls .....	7-41
Editing Controls .....	7-45
Delete Controls .....	7-45
Insert Controls .....	7-45
Terminal Control .....	7-47
Transmission to Host .....	7-49
Printer Controls .....	7-53

**APPENDIXES**

Appendix A - SPECIFICATIONS
Appendix B - INTERFACE CIRCUITS
Appendix C - ASCII CODE CHART
Appendix D - ASCII MODE KEYBOARD GENERATED CODES
Appendix E - ASCII CONTROL CODE SUMMARY
Appendix F - ANSI CONTROL CODES AND CONTROL SEQUENCES
Appendix G - SET-UP MODE PARAMETERS
Appendix H - SELF-TEST MODE

# **CHAPTER 1 -- INTRODUCTION**

---

## **INTRODUCTION TO MANUAL**

The CIT101XL combines ease of use, a full-featured ANSI and ASCII command set, and a variety of display attributes into one inexpensive package.

Designed for ease of operation, the CIT101XL features a detached keyboard and a monitor with a tilt and swivel base. The screen angle can be adjusted for fatigue-free viewing. The keyboard includes a full set of editing and control keys and 16 programmable function keys.

Two separate emulation modes are available for two types of terminals. The first mode (the ANSI mode) emulates the CIE TERMINALS CIT-101e ANSI terminal. The CIT-101 ANSI mode includes DEC VT100 and VT52 sub-emulations.

In the ANSI emulation mode, up to four complete screens can be stored in the terminals memory. Screen width can be either a standard 80 columns or a wide 132 columns. Displayed text can be enhanced with a variety of special effects: underlining, reduced intensity, blinking, double high, double wide, and special graphics characters.

The second mode (the ASCII mode) emulates the WYSE 50 ASCII-type terminal. The WYSE 50 ASCII mode has sub-emulation modes for the ADM 31 (which is the WYSE 50's native mode), the TVI 910, TVI 920, TVI 925, ADDS Viewpoint, and the Hazeltine 1500.

Standard interfaces include an RS-232C communications port and an auxiliary RS-232C printer port. An optional RS-422 communications port is available. You will find complete specifications for the terminal in Appendix A.

### **HOW TO USE THIS MANUAL**

This manual is organized into seven chapters with each chapter divided into sections. The seven chapters are:

- Chapter 1 - INTRODUCTION**
- Chapter 2 - INSTALLATION**
- Chapter 3 - OPERATION**
- Chapter 4 - THE SET-UP MODE**
- Chapter 5 - PROGRAMMABLE FUNCTION KEYS**
- Chapter 6 - ANSI APPLICATION GUIDE**
- Chapter 7 - ASCII APPLICATION GUIDE**



## INTRODUCTION

In this chapter, INTRODUCTION, the manual is described and a general description of the terminal is provided.

In the second chapter, INSTALLATION, you will find all the information you need to unpack, locate, and connect the terminal. This chapter is intended for the person who will be installing the terminal.

The third chapter, OPERATION, is intended as an operating guide to the terminal. It contains a description of the terminal controls, indicators and keyboard. This chapter will serve as guide to first time users of the terminal. Also contained in this chapter is a general description of the terminal Set-Up mode.

The Set-Up mode is described in detail in Chapter 4. The description covers both the ASCII and ANSI emulation modes.

Chapter 5, PROGRAMMABLE FUNCTION KEYS, contains a full description of the programmable key feature of the terminal. In this description procedures are included for programming and accessing the keys from the keyboard or by the host. These procedures cover both the ASCII and ANSI terminal emulations.

The last two chapters are application guides for ANSI and ASCII terminal emulation modes. In these sections descriptions of the keyboard features and programming functions available in each of the emulation modes are provided.

If you are a first time user or are installing the terminal you should read and become familiar with the first three chapters of the manual. The information contained is intended to familiarize the user and to help install the terminal.

Chapters 4 through 7 are intended for users who will be programming their systems or tailoring their application programs for the CIT101XL terminal. The information contained in the chapters is presented in a form and language that is familiar to programmers and systems designers.

Included at the end of each chapter is a summary of the information presented in the chapter. As part of this manual you also received a quick reference guide to the terminal.

There are several appendixes at the end of the manual which contain code charts, specifications, and other technical information regarding the terminal interfaces. A subject index is the last part of this manual.

## CHAPTER 2 -- INSTALLATION

### CHOOSING A PLACE

#### Location

Choose an ample work space at a comfortable height for typing. For most people, the best place to work is a clear, level table or desk top about 26 inches (650 cm) high. The terminal itself occupies an area of 21 by 17 inches, including the keyboard. Figure 2-1 shows the overall dimensions of the terminal.

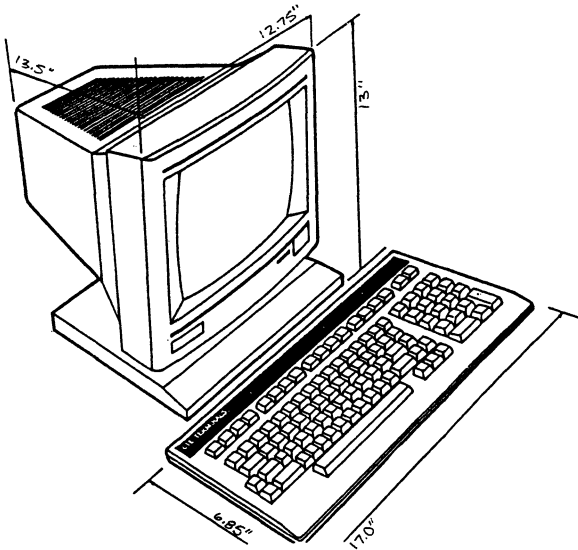

Figure 2-2. Dimensions of the CIT101XL Video Terminal

Allow a clear area of 4 to 6 inches (10 to 13 cm) at the back of the terminal for the power and interface cables. Maintain a clear area at least 3 inches (7.5 cm) wide on both sides and 4 inches above the top for air circulation necessary to keep the terminal cool. Be sure to provide plenty of work space beside the terminal as well.

## **INSTALLATION**

### **Lighting**

Arrange the lighting in the terminal area so that there is no glare reflected from the screen. Avoid furniture arrangements that allow sunlight to fall on the display screen. Ideally, you should be able to adjust the intensity of the nearby light, by a dimmer or other means, for each work station.

### **Environment**

For most reliable performance, the terminal should be operated within a range of temperature and humidity that is reasonably comfortable for people. The temperature can range from 50 degrees F to 100 degrees F (10 degrees to 38 degrees C). The relative humidity should not be higher than 90 percent.

At relative humidities below about 35 percent, static electricity may be a problem. Static electricity discharges can be harmful to the terminal. Your computer supplies dealer can provide a carpet spray that reduces static electricity. Static-reduction mats and grounding devices are also available.

### **Power Requirements**

The terminal comes with a six-foot power cord. Locate the terminal within a few feet of a 115-volt 15 ampere AC power receptacle with an integral ground connection. If a grounded receptacle is not available, a new one should be installed. Do not attempt to operate the terminal with the ground connection broken.

**NOTE:** Some microcomputers require that you turn the terminal and the computer on and off simultaneously. In such cases, leave the power switch on the terminal turned ON, and connect the power cord to a switched receptacle that also supplies power to the computer. If you are using the terminal with a microcomputer, check your computer's operating instructions to determine if this is required.

**CONNECTING UP THE TERMINAL**

The terminal is packaged in two separate assemblies. The display unit houses the display tube, the power supply, the display controls, and the power, interface and keyboard connectors.

**Connectors**

Take a few moments to look at the terminal. Figure 2-2 shows a back view of the display unit. The connector marked "COMM" is the point at which the terminal connects to the host computer. If your terminal will be connected to the host computer through a telephone line, you will connect a modem to that connector. If your terminal will be connected to the host via direct wiring, you will connect the cable from the computer to that connector.

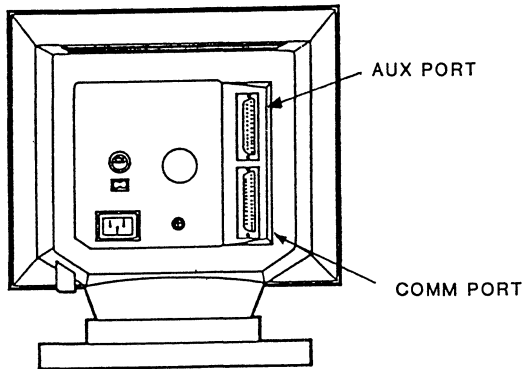

**Figure 2-2. Back View of the Display Unit**

The printer connector (marked "AUX") may be used to connect a serial printer to the terminal. Once connected, the printer may be used to print the data currently displayed on the screen, or to print the data stream from the host computer.

## INSTALLATION

### Connecting the Keyboard

Figure 2-3 shows the keyboard unit. The keyboard comes with a coiled cord attached. The cord plugs into the keyboard connector on the right side of the display unit. The functions of the special keys on the keyboard are described in Chapter 2 and also in the application chapters for the ANSI and ASCII operating modes.

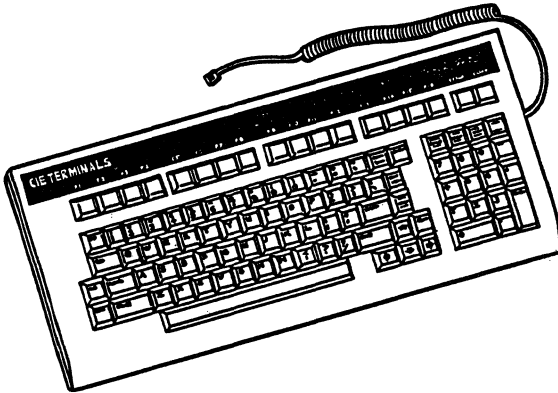
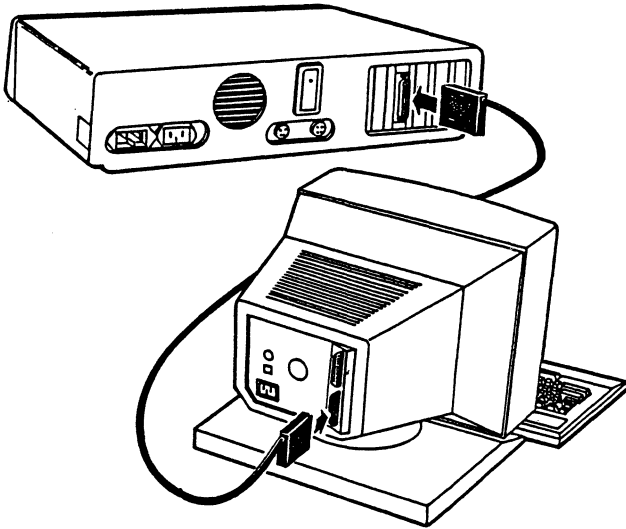

Figure 2-3. The CIT101XL Keyboard.

**Connecting to a Local Computer**

Figure 2-4 shows how to connect the terminal to a local computer. You can use either of two interface methods: a standard RS-232 interface or an optional RS-422 interface. Refer to Appendix B for the pin assignments for the COMM connector.



**Figure 2-4. Connecting to a Local Computer**

## INSTALLATION

### Connecting to a Modem

How you connect the terminal to a modem depends on the type of modem in use. If your modem has a terminal connector on it, you will need a cable. Refer to Appendix B for the pin assignments for the COMM connector. Figure 2-5 shows how to connect the terminal to a modem.

Some of the newer modems come with a cable attached. The cable may have a female connector installed. If so, it will be necessary to install a gender changer between the modem and the terminal. You can purchase cables and gender changers from any well-stocked computer supply store.

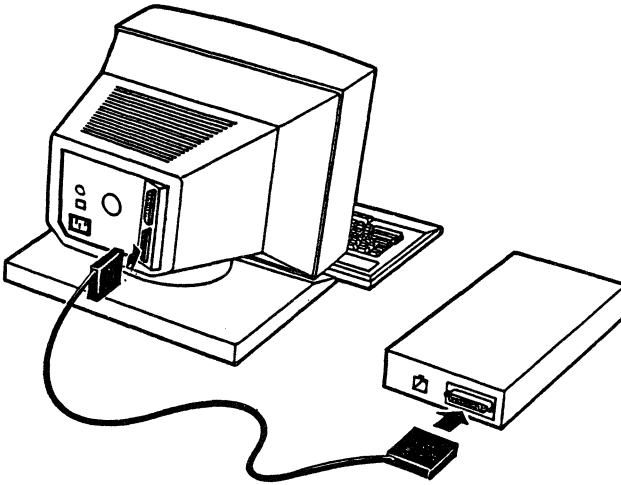

Figure 2-5. Connecting to a Modem

## INSTALLATION

### Connecting to a Printer

Figure 2-6 shows how to connect the terminal to a printer. You will need a cable with at least 3 conductors. If your printer uses DTR Busy/Ready data flow control, use an 8-wire cable with pins 1 through 7 and pin 20 connected directly between the printer and the terminal. Both types of cables are readily available from computer supply stores.

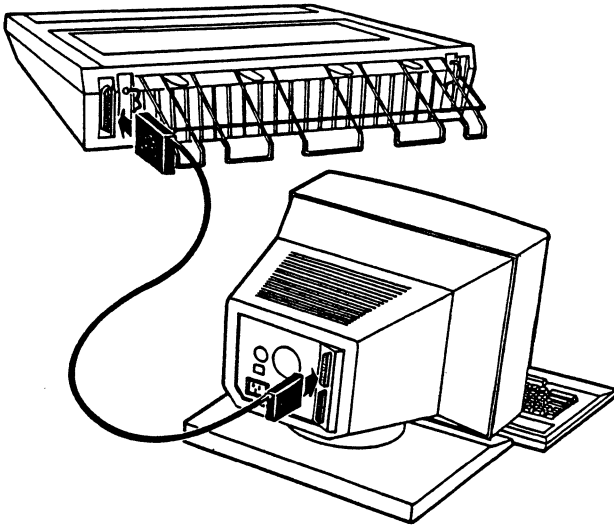

Figure 2-6. Connecting to a Printer





## **CHAPTER 3 -- OPERATION**

---

### **INTRODUCTION**

This chapter of the manual contains a general description of the operation of the CIT101XL terminal. The basic controls and operating modes of the terminal, including the message/status line, are described.

Included in this section is a description of functions and features available from the keyboard. Also the various multinational keyboard layouts are described in this section.

The programmable key feature of the terminal is covered in Chapter 5.

Refer to Chapter 4, **THE SET-UP MODE**, for a description of how to set up the terminal for your particular application.

## OPERATION

### STARTING UP

#### Screen Display Adjustments

The **CONTRAST** and **BRIGHTNESS** controls for the terminal are located on the right side of the display unit, as shown in Figure 3-1. You may adjust the display contrast and brightness for comfortable viewing in keeping with the amount of ambient light on the screen. The **ON/OFF** switch is on the front of the display unit. All of the terminal's optional operating features may be selected and controlled from the keyboard, using the terminal's set-up feature.

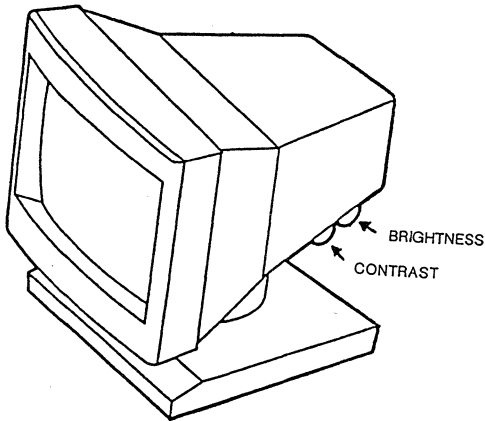

Figure 3-1. Contrast and Brightness Controls

#### Adjusting The Viewing Angle

You can adjust the angle of the screen by grasping the display unit firmly and pushing it to the position you want. Set the viewing angle so that no glare is reflected from the screen. You can minimize eyestrain by positioning the display unit so the screen and the keyboard are about the same distance from you eyes.

**TURNING ON THE POWER**

Turn on the power switch. After a few moments, the power-on display will appear. The message "CIT101XL OK" will appear on the screen. Strike any key. What you see depends upon how the terminal has been set up. If this is the first time that the power has been turned on, the terminal will be in its ANSI mode and a display which looks like Figure 3-2 will appear on the screen. If your terminal has been set up for the ASCII emulation mode, the display will look like Figure 3-3. If the operating parameters of the terminal have been altered, information displayed in either screen may differ.

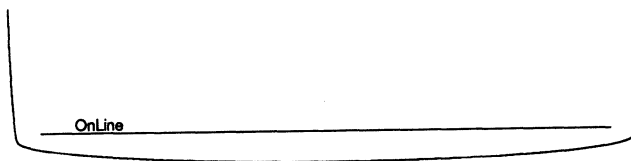

**Figure 3-2. ANSI Emulation Mode Screen Display**

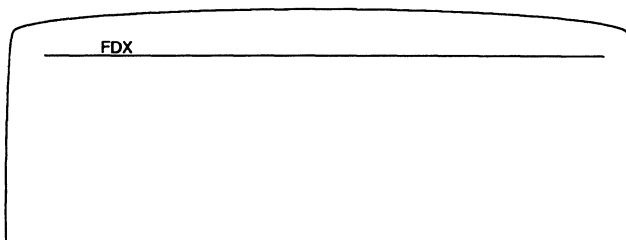

**Figure 3-3. ASCII Emulation Mode Screen Display**

## **OPERATION**

### **ARE YOU IN THE RIGHT MODE?**

The first time you turn on the power, the terminal will be in its ANSI emulation mode. The screen will be as shown in Figure 3-2, and the terminal will work the same as the CIT101E does in its native mode (which is an emulation of the DEC VT100 SERIES TERMINAL).

This may or may not be the right mode for you. Depending upon your application, you may need the terminal to function like the WYSE 50 ASCII-type terminal the CIT101XL emulates. If this is the case, you will have to change the emulation mode. Refer to the "How to Look at and Change Your Operating Parameters" and "Changing Emulation Modes" sections in Chapter 4.

### **THE MESSAGE/STATUS LINE**

The line where the words are displayed is called the Message/Status line. It appears at the top of the screen in the native ASCII operating mode, and near the bottom of the screen (line 25) in the ANSI emulation mode. The Message/Status line may be turned on or off (displayed or hidden) from the keyboard (using the Set-Up mode) or by the host computer (using control codes). When it is visible, the Message/Status line displays information about the terminal's operating status.

#### **The ANSI Message/Status Line**

The ANSI standard assumes that the terminal has four indicator lamps visible to the operator. When a lamp is "on," its designator (L1, L2, L3 or L4) is displayed on the status line. When it is "off," that portion of the line is blank.

The word CAPS is displayed when the caps lock is on. If the terminal is in the local mode, the word LOCAL appears on the status line. When the keyboard is locked, the word LOCKED is displayed.

The Message/Status Line can be selected as a 25th data line in Set-Up mode. When selected as a data line, only screen data will appear. The Message/Status feature is disabled and messages and status information will not be displayed.

### The ASCII Message/Status Line

In the ASCII mode, only the left portion of the line is used for status information. The host computer can use the rest of the line to display messages to the operator, without disturbing the operation of the program in use. The status line displays the communications mode: HDX for half duplex, FDX for full duplex, and BLK for the block mode. If the monitor mode is on, an asterisk is placed next to the FDX, HDX, or BLK indicators.

When the caps lock key has been pressed, the word CAPS indicates that the terminal is in the caps mode. If the keyboard is locked, LOCK is displayed in the status line. PROT indicates that the write protect mode is on; WPRT indicates that the next character written will be protected. INS indicates that the insert mode has been turned on.

### THE FUNCTION KEY LABEL LINE

The bottom line, (line 26) has two uses. When you are connected to the host computer, the program you are using may send function key identification labels from the host to the terminal. These labels will be displayed on the bottom line. Function key labels are optional, so the line may be blank in normal operation.

### THE SET-UP FIELD DISPLAY

When you select the Set-Up mode, the terminal's set-up parameters appear on the bottom line of the display. The Set-Up mode is explained in detail in Chapter 4.

## OPERATION

### THE KEYBOARD

The CIT101XL keyboard is a versatile keyboard that is suited for many applications. The keyboard, refer to Figure 3-4, consists of a standard typewriter alphanumeric key layout with additional terminal control keys and a separate numeric keypad. There are an additional 16 keys located in a row at the top of the keyboard that can be tailored to your application programs.

In normal operation, most of the keys on the keyboard do not directly affect the display; they send data only to the host computer via the COMM port. The terminal control keys do not send data anywhere, but control the internal operation of the terminal or modify the codes generated by other keys.

The different categories of keys are described on the next page. In subsequent sections of this chapter the various terminal functions and features available from the keyboard are described in greater detail.

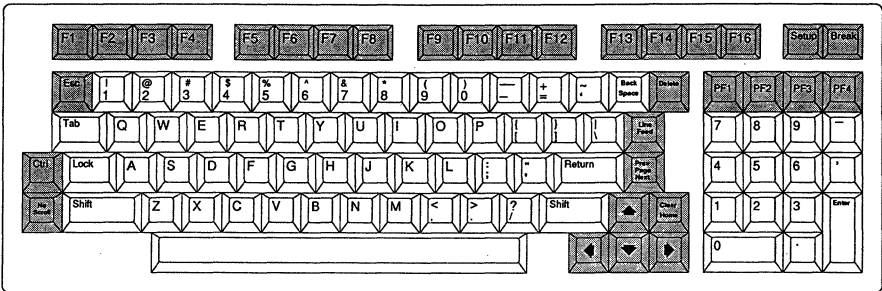

Figure 3-4. The CIT101XL Keyboard

## CATEGORIES OF KEYS

Because of differences in their purpose or function, we will divide the keys on your keyboard into six categories. See figures 3-5 through 3-10.

First, there is the alphanumeric keyboard: the part of the keyboard that looks like a typewriter keyboard. The alphanumeric keyboard includes the complete alphabet, along with numbers, punctuation marks, the space bar, and other symbols.

Second, there are the control keys. Some of these are familiar from the typewriter: **TAB**, **BACKSPACE** and **RETURN**. Three keys that do not appear on most typewriters are **CTRL**, **DELETE** and **ESC**.

Third is a group of keys that control the position of the cursor. The cursor indicates the active position on the display screen. The cursor control keys include the up, down, right and left arrows, and the **CLEAR HOME** key.

Fourth, there is a group of keys to the right of the alphanumeric keyboard, called the numeric keypad. The numeric keypad includes the numbers 0 through 9, the minus sign (hyphen), the comma, the decimal point (period) and an **ENTER** key.

The four function keys across the top of the numeric keypad (PF1, PF2, PF3, PF4) are used as Printer Function keys to control the auxiliary and COMM port. In the ANSI mode, when the HEX Keypad option is used, the editing function keys serve as hexadecimal number keys. In the ASCII mode the keys can be used as editing function keys.

Fifth are the function keys. There are sixteen programmable function keys across the top of the keyboard. These keys can be programmed to transmit application program codes. Refer Chapter 5 for a description of how to use these keys. There is also a description of how to program these keys from the keyboard in Chapter 5 under the **FUNCTION KEY EDITOR** description.

In the sixth category are the various special purpose keys which are used to control or access the features of the terminal. These include the **SET-UP**, **BREAK**, **LINE FEED**, **NEXT PAGE/PREV PAGE**, and **NO SCROLL** keys. The four PF keys across the top of the numeric keypad could also be included in this category.



## OPERATION

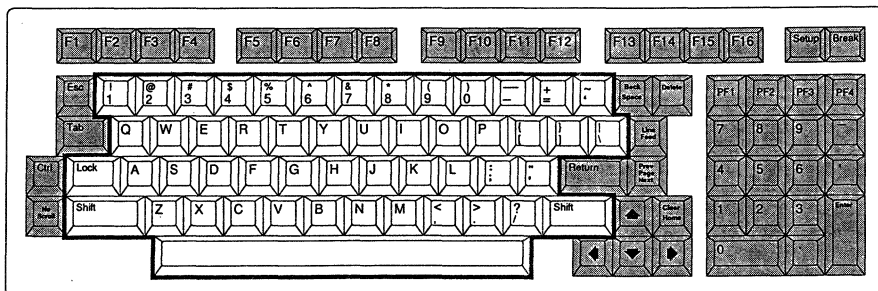

Figure 3-5. Alphanumeric Keys

### The Alphanumeric Keyboard

These keys behave much the same as typewriter keys. There are two important differences. First, the **LOCK** key is not like the typewriter shift lock: it locks only the letters of the alphabet. For example, you must use the shift key to type the symbols at the tops of the number keys.

The second difference is that the alphabetic keys along with some of the symbol keys can be used with the **CTRL** key to generate invisible (non-displayed) characters that are used to control the computer or the terminal. Some of the **CTRL** combinations produce the same effect as the control keys below. For example, **<CTRL-I>** is the same as **TAB**. Refer to the appropriate emulation mode application chapter for a description and listing of the control codes that can be produced from the keyboard.

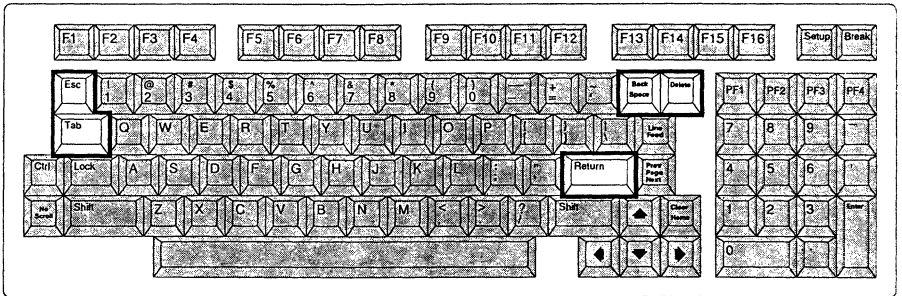

Figure 3-6. Control Keys

### Control Keys

The control keys are RETURN, TAB, BACKSPACE, CTRL, DELETE and ESC. The first three are similar to the equivalent typewriter keys. They are introduced separately here because they produce invisible (non-displayed) control codes, and these are an important category of keys for programmers.

The CTRL key is used to modify the codes generated by other keys. The ESC key generates an escape control code. This control code is used to introduce sequences or code strings in certain applications. A backtab function is available by using a <SHIFT-TAB> key sequence in the ANSI terminal mode.

## OPERATION

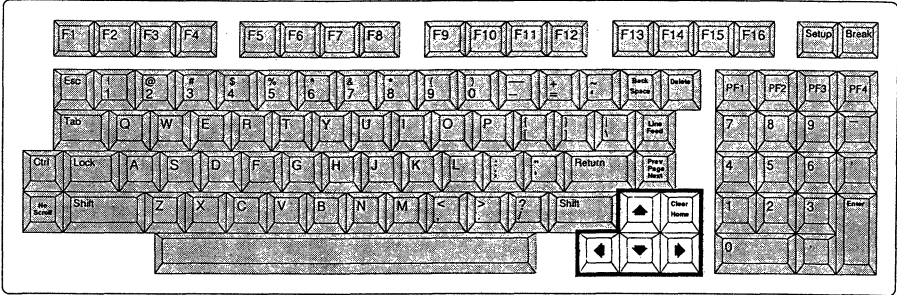

Figure 3-7. Cursor Positioning Keys

### Cursor Positioning Keys

These keys allow you to move the cursor about the screen. When you use the keyboard to make any change on the display, the change nearly always takes place at the cursor location. Pressing the **CLEAR HOME** key moves the cursor to the upper left corner of the screen, or, if you are using a split screen display in the ASCII mode, to the upper left of the active segment of the screen.

The **↑** (up arrow) and **↓** (down arrow) keys can also be used with the **CTRL** and **SHIFT** keys to control the smooth scroll rate. Pressing **<CTRL-SHIFT-↑>** increases the smooth scroll rate until the terminal is placed into jump scroll mode. Pressing **<CTRL-SHIFT-↓>** decreases the smooth scroll rate until the terminal reaches the slowest smooth scroll rate. This feature is valid in either ANSI or ASCII terminal modes.

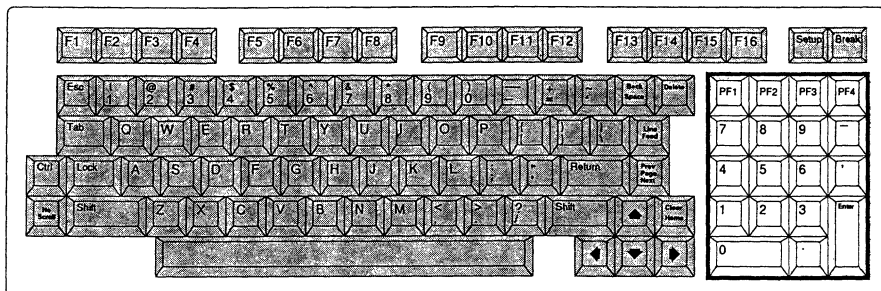

Figure 3-8. Numeric Keypad

### Numeric Keypad and Editing Function Keys

The numeric keypad makes it convenient to enter a large amount of numerical data. It may be used to enter either decimal or hexadecimal numbers. A comma, period and hyphen are provided so you can enter large numbers, decimals or negative numbers without having to lift your hand from the keypad.

The four special function keys across the top of the numeric keypad are the PF1, PF2, PF3, and PF4 printer function keys. When used in conjunction with the CTRL and SHIFT keys, PF1 through PF4 are used to control the auxiliary port in the ANSI mode. Refer to the following Printer Function Controls section.

In the ASCII emulation mode these keys are used as the CHAR INSERT/LINE INSERT, CHAR DELETE/LINE DELETE, LINE CLEAR/SCREEN CLEAR and REPL/INSERT keys. Each key has two functions: one when unshifted and another when shifted. These keys are used mainly for word processing or other editing tasks.

In the ANSI emulation mode, there is a Hex Keypad Numeric option, software selectable, that converts the PF keys to hexadecimal A through D. When this option is in use, the minus sign and the comma become E and F, respectively.

In ASCII mode the ENTER key can be used with the SHIFT or CTRL-SHIFT keys to toggle the audible keyclick feature on and off. Also in ASCII mode, the monitor mode feature may be toggled on or off with the key sequence <CTRL-SHIFT-1>. However only the <1> key on the numeric keypad can be used in this key sequence.

## OPERATION

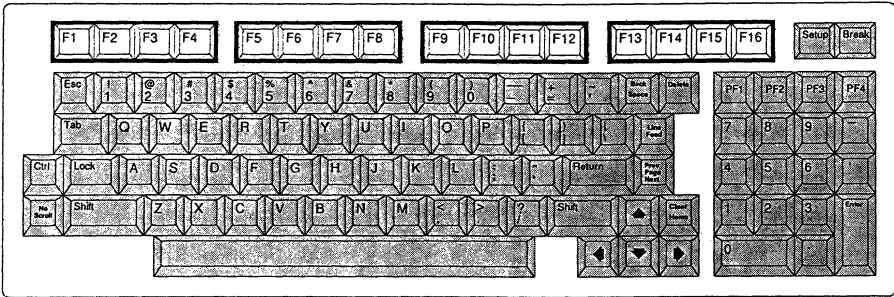

Figure 3-9. Function Keys

### Function Keys

The sixteen programmable function keys are used with the **SHIFT** key to produce 32 distinct codes. Function keys are usually assigned a function by the program that is running on the host computer. The host may change the function of any key at any time. The operator may reprogram the function keys from the keyboard, using the Set-Up mode. Function key sequences are stored in nonvolatile memory, so they are not lost if power to the terminal is turned off.

The function keys may be labeled with legends up to 8 characters long on an 80 column display, or 7 characters long for the 132 column display. The legends are displayed on the bottom (26th) line of the display. Function key legends are stored in the terminal's volatile memory; they must be reentered after any interruption of power to the terminal.

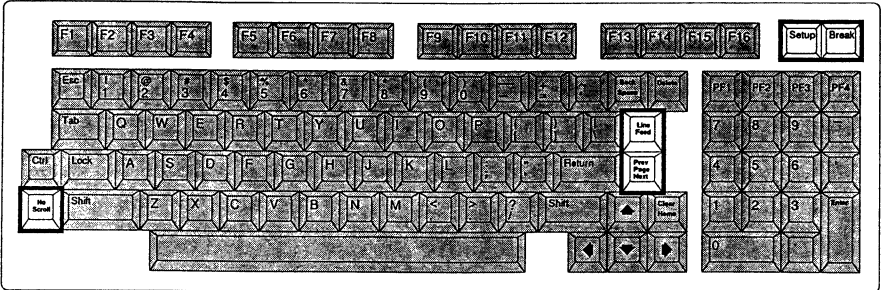

Figure 3-10. Special Purpose Keys.

### Special Purpose Keys

#### ► Set-Up Key

Pressing <SHIFT-SET-UP> puts the terminal in the Set-Up mode. In this mode, you may make choices from the keyboard that modify the way the terminal works internally, or how the terminal communicates with the host computer, or with the printer, if one is used. The Set-Up mode is explained in Chapter 3.

The Set-Up key can also be used in the ASCII terminal mode to unlock the keyboard and to disable the AUX printer port. It will also turn off the transparent print mode. Refer to Chapter 6 under the corresponding control function descriptions.

## OPERATION

### ► Break Key

The BREAK key sends a special signal to the COMM connector that is not a character code at all, but a brief interruption of transmission. This signal may be received and acted upon by the host or by the communication equipment between the terminal and the host.

In the ANSI terminal mode the answerback message is also sent to the host when this key is pressed.

In the ASCII terminal mode, the key sequence <CTRL-SHIFT-BREAK> or <SHIFT-BREAK> places the terminal in BLK (block) mode of communication.

### ► Line Feed Key

In the ANSI mode this key generates a line feed code to the host. When the terminal receives a line feed code the cursor moves down to the next line while maintaining the current column position.

In the ASCII terminal mode this key sends the data currently displayed on the screen to the AUX (printer) port on the back of the terminal. If a printer is connected, the screen contents will be printed.

The key can also be used with the SHIFT and CTRL, in the ASCII terminal mode to control the AUX port. The key sequence <CTRL-SHIFT-LINE FEED> will toggle the port on and off. This key sequence will also disable the transparent print mode.

### ► Next Page/Prev Page Key

In the ANSI mode this key is used to display the next and the previous pages of the multiple page feature. When pressed, the screen will display the next page of the multiple screen memory and home the cursor. When pressed with the SHIFT key, the previous page will be displayed and the cursor will be at the home position.

This key is used in the ASCII terminal mode to move the cursor between screen segments when the split screen feature is enabled. The segment where the cursor is located becomes the active segment.

### ► No Scroll Key

The No Scroll key is used in the Set-Up mode to program one or more of the function key labels.

Outside of Set-Up mode, in the ANSI emulation mode, the function of the key is determined by the VT52/VT100-style mode (refer to Chapter 6). In VT52-style mode, a line of data is added to the bottom of the screen when the key is pressed. When pressed with the SHIFT key a full page of data scrolls onto the screen. In VT100-style mode an XOFF code will be generated when the key is pressed and an XON code when pressed a second time.

In the ASCII emulation mode, pressing this key in conjunction with one of the alphanumeric keys causes the code that is normally sent to be modified. Instead of transmitting the normal alphanumeric code, it is sent the form SOH <char> CR. For a complete description of this key function refer to Chapter 5, PROGRAMMABLE FUNCTION KEYS.



## OPERATION

### MULTINATIONAL LANGUAGE KEYBOARDS

In addition to the standard US ASCII alphanumeric keyboard, eleven multinational language keyboards are also available. When selected in Set-Up mode, these keyboard layouts will allow you to generate a variety of foreign language characters on your display screen. Chapter 4 explains how to change your keyboard language in the sections "How to Look at and Change Your Operating Parameters" and "Set-Up Menus: Emulation Menus."

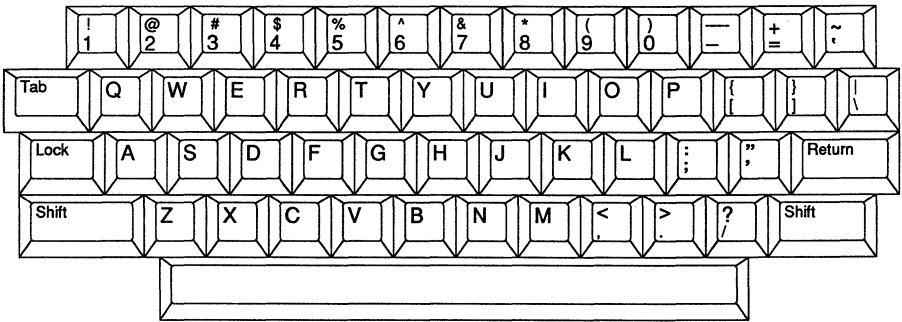

Figure 3-11. US ASCII Keyboard

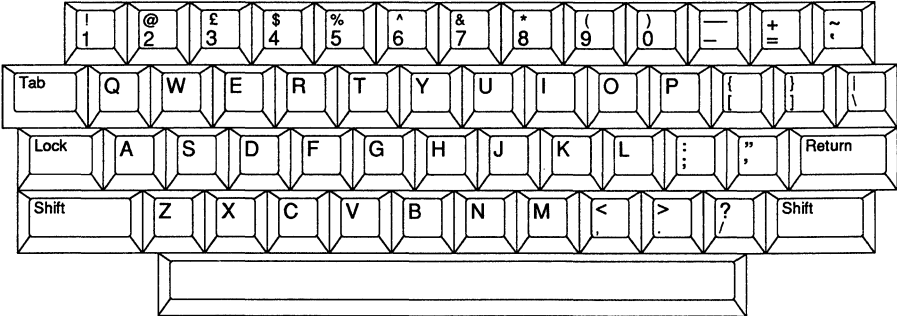
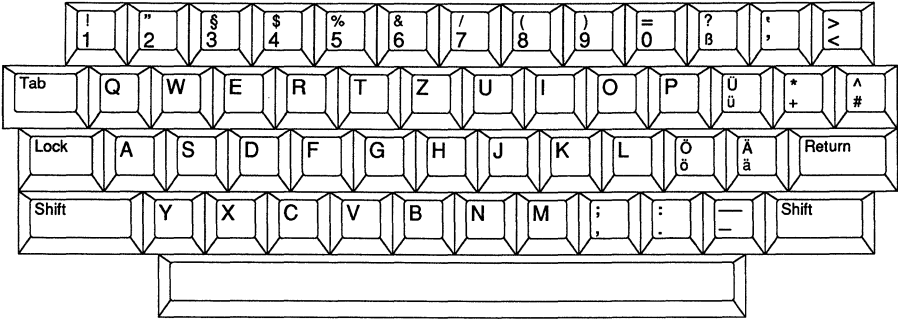

Figure 3-12. British/UK Keyboard

**OPERATION**



**Figure 3-13. German Keyboard**

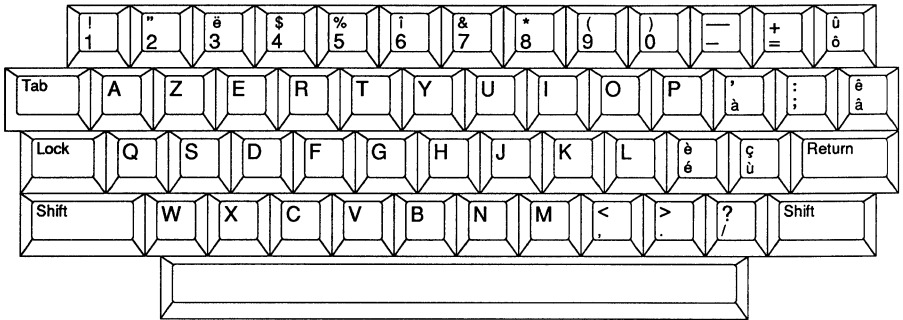
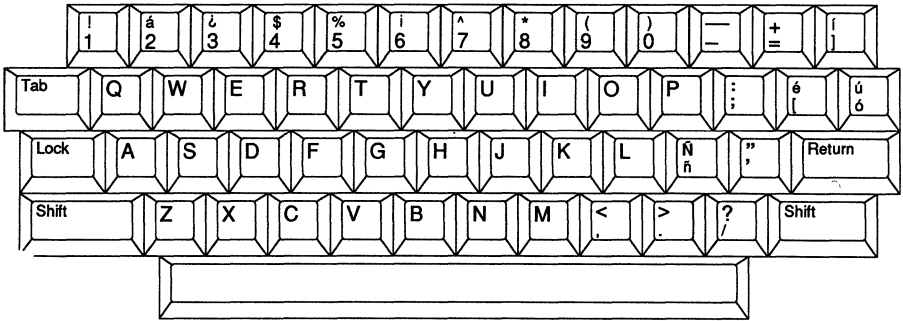
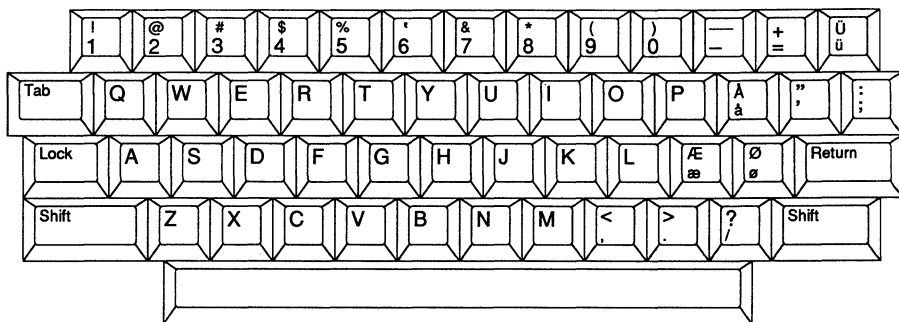

Figure 3-14. French Keyboard

**OPERATION**

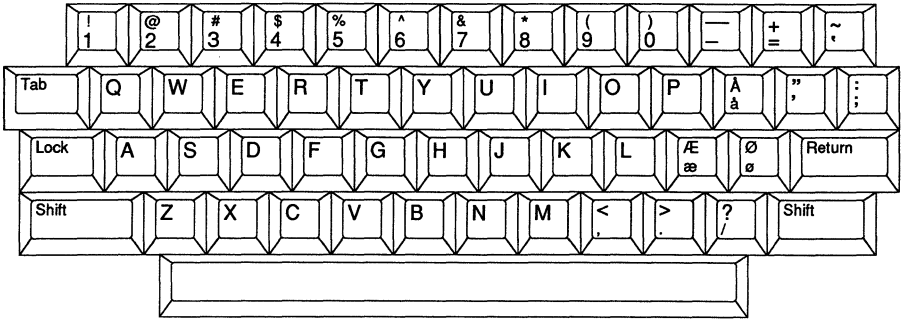

**Figure 3-15. Spanish Keyboard**



**Figure 3-16. Danish Keyboard**

**OPERATION**



**Figure 3-17. Norwegian Keyboard**

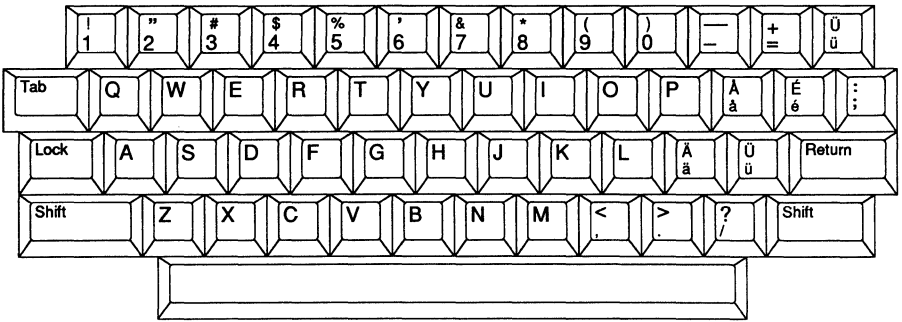

Figure 3-18. Swed/Fin E47 Keyboard



# OPERATION

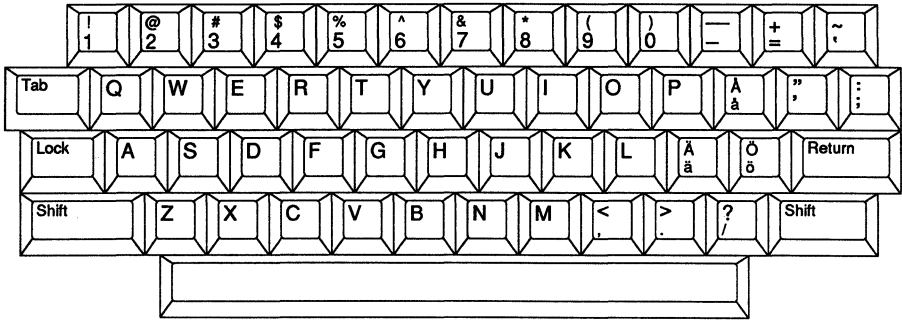

Figure 3-19. Swed/Fin D47 Keyboard

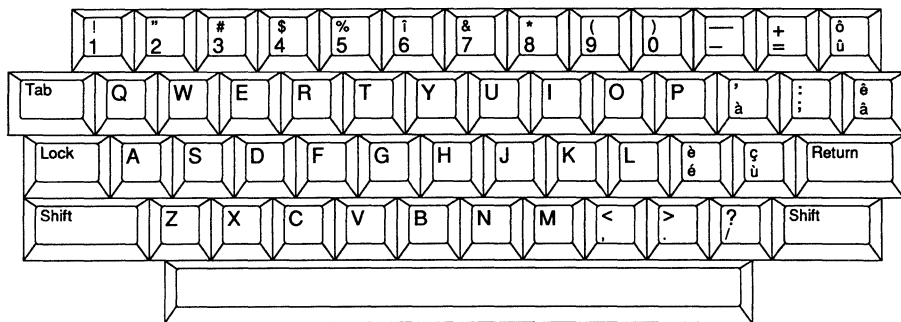

Figure 3-20. French/Canadian Keyboard



## CHAPTER 4 -- THE SET-UP MODE

---

### INTRODUCTION TO OPERATING PARAMETERS AND THE SET-UP MODE

The term "operating parameters" includes a wide variety of characteristics that you may need to change to meet changing procedures, to accommodate new software, or to work with different data communication equipment. A number of operating parameters are intended to be tailored to your comfort and convenience when using the terminal. The CTT101XL allows you to change or set these parameters in the Set-Up mode.

An example is the audible key click. The terminal makes an electronic click each time you press a key. Many people, particularly those accustomed to using a typewriter, find the sound reassuring, because the click means that an electrical contact has occurred. Others find the sound distracting and turn the key click off.

Another example is the margin alarm that sounds when the cursor reaches column 72. Since many programs automatically word wrap when you fill a line, you may not need this feature. You can turn the margin alarm off, if you wish, using one of the parameters in the Set-Up mode.

Set-Up parameters range from these everyday conveniences to technical characteristics that control the terminal's communication with the host and the printer, if you are using one. In this chapter, we will discuss the Set-Up parameters that you will find most useful. A complete list of all of the parameters is presented in the following sections.

#### How to Look at and Change Your Operating Parameters

To examine or change your terminal's operating parameters, press the <SET-UP> key while holding down the <SHIFT> key. A Set-Up menu line like that shown in Figure 4-1 will appear at the bottom (line 26) of your display screen if the terminal is in the ANSI mode. If your terminal is in the ASCII mode, the menu line in Figure 4-2 will appear. The words to the left of the colon indicate whether the terminal is in the ANSI or ASCII emulation mode. The words to the right of the colon are categories of Set-Up menus. Notice that the word "Comms" is brighter than the rest.

To choose the Display menu, press the left arrow key and then the space bar. To choose another, press the left or right arrow keys until the desired menu name is brightest, then press the space bar or the <ENTER> key. If you wish to return to the initial Set-Up menu line to see the Set-Up menu categories, press <SETUP>.

The display menu enable you to adjust certain characteristics of your terminal to fit your personal preferences. Figure 4-3 shows the display menu for the ASCII emulation mode. This figure shows only one possible combination of menu choices. While the parameters will be the same, your Set-Up display will most likely show different choices.

## THE SET-UP MODE

Emulation Mode ANSI| Comms | Display | Keyboard | Aux | Emulation | Tabs

Figure 4-1. Set-Up Menus Line for the ANSI Emulation Mode

Emulation Mode ASCII| Comms | Display | Keyboard | Aux | Emulation

Figure 4-2. Set-Up Menus Line for the ASCII Emulation Mode

DISPLAY 1: | Screen 80 | Freq 60Hz | Cursor Blinking Block

ASCII Display Menu 1

DISPLAY 2: | Auto Scroll On | Scroll Jump | Protect Dim | CRT Saver 60

ASCII Display 2 Menu

Figure 4-3. Set-Up Lines for the ASCII Display Menus

To switch among the available choices for the current parameter, press the space bar. To inspect the operating parameter to the right, press the right arrow; for the parameter to the left, use the left arrow. When the desired parameter is highlighted, press the space bar or the <ENTER> key to make your choice. To inspect the next Set-Up menu, press the down arrow; use the up arrow for the previous menu.

Note that movement in the Set-Up mode **wraps**. If the last menu, parameter, or choice is selected, pressing the right arrow key will move (wrap) to the first. If the first menu, parameter, or choice is selected, pressing the left arrow key will wrap to the last.

Take a few minutes to look through the available choices in the display and features menus. You will seldom, if ever, need to use the printer and communications menus.

## THE SET-UP MODE

### Saving New Set-Up Parameters

If you make changes and exit the Set-Up mode, the changes will be in effect until power to the terminal is turned off. If you want the changes you have just made to be permanent, type <CTRL-S> before leaving the Set-Up mode. The changes that are saved will be called up next time the terminal is turned on or if they are recalled in Set-Up mode (as explained below).

### Recalling Previously Saved Parameters

If you want to recall previously saved settings (as explained above) see the above paragraph, type <CTRL-R>. All changes which you have made will be erased and the parameters last saved with a <CTRL-S> will be recalled. If you leave the Set-Up mode without making further changes, these saved settings will be in effect.

### Recalling the Factory Default Parameters

To recall the factory default settings, type <CTRL-D> while in the Set-Up mode. When you leave Set-Up mode, these defaults will be in effect. Unless you explicitly save these defaults by typing <CTRL-S>, these defaults will be erased when the terminal is turned off.

The functions of all the keys used in Set-Up mode are summarized in the following table.

<u>Action</u>	<u>Key</u>
Switch among choices	Space bar or <ENTER>
Select parameter to the right	Right arrow
Select parameter to the left	Left arrow
Next menu	Down arrow
Previous menu	Up arrow
Save current parameter choice	<CTRL-S>
Read saved parameters	<CTRL-R>
Read default parameters	<CTRL-D>
Toggle Set-Up Mode	<SHIFT-SETUP>
Return to initial menus line	<SETUP>

To leave the Set-Up mode, press <SHIFT-SETUP>.

## THE SET-UP MODE

### CHANGING EMULATION MODES

#### ANSI Standards, ASCII Standards, and Emulation Modes

Many of the operating features of modern terminals can be controlled remotely by the host computer. The host sends a special character, or sequence of characters, to the terminal to perform such functions as positioning the cursor, inserting characters or lines, and erasing all or part of the screen.

Partial standards for these control sequences do exist. Two of these standards are the ANSI and ASCII code systems. The ASCII is a simple if necessary rule: it defines the codes which most computers, printers, and terminals use for communication. The ANSI standard takes the ASCII code chart and goes one step further. It gives a general outline of how control sequences should be used, and even defines what some of them should be. Cursor control sequences, for example, are dictated by the ANSI standard, whereas ASCII cursor control sequences are left up to the imagination of the manufacturer.

The result of these standards is to create two groups of terminals. Terminals which conform to the ASCII code standard are commonly called ASCII terminals. Terminals which conform to the ANSI standard are commonly called ANSI terminals. Because these standards are not complete, terminals which conform to these standards are only partially compatible--only some of the control sequences they use are the same.

In order for two terminals to use exactly the same control sequences, it is necessary for one terminal to emulate another. When one type of terminal, in addition to its own special codes, can recognize those of another type of terminal, it is said to emulate that terminal.

The CIT101XL has two emulation modes: an ANSI emulation mode and an ASCII emulation mode. The normal, or native, operating mode of the CIT101XL uses an ANSI set of control codes identical to those used by the CIE Terminals CIT-101E. The ANSI emulation mode has two sub-emulations: the VT100 mode and the VT52 mode.

## THE SET-UP MODE

The alternative emulation mode --the ASCII emulation mode-- uses an ASCII set of control codes identical to those used by the WYSE 50. Since the WYSE 50 terminal emulates six other terminals, the CIT101XL's ASCII emulation mode has six sub-emulations.

All of these emulation modes are organized as follows:

### ANSI Emulation Mode

VT100 (DEC VT100)  
VT52 (DEC VT52)

### ASCII Emulation Mode

WY 50 (Lear Siegler ADM31)  
TVI910 (Televideo 910)  
TVI920 (Televideo 920)  
TVI925 (Televideo 925)  
ADDSVP (ADDS Viewpoint)  
HZ1500 (Hazeltine 1500)

## Changing the ANSI/ASCII Emulation Modes

To select a particular terminal emulation, you must first make sure that you are in the correct emulation mode. If, for example, you want the CIT101XL to operate like the DEC VT52, you must first select the ANSI emulation mode.

To change the emulation mode, enter the Set-Up mode by pressing <SHIFT-SETUP>. Press <SHIFT-CTRL-BREAK>. This command "toggles" the emulation mode. If the terminal was in the ASCII emulation mode, executing this command will switch the terminal to the ANSI emulation mode. If the terminal was in the ANSI emulation mode, executing this command will switch the terminal to the ASCII emulation mode.

## Selecting a Sub-emulation Mode

Once you have selected the correct emulation mode (ANSI or ASCII), you must still select the specific emulation. To select the emulation, enter the Set-Up mode. Press the right arrow key until "Emulation" is highlighted. Press the space bar until the correct emulation appears. Save the sub-emulation by typing <CTRL-S>. Exit Set-Up mode by pressing <SHIFT-SETUP>.

## SET-UP MENUS

The Set-Up menus are divided into two groups. The first group is the ANSI Set-Up mode. It is available when the terminal is in its native ANSI emulation mode. The second group, the ASCII Set-Up mode, is available when the terminal is in the ASCII emulation mode. While the format of each mode is the same, the menus available will differ according to the features available in the emulation mode. The following section lists the available Set-Up menus by menu number. For each menu, the corresponding menus are shown for the ANSI and ASCII emulation modes. Each selection is then explained.



## THE SET-UP MODE

### THE ANSI SET-UP MODE

The ANSI Set-Up mode is available when the terminal is in the ANSI emulation mode. The following section lists the available Set-Up menus by menu number. For each menu, the corresponding selection menus are shown and each selection is then explained.

### ANSI SET-UP MENUS

#### Initial Set-Up Screen Menu

When you first enter the Set-Up mode in the ANSI terminal emulation mode the following screen will appear:

**Emulation Mode ANSI: Comms Display Keyboard Aux Emulation Tabs**

**Set-Up Menu Line for the ANSI Emulation Mode**

#### ANSI COMMS 1 MENU

**COMMS 1: Speed 9600 Parity None Data 8 Stop Bits 1 Protocol Xon**

**SPEED:**            9600        (Default)  
                  19200  
                  38400  
                  150  
                  300  
                  600  
                  1200  
                  2400  
                  4800

Sets the data transmission/reception speed for the COMM (modem) port.

## THE SET-UP MODE

### ANSI COMMS 1 MENU (Continued)

**PARITY:**       None       (Default)  
                  Even  
                  Odd  
                  Mark  
                  Space

Sets the parity for the COMM port. When Mark or Space are selected, the serial word length defaults to 7 (see below).

**DATA:**           8           (Default)  
                  7

Selects the serial word length for the COMM port. If Mark or Space are selected for PARITY (see above), the data word length can only be set to 7.

**STOP BITS:**    1           (Default)  
                  2

Sets the number of stop bits for the COMM port.

**PROTOCOL:**     None  
                  Xon       (Default)  
                  DTR  
                  Both

Selects the protocol for the COMM port. If you select Xon (or Both), XON/XOFF protocol regulates data transmission from the host only. The RCV Xoff parameter in the COMMS 2 menu determines whether or not the host can use XON/XOFF protocol to regulate data transmission from the terminal.

## THE SET-UP MODE

### ANSI COMMS 2 MENU

**COMMS 2:** **Online** **Mode FDX** **Rcv Xoff Process** **Monitor Off**

**ONLINE:**       Online       (Default)  
                  Local

Online places the terminal in communication with the host computer. Local directs keyboard data to the display screen only; no interaction with the host computer occurs.

**MODE:**         FDX         (Default)  
                  HDX

This menu provides two ways of communicating with the host computer when the terminal is online.

In the FDX (full duplex) mode, data entered from the keyboard is sent directly to the host. The screen displays data sent from the host only; the terminal does not echo data entered from the keyboard.

In the HDX (half-duplex) mode, data entered from the keyboard is sent to both the host and the screen. The screen displays data sent from the host as well as data echoed from the keyboard. Keyboard-generated escape sequences are executed on the screen; they are not transmitted to the host.

**RCV XOFF:**     Process     (Default)  
                  Ignore

Determines whether an incoming XOFF character is executed. If enabled ("Process" is selected), the terminal halts data transmission to the host when an XOFF character is received. Transmission is resumed when an XON character is received.

**MONITOR:**     Off         (Default)  
                  On

Turns the monitor mode on and off. When the monitor mode is on, all control characters are displayed in reverse video. With the exception of the LF code, all control characters are not executed.

## THE SET-UP MODE

### ANSI DISPLAY 1 MENU

**DISPLAY 1:** **Screen 80** **Freq 60Hz** **Cursor Blinking Block**

**SCREEN:** 80 (Default)  
80 Rev  
132  
132 Rev

Sets the screen width to 132 or 80 columns and the screen display to normal video (dark background, light characters) or reverse video (light background, dark characters).

**FREQ:** 60Hz (Default)  
50Hz

Sets the screen refresh rate to either 50 or 60 hertz.

**CURSOR:** Blinking Block (Default)  
Static Block  
Blinking Line  
Static Line  
None

Sets the cursor shape and style. Selecting "None" will make the cursor invisible.

## THE SET-UP MODE

### ANSI DISPLAY 2 MENU

DISPLAY 2:	Scroll Jump	Form Feed LF	CRT Saver 60
------------	-------------	--------------	--------------

**SCROLL:**           Jump           (Default)  
                  SM 1  
                  SM 2  
                  SM 3  
                  SM 4

Sets the scroll mode. Jump scroll displays data as fast as possible; smooth scroll limits the scroll speed to a smooth 1, 2, 3 or 4 lines per second.

**FORM FEED:**       LF           (Default)  
                  Clr

If set to LF, the terminal will perform a line feed when a Form Feed (FF) character is received. If set to Clr, an incoming Form Feed character will home the cursor and clear the screen.

**CRT SAVER:**       60           (Default)  
                  Off  
                  10  
                  20  
                  30  
                  40  
                  50

If CRT Saver is enabled, the screen will go blank if there has been no keyboard entries for 10 to 60 minutes. Pressing any key will restore the display.

ANSI DISPLAY 3 MENU

**DISPLAY 3: 24 Rows, Status, & Labels**

- 24 Rows, Status, & Labels (Default)
- 25 Rows, & Labels
- 24 Rows, & Labels

This menu determines the configuration of the display screen. The screen can be selected as either a 24 or 25 data line display. Two 24 line screens can be selected. One has a status line and the other one does not. The status line is not available when the data screen is selected as 25 lines.

## THE SET-UP MODE

### ANSI DISPLAY 4 MENU

**DISPLAY 4:** **Width Change Erase** **RH OF DW Erase** **Erase Extent Page**

**WIDTH CHANGE:** Erase (Default)  
Preserve

Selects whether the screen is preserved or erased when the screen width is changed.

**RH OF DW:** Erase (Default)  
Preserve

Determines whether or not the right 40 columns of a line are preserved when that line is converted to double width. If set to Preserve, the right 40 columns will remain in memory but will not be displayed until the line is converted back to single width. If set to Erase, converting a line to double width will cause the right 40 columns to be discarded.

**ERASE EXTENT:** Page (Default)  
Margin

When set to Page, a page erase command will erase the entire page. When set to Margin, a page erase command will erase only the area defined by the margins.

## THE SET-UP MODE

### ANSI DISPLAY 5 MENU

**DISPLAY 5:** **Tab Motion Direct** **Insert Line Blank**

**TAB MOTION:** Direct (Default)  
Spaces

When set to Direct, a tab command causes the cursor to move to the next tab stop. Data between the last cursor position and the tab stop is preserved. When set to Spaces, the data between the last cursor position and the tab stop is erased and replaced with spaces.

**INSERT LINE:** Blank (Default)  
Attributes

If set to Attributes, an inserted line will take the attributes of the line at which the cursor is inserted. If set to Blank, an inserted line will have normal attributes.



## THE SET-UP MODE

### ANSI DISPLAY 6 MENU

DISPLAY 6:	G0 Map US	G1 Map US
------------	-----------	-----------

**G0 MAP:** US (Default)  
British/UK  
German  
French  
Spanish  
Danish  
Norwegian  
Swed/Fin E47  
Swed/Fin D47  
French/CA  
Graphics

**G1 MAP:** US (Default)  
British/UK  
German  
French  
Spanish  
Danish  
Norwegian  
Swed/Fin E47  
Swed/Fin D47  
French/CA  
Graphics

This menu determines the display screen G0 and G1 display character sets. Refer to the "DESIGNATE CHARACTER SET" section in chapter 6 for a description of the use of the G0 and G1 character sets.

## THE SET-UP MODE

### ANSI KEYBOARD I MENU

**KEYBOARD 1:** **Click On** **Repeat On** **Margin Bell On** **Normal CSR keys**

**CLICK:**            On            (Default)  
                  Off

Selects whether or not a clicking sound is made when a key is pressed.

**REPEAT:**         On            (Default)  
                  Off

Selects whether the auto repeat function is active. If set to On, keys held down for more than a half-second will repeat until the key is released.

**MARGIN BELL:**    On            (Default)  
                  Off

When set to On, the terminal will beep when the cursor is eight columns from the right margin.

**CSR KEYS:**        Normal CSR keys (Default)  
                  Application CSR keys

Determines whether normal ANSI cursor key sequences or applications mode cursor key sequences are used. Refer to the "CURSOR POSITIONING KEYS" section in this Chapter 6.

## THE SET-UP MODE

### ANSI KEYBOARD 2 MENU

KEYBOARD 2:	Auto Wrap Off	New Line Off	Scroll Key VT100
-------------	---------------	--------------	------------------

**AUTOWRAP:**        Off            (Default)  
                  On

When Autowrap is on, the cursor will automatically move to the next line when it reaches the end of the display line. When set to off, the cursor will remain at the last column of the current line. Any received characters will overwrite the existing character at that position.

**New Line:**        Off            (Default)  
                  On

Selects whether the new line function is active. If set to on, the terminal will execute a carriage return and a line feed when the RETURN key is pressed or the CR code is received. If set to off, only a carriage return is executed.

**SCROLL KEY:**     VT100        (Default)  
                  VT52

Determines how the NO SCROLL key will function. In the VT100 mode, the key controls the scrolling of data on the screen by generating an XOFF or XON control code. The PROTOCOL selection in ANSI COMMS 1 MENU must be either XON or BOTH.

In VT52 mode, the HOLD SCREEN mode must be entered by pressing <CTRL-NO SCROLL> or by the appropriate escape sequence. The NO SCROLL key when pressed alone causes one line of data to be scrolled onto the screen. When <SHIFT-NO SCROLL> is pressed, data will be scrolled onto the entire screen area.

## THE SET-UP MODE

### ANSI KEYBOARD 3 MENU

KEYBOARD 3:	Numeric Numpad	Decimal Numpad + PF's	CNTL Q/S are Hold
-------------	----------------	-----------------------	-------------------

**NUMERIC KEYPAD:**        Numeric Numpad        (Default)  
  Application Numpad

Determines the codes produced by the numeric keypad. When set to Numeric Numpad, the numeric keypad will generate the comma, period and 0 through 9 ASCII character codes. When set to Applications Numpad, special escape sequences will be generated. Refer to the "Numeric Keypad" section in Chapter 6.

**HEX KEYPAD:**            Decimal Numpad + PF's        (Default)  
  Hex Keypad

Determines whether or not the numeric keypad generates hexadecimal or decimal numbers. Refer to the Numeric "Keypad and Editing Function Keys" section in Chapter 2. This menu is effective only if the Numeric Numpad mode is set (see previous menu description).

**CNTL Q/S:**                are Hold        (Default)  
  Data

Determines whether XOFF/XON control codes generated at the keyboard are treated as Data and are not acted on by the terminal. In the default selection the the terminal will process and act upon the codes. This mode must be selected for the NO SCROLL key to function properly.

## THE SET-UP MODE

### ANSI AUX 1 MENU

**AUX 1** **Speed 9600** **Parity None** **Data 8** **Rcv Xoff Process** **Tx Xoff On**

**SPEED:**           9600           (Default)  
                  19200  
                  38400  
                  150  
                  300  
                  600  
                  1200  
                  2400  
                  4800

Selects the data transmission/reception speed for the AUX (printer) port.

**PARITY:**           None           (Default)  
                  Even  
                  Odd  
                  Mark  
                  Space

Sets the parity for the COMM port. When Mark or Space are selected, the serial word length defaults to 7 (see below).

**DATA:**            8            (Default)  
                  7

Selects the serial word length for the COMM port. If Mark or Space are selected for PARITY (see above), the data word length can only be set to 7.

**RCV XOFF:**        Process       (Default)  
                  Ignore

If enabled, the terminal halts transmission when it receives an XOFF character from the AUX port. Transmission is resumed when an XON is received.

**TX XOFF:**         On           (Default)  
                  Off

When On the terminal transmits XON and XOFF characters to the AUX port to regulate data received from the AUX port.

ANSI AUX 2 MENU

**AUX 2:** **Page Term None** **Print Ext Screen**

**PAGE TERM:** None (Default)  
FF

Determines whether or not a Form Feed (FF) character is sent as a page terminator at the end of a page send operation.

**PRINT EXT:** Screen (Default)  
Margin

When set to Screen, a page send command will transmit the entire page to the AUX port. When set to Margin, a page send command will transmit only the area defined by the margins.

ANSI AUX 3 MENU

**AUX 3:** **Fill After CR** **Print Non Fill On** **Fill Count 00**

**FILL AFTER:** CR (Default)  
LF

Determines whether a transmitted Carriage Return (CR) or Line Feed (LF) will be followed by a selectable number of fill characters.

**PRINT NON FILL:** On (Default)  
Off

Determines whether or not the Fill After character (CR or LF) selected in the previous menu is suppressed.

**FILL COUNT:** 00 (Default)  
01  
..  
99

Determines the number of fill characters to be transmitted following the selected Fill After character.

## THE SET-UP MODE

### ANSI AUX 4 MENU

**AUX 4:** **Print Normal**

**Print:**        Normal    (Default)  
              National

Determines the character set that will be used to transmit characters from the AUX port.

## THE SET-UP MODE

### ANSI EMULATION MENU

**EMUL: VT100**   **Identify VT102**   **Keyboard Language US**

**EMULATION MODE:**    VT100        (Default)  
                          VT52

Selects the terminal emulation for the ANSI emulation mode.

**IDENTIFY:**            VT102        (Default)  
                          VT100  
                          VT101  
                          VT200

Determines whether the terminal identifies itself as a VT102, VT100, VT101, or VT200 when the host computer requests the terminal for identification.

**KEYBOARD LANGUAGE:**    US            (Default)

Selects the keyboard language. This parameter is only effective if your terminal has the foreign language option.

### ANSI TABS MENU

```
12345678H0123456H8901234H6789012H4567890H2345678H0123456H89..
```

**Tabulation:**            Default = tabs every eighth column (starting at column 9)

On the TAB display, an TAB character appears for each tab that is set. To move the cursor, use left and right arrow keys. When the cursor is at the desired position, press the space bar to clear an existing tab, or to set a tab where there was none.



## THE SET-UP MODE

## THE ASCII SET-UP MODE

### Initial Set-Up Screen Menu

When you first enter the Set-Up mode in the ASCII terminal emulation mode the following screen will appear:

**Emulation Mode ASCII** **Comms** **Display** **Keyboard** **Aux** **Emulation**

Set-Up Menu Line for the ASCII Emulation Mode

## ASCII SET-UP MENUS

The ASCII Set-Up mode is available when the terminal is in its native ASCII emulation mode. The following section lists the available ASCII Set-Up menus by menu number. Each selection within the menu is then described following the illustration of the menu.

### ASCII COMMS 1 MENU

**COMMS 1** **Speed 9600** **Parity None** **Data 8** **Stop Bits 1** **Protocol None**

**SPEED:**           9600           (Default)  
                  19200  
                  38400  
                  150  
                  300  
                  600  
                  1200  
                  2400  
                  4800

Sets the data transmission/reception speed for the COMM (modem) port.

## THE SET-UP MODE

### ASCII COMMS 1 MENU (Continued)

**PARITY:**       None       (Default)  
                  Even  
                  Odd  
                  Mark  
                  Space

Sets the parity for the COMM port.

**DATA:**         8         (Default)  
                  7

Selects the serial word length for the COMM port.

**STOP BITS:**    1         (Default)  
                  2

Sets the number of stop bits for the COMM port.

**PROTOCOL:**     None       (Default in ASCII mode)  
                  Xon  
                  DTR  
                  Both

Selects the protocol for the COMM port. If you select Xon or Both in the ASCII mode, XON/XOFF protocol regulates the transmission of data to the host and the transmission of data from the host.

## THE SET-UP MODE

### ASCII COMMS 2 MENU

COMMS 2:	Mode FDX	Block End US/CR	Test Off
----------	----------	-----------------	----------

**MODE:**            FDX            (Default)  
                  HDX  
                  Block  
                  H-Block

This menu provides four ways of communicating with the host computer when the terminal is online.

In the FDX (full duplex) mode, data entered from the keyboard is sent directly to the host. The screen displays data sent from the host only; the terminal does not echo data entered from the keyboard.

In the HDX (half-duplex) mode, data entered from the keyboard is sent to both the host and the screen. The screen displays data sent from the host as well as data echoed from the keyboard. Keyboard-generated escape sequences are executed on the screen; they are not transmitted to the host.

In either the BLOCK or H-BLOCK modes, data entered affects the screen only. Data is not transmitted to the host until a SEND command is received from the keyboard or the host. Escape sequences are executed onscreen and not sent to the host.

**BLOCK END:**      US/CR            (Default)  
                  CRLF/ETX

Selects the end-of-block sequence.

**TEST:**            Off            (Default)  
                  On

When the test mode is turned on, the terminal executes a diagnostic self-test. Refer to Appendix H.

## THE SET-UP MODE

### ASCII DISPLAY 1 MENU

**DISPLAY 1:** **Screen 80** **Freq 60Hz** **Cursor Blinking Block**

**SCREEN:** 80 (Default)  
80 Rev  
132  
132 Rev

Sets the screen width to 132 or 80 columns and the screen display to normal video (dark background, light characters) or reverse video (light background, dark characters).

**FREQ:** 60Hz (Default)  
50Hz

Sets the screen refresh rate to either 50 or 60 hertz.

**CURSOR:** Blinking Block (Default)  
Static Block  
Blinking Line  
Static Line  
None

Sets the cursor shape and style. Selecting "None" will make the cursor invisible.

## THE SET-UP MODE

### ASCII DISPLAY 2 MENU

**DISPLAY 2:** **Auto Scroll On** **Scroll Jump** **Protect Dim** **CRT Saver 60**

**AUTO SCROLL:**           On           (Default)  
                          Off

Controls the automatic scrolling function. When the auto scroll function is on, typing characters past the end of screen will cause the terminal to scroll one line up.

**SCROLL:**               Jump           (Default)  
                          SM 1  
                          SM 2  
                          SM 3  
                          SM 4

Sets the scroll mode. Jump scroll displays data as fast as possible; smooth scroll limits the scroll speed to a smooth 1, 2, 3 or 4 lines per second.

**PROTECT:**             Dim           (Default)  
                          Reverse  
                          Normal

Determines how protected characters are displayed. Protected characters can be normal, reverse video, or dim.

**CRT SAVER:**          60           (Default)  
                          Off  
                          10  
                          20  
                          30  
                          40  
                          50

If CRT Saver is enabled, the screen will go blank if there has been no keyboard for 10 to 60 minutes. Pressing any key will restore the display.

## THE SET-UP MODE

### ASCII DISPLAY 3 MENU

**DISPLAY 3:** **24 Rows, Status, & Labels**

24 Rows, Status, & Labels            (Default)  
25 Rows, & Labels  
24 Rows, & Labels

This menu determines the configuration of the display screen. The screen can be selected as either a 24 or 25 data line display. Two 24 line screens can be selected. One has a status line and the other one does not. The status line is not available when the data screen is selected as 25 lines.

## THE SET-UP MODE

### ASCII KEYBOARD MENU 1

**KEYBOARD 1:** **Click On** **Repeat On** **Ret/Enter CR/CR**

**CLICK:**           On           (Default)  
                  Off

Selects whether or not a clicking sound is made when a key is pressed.

**REPEAT:**         On           (Default)  
                  Off

Selects whether the auto repeat function is active. If set to On, keys held down for more than a half-second will repeat until the key is released.

**RET/ENTER:**     CR/CR       (Default)  
                  CRLF/TAB

Selects the functions of the Return and Enter keys. If set to CR/CR, both keys generate a carriage return. If set to CRLF/TAB, the Return key generates a carriage return (CR) and line feed (LF) and the Enter key generates a horizontal tab (HT).

### ASCII KEYBOARD MENU 2

**KEYBOARD 2:** **Auto Wrap Off** **Rcv CR CR**

**AUTOWRAP:**       Off           (Default)  
                  On

When Autowrap is on, the cursor will automatically move to the next line when it reaches the end of the display line. When set to off, the cursor will remain at the last column of the current line. Any received characters will overwrite the existing character at that position.

**RCV CR:**         CR           (Default)  
                  CRLF

When set to CR, the terminal will execute a carriage return only. When set to CRLF, the terminal will execute a carriage return and line feed.

## ASCII AUX MENU

**AUX:** **Speed 9600** **Parity None** **Data 8** **Rcv Xoff Process**

**SPEED:** 9600 (Default)  
19200  
38400  
150  
300  
600  
1200  
2400  
4800

Selects the data transmission/reception speed for the AUX (printer) port.

**PARITY:** None (Default)  
Even  
Odd  
Mark  
Space

Sets the parity for the AUX port.

**DATA:** 8 (Default)  
7

Selects the serial word length for the AUX port.

**RCV XOFF:** Process (Default)  
Ignore

Determines whether an XOFF received from the AUX port is executed. If enabled, the terminal halts transmission when it receives an XOFF character from the AUX port. Transmission is resumed when the terminal receives and XON character.



**THE SET-UP MODE**

**ASCII EMULATION MENU**

**EMUL:** **Mode WY 50** **Enhance Off** **Keyboard Language US**

**MODE:**           WY 50           (Default)  
                  TVI910  
                  TVI920  
                  TVI925  
                  ADDSVP  
                  HZ1500

Selects the terminal emulation for the ASCII emulation mode. Note that the WYSE 50 native mode (WY 50) is an emulation of the ADM31.

**ENHANCE:**       Off           (Default)  
                  On

If set to on, the HZ1500 (Hazeltime 1500) and ADDSVP (ADDS Viewpoint) emulation modes are enhanced with selected WY 50 codes. Refer to **Terminal Mode Control Sequences** in Chapter 7 for a complete description of this feature.

**KEYBOARD LANGUAGE:**    US           (Default)  
                          British/UK  
                          German  
                          French  
                          Spanish  
                          Danish  
                          Norwegian  
                          Swed/Fin E47  
                          Swed/Fin D47  
                          French/CA

This menu selects the keyboard language.

## THE SET-UP MODE

### SET-UP MODE SUMMARY

#### KEYBOARD CONTROLS

<u>ACTION</u>	<u>KEY</u>
SWITCH AMONG CHOICES	SPACE BAR OR <ENTER>
SELECT PARAMETER TO THE RIGHT	RIGHT ARROW
SELECT PARAMETER TO THE LEFT	LEFT ARROW
NEXT MENU	DOWN ARROW
PREVIOUS MENU	UP ARROW
SAVE CURRENT PARAMETER CHOICE	<CTRL-S>
READ SAVED PARAMETERS	<CTRL-R>
READ DEFAULT PARAMETERS	<CTRL-D>
TOGGLE SET-UP MODE	<SHIFT-SETUP>
RETURN TO INITIAL MENU LINE	<SETUP>

TO LEAVE THE SET-UP MODE, PRESS <SHIFT-SETUP>.

#### ANSI SET-UP MENU

##### ANSI COMMS 1 MENU

**SPEED:**            9600        (Default)  
                     19200  
                     38400  
                     150  
                     300  
                     600  
                     1200  
                     2400  
                     4800

**PARITY:**           None        (Default)  
                     Even  
                     Odd  
                     Mark  
                     Space

**DATA:**            8            (Default)  
                     7

**STOP BITS:**      1            (Default)  
                     2

**PROTOCOL:**       None        (Default)  
                     Xon  
                     DTR  
                     Both

## THE SET-UP MODE

### ANSI COMMS 2 MENU

**ONLINE:** Online (Default)  
Local

**MODE:** FDX (Default)  
HDX

**RCV XOFF:** Process (Default)  
Ignore

**MONITOR:** Off (Default)  
On

### ANSI DISPLAY 1 MENU

**SCREEN:** 80 (Default)  
80 Rev  
132  
132 Rev

**FREQ:** 60Hz (Default)  
50Hz

**CURSOR:** Blinking Block (Default)  
Static Block  
Blinking Line  
Static Line  
None

### ANSI DISPLAY 2 MENU

**SCROLL:** Jump (Default)  
SM 1  
SM 2  
SM 3  
SM 4

**FORM FEED:** LF (Default)  
Clr

**CRT SAVER:** 60 (Default)  
Off  
10  
20  
30  
40  
50

### ANSI DISPLAY 3 MENU

24 Rows, Status, & Labels (Default)  
25 Rows, & Labels  
24 Rows, & Labels

## THE SET-UP MODE

### ANSI DISPLAY 4 MENU

**WIDTH CHANGE:** Erase (Default)  
Preserve

**RH OF DW:** Erase (Default)  
Preserve

**ERASE EXTENT:** Page (Default)  
Margin

### ANSI DISPLAY 5 MENU

**TAB MOTION:** Direct (Default)  
Spaces

**INSERT LINE:** Blank (Default)  
Attributes

### ANSI DISPLAY 6 MENU

**GO MAP:** US (Default)  
British/UK  
German  
French  
Spanish  
Danish  
Norwegian  
Swed/Fin E47  
Swed/Fin D47  
French/CA  
Graphics

**G1 MAP:** US (Default)  
British/UK  
German  
French  
Spanish  
Danish  
Norwegian  
Swed/Fin E47  
Swed/Fin D47  
French/CA  
Graphics

## THE SET-UP MODE

### ANSI KEYBOARD 1 MENU

**CLICK:**            On            (Default)  
                  Off

**REPEAT:**        On            (Default)  
                  Off

**MARGIN BELL:** On            (Default)  
                  Off

**CSR KEYS:**      Normal CSR keys (Default)  
                  Application CSR keys

### ANSI KEYBOARD 2 MENU

**AUTOWRAP:**      Off            (Default)  
                  On

**New Line:**     Off            (Default)  
                  On

**SCROLL KEY:**   VT100        (Default)  
                  VT52

### ANSI KEYBOARD 3 MENU

**NUMERIC KEYPAD:**    Numeric Numpad        (Default)  
                      Application Numpad

**HEX KEYPAD:**        Decimal Numpad + PF's   (Default)  
                      Hex Keypad

**CNTL Q/S:**         are Hold   (Default)  
                      Data

## THE SET-UP MODE

### ANSI AUX 1 MENU

**SPEED:** 9600 (Default)  
19200  
38400  
150  
300  
600  
1200  
2400  
4800

**PARITY:** None (Default)  
Even  
Odd  
Mark  
Space

**DATA:** 8 (Default)  
7

**RCV XOFF:** Process (Default)  
Ignore

**TX XOFF:** On (Default)  
Off

### ANSI AUX 2 MENU

**PAGE TERM:** None (Default)  
FF

**PRINT EXT:** Screen (Default)  
Margin

### ANSI AUX 3 MENU

**FILL AFTER:** CR (Default)  
LF

**PRINT NON FILL:** On (Default)  
Off

**FILL COUNT:** 00 (Default)  
01  
..  
99

### ANSI AUX 4 MENU

**Print:** Normal (Default)  
National

## THE SET-UP MODE

### ANSI EMULATION MENU

EMULATION MODE: VT100 (Default)  
VT52

IDENTIFY: VT102 (Default)  
VT100  
VT101  
VT200

KEYBOARD LANGUAGE: US (Default)

### ANSI TABS MENU

Tabulation: Default = tabs every eighth column (starting at column 9)

ASCII SET-UP MENUS

ASCII COMMS 1 MENU

**SPEED:** 9600 (Default)  
19200  
38400  
150  
300  
600  
1200  
2400  
4800

**PARITY:** None (Default)  
Even  
Odd  
Mark  
Space

**DATA:** 8 (Default)  
7

**STOP BITS:** 1 (Default)  
2

**PROTOCOL:** None (Default in ASCII mode)  
Xon  
DTR  
Both

ASCII COMMS 2 MENU

**MODE:** FDX (Default)  
HDX  
Block  
H-Block

**BLOCK END:** US/CR (Default)  
CRLF/ETX

**TEST:** Off (Default)  
On



## THE SET-UP MODE

### ASCII DISPLAY 1 MENU

**SCREEN:** 80 (Default)  
80 Rev  
132  
132 Rev

**FREQ:** 60Hz (Default)  
50Hz

**CURSOR:** Blinking Block (Default)  
Static Block  
Blinking Line  
Static Line  
None

### ASCII DISPLAY 2 MENU

**AUTO SCROLL:** On (Default)  
Off

**SCROLL:** Jump (Default)  
SM 1  
SM 2  
SM 3  
SM 4

**PROTECT:** Dim (Default)  
Reverse  
Normal

**CRT SAVER:** 60 (Default)  
Off  
10  
20  
30  
40  
50

### ASCII DISPLAY 3 MENU

24 Rows, Status, & Labels (Default)  
25 Rows, & Labels  
24 Rows, & Labels

## THE SET-UP MODE

### ASCII KEYBOARD MENU 1

**CLICK:**            On            (Default)  
                 Off

**REPEAT:**        On            (Default)  
                 Off

**RET/ENTER:**    CR/CR        (Default)  
                 CRLF/TAB

### ASCII KEYBOARD MENU 2

**AUTOWRAP:**     Off           (Default)  
                 On

**RCV CR:**        CR            (Default)  
                 CRLF

### ASCII AUX MENU

**SPEED:**         9600        (Default)  
                 19200  
                 38400  
                 150  
                 300  
                 600  
                 1200  
                 2400  
                 4800

**PARITY:**        None         (Default)  
                 Even  
                 Odd  
                 Mark  
                 Space

**DATA:**          8            (Default)  
                 7

**RCV XOFF:**     Process      (Default)  
                 Ignore

## THE SET-UP MODE

### ASCII EMULATION MENU

**MODE:**           WY 50           (Default)  
                  TVI910  
                  TVI920  
                  TVI925  
                  ADDSVP  
                  HZ1500

**ENHANCE:**       Off           (Default)  
                  On

**KEYBOARD LANGUAGE:**   US           (Default)  
                          British/UK  
                          German  
                          French  
                          Spanish  
                          Danish  
                          Norwegian  
                          Swed/Fin E47  
                          Swed/Fin D47  
                          French/CA

## CHAPTER 5 -- PROGRAMMABLE FUNCTION KEYS

---

### INTRODUCTION

This chapter provides all the information you need to use the programmable key feature of the CIT101XL terminal. The keys may be programmed by the operator at the keyboard by using the function key editor or by the host computer with the use of control sequences.

The CIT101XL has 16 programmable function keys, F1 through F16, which can be used to generate 32 functions. Pressing <F1> through <F16> (unshifted) generates functions F1 through F16; pressing <SHIFT-F1> through <SHIFT-F16> generates functions F17 through F32. By using these programmable keys, you can make one function key do the work of many ordinary keys. Repetitive keystrokes, word processing commands, and any other special command can be recorded and then played back by pressing a single function key.

Function keys can be programmed by means of the function key editor in either of the ANSI or ASCII terminal emulation modes. The procedure is the same in both modes. However, the control sequences to program the keys from the host vary depending on the terminal emulation mode.

Included first in this chapter is a description of the function key editor, followed by descriptions of the ANSI and ASCII function key programming sequences.

## FUNCTION KEYS

### FUNCTION KEY EDITOR

#### Entering the Function Key Editor

To enter the function key editor, first enter the Set-Up mode by pressing <SHIFT-SETUP>. Once you are in the Set-Up mode, press the function key you wish to program (keys <F1> through <F16> for functions F1 through F16 and <SHIFT-F1> through <SHIFT-F16> for functions F17 through F32). The function key editor will appear as follows:

KEY: F01	*	AV.SPACE 04352
↑	↑	↑
Programmed Key	End of Sequence Display Box	Available Memory

#### The Function Key Editor Screen

The key which is being programmed is shown in the left-most box as KEY: Fxx, where xx is the current function key number. For example, if you hit the F1 key, KEY: F01 will be displayed.

The center display box contains the key sequence programmed for Fxx. The cursor marks where typed characters will be inserted. The end of the sequence is marked by an asterisk (\*). You can enter more characters than can be displayed in the display box. If the key sequence extends to the right of the display box, a blinking > will appear at the right-most position. If the key sequence extends to the left of the display box, a blinking < will appear in the left-most column.

The right-most box contains the available space left for storing the function key contents. This space can be divided up between any keys in any way. The sole limitation is memory: the sum of the lengths of all the F-Key sequences cannot exceed 4352 characters. If the space is exhausted, the terminal will beep each time you try to enter new data.

## FUNCTION KEYS

### Editing a Function Key Sequence

To edit a function key after entering the editor, simply type the characters you want the F-Key to generate. You are not limited to normal alphanumeric characters; control characters can be entered by typing <CTRL> and the control character. If the cursor is positioned between existing characters, typed characters will be inserted between (not written over) existing characters. Typing past the end of the display box will cause the display to scroll left.

To move to any position in the sequence, use the right or left arrow keys. If the sequence is larger than the display box, moving the cursor to the right or left past the end of the display box will scroll the display left or right. To delete the character to the left of the cursor, press the delete key. Characters to the right of the deleted character will be moved one column left.

Function key sequences are saved automatically in nonvolatile memory when you exit the function key editor by pressing <SETUP> or <SHIFT-SETUP>.

### Function Key Editor Commands

<u>Keystroke</u>	<u>Action performed</u>
<F1> to <F16>	Edit function keys F1 through F16.
<SHIFT-F1> to <SHIFT-F16>	Edit function keys F17 through F32.
<↑> (Up Arrow)	Edit previous function key.
<↓> (Down Arrow)	Edit next function key.
<→> (Right Arrow)	Move cursor right. Scroll left if end of display is encountered.
<SHIFT-→>	Move cursor to end of function key sequence.
<←> (Left Arrow)	Move cursor left. Scroll right if end of display is encountered.
<SHIFT-←>	Move cursor to start of function key sequence.
<DELETE>	Delete character to left of cursor. Characters to the right of the cursor are moved left.

## FUNCTION KEYS

### Function Key Editor Commands (Continued)

<u>Keystroke</u>	<u>Action performed</u>
<SHIFT-DELETE>	Delete character under the cursor. Characters to the right of the cursor are moved left.
<CTRL-DELETE>	Delete entire function key sequence.
<SHIFT-CTRL-DELETE>	Delete characters from cursor to end of sequence.
<SETUP>	Exit function key editor to Set-Up mode. Function keys are saved in nonvolatile memory.
<SHIFT-SETUP>	Exit function key editor to normal operating mode. Function keys are saved in nonvolatile memory.

## FUNCTION KEYS

### Function Key Label Editor

When not in the Set-Up mode, line 26 on the screen is dedicated to the function key labels. These labels allow you to display on screen the functions which the function keys will execute when pressed. Function key labels can be programmed by means of escape sequences (refer to the appropriate section in this chapter) or from the keyboard.

In the 80 column display mode, 16 function key labels are available: 8 unshifted and 8 shifted. In the 132 column display mode, 32 function key labels are available: 16 unshifted and 16 shifted.

To program function key labels from the keyboard, enter the Set-Up mode by pressing <SHIFT-SETUP>. Press <NO SCROLL>. You are now in the function key label editor. The Set-Up menus line will disappear, and the unshifted function key labels will appear at line 26. If no function keys have been programmed, line 26 on the screen will be blank. To edit a function key label, simply move the cursor to by means of the right or left arrow keys to the desired label position and type. Typed characters overwrite existing characters.

If no labels have been programmed, the function key label fields will be invisible. You will not be able to see where one field ends and another begins. If this is the case, hold down any alphanumeric key (such as "m") until the function key labels are filled. The function key label fields will be separated by spaces as follows:

mmmmmmmm	mmmmmmmm	mmmmmmmm	THRU	mmmmmmmm	mmmmmmmm	mmmmmmmm
↑	↑	↑		↑	↑	↑
F1	F2	F3		F6	F7	F8

### Function Key Label Fields

If the screen is in the 132 column mode, sixteen fields will appear. You can edit the fields any way you wish. You need not use field one for the label for the function key F1, field 2 for F2, etc.

To edit the second group of function key labels (the shifted function key labels), press and hold the <SHIFT> key and then press the <NO SCROLL> key. You can edit the shifted function key labels the same way you edited the unshifted function key labels.

To exit the function key label editor press <SETUP> or <SHIFT-SETUP>. Once you are out of the Set-Up mode, the unshifted labels will appear at line 26. Pressing the <SHIFT> key will display the shifted function key labels.

Function key labels can not be saved. Once you turn the power off, the labels are lost.



## FUNCTION KEYS

If you change the screen width after function key labels have been programmed, you may have to delete the function key label line. To do so, press <SHIFT-CTRL-DELETE>.

The following table summarizes the function key label commands:

<u>Keystroke</u>	<u>Action performed</u>
<SHIFT-SETUP>	Enter/Exit the Set-Up mode.
<NO SCROLL>	Edit the unshifted function key labels.
<SHIFT-NO SCROLL>	Edit the shifted function key labels.
<→> (Right Arrow)	Move cursor right.
<←> (Left Arrow)	Move cursor left.
<SHIFT-CTRL-DELETE>	Delete function key labels.
<SETUP>	Return to the Set-Up mode.

## FUNCTION KEYS

### ANSI PROGRAMMABLE FUNCTION KEY CONTROLS

#### Function Keys

In the ANSI emulation mode the function keys generate the following default sequences when pressed.

#### Function Key Generated Codes

Function Key	Default Sequence
F1	ESC[17~
F2	ESC[18~
F3	ESC[19~
F4	ESC[20~
F5	ESC[21~
F6	ESC[23~
F7	ESC[24~
F8	ESC[25~
F9	ESC[26~
F10	ESC[28~
F11	ESC[29~
F12	ESC[31~
F13	ESC[32~
F14	ESC[33~
F15	ESC[34~
F16	ESC[35~

Used with the <SHIFT> key, the function keys can be programmed to generate up to sixteen additional functions. Shifted keys <F17> through <F32> do not generate default sequences.

#### Function Key Control Sequences

Function keys <F1> through <F16> can be programmed to generate up to 32 functions through the Function Key Editor, or through a device control string. A total of 4352 bytes of memory are dedicated to storing programmed data in nonvolatile memory. Once that space is used up, no more keys can be programmed until some space is made available. To free up space, you may:

- redefine a key definition with a shorter sequence, or
- clear all defined keys with a device control string.

## FUNCTION KEYS

There are two DCS methods that can be used to download a programmable Function key.

### Method 1

Format 1 is as follows:

```
ESC P Pc;P1|Kyn/Stn;...;Kyn/Stn ESC \
```

where:

**ESC P** is the Device Control String Introducer

**Pc** Clear Parameter.  
none = Clear all keys before loading  
0 = Clear all keys before loading  
1 = Clear only keys being loaded

**P1** Lock Parameter.  
Ignored, keys are never locked

**|** Vertical Bar.  
Designates a soft key load sequence

**Kyn** Key Number.  
21 = F-Key 1 (normal)  
22 = F-Key 2 (normal)  
:  
37 = F-Key 17 (F-Key 1 shifted)  
:  
52 = F-Key 32 (F-Key 16 shifted)

Note that all combinations with alphas (i.e. 2A, 3F) are illegal and will abort the command.

**/** Separator

**Stn** String data is hex pairs. Valid range is 30H through 39H (0-9), 41H through 46H (A-F) and 61H through 66H (a-f). When these hex values are combined, they represent one byte of hex data in the range 00H through FFH.

**ESC \** ANSI String Terminator

Several definitions can be entered in one string by separating each Kyn/Stn sequence with a separator (;).

The format for clearing the Function keys is as follows:

```
ESC P 0;1| ESC \
```

This sequence returns keys <F1> through <F16> to their default sequences, and sets the <F17> through <F32> keys to empty.

## FUNCTION KEYS

As an example, to define key F5 to display the word "FILE" when pressed, and to do this without clearing values in any other keys, the string would begin:

```
ESC P 1;0|25/
```

The 25 after the vertical bar (|) identifies key F5 as the key to be loaded. The encoding for "FILE" (in Hex) is:

```
F = 46  
I = 49  
L = 4C  
E = 45
```

Thus, after the slash character (/), continue with this string:

```
46494C45 ESC \
```

The ESC \ specifies the end of the string.

By finding the hexadecimal equivalent of any of the terminals valid control functions, a function key could perform those functions by down-line loading the control sequence.

### Method 2

Format 2 is as follows:

```
ESC P Pn u <key data> ESC \
```

where:

```
ESC P      is the ANSI Device Control String (DCS) introducer  
Pn         is the key number  
u          is the terminator for the DCS introducer  
<key data> is the string of ASCII characters  
ESC \     is the ANSI String Terminator (ST)
```

For example:

```
ESC P 29 u FILE ESC \
```

programs Function key 9 to display the word 'FILE' when pressed.

Note that the command to clear all programmable Function keys:

```
ESC P 0;1 | ESC \
```

remains unchanged.

## FUNCTION KEYS

### Programmable Function Key Labels

Line 26 on the screen is dedicated to the Function key labels when out of Set-Up mode. These labels display the Functions programmed into the Function keys. In 80 column mode, 16 Function key labels are available: eight unshifted and eight shifted. In 132 column mode, 32 Function key labels are available: 16 unshifted and 16 shifted.

The format to load the Function key label line is described below:

```
ESC [ Pl;Pfs;Pf W <text> ESC \
```

where:

- ESC [** is the ANSI Command String Introducer.
- Pl** Line Select. This parameter selects either the normal or shifted Function Key Label line as the line being written.
- 0 = Normal F-Key Label Line, field write
  - 1 = Shifted F-Key Label Line, field write
  - 2 = Normal F-Key Label Line, write entire line
  - 3 = Shifted F-Key Label Line, write entire line
- Pfs** Field Set Select. This parameter selects which set of eight fields is being written.
- 0 = 1st eight fields
  - 1 = 2nd eight fields
- Pf** Field Select. This parameter selects which field within the Field Set is being written.
- 0 = 1st field (first in set)
  - :
  - 7 = 8th field (last in set)
- W** Command Header Terminator
- <text>** ASCII text to write to F-Key Label line. Normal 7-bit ASCII characters are valid. Control codes will be executed if received.
- ESC \** ANSI String Terminator

## FUNCTION KEYS

- NOTES:**
- When P1 = 2 or 3, all other parameters are ignored.
  - When P1 = 1 or 2, three parameters are required for command execution, less than three parameters will abort command execution.
  - ANY illegal parameter will abort the command and print to the screen.
  - Entering no parameters is illegal.
  - If more <text> data is received than the specified field length allows, the additional <text> data will be discarded.
  - Command interpretation will only halt on a received ESC \.
  - When the display is in 80 column mode, the first and second eight fields (Field Set 0 or 1) are the same.

For example, the command to write the third field from the left on the shifted F-Key Label Line is:

```
ESC [ 1;0;2 W <text> ESC \
```

The command to write the entire normal F-Key Label Line is:

```
ESC [ 2 W <text> ESC \
```

The Function Key Label line display attributes are changed through the following DCS string:

```
ESC [ > Pa W
```

where:

ESC [ > is the Device Control String Introducer.

Pa Specified Attribute.

0 = Normal (Default)  
1 = Reverse video  
2 = Invisible

W Command Terminator.

## FUNCTION KEYS

### ASCII PROGRAMMABLE FUNCTION KEY CONTROLS

An unprogrammed function key transmits a default value code in the ASCII emulation mode with the format:

SOH value CR

value is the the default value code listed in the following table. The Field code listed in the table defines an onscreen label that is associated with a specific key. Refer to the Function Key Label Editor description.

Programmable Function Key Default Value Codes

Function Key	Field Code	Default Value Code
<F1>	0	@
<SHIFT-F1>	P	'
<F2>	1	A
<SHIFT-F2>	Q	a
<F3>	2	B
<SHIFT-F3>	R	b
<F4>	3	C
<SHIFT-F4>	S	c
<F5>	4	D
<SHIFT-F5>	T	d
<F6>	5	E
<SHIFT-F6>	U	e
<F7>	6	F
<SHIFT-F7>	V	f
<F8>	7	G
<SHIFT-F8>	W	g
<F9>	8	H
<SHIFT-F9>	X	h
<F10>	9	I
<SHIFT-F10>	Y	i
<F11>	:	J
<SHIFT-F11>	Z	j
<F12>	;	K
<SHIFT-F12>	[	k
<F13>	<	L
<SHIFT-F13>	\	I
<F14>	=	M
<SHIFT-F14>	]	m
<F15>	>	N
<SHIFT-F15>	^	n
<F16>	?	O
<SHIFT-F16>	-	o

## FUNCTION KEYS

### NOTE:

Field (unshifted message) and (shifted message) specify the entire function keys labeling line as one message field of up to 78 characters for an 80-column screen or up to 130 characters for a 132-column screen.

80-column screen = eight function key label fields, shiftable to 16

132-column screen = 16 function key label fields, shiftable to 32

### Program Function Keys/Function Key Labels

WY-50	TVI-910	TVI-920	TVI-925	HZ-1500	ADDS-VP
ESC z	ESC f	ESC f	ESC f	ESC z	ESC z

This sequence enters a message into a selected function key label field or programs a user-defined sequence for a function key (maximum of eight label fields, shiftable to 16 for an 80-column screen: maximum of 16 label fields, shiftable to 32 for a 132-column screen) The message format is:

**ESC z n aaaa CR**

where n = field code (see Function Key Field Codes/Default Value Codes) and aaaa = a character string of up to eight characters for an 80-column screen or up to seven characters for a 132-column screen.

**ESC z n CR** clears a particular function key label field.

**ESC z DEL** turns off the shifted function key labeling line.

the function key program format is:

**ESC z value SEQ DEL**

where value = the default value code (see Function Key Field Codes/Default Value Codes)

**SEQ** = the program sequence up to eight bytes (4352 byte maximum for all function keys).





## **CHAPTER 6 -- ANSI APPLICATION GUIDE**

---

### **INTRODUCTION TO TERMINAL CONTROL CODES**

The CIT101XL terminal is a general purpose display terminal which operates in one of the two most commonly used programming standards: ANSI and ASCII. In ANSI mode, the terminal emulates the CIE TERMINALS CIT-101 and CIT-101E terminals. In this mode the CIT101XL is compatible with the DEC VT100, VT102 and VT52 video terminals. The mode of operation is selected in Set-Up and as described in Chapter 4.

In the ASCII mode of operation the terminal recognizes codes as defined by the ANSI document X3.4-1977 which defines the American Standard Code for Information Interchange (ASCII). For programming information in the ASCII mode of operation, refer to Chapter 7.

In ANSI mode the terminal recognizes ASCII codes and also recognizes control sequences as defined by ANSI document X3.64-1979 "Additional Controls for Use with American National Standard for Information Interchange". In this chapter application information for the ANSI mode of operation is presented.

In both modes of operation the terminal exchanges information with the host by the use of codes which are defined by the ASCII standard. These codes are categorized as either Graphic character codes or Control character codes.

Graphic character codes represent the letters of the alphabet, numbers, punctuation marks and various other symbols (such as dollar signs, plus signs, and so on). The CIT101XL also has the capability to substitute graphic characters in part of the standard U.S. ASCII character set.

Control character codes represent control functions and are used as instructions to the terminal or host for functions such as a carriage return (CR), end-of-transmission (EOT), to introduce a control code sequence (ESC), or other functions common in terminal operations.

This chapter is divided into two sections. The first section of this chapter describes the keyboard operation when in the ANSI emulation mode. In this section the features available from the keyboard are described. The ASCII codes that are generated by the terminal keyboard in the ANSI mode are described.

The last section of this chapter deals with escape code sequences generated and recognized by the terminal.

## **ANSI APPLICATION**

### **HOW INFORMATION IS PRESENTED IN THIS CHAPTER**

The ASCII codes in this chapter are presented in the form of ASCII mnemonics. Refer to Appendix C which contains the ASCII code chart and also provides the decimal and hexadecimal equivalents for the ASCII mnemonics.

For example, the ASCII code for controlling the bell tone is shown in this chapter and in the ASCII code chart as the ASCII mnemonic BEL. The hexadecimal equivalent is 07 and the decimal equivalent is 07.

In this chapter the key or keys required to generate a control code are enclosed by <> brackets. For example the BEL code can be generated from the keyboard by pressing <CTRL-G>. A complete listing of the key actions required to produce control codes is on page 6-5.

Two types of sequences are presented in this chapter: control codes and escape sequences. A control code sequence can consist of ASCII control codes, graphic character codes and parameters. Escape sequences always contain the ASCII control code ESC (escape) as the introducer to the sequence.

When control or escape sequences are presented in this chapter, the sequence may contain ASCII graphic characters in addition to ASCII mnemonics. The codes for these characters can also be found in the ASCII code chart.

Two types of parameters are contained in this section and are noted as Ps or Pn. Ps refers to a selective parameter that selects a specified function from one of several available. Pn refers to a numeric parameter which indicates a numeric value, for example, a specific row or column on the display screen.

## ANSI KEYBOARD FEATURES AND CODES

In this section the features and functions available at the keyboard when in the ANSI terminal emulation mode are described. Also contained are the codes generated by the keyboard entries. A general description of the types of keys present on the keyboard is contained in Chapter 3.

The programmable function keys are described in Chapter 5.

### Keyboard Features

In addition to the common functions available from the keyboard such as TAB, BACKSPACE, etc., which are described in Chapter 2, there are other features available. These features allow the operator to control terminal operating parameters without entering the Set-Up mode. Some of these features are intended for use by programmers or maintenance personnel.

#### SMOOTH SCROLL RATE

<CTRL-SHIFT-↑> will increment the smooth scroll rate until the terminal reaches the jump scroll mode. <CTRL-SHIFT-↓> will decrease the scroll rate until the slowest rate is reached.

#### ANSWERBACK MESSAGE

The answerback message is sent to the host whenever the BREAK key is pressed.

#### BACKTAB

A backtab sequence, ESC[Z, is produced when the <SHIFT-TAB> keys are pressed.

#### PAGE SEND

The numeric keypad <SHIFT-ENTER> key performs the same function as the Auxiliary Port Control <CTRL-PF1>. This control transmits the entire screen to the AUX port. If the Cursor Origin mode is set only the data within the margins is transmitted.

#### HOME CURSOR

The <CLEAR HOME> key when pressed alone will cause the cursor to move to the home position, row 1 column 1. The <SHIFT-CLEAR HOME> sequence will cause the cursor to move to the home position and will also clear the display screen.

## ANSI APPLICATION

### CODES GENERATED AT THE TERMINAL

The ASCII codes that are generated from the keyboard with the use of the CTRL key are listed in the following table. These codes are presented in the same order that they appear in the ASCII code chart. Appendix D contains a summary of these codes.

ASCII mnemonics and ASCII definitions are taken from ANSI standard X3.4-1977.

Either the lowercase (unshifted) or uppercase (shifted) letter will produce the indicated code when pressed with the CTRL key.

There are dedicated function keys that also produce control codes, for example, the ESC, TAB, SPACE, RETURN, etc.. Some of these key codes can be altered in Set-Up mode or by the Host. Refer to the following section in this chapter for keyboard generated codes.

## ANSI APPLICATION

## KEYBOARD GENERATED ASCII CONTROL CODES

ASCII MNEMONIC	HEX CODE	KEY	ASCII DEFINITION
NUL	00	@	Null
SOH	01	A	Start of Heading
STX	02	B	Start of Text
ETX	03	C	End of Text
EOT	04	D	End of Transmission
ENQ	05	E	Enquiry
ACK	06	F	Acknowledge
BEL	07	G	Bell
BS	08	H	Backspace
HT	09	I	Horizontal Tabulation
LF	0A	J	Line Feed
VT	0B	K	Vertical Tabulation
FF	0C	L	Form Feed
CR	0D	M	Carriage Return
SO	0E	N	Shift Out
SI	0F	O	Shift In
DLE	10	P	Data Link Escape
DC1 (XON)	11	Q	Device Control 1
DC2	12	R	Device Control 2
DC3 (XOFF)	13	S	Device Control 3
DC4	14	T	Device Control 4
NAK	15	U	Negative Acknowledge
SYN	16	V	Synchronous Idle
ETB	17	W	End of Transmission Block
CAN	18	X	Cancel
EM	19	Y	End of medium
SUB	1A	Z	Substitute
ESC	1B	{ or [	Escape
FS	1C	or \	File Separator
GS	1D	} or ]	Group Separator
RS	1E	~	Record Separator
US	1F	_	Unit Separator
DEL	7F	DELETE	Delete

## ANSI APPLICATION

### CURSOR POSITIONING KEYS

The four keys which control cursor movement generate control sequences which are transmitted to the host. When the host sends the signals back, the corresponding cursor action occurs. The following table lists the codes generated.

Cursor Key Control Sequences

Cursor Key (Arrow)	ANSI Mode in Normal Key Mode	ANSI Mode in Appl. Key Mode	VT52 Mode
↑ Up	ESC [A	ESC OA	ESC A
↓ Down	ESC [B	ESC OB	ESC B
→ Right	ESC [C	ESC OC	ESC C
← Left	ESC [D	ESC OD	ESC D

## ANSI APPLICATION

### NUMERIC KEYPAD

The numeric keypad generates codes for numerals, a decimal point, minus sign, and comma. The ENTER key transmits the same codes as the RETURN key.

If the host computer must distinguish between the numeric keypad and main keyboard, the terminal can be placed in a Keypad Application mode by the host with the escape sequence ESC =. In the Keypad Application mode the keys transmit control sequences which can be used by the host as user-defined functions. The following table lists the codes/code sequences generated in the Keypad Numeric/Application modes for both ANSI and VT52 modes of operation.

To enter the Hex Keypad Numeric mode in both ANSI and VT52 modes, select the 'Hex Numpad' parameter in the 'Keyboard 3' menu. In ANSI mode, Hex Keypad Numeric mode may be invoked through an escape sequence: ESC[>3h. (See 'Terminal Mode Controls' later in this chapter.)

A fourth numeric Keypad Application mode exists when using the bidirectional auxiliary port. The command structure for this port is listed in the following 'AUXILIARY PORT CONTROLS' section.

Numeric Keypad Generated Codes

Key	ANSI Normal Keypad Numeric Mode	ANSI Hex Keypad Numeric Mode	ANSI Keypad Application Mode	VT52 Normal Keypad Numeric Mode	VT52 Hex Keypad Numeric Mode	VT52 Keypad Application Mode
0	0	0	ESC Op	0	0	ESC ?p
1	1	1	ESC Oq	1	1	ESC ?q
2	2	2	ESC Or	2	2	ESC ?r
3	3	3	ESC Os	3	3	ESC ?s
4	4	4	ESC Ot	4	4	ESC ?t
5	5	5	ESC Ou	5	5	ESC ?u
6	6	6	ESC Ov	6	6	ESC ?v
7	7	7	ESC Ow	7	7	ESC ?w
8	8	8	ESC Ox	8	8	ESC ?x
9	9	9	ESC Oy	9	9	ESC ?y
PF1	ESC OP	A	ESC OP	ESC P	A	ESC P
PF2	ESC OQ	B	ESC OQ	ESC Q	B	ESC Q
PF3	ESC OR	C	ESC OR	ESC R	C	ESC R
PF4	ESC OS	D	ESC OS	ESC S	D	ESC S
MINUS	MINUS	E	ESC Om	MINUS	E	ESC ?m
COMMA	COMMA	F	ESC Ol	COMMA	F	ESC ?l
PERIOD	PERIOD	PERIOD	ESC On	PERIOD	PERIOD	ESC ?n
ENTER	RETURN	RETURN	ESC Om	RETURN	RETURN	ESC ?M



## ANSI APPLICATION

### AUXILIARY PORT CONTROLS

In the ANSI emulation mode, the four editing keys on the numeric keypad generate the escape sequences listed in the table above. The keys are also used in conjunction with the <SHIFT> and <CTRL> keys to perform the following auxiliary port functions. These functions place the terminal in various modes in which data can be sent to the display, auxiliary port, and COMM port at the same time.

- ▶ **Line Send**                                   <SHIFT-PF1>  
      Transmits the line that the cursor is on to the AUX port.
  
- ▶ **Page Send**                                 <CTRL-PF1>  
      Transmits the entire screen to the AUX port. If the Cursor Origin mode is set, only the data within the margins is transmitted.
  
- ▶ **Keyboard Auxiliary Mode**                 <SHIFT-PF2>  
      Data entered at the keyboard is sent to AUX port instead of to the COMM port. Resets the Keyboard COMM Mode <SHIFT-PF3>.
  
- ▶ **Keyboard COMM Mode**                     <SHIFT-PF3>  
      Data entered at the keyboard is sent to the COMM port. Resets the Keyboard Auxiliary Mode <SHIFT-PF2>.
  
- ▶ **Auto Auxiliary Mode**                    <CTRL-PF2>  
      Transmits the current line to the AUX port when a line feed is received from the COMM port, the AUX port, or the keyboard.
  
- ▶ **Auxiliary Control Mode**                 <CTRL-PF3>  
      Data received from the AUX port or the COMM port is transmitted to the AUX port without being displayed.
  
- ▶ **Auxiliary Output Disable**               <SHIFT-PF4>  
      Disables any mode which transmits data to the AUX port, except the Keyboard Auxiliary Mode <SHIFT-PF2>.

## ANSI APPLICATION

- ▶ **Concurrent Auxiliary Mode**      <CTRL-PF4>  
Data received from the AUX port or the COMM port is sent to the AUX port and displayed on the screen.
  
- ▶ **Auxiliary to COMM Mode**      <SHIFT-CTRL-PF2>  
Data received from the AUX port is sent to the COMM port. This function can be performed concurrently with the Auxiliary to Display Mode <SHIFT-CTRL-PF3>.
  
- ▶ **Auxiliary to Display Mode**      <SHIFT-CTRL-PF3>  
Data received from the AUX port is displayed on the screen. This function can be performed concurrently with the Auxiliary to COMM Mode <SHIFT-CTRL-PF2>.
  
- ▶ **Input Disable**      <SHIFT-CTRL-PF4>  
Disables the Auxiliary to COMM Mode <SHIFT-CTRL-PF2> and the Auxiliary to Display Mode <SHIFT-CTRL-PF3>.
  
- ▶ **Print Screen**      <SHIFT-ENTER>  
Initiates a print screen operation.
  
- ▶ **Auto Print**      <CTRL-ENTER>  
Toggles auto print operation.

## ANSI APPLICATION

### ANSI CONTROL SEQUENCES

#### VT100 Compatible Control Sequences

In ANSI mode, the CIT101XL is compatible with the CIT-101e with enhancements. There are two sub-emulations in this mode: VT100 and VT52. Control sequences are divided according to whether they are VT100 or VT52 compatible. Also listed under the VT100 compatible sequences are CIET private sequences which are normally not available on a VT100 type terminal.

The basic elements of the ANSI mode, VT100 control sequences are defined as follows:

**Control Sequence (or Escape Sequence)** - A sequence of characters that is used for control purposes to perform a function. It begins with the control code ESC and contains a single parameter or a parameter string.

**Control Code: ESC** - A character used to indicate that the succeeding character or characters are interpreted as functions to be performed.

**Parameter** - A number (a string of decimal digits) representing a single value (i.e., a decimal number). Leading zeros are ignored. The decimal digits are sent in the ASCII representation, 0 (30H) through 9 (39H). Parameter also means the value so represented.

**Numeric Parameter** - A parameter that represents a number designated by Pn, for instance, the number of positions to move the cursor in a certain direction.

**Selective Parameter** - A parameter that selects one function from a group of functions, designated by Ps. In general, a control sequence with multiple selective parameters has the same effect as multiple control sequences, each with one selective parameter, e.g., ESC Psa;Psb;Psc F acts identically to ESC Psa F; ESC Psb F; ESC Psc F.

**Parameter String** - A string of parameters separated by a semicolon (3BH).

**Default** - The value that is automatically given to a parameter when none is specified, or when zero is specified.

**Final Character** - The character that signals the end of an escape or control sequence.

## ANSI APPLICATION

An example of a valid control sequence is:

<b>ESC #3</b>	Changes line to top half of double-height, double-width
<b>ESC</b>	Control Code, (Hex 1B)
<b>#</b>	An intermediate character, (Hex 23)
<b>3</b>	Final character, (Hex 33)

A second example is:

<b>ESC [0;2;5v</b>	Change cursor to visible blinking underline
<b>ESC</b>	Control Code, (Hex 1B)
<b>[</b>	An intermediate character, (Hex 5B)
<b>0;2;5</b>	Selective parameters (Ps), (Hex 30, 3B, 32, 3B and 35) where the ";" is a delimiter
<b>v</b>	Final character, (Hex 76)

The control sequences defined below are valid only when the CIT101XL is in ANSI, VT100 mode. Unless otherwise noted, actions described are taken in response to receipt of the indicated control sequence.

Parameters are either numeric (Pn) or selective (Ps). If a parameter position in a control sequence is left blank or specified as 0, the default is used.

## ANSI APPLICATION

### CURSOR CONTROL SEQUENCES

The CIT101XL supports a variety of powerful cursor commands that position the cursor, scroll the display up and down, and select a variety of cursor styles.

#### Relative Cursor Positioning

Move cursor up	ESC[PnA
Move cursor down	ESC[PnB
Move cursor right (forward)	ESC[PnC
Move cursor left (backward)	ESC[PnD

Pn is the number of rows or columns to move the cursor. The default is 1. If no value for Pn is entered, the cursor moves by 1 row or 1 column, as appropriate. When the cursor reaches any margin (left, right, top, or bottom) it stops there.

#### Next Line

Move cursor down to line Pn	ESC[PnE
-----------------------------	---------

Moves the cursor to the first column position Pn lines down.

#### Previous Line

Move cursor up to line Pn	ESC[PnF
---------------------------	---------

Moves the cursor to the first column position Pn lines up.

#### Cursor Horizontal Absolute

Cursor Horizontal Absolute	ESC[PnG
----------------------------	---------

Moves the cursor forward or backward along the active line to the character position specified by Pn. A value of 0 or 1 moves the cursor to the first character position of the active line. A parameter value (Pn) moves the cursor to character position (Pn) on the active line.

**CURSOR CONTROL SEQUENCES (Continued)****Direct Cursor Positioning**

Position cursor	ESC[Pn;PnH or ESC[Pn;Pnf
-----------------	--------------------------------

Directly positions the cursor at the location given. The first Pn specifies row number and the second Pn specifies column number where the cursor is to be positioned. Default values are 1.

**Scroll Direction**

Index	ESCD
Reverse Index	ESCM

Index moves the cursor down one line without changing the column position. Reverse Index moves the cursor up without changing the column position. These moves cause scrolling when the top or bottom margins are encountered.

**Save and Restore Cursor and Attributes**

Save cursor and attributes	ESC7
Restore cursor and attributes	ESC8

Saves the cursor position, type, and attributes, or restores previously saved cursor and attributes.

**New Line**

New Line	ESCE
----------	------

Moves the cursor to the first position on the next line down. If the bottom margin is encountered, the display scrolls.

**Cursor Attributes**

Cursor Attributes	ESC[PsV
Cursor is visible	Ps = 0
Cursor is invisible	1
Cursor is an underline	2
Cursor is a reverse video block	3
Non-blinking cursor	4
Blinking cursor	5

If no value for Ps is entered the default value is 0 and the cursor becomes visible.

## ANSI APPLICATION

### ERASE CONTROL SEQUENCES

A variety of erase commands are provided by ANSI. With them you can erase from the cursor to the beginning or end of the current line or entire display or scrolling region. A second group of erase commands can erase a rectangular window spanning a single line (or column) or the entire display.

#### Set Erase Character

Set Erase Character ESC[>Pns

Selects a specific character (Pn = decimal value of the character) used to erase fields. The default value is a space.

#### Erase Character(s)

Erase Character ESC[PnX

Erases the character at the active position and other following characters, according to the parameter (Pn). The active position is unchanged. A numeric parameter of 0 or 1 indicates that one character is erased. A numeric parameter (Pn) indicates that (Pn) characters are erased.

#### Erase Within Display

Erase within display ESC[PsJ

From cursor to end of display	Ps = 0 (Default)
From start of display to cursor	1
Entire display	2

If no value is entered the display is erased from the cursor to the end of the screen. If the appropriate bit is set in Set-Up Mode, the display is erased only to the appropriate margin instead of the display limit.

**ERASE CONTROL SEQUENCES (Continued)****Erase Window**

Erase Window	<b>ESC[&gt;3;rt;cl;rb;crJ</b>
	rt = top row
	cl = left column
	rb = bottom row
	cr = right column

Erases a portion of the display within the window specified by the above parameters.

**Erase Within Line**

Erase within line	<b>ESC[PsK</b>
From cursor to end of line	Ps = 0 (Default)
From start of line to cursor	1
Entire line	2

If no value is entered, the line is erased from the cursor to the end of the line.

**Erase Window Line**

Erase portion of line	<b>ESC[&gt;3;cl;crK</b>
	cl = left column
	cr = right column

Erases on the line containing the cursor that portion within boundaries specified by the cl and cr parameters.



## ANSI APPLICATION

### WIDTH/HEIGHT LINE COMMANDS

These commands select double- or single-height and double- or single-width characters on a line at a time basis. Note that double-width decreases the number of characters on a line by 50%.

Double-height, double-width (top)	ESC#3
Double-height, double-width (bottom)	ESC#4
Single-height, single-width (normal)	ESC#5
Single-height, double-width	ESC#6
Double-height, single-width (top)	ESC#:
Double-height, single-width (bottom)	ESC#;

These commands change the line the cursor is on to the indicated format. Full double-height characters require that the line data be given twice, once with a "top" command and once with a "bottom" command.

Unless erase RH or DW line bit is set to preserve in Set-Up mode, changing a line to double-width will erase the right half of the line.

### VIDEO ATTRIBUTE COMMANDS

Set video attributes	ESC[Psm
Normal (no attributes)	Ps = 0 (Default)
Bold	1
Underline	4
Blinking	5
Reverse video	7

If no value is entered, all characters received are normal video with no other attributes set. The current attribute settings apply to all succeeding characters displayed until new attributes are set.

**SCROLL CONTROL**

A set of commands is available that affects the size of the scrolling region and the rate at which smooth scrolling occurs.

**Set Scrolling Region**

Set scrolling region ESC[Pn;Pnr

The first parameter value is the top margin and the second is the bottom margin. The default is the entire screen. Note that the top display line is designated Line 1.

**Set Smooth Scroll Rate**

Set smooth scroll rate ESC[Pnu

Pn is a number that determines how long it will take for one scan line to scroll on the display when the smooth scroll feature is activated. Valid Pn entries are 0 to 7, where 0 is the fastest rate of scrolling and 7 is the slowest. (See 'Terminal Mode Controls' later in this chapter for additional scrolling sequences.)

**Scroll Up**

Scroll display up ESC[PnS

Causes the entire contents of the visible screen to be moved up. The first line is removed and a line is inserted at the bottom of the display for each line moved. The number of lines moved is determined by the value of Pn. A value of 0 or 1 moves the contents of the screen up one line.

**Scroll Down**

Scroll display down ESC[PnT

Causes the entire contents of the visible screen to be moved down. For each line moved, the bottom line is removed and a new line is added to the top. The number of lines moved is determined by the value of Pn. A value of 0 or 1 moves the contents of the screen down one line.

## ANSI APPLICATION

### TAB CONTROLS

TAB STOP(s) may be individually set or cleared at the current cursor position, cleared altogether, or added to every eighth column (DEC standard).

Set TAB STOP at current column	ESCH
Set or clear TAB STOP(s)	ESC[Psq
Clear TAB STOP at current column	Ps = 0
Clear all TAB STOPS	3
Set TAB STOPS at every 8th column	>5

The default value is 0. If no value is entered, the tab is cleared at the current column position. Note that the symbol ">" is to be taken literally as Hex value 3E and not as the "greater than" symbol.

#### Horizontal Tab

Horizontal Tab ESC[PnI

Moves the active position to the next horizontal tab stop or to the right margin.

#### Horizontal Backtab

Horizontal Backtab ESC[PnZ

Moves the active position to the previous tab stop or to the left margin.

**EDITING COMMANDS**

Editing sequences are used to insert and delete characters and lines of characters.

**Insert/Delete Line**

Insert Line	ESC[PnL
Delete Line	ESC[PnM

The insert sequence inserts Pn line(s) starting at the active position. Lines moved below the bottom margins are lost. The cursor moves to column one.

The delete sequence deletes Pn line(s) starting at the active position. Subsequent lines are moved up and a blank line is added at the bottom for each line removed. The cursor moves to column one.

**Insert/Delete Character**

Insert character	ESC[Pn@
Delete character	ESC[PnP

The insert character command adds Pn blank spaces of the current visual attributes at the cursor position. Data on the line shifts to the right starting at the cursor position. Any characters that go beyond the right margin are lost. A Pn value of 0 or 1 adds one blank character. If Pn is not entered, a value of 1 is assumed.

The delete character command deletes Pn characters, starting at the cursor position. The characters to the right of the cursor shift to the left, and a space is inserted at the right margin for each character that is deleted. A Pn value of 0 or 1 deletes one blank character. If Pn is not entered, a value of 1 is assumed.

## ANSI APPLICATION

### TERMINAL MODE CONTROLS

A variety of features are present that offer the user a choice of one of two states. These two state features are called modes and have a "set" or asserted state and a "reset" or base state.

For some modes the set state turns a feature on, and the reset turns it off. In other cases, both settings turn on different features.

**NOTE:** The last character in all of the reset modes listed in this section is a lower case letter "l" (Hex value 6C).

#### VT52/VT100-Style Scroll Key Modes

Set to VT52-Style Scroll Key Mode           ESC[>2h  
Reset to VT100-Style Scroll Key Mode       ESC[>2l

In the set state, when pressed, the <NO SCROLL> key adds one line of data to the display. When pressed simultaneously with the SHIFT key, a full page of data scrolls on the screen (a total of 24 lines). This mode is operable when Hold Screen mode is set.

In the reset state, data scrolling on the screen is halted (XOFF) when the <NO SCROLL> key is pressed. Data resumes scrolling (XON) when the <NO SCROLL> key is pressed a second time.

#### Character Insert/Replace Mode

Set Insert mode                               ESC[4h  
Reset Replace mode                            ESC[4l

When insert mode is set, characters are added to the line at the cursor position with remaining characters shifted right. Any characters shifted into the margin are lost. When reset, the added characters replace the character at the cursor position.

#### Newline Mode

Set Newline mode                             ESC[20h  
Reset to Line Feed mode                     ESC[20l

When Newline mode is in the set state and a line feed is received, the active position is moved to the first position on the next line. The RETURN key generates a carriage return followed by a line feed each time it is pressed. When Newline mode is reset and a line feed is received, the active position is moved to the next line but stays in the same column position.

**Cursor Key Application Mode**

Set Cursor Key Application mode	ESC[?1h
Reset Cursor Key Application mode	ESC[?1l

This mode is effective only when the terminal is in ANSI mode (i.e., ESC[?2h has been sent). With Cursor Key Application mode set, the four cursor control keys send special user interpretable functions such as ESC OA. If Cursor Key Application mode is reset the function keys send ANSI cursor control commands such as ESC [A.

**ANSI/VT52 Modes**

Set to ANSI mode	ESC[?2h
Set to ANSI mode (from VT52 mode)	ESC<
Reset to VT52 mode	ESC[?2l

In the set state only ANSI compatible sequences are recognized. In the reset state only VT52 sequences are recognized.

**80/132 Column Modes**

Set to 132 Column mode	ESC[?3h
Reset to 80 Column mode	ESC[?3l

In the set state the screen displays 132 columns. In the reset state the screen displays 80 columns.

**Smooth/Jump Scroll Modes**

Set to Smooth Scroll mode	ESC[?4h
Reset to Jump Scroll mode	ESC[?4l

In the set state the display scrolls smoothly at a maximum rate of six lines per second if Normal Speed Smooth Scroll is set, and twelve lines per second if Double Speed Smooth Scroll is set. In the reset state the scroll jumps instantaneously.

## ANSI APPLICATION

### Reverse/Normal Screen Mode

Set to Reverse Screen mode	ESC[?5h
Reset to Normal Screen mode	ESC[?5l

In the set state the screen is reversed, showing dark characters on a light background. In the reset state the screen shows light characters on a dark background. These conditions may be locally reversed under the cursor or where character attributes are other than normal.

### Cursor Origin Mode

Set Cursor Origin mode	ESC[?6h
Reset Cursor Origin mode	ESC[?6l

In the set state the cursor Home position is the upper left character position within set margins. Screen addresses are relative to that position as the origin (row 1, column 1).

In the reset state the cursor Home position is the upper left character position of the display, regardless of where margins are set.

### Auto Wraparound Mode

Set Auto Wraparound mode	ESC[?7h
Reset Auto Wraparound mode	ESC[?7l

In the set state, any characters received when the cursor is at the right margin are moved to the start of the next line. A scroll is performed if necessary and allowed. In the reset state, any characters received when the cursor is at the right margin replace characters at that position.

### Auto Repeat Mode

Set Auto Repeat mode	ESC[?8h
Reset Auto Repeat mode	ESC[?8l

In the set state, any key (except SET-UP, ESC, and CTRL with any key) when held down for more than 1/2 second repeats at the rate of about 30 characters per second. In the reset state no keys repeat.

**Form Feed Mode**

Set Form Feed    ESC[?18h  
Reset Form Feed   ESC[?18l

When set, the form feed (FF) character is selected as the print termination character. When reset, there is no print termination character.

**Print Extent Mode**

Set Extent mode                                        ESC[?19h  
Reset Extent mode                                     ESC[?19l

When set, the entire screen is printed during a print screen operation. When reset, only the defined scrolling region is printed.

**Double Speed Smooth Scroll Mode**

Set Double Speed Smooth Scroll                    ESC[>1h  
Reset to Normal Speed Smooth Scroll             ESC[>1l

In the set state Smooth Scroll occurs at double the normal rate. In the reset state Smooth Scroll occurs at the same rate as at power-up.

**Hex Keypad Numeric Mode**

Set Hex Keypad Numeric mode                     ESC[>3h  
Reset to Normal Keypad Numeric mode            ESC[>3l

In the set state, the numeric keypad generates hexadecimal characters from 0 through F. The keypad must be in Numeric Mode. The characters A to F are generated by the following keys:

<u>Key</u>	<u>Character</u>
PF1	A
PF2	B
PF3	C
PF4	D
- (MINUS)	E
, (COMMA)	F

In the reset state with the keypad in Numeric mode, the keypad generates the normal decimal characters 0 through 9 as in the set state. However, PF1 through PF4 generate control sequences; and MINUS and COMMA generate their respective normal characters.



## ANSI APPLICATION

### Keypad Application Mode

Enter Keypad Application mode                   ESC=  
Enter Keypad Numeric mode                   ESC>

In Keypad Application mode, the numeric keypad transmits the appropriate ANSI or VT52 mode control sequences as selected. In Keypad Numeric mode, the keypad transmits ASCII values, determined by the user's choice of normal keypad mode, or hexadecimal keypad mode as indicated above.

### Clear Display/line Feed On Form Feed Mode

Set Clear Display on LINE FEED mode           ESC[>4h  
Reset to Normal LINE FEED function mode    ESC[>4l

In the set state, any form feed received clears the display or scrolling region (as set elsewhere). In the reset state, a form feed performs the line feed function.

### Disable Incoming XOFF Mode

Set Disable Incoming XOFF mode               ESC[>6h  
Reset Process Incoming XOFF mode           ESC[>6l

In the set state, the keyboard ignores XOFF (CTRL S) received from the COMM Port. In the reset state, the keyboard lights the Keyboard Locked indicator on the status line and ceases further transmission via the active output port until an XON (CTRL Q) is received.

### Screen Width Change Erase Mode

Set Screen Width Change Erase mode           ESC[>9h  
Reset Screen Width Change Preserve mode    ESC[>9l

In the set state, data beyond the 80th column (single-width characters) are erased whenever the display is switched from 132 Column Mode to 80 Column Mode or vice versa (DEC compatible). In the reset state, data beyond the 80th column (single-width characters) is preserved on such changes.

**Right Half Of Double-width Lines Erase Mode**

Set RH of DW Lines Erase mode	ESC[>10h
Reset to RH of DW Lines Preserve mode	ESC[>10l

In the set state, the right side (off screen) portion of double-width lines are not preserved if the double-width line is converted to single-width (DEC compatible). In the reset state, the right-most characters are preserved on such a transformation.

**Erase Page Extent Mode**

Set Erase Page Within Margins	ESC[>11h
Reset Erase Entire Display	ESC[>11l

In the set state, a page erase or display clear command erases only the scrolling region. In the reset state, the entire display is erased.

**Tab Motion Spaces/Direct Modes**

Set Tab Motion With Spaces mode	ESC[>12h
Reset Tab Motion Direct	ESC[>12l

In the set state, tab commands fill in space characters between the beginning cursor position and the tabbed to position. In the reset state, tab commands are executed by immediate movement of the cursor to the appropriate column, with no change to any characters in intervening columns.

**CRT Save Mode**

Set CRT Saver mode	ESC[>13h
Reset CRT Saver mode	ESC[>13l

In the set state, the CRT Saver is engaged, causing the screen display to turn off if no characters are typed or received through any active input port over an extended time period. Receipt or typing of any such characters automatically restores the display brightness to its previous level. In the reset state, the CRT Saver is disengaged.

## ANSI APPLICATION

### Half Duplex/Full Duplex Modes

Set Half Duplex mode	ESC[>14h
Reset Full Duplex mode	ESC[>14l

In the set state, the terminal is configured for half duplex (local echo). In the reset state, full duplex is used.

### Eraser Attributes Clear/Cursor

Cursor	ESC[>201h
Clear	ESC[>201l

Selects whether attributes are cleared or filled with the cursor value.

### Erase Attributes

Enable	ESC[>202h
Disable	ESC[>202l

Enables or disables erasure of attributes when in erase mode.

### Erase Characters

Enable	ESC[>203h
Disable	ESC[>203l

Enables or disables erasure of characters when in erase mode.

**AUXILIARY PORT CONTROL COMMANDS**

The CIT101XL printing functions are selectable by the following control sequences.

**Print Screen**

Print Screen ESC[i

Prints the entire screen as defined by the Print Extent mode.

**Print Cursor Line**

Print Cursor Line ESC[?1i

Prints the line the active position is on. The active position does not move.

**Auto Print**

Auto Print On ESC[?5i  
Auto Print Off ESC[?4i

When Auto Print is ON, a line on the screen is printed when the cursor moves to the next line. The cursor moves off the line by an LF, FF, or VT. During autowrap mode, the line is also printed when ended with a CR, LF. The control used to move the cursor to the next line is also transmitted.

**Print Controller**

Print Controller On ESC[5i  
Print Controller Off ESC[4i

When Print Controller is ON, the host computer has direct control of the printer. All characters received by the terminal are printed without appearing on the display.

## ANSI APPLICATION

### Auxiliary Port Control

These commands perform the same control functions described on page 6-8 using the four PF keys on the numeric keypad.

- ▶ **Line Send** **ESC#2**  
Transmits the line that the cursor is on to the AUX port.
- ▶ **Page Send** **ESC#7**  
Transmits the entire screen to the AUX port. If the Cursor Origin mode is set, only the data within the margins is transmitted.
- ▶ **Keyboard Auxiliary Mode** **ESC[1z**  
Data entered at the keyboard is sent to AUX port instead of to the COMM port. Resets the Keyboard COMM Mode **ESC[0z**.
- ▶ **Keyboard COMM Mode** **ESC[0z**  
Data entered at the keyboard is sent to the COMM port. Resets the Keyboard Auxiliary Mode **ESC[1z**.
- ▶ **Auto Auxiliary Mode** **ESC#0**  
Transmits the current line to the AUX port when a line feed is received from the COMM port, the AUX port, or the keyboard.
- ▶ **Auxiliary Control Mode** **ESC1**  
Data received from the AUX port or the COMM port is transmitted to the AUX port without being displayed.
- ▶ **Auxiliary Output Disable** **ESC2**  
Disables any mode which transmits data to the AUX port, except the Keyboard Auxiliary Mode **ESC[1z**.
- ▶ **Concurrent Auxiliary Mode** **ESC0**  
Data received from the AUX port or the COMM port is sent to the AUX port and displayed on the screen.
- ▶ **Auxiliary to COMM Mode** **ESC[2z**  
Data received from the AUX port is sent to the COMM port. This function can be performed concurrently with the Auxiliary to Display Mode **ESC[3z**.

**Auxiliary Port Control (Continued)**

- ▶ **Auxiliary to Display Mode** **ESC[3z**  
Data received from the AUX port is displayed on the screen. This function can be performed concurrently with the Auxiliary to COMM Mode ESC[2z.
- ▶ **Input Disable** **ESC[4z**  
Disables the Auxiliary to COMM Mode ESC[2z and the Auxiliary to Display Mode ESC[3z.
- ▶ **Clear Auxiliary Port Output buffer** **ESC[5z**  
Any data present in the auxiliary port output buffer is cleared.
- ▶ **Exit Auto Auxiliary or Concurrent Auxiliary Modes** **ESC#1**  
The auto auxiliary or the concurrent print modes are exited.

## ANSI APPLICATION

### 25TH ROW STATUS LINE

The terminal supports a status line displayed in the 25th line position of the screen. The left half of the status line is referred to as the terminal status line, and the right half as the host status line.

To enable the 25th row status line feature, select 'Status On' in the Display 1 Set-Up menu.

The Terminal Status Line indicates current terminal mode selections as follows:

```
      Caps OnLine Locked L1 L2 L3 L4
      Local
```

The Host Status Line is utilized for host messages sent to the terminal, and is written to using the following Device Control String:

```
ESC [ Q <text> ESC \
```

where:

ESC [ is the ANSI Command String Introducer.

Q is the ANSI Command String Terminator.

<text> is the ASCII text to write to the Host Status Line. Normal 7-bit ASCII characters are all valid. Control codes will be executed if received.

ESC \ is the ANSI String Terminator.

- NOTES:
- Parameters are invalid in this string and will abort the command decode and print to the screen.
  - The Host Status Line field length is determined by the terminal column mode, writing 46 characters in 80 column mode and 98 characters in 132 column mode.
  - If <text> is longer than the currently selected field length, it is written to the last column of the Host Status Line.
  - The command interpretation halts only on receipt of ESC \.

**25TH ROW STATUS LINE (Continued)**

In VT100 emulation mode, both the Terminal and the Host Status Line display attributes are changed through the following DCS string:

**ESC [ > Ps1 ; Ps2 Q**

where:

**ESC [ >** is the Device Control String Introducer.

**Ps1** sets the attribute for the Terminal Status Line:

0 = Normal (Default)  
1 = Reverse video  
2 = Invisible

**Ps2** sets the attribute for the Host Status Line:

0 = Normal (Default)  
1 = Reverse video  
2 = Invisible

**Q** is the Command Terminator.

**LED CONTROL**

THE CIT101XL has four user programmable indicators on the status line labeled L1 through L4. They may be turned on and off through the following command:

Set LED **ESC[Pnq**

LED number **Pn** is turned on; for example, a **Pn** value of 1 turns on L1. If **Pn** is zero, or omitted (default), all LED's are turned off.



## ANSI APPLICATION

### MULTIPLE PAGE FUNCTIONS

#### Next Page

ESC[PnU or ESC[>PnU

Pn Value of 0,1 or none = Go to next page  
2 = Go forward two pages  
3 = Go forward three pages

These sequences display succeeding pages on the screen. If the value of Pn is zero, one, or no value is entered, the next page displays. If a value greater than 2 is entered, page 4 displays. However, if page 4 is currently displayed, then no action occurs.

The active position is placed at the Home position of the newly displayed page unless the private use character '>' is included in the command. When used, the active position remains on the previously displayed page and does not appear on the new page.

Note, however, that when either 'Next Page' command is entered locally, the active position is placed at the Home position of the newly displayed page.

#### Previous Page

ESC[PnV or ESC[>PnV

Pn Value of 0,1 or none = Go to previous page  
2 = Go back two pages  
3 = Go back three pages

These sequences display preceding pages on the screen. If the value of Pn is zero, one, or no value is entered, the preceding page displays. If a value greater than 2 is entered, page 1 displays. However, if page 1 is currently displayed, then no action occurs.

The active position is placed at the Home position of the newly displayed page unless the private use character '>' is included in the command. When used, the active position remains on the previously displayed page and does not appear on the new page.

Note, however, that when either 'Previous Page' command is entered locally, the active position is placed at the Home position of the newly displayed page.

#### Copy Data

ESC[Ps;P1;P2;P3;P4;P5p

Ps = 0 - Copy lines in the forward direction  
1 - Copy lines in the reverse direction  
P1 = Copy from page  
P2 = Copy from line  
P3 = Copy to page  
P4 = Copy to line  
P5 = Number of lines to copy

## ANSI APPLICATION

This sequence causes P5 lines of data on page P1 from line P2 to be copied to page P3 starting on line P4. The Ps parameter determines the direction in which the lines are copied.

For example, to copy 4 lines of data from page 3 (starting at line 2) to page 1 (starting at line 8), and to copy them in the forward direction, the command would be:

```
ESC [ 0;3;2;1;8;4p
```

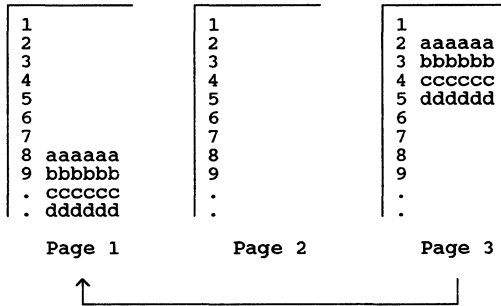

If these lines of data are copied to page 1 in the reverse direction, the data would be copied with the bottom line on line 8, as shown below. Note that any existing data would be replaced with the new data.

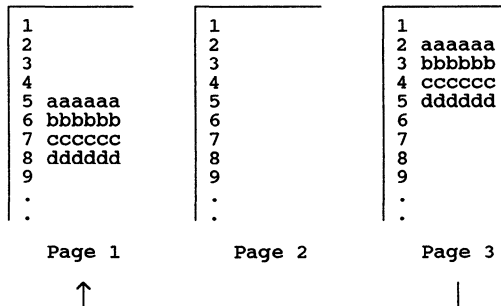

## ANSI APPLICATION

### REPORTS

The host computer can send certain request sequences to the terminal. Each request sequence causes the terminal to send a report to the host. These reports tell the host about terminal parameters and/or terminal status.

#### Terminal Identification

Set identify type	ESC[>Psp
VT102	Ps = 0 (or none)
VT100	1
VT101	2

Sets the response to an inquiry (ESCZ) from the host computer.

Request for Terminal Status	ESC[5n
-----------------------------	--------

Response that terminal is OK	ESC[n or ESC[0n
------------------------------	-----------------------

Response that terminal is not OK	ESC[3n
----------------------------------	--------

Request for Cursor Position	ESC[6n
-----------------------------	--------

Response with cursor position	ESC[Pl:PcR
-------------------------------	------------

where Pl = cursor row number  
Pc = cursor column number

Request Device Attributes	ESC[c or ESC[0c
---------------------------	-----------------------

Response with Attributes	ESC[?1;2c
--------------------------	-----------

Request Printer Status with/without Terminal Identification	ESC[?15n
---	----------

Printer is ready	ESC[?10n
Printer is not ready	ESC[?11n
There is no printer	ESC[?13n
CIT101XL with printer	ESC[?1;11c
CIT101XL without printer	ESC[?1;2c

**NOTE:** See also control sequence ESC[>Pnp,  
Set Identify Type.

## REPORTS (Continued)

## Request for Terminal Parameters

ESC[&lt;sol&gt;x

<u>Parameter</u>	<u>Value</u>	<u>Meaning</u>
<sol>	0 or none	This sequence asks for a report. However, the terminal may send unsolicited reports. For example, an unsolicited report is sent when the terminal exits Set-Up mode.
	1	This sequence asks for a report. The terminal will send reports only when requested (default condition when the terminal is powered on).

## ANSI APPLICATION

### REPORTS (Continued)

#### Terminal Parameter Report

ESC[<sol>;<par>;<nbits>;<xspeed>;<rspeed>;<clkmul>x

<u>Parameter</u>	<u>Value</u>	<u>Meaning</u>
<sol>	2	This message is an unsolicited report.
	3	This message is a report sent on request.
<par>	1	Parity is not set
	4	Parity is odd
	5	Parity is even
<nbits>	1	Serial data characters are 8 bits long.
	2	Serial data characters are 7 bits long.
<xspeed>	32	Transmit rate is 150 Baud
	48	Transmit rate is 300 Baud
	56	Transmit rate is 600 Baud
	64	Transmit rate is 1200 Baud
	88	Transmit rate is 2400 Baud
	104	Transmit rate is 4800 Baud
	112	Transmit rate is 9600 Baud
	120	Transmit rate is 19200 Baud
128	Transmit rate is 38400 Baud	
<rspeed>	32	Receive rate is 150 Baud
	48	Receive rate is 300 Baud
	56	Receive rate is 600 Baud
	64	Receive rate is 1200 Baud
	88	Receive rate is 2400 Baud
	104	Receive rate is 4800 Baud
	112	Receive rate is 9600 Baud
	120	Receive rate is 19200 Baud
128	Receive rate is 38400 Baud	
<clkmul>	1	Bit rate multiplier is 16

**DESIGNATE CHARACTER SET**

The terminal is equipped at the factory with a character set. However, with the use of escape sequences and control keys, you may designate another character set as G0 and G1.

The G0 character set is designated by first entering a Shift In (SI) control code <CTRL-O>. Following this entry, choose the appropriate control sequence from below:

ASCII Character Set	ESC(B
Graphics Character Set	ESC(0

The G1 character set is selected by performing a Shift Out (SO) control code <CTRL-N>. Then choose the appropriate control sequence from below:

ASCII Character Set	ESC)B
Graphics Character Set	ESC)0

The ASCII Character Set conforms to the ISO (International Standards Organization) register of character sets. The Graphics Character Set replaces the characters for ASCII codes 5FH thru 7EH with the characters shown in Appendix C.

**SCREEN ALIGNMENT**

Fill Screen With E's	ESC#8
Fill Screen With Character Assortment	ESC#9

These commands are used for screen alignment and test purposes. The first control sequence fills the screen with uppercase E characters, while the second repeats an assortment of characters utilizing a variety of character attributes.

**KEYCLICK**

Perform Keyclick	ESC#>
------------------	-------

When received, results in one keyclick.

**RESET TERMINAL**

Reset Terminal to Initial Conditions	ESCc
--------------------------------------	------

The terminal is cleared and reset to fixed set-up values. Note that this function takes several seconds to occur and that XON-XOFF is not supported during this operation.

## ANSI APPLICATION

### VT52 MODE CONTROL SEQUENCES

The CIT101XL control sequences defined here are valid in the VT52 mode of operation. Unless otherwise noted, actions described are taken in response to receipt of the indicated control sequence.

#### Cursor Control Sequences

Move cursor up	ESC A
Move cursor down	ESC B
Move cursor right	ESC C
Move cursor left	ESC D

Moves the cursor one row up or down, or one column left or right, as specified. The cursor does not move beyond the margin limits.

Move cursor Home	ESC H
------------------	-------

Moves the cursor to the home position at the upper left corner of the display.

Position cursor	ESC Yrc
-----------------	---------

Positions the cursor to a specified row (r) and column (c). The row and column values are sent in ASCII code plus Hex 1F. For example, row 2, column 2 is Hex 21 (1F + 2), or ESCY!!.

#### Erase Control Sequences

Erase to end of line	ESC K
Erase to end of page	ESC J

Erase the screen from the cursor to the end of the line or page as indicated.

#### Graphics Mode

Enter Special Graphics mode	ESC F
Exit Special Graphics mode	ESC G

Use the Special Graphic Character Set when in graphics mode.

**Keypad Application Mode**

Enter Keypad Application mode	ESC =
Exit Keypad Application mode	ESC >

Use the special applications control sequences from the numeric keypad.

**Bidirectional Auxiliary Port Control**

Enter Concurrent Auxiliary mode	ESC U
Output cursor line to Auxiliary	ESC V
Enter Auxiliary Controller mode	ESC W
Exit Auxiliary Controller mode	ESC X
Output full screen to Auxiliary	ESC ]
Enter Auto Auxiliary mode	ESC ^
Exit Auto Auxiliary mode	ESC _

**Scroll**

Reverse line feed	ESC I
-------------------	-------

Moves the cursor up one row in the same column. If the cursor is at the top margin, a scroll is performed.

**ANSI Mode**

Enter ANSI mode	ESC <
-----------------	-------

Exits VT52 mode and enters ANSI mode.

**Request Identity**

Identify terminal type	ESC Z
Transmit identifier sequence	ESC /Z





## **CHAPTER 7 -- ASCII APPLICATION GUIDE**

---

### **INTRODUCTION**

The CIT101XL terminal is general purpose display terminal which operates in one of the two most commonly used programming standards ASCII or ANSI. The mode of operation is selected in Set-Up mode and is described in Chapter 4.

In the ASCII mode of operation the terminal recognizes codes as defined by the ANSI document X3.4-1977 which defines the American Standard Code for Information Interchange (ASCII).

In the ANSI mode the terminal recognizes ASCII codes and also recognizes control sequences as defined by ANSI document X3.64-1979 "Additional Controls for Use with American National Standard for Information Interchange".

In this chapter application information for the ASCII mode of operation is presented. For application information in the ANSI mode of operation refer to Chapter 6.

In either mode of operation the terminal exchanges information with the host by the use of codes which are defined by the ASCII standard. These codes are categorized as either Graphic character codes or Control character codes.

Graphic character codes represent the letters of the alphabet, numbers, punctuation marks and various other symbols (such as dollar signs, plus signs, and so on). The CIT101XL also has the capability to substitute international character sets for the standard US ASCII character set.

Control character codes represent control functions and are used as instructions to the terminal or host for control functions such as a carriage return, end-of-transmission, introduce a control code sequence (that can include graphic character codes), or other functions common in terminal operations.

This chapter is divided into two sections. The first section of this chapter describes the keyboard operation when in the ASCII emulation mode. In the section the keyboard features and the codes generated from the keyboard are described.

The second section of the chapter describes the ASCII control codes recognized by the terminal. Block graphics are also described in this section.

### HOW INFORMATION IS PRESENTED IN THIS CHAPTER

The ASCII codes in this chapter are presented in the form of ASCII mnemonics. Refer to Appendix C which contains the ASCII code chart and also provides the binary and hexadecimal equivalents for the ASCII mnemonics. For example, the ASCII code for controlling the terminal tone is shown in this chapter and in the ASCII code chart as the ASCII mnemonic BEL. The hexadecimal equivalent is 07H and the decimal equivalent is 7.

In this chapter the key or keys required to generate a control code are indicated by <> brackets. For example the BEL code can be generated from keyboard by pressing <CTRL-G>. A complete listing of the key actions required to produce control codes from the keyboard is contained in the section titled ASCII CODES GENERATED AT THE TERMINAL. Refer to Chapter 3 for a detailed description of the CIT101XL keyboard.

Two types of sequences are presented in this chapter: control code and escape. A control sequence can consist of ASCII control codes, graphic character codes and parameters. Escape sequences contain the ASCII control code ESC (escape) as the introducer to the sequence.

When control or escape sequences are presented in this chapter, the sequence may contain ASCII graphic characters in addition to ASCII mnemonics. The codes for this characters can also be found in the ASCII code chart.

Two types of parameters are contained in this section and are noted as Ps or Pn. Ps refers to selective parameter that selects a specified function from one of several available to a control or escape sequence. Pn refers to numeric parameter which indicates a numeric value. For example, a specific row or column on the display screen.

## ASCII APPLICATION

### ASCII KEYBOARD FEATURES AND CODES

In this section the features and functions available at the keyboard when in the ASCII terminal emulation mode are described. Also contained are the codes generated by the keyboard entries. A general description of the keyboard and the different types of keys present on the keyboard is contained in Chapter 3.

The programmable function keys are described in Chapter 4.

### KEYBOARD FEATURES

In addition to the common functions available from the keyboard such as TAB, BACKSPACE, etc., which are described in Chapter 3, there are other features available. These features allow the operator to control the terminal operating parameters without entering Set-Up mode. Some of these features are intended for use by programmers or maintenance personnel.

**MONITOR MODE** -- <CTRL-SHIFT-1> will toggle the terminal monitor mode. The <1> key on the numeric keypad must be used in this key sequence.

**SMOOTH SCROLL RATE** -- <CTRL-SHIFT-↑> will increment the smooth scroll rate until the terminal reaches the jump scroll mode. <CTRL-SHIFT-↓> will decrease the scroll rate until the slowest rate is reached.

**KEYCLICK MODE** -- <SHIFT-ENTER> or <CTRL-SHIFT-ENTER> will toggle the keyclick mode.

**KEYBOARD UNLOCK** -- Either the <SET-UP> key alone or <CTRL-SET-UP> will unlock the keyboard and disable all printer pass through modes.

**DUPLEX TO BLOCK MODE TOGGLE** -- <SHIFT-BREAK> OR <CTRL-SHIFT-BREAK> will place the terminal in the block (BLK) communication mode from the full duplex (FDX) or half duplex (HDX) communication mode.

**PRINTER PASS THROUGH MODE** -- <CTRL-SHIFT-PRINT SEND> will toggle the printer pass through mode on and off.

### ASCII CONTROL CODE GENERATION

The table on the following page lists the ASCII codes that can be generated from the keyboard with the use of the CTRL key. These codes are presented in the same order that they appear in ASCII code chart. Also included is the symbol that can be displayed on the terminal screen.

## ASCII APPLICATION

### KEYBOARD GENERATED ASCII CONTROL CODES

ASCII MNEMONIC	HEX CODE	KEY	ASCII DEFINITION	SCREEN DISPLAY
NUL	00	@	Null	(blank)
SOH	01	A	Start of Heading	SH
STX	02	B	Start of Text	SX
ETX	03	C	End of Text	EX
EOT	04	D	End of Transmission	EX
ENQ	05	E	Enquiry	EQ
ACK	06	F	Acknowledge	AK
BEL	07	G	Bell	BL
BS	08	H	Backspace	BS
HT	09	I	Horizontal Tabulation	HT
LF	0A	J	Line Feed	LF
VT	0B	K	Vertical Tabulation	VT
FF	0C	L	Form Feed	FF
CR	0D	M	Carriage Return	CR
SO	0E	N	Shift Out	SO
SI	0F	O	Shift In	SI
DLE	10	P	Data Link Escape	T L
DC1 (XON)	11	Q	Device Control 1	r L
DC2	12	R	Device Control 2	r
DC3 (XOFF)	13	S	Device Control 3	r
DC4	14	T	Device Control 4	r
NAK	15	U	Negative Acknowledge	J
SYN	16	V	Synchronous Idle	
ETB	17	W	End of Transmission Block	■
CAN	18	X	Cancel	+
EM	19	Y	End of medium	↓
SUB	1A	Z	Substitute	-
ESC	1B	{ or [	Escape	■
FS	1C	or \	File Separator	=
GS	1D	} or ]	Group Separator	↓
RS	1E	~	Record Separator	
US	1F		Unit Separator	■
DEL	7F	DELETE	Delete	■

#### NOTES:

1. ASCII mnemonics and ASCII definitions are taken from ANSI standard X3.4-1977.
2. Either the lowercase (unshifted) or uppercase (shifted) letter will produce the indicated code when pressed with the CTRL key.
3. There are dedicated function keys that also produce control codes, for example, the ESC, TAB, SPACE, RETURN, etc.. Some of these key codes can be altered in Set-Up mode or by the Host. Refer to the following section in this chapter for keyboard generated codes.

## ASCII APPLICATION

### CONTROL CODES GENERATED BY KEYBOARD FUNCTION KEYS

The CIT101XL keyboard contains keys that are designated for certain functions. These keys when pressed produce a control code or codes that cause a function to be performed by the terminal or the codes are sent to the host. The function performed and/or the codes generated by these keys is determined by the emulation currently selected and also whether the enhance feature is on or off. The enhance feature is selected in Set-Up mode.

The codes generated by some of the keys listed below can be altered in Set-Up mode. Refer to the Set-Up mode in this chapter for the options available to you and how to set them up for your application.

In the following descriptions only the codes generated in each of the ASCII emulations are covered.

### CONTROL KEYS

#### ESC

WYSE	TVI	TVI	TVI	HZ	ADDS
50	910	920	925	1500	VP
ESC	ESC	ESC	ESC	ESC	ESC

This key when pressed will generate an escape code.

#### BACKSPACE

WYSE	TVI	TVI	TVI	HZ	ADDS
50	910	920	925	1500	VP
BS	BS	BS	BS	BS	BS

This key when pressed in any emulation mode generates a backspace code. This will cause the active position or cursor to behave in the same manner as pressing the the cursor left arrow key.

## ASCII APPLICATION

### RETURN

WYSE 50	TVI 910	TVI 920	TVI 925	HZ 1500	ADDS VP
CR or CR LF	CR or CR LF	CR or CR LF	CR or CR LF	CR or CR LF	CR or CR LF

This key when pressed will generate a carriage return or carriage return and linefeed code as selected in Set-Up mode.

### TAB

WYSE 50	TVI 910	TVI 920	TVI 925	HZ 1500	ADDS VP
HT	HT	HT	HT	HT	HT

This key when pressed will generate a horizontal tab code in any of the emulation modes.

### TAB with SHIFT key

WYSE 50	TVI 910	TVI 920	TVI 925	HZ 1500	ADDS VP
ESC I	ESC I	ESC I	ESC I	~HT	ESC I

When the TAB key is pressed with the SHIFT key a backtab control sequence is generated in the WYSE 50, TVI, and ADDS-VP modes. This control sequence causes the active position or cursor to move to the previous tab on the current line unless there are no more tabs in which case it will move to column 1 on that line.

The enhance feature must be on for the control sequence to be valid in the ADDS-VP mode.

## ASCII APPLICATION

### CURSOR POSITION KEYS

#### ↓ (CURSOR DOWN)

WYSE	TVI	TVI	TVI	HZ	ADDS
50	910	920	925	1500	VP
LF	LF	LF	SYN	ESC VT	LF

When the cursor down arrow key is pressed in the WYSE 50, TVI-910, TVI-920 or ADDS-VP emulation modes a line feed code is generated. This results in the cursor position moving down to the next line.

In the TVI-925 and HZ-1500 modes, the codes shown above are generated and the cursor moves now to next line. However, in these modes a scroll is not performed. Refer to the use of SHIFT key in next next description.

Note that the exact behavior of the cursor in the display is also dependent on how the NO SCROLL submode is set. Refer to description of these submode later in this chapter.

#### ↓ (CURSOR DOWN) with SHIFT key

WYSE	TVI	TVI	TVI	HZ	ADDS
50	910	920	925	1500	VP
LF	LF	LF	LF	LF	LF

When the cursor down arrow key is pressed in any of the emulation modes with the shift key a linefeed code is generated. This results in the cursor moving down to the next line or row within the same column position. If the cursor is at row 24, it will move to row 1.

A scroll will be performed if at the row 24, however the exact behavior of the cursor on the screen is dependent on how the NO SCROLL submode is set.



## ASCII APPLICATION

### ← (CURSOR LEFT)

WYSE 50	TVI 910	TVI 920	TVI 925	HZ 1500	ADDS VP
BS	BS	BS	BS	BS	NAK

When the cursor left key is pressed a backspace code is generated except for the ADDS-VP emulation mode in which a NAK code is generated. The backspace code, or NAK code in ADDS-VP mode, causes the cursor to move back one character position. If the cursor is at column 1, it will wrap back to the last column of the previous line. If it is at row 1 col 1, it will wrap to the last character position on line 24.

### → (CURSOR RIGHT)

WYSE 50	TVI 910	TVI 920	TVI 925	HZ 1500	ADDS VP
FF	FF	FF	FF	DLE	ACK

When the cursor right key is pressed the codes shown above are generated in each of corresponding emulation modes. These codes cause the cursor to move forward one character position. If the cursor is at the last position of a row it will wrap to the first position on the next row. If it is at the last character position on row 24 it will wrap to row 1 column 1.

### ↑ (CURSOR UP)

WYSE 50	TVI 910	TVI 920	TVI 925	HZ 1500	ADDS VP
VT	VT	VT	VT	~FF	SUB

When the cursor up arrow key is pressed the codes shown above are generated in each of the corresponding emulation modes. These codes cause the cursor to move back one row in the same column. If the cursor is in row 1, it will move to row 24.

## ASCII APPLICATION

### HOME

WYSE 50	TVI 910	TVI 920	TVI 925	HZ 1500	ADDS VP
RS	RS	RS	RS	~DC2	SOH

This key when pressed generates the codes shown above in each of the corresponding emulation modes. These codes will cause the cursor to move to the home position on the screen. The home position is defined as the first row and first column position of the active text segment.

### HOME with SHIFT key

WYSE 50	TVI 910	TVI 920	TVI 925	HZ 1500	ADDS VP
ESC }	ESC }	ESC }	ESC }	~DC2	SOH

When the HOME key is pressed with the SHIFT key, the codes shown above are generated. In the WYSE 50 and TVI emulation modes the generated codes active text segment 1. Refer to ASCII MODE CONTROL SEQUENCES for a further description. In the HZ-1500 and ADDS-VP emulation modes this key sequence has the same effect as pressing the HOME key alone.

## ASCII APPLICATION

### EDITING KEYS

The editing keys described are the four PF keys located at the top of the numeric keypad at the right of the keyboard. In order to obtain the function listed on the top half of the key, it must be pressed with the shift key.

### INSERT LINE/CHARACTER (PF1)

#### CHARACTER (UNSHIFTED)

WYSE 50	TVI 910	TVI 920	TVI 925	HZ 1500	ADDS VP
ESC Q	ESC Q	ESC Q	ESC Q	STX	ESC Q

When this key is pressed an insert character control code sequence is generated in each of the emulation modes except HZ-1500. This sequence causes a space to be inserted at the current cursor position. The character the cursor was on and all characters to the right of it are moved to the right one position. If there is a character at the end of the line it is lost.

If the protect mode is on, the sequence has no effect on protected fields. A space is inserted in the unprotected character field and all characters are moved right within the unprotected field. Any characters moved past column 80 or into a protected character position are lost. The next unprotected character, after the protected character position, is not affected.

The enhance feature must be on for the key function to be valid in ADDS-VP mode.

#### LINE (SHIFTED)

WYSE 50	TVI 910	TVI 920	TVI 925	HZ 1500	ADDS VP
ESC E	ESC E	ESC E	ESC E	~SUB	ESC M

When this key is pressed with the SHIFT key an insert line control code sequence is generated for each of the emulation modes. This sequence causes a line consisting of space codes to be inserted at line the cursor is on. The line the cursor is on and all lines to end of the active text segment are moved down one line. Any line moved beyond the active text or line 24 is lost.

These sequences are not valid when the protect submode is on.

## ASCII APPLICATION

### DELETE LINE/CHARACTER (PF2)

#### CHARACTER (UNSHIFTED)

WYSE 50	TVI 910	TVI 920	TVI 925	HZ 1500	ADDS VP
ESC W	ESC W	ESC W	ESC W	ETX	ESC W

When this key is pressed a delete character control code sequence is generated in each of the emulation modes except for HZ-1500 mode. This control sequence will delete the character at the cursor position and move all of the characters at the right of it one position to the left. A space code will be added to the end of the line. If the protect mode is on, this key will affect only unprotected fields.

This key function is valid in ADDS-VP mode only if the enhance feature has been selected in Set-Up mode.

#### LINE (SHIFTED)

WYSE 50	TVI 910	TVI 920	TVI 925	HZ 1500	ADDS VP
ESC R	ESC R	ESC R	ESC R	~DC3	ESC l

When this key is pressed with the SHIFT key a delete line control code sequence is generated in each of the emulation modes except for HZ-1500 mode. This sequence will delete the line the cursor is on and move all the line up one line. The cursor is moved to column one on the next line and the line added at the bottom of the screen contains spaces. This sequence is not valid if the protect mode is on.

## ASCII APPLICATION

### CLEAR SCREEN/LINE (PF3)

#### LINE (UNSHIFTED)

WYSE 50	TVI 910	TVI 920	TVI 925	HZ 1500	ADDS VP
ESC T	ESC T	ESC T	ESC T	~SI	ESC K

When this key is pressed a clear line control code sequence is generated in each of the emulation modes. This control sequence will clear the line from current cursor position to the end of the line and replace the characters with space codes. If the protect submode is on the line is cleared to the start of a protected field.

#### SCREEN (SHIFTED)

WYSE 50	TVI 910	TVI 920	TVI 925	HZ 1500	ADDS VP
ESC Y	ESC Y	ESC Y	ESC Y	~FS	ESC k

When this key is pressed with the SHIFT key a clear screen control code sequence is generated in each of the emulation modes except for HZ-1500 mode. This control sequence will clear the screen from current cursor position to the end of the active text segment and replace the characters with space codes. If the protect submode is on, only the unprotected characters are cleared.

### INSERT/REPLACE (PF4)

#### INSERT (SHIFTED)

WYSE 50	TVI 910	TVI 920	TVI 925	HZ 1500	ADDS VP
ESC q	ESC q	ESC q	ESC q	NAK	ESC q

#### REPLACE (UNSHIFTED)

WYSE 50	TVI 910	TVI 920	TVI 925	HZ 1500	ADDS VP
ESC r	ESC r	ESC r	ESC r	EOT	ESC r

This key is used with the SHIFT key to toggle between the insert and replace submodes of the terminal. This key function is not valid in the HZ-1500 emulation. The key function is valid for the ADDS-VP mode only when the enhance feature has been selected in Set-Up mode.

Refer to the ASCII MODE CONTROL SEQUENCE section of this chapter for a description of the insert and replace modes.

## ASCII APPLICATION

### SPECIAL-PURPOSE KEYS

#### ENTER

WYSE 50	TVI 910	TVI 920	TVI 925	HZ 1500	ADDS VP
CR or HT	CR or HT	CR or HT	CR or HT	CR or HT	CR or HT

This key when pressed will generate a carriage return code or a horizontal tab as selected in Set-Up mode.

#### PRINT

WYSE 50	TVI 910	TVI 920	TVI 925	HZ 1500	ADDS VP
ESC P	ESC P	ESC P	ESC P	ACK	ESC P

This key function is obtained by pressing <SHIFT-LINE FEED>. When this key sequence is pressed a PRINT PAGE control sequence is generated. This control sequence causes the contents of the screen display to be transmitted to the AUX port.

This action occurs in all modes of operation except the HZ-1500 mode. In this mode an acknowledge control code is generated. In ADDS-VP mode the PRINT PAGE command is valid only if the enhance feature is selected in Set-Up mode.

#### SEND

WYSE 50	TVI 910	TVI 920	TVI 925	HZ 1500	ADDS VP
ESC 7	ESC 7	ESC 7	ESC 7	-7	ESC 7

This key function is obtained by pressing the <LINE FEED> key by itself. When the key is pressed a SEND PAGE control sequence is generated in any of the emulation modes. This control sequence causes the contents of the screen display to be sent to the host via the COMM port.

This action occurs in all modes of operation, however, the enhance feature must be selected in Set-Up mode for the control sequence to take effect in ADDS-VP or HZ-1500 mode. Note that in HZ-1500 mode the tilde(-) is interchangeable with ESC when the enhance feature is on.

## ASCII APPLICATION

### BREAK

This key when pressed does not generate any codes but sends a signal to the host. This signal consists of deasserting the DTR signal for 250 seconds in any of the TVI and HZ-1500 emulation modes. In the WYSE 50 and ADDS-VP modes the DTR signal is deasserted for 250 microseconds.

### NEXT PAGE/PREV PAGE

#### UNSHIFTED (NEXT PAGE)

WYSE 50	TVI 910	TVI 920	TVI 925	HZ 1500	ADDS VP
ESC K	ESC K	ESC K	ESC K	SOH	ESC J

#### SHIFTED (PREV PAGE)

WYSE 50	TVI 910	TVI 920	TVI 925	HZ 1500	ADDS VP
ESC J	ESC J	ESC J	ESC J	ENQ	ESC J

This key when pressed alone (unshifted) will generate the next page control sequences shown and pressed with the SHIFT key (shifted) will generate the previous page sequences shown above.

In the WYSE 50, TVI, and ADDS-VP these sequences active the alternate text segment. Refer to the next section, ASCII MODE CONTROL SEQUENCES for further information. Note that the enhance feature must be selected in Set-Up mode for the sequence to be valid in ADDS-VP mode.

## ASCII APPLICATION

### TERMINAL CONTROL SEQUENCES

The following section provides a description of the control codes and escape codes, in all the ASCII emulation modes of the CIT101XL, that control the terminal operating modes. This listing is organized by function. A summary of the control codes is provided in the appendix.

When the ENHANCE parameter has been selected in Set-Up mode (as explained in Chapter 4) additional codes in the Hazeltine 1500 and the ADDS Viewpoint emulation modes are available. These codes are listed in bold type. In the HZ-1500 enhanced mode, the ESC control code (1BH) can be interchanged with ~ character code (7EH) in command sequences.

### OPERATING MODE CONTROLS

The CIT101XL recognizes a set of control sequences that set the terminal operating configuration. These controls are known as mode control sequences since they control or set up how the terminal operates. These controls include how the terminal communicates with the host, how the cursor behaves on the screen, and how characters are displayed on the screen.

### COMMUNICATION MODES

The terminal communicates with the host in either a conversational or block mode with full or half duplex transmission. There are four possible communication modes:

1. **Block**---In this operating mode, data is sent in blocks to the host. A block of data can consist of a word, line, or screen. The end of a block is marked by the code selected by the BLOCK END setting in Set-Up mode. The data entered at the keyboard is stored in the terminal and is sent to the host when the LINE FEED key is pressed. Control key functions are valid and except for BREAK, SET-UP, F1-F16, and NO SCROLL, do not result in any transmission to the host.

Null codes (00H) are not transmitted in this mode. Attributes are transmitted as space codes (20H) and graphic characters also are sent as space codes if the protect mode is on.

2. **Half-duplex**---In this operating mode data entered at the keyboard is displayed and also sent to the host. Control key functions are not sent to the host but are recognized by the terminal locally. Control code sequences entered at the keyboard are sent to the host and are also acted on locally. This operating mode is referred to as a conversational mode.



## ASCII APPLICATION

3. **Half-duplex block**---This mode is a combination of the two modes described above. The terminal operates in half-duplex mode except that transmissions to the host are handled in block mode fashion. This is also a conversational mode.
4. **Full-duplex**---This is a conversational mode. In this mode the display and terminal operations are controlled or determined by the host. Any data or key functions entered at the keyboard is sent to the host as the key is pressed. The data is not displayed or function is not executed at the terminal until it is sent back from the host.

The operating communication mode of the terminal can be selected in Set-Up mode or with a control sequence. The current mode is displayed on the status line at the top of the display if the status line is enabled in Set-Up mode. The display is:

1. BLK for block mode or half-duplex block mode
2. HDX for half-duplex mode
3. FDX for full-duplex mode

### BLOCK MODE ON

WY-50	TVI-910	TVI-920	TVI-925	HZ-1500	ADDS-VP
ESC B	ESC B	ESC B	ESC B	ESC B	ESC B

This sequence is valid in the HZ-1500 and ADDS-VP modes if the enhance feature has been selected in Set-Up mode.

### CONVERSATION MODE ON

WY-50	TVI-910	TVI-920	TVI-925	HZ-1500	ADDS-VP
ESC C	ESC C	ESC C	ESC C	ESC C	ESC C

This sequence is valid in the HZ-1500 and ADDS-VP modes if the enhance feature has been selected in Set-Up mode.

The terminal is placed in the last conversation mode selected. A control sequence selecting a conversation mode is not valid until this sequence is received.

## ASCII APPLICATION

### DUPLEX MODE CONTROL SEQUENCES

ESC D Pn Selects the full duplex or half duplex conversation modes as specified by Pn. The values for Pn are:

F -- full duplex mode  
H -- half duplex mode

#### Full Duplex On

WY-50	TVI-910	TVI-920	TVI-925	HZ-1500	ADDS-VP
ESC D F	ESC D F	ESC D F	ESC D F	ESC D F	ESC D F

#### Half-Duplex Block On

WY-50	TVI-910	TVI-920	TVI-925	HZ-1500	ADDS-VP
ESC D H then ESC B	ESC D H then ESC B	ESC D H then ESC B	ESC D H then ESC B	ESC D H then ESC B	ESC D H then ESC B

The first sequence ESC D H will turn the half-duplex mode on. The second sequence selects the block mode.

The sequences are valid in the HZ-1500 and ADDS-VP modes if the enhance feature has been selected in Set-Up mode.

**TERMINAL OPERATING SUBMODES**

Besides the control sequences that control the terminals operating communication mode, there are control sequences that control the various operating submodes of the terminal. These submodes are:

1. Graphic Character Submode -- In this mode the numeric and some symbol characters are replaced with a line ruled graphic character set that can be used to draw ruled blocks.
2. Insert/Replace Submode -- This mode determines how data is edited in the display screen.
3. Edit Submode -- This mode determines the edit communication mode.
4. Scroll Submode -- This mode determines how data is scrolled on the screen.
5. Protect Submode -- This mode determines how protected characters are processed on the screen.
6. Write Protect Submode -- This mode determines whether characters entered at the keyboard are protected.
7. Monitor Submode -- In this mode control codes are not executed and a symbol appears on the screen.

The terminal submode status is displayed on the status line in addition to the terminal communication mode. The submode status messages are as follows:

1. **INS** -- Indicates that the terminal is in the insert submode.
2. **\*** -- An asterisk(\*) next to the communication mode status message (e.g. \*HDX) indicates that the terminal is in the monitor submode.
3. **PROT** -- Indicates that the terminal is in the protect submode.
4. **WRPT** -- Indicates that the terminal is in the write protect submode. This status indication will appear only if the terminal is in the protect mode also.

## ASCII APPLICATION

### Graphic Character Submode

#### Mode Off

WY-50	TVI-910	TVI-920	TVI-925	HZ-1500	ADDS-VP
ESC H ETX	ESC H ETX	ESC H ETX	ESC H ETX	ESC H ETX	ESC H ETX

#### Mode On

WY-50	TVI-910	TVI-920	TVI-925	HZ-1500	ADDS-VP
ESC H STX	ESC H STX	ESC H STX	ESC H STX	ESC H STX	ESC H STX

When this mode is on the graphic characters shown in the following table will be displayed when the corresponding graphic character code is received from the host or corresponding alphanumeric key at the keyboard is pressed.

A single graphic character can be sent with the sequence:

**ESC H Pn**

The graphic character is specified with the same character codes listed in table. This sequence is valid in all terminal modes.

**Graphic Character Codes**

GRAPHIC	CODE	KEY	GRAPHIC	CODE	KEY
⌈	30H	0	⊕	38H	8
┌	31H	1	┆	39H	9
┐	32H	2	—	3AH	:
└	33H	3	■	3BH	;
└	34H	4	—	3CH	<
└	35H	5	⊥	3DH	=
	36H	6		3EH	>
■	37H	7	▒	3FH	?

Insert/Replace Submode

Insert Submode On

WY-50	TVI-910	TVI-920	TVI-925	HZ-1500	ADDS-VP
ESC q	ESC q		ESC q	ESC q	ESC q

Replace Submode On

WY-50	TVI-910	TVI-920	TVI-925	HZ-1500	ADDS-VP
ESC r	ESC r		ESC r	ESC r	ESC r

These control sequences toggle the terminal between the insert and replace modes of operation. They perform the same function as the INSERT/REPLACE key. The enhance feature must be selected in Set-Up mode for the sequences to be valid in HZ-15000 and ADDS-VP modes.

When the insert submode is on data is inserted at the current cursor position. The character the cursor was on and all characters to the right of it are moved to the right one position. If there is a character at the end of the line it is lost.

If the protect mode is on, the sequence has no effect on protected fields. Data is inserted in the unprotected character field and all characters are moved right within the unprotected field. Any characters moved past column 80 or into a protected character position are lost. The next unprotected character, after the protected character position, is not affected.

When the replace mode is on, any data character entered replaces the character at the current cursor position. The cursor moves to the next character position to the right. If autowrap is on the cursor wraps to the first position on the next line. If protect mode is on, protected fields are unaffected.

## ASCII APPLICATION

### Edit Submode

#### Local Edit Submode On

WY-50	TVI-910	TVI-920	TVI-925	HZ-1500	ADDS-VP
ESC k			ESC k		

#### Duplex Edit Submode On

WY-50	TVI-910	TVI-920	TVI-925	HZ-1500	ADDS-VP
ESC l			ESC l		

The edit submodes are available only in the WY-50 and TVI-925 modes.

In the local edit submode, control functions entered at the keyboard are processed by the terminal and result in the appropriate screen display regardless of the communication mode selected.

In the duplex edit submode, if the terminal is in a full duplex mode of operation, the key function codes generated at the keyboard are transmitted to the host and are not valid until echoed back by the host.

### Scroll Submode

#### Scroll Submode On

WY-50	TVI-910	TVI-920	TVI-925	HZ-1500	ADDS-VP
ESC O				ESC O	ESC O

#### Scroll Submode Off

WY-50	TVI-910	TVI-920	TVI-925	HZ-1500	ADDS-VP
ESC N				ESC N	ESC N

This submode is available only in the WY-50 mode of operation. However, it is available in the HZ-1500 and ADDS-VP modes when the enhance feature has been selected in Set-Up mode.

When the scroll submode is on and the cursor reaches line 24, the screen will scroll up one line if the cursor is moved down one line. If the scroll submode is off or the protect mode is on, the cursor will wrap to the top of the screen.

## ASCII APPLICATION

### Protect Submode

#### Protect Submode Off

WY-50	TVI-910	TVI-920	TVI-925	HZ-1500	ADDS-VP
ESC '	ESC '	ESC '	ESC '	ESC '	ESC '

#### Protect Submode On

WY-50	TVI-910	TVI-920	TVI-925	HZ-1500	ADDS-VP
ESC &	ESC &	ESC &	ESC &	ESC &	ESC &

These sequences turn the protect submode off and on. When the protect submode is on, all characters entered as protected characters or displayed as protected characters are not affected by keyboard entered controls or host received controls.

In this submode some control functions are not valid. These functions include: scroll, insert line, and delete line.

These control sequences are valid in the HZ-1500 and ADDS-VP modes only if the enhance feature has been selected in Set-Up mode.

### Write Protect Submode

#### Write protect Submode Off

WY-50	TVI-910	TVI-920	TVI-925	HZ-1500	ADDS-VP
ESC (	ESC (	ESC (	ESC (	~ US	SI

#### Write Protect Submode On

WY-50	TVI-910	TVI-920	TVI-925	HZ-1500	ADDS-VP
ESC )	ESC )	ESC )	ESC )	~ EM	SO

These sequences and control codes turn the write protect submode on and off for the respective terminal mode. When the mode is on all characters processed for display, received from the host or generated at the keyboard, are protected characters. The characters are displayed and stored as protected characters.

## ASCII APPLICATION

### Monitor Submode

#### Submode Off

WY-50	TVI-910	TVI-920	TVI-925	HZ-1500	ADDS-VP
ESC u	ESC u	ESC u	ESC u	ESC u	ESC u
ESC X	ESC X	ESC X	ESC X	ESC X	ESC X

#### Submode On

WY-50	TVI-910	TVI-920	TVI-925	HZ-1500	ADDS-VP
ESC U	ESC U	ESC U	ESC U	ESC U	ESC U

These control sequences switch the monitor submode off or on. The enhance feature must be selected in Set-Up mode for these sequences to be valid in the HZ-1500 and ADDS-VP modes of operation.

When the monitor submode is on, control functions entered at the keyboard or received from the host are not acted on. However, the control code is displayed on the screen as a control symbol.

This submode can also be toggled on and off with the key sequence <CTRL-SHIFT-1>. However, the 1 key on the numeric keypad must be used in this key sequence.



**DISPLAY CONTROL**

The CIT101XL display features can be controlled from the host with control sequences and control codes. These controls include:

1. **SPLIT SCREEN** -- These controls divide the screen into two text segments. The text segments are designated 0 and 1.
2. **TAB AND CARRIAGE RETURN** -- These control the way carriage returns (CR) are interpreted and also control the tab features of the terminal.

**SPLIT SCREEN FORMAT CONTROLS**

WY-50	TVI-910	TVI-920	TVI-925	HZ-1500	ADDS-VP
ESC x	ESC	ESC	ESC	ESC x	ESC x

The control sequence is used in the form:

ESC x Ps Pa

Where:

- Ps = 0 -- for a full screen, 24 rows by 80 or 132 columns  
 1 -- for a split screen display

- Pa = A numeric parameter where the first row of the second text segment begins. The parameter is a value for the row number, 2 to 24, on which the lower text segment starts. Refer to the Row/Column code table in the Cursor Controls section for the row codes.

When the sequence is received any submodes that have been set are cleared. The upper text segment designated is the active text segment. The cursor is moved to the home position of this text segment.

An ACK control code is sent to the host if the sequence was sent by the host.

This sequence is valid for the HZ-1500 and ADDS-VP modes when the enhance feature has been selected in Set-Up mode.

## ASCII APPLICATION

### ACTIVATE TEXT SEGMENT

#### Upper Text Segment

WY-50	TVI-910	TVI-920	TVI-925	HZ-1500	ADDS-VP
ESC ]				ESC ]	ESC ]

#### Lower Text Segment

WY-50	TVI-910	TVI-920	TVI-925	HZ-1500	ADDS-VP
ESC )	ESC )	ESC )	ESC )	ESC )	ESC )

These sequences activate the text segment. The active position or cursor is moved to the home position of the text segment specified. The cursor moves to the previous position it occupied if it is moved back from one segment to the other.

Any submodes set while in any text segment are also set for the other text segment.

These sequences are valid for the HZ-1500 and ADDS-VP modes when the enhance feature has been selected in Set-Up mode.

#### Alternate Text Segment

WY-50	TVI-910	TVI-920	TVI-925	HZ-1500	ADDS-VP
ESC J	ESC J	ESC J	ESC J	ESC J	ESC J
ESC K	ESC K	ESC K	ESC K	ESC K	

This sequence activates the alternate text segment. The cursor is moved to the home position of the text segment or to the position it previously occupied. These sequences are generated by the PREV/NEXT PAGE key.

These sequences are valid for the HZ-1500 and ADDS-VP modes when the enhance feature has been selected in Set-Up mode.

**MOVE CURSOR TO SPECIFIC TEXT SEGMENT**

WY-50	TVI-910	TVI-920	TVI-925	HZ-1500	ADDS-VP
ESC -	ESC -	ESC -	ESC -	ESC -	ESC -

This sequence moves the cursor to a text segment. The format for the sequence is:

**ESC - Pn Pr Pc**

Pn is the text segment, 0 = Upper, 1 = Lower  
Pr and Pc are the row and column numbers as listed in the Row/Column code table in the Cursor Controls Section.

This sequence is valid for the HZ-1500 and ADDS-VP modes when the enhance feature has been selected in Set-Up mode.

**SELECT SCREEN FEATURES**

WY-50	TVI-910	TVI-920	TVI-925	HZ-1500	ADDS-VP
ESC ' Pn	ESC . Pn	ESC . Pn	ESC . Pn	ESC ' Pn	ESC ' Pn

These sequences select the available screen features that control how the display, including the cursor and protected characters, appear to the user.

In the WYSE 50 emulation mode and the HZ-1500 and ADDS-VP emulation modes, the sequence is used in the following form:

**ESC ' Pn**

The enhance feature must be on for this sequence to be valid in the HZ-1500 and ADDS-VP modes.

In the TVI emulation modes the sequence is used in the form:

**ESC . Pn**

The available values for Pn are listed in the following table.

**ASCII APPLICATION**

**Screen Feature codes**

---

<b>Pn values</b>	<b>Screen Feature</b>
0	cursor display off
1	cursor display on (default)
2	Steady block cursor
3	Blinking line cursor
4	Steady line cursor
5	Blinking block cursor (default)
A	Normal protect character
6	Reverse protect character
7	Dim protect character (default)
8	Screen display off
9	Screen display on (default)
:	80-column screen (default)
;	132-column screen
<	Smooth scroll @ 1 row per second
=	Smooth scroll @ 2 rows per second
>	Smooth scroll @ 4 rows per second
?	Smooth scroll @ 8 rows per second
@	Jump scroll (default)

---

**CHARACTER DISPLAY ATTRIBUTES**

**Set Display Field Attributes**

WY-50	TVI-910	TVI-920	TVI-925	HZ-1500	ADDS-VP
ESC G	ESC G	ESC G	ESC G	ESC G	ESC G

This sequence sets a video attribute within the application display area. The attributes occupies a space. The complete format of the sequence is ESC G Pa. Pa is the attribute as defined in the following attribute code table.

**Set Attribute for Message Field/Screen**

WY-50	TVI-910	TVI-920	TVI-925	HZ-1500	ADDS-VP
ESC A	ESC \	ESC \	ESC \	ESC A	ESC A

This sequence controls how the characters within the message/status line, application area, and function key label line are displayed. An attribute is written into the current cursor location and occupies a space.

The sequence is used in the form:

**ESC A Pn Pa**

This sequence is used to set a display attribute for the message field in the WYSE 50 emulation mode and the HZ-1500 and ADDS-VP emulation modes when the enhance feature is on. For the TVI emulation modes the sequence is used as follows:

**ESC \ Pn Pa**

Pn is the display field code and is defined as follows:

Application Display Area	0
Function Key Labeling Line	1
Local Message Field	2
Host Message Field	3

Pa is the attribute code. The valid values for Pa are listed in the following table.

## ASCII APPLICATION

### Attribute Codes

---

Pa	Display Attributes
(space)	Space code (20H)
0	Normal
1	Blank (no display)
2	Blink
3	Blank
4	Reverse
5	Reverse and blank
6	Reverse and blink
7	Reverse and blank
8	Underscore
9	Underscore and blank
:	Underscore and blink
;	Underscore, blink, and blank
<	Underscore and reverse
=	Underscore, reverse, and blank
>	Underscore, reverse, and blank
?	Underscore, reverse, blink, and blank
p	Dim
q	Dim and blank
r	Dim and blink
s	Dim and blank
t	Dim and reverse
u	Dim, reverse, and blank
v	Dim, reverse, and blink
w	Dim, reverse, and blank
x	Dim and underline
y	Dim, reverse, and blank
z	Dim, underline, and blink
{	Dim, underline, blink, and blank
	Dim, underline, and reverse
}	Dim, underline, reverse, and blank
~	Dim, underline, reverse, and blink

---

ADDITIONAL ATTRIBUTE CONTROLS

Set Attribute For Protected Character

WY-50	TVI-910	TVI-920	TVI-925	HZ-1500	ADDS-VP
					ESC 0

This control sequence is valid only in the ADDS-VP mode of operation. It is used in the form:

ESC 0 Pa

Pa is a selective parameter that determines the attributes for any protected characters currently on the screen and characters received. Refer to the Attribute Code table for valid parameter codes.

Set Protected Column

WY-50	TVI-910	TVI-920	TVI-925	HZ-1500	ADDS-VP
ESC V	ESC V	ESC V	ESC V	ESC V	ESC V

These sequences set the column the cursor is on to the protected mode.

BLANK AND BLINKING FIELD ATTRIBUTE (TVI-920 MODE)

Start Blank Field Attribute

WY-50	TVI-910	TVI-920	TVI-925	HZ-1500	ADDS-VP
		ESC _			

Start Blink Field Attribute

WY-50	TVI-910	TVI-920	TVI-925	HZ-1500	ADDS-VP
		ESC ^			

End Blank/Blink Field Attribute

WY-50	TVI-910	TVI-920	TVI-925	HZ-1500	ADDS-VP
		ESC q			

These control sequences set the blank and blinking field attribute when the terminal is in the Teletype 920 emulation mode. The field is defined by the start attribute control at the current cursor position. The end of the field is defined by the end field attribute control at the current cursor position.

## ASCII APPLICATION

### REVERSE VIDEO FIELD ATTRIBUTE CONTROL

#### Start Reverse Video Field Attribute

WY-50	TVI-910	TVI-920	TVI-925	HZ-1500	ADDS-VP
		ESC j			

#### End Reverse Video Field Attribute

WY-50	TVI-910	TVI-920	TVI-925	HZ-1500	ADDS-VP
		ESC k			

These control sequences set the reverse field attribute when the terminal is in the Televideo 920 emulation mode. The field is defined by the start attribute control at the current cursor position. The end of the field is defined by the end field attribute control at the current cursor position.

### UNDERLINE FIELD ATTRIBUTE CONTROL

#### Start Underline Field Attribute

WY-50	TVI-910	TVI-920	TVI-925	HZ-1500	ADDS-VP
		ESC l			

#### End Underline Field Attribute

WY-50	TVI-910	TVI-920	TVI-925	HZ-1500	ADDS-VP
		ESC m			

These control sequences set the underline field attribute when the terminal is in the Televideo 920 emulation mode. The field is defined by the start attribute control at the current cursor position. The end of the field is defined by the end field attribute control at the current cursor position.



**TAB AND CARRIAGE CONTROLS**

**Carriage Return**

WY-50	TVI-910	TVI-920	TVI-925	HZ-1500	ADDS-VP
CR	CR	CR	CR	CR	CR

The carriage return code (CR) causes the cursor to move to column 1 of the present line.

**Carriage Return (New Line)**

WY-50	TVI-910	TVI-920	TVI-925	HZ-1500	ADDS-VP
US	US	US	US	US	US

The unit separator code (US) causes the cursor to move to column 1 position of the next row.

The enhance feature must be selected for the code to be valid in ADDS-VP mode.

**Set Tab**

WY-50	TVI-910	TVI-920	TVI-925	HZ-1500	ADDS-VP
ESC 1	ESC 1	ESC 1	ESC 1	ESC 1	ESC 1

This control sequence causes a tab to be set for the column the cursor is on.

The enhance feature must be selected for the sequence to be valid in the HZ-1500 and ADDS-VP modes.

**Clear Single Tab**

WY-50	TVI-910	TVI-920	TVI-925	HZ-1500	ADDS-VP
ESC 2	ESC 2	ESC 2	ESC 2	ESC 2	ESC 2

This control sequence causes a tab position to be cleared at the current cursor position. If a tab is not set at that position, the sequence is ignored.

The enhance feature must be selected for the sequence to be valid in the HZ-1500 and ADDS-VP modes.

## ASCII APPLICATION

### Clear All Tabs

WY-50	TVI-910	TVI-920	TVI-925	HZ-1500	ADDS-VP
ESC 0	ESC 3	ESC 3	ESC 3	ESC 3	

This control sequence causes all tabs to be cleared.

The enhance feature must be selected for the sequence to be valid in the HZ-1500 mode.

### Tab Position

WY-50	TVI-910	TVI-920	TVI-925	HZ-1500	ADDS-VP
HT ESC i	HT ESC i	HT ESC i	HT ESC i	HT ESC i	HT

The horizontal tab code (HT) and the escape sequences shown above cause the cursor to move to the next tab stop. The enhance feature must be selected for the escape sequence to be valid in HZ-1500 mode.

### Back Tab

WY-50	TVI-910	TVI-920	TVI-925	HZ-1500	ADDS-VP
ESC I	ESC I	ESC I	ESC I	ESC I	ESC I

This control sequence causes the cursor to move back to the previous tab stop on the current line unless there are no more tabs in which case it will move to column 1 on that line.

The enhance feature must be on for the control sequence to be valid in the ADDS-VP and HZ-1500 modes.

This control sequence is equivalent to <SHIFT-TAB> Key sequence in all of emulation modes except HZ-1500. Refer to KEYBOARD GENERATED CONTROL FUNCTIONS in this chapter.

## ASCII APPLICATION

### CURSOR CONTROL

The movements of the cursor on the display screen are dependent on how the terminal submodes are set and the type of data currently displayed on the screen. In the following control codes the cursor movement applies only to the active text segment.

Also, if the protect submode is on, the cursor skips protected characters.

Except when the no scroll submode is on, if the cursor movement would result in the cursor leaving the active text segment, then the text automatically scrolls up.

#### Home Cursor

WY-50	TVI-910	TVI-920	TVI-925	HZ-1500	ADDS-VP
RS	RS	RS	RS	~DC2	SOH
ESC {	ESC {	ESC {	ESC {	ESC {	ESC {

These control sequences cause the cursor to move to the home position on the display screen. The home position is defined as defined as the first row first column position of the active text segment.

The enhance feature must be selected for the sequence ESC { to be valid in ADDS-VP and HZ-1500 modes.

These control sequences are equivalent to the HOME key function.

#### Move Cursor Down (no scroll)

WY-50	TVI-910	TVI-920	TVI-925	HZ-1500	ADDS-VP
			SYN	~ VT	

These control codes cause the cursor to move down one row. A scroll is not performed.

#### Move Cursor (scroll)

WY-50	TVI-910	TVI-920	TVI-925	HZ-1500	ADDS-VP
LF	LF	LF	LF	LF	LF

The linefeed (LF) control code causes the cursor to move down to the next line while remaining in the same column position. A scroll is performed when the cursor reaches the last line of the active text segment or screen display.

## ASCII APPLICATION

### Move Cursor Left

WY-50	TVI-910	TVI-920	TVI-925	HZ-1500	ADDS-VP
BS	BS	BS	BS	BS	NAK

The backspace code (BS), or negative acknowledge code (NAK) in ADDS-VP mode, causes the cursor to move back one character position. If the cursor is at column 1, it will wrap back to the last column of the previous line. If it is at row 1 column 1, it will wrap to the last character position on line 24.

### Move Cursor Right

WY-50	TVI-910	TVI-920	TVI-925	HZ-1500	ADDS-VP
FF	FF	FF	FF	DLE	ACK

The codes shown above cause the cursor to move forward one character position. If the cursor is at the last position of a row it wrap to the first position on the next row. If it is at the last character position on row 24 it will wrap to row 1 column 1.

### Move Cursor Up

WY-50	TVI-910	TVI-920	TVI-925	HZ-1500	ADDS-VP
VT	VT	VT	VT	~ FF	SUB

The codes shown above will cause the cursor to move back one row in the same column position. If the cursor is in row 1 it will move to row 24.

### Move Cursor Up (Scroll)

WY-50	TVI-910	TVI-920	TVI-925	HZ-1500	ADDS-VP
ESC j	ESC j		ESC j		

This sequence moves the cursor up one row in the same column position. A scroll is performed if the cursor is at the top row.

## ASCII APPLICATION

### Move Cursor to Specific Column or Row

#### Specific Column

WY-50	TVI-910	TVI-920	TVI-925	HZ-1500	ADDS-VP
	ESC ]				DLE

#### Specific Row

WY-50	TVI-910	TVI-920	TVI-925	HZ-1500	ADDS-VP
	ESC [				VT

These sequences are entered in the following form:

ESC ] Pc  
DLE Pc

ESC [ Pr  
VT Pr

The cursor moves to the row specified by parameter Pr and to the column specified by Pc. Valid values for these parameters are defined in the Row/Column codes table which follows on the next page.

### Move Cursor to Specific Row and Column (80-column mode)

WY-50	TVI-910	TVI-920	TVI-925	HZ-1500	ADDS-VP
ESC =	ESC =	ESC =	ESC =	-DC1	ESC Y

In the WY-50 and TVI modes the sequence is entered in the form:

ESC = Pr Pc

In the HZ-1500 mode the sequence is entered in the form:

-DCI Pc Pr or ESC DCI Pc Pr if the enhance feature is on.

In the ADDS-VP mode the sequence is entered in the form:

ESC Y Pr Pc

The cursor moves to the row specified by parameter Pr and to the column specified by Pc. This sequence is valid only for 80-column displays. Valid values for these parameters are defined in the following table.

## ASCII APPLICATION

### Move Cursor to Specific Row and Column (132-column mode)

WY-50	TVI-910	TVI-920	TVI-925	HZ-1500	ADDS-VP
ESC a	ESC d	ESC d	ESC d	ESC a	ESC a

These sequence moves the cursor to a specified row and column for an 80- or a 132-column screen. For the WY-50 mode and the HZ-1500 and ADDS-VP when the enhance feature is on, the sequence is entered in the form:

ESC a Pr R Pc C

It is entered in the following form for the TVI modes:

ESC d Pr R Pc C

The parameter Pr is the ASCII encoded decimal value of the row and Pc is the ASCII encoded decimal value of the column.

For example:

ESC a 1 R 1 C positions the cursor at true home.

ESC a 2 R 12 C positions the cursor at row 2 column 12.

### ENABLE/DISABLE CURSOR

The following commands are available only in the ADDS-VP mode and will disable or enable the cursor when received.

#### Disable Cursor

WY-50	TVI-910	TVI-920	TVI-925	HZ-1500	ADDS-VP
					ETB

#### Enable Cursor

WY-50	TVI-910	TVI-920	TVI-925	HZ-1500	ADDS-VP
					CAN

## ASCII APPLICATION

### ROW/COLUMN CODES

The following table list the row and column codes for the CIT101XL for all the emulation modes.

CIT101XL ROW/COLUMN CODES		
Row	WY-50/ADDS-VP TVI-910/920/925 Row Code	HZ-1500 Row Code
1	(space)	NUL
2	!	SOH
3	"	STX
4	#	ETX
5	\$	EOT
6	%	ENQ
7	&	ACK
8	'	BEL
9	(	BS
10	)	HT
11	*	LF
12	+	VT
13	,	FF
14	-	CR
15	.	SO
16	/	SI
17	0	DLE
18	1	DC1
19	2	DC2
20	3	DC3
21	4	DC4
22	5	NAK
23	6	SYN
24	7	ETB

Column	WY-50/ADDS-VP TVI-910/920/925 Column Code	HZ-1500 Column Code
1	(space)	NUL
2	!	SOH
3	"	STX
4	#	ETX
5	\$	EOT
6	%	ENQ
7	&	ACK
8	'	BEL
9	(	BS
10	)	HT
11	*	LF
12	+	VT

# ASCII APPLICATION

## CIT101XL ROW/COLUMN CODES (continued)

Column	WY-50/ADDS-VP TVI-910/920/925 Column Code	HZ-1500 Column Code
13	,	FF
14	-	CR
15	.	SO
16	/	SI
17	0	DLE
18	1	DC1
19	2	DC2
20	3	DC3
21	4	DC4
22	5	NAK
23	6	SYN
24	7	ETB
25	8	CAN
26	9	EM
27	:	SUB
28	;	ESC
29	<	FS
30	=	GS
31	>	RS
32	?	US
33	@	(SPACE)
34	A	!
35	B	"
36	C	#
37	D	\$
38	E	%
39	F	&
40	G	'
41	H	(
42	I	)
43	J	*
44	K	+
45	L	,
46	M	-
47	N	.
48	O	/
49	P	0
50	Q	1
51	R	2
52	S	3
53	T	4
54	U	5
55	V	6
56	W	7
57	X	8
58	Y	9
59	Z	:
60	[	;



## ASCII APPLICATION

### CIT101XL ROW/COLUMN CODES (continued)

Column	WY-50/ADDS-VP TVI-910/920/925 Column Code	HZ-1500 Column Code
61	\	<
62	]	=
63	^	>
64	—	?
65	⌐	@
66	a	A
67	b	B
68	c	C
69	d	D
70	e	E
71	f	F
72	g	G
73	h	H
74	i	I
75	j	J
76	k	K
77	l	L
78	m	M
79	n	N
80	o	O

## ASCII APPLICATION

### CLEAR SCREEN CONTROLS

#### CLEAR WITH NULL CODE (00H)

The following controls replace any cleared positions with a null control character code (00H).

#### Clear all to Nulls

WY-50	TVI-910	TVI-920	TVI-925	HZ-1500	ADDS-VP
ESC *	ESC *	ESC *	ESC *	ESC *	FF

This sequence clears the entire screen to nulls. All protected characters are also cleared and the protect submode is turned off. This control affects only the active display segment in split screen mode.

The enhance feature must be selected in Set-Up mode for the sequence to be valid in HZ-1500 mode.

#### Clear Unprotected To Nulls

WY-50	TVI-910	TVI-920	TVI-925	HZ-1500	ADDS-VP
ESC :	ESC :	ESC :	ESC :	ESC :	ESC :

Clears all unprotected characters to nulls. The protect submode must be on, otherwise the sequence will affect the entire screen.

The enhance feature must be selected in Set-Up mode for the sequence to be valid in HZ-1500 and ADDS-VP modes.

#### Clear Unprotected to End of Page with Nulls

WY-50	TVI-910	TVI-920	TVI-925	HZ-1500	ADDS-VP
ESC y	ESC y	ESC y	ESC y	ESC y	ESC y

This sequence clears all unprotected characters from cursor position to end of active display. Protected characters are unaffected if the protect submode is on.

The enhance feature must be selected in Set-Up mode for the sequence to be valid in HZ-1500 and ADDS-VP modes.

**Clear to End of Row with Nulls**

WY-50	TVI-910	TVI-920	TVI-925	HZ-1500	ADDS-VP
ESC t	ESC t	ESC t	ESC t	ESC t	ESC t

This sequence clears all characters from the current cursor position to the end of the row and replaces them with nulls. Protected characters are unaffected if the protect submode is on.

When the protect submode is on, characters are cleared to the end of row or to a protected character if there is one on the same row before the end of the row.

The enhance feature must be selected in Set-Up mode for the sequence to be valid in HZ-1500 and ADDS-VP modes.

**CLEAR WITH SPACE CODE (20H)**

The following controls replace any cleared positions with a space character code (20H).

**Clear all to Spaces**

WY-50	TVI-910	TVI-920	TVI-925	HZ-1500	ADDS-VP
ESC +		ESC +		ESC +	ESC +

This sequence clears the entire screen to spaces. All protected characters are also cleared and the protect submode is turned off. This control affects only the active display segment in split screen mode.

The enhance feature must be selected in Set-Up mode for the sequence to be valid in ADDS-VP mode.

**Clear Unprotected to Spaces**

WY-50	TVI-910	TVI-920	TVI-925	HZ-1500	ADDS-VP
SUB	SUB	SUB	SUB	~ GS	
ESC ;	ESC + ESC ;	ESC ;	ESC + ESC ;	ESC ;	ESC ;

Clears all unprotected characters to spaces. The protect submode must be on, otherwise the sequence will affect the entire screen.

The enhance feature must be selected in Set-Up mode for the sequence ESC ; to be valid in ADDS-VP and HZ-1500 modes.

## ASCII APPLICATION

### Clear all to Protected Spaces

WY-50	TVI-910	TVI-920	TVI-925	HZ-1500	ADDS-VP
ESC ,	ESC ,	ESC ,	ESC ,	~ETB	ESC ,

This sequence clears the screen to protected spaces. The protect submode is turned off.

### Clear to End of Page With Spaces

WY-50	TVI-910	TVI-920	TVI-925	HZ-1500	ADDS-VP
ESC Y	ESC Y	ESC Y	ESC Y	~CAN	ESC k

These sequences clear all characters from the cursor position to the end of the active text segment and replace them with spaces. Protected characters are not affected if protect mode is on.

### Clear to End of Row with Spaces

WY-50	TVI-910	TVI-920	TVI-925	HZ-1500	ADDS-VP
ESC T	ESC T	ESC T	ESC T	~SI	ESC K

This sequence clears all characters from the current cursor position to the end of the row and replaces them with spaces. Protected characters are unaffected if the protect submode is on.

When the protect submode is on, characters are cleared to the end of row or to a protected character if there is one on the same row before the end of the row.

## ASCII APPLICATION

### CLEAR UNPROTECTED CHARACTERS WITH ATTRIBUTE

WY-50	TVI-910	TVI-920	TVI-925	HZ-1500	ADDS-VP
ESC !	ESC !	ESC !	ESC !	ESC !	ESC !

This sequence clears all unprotected character positions with a specified attribute. The protect submode must be on, otherwise the sequence will affect the entire screen. The format for the sequence is:

**ESC ! Ps**

Ps is the parameter which specifies the attribute. The valid parameter values are listed in the attribute code table.

This sequence is valid in the HZ-1500 and ADDS-VP emulation modes only when the enhance feature is on.

### CLEAR UNPROTECTED WITH CODE

WY-50	TVI-910	TVI-920	TVI-925	HZ-1500	ADDS-VP
ESC .				ESC .	ESC .

This sequence clears all unprotected character positions with the character specified by Pn. Pn is the hexadecimal ASCII character code. The protect submode must be on, otherwise the sequence will affect the entire screen. The sequence is entered in the form:

**ESC . Pn**

This sequence is valid in the HZ-1500 and ADDS-VP emulation modes only when the enhance feature is on.

## ASCII APPLICATION

### EDITING CONTROLS

#### DELETE CONTROLS

##### Delete Character

WY-50	TVI-910	TVI-920	TVI-925	HZ-1500	ADDS-VP
ESC W	ESC W	ESC W	ESC W	ESC W	ESC W

These sequences delete the character the cursor is on and move all the characters to the right of the deleted character position over one space to the left. A space is inserted at the end of the row.

This function is valid in the HZ-1500 and ADDS-VP emulation modes only when the enhance feature is on.

##### Delete Row

WY-50	TVI-910	TVI-920	TVI-925	HZ-1500	ADDS-VP
ESC R	ESC R	ESC R	ESC R	ESC R	ESC I

These sequences delete the row the cursor is on. The rows below are moved up one row within the active text segment and a row of spaces is inserted at the bottom row position.

This function is valid in the HZ-1500 and ADDS-VP emulation modes only when the enhance feature is on.

#### INSERT CONTROLS

##### Insert Space

WY-50	TVI-910	TVI-920	TVI-925	HZ-1500	ADDS-VP
ESC Q	ESC Q	ESC Q	ESC Q	ESC Q	ESC Q

This sequence inserts a space at the current cursor position. Protected characters are not affected if protect mode is on. Any data moved beyond the display screen is lost if protect mode is off. Data present on the same line as a protected character is not affected if it is present after the protected character and protect mode is on. Data moved into a protected field while protect mode is on is lost.

The enhance feature must be selected in Set-Up mode for the sequence to be valid in ADDS-VP and HZ-1500 mode.

## ASCII APPLICATION

### Insert Row with Spaces

WY-50	TVI-910	TVI-920	TVI-925	HZ-1500	ADDS-VP
ESC E	ESC E	ESC E	ESC E	~ SUB	ESC M

This sequence inserts a row of spaces at the row position the cursor is on. The row the cursor is on and any rows below are moved down. A row moved beyond the bottom margin is lost.

The sequence is not valid when protect mode is on.

## ASCII APPLICATION

### TERMINAL CONTROL

#### ENTER HOST MESSAGE

WY-50	TVI-910	TVI-920	TVI-925	HZ-1500	ADDS-VP
ESC F	ESC F	ESC F	ESC F	ESC F	ESC F

This sequence is entered in the following format:

ESC F <message> CR

The sequence inserts a message in the host message field. The message can be a character string of up to 46 characters for an 80-column screen or up to 100 characters for a 132-column screen.

The enhance feature must be selected in Set-Up mode for the sequence to be valid in the ADDS-VP and HZ-1500 modes.

### KEYBOARD LOCK CONTROL

#### Lock Keyboard

WY-50	TVI-910	TVI-920	TVI-925	HZ-1500	ADDS-VP
SI				~ NAK	EOT
ESC #	ESC #	ESC #	ESC #	ESC #	ESC 5 ESC #

These sequences when received by the terminal cause the keyboard to be disabled. All key actions are ignored except for the BREAK, function keys F1 thru F16, and FUNCT key.

The enhance feature must be selected in Set-Up mode for the sequence, ESC #, to be valid in ADDS-VP and HZ-1500 modes.

The keyboard can be unlocked with the sequences shown below or by placing the terminal in Set-Up mode and pressing the Set-Up key.

#### Unlock Keyboard

WY-50	TVI-910	TVI-920	TVI-925	HZ-1500	ADDS-VP
SO				~ ACK	STX
ESC "	ESC "	ESC "	ESC "	ESC "	ESC 6

These sequences when received from the host will unlock the keyboard. The enhance feature must be selected in Set-Up mode for the sequence, ESC ", to be valid in the HZ-1500 mode.



## ASCII APPLICATION

### XON/XOFF PROTOCOL CONTROL

#### Enable XON/XOFF

WY-50	TVI-910	TVI-920	TVI-925	HZ-1500	ADDS-VP
	SI	SI	SI		

#### Disable XON/XOFF

WY-50	TVI-910	TVI-920	TVI-925	HZ-1500	ADDS-VP
	SO	SO	SO		

In the TVI modes XON/XOFF protocol can be enabled or disabled with the control codes listed above.

### ENTER END-OF-MESSAGE (ETX)

WY-50	TVI-910	TVI-920	TVI-925	HZ-1500	ADDS-VP
ESC 9	ESC 9	ESC 9	ESC 9	ESC 9	ESC 9

This sequence inserts at the current cursor position an End-Of-Message (ETX) control code (03H). Any characters moved beyond the right margin are lost.

The enhance feature must be selected in Set-Up mode for the sequence to be valid in the ADDS-VP and HZ-1500 modes.

### ENTER START-OF-MESSAGE (STX)

WY-50	TVI-910	TVI-920	TVI-925	HZ-1500	ADDS-VP
ESC 8	ESC 8	ESC 8	ESC 8	ESC 8	ESC 8

This sequence inserts at the current cursor position an End-Of-Message (ETX) control code (03H). Any characters moved beyond the right margin are lost.

The enhance feature must be selected in Set-Up mode for the sequence to be valid in the ADDS-VP and HZ-1500 modes.

## ASCII APPLICATION

### TRANSMISSION TO HOST

The following sequences cause the terminal to send to the host information regarding status of the terminal and display screen.

### IDENTIFY TERMINAL MODE

WY-50	TVI-910	TVI-920	TVI-925	HZ-1500	ADDS-VP
ESC SP	ESC SP	ESC SP	ESC SP	ESC SP	ESC SP

This sequences asks for the terminal operating mode. The response for each mode is:

<u>MODE</u>	<u>RESPONSE</u>
WY-50	50 CR
TVI-910	
TVI-920	
TVI-925	
HZ-1500	
ADDS-VP	

### READ CURSOR ADDRESS AND TEXT SEGMENT

WY-50	TVI-910	TVI-920	TVI-925	HZ-1500	ADDS-VP
ESC /	ESC /	ESC /	ESC /	ESC /	ESC /

This sequence asks the terminal to transmit the active text segment number and cursor address.

The enhance feature must be selected in Set-Up mode for the sequence to be valid in the ADDS-VP and HZ-1500 modes.

### READ CURSOR ROW AND COLUMN (80-COLUMN)

WY-50	TVI-910	TVI-920	TVI-925	HZ-1500	ADDS-VP
ESC ?	ESC ?	ESC ?	ESC ?	~ ENQ	ESC ?

This sequence asks the terminal to send the cursor address for the active text segment of an 80-column screen only. The format for the reply is Pr Pc CR, where Pr is the row and Pc is the column for each of the emulation modes as defined in the Row/Column code table.

The enhance feature must be selected in Set-Up mode for the sequence to be valid in the ADDS-VP mode.

## ASCII APPLICATION

### READ CURSOR ROW AND COLUMN (132-COLUMN)

WY-50	TVI-910	TVI-920	TVI-925	HZ-1500	ADDS-VP
ESC b	ESC b	ESC b	ESC b	ESC b	ESC b

Transmits the cursor address to the host computer for the active text segment. The format is:

Pr R Pc C

where

Pr = The ASCII encoded decimal value of the row

R = ASCII R (52H)

Pc = the ASCII encoded decimal value of the column

C = ASCII C (43H)

For example, the report to the host for a position of row 8, column 12 would in following hexadecimal code:

38H 52H 31H 32H 43H  
( 8 R 1 2 C )

The enhance feature must be selected in Set-Up mode for the sequence to be valid in the ADDS-VP and HZ-1500 modes.

### SEND CHARACTER

WY-50	TVI-910	TVI-920	TVI-925	HZ-1500	ADDS-VP
ESC M	ESC M	ESC M	ESC M	ESC M	ESC M

This sequence causes the terminal to send the character at the cursor position to the host computer.

The enhance feature must be selected in Set-Up mode for the sequence to be valid in the ADDS-VP and HZ-1500 modes.

## ASCII APPLICATION

### SEND MESSAGE

WY-50	TVI-910	TVI-920	TVI-925	HZ-1500	ADDS-VP
ESC s	ESC s	ESC s	ESC s	ESC s	ESC s

This sequence sends a message to the host. The message is defined as the first character after the first start-of-text (STX) control character left of the cursor position to the a following end-of-text (ETX) control character. At the end of each row encountered the row end sequence is sent to the host. The ETX code is sent as the transmission terminator.

When the protect mode is on, the start of protected fields are marked with the protect on control, ESC), and the end of the protected field with the protect off control, ESC(.

The enhance feature must be selected in Set-Up mode for the sequence to be valid in the ADDS-VP and HZ-1500 modes.

### SEND UNPROTECTED MESSAGE

WY-50	TVI-910	TVI-920	TVI-925	HZ-1500	ADDS-VP
ESC S	ESC S	ESC S	ESC S	ESC S	ESC S

This sequence provides the same function as the send message control sequence, except the message is sent as unprotected characters. The protect on and off control sequences are not sent. If the protect mode is on, a FS (1CH) code is sent to separate protected character fields. The enhance feature must be selected in Set-Up mode for the sequence to be valid in the ADDS-VP and HZ-1500 modes.

### SEND PAGE

WY-50	TVI-910	TVI-920	TVI-925	HZ-1500	ADDS-VP
ESC 7	ESC 7	ESC 7	ESC 7	ESC 7	ESC 7

This sequence asks the terminal to send all characters from the start-of-text (STX) marker up to and including the cursor position to the host computer.

The enhance feature must be selected in Set-Up mode for the sequence to be valid in the ADDS-VP and HZ-1500 modes.

## ASCII APPLICATION

### SEND UNPROTECTED PAGE

WY-50	TVI-910	TVI-920	TVI-925	HZ-1500	ADDS-VP
ESC 5	ESC 5	ESC 5	ESC 5	ESC 5	

This sequence asks the terminal to send all unprotected characters from the start-of-text (STX) marker up to and including the cursor position to the host computer.

The enhance feature must be selected in Set-Up mode for the sequence to be valid in the HZ-1500 mode.

### SEND ROW

WY-50	TVI-910	TVI-920	TVI-925	HZ-1500	ADDS-VP
ESC 6	ESC 6	ESC 6	ESC 6	ESC 6	

This sequence asks the terminal to send all characters from the start of the row the cursor is on, up to and including the cursor position to the host computer.

The enhance feature must be selected in Set-Up mode for the sequence to be valid in the HZ-1500 mode.

### SEND UNPROTECTED ROW

WY-50	TVI-910	TVI-920	TVI-925	HZ-1500	ADDS-VP
ESC 4	ESC 4	ESC 4	ESC 4	ESC 4	

This sequence asks the terminal to send all unprotected characters from the start-of-row up to and including the cursor position to the host computer.

The enhance feature must be selected in Set-Up mode for the sequence to be valid in the HZ-1500 mode.

## ASCII APPLICATION

### PRINTER CONTROLS

The following sequences control the operation and flow of data to the AUX port.

#### AUX PORT ENABLE

##### Aux Print Off

WY-50	TVI-910	TVI-920	TVI-925	HZ-1500	ADDS-VP
DC4	DC4 ESC A	DC4 ESC A	DC4 ESC A	DC4	DC4

##### Aux Print On

WY-50	TVI-910	TVI-920	TVI-925	HZ-1500	ADDS-VP
DC2	DC2 ESC @	DC2 ESC @	DC2 ESC @	DC2	DC2

These sequences enable and disable the auxiliary port output.

The enhance feature must be selected in Set-Up mode for the sequences to be valid in the HZ-1500 mode.

### SEND DATA TO AUX PORT CONTROLS

##### Send All Unformatted

WY-50	TVI-910	TVI-920	TVI-925	HZ-1500	ADDS-VP
ESC L ESC p	ESC L ESC p	ESC L ESC p	ESC L ESC p	ESC L ESC p	ESC L ESC p

These sequences send all characters unformatted to the auxiliary port. Attribute codes are sent as spaces. Row-end sequences are not sent.

The enhance feature must be selected in Set-Up mode for the sequence to be valid in the ADDS-VP and HZ-1500 modes.

## ASCII APPLICATION

### Send Entire Page

WY-50	TVI-910	TVI-920	TVI-925	HZ-1500	ADDS-VP
ESC P	ESC P	ESC P	ESC P	ESC P	ESC P

Sends all protected and unprotected characters to the auxiliary port, regardless of the mode setting.

The enhance feature must be selected in Set-Up mode for the sequence to be valid in the ADDS-VP and HZ-1500 modes.

### Send All Unprotected

WY-50	TVI-910	TVI-920	TVI-925	HZ-1500	ADDS-VP
ESC @				ESC @	ESC @

All unprotected characters from the start-of-text marker to the current cursor position are sent to the aux port. A CR LF NULL code sequence (4DH 4AH 00H) is sent at the end of each row.

Spaces are substituted for all protected characters and attributes.

Graphic characters are sent as spaces if protect mode is on, or as the corresponding control code if protect mode is on.

The enhance feature must be selected in Set-Up mode for the sequence to be valid in the ADDS-VP and HZ-1500 modes.

## TRANSPARENT PRINT MODE CONTROLS

### Print Mode Off

WY-50	TVI-910	TVI-920	TVI-925	HZ-1500	ADDS-VP
DC4	ESC a		ESC a		ESC 4

### Print Mode On

WY-50	TVI-910	TVI-920	TVI-925	HZ-1500	ADDS-VP
CAN	ESC '		ESC '		ESC 3

These sequences enable and disable the transparent print mode. When the transparent print mode is enabled all data received at the COMM port is sent to the AUX port.

## Appendix A -- SPECIFICATIONS

---

### DISPLAY

<b>CRT</b>	14 inch diagonal, non-glare, choice of P4 white, P31 green or PLA amber phosphor
<b>USABLE SCREEN</b>	horizontal: 23 cm (9 in) vertical: 17 cm (6.7 in)
<b>FORMAT</b>	24 data rows x 80 or 132 characters (selectable), light on dark or reverse with selectable 25th status line and 26th label line
<b>CHAR. MATRIX</b>	7X9 dot matrix within a 10X13 cell in 80 column 26th row mode
<b>CHAR. FONTS</b>	96 character ASCII set 32 character ASCII control set 32 character graphics set WYSE-50 graphics character subset 48 nonenglish character set
<b>CURSOR TYPES</b>	block, underline, invisible
<b>CURSOR ATTRIB.</b>	blinking or nonblinking
<b>VIDEO ATTRIB. (FIELD)</b>	normal, blink, reverse, underscore, bold, double-wide
<b>VIDEO ATTRIB. (CHARACTER)</b>	normal, blink, reverse, underscore, bold
<b>SCROLLING</b>	Variable speed smooth, jump, or split screen



## Appendix A

### KEYBOARD

<b>GENERAL</b>	low profile, DIN standard detachable keyboard with three position tilt adjustment and 1.8 M (6 FT.) coiled cord (RJ-11 type-connector)
<b>KEY LAYOUT</b>	101 keys: including a 65-key main pad, a full auxiliary keypad and 16 function keys
<b>AUX KEYPAD</b>	18-key numeric pad with period, comma, minus(-), ENTER and 4 function keys

### COMMUNICATION

<b>TYPE</b>	full-duplex asynchronous with selectable local echo and full or half duplex modem control
<b>INTERFACE</b>	bidirectional EIA RS232C with 25-pin D-type male connector in data terminal (DTE) configuration optional EIA RS422/423 or 20 mA current loop
<b>SPEEDS</b>	150, 300, 600, 1200, 2400, 4800, 9600, 19200, 38400 bps
<b>CHARACTER LENGTH</b>	7 or 8 bits with 1 or 2 stop bits (kybd selectable)
<b>PARITY</b>	even, odd, mark, space or none (kybd selectable)
<b>CONTROL CODES</b>	Wyse WY-50 (Lear Siegler ADM 31, ADDS VIEWPOINT, TVI 910, TVI 920, TVI 925, HAZELTINE 1500), CIT-101e (DEC VT52-VT100-VT102)

### AUXILIARY PORT

<b>TYPE</b>	Bidirectional RS232C with 25-pin female D-type connector configured as data communications equipment (DCE)
-------------	--

**ELECTRICAL**

**LINE VOLTAGE** 90 to 132 VAC single phase 3-wire  
**LINE FREQ** 47 to 63 Hz  
**VISUAL INDICATOR** LED power indicator on front of monitor  
**LINE CURRENT** 1.1 amps max at 100 to 120VAC  
**INPUT POWER** 50 WATTS  
**POWER CORD** detachable, 3 conductor, grounded 2M (6.5 FT)

**DIMENSIONS**

**MONITOR** weight: 9.07 kg (20 lb)  
height: 33 cm (13 in)  
width: 32.4 cm (12.75 in)  
depth: 34.3 cm (13.5 in)  
**KEYBOARD** weight: 1.47 kg (3.25 lb)  
height: 3.97 cm (1.56 in)  
width: 43.4 cm (17 in)  
depth: 17.4 cm (6.85 in)  
tilt: 5 degrees maximum

**ENVIRONMENT**

**OPERATING** temperature: 10° to 40° C (50° to 105° F)  
rel. humidity: 20% to 90% (noncondensing)  
altitude: 2.4 Km (7800 ft)  
**NON-OPERATING** temperature: -40° to 60° C (-40° to 150° F)  
rel. humidity: 10% to 95% (noncondensing)  
altitude: 9.1 Km (29,850 ft)



**Appendix B -- INTERFACE CIRCUITS**

---

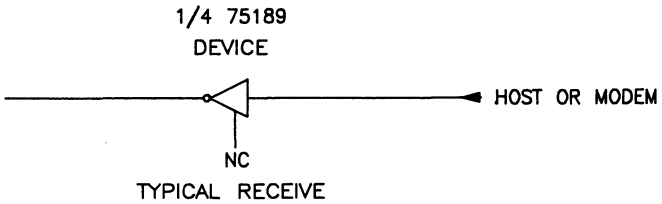
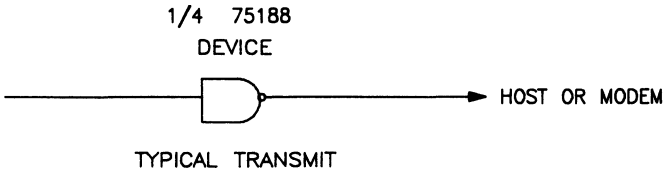

REFER TO MANUFACTURER'S SPECIFICATIONS FOR  
DEVICE ELECTRICAL CHARACTERISTICS.

## Appendix B

### Communication D Connector Pin Assignments

Pin	Mnemonic	Function	Notes
1	SGND	Signal Ground	Chassis and reference ground.
2	TXD	Transmit Data	Transmits serial data from the terminal.
3	RXD	Receive Data	Receives serial data into the terminal.
4	RTS	Request to Send	Asks the host to transmit.
5	CTS	Clear to Send	Tells the terminal that the host is ready to transmit.
6	DSR	Data Set Ready	Tells the terminal the host is in the data mode and is ready to exchange RTS, CTS and CD.
7	SGND	Signal Ground	Chassis and reference ground.
8	CD	Carrier Detect	Tells the terminal that the signal received on the communication line is of adequate quality to ensure proper demodulation of received data. If off, indicates no signal received or signal not suited for demodulation.
12	SI	Speed Select	Enables modem to control speed.
20	DTR	Data Terminal Ready	Tells the host that the terminal is ready to transmit or receive.
22	CE	Ring Indicator	
23	SPDS	Speed Selector	

### Male D Connector Pin Locations (labeled COMM)

## Appendix B

### AUX Port D Connector Pin Assignments

Pin	Mnemonic	Function	Notes
1	PGND	Protective Ground	Chassis ground.
2	TXD	Transmitted Data	Transmits serial data from the terminal.
3	RXD	Received Data	Receives serial data into the terminal.
6	DSR	Data Set Ready	Indicates that aux device is ready to receive data.
7	SGND	Signal Ground	Chassis and reference ground.
20	DTR	Data Term. Ready	Indicates that the terminal is ready to receive data

### Female D Connector Pin Locations (labeled AUX)

**MODEMS**

The CIT224 operates with modems with standard EIA RS-232-C and RS-423 interfaces, and is in accordance with national and international standards and recommendations. The modems at the terminal end and at the host computer end must be compatible with each other.

**COMMUNICATIONS PORT PROTOCOL**

The CIT224 terminal utilizes XON/XOFF handshake protocols for control of data flow. The following describes the communications XON/XOFF handshake controls.

Incoming characters are stored by the terminal in a receiver buffer manager that transmits XON/XOFF control. The manager processes the characters on a first-in/first-out basis. It does so on the appropriate transitions of the receiver buffer minimum and maximum thresholds determined by the terminal's logic. When the receiver buffer fills to the maximum number of characters the terminal transmits an XOFF character to inhibit the host computer from sending more data.

An XON is asserted to resume communications when the data in the receiver buffer falls below 20% of the buffer space. Additional conditions that transmit XON are:

- A Clear Comm function
- A Recall function
- Completion of the self-test
- Pressing the HOLD SCREEN key to "free" the screen when the receiver buffer is at or below the XON point.

**NOTE:** If XOFF is disabled in Set-Up, the receiver buffer manager is inactive and does not transmit an XOFF character to the host computer. The keyboard HOLD SCREEN key is inactive also. There is no way to ensure that characters will not be lost.

The receiver buffer continues to fill with characters if XOFF is disabled. Any characters received after the buffer has filled up are lost. Reverse question marks appear on the screen replacing the lost characters.

## **Appendix B**

### **Unrecognized XON/XOFF Characters**

Software packages that do not recognize XON/XOFF characters sent from the terminal may access the terminal's features in the following ways:

through the use of fill characters, or  
by limiting the send/receive rate to 9600 and avoiding the use of an escape code, slow scrolling, the printer port, and the split screen.

### **Modem Connect/Disconnect**

A modem may be used to connect the terminal to the host computer. When connected, all buffers, transmissions in progress, and XOFF's are cleared by the terminal, and the keyboard is unlocked if it is in the locked condition.

To disconnect the communications line, press the SHIFT BREAK keys.

Other actions that cause a disconnect between the host computer and terminal are:

- Selecting Recall or Default in the Set-Up mode
- The loss of a Data Set Ready (DSR) signal
- The loss of a carrier detect signal for 2 seconds (or 60 ms) as determined in the Communications Set-Up menu
- Lack of a carrier detect signal within 30 seconds after a DSR
- The host sends a self-test directive to the terminal





## Appendix C -- ASCII CODE CHART

		COLUMN															
		0	1	2	3	4	5	6	7	0	1	2	3	4	5	6	7
ROW	0	NUL	00 00	DLE	16 10	SP	32 20	0	48 30	@	64 40	P	80 50	`	96 80	p	112 70
	1	SOH	01 01	DC1	17 11	!	33 21	1	49 31	A	65 41	Q	81 51	a	97 81	q	113 71
	2	STX	02 02	DC2	18 12	"	34 22	2	50 32	B	66 42	R	82 52	b	98 82	r	114 72
	3	ETX	03 03	DC3	19 13	#	35 23	3	51 33	C	67 43	S	83 53	c	99 83	s	115 73
	4	EOT	04 04	DC4	20 14	\$	36 24	4	52 34	D	68 44	T	84 54	d	100 84	t	116 74
	5	ENQ	05 05	NAK	21 15	%	37 25	5	53 35	E	69 45	U	85 55	e	101 85	u	117 75
	6	ACK	06 06	SYN	22 16	&	38 26	6	54 36	F	70 46	V	86 56	f	102 86	v	118 76
	7	BEL	07 07	ETB	23 17	'	39 27	7	55 37	G	71 47	W	87 57	g	103 87	w	119 77
	8	BS	08 08	CAN	24 18	(	40 28	8	56 38	H	72 48	X	88 58	h	104 88	x	120 78
	9	HT	09 09	EM	25 19	)	41 29	9	57 39	I	73 49	Y	89 59	i	105 89	y	121 79
	10	LF	10 0A	SUB	26 1A	*	42 2A	:	58 3A	J	74 4A	Z	90 5A	j	106 8A	z	122 7A
	11	VT	11 0B	ESC	27 1B	+	43 2B	;	59 3B	K	75 4B	[	91 5B	k	107 8B	{	123 7B
	12	FF	12 0C	FS	28 1C	,	44 2C	<	60 3C	L	76 4C	\	92 5C	l	108 8C		124 7C
	13	CR	13 0D	GS	29 1D	-	45 2D	=	61 3D	M	77 4D	]	93 5D	m	109 8D	}	125 7D
	14	SO	14 0E	RS	30 1E	.	46 2E	>	62 3E	N	78 4E	^	94 5E	n	110 8E	~	126 7E
	15	SI	15 0F	US	31 1F	/	47 2F	?	63 3F	O	79 4F	_	95 5F	o	111 8F	DEL	127 7F

← CO CODES →

← GL CODES →

### KEY

Character

ESC	27
	1B

Decimal

Hexadecimal



## Appendix D -- ASCII MODE GENERATED KEYBOARD CODES

---

### CONTROL KEYS

#### ESC

WYSE 50	TVI 910	TVI 920	TVI 925	HZ 1500	ADDS VP
ESC	ESC	ESC	ESC	ESC	ESC

#### BACKSPACE

WYSE 50	TVI 910	TVI 920	TVI 925	HZ 1500	ADDS VP
BS	BS	BS	BS	BS	BS

#### RETURN

WYSE 50	TVI 910	TVI 920	TVI 925	HZ 1500	ADDS VP
CR or CR LF	CR or CR LF	CR or CR LF	CR or CR LF	CR or CR LF	CR or CR LF

#### TAB

WYSE 50	TVI 910	TVI 920	TVI 925	HZ 1500	ADDS VP
HT	HT	HT	HT	HT	HT

#### TAB with SHIFT key

WYSE 50	TVI 910	TVI 920	TVI 925	HZ 1500	ADDS VP
ESC I	ESC I	ESC I	ESC I	~HT	ESC I

## Appendix D

### CURSOR POSITION KEYS

#### ↓ (CURSOR DOWN)

WYSE 50	TVI 910	TVI 920	TVI 925	HZ 1500	ADDS VP
LF	LF	LF	SYN	ESC VT	LF

#### ↓ (CURSOR DOWN) with SHIFT key

WYSE 50	TVI 910	TVI 920	TVI 925	HZ 1500	ADDS VP
LF	LF	LF	LF	LF	LF

#### ← (CURSOR LEFT)

WYSE 50	TVI 910	TVI 920	TVI 925	HZ 1500	ADDS VP
BS	BS	BS	BS	BS	NAK

#### → (CURSOR RIGHT)

WYSE 50	TVI 910	TVI 920	TVI 925	HZ 1500	ADDS VP
FF	FF	FF	FF	DLE	ACK

#### ↑ (CURSOR UP)

WYSE 50	TVI 910	TVI 920	TVI 925	HZ 1500	ADDS VP
VT	VT	VT	VT	~FF	SUB

#### CLEAR HOME

WYSE 50	TVI 910	TVI 920	TVI 925	HZ 1500	ADDS VP
RS	RS	RS	RS	~DC2	SOH

**CURSOR POSITION KEYS (Continued)**

CLEAR HOME with SHIFT key

WYSE 50	TVI 910	TVI 920	TVI 925	HZ 1500	ADDS VP
ESC }	ESC }	ESC }	ESC }	~DC2	SOH

**EDITING KEYS**

INSERT LINE/CHARACTER (PF1)

CHARACTER (UNSHIFTED)

WYSE 50	TVI 910	TVI 920	TVI 925	HZ 1500	ADDS VP
ESC Q	ESC Q	ESC Q	ESC Q	STX	ESC Q

LINE (SHIFTED)

WYSE 50	TVI 910	TVI 920	TVI 925	HZ 1500	ADDS VP
ESC E	ESC E	ESC E	ESC E	~SUB	ESC M

DELETE LINE/CHARACTER (PF2)

CHARACTER (UNSHIFTED)

WYSE 50	TVI 910	TVI 920	TVI 925	HZ 1500	ADDS VP
ESC W	ESC W	ESC W	ESC W	ETX	ESC W

LINE (SHIFTED)

WYSE 50	TVI 910	TVI 920	TVI 925	HZ 1500	ADDS VP
ESC R	ESC R	ESC R	ESC R	~DC3	ESC I

**Appendix D**

**EDITING KEYS (Continued)**

**CLEAR SCREEN/LINE (PF3)**

LINE (UNSHIFTED)

WYSE 50	TVI 910	TVI 920	TVI 925	HZ 1500	ADDS VP
ESC T	ESC T	ESC T	ESC T	~SI	ESC K

SCREEN (SHIFTED)

WYSE 50	TVI 910	TVI 920	TVI 925	HZ 1500	ADDS VP
ESC Y	ESC Y	ESC Y	ESC Y	~FS	ESC k

**INSERT/REPLACE (PF4)**

INSERT (SHIFTED)

WYSE 50	TVI 910	TVI 920	TVI 925	HZ 1500	ADDS VP
ESC q	ESC q	ESC q	ESC q	NAK	ESC q

REPLACE (UNSHIFTED)

WYSE 50	TVI 910	TVI 920	TVI 925	HZ 1500	ADDS VP
ESC r	ESC r	ESC r	ESC r	EOT	ESC r

**SPECIAL-PURPOSE KEYS**

**ENTER**

WYSE 50	TVI 910	TVI 920	TVI 925	HZ 1500	ADDS VP
CR or HT	CR or HT	CR or HT	CR or HT	CR or HT	CR or HT

**PRINT (LINE FEED UNSHIFTED)**

WYSE 50	TVI 910	TVI 920	TVI 925	HZ 1500	ADDS VP
ESC P	ESC P	ESC P	ESC P	ACK	ESC P

**SEND (LINE FEED SHIFTED)**

WYSE 50	TVI 910	TVI 920	TVI 925	HZ 1500	ADDS VP
ESC 7	ESC 7	ESC 7	ESC 7	~7	ESC 7

**NEXT PAGE/PREV PAGE**

UNSHIFTED (NEXT PAGE)

WYSE 50	TVI 910	TVI 920	TVI 925	HZ 1500	ADDS VP
ESC K	ESC K	ESC K	ESC K	SOH	ESC J

SHIFTED (PREV PAGE)

WYSE 50	TVI 910	TVI 920	TVI 925	HZ 1500	ADDS VP
ESC J	ESC J	ESC J	ESC J	ENQ	ESC J





## Appendix E -- ASCII CONTROL CODE SUMMARY

---

### OPERATING MODE CONTROLS

#### COMMUNICATION MODES

##### BLOCK MODE ON

WY-50	TVI-910	TVI-920	TVI-925	HZ-1500	ADDS-VP
ESC B	ESC B	ESC B	ESC B	ESC B	ESC B

##### CONVERSATION MODE ON

WY-50	TVI-910	TVI-920	TVI-925	HZ-1500	ADDS-VP
ESC C	ESC C	ESC C	ESC C	ESC C	ESC C

##### DUPLEX MODE CONTROL SEQUENCES

###### Full Duplex On

WY-50	TVI-910	TVI-920	TVI-925	HZ-1500	ADDS-VP
ESC D F	ESC D F	ESC D F	ESC D F	ESC D F	ESC D F

###### Half-Duplex Block On

WY-50	TVI-910	TVI-920	TVI-925	HZ-1500	ADDS-VP
ESC D H then ESC B	ESC D H then ESC B	ESC D H then ESC B	ESC D H then ESC B	ESC D H then ESC B	ESC D H then ESC B

#### TERMINAL OPERATING SUBMODES

##### GRAPHIC CHARACTER SUBMODE

###### Mode Off

WY-50	TVI-910	TVI-920	TVI-925	HZ-1500	ADDS-VP
ESC H ETX	ESC H ETX	ESC H ETX	ESC H ETX	ESC H ETX	ESC H ETX

###### Mode On

WY-50	TVI-910	TVI-920	TVI-925	HZ-1500	ADDS-VP
ESC H STX	ESC H STX	ESC H STX	ESC H STX	ESC H STX	ESC H STX

**INSERT/REPLACE SUBMODE**

**Insert Submode On**

WY-50	TVI-910	TVI-920	TVI-925	HZ-1500	ADDS-VP
ESC q	ESC q		ESC q	ESC q	ESC q

**Replace Submode On**

WY-50	TVI-910	TVI-920	TVI-925	HZ-1500	ADDS-VP
ESC r	ESC r		ESC r	ESC r	ESC r

**EDIT SUBMODE**

**Local Edit Submode On**

WY-50	TVI-910	TVI-920	TVI-925	HZ-1500	ADDS-VP
ESC k			ESC k		

**Duplex Edit Submode On**

WY-50	TVI-910	TVI-920	TVI-925	HZ-1500	ADDS-VP
ESC l			ESC l		

**SCROLL SUBMODE**

**Scroll Submode On**

WY-50	TVI-910	TVI-920	TVI-925	HZ-1500	ADDS-VP
ESC o				ESC o	ESC o

**Scroll Submode Off**

WY-50	TVI-910	TVI-920	TVI-925	HZ-1500	ADDS-VP
ESC n				ESC n	ESC n

## Appendix E

### PROTECT SUBMODE

#### Protect Submode Off

WY-50	TVI-910	TVI-920	TVI-925	HZ-1500	ADDS-VP
ESC '	ESC '	ESC '	ESC '	ESC '	ESC '

#### Protect Submode On

WY-50	TVI-910	TVI-920	TVI-925	HZ-1500	ADDS-VP
ESC &	ESC &	ESC &	ESC &	ESC &	ESC &

### WRITE PROTECT SUBMODE

#### Write protect Submode Off

WY-50	TVI-910	TVI-920	TVI-925	HZ-1500	ADDS-VP
ESC (	ESC (	ESC (	ESC (	~ US	SI

#### Write Protect Submode On

WY-50	TVI-910	TVI-920	TVI-925	HZ-1500	ADDS-VP
ESC )	ESC )	ESC )	ESC )	~ EM	SO

### MONITOR SUBMODE

#### Submode Off

WY-50	TVI-910	TVI-920	TVI-925	HZ-1500	ADDS-VP
ESC u	ESC u	ESC u	ESC u	ESC u	ESC u
ESC X	ESC X	ESC X	ESC X	ESC X	ESC X

#### Submode On

WY-50	TVI-910	TVI-920	TVI-925	HZ-1500	ADDS-VP
ESC U	ESC U	ESC U	ESC U	ESC U	ESC U

**DISPLAY CONTROL**

**SPLIT SCREEN FORMAT CONTROLS**

**Enable Split Screen Mode**

WY-50	TVI-910	TVI-920	TVI-925	HZ-1500	ADDS-VP
ESC x	ESC	ESC	ESC	ESC x	ESC x

**ACTIVATE TEXT SEGMENT**

**Upper Text Segment**

WY-50	TVI-910	TVI-920	TVI-925	HZ-1500	ADDS-VP
ESC ]				ESC ]	ESC ]

**Lower Text Segment**

WY-50	TVI-910	TVI-920	TVI-925	HZ-1500	ADDS-VP
ESC }	ESC }	ESC }	ESC }	ESC }	ESC }

**Alternate Text Segment**

WY-50	TVI-910	TVI-920	TVI-925	HZ-1500	ADDS-VP
ESC J	ESC J	ESC J	ESC J	ESC J	ESC J
ESC K	ESC K	ESC K	ESC K	ESC K	

**MOVE CURSOR TO SPECIFIC TEXT SEGMENT**

WY-50	TVI-910	TVI-920	TVI-925	HZ-1500	ADDS-VP
ESC -	ESC -	ESC -	ESC -	ESC -	ESC -

**SELECT SCREEN FEATURES**

WY-50	TVI-910	TVI-920	TVI-925	HZ-1500	ADDS-VP
ESC '	ESC .	ESC .	ESC .	ESC '	ESC '

## Appendix E

### CHARACTER DISPLAY ATTRIBUTES

#### Set Display Field Attributes

WY-50	TVI-910	TVI-920	TVI-925	HZ-1500	ADDS-VP
ESC G	ESC G	ESC G	ESC G	ESC G	ESC G

#### Set Attribute for Message Field/Screen

WY-50	TVI-910	TVI-920	TVI-925	HZ-1500	ADDS-VP
ESC A	ESC \	ESC \	ESC \	ESC A	ESC A

### ADDITIONAL ATTRIBUTE CONTROLS

#### Set Attribute For Protected Character

WY-50	TVI-910	TVI-920	TVI-925	HZ-1500	ADDS-VP
					ESC 0

#### Set Protected Column

WY-50	TVI-910	TVI-920	TVI-925	HZ-1500	ADDS-VP
ESC V	ESC V	ESC V	ESC V	ESC V	ESC V

### BLANK AND BLINKING FIELD ATTRIBUTE (TVI-920 MODE)

#### Start Blank Field Attribute

WY-50	TVI-910	TVI-920	TVI-925	HZ-1500	ADDS-VP
		ESC _			

#### Start Blink Field Attribute

WY-50	TVI-910	TVI-920	TVI-925	HZ-1500	ADDS-VP
		ESC ^			

#### End Blank/Blink Field Attribute

WY-50	TVI-910	TVI-920	TVI-925	HZ-1500	ADDS-VP
		ESC q			

**REVERSE VIDEO FIELD ATTRIBUTE CONTROL**

**Start Reverse Video Field Attribute**

WY-50	TVI-910	TVI-920	TVI-925	HZ-1500	ADDS-VP
		ESC j			

**End Reverse Video Field Attribute**

WY-50	TVI-910	TVI-920	TVI-925	HZ-1500	ADDS-VP
		ESC k			

**UNDERLINE FIELD ATTRIBUTE CONTROL**

**Start Underline Field Attribute**

WY-50	TVI-910	TVI-920	TVI-925	HZ-1500	ADDS-VP
		ESC l			

**End Underline Field Attribute**

WY-50	TVI-910	TVI-920	TVI-925	HZ-1500	ADDS-VP
		ESC m			

**TAB AND CARRIAGE CONTROLS**

**Carriage Return**

WY-50	TVI-910	TVI-920	TVI-925	HZ-1500	ADDS-VP
CR	CR	CR	CR	CR	CR

**Carriage Return (New Line)**

WY-50	TVI-910	TVI-920	TVI-925	HZ-1500	ADDS-VP
US	US	US	US	US	US

**Set Tab**

WY-50	TVI-910	TVI-920	TVI-925	HZ-1500	ADDS-VP
ESC 1	ESC 1	ESC 1	ESC 1	ESC 1	ESC 1

## Appendix E

### TAB AND CARRIAGE CONTROLS (Continued)

#### Clear Single Tab

WY-50	TVI-910	TVI-920	TVI-925	HZ-1500	ADDS-VP
ESC 2	ESC 2	ESC 2	ESC 2	ESC 2	ESC 2

#### Clear All Tabs

WY-50	TVI-910	TVI-920	TVI-925	HZ-1500	ADDS-VP
ESC 0	ESC 3	ESC 3	ESC 3	ESC 3	

#### Tab Position

WY-50	TVI-910	TVI-920	TVI-925	HZ-1500	ADDS-VP
HT ESC i	HT ESC i	HT ESC i	HT ESC i	HT ESC i	HT

#### Back Tab

WY-50	TVI-910	TVI-920	TVI-925	HZ-1500	ADDS-VP
ESC I	ESC I	ESC I	ESC I	ESC I	ESC I

### CURSOR CONTROL

#### Home Cursor

WY-50	TVI-910	TVI-920	TVI-925	HZ-1500	ADDS-VP
RS ESC {	RS ESC {	RS ESC {	RS ESC {	~DC2 ESC {	SOH ESC {

#### Move Cursor Down (no scroll)

WY-50	TVI-910	TVI-920	TVI-925	HZ-1500	ADDS-VP
			SYN	~ VT	

#### Move Cursor (scroll)

WY-50	TVI-910	TVI-920	TVI-925	HZ-1500	ADDS-VP
LF	LF	LF	LF	LF	LF



## CURSOR CONTROL(continued)

## Move Cursor Left

WY-50	TVI-910	TVI-920	TVI-925	HZ-1500	ADDS-VP
BS	BS	BS	BS	BS	NAK

## Move Cursor Right

WY-50	TVI-910	TVI-920	TVI-925	HZ-1500	ADDS-VP
FF	FF	FF	FF	DLE	ACK

## Move Cursor Up

WY-50	TVI-910	TVI-920	TVI-925	HZ-1500	ADDS-VP
VT	VT	VT	VT	~ FF	SUB

## Move Cursor Up (Scroll)

WY-50	TVI-910	TVI-920	TVI-925	HZ-1500	ADDS-VP
ESC j	ESC j		ESC j		

## Move Cursor to Specific Column or Row

Specific Column

WY-50	TVI-910	TVI-920	TVI-925	HZ-1500	ADDS-VP
	ESC ]				DLE

Specific Row

WY-50	TVI-910	TVI-920	TVI-925	HZ-1500	ADDS-VP
	ESC [				VT

Move Cursor to Specific Row and Column (80-column mode)

WY-50	TVI-910	TVI-920	TVI-925	HZ-1500	ADDS-VP
ESC =	ESC =	ESC =	ESC =	~DC1	ESC Y

Move Cursor to Specific Row and Column (132-column mode)

WY-50	TVI-910	TVI-920	TVI-925	HZ-1500	ADDS-VP
ESC a	ESC d	ESC d	ESC d	ESC a	ESC a

## Appendix E

### ENABLE/DISABLE CURSOR

#### Disable Cursor

WY-50	TVI-910	TVI-920	TVI-925	HZ-1500	ADDS-VP
					ETB

#### Enable Cursor

WY-50	TVI-910	TVI-920	TVI-925	HZ-1500	ADDS-VP
					CAN

### CLEAR SCREEN CONTROLS

#### CLEAR WITH NULL CODE (00H)

##### Clear all to Nulls

WY-50	TVI-910	TVI-920	TVI-925	HZ-1500	ADDS-VP
ESC *	ESC *	ESC *	ESC *	ESC *	FF

##### Clear Unprotected To Nulls

WY-50	TVI-910	TVI-920	TVI-925	HZ-1500	ADDS-VP
ESC :	ESC :	ESC :	ESC :	ESC :	ESC :

##### Clear Unprotected to End of Page with Nulls

WY-50	TVI-910	TVI-920	TVI-925	HZ-1500	ADDS-VP
ESC y	ESC y	ESC y	ESC y	ESC y	ESC y

##### Clear to End of Row with Nulls

WY-50	TVI-910	TVI-920	TVI-925	HZ-1500	ADDS-VP
ESC t	ESC t	ESC t	ESC t	ESC t	ESC t

**CLEAR SCREEN CONTROLS (Continued)**

**CLEAR WITH SPACE CODE (20H)**

**Clear all to Spaces**

WY-50	TVI-910	TVI-920	TVI-925	HZ-1500	ADDS-VP
ESC +		ESC +		ESC +	ESC +

**Clear Unprotected to Spaces**

WY-50	TVI-910	TVI-920	TVI-925	HZ-1500	ADDS-VP
SUB	SUB	SUB	SUB	~ GS	
ESC ;	ESC + ESC ;	ESC ;	ESC + ESC ;	ESC ;	ESC ;

**Clear all to Protected Spaces**

WY-50	TVI-910	TVI-920	TVI-925	HZ-1500	ADDS-VP
ESC ,	ESC ,	ESC ,	ESC ,	~ETB	ESC ,

**Clear to End of Page With Spaces**

WY-50	TVI-910	TVI-920	TVI-925	HZ-1500	ADDS-VP
ESC Y	ESC Y	ESC Y	ESC Y	~CAN	ESC k

**Clear to End of Row with Spaces**

WY-50	TVI-910	TVI-920	TVI-925	HZ-1500	ADDS-VP
ESC T	ESC T	ESC T	ESC T	~SI	ESC K

**CLEAR UNPROTECTED CHARACTERS WITH ATTRIBUTE**

WY-50	TVI-910	TVI-920	TVI-925	HZ-1500	ADDS-VP
ESC !	ESC !	ESC !	ESC !	ESC !	ESC !

**CLEAR UNPROTECTED WITH CODE**

WY-50	TVI-910	TVI-920	TVI-925	HZ-1500	ADDS-VP
ESC .				ESC .	ESC .

## Appendix E

### EDITING CONTROLS

#### DELETE CONTROLS

##### Delete Character

WY-50	TVI-910	TVI-920	TVI-925	HZ-1500	ADDS-VP
ESC W	ESC W	ESC W	ESC W	ESC W	ESC W

##### Delete Row

WY-50	TVI-910	TVI-920	TVI-925	HZ-1500	ADDS-VP
ESC R	ESC R	ESC R	ESC R	ESC R	ESC I

#### INSERT CONTROLS

##### Insert Space

WY-50	TVI-910	TVI-920	TVI-925	HZ-1500	ADDS-VP
ESC Q	ESC Q	ESC Q	ESC Q	ESC Q	ESC Q

##### Insert Row with Spaces

WY-50	TVI-910	TVI-920	TVI-925	HZ-1500	ADDS-VP
ESC E	ESC E	ESC E	ESC E	~ SUB	ESC M

#### TERMINAL CONTROL

##### ENTER HOST MESSAGE

WY-50	TVI-910	TVI-920	TVI-925	HZ-1500	ADDS-VP
ESC F	ESC F	ESC F	ESC F	ESC F	ESC F

**TERMINAL CONTROL (Continued)**

**KEYBOARD LOCK CONTROL**

**Lock Keyboard**

WY-50	TVI-910	TVI-920	TVI-925	HZ-1500	ADDS-VP
SI				~ NAK	EOT
ESC #	ESC #	ESC #	ESC #	ESC #	ESC 5 ESC #

**Unlock Keyboard**

WY-50	TVI-910	TVI-920	TVI-925	HZ-1500	ADDS-VP
SO				~ ACK	STX
ESC "	ESC "	ESC "	ESC "	ESC "	ESC 6

**XON/XOFF PROTOCOL CONTROL**

**Enable XON/XOFF**

WY-50	TVI-910	TVI-920	TVI-925	HZ-1500	ADDS-VP
	SI	SI	SI		

**Disable XON/XOFF**

WY-50	TVI-910	TVI-920	TVI-925	HZ-1500	ADDS-VP
	SO	SO	SO		

**ENTER END-OF-MESSAGE (ETX)**

WY-50	TVI-910	TVI-920	TVI-925	HZ-1500	ADDS-VP
ESC 9	ESC 9	ESC 9	ESC 9	ESC 9	ESC 9

**ENTER START-OF-MESSAGE (STX)**

WY-50	TVI-910	TVI-920	TVI-925	HZ-1500	ADDS-VP
ESC 8	ESC 8	ESC 8	ESC 8	ESC 8	ESC 8

## Appendix E

### TRANSMISSION TO HOST

#### IDENTIFY TERMINAL MODE

WY-50	TVI-910	TVI-920	TVI-925	HZ-1500	ADDS-VP
ESC SP	ESC SP	ESC SP	ESC SP	ESC SP	ESC SP

#### READ CURSOR ADDRESS AND TEXT SEGMENT

WY-50	TVI-910	TVI-920	TVI-925	HZ-1500	ADDS-VP
ESC /	ESC /	ESC /	ESC /	ESC /	ESC /

#### READ CURSOR ROW AND COLUMN (80-COLUMN)

WY-50	TVI-910	TVI-920	TVI-925	HZ-1500	ADDS-VP
ESC ?	ESC ?	ESC ?	ESC ?	~ ENQ	ESC ?

#### READ CURSOR ROW AND COLUMN (132-COLUMN)

WY-50	TVI-910	TVI-920	TVI-925	HZ-1500	ADDS-VP
ESC b	ESC b	ESC b	ESC b	ESC b	ESC b

#### SEND CHARACTER

WY-50	TVI-910	TVI-920	TVI-925	HZ-1500	ADDS-VP
ESC M	ESC M	ESC M	ESC M	ESC M	ESC M

#### SEND MESSAGE

WY-50	TVI-910	TVI-920	TVI-925	HZ-1500	ADDS-VP
ESC s	ESC s	ESC s	ESC s	ESC s	ESC s

#### SEND UNPROTECTED MESSAGE

WY-50	TVI-910	TVI-920	TVI-925	HZ-1500	ADDS-VP
ESC S	ESC S	ESC S	ESC S	ESC S	ESC S

TRANSMISSION TO HOST (Continued)

SEND PAGE

WY-50	TVI-910	TVI-920	TVI-925	HZ-1500	ADDS-VP
ESC 7	ESC 7	ESC 7	ESC 7	ESC 7	ESC 7

SEND UNPROTECTED PAGE

WY-50	TVI-910	TVI-920	TVI-925	HZ-1500	ADDS-VP
ESC 5	ESC 5	ESC 5	ESC 5	ESC 5	

SEND ROW

WY-50	TVI-910	TVI-920	TVI-925	HZ-1500	ADDS-VP
ESC 6	ESC 6	ESC 6	ESC 6	ESC 6	

SEND UNPROTECTED ROW

WY-50	TVI-910	TVI-920	TVI-925	HZ-1500	ADDS-VP
ESC 4	ESC 4	ESC 4	ESC 4	ESC 4	

## Appendix E

### PRINTER CONTROLS

#### AUX PORT ENABLE

##### Aux Print Off

WY-50	TVI-910	TVI-920	TVI-925	HZ-1500	ADDS-VP
DC4	DC4 ESC A	DC4 ESC A	DC4 ESC A	DC4	DC4

##### Aux Print On

WY-50	TVI-910	TVI-920	TVI-925	HZ-1500	ADDS-VP
DC2	DC2 ESC @	DC2 ESC @	DC2 ESC @	DC2	DC2

#### SEND DATA TO AUX PORT CONTROLS

##### Send All Unformatted

WY-50	TVI-910	TVI-920	TVI-925	HZ-1500	ADDS-VP
ESC L ESC p	ESC L ESC p	ESC L ESC p	ESC L ESC p	ESC L ESC p	ESC L ESC p

##### Send Entire Page

WY-50	TVI-910	TVI-920	TVI-925	HZ-1500	ADDS-VP
ESC P	ESC P	ESC P	ESC P	ESC P	ESC P

##### Send All Unprotected

WY-50	TVI-910	TVI-920	TVI-925	HZ-1500	ADDS-VP
ESC @				ESC @	ESC @

#### TRANSPARENT PRINT MODE CONTROLS

##### Print Mode Off

WY-50	TVI-910	TVI-920	TVI-925	HZ-1500	ADDS-VP
DC4	ESC a		ESC a		ESC 4

##### Print Mode On

WY-50	TVI-910	TVI-920	TVI-925	HZ-1500	ADDS-VP
CAN	ESC '		ESC '		ESC 3





## **Appendix F -- ANSI CONTROL CODES AND CONTROL SEQUENCES**

---

### **ANSI KEYBOARD FEATURES**

#### **SMOOTH SCROLL RATE**

<CTRL-SHIFT-↑> to increment the smooth scroll  
<CTRL-SHIFT-↓> to decrement the scroll rate

#### **ANSWERBACK MESSAGE**

**BREAK**

**BACKTAB**

<SHIFT-TAB>

**PAGE SEND**

<SHIFT-ENTER> or <CTRL-PF1>

**HOME CURSOR**

<CLEAR HOME> move to the home position, row 1 column 1  
<SHIFT-CLEAR HOME> move to the home position and clear the display

## Appendix F

### CODES GENERATED AT THE TERMINAL

#### KEYBOARD GENERATED ASCII CONTROL CODES

ASCII MNEMONIC	HEX CODE	KEY	ASCII DEFINITION
NUL	00	@	Null
SOH	01	A	Start of Heading
STX	02	B	Start of Text
ETX	03	C	End of Text
EOT	04	D	End of Transmission
ENQ	05	E	Enquiry
ACK	06	F	Acknowledge
BEL	07	G	Bell
BS	08	H	Backspace
HT	09	I	Horizontal Tabulation
LF	0A	J	Line Feed
VT	0B	K	Vertical Tabulation
FF	0C	L	Form Feed
CR	0D	M	Carriage Return
SO	0E	N	Shift Out
SI	0F	O	Shift In
DLE	10	P	Data Link Escape
DC1 (XON)	11	Q	Device Control 1
DC2	12	R	Device Control 2
DC3 (XOFF)	13	S	Device Control 3
DC4	14	T	Device Control 4
NAK	15	U	Negative Acknowledge
SYN	16	V	Synchronous Idle
ETB	17	W	End of Transmission Block
CAN	18	X	Cancel
EM	19	Y	End of medium
SUB	1A	Z	Substitute
ESC	1B	{ or [	Escape
FS	1C	or \	File Separator
GS	1D	} or ]	Group Separator
RS	1E	~	Record Separator
US	1F		Unit Separator
DEL	7F	DELETE	Delete

**CURSOR POSITIONING KEYS**

**Cursor Key Control Sequences**

Cursor Key (Arrow)	ANSI Mode in Normal Key Mode	ANSI Mode in Appl. Key Mode	VT52 Mode
↑ Up	ESC [A	ESC OA	ESC A
↓ Down	ESC [B	ESC OB	ESC B
→ Right	ESC [C	ESC OC	ESC C
← Left	ESC [D	ESC OD	ESC D

## Appendix F

### NUMERIC KEYPAD

#### Numeric Keypad Generated Codes

Key	ANSI Normal Keypad Numeric Mode	ANSI Hex Keypad Numeric Mode	ANSI Keypad Appli- cation Mode	VT52 Normal Keypad Numeric Mode	VT52 Hex Keypad Numeric Mode	VT52 Keypad Appli- cation Mode
0	0	0	ESC Op	0	0	ESC ?p
1	1	1	ESC Oq	1	1	ESC ?q
2	2	2	ESC Or	2	2	ESC ?r
3	3	3	ESC Os	3	3	ESC ?s
4	4	4	ESC Ot	4	4	ESC ?t
5	5	5	ESC Ou	5	5	ESC ?u
6	6	6	ESC Ov	6	6	ESC ?v
7	7	7	ESC Ow	7	7	ESC ?w
8	8	8	ESC Ox	8	8	ESC ?x
9	9	9	ESC Oy	9	9	ESC ?y
PF1	ESC OP	A	ESC OP	ESC P	A	ESC P
PF2	ESC OQ	B	ESC OQ	ESC Q	B	ESC Q
PF3	ESC OR	C	ESC OR	ESC R	C	ESC R
PF4	ESC OS	D	ESC OS	ESC S	D	ESC S
MINUS	MINUS	E	ESC Om	MINUS	E	ESC ?m
COMMA	COMMA	F	ESC Ol	COMMA	F	ESC ?l
PERIOD	PERIOD	PERIOD	ESC On	PERIOD	PERIOD	ESC ?n
ENTER	RETURN	RETURN	ESC OM	RETURN	RETURN	ESC ?M

**AUXILIARY PORT CONTROLS**

▶ Line Send	<SHIFT-PF1>
▶ Page Send	<CTRL-PF1>
▶ Keyboard Auxiliary Mode	<SHIFT-PF2>
▶ Keyboard COMM Mode	<SHIFT-PF3>
▶ Auto Auxiliary Mode	<CTRL-PF2>
▶ Auxiliary Control Mode	<CTRL-PF3>
▶ Auxiliary Output Disable	<SHIFT-PF4>
▶ Concurrent Auxiliary Mode	<CTRL-PF4>
▶ Auxiliary to COMM Mode	<SHIFT-CTRL-PF2>
▶ Auxiliary to Display Mode	<SHIFT-CTRL-PF3>
▶ Input Disable	<SHIFT-CTRL-PF4>
▶ Print Screen	<SHIFT-ENTER>
▶ Auto Print	<CTRL-ENTER>

**ANSI CONTROL SEQUENCES**

**VT100 Compatible Control Sequences**

**CURSOR CONTROL SEQUENCES**

**Relative Cursor Positioning**

Move cursor up	ESC[PnA
Move cursor down	ESC[PnB
Move cursor right (forward)	ESC[PnC
Move cursor left (backward)	ESC[PnD

**Next Line**

Move cursor down to line Pn	ESC[PnE
-----------------------------	---------

**Previous Line**

Move cursor up to line Pn	ESC[PnF
---------------------------	---------

**Cursor Horizontal Absolute**

Cursor Horizontal Absolute	ESC[PnG
----------------------------	---------

## Appendix F

### CURSOR CONTROL SEQUENCES (Continued)

#### Direct Cursor Positioning

Position cursor	ESC[Pn;PnH or ESC[Pn;Pnf
-----------------	--------------------------------

#### Scroll Direction

Index	ESC D
Reverse Index	ESC M

#### Save and Restore Cursor and Attributes

Save cursor and attributes	ESC 7
Restore cursor and attributes	ESC 8

#### New Line

New Line	ESC E
----------	-------

#### Cursor Attributes

Cursor Attributes	ESC[PsV
Cursor is visible	Ps = 0
Cursor is invisible	1
Cursor is an underline	2
Cursor is a reverse video block	3
Non-blinking cursor	4
Blinking cursor	5

### ERASE CONTROL SEQUENCES

#### Set Erase Character

Set Erase Character	ESC[>Pns
---------------------	----------

#### Erase Character(s)

Erase Character	ESC[PnX
-----------------	---------

#### Erase Within Display

Erase within display	ESC[PsJ
From cursor to end of display	Ps = 0 (Default)
From start of display to cursor	1
Entire display	2

**ERASE CONTROL SEQUENCES (Continued)****Erase Window**

Erase Window	<b>ESC[&gt;3;rt;cl;rb;crJ</b>
	rt = top row
	cl = left column
	rb = bottom row
	cr = right column

**Erase Within Line**

Erase within line	<b>ESC[PsK</b>
From cursor to end of line	Ps = 0 (Default)
From start of line to cursor	1
Entire line	2

**Erase Window Line**

Erase portion of line	<b>ESC[&gt;3;cl;crK</b>
	cl = left column
	cr = right column

**WIDTH/HEIGHT LINE COMMANDS**

Double-height, double-width (top)	<b>ESC#3</b>
Double-height, double-width (bottom)	<b>ESC#4</b>
Single-height, single-width (normal)	<b>ESC#5</b>
Single-height, double-width	<b>ESC#6</b>
Double-height, single-width (top)	<b>ESC#:</b>
Double-height, single-width (bottom)	<b>ESC#;</b>

**VIDEO ATTRIBUTE COMMANDS**

Set video attributes	<b>ESC[PsM</b>
Normal (no attributes)	Ps = 0 (Default)
Bold	1
Underline	4
Blinking	5
Reverse video	7



## Appendix F

### SCROLL CONTROL

#### Set Scrolling Region

Set scrolling region ESC[Pn;Pnr

#### Set Smooth Scroll Rate

Set smooth scroll rate ESC[Pnu

#### Scroll Up

Scroll display up ESC[PnS

#### Scroll Down

Scroll display down ESC[PnT

### TAB CONTROLS

Set TAB STOP at current column ESCH  
Set or clear TAB STOP(s) ESC[Psg

Clear TAB STOP at current column Ps = 0  
Clear all TAB STOPS 3  
Set TAB STOPS at every 8th column >5

#### Horizontal Tab

Horizontal Tab ESC[PnI

#### Horizontal Backtab

Horizontal Backtab ESC[PnZ

### EDITING COMMANDS

#### Insert/Delete Line

Insert Line ESC[PnL  
Delete Line ESC[PnM

#### Insert/Delete Character

Insert character ESC[Pn@  
Delete character ESC[PnP

**TERMINAL MODE CONTROLS****VT52/VT100-Style Scroll Key Modes**

Set to VT52-Style Scroll Key Mode	ESC[>2h
Reset to VT100-Style Scroll Key Mode	ESC[>2l

**Character Insert/Replace Mode**

Set Insert mode	ESC[4h
Reset Replace mode	ESC[4l

**Newline Mode**

Set Newline mode	ESC[20h
Reset to Line Feed mode	ESC[20l

**Cursor Key Application Mode**

Set Cursor Key Application mode	ESC[?1h
Reset Cursor Key Application mode	ESC[?1l

**ANSI/VT52 Modes**

Set to ANSI mode	ESC[?2h
Set to ANSI mode (from VT52 mode)	ESC<
Reset to VT52 mode	ESC[?2l

**80/132 Column Modes**

Set to 132 Column mode	ESC[?3h
Reset to 80 Column mode	ESC[?3l

**Smooth/Jump Scroll Modes**

Set to Smooth Scroll mode	ESC[?4h
Reset to Jump Scroll mode	ESC[?4l

**Reverse/Normal Screen Mode**

Set to Reverse Screen mode	ESC[?5h
Reset to Normal Screen mode	ESC[?5l

**Cursor Origin Mode**

Set Cursor Origin mode	ESC[?6h
Reset Cursor Origin mode	ESC[?6l

**Auto Wraparound Mode**

Set Auto Wraparound mode	ESC[?7h
Reset Auto Wraparound mode	ESC[?7l

## Appendix F

### TERMINAL MODE CONTROLS (Continued)

#### Auto Repeat Mode

Set Auto Repeat mode	ESC[?8h
Reset Auto Repeat mode	ESC[?8l

#### Form Feed Mode

Set Form Feed	ESC[?18h
Reset Form Feed	ESC[?18l

#### Print Extent Mode

Set Extent mode	ESC[?19h
Reset Extent mode	ESC[?19l

#### Double Speed Smooth Scroll Mode

Set Double Speed Smooth Scroll	ESC[>1h
Reset to Normal Speed Smooth Scroll	ESC[>1l

#### Hex Keypad Numeric Mode

Set Hex Keypad Numeric mode	ESC[>3h
Reset to Normal Keypad Numeric mode	ESC[>3l

#### Keypad Application Mode

Enter Keypad Application mode	ESC=
Enter Keypad Numeric mode	ESC>

#### Clear Display/line Feed On Form Feed Mode

Set Clear Display on LINE FEED mode	ESC[>4h
Reset to Normal LINE FEED function mode	ESC[>4l

#### Disable Incoming XOFF Mode

Set Disable Incoming XOFF mode	ESC[>6h
Reset Process Incoming XOFF mode	ESC[>6l

#### Screen Width Change Erase Mode

Set Screen Width Change Erase mode	ESC[>9h
Reset Screen Width Change Preserve mode	ESC[>9l

#### Right Half Of Double-width Lines Erase Mode

Set RH of DW Lines Erase mode	ESC[>10h
Reset to RH of DW Lines Preserve mode	ESC[>10l

**TERMINAL MODE CONTROLS (Continued)**

**Erase Page Extent Mode**

Set Erase Page Within Margins	ESC[>11h
Reset Erase Entire Display	ESC[>11l

**Tab Motion Spaces/Direct Modes**

Set Tab Motion With Spaces mode	ESC[>12h
Reset Tab Motion Direct	ESC[>12l

**CRT Save Mode**

Set CRT Saver mode	ESC[>13h
Reset CRT Saver mode	ESC[>13l

**Half Duplex/Full Duplex Modes**

Set Half Duplex mode	ESC[>14h
Reset Full Duplex mode	ESC[>14l

**Eraser Attributes Clear/Cursor**

Cursor	ESC[>201h
Clear	ESC[>201l

**Erase Attributes**

Enable	ESC[>202h
Disable	ESC[>202l

**Erase Characters**

Enable	ESC[>203h
Disable	ESC[>203l

## Appendix F

### AUXILIARY PORT CONTROL COMMANDS

#### Print Screen

Print Screen ESC[i

#### Print Cursor Line

Print Cursor Line ESC[?1i

#### Auto Print

Auto Print On ESC[?5i  
Auto Print Off ESC[?4i

#### Print Controller

Print Controller On ESC[5i  
Print Controller Off ESC[4i

#### Auxiliary Port Control

- ▶ Line Send ESC#2
- ▶ Page Send ESC#7
- ▶ Keyboard Auxiliary Mode ESC[1z
- ▶ Keyboard COMM Mode ESC[0z
- ▶ Auto Auxiliary Mode ESC#0
- ▶ Auxiliary Control Mode ESC1
- ▶ Auxiliary Output Disable ESC2
- ▶ Concurrent Auxiliary Mode ESC0
- ▶ Auxiliary to COMM Mode ESC[2z
- ▶ Auxiliary to Display Mode ESC[3z
- ▶ Input Disable ESC[4z
- ▶ Clear Auxiliary Port Output buffer ESC[5z
- ▶ Exit Auto Auxiliary or Concurrent Auxiliary Modes ESC#1

**25TH ROW STATUS LINE**

ESC [ Q <text> ESC \  
 ESC [ > Ps1 ; Ps2 Q

**LED CONTROL**

Set LED ESC[Pnq

**MULTIPLE PAGE FUNCTIONS**

Next Page ESC[PnU or ESC[>PnU  
 Previous Page ESC[PnV or ESC[>PnV  
 Copy Data ESC[Ps;P1;P2;P3;P4;P5p

**REPORTS**

**Terminal Identification**

Set identify type ESC[>Psp  
 Request for Terminal Status ESC[5n  
     Response that terminal is OK ESC[n  
     or  
     ESC[0n  
     Response that terminal is not OK ESC[3n  
 Request for Cursor Position ESC[6n  
     Response with cursor position ESC[P1;PcR  
 Request Device Attributes ESC[c  
     or  
     ESC[0c  
     Response with Attributes ESC[?1;2c  
 Request Printer Status ESC[?15n  
     Printer is ready ESC[?10n  
     Printer is not ready ESC[?11n  
     There is no printer ESC[?13n  
     CIT101XL with printer ESC[?1;11c  
     CIT101XL without printer ESC[?1;2c  
 Request for Terminal Parameters ESC[<sol>x  
 Terminal Parameter Report  
 ESC[<sol>;<par>;<nbits>;<xspeed>;<rspeed>;<clkmul>x

## Appendix F

### DESIGNATE CHARACTER SET

ASCII Character Set	ESC(B
Graphics Character Set	ESC(O
ASCII Character Set	ESC)B
Graphics Character Set	ESC)O

### SCREEN ALIGNMENT

Fill Screen With E's	ESC#8
Fill Screen With Character Assortment	ESC#9

### KEYCLICK

Perform Keyclick	ESC#>
------------------	-------

### RESET TERMINAL

Reset Terminal to Initial Conditions	ESCC
--------------------------------------	------

## VT52 MODE CONTROL SEQUENCES

### Cursor Control Sequences

Move cursor up	ESC A
Move cursor down	ESC B
Move cursor right	ESC C
Move cursor left	ESC D
Move cursor Home	ESC H
Position cursor	ESC Yrc

### Erase Control Sequences

Erase to end of line	ESC K
Erase to end of page	ESC J

### Graphics Mode

Enter Special Graphics mode	ESC F
Exit Special Graphics mode	ESC G

### Keypad Application Mode

Enter Keypad Application mode	ESC =
Exit Keypad Application mode	ESC >

**Bidirectional Auxiliary Port Control**

Enter Concurrent Auxiliary mode	ESC U
Output cursor line to Auxiliary	ESC V
Enter Auxiliary Controller mode	ESC W
Exit Auxiliary Controller mode	ESC X
Output full screen to Auxiliary	ESC ]
Enter Auto Auxiliary mode	ESC ^
Exit Auto Auxiliary mode	ESC _

**Scroll**

Reverse line feed	ESC I
-------------------	-------

**ANSI Mode**

Enter ANSI mode	ESC <
-----------------	-------

**Request Identity**

Identify terminal type	ESC Z
Transmit identifier sequence	ESC /Z





## Appendix G -- SET-UP MODE SUMMARY

---

### KEYBOARD CONTROLS

<u>Action</u>	<u>Key</u>
Switch among choices	Space bar or <ENTER>
Select parameter to the right	Right arrow
Select parameter to the left	Left arrow
Next menu	Down arrow
Previous menu	Up arrow
Save current parameter choice	<CTRL-S>
Read saved parameters	<CTRL-R>
Read default parameters	<CTRL-D>
Toggle Set-Up Mode	<SHIFT-SETUP>
Return to initial menus line	<SETUP>

To leave the Set-Up mode, press <SHIFT-SETUP>.

### THE ANSI SET-UP MODE

#### ANSI SET-UP MENUS

##### ANSI COMMS 1 MENU

<b>SPEED:</b>	9600 (Default)
	19200
	38400
	150
	300
	600
	1200
	2400
	4800
<b>PARITY:</b>	None (Default)
	Even
	Odd
	Mark
	Space
<b>DATA:</b>	8 (Default)
	7
<b>STOP BITS:</b>	1 (Default)
	2
<b>PROTOCOL:</b>	None (Default)
	Xon
	DTR
	Both

## Appendix G

### ANSI COMMS 2 MENU

**ONLINE:** Online (Default)  
Local

**MODE:** FDX (Default)  
HDX

**RCV XOFF:** Process (Default)  
Ignore

**MONITOR:** Off (Default)  
On

### ANSI DISPLAY 1 MENU

**SCREEN:** 80 (Default)  
80 Rev  
132  
132 Rev

**FREQ:** 60Hz (Default)  
50Hz

**CURSOR:** Blinking Block (Default)  
Static Block  
Blinking Line  
Static Line  
None

### ANSI DISPLAY 2 MENU

**SCROLL:** Jump (Default)  
SM 1  
SM 2  
SM 3  
SM 4

**FORM FEED:** LF (Default)  
Clr

**CRT SAVER:** 60 (Default)  
Off  
10  
20  
30  
40  
50

### ANSI DISPLAY 3 MENU

24 Rows, Status, & Labels (Default)  
25 Rows, & Labels  
24 Rows, & Labels

**ANSI DISPLAY 4 MENU**

**WIDTH CHANGE:** Erase (Default)  
                  Preserve

**RH OF DW:** Erase (Default)  
              Preserve

**ERASE EXTENT:** Page (Default)  
                  Margin

**ANSI DISPLAY 5 MENU**

**TAB MOTION:** Direct (Default)  
              Spaces

**INSERT LINE:** Blank (Default)  
                  Attributes

**ANSI DISPLAY 6 MENU**

**GO MAP:** US (Default)  
          British/UK  
          German  
          French  
          Spanish  
          Danish  
          Norwegian  
          Swed/Fin E47  
          Swed/Fin D47  
          French/CA  
          Graphics

**G1 MAP:** US (Default)  
          British/UK  
          German  
          French  
          Spanish  
          Danish  
          Norwegian  
          Swed/Fin E47  
          Swed/Fin D47  
          French/CA  
          Graphics

## Appendix G

### ANSI KEYBOARD 1 MENU

**CLICK:** On (Default)  
Off

**REPEAT:** On (Default)  
Off

**MARGIN BELL:** On (Default)  
Off

**CSR KEYS:** Normal CSR keys (Default)  
Application CSR keys

### ANSI KEYBOARD 2 MENU

**AUTOWRAP:** Off (Default)  
On

**New Line:** Off (Default)  
On

**SCROLL KEY:** VT100 (Default)  
VT52

### ANSI KEYBOARD 3 MENU

**NUMERIC KEYPAD:** Numeric Numpad (Default)  
Application Numpad

**HEX KEYPAD:** Decimal Numpad + PF's (Default)  
Hex Keypad

**CNTL Q/S:** are Hold (Default)  
Data

**ANSI AUX 1 MENU**

**SPEED:** 9600 (Default)  
19200  
38400  
150  
300  
600  
1200  
2400  
4800

**PARITY:** None (Default)  
Even  
Odd  
Mark  
Space

**DATA:** 8 (Default)  
7

**RCV XOFF:** Process (Default)  
Ignore

**TX XOFF:** On (Default)  
Off

**ANSI AUX 2 MENU**

**PAGE TERM:** None (Default)  
FF

**PRINT EXT:** Screen (Default)  
Margin

**ANSI AUX 3 MENU**

**FILL AFTER:** CR (Default)  
LF

**PRINT NON FILL:** On (Default)  
Off

**FILL COUNT:** 00 (Default)  
01  
..  
99

**ANSI AUX 4 MENU**

**Print:** Normal (Default)  
National

## Appendix G

### ANSI EMULATION MENU

EMULATION MODE: VT100 (Default)  
VT52

IDENTIFY: VT102 (Default)  
VT100  
VT101  
VT200

KEYBOARD LANGUAGE: US (Default)

### ANSI TABS MENU

Tabulation: Default = tabs every eighth column (starting at column 9)

## THE ASCII SET-UP MODE

### ASCII SET-UP MENUS

#### ASCII COMMS 1 MENU

SPEED: 9600 (Default)  
19200  
38400  
150  
300  
600  
1200  
2400  
4800

PARITY: None (Default)  
Even  
Odd  
Mark  
Space

DATA: 8 (Default)  
7

STOP BITS: 1 (Default)  
2

PROTOCOL: None (Default in ASCII mode)  
Xon  
DTR  
Both

**ASCII COMMS 2 MENU**

**MODE:** FDX (Default)  
 HDX  
 Block  
 H-Block

**BLOCK END:** US/CR (Default)  
 CRLF/ETX

**TEST:** Off (Default)  
 On

**ASCII DISPLAY 1 MENU**

**SCREEN:** 80 (Default)  
 80 Rev  
 132  
 132 Rev

**FREQ:** 60Hz (Default)  
 50Hz

**CURSOR:** Blinking Block (Default)  
 Static Block  
 Blinking Line  
 Static Line  
 None

**ASCII DISPLAY 2 MENU**

**AUTO SCROLL:** On (Default)  
 Off

**SCROLL:** Jump (Default)  
 SM 1  
 SM 2  
 SM 3  
 SM 4

**PROTECT:** Dim (Default)  
 Reverse  
 Normal

**CRT SAVER:** 60 (Default)  
 Off  
 10  
 20  
 30  
 40  
 50



## Appendix G

### ASCII DISPLAY 3 MENU

24 Rows, Status, & Labels	(Default)
25 Rows, & Labels	
24 Rows, & Labels	

### ASCII KEYBOARD MENU 1

CLICK:	On	(Default)
	Off	

REPEAT:	On	(Default)
	Off	

RET/ENTER:	CR/CR	(Default)
	CRLF/TAB	

### ASCII KEYBOARD MENU 2

AUTOWRAP:	Off	(Default)
	On	

RCV CR:	CR	(Default)
	CRLF	

### ASCII AUX MENU

SPEED:	9600	(Default)
	19200	
	38400	
	150	
	300	
	600	
	1200	
	2400	
	4800	

PARITY:	None	(Default)
	Even	
	Odd	
	Mark	
	Space	

DATA:	8	(Default)
	7	

RCV XOFF:	Process	(Default)
	Ignore	

**ASCII EMULATION MENU**

**MODE:**           WY 50           (Default)  
                  TVI910  
                  TVI920  
                  TVI925  
                  ADDSVP  
                  HZ1500

**ENHANCE:**       Off           (Default)  
                  On

**KEYBOARD LANGUAGE:**   US           (Default)  
                          British/UK  
                          German  
                          French  
                          Spanish  
                          Danish  
                          Norwegian  
                          Swed/Fin E47  
                          Swed/Fin D47  
                          French/CA



## Appendix H -- SELF-TEST MODE

---

The COMM and AUX ports may be tested locally by using the Self-Test mode in conjunction with the appropriate EIA Loopback connectors or a break out box. While the test mode is active all other keys except the space bar, control and both shift keys are illegal and will cause an error bell. This allows testing of the keyboard keys. Operation of the test mode is as follows:

1. Place Self-Test Loopback connectors on both the COMM and AUX ports of the terminal. Loopback connectors are defined as follows:

COMM EIA Loopback: Pin 2 is tied to Pin 3.  
Pin 4, Pin 5, and Pin 8 are all tied together.  
Pin 6 is tied to Pin 20.

AUX EIA Loopback: Pin 2 is tied to Pin 3.  
Pin 6 is tied to Pin 20.

2. Enter the ASCII Set-Up mode and select the Test parameter in the COMMS 2 menu.
3. Depress the Space bar. The Test parameter will read "Test On".
4. While Test mode is on the right half of the status line is replaced with a reverse video box displaying the test status. If the test detects no errors the status line will read "CIT 50+ OK". If an error is detected the appropriate error message is displayed in the status line.

The tests run continuously and the messages are updated continuously. To detect an error, remove one of the Loopback connectors from either the COMM or the AUX port.

5. Press the space bar to exit the Self-Test mode. Normal terminal operation is restored.













**Addendum  
13 November 1987**

**Addendum  
to  
CIT101XL  
USER'S MANUAL**

**C.I.TOH**  
CIE Terminals

© 1987 C.Itoh Electronics, Inc.



# INTRODUCTION

---

This publication is a description of the enhancements implemented in firmware Version 4.0 of the CIT101XL Video Display Terminal. It is an addendum to the User's Manual dated January 1987, Part Number 093-065, and is intended to be used in conjunction with that manual.

The following features are added to the new CIT101XL terminals:

- ▶ Additional 220-240V Power Supply
- ▶ Description of Answerback Message
- ▶ Larger Character Cell of 10 x 14 Pixels

These features are arranged according to their corresponding chapters in the User's Manual.

---

# INSTALLATION

## Power Requirements

BEFORE connecting power, verify that the CIT101XL terminal's AC line switch setting is set to the value of the voltage supplied (see Figure 2-1.) The terminal can be set to operate on 115V or 230V. Refer to the specifications in Appendix A for the correct setting.

---

### CAUTION

*Do not attempt to operate the CIT101XL with an incorrect AC voltage setting or damage to the terminal can occur.*

---

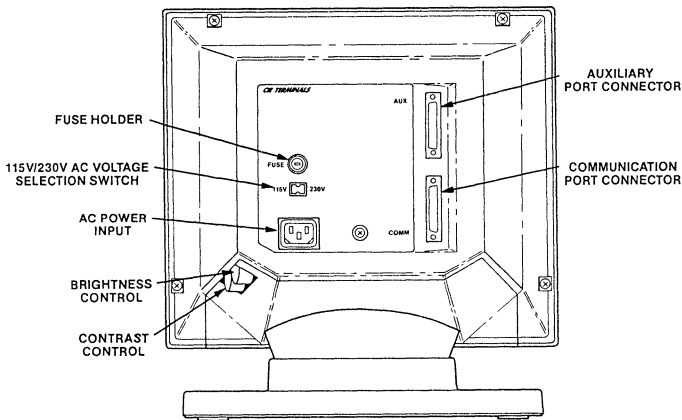

**Figure 2-1. Back View of the Display Unit**

Check the AC voltage selection switch and ensure it is set to the correct voltage. If it is not correct, use a pen or a small screwdriver to set the slide switch to the value of the AC line voltage. Be sure that the correct fuse is installed for the line voltage setting.

Connect the AC cord to the receptacle at the rear of the terminal. Plug the cord into an AC outlet equipped with an integral ground connection. If a grounded receptacle is not available, a new one should be installed. Do not attempt to operate the terminal with the ground connection broken.

## CHAPTER 4

---

### THE SET-UP MODE

#### Answerback Message

The answerback feature allows the CIT101XL terminal to identify itself to the host. The message is entered in Set-Up mode and is sent when the host sends an ENQ (05H) code to the terminal requesting its identity. To set the answerback message:

1. Enter Set-Up mode by pressing **<Shift-SetUp>**.

2. Press **<Ctrl-A>**.

The Set-Up menu line is replaced with the message - "Answerback=".

3. Type in the answerback message, which can be up to 20 characters long, including spaces and control characters.

If an error is made when entering the message, use the **<Delete>** key to remove the message and type in another.

4. Exit Set-Up by pressing **<Shift-SetUp>**.

Once entered, the answerback message is temporarily stored. A SAVE operation must be performed to permanently store the message. To do a SAVE operation:

5. Re-enter Set-Up mode by pressing **<Shift-SetUp>**.

6. Press **<Ctrl-S>**.

"Done" appears on the screen to show that the SAVE operation is completed.

7. Exit Set-Up mode by pressing **<Shift-SetUp>**.

---

**NOTE:** If you re-enter the answerback message mode by pressing **<Ctrl-A>** in Set-Up, the current message is erased and a new message must be entered.

---

To verify the answerback message, send an ENQ code to the terminal, or press **<Ctrl-Break>** on the keyboard. The terminal responds with the new answerback message.

# APPENDIX A

---

## SPECIFICATIONS

Changes to the terminal's specifications are listed below and highlighted by underlining and bolding.

### DISPLAY

CHAR. MATRIX      7x9 dot matrix within a 10x14 cell in 80 column  
26th row mode

### ELECTRICAL

LINE VOLTAGE      100 to 120 VAC single phase 3-wire  
220 to 240 VAC single phase-3-wire  
(switch selectable)

LINE FREQUENCY      47 to 63 Hz

LINE CURRENT      1.1 amps max at 100 to 120 VAC  
0.7 amps max at 220 to 240 VAC

# C.I.TOH

**CIE Terminals, Inc.**  
A C.Itoh Electronics Company

2505 McCabe Way  
Irvine, CA 92714-6297  
Telephone 714/660-1421